



Central Park Price List

Effective November 1, 2022

Date	Page	Modification	Description
9.27.22		Wall Boards	The sizes 99" and 105" have been removed from all wall boards.
9.27.22		Refresh Items Added	Refresh items have been added along with new tackboards, wall hung glassboards, and wall hung tfl panels.
10.12.22	5	Pulls Pricing	New pricing added to the Matte Black, Matte Gold and Staineless Steel Pulls
10.12.22	5	Removed Finger Pulls	Removed Finger Pull Option
11.07.22	37	Grommets	Centered grommet is standard
11.11.22		Price Increase	9% price increase applied
01.05.22	44, 52	Added Modesty and K28, K31, K31-SK options	
01.18.23	8	Removed grommets from M51 and M34	
01.19.23	107-108	Changed 48" wide wall shellives to 47"wide	
02.08.23	105-108	Updated the max load of pounds the shelves will support	
02.15.23	163	Removed leather inlays	

Statement of Line

Features & Advantages1

Finishes | Specifications3

Edges4

Pulls | Knobs5

Grommets | Grommet Reference.....6

Height Reference7

Modesty Reference8

Doors | Grain Direction9

Drawer Dimensions | FILING Reference.....10

Double Pedestal Desk.....11

Table Desk.....18

Single Pedestal Desk.....20

Non-Handed Desk Shells.....28

Desk shell.....29

Work Wall Desk.....36

Height Adjustable Table Desk37

Conference Desk.....39

Service Desk.....46

Runoff Desk.....49

Returns.....53

Bridges60

Freestanding Credenzas61

Workstation Credenzas.....66

Workstation Shell.....69

Bench Cabinets/Accessories.....71

Pedestals75

Single Height Freestanding Overheads.....78

Double Height Freestanding Overheads.....81

Overhead Accessories.....83

Single Height Wall Hung Overheads.....87

Double Height Wall Hung Overheads.....90

Wall Hung Accessories93

Overhead Half Towers.....101

Overhead Bookcases104

Vertical Half Towers.....105

Vertical Full Towers.....107

Bookcases.....111

Reception.....113

Options127

Power & Data.....144

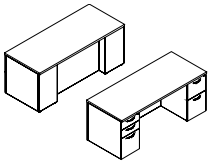

Page 11
Breakfront Chassis Desks
Double Pedestal Desk

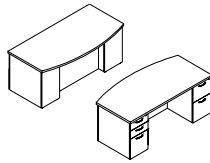

Page 12
Breakfront Chassis Desks
Bowfront Double Pedestal Desk

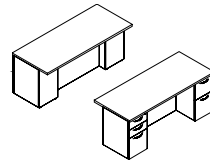

Page 13
Breakfront Chassis Desks
Conference Overhang Double
Pedestal Desk

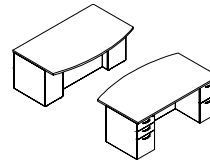

Page 14
Breakfront Chassis Desks
Bowfront Conference Overhang
Double Pedestal Desk

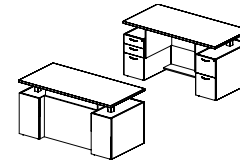

Page 15
Breakfront Chassis Desks
Height Adjustable Double Ped-
estal Desk

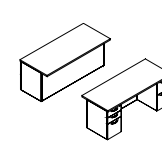

Page 16
Flush Chassis Desks W/ Over-
hang
Full Double Pedestal Desk

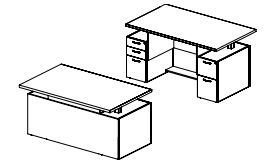

Page 17
Flush Chassis Desks W/ Over-
hang
Height Adjustable Full Double
Pedestal Desk

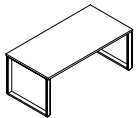

Page 18
Table Desks With Sleigh Base
Rectangle With Sleigh Legs

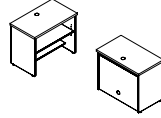

Page 19
Desks
Crt Desk / Printer

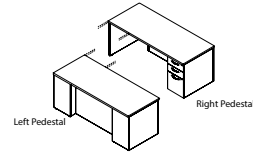

Page 20
Double Breakfront / Single Ped-
estal Desks
Single Full Pedestal

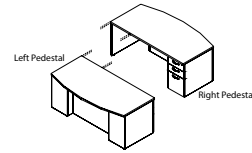

Page 21
Double Breakfront / Single Ped-
estal Desks
Bowfront Single Full Pedestal

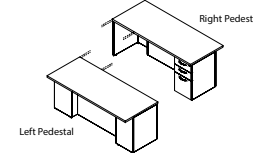

Page 22
Double Breakfront / Single Ped-
estal Desks
Conference Overhang Single Full
Pedestal

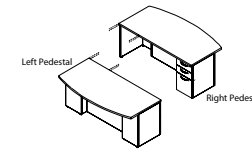

Page 23
Double Breakfront / Single Ped-
estal Desks
Bowfront Conference Overhang
Single Full Pedestal

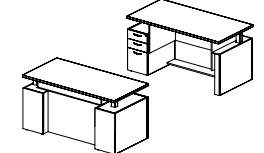

Page 24
Double Breakfront / Single Ped-
estal Desks
Height Adjustable Single Full
Pedestal

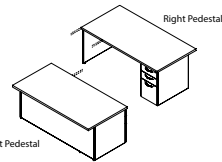

Page 25
Flush Chassis Single Pedestal
Desks W/ Overhang Top
Single Full Pedestal

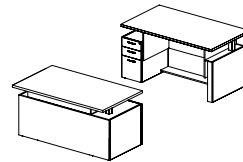

Page 26
Flush Chassis Single Pedestal
Desks W/ Overhang Top
Height Adjustable Single Full
Pedestal

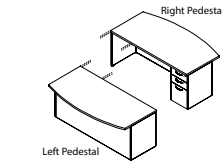

Page 27
Flush Modesty Single Pedestal
Desks
Bowfront Single Full Pedestal

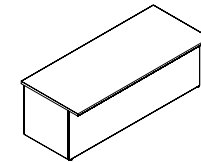

Page 28
Non-Handed Desk Units
Flush Modesty Shell W/ Overhang
Top

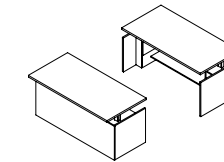

Page 29
Desk Shell
Height Adjustable Overhang

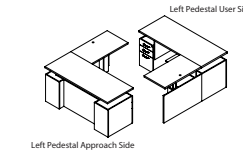

Page 30
Height Adjustable Box/Box/File
Pedestal With Bridge
"L" Double Breakfront / Single Ped-
estal Desks With 42" Bridge

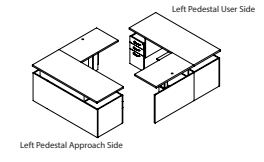

Page 31
Height Adjustable Box/Box/File
Pedestal With Bridge
"L" Flush Front / Single Pedestal
Desks With 42" Bridge

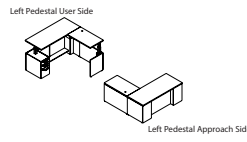

Page 32
Double Breakfront Height Ad-
justable Box / Box / File Pedestal
Desk
42" Return Shell

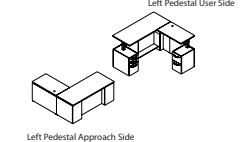

Page 33
Double Breakfront Height Ad-
justable Box / Box / File Pedestal
Desk
42" File / File Pedestal Return

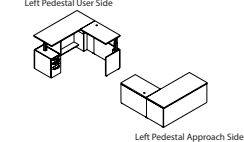

Page 34
Flush Chassis Height Adjustable
Box / Box / File Pedestal Desk
42" Return Shell

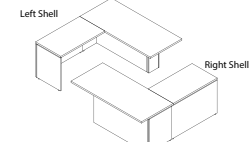

Page 35
Height Adjustable Desk Shell
42" Return Shell

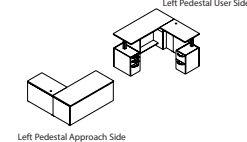

Page 36
Flush Chassis Height Adjustable
Box / Box / File Pedestal Desk
42" File / File Pedestal Return

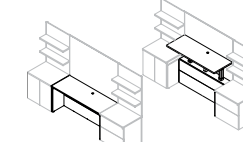

Page 37
Height Adjustable Work Wall
Desk
Work Wall Shell

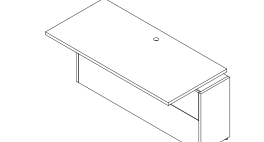

Page 38
Height Adjustable Work Wall Shell

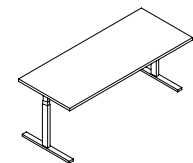

Page 39
Height Adjustable Table Desk
Table Desks

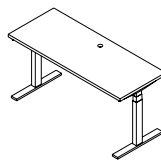

Page 40
Height Adjustable Bridges
Open Back

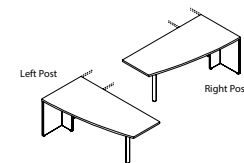

Page 41
Conference Desks
Elliptical Conference Desk

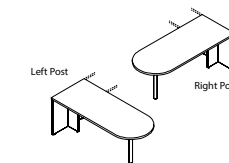

Page 42
Conference Desks
Bullet Conference Desk

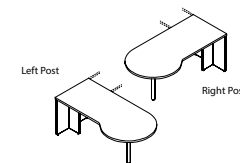

Page 43
Conference Desks
"P" Conference Desk

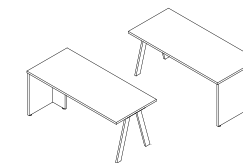

Page 44
Conference Desks
Rectangle Conference Desk with
(2)Angled Metal Legs

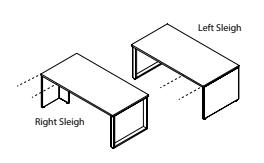

Page 45
Conference Desks
Rectangle Conference Desk With
Sleigh Base

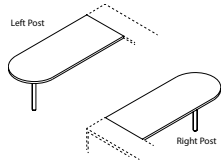

Page 46
Conference Runoff Desks
Bullet Runoff Desk

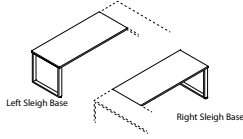

Page 47
Conference Runoff Desks
Rectangle Runoff Desk

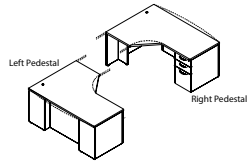

Page 48
Service Workstation Desks
Breakfront Modesty Full Pedestal

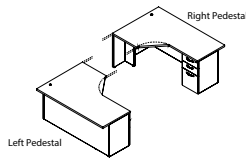

Page 49
Service Workstation Desks
Flush Modesty Full Pedestal W/
Overhang Top

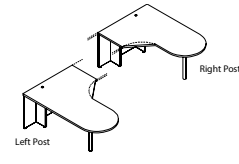

Page 50
Service Workstation Desks
Bullet Service Desk

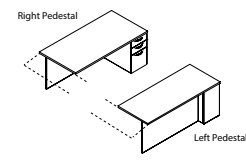

Page 51
Workstation Runoff Desks Single
Full Pedestal
Breakfront Runoff

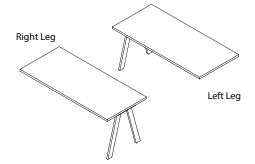

Page 52
Conference Runoff Desk
Rectangle Conference Runoff
with Angled Legs

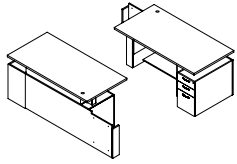

Page 53
Height Adjustable Workstation
Runoff Desks
Height Adjustable Runoff Desk

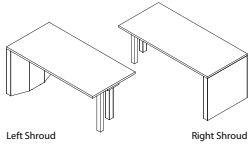

Page 54
Height Adjustable Runoff Desk
Height Adjustable Runoff with
Angled Metal Shroud

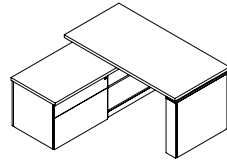

Page 55
Height Adjustable Runoff Desk
Workstation with Adjustable
Column Box

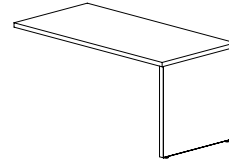

Page 56
Runoff Desk
Shell Unit

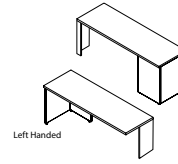

Page 57
Workstation Shells - Used Next to
Single Pedestal or Shell Lift Desk
Open Back

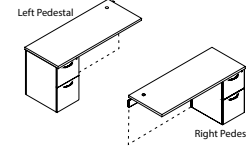

Page 58
"L" Workstation Returns
"L" Workstation Return - File/File

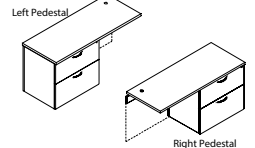

Page 59
"L" Workstation Returns
"L" Workstation Return - Lateral
File

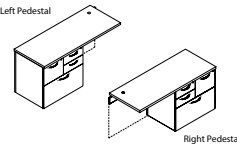

Page 60
"L" Workstation Returns
"L" Workstation Return - Multi-File

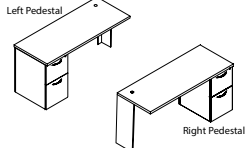

Page 61
"L" Workstation Returns
"L" Workstation Return - File/File

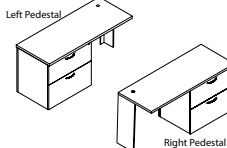

Page 62
"L" Workstation Returns
"L" Workstation Return - Lateral
File

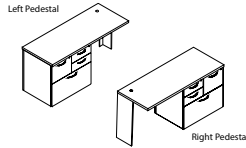

Page 63
"L" Workstation Returns
"L" Workstation Return - Multi-File

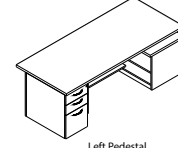

Page 64
Conference Runoff Desk
Height Adjustable Bench Creden-
za Conference Runoff Desk

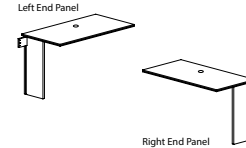

Page 65
Bridges
Open Back With Half End Panel

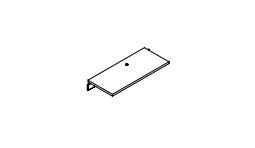

Page 66
Bridges
Open Back With 4"H Wire Man-
agement Rail

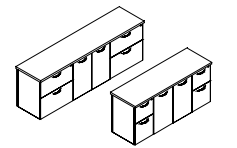

Page 67
Full Pedestal Credenzas
File Storage Credenza

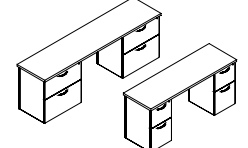

Page 68
Full Pedestal Credenzas
Kneespace Credenza

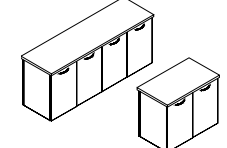

Page 69
Full Pedestal Credenzas
Storage Credenza

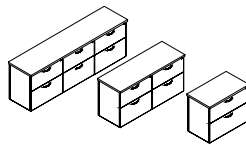

Page 70
Full Pedestal Credenzas
Horizontal Lateral File

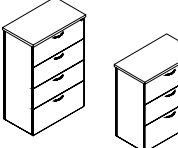

Page 71
Full Pedestal Credenzas
Vertical Lateral File

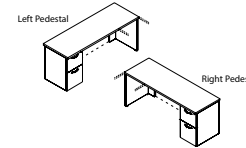

Page 72
Workstation Credenzas
"U" Workstation Credenza - File
/ File

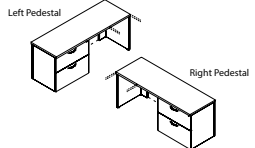

Page 73
Workstation Credenzas
"U" Workstation Credenza -
Lateral File

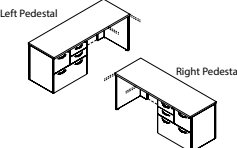

Page 74
Workstation Credenzas
"U" Workstation Credenza -
Multi-File

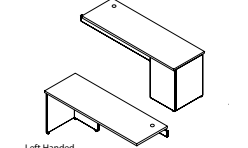

Page 75
Workstation Return Shells
Open Back

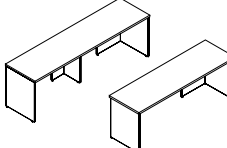

Page 76
Workstation Freestanding Cre-
denza Shells
Open Back

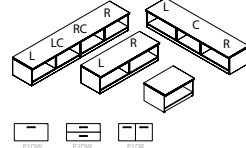

Page 77
Single Height Bench Cabinets
One, Two And Three Section
Storage

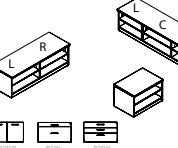

Page 78
Double Height Bench Cabinets
One, Two And Three Section
Storage

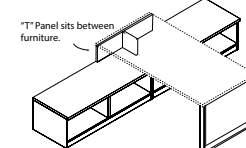

Page 79
Bench Accessories
Bench Runoff Support Wood "T"
Panel

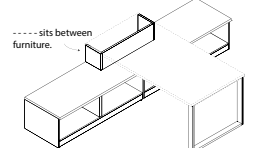

Page 80
Bench Accessories
Bench Runoff Technology
Support

Statement of Line



Page 81
Mobile Pedestals
Open Plan Mobile Desk Pedestal
With Casters

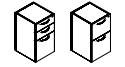

For use under 29"H work surfaces

Page 82
Modular Pedestals
Undersurface Pedestal
With Casters

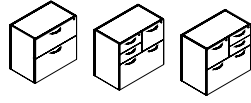

For use under 29"H work surfaces

Page 83
Pedestals
Undersurface Lateral File
Pedestals

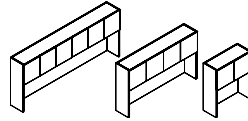

Page 84
Single Storage Overhead
Console
14" D Panel Door - 2/4/6 Section

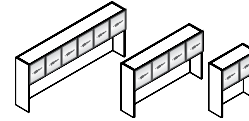

Page 85
Single Storage Overhead
Console
14" D Silverluma Frame Doors /
Frosted Inserts - 2/4/6 Section

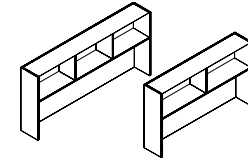

Page 86
Single Storage Overhead
Console
14" D Open Storage Console - 2/3
Section

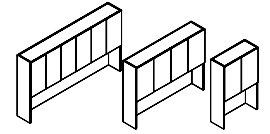

Page 87
Double Storage Overhead
Console
14" D Panel Door - 2/4/6 Section

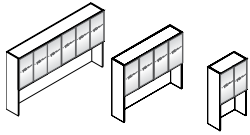

Page 88
Double Storage Overhead
Console
14" D Silverluma Frame Doors /
Frosted Inserts - 2/4/6 Section

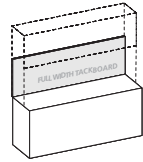

Page 89
Overhead Tackboards

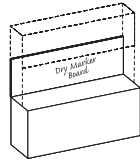

Page 90
Overhead Dry Marker Boards

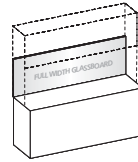

Page 91
Overhead Glassboards

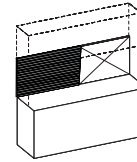

Page 92
Overhead Slat Wall

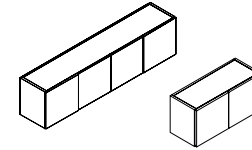

Page 93
Single Height Wall Hung Over-
heads
14" D Panel Doors - 1/2/3 Section

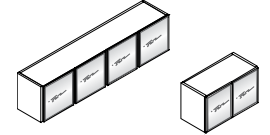

Page 94
Double Height Wall Hung Over-
heads
14" D Silverluma Frame / Frosted
Doors - 1/2/3 Section

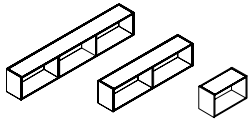

Page 95
Single Height Wall Hung Over-
heads
14" D Open Storage Cabinet -
1/2/3 Section

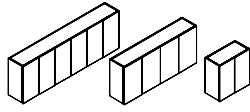

Page 96
Double Height Wall Hung
Overheads
14" D Panel Doors - 2/4/6 Section

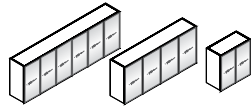

Page 97
Double Height Wall Hung
Overheads
14" D Silverluma Frame / Frosted
Doors - 2/4/6 Section

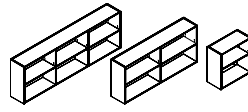

Page 98
Double Height Wall Hung
Overheads
14" D Open Storage Cabinet -
1/2/3 Section

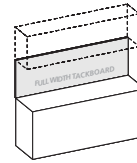

Page 99
Wall Hung Tackboards

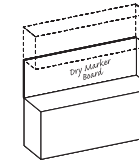

Page 100
Wall Hung Dry Marker Boards

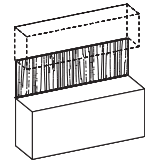

Page 101
Wall Hung Veneer Panels

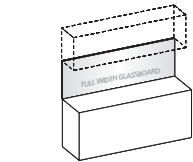

Page 102
Wall Hung Glassboards

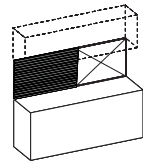

Page 103
Wall Hung Slat Wall

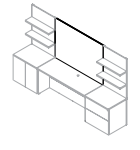

Page 104
Glass Wall Hung Board

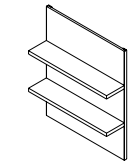

Page 105
Single Height Wall Hung Shelf
Open Endless Shelf - 2 Shelves

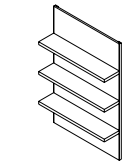

Page 106
Double Height Wall Hung Shelf
Open Endless Shelf - 3 Shelves

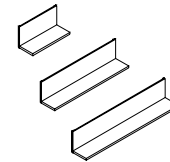

Page 107
Single Height Wall Hung Over-
heads
Open Endless Shelf Single Height

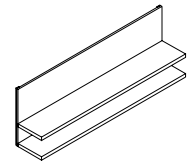

Page 108
Double Height Wall Hung
Overheads
Open Endless Shelf Double
Height

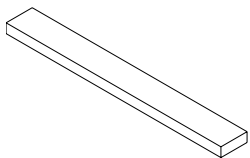

Page 109
Floating Wall Mounted Shelf
Single Shelf

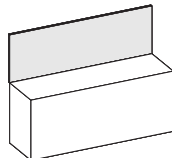

Page 110
Wall Hung Tackboards

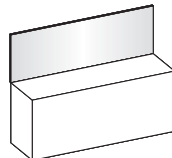

Page 112
Wall Hung Glassboards

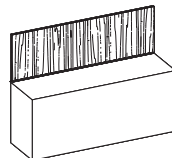

Page 116
Wall Hung Veneer Panels

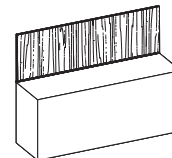

Page 119
Wall Hung TFL Panels

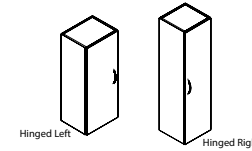

Page 122
Overhead Half Towers
14" D Panel Doors / Storage

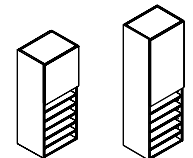

Page 123
Overhead Half Towers
14" D Panel Door - Storage /
Organizer

Statement of Line

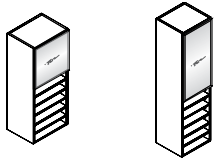

Page 124
Overhead Half Towers
14" D Silverluma Frame Door/
Frosted Insert - Storage/Organizer

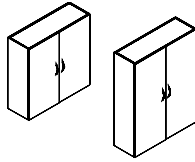

Page 125
Overhead Bookcases
14" D Panel Doors / Storage

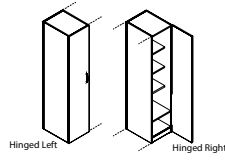

Page 126
Vertical Half Towers
Storage Wardrobe - Panel Door

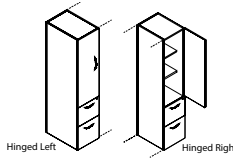

Page 127
Vertical Half Towers
Storage / File - Panel Door

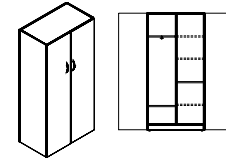

Page 128
Vertical Full Towers
Wardrobe

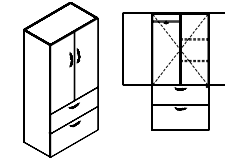

Page 129
Vertical Full Towers
Storage / File

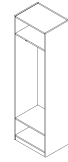

Page 130
Right Angle Open Tower
Storage/Wardrobe

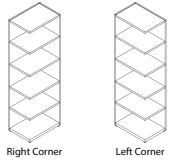

Page 131
Corner Display Towers
Display Towers

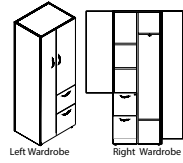

Page 132
Vertical Full Towers
Storage / File - Mini-Wardrobe



Page 133
Workcenter 54" Full Tower
Components
Lateral File X2 / Open Storage

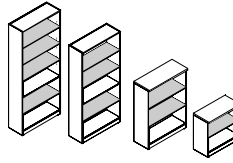

Page 134
Bookcases
14" D Open Bookcase

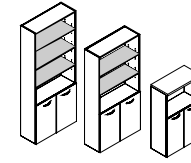

Page 135
Bookcases
14" D Bookcase W/ Doors

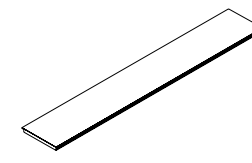

Page 136
Reception Desk Countertops
12" Rectangle Overhang Counter

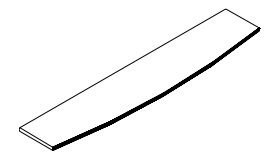

Page 137
Reception Desk Countertops
Bowfront Overhang Counter

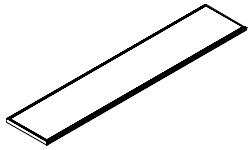

Page 138
Reception Desk Countertops
Floating Overhang Counter

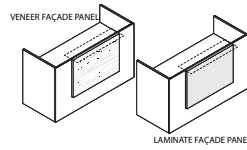

Page 139
Reception Facade Panel Counters
Facade Panel

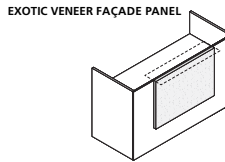

Page 140
Reception Facade Panel Counters
Exotic Facade Panel

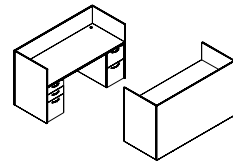

Page 141
Reception Desk
Freestanding - Double Pedestal

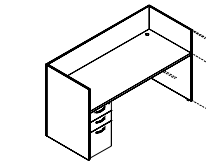

Page 142
Reception Desk
Single Pedestal Box/Box/File

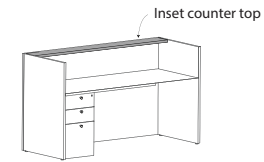

Page 143
Reception
Inset Reception Counter Top

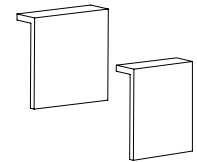

Page 144
Reception
Solid Surface Cliff Counter

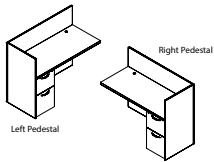

Page 145
Reception Return
File / File

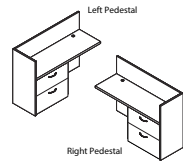

Page 146
Reception Return
Lateral File

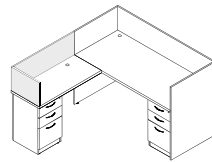

Page 147
Sit-On Reception Counters
Return Gallery

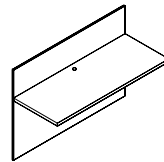

Page 148
Reception Bridge
Standard "U" Bridge

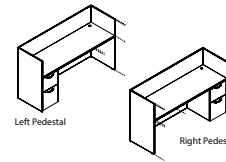

Page 149
Standard Reception "U" Credenzas
File / File

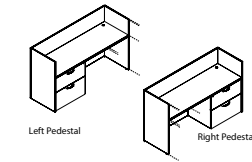

Page 150
Standard Reception "U" Credenzas
Lateral File

Veneer

DARRAN only uses HPVA AA Grade Flat Cut Cherry, Maple, and Walnut Veneers and AA Grade Quartered Oak Veneers. Central Park is also available in double cut reconstituted walnut and oak patterns made from rapidly renewable wood veneer providing a repeatable consistent straight grain pattern. All veneers are selected and matched for balance and consistency.

Veneer Tops

Central park veneer tops feature a 45-pound density substrate with balanced 3-ply construction. Tops are 1-1/8" thick on MDF core comprised of 100% recycled and recovered wood fibers. All veneer tops are slipmatched and feature a 3mm external solid hardwood band or profile edge.

Laminate Tops

Central park high-pressure laminate tops feature a 45-pound density substrate with balanced 3-ply construction. Tops are 1-1/8" thick on MDF core comprised of 100% recycled and recovered wood fibers. All high pressure laminate tops are available with a profile edge, laminate self-edge or 2mm PVC edge band. Laminates in wood grain patterns feature a fine grain texture that features the polish and luxe of a real wood veneer with a subtle narrow grain structure.

TFL tops

Thermally Fused Laminate tops feature a 45-pound density substrate with balanced 3-ply construction. Tops are 1-1/8" thick on MDF core that is comprised of 100% recycled and recovered wood fibers. All Thermally Fused Laminate tops are available with a 2mm flat PVC band. Laminates in wood grain patterns feature Timberline Texture providing the grain pattern of wood.

Cleaning wood & laminate

In addition to regular dusting, give your furniture an occasional cleaning in accordance with our cleaning instructions. DARRAN wood and laminate products can be cleaned with a soft cloth and a mild soap and water mixture. Use approximately 32 oz of water mixed with one tablespoon of dish soap, always wiping with the grain. Dry with a soft cloth, going with the grain, to avoid spotting or streaking.

Wood products should be waxed periodically using a non-wax liquid; please do not use any waxy polish or cleaner. Interior of drawers may also be cleaned with mild soap and water mixture, or any household cleaner that is not petroleum or thinner-based.

Chassis & pedestal

Chassis components are 3/4" thick core of particle board or MDF rated EPP/SCS/CARB-II material with 3-ply balanced construction. Pedestal and Cabinets feature dowel construction reinforced with steel bracket plates, wood cleats, screws and glue. All units are standard with 1" adjustable glides that allow for leveling of units that are secured in solid wood glide blocks to prevent tearout.

Overhead cabinet construction

Freestanding Overhead storage cabinets are constructed of 1" and 3/4" thick core of particle board or MDF rated EPP/SCS/CARB-II material with 3-ply balanced construction. Panels are attached with cam fasteners in conjunction with dowels securely adhered with PVAc glue. All surface mount cabinets connect to work surface with anti-slip tape. Wall mount cabinets are mounted to the wall with steel "z" bracket attachment method using 5mm euro screws to attach to the back of the cabinet. All units ship with a steel "z" bracket. This bracket is mounted to the wall by field installers. Installers are responsible for selecting and supplying appropriate fasteners for wall conditions.

Bookcase construction

All chassis (sides, back, top and bottom panels) are constructed with 3/4" thick core of particle board or MDF rated EPP/SCS/CARB-II material with 3-ply balanced construction. Panels are attached with cam-lock fasteners in conjunction with dowels securely adhered with glue. Shelves on all units are 3/4" thick balance 3 ply panels. Optional heavy duty shelves are 1" thick lumber core balanced 5 ply construction.

Tackboards

Wall mount tackboards are constructed of .75" thick fiberboard. The fabric is precisely aligned and fitted to the tackboard with a sock on cover. Overhead storage tackboards are constructed of .75" thick fiberboard. The fabric is precisely aligned and fitted to the tackboard and adhered to the rigid hardboard with staples. Wall mount cabinets are mounted to the wall with steel "z" bracket attachment method using 5mm euro screws to attach to the back of the cabinet. All units ship with a steel "z" bracket. This bracket is mounted to the wall by field installers. Installers are responsible for selecting and supplying appropriate fasteners for wall conditions.

Adjustable glides

Glides provide 1" of vertical leveling adjustment. Glide bottom is durable metal. Glides are secured in solid wood blocks that are screwed and glued for durability. etal.

Drawers

All drawers are constructed with mitre joint/dowel construction in a natural maple finish with four sides and a bottom, which are attached to a drawer front with screws for easy removal. Drawer fronts are vertically matched in balanced sets. Pencil trays are standard in all box drawers. Drawers are constructed of 1/2" thick wood grained wrapped 5 sided miter-folded construction with 1/4" thick hardboard bottoms reinforced for heavy weight capacity. Drawers have been tested and pass BIFMA 50,000 cycle test. All drawers are guaranteed lifetime with free replacement warranty.

Drawer fronts

Drawer fronts are vertically matched in balanced sets. Doors feature vertical veneer bookmatched horizontally in sets of 2 / 4 and 6 doors. All drawers and doors have traditional scallop profile edge shape. All tower fronts matched in vertical sets.

Optional wood drawers

Optional hardwood veneer plywood drawers feature banded top and bottom edges for smoothness. Drawers are dowel joint construction with a UV cured finish over maple veneers, plus a lifetime free replacement guarantee.

Optional Wood Drawer (Any Size) – Option Code P33...\$45 List Price Per Drawer

Suspensions

All casegoods utilize cold rolled steel zinc plated high-grade drawer suspensions. All suspensions are warranted for the lifetime of the product. Box and File drawers are full extension, featuring steel ball bearings for a smoother quieter range of motion and are rated 100lbs. Lateral file drawers are a progressive action full extension suspension and is rated at 150lbs. Veneer and High Pressure laminate casegoods feature soft close suspension. Thermally Fused Laminate casegoods feature standard suspensions. Lateral files include anti tip mechanism that allow only one drawer to be opened at a time.

Hinges

Units with doors include 95 degree swing hinges.

Filing

Central park features a highly durable black plastic extrusion that is securely fastened into a route on top of the drawer to support hanging files. An adjustable crossbar is provided for all file drawers that enables legal/letter filing front to back or side-to-side based on the drawer size.

Locks

Locks are Standard on all drawers below the worksurface. Random lock cores are installed at the factory. Some units may be shipped with the same key number. Locks are Silver, Black or Bronze and match pull finish unless otherwise specified.

DARRAN will also send lock cores separately to the dealer at your request. These units will be send with an empty lock core and the Dealer will receive a shipment of the requested lock core/keys.

Keying

Keying is available either factory or field installed. Factory installed keying is random.

Wire management

Wire management capabilities include standard and optional worksurface grommets. Specify W-1 under surface wire channels for organization and management of all communication wires and cords. Horizontal J-Channel wire management (Sku: W-1) is sold separately to conceal wire under worksurfaces.

Grommets

Metal grommets are provided to match the drawer pull selection. Grommet is available in black, silver, white or antique brass. Must specify standard or non-standard location. Black plastic grommets are available as an option for vertical applications.

Powerports

A large selection of power pods are available and handle power, data, docking stations and communication. See options section for selection.

LED Task Lights

LED task lighting provides high efficiency, low energy lighting with a long life. Surface mounted light is encased in silver aluminum channel with milk lense and rounded end caps. Lights are field installed. Product specifications listed below:

- Diffuser creates a softer light and eliminates hot spots
- Touch dimmer switch
- Can be “daisy chained” up to 90W
- 4.6 watts per foot
- 120 LEDs per meter
- Certification: UL Listed
- 50,000 hour life span.

Color Temp is 4000K

STANDARD VENEER		PREMIUM VENEER		HIGH PRESSURE LAMINATE		THERMALLY FUSED LAMINATE	
WAC Amber Cherry	N/A	GAC Amber Cherry	MAC Amber Cherry	WIC Crimson Cherry	N/A	GIC Crimson Cherry	N/A
WHC Honey Cherry	N/A	GHC Honey Cherry	N/A	WOC KoKo Cherry	N/A	GOC KoKo Cherry	MOC KoKo Cherry
WEC Ebony Cherry	N/A	GEC Ebony Cherry	MEC Ebony Cherry	WAM Alabaster Maple	N/A	GAM Alabaster Maple	N/A
WCM Clear Maple	N/A	GCM Clear Maple	N/A	WCM Clear Maple	N/A	GCM Clear Maple	N/A
WEW Executive Walnut	N/A	GEW Executive Walnut	N/A	WEW Executive Walnut	N/A	GEW Executive Walnut	N/A
WGW Gunstock Walnut	N/A	N/A	MGW Gunstock Walnut	WGW Gunstock Walnut	N/A	N/A	N/A
WBW Henna Walnut	N/A	N/A	N/A	WBW Henna Walnut	N/A	N/A	N/A
WSW Smokey Walnut	N/A	N/A	N/A	WSW Smokey Walnut	N/A	N/A	N/A
WNW Natural Walnut	N/A	GNW Natural Walnut	N/A	WNW Natural Walnut	N/A	GNW Natural Walnut	N/A
N/A	WMO Mocha Oak	N/A	N/A	N/A	WMO Mocha Oak	N/A	N/A
N/A	WNO Natural Oak	N/A	N/A	N/A	WNO Natural Oak	N/A	N/A
N/A	WSO Salted Oak	N/A	N/A	N/A	WSO Salted Oak	N/A	N/A
WNF Natural Oak on Flat Cut	N/A	N/A	N/A	WNF Natural Oak on Flat Cut	N/A	N/A	N/A
WMF Mocha Oak on Flat Cut	N/A	N/A	N/A	WMF Mocha Oak on Flat Cut	N/A	N/A	N/A
WSF Salted Oak on Flat Cut	N/A	N/A	N/A	WSF Salted Oak on Flat Cut	N/A	N/A	N/A
N/A	TBCO Baby's Cheek	N/A	N/A	N/A	TBCO Baby's Cheek	N/A	N/A
N/A	TBSW Brown Sugar	N/A	N/A	N/A	TBSW Brown Sugar	N/A	N/A
N/A	TOBW Organic Brown	N/A	N/A	N/A	TOBW Organic Brown	N/A	N/A
N/A	TSTV Studio Teak Walnut	GSTV Studio Teak Walnut +10%	MTW Studio Teak Walnut	N/A	TSTV Studio Teak Walnut	N/A	N/A
N/A	TSMV Seattle Mist	N/A	N/A	N/A	TSMV Seattle Mist	N/A	N/A
N/A	TSLV Skyline Walnut	GSLV Skyline Walnut +10%	MSW Skyline Walnut	N/A	TSLV Skyline Walnut	N/A	N/A
WWP Designer White Paint	N/A	GWL Designer White	MWL Designer White	WWP Designer White Paint	N/A	GWL Designer White	MWL Designer White
N/A	N/A	N/A	MNA Narvik Ash	N/A	N/A	N/A	N/A

HPL TOPS ON TFL PRODUCTS Add 10% - Available with flat edge only
 Send 3x3 or larger finish chip for color match. Custom finish upcharge is 3% or \$250 Net (whichever is greater).



Finish

Welltech Finish delivers a superior furniture coating with exceptional performance that can withstand stringent cleaning agents and possesses unparalleled durability, allowing DARRAN to provide lasting, sustainable products to our customers.

Standard Profile

Central Park Edge for "W" and "G" Styles



Ledge*

"W" 3mm Solid Hardwood Band
"P" 3mm Solid Hardwood Band
"G" HPL Self Edge

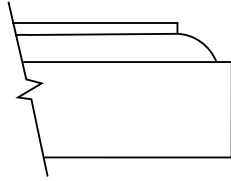

Classic*

"W" 3mm Solid Hardwood Band
"G" HPL Self Edge

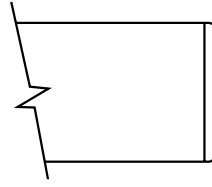

Flat

"W" 3mm Solid Hardwood Band
"P" 3mm Solid Hardwood Band
"G" HPL Self Edge

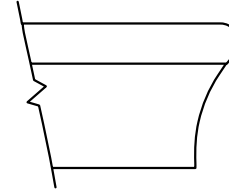

Knife*

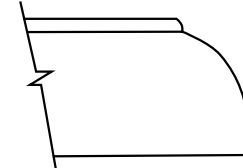

Waterfall*

"M" Standard profile

Central Park Edges for "M" Styles

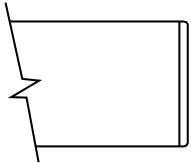

Flat

2 mm PVC Edge

***Coping Edges**

Pulls/Knobs

Factory Installed

\$15 per pull on Overhead and Wall Hung units

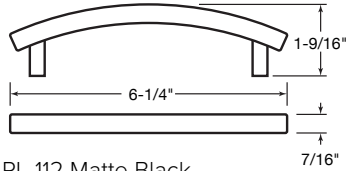

PL-112 Matte Black
PL-113 Matte Nickel

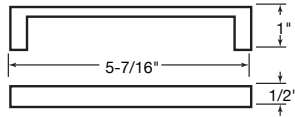

PL-115 Matte Black
PL-116 Matte Nickel

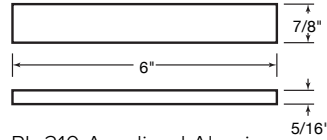

PL-210 Anodized Aluminum

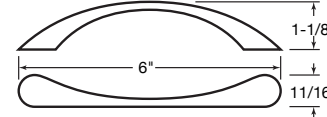

PL-105 Matte Black
PL-106 Matte Nickel

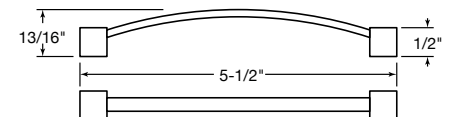

PL-125 Antique Pewter
PL-126 Antique English
PL-127 Matte Black

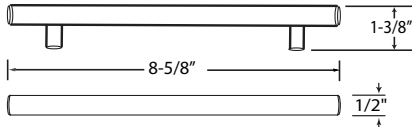

PL-310 Stainless Steel
PL-311 Royal Brass

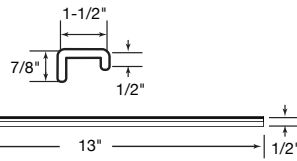

PL270 Stainless Steel \$35
PL-271 Matte Gold \$45
PL-272 Matte Black \$45

*Pulls are offset to one side on drawer front



PL273 Stainless Steel \$75
PL274 Matte Gold \$110
PL-275 Matte Black \$110

*Pulls are offset to one side on drawer front

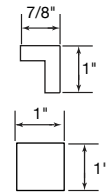

DK-270 Stainless Steel
DK-271 Matte Gold \$15
DK-272 Matte Black \$15



Silverluma
Frame
Doors

Open with touch
latch assist -
without pulls

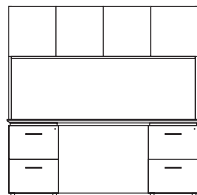

Overhead
Doors

Open with door
bottom overhang.
Pulls available on
request

TM30
Black
1-5/8" Dia.

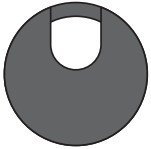

TM31
Silver
1-5/8" Dia.

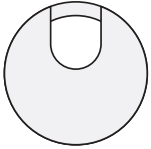

TM33
Antique Brass
1-5/8" Dia.

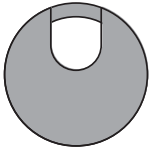

Optional grommets

Factory Installed

Grommets (Standard Location)

Specify Color and Left/Right/Center - \$50 ea.

- Black: TM30-R (Right), TM30-L (Left), TM30-C (Center)
- Silver: TM31-R (Right), TM31-L (Left), TM31-C (Center)
- Antique Brass: TM33-R (Right), TM33-L (Left), TM33-C (Center)

Grommets (Non-Standard Location)

Provide drawing w/ Grommet Location and Specify Color - \$95 ea.

- Black: TM30-NS
- Silver: TM31-NS
- Antique Brass: TM33-NS

TM50
Black
1-5/8" Dia.



Grommets (vertical surface)

Standard Location - \$50 ea.

- Black Plastic Vertical Surface: TM50-C (Bottom Center)

Non-Standard Location - \$95 ea.

- Black Plastic Vertical Surface: TM50-NS

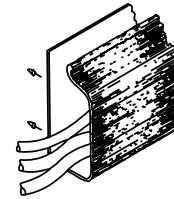

W1

Horizontal J-Channel

Horizontal J-Channel wire management (Sku: W-1) is sold separately to conceal wire under worksurfaces.

Standard Grommet Location Reference

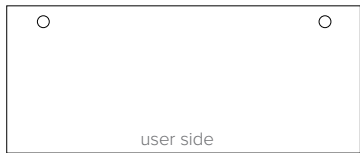

Desk
Specify Right or Left Grommet



6" Overhang Desk
Specify Right or Left Grommet

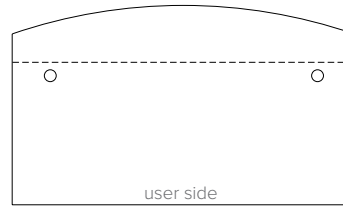

6"/12" Bow Front Desk
Specify Right or Left Grommet



Bullet Conference Desk (Right Post)
Center Grommet

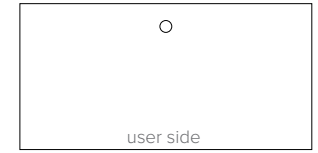

Bridge
Center Grommet

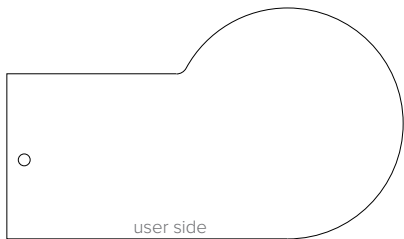

P Conference Desk (Right Post)
Center Grommet



Return (Left Pedestal Shown)
Right Pedestal - Left Grommet
Left Pedestal - Right Grommet



Workstation Credenza
Center Kneespace Grommet

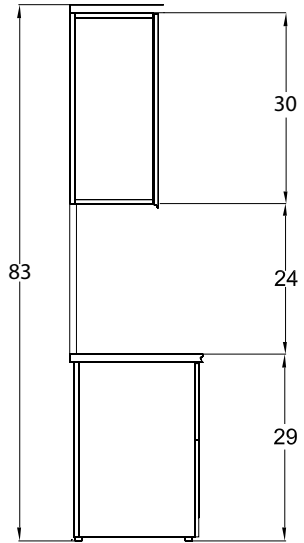

Typical Double Height Side Profile Wall Hung Overhead

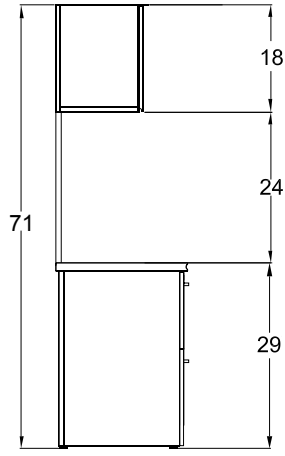

Typical Single Height Side Profile Wall Hung Overhead

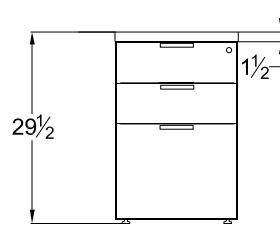

Pedestal Front Profile Box/Box/File

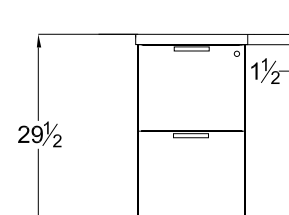

Pedestal Front Profile File/File

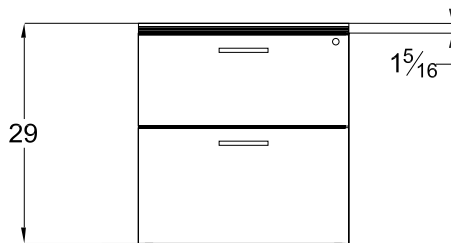

Pedestal Front Profile Lateral File

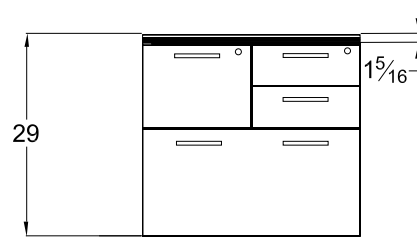

Pedestal Front Profile Multi-File

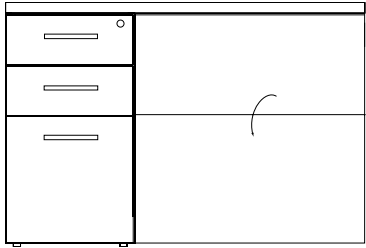

Top View

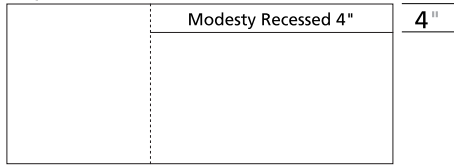

M34

Drop Door Tech Modesty

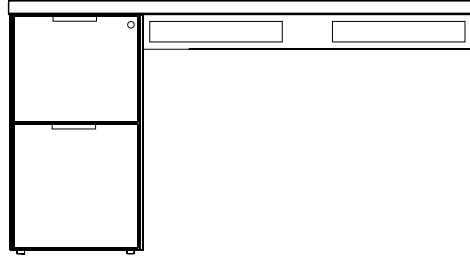

M51

Open Back Modesty with 4" Wire Management Rail

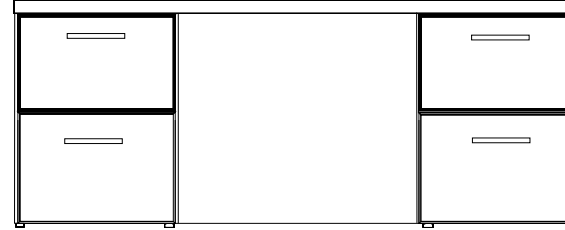

M37

Fixed Full Modesty

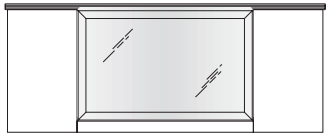

M39

Full Modesty
SilverLuma Frame w/ Frost Insert

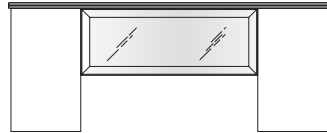

HM39

Half Modesty
SilverLuma Frame w/ Frost Insert

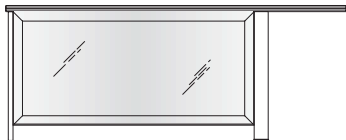

M45

Full Modesty
SilverLuma Frame w/ Frost Insert

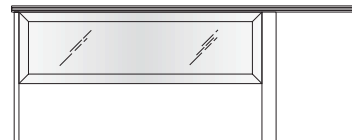

HM45

Half Modesty
SilverLuma Frame w/ Frost Insert

Panel Doors

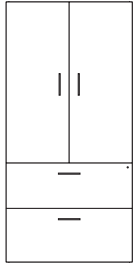

Silverluma Frame with Frosted Panel

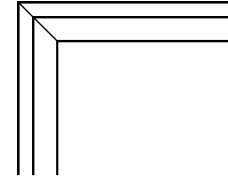
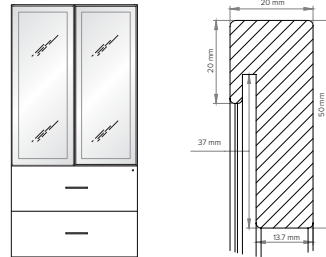

Grain Direction

Veneer chassis parts are vertical grain with the exception of Rift chassis parts. The backs of Thermally Fused Laminate overheads, wall hungs, wall hung shelves and flush chassis desks are horizontal grain. Bridges, returns, and credenza kneespace Thermally Fused Laminate backs over 60" are horizontal grain.

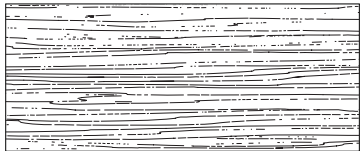

Desk

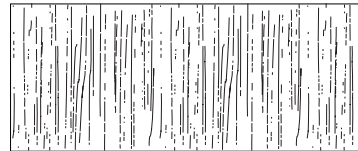

Runoff Desk
Grain Direction on TFL
Units Above 60" runs end to end

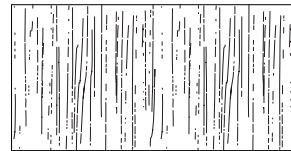

Bridge
Grain Direction on TFL
Units Above 60" runs end to end

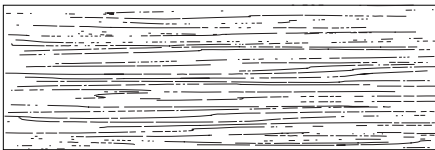

Credenza

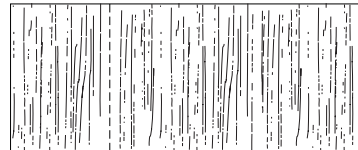

Return
Grain Direction on TFL
Units Above 60" runs end to end

Interior Drawer Dimensions

UNIT DEPTH	DRAWER TYPE	OVERALL DIMENSIONS			INTERIOR DRAWER DIMENSIONS			NOTES
		W	D	H	W	D	H	
15-5/8" Letter	36" Box	13-1/8	19-11/16	4	12-1/8	18-11/16	3-7/16	Units less than 72"
	36" File	13-1/8	19-11/16	9-13/16	12-1/8	18-11/16	9-5/16	Units less than 72"
	30" Box	13-1/8	19-11/16	4	12-1/8	18-11/16	3-7/16	Units less than 72"
	30" File	13-1/8	19-11/16	9-13/16	12-1/8	18-11/16	9-5/16	Units less than 72"
	24" Box	13-1/8	16-1/16	4	12-1/8	15-1/16	3-7/16	Units less than 72"
	24" File	13-1/8	16-1/16	9-13/16	12-1/8	15-1/16	9-5/16	Units less than 72"
29" Lateral	24" Box	26-1/2	16-1/16	4	25-1/2	15-1/16	3-7/16	Workstation Credenzas less than 82"
	24" File	26-1/2	16-1/16	9-13/16	25-1/2	15-1/16	9-5/16	Workstation Credenzas less than 82"
31" Lateral	24" File	28-9/16	16-1/16	9-13/16	27-9/16	15-1/16	9-5/16	Multi-File Lateral File
35" Lateral	24" Box	32-1/2	16-1/16	4	31-1/2	15-1/16	3-7/16	Workstation Credenzas over 83"
	24" File	32-1/2	16-1/16	9-13/16	31-1/2	15-1/16	9-5/16	Workstation Credenzas over 83"
41" Lateral	24" File	38-1/2	16-1/16	9-13/16	37-1/2	15-1/16	9-5/16	Wood Drawer Only

Filing Reference

Filing for 24" depth units

13 1/8" Wide File Drawer - 16 1/16" Deep

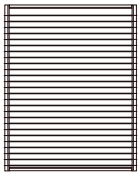

Letter Front to Back

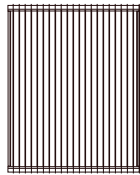

Legal Side to Side with File Rail

29" and 31" Lateral file drawer

29" : 26-1/2" Wide File Drawer - 16-1/16" Deep

31" : 28 9/16" Wide File Drawer - 16-1/16" Deep

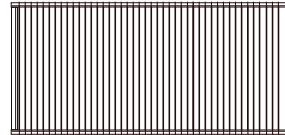

Legal Side to Side

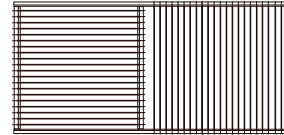

Legal Side to Side Letter Front to Back with File Rail

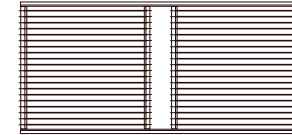

Letter Front to Back with File Rail

Filing for 30" & 36" depth units

13 1/8" Wide File Drawer - 19 11/16" Deep

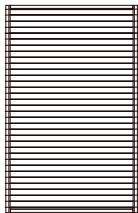

Letter Front to Back

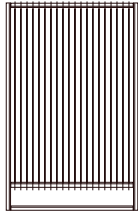

Legal Side to Side with File Rail

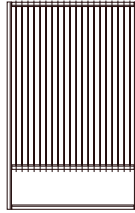

Letter Side to Side with File Rail

35" and 41" Lateral file drawer

35" : 32-1/2" Wide File Drawer - 16-1/16" Deep

41" : 38-1/2" Wide File Drawer - 16 1/16" Deep

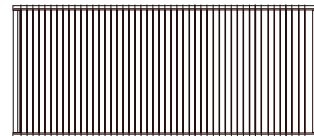

Legal Side to Side

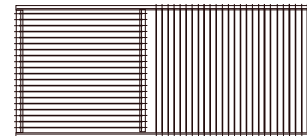

Legal Side to Side Letter Front to Back with File Rail

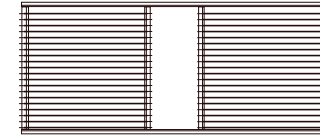

Letter Front to Back with File Rail

Central Park

Breakfront Chassis Desks
Double Pedestal Desk

[Click here to view statement of line](#)

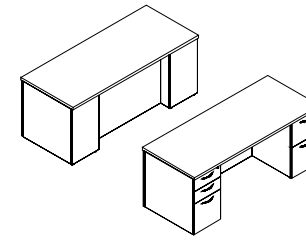

1 Select Model

w" x d" x h"	Weight
84 x 36 x 29	345
72 x 36 x 29	315
72 x 30 x 29	300
66 x 36 x 29	300
66 x 30 x 29	270
60 x 30 x 29	260

Standard Veneer Top Standard Veneer Chassis		Premium Veneer Top Premium Veneer Chassis		High Pressure Laminate Top Veneer Chassis		Thermally Fused Laminate Top Thermally Fused Laminate Chassis	
CPC8436DD000W	5026	CPC8436DD000P	5529	CPC8436DD000G	5026	CPC8436DD000M	2799
CPC7236DD000W	4534	CPC7236DD000P	4987	CPC7236DD000G	4534	CPC7236DD000M	2743
CPC7230DD000W	4490	CPC7230DD000P	4939	CPC7230DD000G	4490	CPC7230DD000M	2377
CPC6636DD000W	4503	CPC6636DD000P	4955	CPC6636DD000G	4503	CPC6636DD000M	2724
CPC6630DD000W	4378	CPC6630DD000P	4816	CPC6630DD000G	4378	CPC6630DD000M	2346
CPC6030DD000W	4119	CPC6030DD000P	4531	CPC6030DD000G	4119	CPC6030DD000M	2315

Product Features

- Box/Box/File (left)
- Breakfront chassis
- File/File (right)
- Legal/Letter filing
- "W" & "G" SKUs feature soft close suspensions, "M" SKUs feature ball bearing suspensions. Both suspensions are full extension.

Notes

- All units are standard w/ flush ends
- Modesty is recessed 6"

Options

Accessories

- K28: Articulating Keyboard w/ Mouse - \$390
- K31: Center drawer - \$205

Drawer

- P6: Modify File/File to Box/Box/File - \$55 per pedestal
- P33: Wood Drawer Upgrade - \$45 per drawer
- WPD3061: Designer White - \$80 per pedestal

Grommets (Standard Location)

- Specify Color and Left/Right - \$50 ea.
- Black: TM30-R (Right), TM30-L (Left)
- Silver: TM31-R (Right), TM31-L (Left)
- Antique Brass: TM33-R (Right), TM33-L (Left)

Grommets (Non-Standard Location)

- Provide drawing w/ Grommet Location and Specify Color - \$95 ea.
- Black: TM30-NS
- Silver: TM31-NS
- Antique Brass: TM33-NS

Modesty

- M39: SilverLuma frame/frost (Full Modesty) - \$650
- HM39: SilverLuma frame/frost (Half Modesty) - \$340

2 Select Finish

[Click to view finishes](#)

WAC	WNW
WIC	WWP
WHC	WNF(Natural
WOC	Oak on Flat
WEC	Cut)
WAM	WSF(Salted
WCM	Oak on Flat
WEW	Cut)
WGW	WMF(Mocha
WBW	Oak on Flat
WSW	Cut)

TBCO
TBSW
TSTV
TSMV
TSLV
TOBW
WMO
WNO
WSO

GAC +10%
GIC GSLV
GHC +10%
GOC GWL
GEC
GAM
GCM
GEW
GNW
GSTV

MAC
MOC
MEC
MGW
MTW
MSW
MWL
MNA

3 Select Edge

[Click to view edges](#)

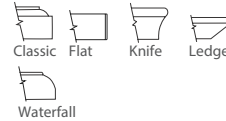
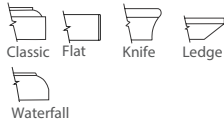

4 Select Hardware

[Click to view details](#)

See Intro Page
for Pull Options

See Intro Page
for Pull Options

See Intro Page
for Pull Options

See Intro Page
for Pull Options

Central Park

Breakfront Chassis Desks
Bowfront Double Pedestal Desk

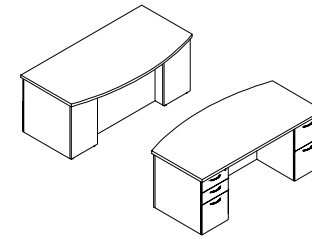

[Click here to view statement of line](#)

1 Select Model

w" x d" x h"	Weight
84 x 36/42 x 29	360
72 x 36/42 x 29	340
72 x 30/36 x 29	335
66 x 30/36 x 29	305

Standard Veneer Top Standard Veneer Chassis		Premium Veneer Top Premium Veneer Chassis		High Pressure Laminate Top Veneer Chassis		Thermally Fused Laminate Top Thermally Fused Laminate Chassis	
CPC8442DD006W	5607	CPC8442DD006P	6169	CPC8442DD006G	5607	CPC8442DD006M	2891
CPC7242DD006W	5116	CPC7242DD006P	5628	CPC7242DD006G	5116	CPC7242DD006M	2836
CPC7236DD006W	5043	CPC7236DD006P	5548	CPC7236DD006G	5043	CPC7236DD006M	2470
CPC6636DD006W	4835	CPC6636DD006P	5319	CPC6636DD006G	4835	CPC6636DD006M	2407

Product Features

- Box/Box/File (left)
- Breakfront chassis
- File/File (right)
- Legal/Letter filing
- "W" & "G" SKUs feature soft close suspensions, "M" SKUs feature ball bearing suspensions. Both suspensions are full extension.

Notes

- All units are standard w/ flush ends
- Modesty is recessed 12"
- Overhang 6"

Options

Accessories

- K28: Articulating Keyboard w/ Mouse - \$390
- K31: Center drawer - \$205

Drawer

- P6: Modify File/File to Box/Box/File - \$55 per pedestal
- P33: Wood Drawer Upgrade - \$45 per drawer
- WPD3061: Designer White - \$80 per pedestal

Grommets (Standard Location)

Specify Color and Left/Right - \$50 ea.

- Black: TM30-R (Right), TM30-L (Left)
- Silver: TM31-R (Right), TM31-L (Left)
- Antique Brass: TM33-R (Right), TM33-L (Left)

Grommets (Non-Standard Location)

Provide drawing w/ Grommet Location and Specify Color - \$95 ea.

- Black: TM30-NS
- Silver: TM31-NS
- Antique Brass: TM33-NS

Modesty

- M39: SilverLuma frame/frost (Full Modesty) - \$650
- HM39: SilverLuma frame/frost (Half Modesty) - \$340

2 Select Finish

[Click to view finishes](#)

WAC	WNW	TBCO	GAC +10%	MAC
WIC	WWP	TBSW	GIC GSLV	MOC
WHC	WNF(Natural	TSTV	GHC +10%	MEC
WOC	Oak on Flat	TSMV	GOC GWL	MGW
WEC	Cut)	TSLV	GEC	MTW
WAM	WSF(Salted	TOBW	GAM	MSW
WCM	Oak on Flat	WMO	GCM	MWL
WEW	Cut)	WNO	GEW	MNA
WGW	WMF(Mocha	WSO	GNW	
WBW	Oak on Flat		GSTV	
WSW	Cut)			

3 Select Edge

[Click to view edges](#)



4 Select Hardware

[Click to view details](#)

See Intro Page
for Pull Options

See Intro Page
for Pull Options

See Intro Page
for Pull Options

See Intro Page
for Pull Options

Central Park

Breakfront Chassis Desks
Conference Overhang Double Pedestal Desk

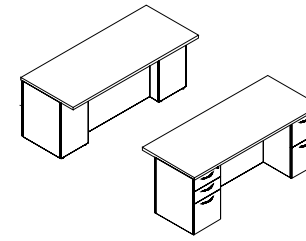

[Click here to view statement of line](#)

1 Select Model

w" x d" x h"
72 x 30 Chassis
72 x 36 x 29
72 x 24 Chassis
72 x 30 x 29
66 x 30 Chassis
66 x 36 x 29
66 x 24 Chassis
66 x 30 x 29

Weight	Standard Veneer Top Standard Veneer Chassis	Premium Veneer Top Premium Veneer Chassis	High Pressure Laminate Top Veneer Chassis	Thermally Fused Laminate Top Thermally Fused Laminate Chassis
315	CPC7236DD037W 4341	CPC7236DD037P 4776	CPC7236DD037G 4341	CPC7236DD037M 2470
300	CPC7230DD037W 4289	CPC7230DD037P 4718	CPC7230DD037G 4289	CPC7230DD037M 2339
300	CPC6636DD037W 4309	CPC6636DD037P 4741	CPC6636DD037G 4309	CPC6636DD037M 2407
280	CPC6630DD037W 4033	CPC6630DD037P 4437	CPC6630DD037G 4033	CPC6630DD037M 2307

Product Features

- Box/Box/File (left)
- Breakfront chassis
- File/File (right)
- Legal/Letter filing
- "W" & "G" SKUs feature soft close suspensions, "M" SKUs feature ball bearing suspensions. Both suspensions are full extension.

Notes

- All units are standard w/ flush ends
- Modesty is recessed 12"
- Overhang 6"

Options

Accessories

- K28: Articulating Keyboard w/ Mouse - \$390
- K31: Center drawer - \$205

Drawer

- P6: Modify File/File to Box/Box/File - \$55 per pedestal
- P33: Wood Drawer Upgrade - \$45 per drawer
- WPD3061: Designer White - \$80 per pedestal

Grommets (Standard Location)

- Specify Color and Left/Right - \$50 ea.
- Black: TM30-R (Right), TM30-L (Left)
 - Silver: TM31-R (Right), TM31-L (Left)
 - Antique Brass: TM33-R (Right), TM33-L (Left)

Grommets (Non-Standard Location)

- Provide drawing w/ Grommet Location and Specify Color - \$95 ea.
- Black: TM30-NS
 - Silver: TM31-NS
 - Antique Brass: TM33-NS

Modesty

- M39: SilverLuma frame/frost (Full Modesty) - \$650
- HM39: SilverLuma frame/frost (Half Modesty) - \$340

2 Select Finish

[Click to view finishes](#)

WAC	WNW
WIC	WWP
WHC	WNF(Natural
WOC	Oak on Flat
WEC	Cut)
WAM	WSF(Salted
WCM	Oak on Flat
WEW	Cut)
WGW	WMF(Mocha
WBW	Oak on Flat
WSW	Cut)

TBCO
TBSW
TSTV
TSMV
TSLV
TOBW
WMO
WNO
WSO

GAC +10%
GIC GSLV
GHC +10%
GOC GWL
GEC
GAM
GCM
GEW
GNW
GSTV

MAC
MOC
MEC
MGW
MTW
MSW
MWL
MNA

3 Select Edge

[Click to view edges](#)

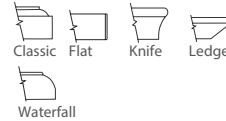
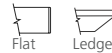
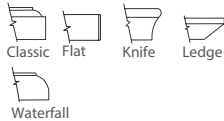

4 Select Hardware

[Click to view details](#)

See Intro Page
for Pull Options

See Intro Page
for Pull Options

See Intro Page
for Pull Options

See Intro Page
for Pull Options

Central Park

Breakfront Chassis Desks
Bowfront Conference Overhang Double Pedestal Desk

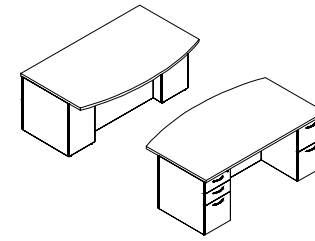

[Click here to view statement of line](#)

1 Select Model

w" x d" x h"
72 x 30 Chassis
72 x 36/42 x 29

Weight

Standard Veneer Top Standard Veneer Chassis	Premium Veneer Top Premium Veneer Chassis	High Pressure Laminate Top Veneer Chassis	Thermally Fused Laminate Top Thermally Fused Laminate Chassis
--	--	--	--

CPC7242DD043W 4956	CPC7242DD043P 5452	CPC7242DD043G 4956	CPC7242DD043M 2561
--------------------	--------------------	--------------------	--------------------

Product Features

- Box/Box/File (left)
- Breakfront chassis
- File/File (right)
- Legal/Letter filing
- "W" & "G" SKUs feature soft close suspensions, "M" SKUs feature ball bearing suspensions. Both suspensions are full extension.

Notes

- All units are standard w/ flush ends
- Modesty is recessed 18"
- Overhang 12"

Options

Accessories

- K28: Articulating Keyboard w/ Mouse - \$390
- K31: Center drawer - \$205

Drawer

- P6: Modify File/File to Box/Box/File - \$55 per pedestal
- P33: Wood Drawer Upgrade - \$45 per drawer
- WPD3061: Designer White - \$80 per pedestal

Grommets (Standard Location)

Specify Color and Left/Right - \$50 ea.

- Black: TM30-R (Right), TM30-L (Left)
- Silver: TM31-R (Right), TM31-L (Left)
- Antique Brass: TM33-R (Right), TM33-L (Left)

Grommets (Non-Standard Location)

Provide drawing w/ Grommet Location and Specify Color - \$95 ea.

- Black: TM30-NS
- Silver: TM31-NS
- Antique Brass: TM33-NS

Modesty

- M39: SilverLuma frame/frost (Full Modesty) - \$650
- HM39: SilverLuma frame/frost (Half Modesty) - \$340

2 Select Finish

[Click to view finishes](#)

WAC	WNW
WIC	WWP
WHC	WNF(Natural
WOC	Oak on Flat
WEC	Cut)
WAM	WSF(Salted
WCM	Oak on Flat
WEW	Cut)
WGW	WMF(Mocha
WBW	Oak on Flat
WSW	Cut)

TBCO
TBSW
TSTV
TSMV
TSLV
TOBW
WMO
WNO
WSO

GAC +10%
GIC GSLV
GHC +10%
GOC GWL
GEC
GAM
GCM
GEW
GNW
GSTV

MAC
MOC
MEC
MGW
MTW
MSW
MWL
MNA

3 Select Edge

[Click to view edges](#)

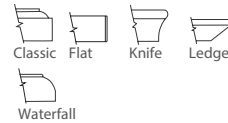
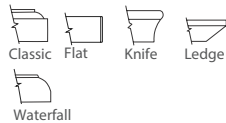

4 Select Hardware

[Click to view details](#)

See Intro Page
for Pull Options

See Intro Page
for Pull Options

See Intro Page
for Pull Options

See Intro Page
for Pull Options

Central Park

Breakfront Chassis Desks
Height Adjustable Double Pedestal Desk

[Click here to view statement of line](#)

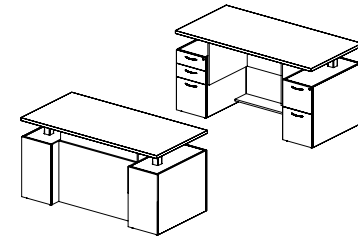

1 Select Model

w" x d" x h"	Weight
84 x 36 x 29	345
72 x 36 x 29	315
72 x 30 x 29	300
66 x 36 x 29	300
66 x 30 x 29	270
60 x 30 x 29	260

Standard Veneer Top Standard Veneer Chassis		Premium Veneer Top Premium Veneer Chassis		High Pressure Laminate Top Veneer Chassis		Thermally Fused Laminate Top Thermally Fused Laminate Chassis																																																																														
CPC8436DD004W	9349	CPC8436DD004P	10285	CPC8436DD004G	9349	CPC8436DD004M	7228																																																																													
CPC7236DD004W	9032	CPC7236DD004P	9936	CPC7236DD004G	9032	CPC7236DD004M	7132																																																																													
CPC7230DD004W	8702	CPC7230DD004P	9573	CPC7230DD004G	8702	CPC7230DD004M	6672																																																																													
CPC6636DD004W	8845	CPC6636DD004P	9730	CPC6636DD004G	8845	CPC6636DD004M	7014																																																																													
CPC6630DD004W	8522	CPC6630DD004P	9374	CPC6630DD004G	8522	CPC6630DD004M	6520																																																																													
CPC6030DD004W	8447	CPC6030DD004P	9292	CPC6030DD004G	8447	CPC6030DD004M	6478																																																																													
<p>2 Select Finish Click to view finishes</p> <table border="0"> <tr><td>WAC</td><td>WNW</td><td>TBCO</td><td>GAC +10%</td><td>MAC</td></tr> <tr><td>WIC</td><td>WWP</td><td>TBSW</td><td>GIC GSLV</td><td>MOC</td></tr> <tr><td>WHC</td><td>WNF(Natural</td><td>TSTV</td><td>GHC +10%</td><td>MEC</td></tr> <tr><td>WOC</td><td>Oak on Flat</td><td>TSMV</td><td>GOC GWL</td><td>MGW</td></tr> <tr><td>WEC</td><td>Cut)</td><td>TSLV</td><td>GEC</td><td>MTW</td></tr> <tr><td>WAM</td><td>WSF(Salted</td><td>TOBW</td><td>GAM</td><td>MSW</td></tr> <tr><td>WCM</td><td>Oak on Flat</td><td>WMO</td><td>GCM</td><td>MWL</td></tr> <tr><td>WEW</td><td>Cut)</td><td>WNO</td><td>GEW</td><td>MNA</td></tr> <tr><td>WGW</td><td>WMF(Mocha</td><td>WSO</td><td>GNW</td><td></td></tr> <tr><td>WBW</td><td>Oak on Flat</td><td></td><td>GSTV</td><td></td></tr> <tr><td>WSW</td><td>Cut)</td><td></td><td></td><td></td></tr> </table>		WAC	WNW	TBCO	GAC +10%	MAC	WIC	WWP	TBSW	GIC GSLV	MOC	WHC	WNF(Natural	TSTV	GHC +10%	MEC	WOC	Oak on Flat	TSMV	GOC GWL	MGW	WEC	Cut)	TSLV	GEC	MTW	WAM	WSF(Salted	TOBW	GAM	MSW	WCM	Oak on Flat	WMO	GCM	MWL	WEW	Cut)	WNO	GEW	MNA	WGW	WMF(Mocha	WSO	GNW		WBW	Oak on Flat		GSTV		WSW	Cut)				<p>3 Select Edge Click to view edges</p> <table border="0"> <tr> <td></td> <td></td> <td></td> <td></td> <td></td> <td></td> <td></td> <td></td> <td></td> <td></td> <td></td> <td></td> </tr> <tr> <td>Classic</td> <td>Flat</td> <td>Knife</td> <td>Ledge</td> <td>Flat</td> <td>Ledge</td> <td>Classic</td> <td>Flat</td> <td>Knife</td> <td>Ledge</td> <td>Waterfall</td> <td>Flat</td> </tr> </table>														Classic	Flat	Knife	Ledge	Flat	Ledge	Classic	Flat	Knife	Ledge	Waterfall	Flat	<p>4 Select Hardware Click to view details</p> <p>See Intro Page for Pull Options</p>	
WAC	WNW	TBCO	GAC +10%	MAC																																																																																
WIC	WWP	TBSW	GIC GSLV	MOC																																																																																
WHC	WNF(Natural	TSTV	GHC +10%	MEC																																																																																
WOC	Oak on Flat	TSMV	GOC GWL	MGW																																																																																
WEC	Cut)	TSLV	GEC	MTW																																																																																
WAM	WSF(Salted	TOBW	GAM	MSW																																																																																
WCM	Oak on Flat	WMO	GCM	MWL																																																																																
WEW	Cut)	WNO	GEW	MNA																																																																																
WGW	WMF(Mocha	WSO	GNW																																																																																	
WBW	Oak on Flat		GSTV																																																																																	
WSW	Cut)																																																																																			
Classic	Flat	Knife	Ledge	Flat	Ledge	Classic	Flat	Knife	Ledge	Waterfall	Flat																																																																									

Product Features

- Adjustable height from 29" to 47.5" with a maximum weight capacity of 350 lbs.
- Box/Box/File (left)
- Breakfront chassis
- File/File (right)
- Lift available in MFS Silver (standard) or MFB Black (optional)
- Legal/Letter filing
- Metal parts include 5 year warranty
- Privacy surround panels
- Programmable height adjustable mechanism, motor includes 2 year warranty
- "W" & "G" SKUs feature soft close suspensions, "M" SKUs feature ball bearing suspensions. Both suspensions are full extension.

Notes

- All units are standard w/ flush ends
- Modesty is recessed 6"

Options

Accessories

- K28: Articulating Keyboard w/ Mouse - \$390
- K31: Center drawer - \$205

Drawer

- P6: Modify File/File to Box/Box/File - \$55 per pedestal
- P33: Wood Drawer Upgrade - \$45 per drawer
- WPD3061: Designer White - \$80 per pedestal

Grommets (Standard Location)

- Specify Color and Left/Right - \$50 ea.
- Black: TM30-R (Right), TM30-L (Left)
- Silver: TM31-R (Right), TM31-L (Left)
- Antique Brass: TM33-R (Right), TM33-L (Left)

Grommets (Non-Standard Location)

- Provide drawing w/ Grommet Location and Specify Color - \$95 ea.
- Black: TM30-NS
- Silver: TM31-NS
- Antique Brass: TM33-NS

Modesty

- M39: SilverLuma frame/frost (Full Modesty) - \$650

Wire Management

- LWMB: Lift wire management box with flip down door - \$365
- Power strip with five outlets and 12' cord, mesh wire cover, 6" deep black box

Central Park

Flush Chassis Desks W/ Overhang
Full Double Pedestal Desk

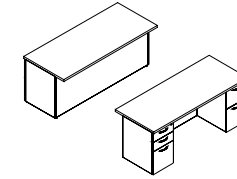

[Click here to view statement of line](#)

1 Select Model

w" x d" x h"	Weight
84 x 36 x 29	365
72 x 36 x 29	330
72 x 30 x 29	320
66 x 36 x 29	315
66 x 30 x 29	295
60 x 30 x 29	275

Standard Veneer Top Standard Veneer Chassis		Premium Veneer Top Premium Veneer Chassis		High Pressure Laminate Top Veneer Chassis		Thermally Fused Laminate Top Thermally Fused Laminate Chassis	
CPC8436DD032W	4812	CPC8436DD032P	5294	CPC8436DD032G	4812	CPC8436DD032M	2736
CPC7236DD032W	4341	CPC7236DD032P	4776	CPC7236DD032G	4341	CPC7236DD032M	2470
CPC7230DD032W	4194	CPC7230DD032P	4613	CPC7230DD032G	4194	CPC7230DD032M	2339
CPC6636DD032W	4309	CPC6636DD032P	4741	CPC6636DD032G	4309	CPC6636DD032M	2407
CPC6630DD032W	3700	CPC6630DD032P	4437	CPC6630DD032G	3700	CPC6630DD032M	2116
CPC6030DD032W	3778	CPC6030DD032P	4157	CPC6030DD032G	3778	CPC6030DD032M	2165

Product Features

- Box/Box/File (left)
- File/File (right)
- Legal/Letter filing
- "W" & "G" SKUs feature soft close suspensions, "M" SKUs feature ball bearing suspensions. Both suspensions are full extension.

Notes

- All units are standard w/ flush ends
- Modesty is recessed 6"
- 36" units have 30" chassis
- 30" units have 24" chassis

Options

Accessories

- K28: Articulating Keyboard w/ Mouse - \$390
- K31: Center drawer - \$205

Drawer

- P6: Modify File/File to Box/Box/File - \$55 per pedestal
- P33: Wood Drawer Upgrade - \$45 per drawer
- WPD3061: Designer White - \$80 per pedestal

Grommets (Standard Location)

Specify Color and Left/Right - \$50 ea.

- Black: TM30-R (Right), TM30-L (Left)
- Silver: TM31-R (Right), TM31-L (Left)
- Antique Brass: TM33-R (Right), TM33-L (Left)

Grommets (Non-Standard Location)

Provide drawing w/ Grommet Location and Specify Color - \$95 ea.

- Black: TM30-NS
- Silver: TM31-NS
- Antique Brass: TM33-NS

2 Select Finish

[Click to view finishes](#)

WAC	WNW
WIC	WWP
WHC	WNF(Natural
WOC	Oak on Flat
WEC	Cut)
WAM	WSF(Salted
WCM	Oak on Flat
WEW	Cut)
WGW	WMF(Mocha
WBW	Oak on Flat
WSW	Cut)

TBCO
TBSW
TSTV
TSMV
TSLV
TOBW
WMO
WNO
WSO

GAC +10%
GIC GSLV
GHC +10%
GOC GWL
GEC
GAM
GCM
GEW
GNW
GSTV

MAC
MOC
MEC
MGW
MTW
MSW
MWL
MNA

3 Select Edge

[Click to view edges](#)

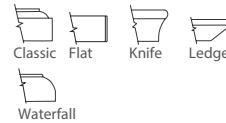
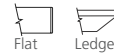
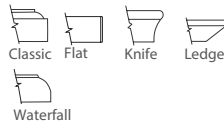

4 Select Hardware

[Click to view details](#)

See Intro Page
for Pull Options

See Intro Page
for Pull Options

See Intro Page
for Pull Options

See Intro Page
for Pull Options

Central Park

Flush Chassis Desks W/ Overhang
Height Adjustable Full Double Pedestal Desk

[Click here to view statement of line](#)

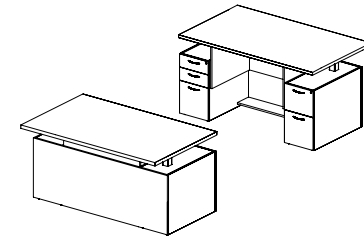

1 Select Model

w" x d" x h"	Weight
84 x 36 x 29	365
72 x 36 x 29	330
72 x 30 x 29	320
66 x 36 x 29	315
66 x 30 x 29	295
60 x 30 x 29	275

Standard Veneer Top Standard Veneer Chassis		Premium Veneer Top Premium Veneer Chassis		High Pressure Laminate Top Veneer Chassis		Thermally Fused Laminate Top Thermally Fused Laminate Chassis	
CPC8436DD033W	9073	CPC8436DD033P	9981	CPC8436DD033G	9073	CPC8436DD033M	6953
CPC7236DD033W	8756	CPC7236DD033P	9633	CPC7236DD033G	8756	CPC7236DD033M	6858
CPC7230DD033W	8426	CPC7230DD033P	9269	CPC7230DD033G	8426	CPC7230DD033M	6396
CPC6636DD033W	8571	CPC6636DD033P	9429	CPC6636DD033G	8571	CPC6636DD033M	6740
CPC6630DD033W	8247	CPC6630DD033P	9073	CPC6630DD033G	8247	CPC6630DD033M	6246
CPC6030DD033W	8173	CPC6030DD033P	8991	CPC6030DD033G	8173	CPC6030DD033M	6204

2 Select Finish

[Click to view finishes](#)

WAC	WNW
WIC	WWP
WHC	WNF(Natural
WOC	Oak on Flat
WEC	Cut)
WAM	WSF(Salted
WCM	Oak on Flat
WEW	Cut)
WGW	WMF(Mocha
WBW	Oak on Flat
WSW	Cut)

TBCO
TBSW
TSTV
TSMV
TSLV
TOBW
WMO
WNO
WSO

GAC +10%
GIC GSLV
GHC +10%
GOC GWL
GEC
GAM
GCM
GEW
GNW
GSTV

MAC
MOC
MEC
MGW
MTW
MSW
MWL
MNA

3 Select Edge

[Click to view edges](#)

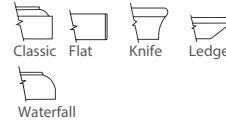
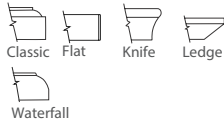

4 Select Hardware

[Click to view details](#)

[See Intro Page for Pull Options](#)

[See Intro Page for Pull Options](#)

[See Intro Page for Pull Options](#)

[See Intro Page for Pull Options](#)

Product Features

- Adjustable height from 29" to 47.5" with a maximum weight capacity of 350 lbs.
- Box/Box/File (left)
- File/File (right)
- Legal/Letter filing
- Lift available in MFS Silver (standard) or MFB Black (optional)
- Metal parts include 5 year warranty
- Privacy surround panels
- Programmable height adjustable mechanism, motor includes 2 year warranty
- "W" & "G" SKUs feature soft close suspensions, "M" SKUs feature ball bearing suspensions. Both suspensions are full extension.

Notes

- All units are standard w/ flush ends
- Modesty is recessed 6"
- 36" units have 30" chassis
- 30" units have 24" chassis

Options

Accessories

- K28: Articulating Keyboard w/ Mouse - \$390
- K31: Center drawer - \$205

Drawer

- P6: Modify File/File to Box/Box/File - \$55 per pedestal
- P33: Wood Drawer Upgrade - \$45 per drawer
- WPD3061: Designer White - \$80 per pedestal fronts

Grommets (Standard Location)

Specify Color and Left/Right - \$50 ea.

- Black: TM30-R (Right), TM30-L (Left)
- Silver: TM31-R (Right), TM31-L (Left)
- Antique Brass: TM33-R (Right), TM33-L (Left)

Grommets (Non-Standard Location)

Provide drawing w/ Grommet Location and Specify Color - \$95 ea.

- Black: TM30-NS
- Silver: TM31-NS
- Antique Brass: TM33-NS

Wire Management

- LWMB: Lift wire management box with flip down door - \$365
- Power strip with five outlets and 12' cord, mesh wire cover, 6" deep black box

Central Park

Table Desks With Sleigh Base
Rectangle With Sleigh Legs

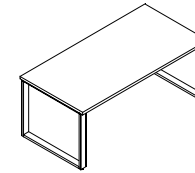

[Click here to view statement of line](#)

1 Select Model

w" x d" x h"	Weight
72 x 36 x 29	150
72 x 30 x 29	135
66 x 30 x 29	125
60 x 30 x 29	115

Standard Veneer Top Standard Veneer Chassis		Premium Veneer Top Premium Veneer Chassis		High Pressure Laminate Top Veneer Chassis		Thermally Fused Laminate Top Thermally Fused Laminate Chassis	
CPC7236DT099W	3546	CPC7236DT099P	3902	CPC7236DT099G	3546	CPC7236DT099M	2015
CPC7230DT099W	3402	CPC7230DT099P	3744	CPC7230DT099G	3402	CPC7230DT099M	1860
CPC6630DT099W	3353	CPC6630DT099P	3689	CPC6630DT099G	3353	CPC6630DT099M	1835
CPC6030DT099W	3313	CPC6030DT099P	3644	CPC6030DT099G	3313	CPC6030DT099M	1812

Product Features

- Metal sleigh base - standard silver finish

Notes

- All units are standard w/ flush ends

Options

Accessories

- K28: Articulating Keyboard w/ Mouse - \$390
- K31: Center drawer - \$205
- K31-SK: Center drawer w/ skirt - \$310

Grommets (Standard Location)

- Specify Color and Left/Right - \$50 ea.
- Black: TM30-R (Right), TM30-L (Left)
 - Silver: TM31-R (Right), TM31-L (Left)
 - Antique Brass: TM33-R (Right), TM33-L (Left)

Grommets (Non-Standard Location)

Provide drawing w/ Grommet Location and Specify Color - \$95 ea.

- Black: TM30-NS
- Silver: TM31-NS
- Antique Brass: TM33-NS

Modesty

- HM45: SilverLuma frame/frost insert (half modesty) - \$415
- MC51: Half veneer/laminate modesty - \$130

Premium Finish Option

- MFB: Black Metal Finish - \$160 per base

2 Select Finish

[Click to view finishes](#)

Metal Finish

MFS Silver. Additional

Metal Finishes are available, options

WAC	WNW
WIC	WWP
WHC	WNF(Natural
WOC	Oak on Flat
WEC	Cut)
WAM	WSF(Salted
WCM	Oak on Flat
WEW	Cut)
WGW	WMF(Mocha
WBW	Oak on Flat
WSW	Cut)

TBCO
TBSW
TSTV
TSMV
TSLV
TOBW
WMO
WNO
WSO

GAC +10%
GIC GSLV
GHC +10%
GOC GWL
GEC
GAM
GCM
GEW
GNW
GSTV

MAC
MOC
MEC
MGW
MTW
MSW
MWL
MNA

3 Select Edge

[Click to view edges](#)

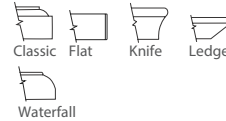
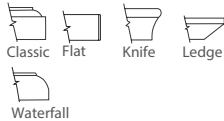

4 Select Hardware

[Click to view details](#)

Hardware
N/A

Hardware
N/A

Hardware
N/A

Hardware
N/A

Central Park

Desks
Crt Desk / Printer

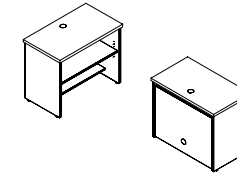

[Click here to view statement of line](#)

1 Select Model

w" x d" x h"	Weight
48 x 24 x 29	150
35 x 24 x 29	110
29 x 24 x 29	95

Standard Veneer Top Standard Veneer Chassis		Premium Veneer Top Premium Veneer Chassis		High Pressure Laminate Top Veneer Chassis		Thermally Fused Laminate Top Thermally Fused Laminate Chassis																																																																																		
CPC4824AU225W	1882	CPC4824AU225P	2070	CPC4824AU225G	1882	CPC4824AU225M	1196																																																																																	
CPC3524AU225W	1761	CPC3524AU225P	1937	CPC3524AU225G	1761	CPC3524AU225M	1116																																																																																	
CPC2924AU225W	1635	CPC2924AU225P	1799	CPC2924AU225G	1635	CPC2924AU225M	1034																																																																																	
<p>2 Select Finish Click to view finishes</p> <table border="0"> <tr> <td>WAC</td> <td>WNW</td> <td>TBCO</td> <td>GAC +10%</td> <td>MAC</td> </tr> <tr> <td>WIC</td> <td>WWP</td> <td>TBSW</td> <td>GIC GSLV</td> <td>MOC</td> </tr> <tr> <td>WHC</td> <td>WNF(Natural</td> <td>TSTV</td> <td>GHC +10%</td> <td>MEC</td> </tr> <tr> <td>WOC</td> <td>Oak on Flat</td> <td>TSMV</td> <td>GOC GWL</td> <td>MGW</td> </tr> <tr> <td>WEC</td> <td>Cut)</td> <td>TSLV</td> <td>GEC</td> <td>MTW</td> </tr> <tr> <td>WAM</td> <td>WSF(Salted</td> <td>TOBW</td> <td>GAM</td> <td>MSW</td> </tr> <tr> <td>WCM</td> <td>Oak on Flat</td> <td>WMO</td> <td>GCM</td> <td>MWL</td> </tr> <tr> <td>WEW</td> <td>Cut)</td> <td>WNO</td> <td>GEW</td> <td>MNA</td> </tr> <tr> <td>WGW</td> <td>WMF(Mocha</td> <td>WSO</td> <td>GNW</td> <td></td> </tr> <tr> <td>WBW</td> <td>Oak on Flat</td> <td></td> <td>GSTV</td> <td></td> </tr> <tr> <td>WSW</td> <td>Cut)</td> <td></td> <td></td> <td></td> </tr> </table>		WAC	WNW	TBCO	GAC +10%	MAC	WIC	WWP	TBSW	GIC GSLV	MOC	WHC	WNF(Natural	TSTV	GHC +10%	MEC	WOC	Oak on Flat	TSMV	GOC GWL	MGW	WEC	Cut)	TSLV	GEC	MTW	WAM	WSF(Salted	TOBW	GAM	MSW	WCM	Oak on Flat	WMO	GCM	MWL	WEW	Cut)	WNO	GEW	MNA	WGW	WMF(Mocha	WSO	GNW		WBW	Oak on Flat		GSTV		WSW	Cut)				<p>3 Select Edge Click to view edges</p> <table border="0"> <tr> <td></td> <td></td> <td></td> <td></td> <td></td> </tr> <tr> <td>Classic</td> <td>Flat</td> <td>Knife</td> <td>Ledge</td> <td>Flat</td> </tr> <tr> <td></td> <td></td> <td></td> <td></td> <td></td> </tr> <tr> <td>Waterfall</td> <td></td> <td></td> <td></td> <td></td> </tr> </table>							Classic	Flat	Knife	Ledge	Flat						Waterfall					<p>4 Select Hardware Click to view details</p> <table border="0"> <tr> <td>Hardware</td> <td>Hardware</td> <td>Hardware</td> <td>Hardware</td> </tr> <tr> <td>N/A</td> <td>N/A</td> <td>N/A</td> <td>N/A</td> </tr> </table>		Hardware	Hardware	Hardware	Hardware	N/A	N/A	N/A	N/A
WAC	WNW	TBCO	GAC +10%	MAC																																																																																				
WIC	WWP	TBSW	GIC GSLV	MOC																																																																																				
WHC	WNF(Natural	TSTV	GHC +10%	MEC																																																																																				
WOC	Oak on Flat	TSMV	GOC GWL	MGW																																																																																				
WEC	Cut)	TSLV	GEC	MTW																																																																																				
WAM	WSF(Salted	TOBW	GAM	MSW																																																																																				
WCM	Oak on Flat	WMO	GCM	MWL																																																																																				
WEW	Cut)	WNO	GEW	MNA																																																																																				
WGW	WMF(Mocha	WSO	GNW																																																																																					
WBW	Oak on Flat		GSTV																																																																																					
WSW	Cut)																																																																																							
Classic	Flat	Knife	Ledge	Flat																																																																																				
Waterfall																																																																																								
Hardware	Hardware	Hardware	Hardware																																																																																					
N/A	N/A	N/A	N/A																																																																																					

Product Features

- 1 Standard grommet - matches pull finish or specify black TM30, silver TM31 or antique brass TM33
- 6" D Foot rest/adjustable storage shelf
- Paper/wire access back
- Vertical surface grommet - TM50 Black

Notes

- All units are standard w/ flush ends

Options

Accessories

- K28: Articulating Keyboard w/ Mouse - \$390

Grommets (Non-Standard Location)

Provide drawing w/ Grommet Location and Specify Color - \$95 ea.

- Black: TM30-NS
- Silver: TM31-NS
- Antique Brass: TM33-NS

Grommets (Vertical Surface)

Non-Standard Location - \$95 ea.

- Black Plastic Vertical Surface: TM50-NS

Central Park

Double Breakfront / Single Pedestal Desks
Single Full Pedestal

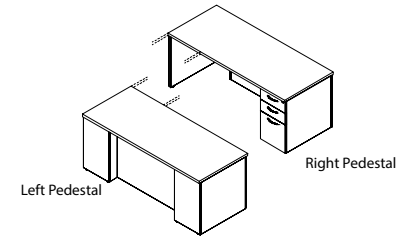

[Click here to view statement of line](#)

1 Select Model

w" x d" x h"	Weight
Left Pedestal	
72 x 36 x 29	275
72 x 30 x 29	265
66 x 36 x 29	265
66 x 30 x 29	225
Right Pedestal	
72 x 36 x 29	275
72 x 30 x 29	265
66 x 36 x 29	265
66 x 30 x 29	225

Standard Veneer Top Standard Veneer Chassis		Premium Veneer Top Premium Veneer Chassis		High Pressure Laminate Top Veneer Chassis		Thermally Fused Laminate Top Thermally Fused Laminate Chassis	
CPC7236DS009W	4039	CPC7236DS009P	4443	CPC7236DS009G	4039	CPC7236DS009M	2352
CPC7230DS009W	3902	CPC7230DS009P	4292	CPC7230DS009G	3902	CPC7230DS009M	2070
CPC6636DS009W	3947	CPC6636DS009P	4343	CPC6636DS009G	3947	CPC6636DS009M	2332
CPC6630DS009W	3810	CPC6630DS009P	4192	CPC6630DS009G	3810	CPC6630DS009M	2024
CPC7236DS010W	4039	CPC7236DS010P	4443	CPC7236DS010G	4039	CPC7236DS010M	2352
CPC7230DS010W	3902	CPC7230DS010P	4292	CPC7230DS010G	3902	CPC7230DS010M	2070
CPC6636DS010W	3947	CPC6636DS010P	4343	CPC6636DS010G	3947	CPC6636DS010M	2332
CPC6630DS010W	3810	CPC6630DS010P	4192	CPC6630DS010G	3810	CPC6630DS010M	2024

Product Features

- Box/Box/File
- Hookup hardware
- Legal/Letter filing
- "W" & "G" SKUs feature soft close suspensions, "M" SKUs feature ball bearing suspensions. Both suspensions are full extension.

Notes

- 6" Recessed Modesty
- All units are standard w/ flush ends

Options

Accessories

- K28: Articulating Keyboard w/ Mouse - \$390
- K31: Center drawer - \$205

Drawer

- P6: Modify Box/Box/File to File/File - \$55 per pedestal
- P33: Wood Drawer Upgrade - \$45 per drawer
- WPD3061: Designer White - \$80 per pedestal

Grommets (Standard Location)

- Specify Color and Left/Right - \$50 ea.
- Black: TM30-R (Right), TM30-L (Left)
 - Silver: TM31-R (Right), TM31-L (Left)
 - Antique Brass: TM33-R (Right), TM33-L (Left)

Grommets (Non-Standard Location)

- Provide drawing w/ Grommet Location and Specify Color - \$95 ea.
- Black: TM30-NS
 - Silver: TM31-NS
 - Antique Brass: TM33-NS

Modesty

- M39: SilverLuma frame/frost (Full Modesty) - \$650
- HM39: SilverLuma frame/frost (Half Modesty) - \$340

2 Select Finish

[Click to view finishes](#)

WAC	WNW
WIC	WWP
WHC	WNF(Natural
WOC	Oak on Flat
WEC	Cut)
WAM	WSF(Salted
WCM	Oak on Flat
WEW	Cut)
WGW	WMF(Mocha
WBW	Oak on Flat
WSW	Cut)

TBCO
TBSW
TSTV
TSMV
TSLV
TOBW
WMO
WNO
WSO

GAC +10%
GIC GSLV
GHC +10%
GOC GWL
GEC
GAM
GCM
GEW
GNW
GSTV

MAC
MOC
MEC
MGW
MTW
MSW
MWL
MNA

3 Select Edge

[Click to view edges](#)

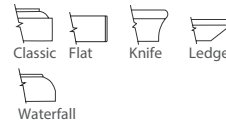
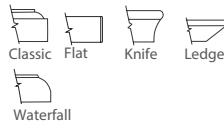

4 Select Hardware

[Click to view details](#)

[See Intro Page for Pull Options](#)

[See Intro Page for Pull Options](#)

[See Intro Page for Pull Options](#)

[See Intro Page for Pull Options](#)

Central Park

Double Breakfront / Single Pedestal Desks
Bowfront Single Full Pedestal

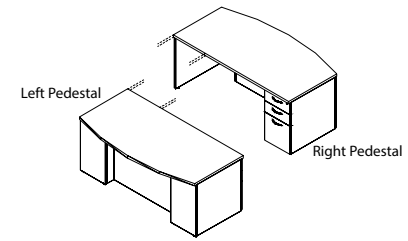

[Click here to view statement of line](#)

1 Select Model

w" x d" x h"	Weight
Left Pedestal	
72 x 36/42 x 29	295
72 x 30/36 x 29	285
66 x 30/36 x 29	270
Right Pedestal	
72 x 36/42 x 29	295
72 x 30/36 x 29	285
66 x 30/36 x 29	270

Standard Veneer Top Standard Veneer Chassis		Premium Veneer Top Premium Veneer Chassis		High Pressure Laminate Top Veneer Chassis		Thermally Fused Laminate Top Thermally Fused Laminate Chassis	
CPC7242DS017W	4577	CPC7242DS017P	5035	CPC7242DS017G	4577	CPC7242DS017M	2444
CPC7236DS017W	4512	CPC7236DS017P	4963	CPC7236DS017G	4512	CPC7236DS017M	2165
CPC6636DS017W	4444	CPC6636DS017P	4889	CPC6636DS017G	4444	CPC6636DS017M	2114
CPC7242DS018W	4577	CPC7242DS018P	5035	CPC7242DS018G	4577	CPC7242DS018M	2444
CPC7236DS018W	4512	CPC7236DS018P	4963	CPC7236DS018G	4512	CPC7236DS018M	2165
CPC6636DS018W	4444	CPC6636DS018P	4889	CPC6636DS018G	4444	CPC6636DS018M	2114

Product Features

- Box/Box/File
- Hookup hardware
- Legal/Letter filing
- "W" & "G" SKUs feature soft close suspensions, "M" SKUs feature ball bearing suspensions. Both suspensions are full extension.

Notes

- 12" Recessed Modesty
- All units are standard w/ flush ends

Options

Accessories

- K28: Articulating Keyboard w/ Mouse - \$390
- K31: Center drawer - \$205

Drawer

- P6: Modify Box/Box/File to File/File - \$55 per pedestal
- P33: Wood Drawer Upgrade - \$45 per drawer
- WPD3061: Designer White - \$80 per pedestal

Grommets (Standard Location)

- Specify Color and Left/Right - \$50 ea.
- Black: TM30-R (Right), TM30-L (Left)
 - Silver: TM31-R (Right), TM31-L (Left)
 - Antique Brass: TM33-R (Right), TM33-L (Left)

Grommets (Non-Standard Location)

- Provide drawing w/ Grommet Location and Specify Color - \$95 ea.
- Black: TM30-NS
 - Silver: TM31-NS
 - Antique Brass: TM33-NS

Modesty

- M39: SilverLuma Frame w/ Frost insert (full modesty) - \$650
- HM39: SilverLuma Frame w/ Frost insert (half modesty) - \$340

2 Select Finish

[Click to view finishes](#)

WAC	WNW
WIC	WWP
WHC	WNF(Natural
WOC	Oak on Flat
WEC	Cut)
WAM	WSF(Salted
WCM	Oak on Flat
WEW	Cut)
WGW	WMF(Mocha
WBW	Oak on Flat
WSW	Cut)

TBCO
TBSW
TSTV
TSMV
TSLV
TOBW
WMO
WNO
WSO

GAC +10%
GIC GSLV
GHC +10%
GOC GWL
GEC
GAM
GCM
GEW
GNW
GSTV

MAC
MOC
MEC
MGW
MTW
MSW
MWL
MNA

3 Select Edge

[Click to view edges](#)

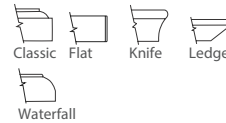
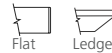
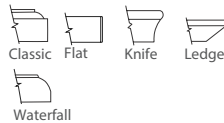

4 Select Hardware

[Click to view details](#)

[See Intro Page for Pull Options](#)

[See Intro Page for Pull Options](#)

[See Intro Page for Pull Options](#)

[See Intro Page for Pull Options](#)

Central Park

Double Breakfront / Single Pedestal Desks
 Conference Overhang Single Full Pedestal

[Click here to view statement of line](#)

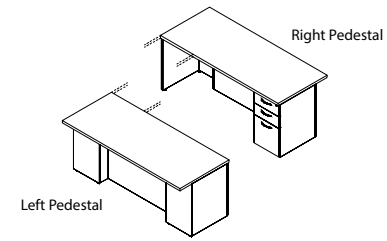

1 Select Model

w" x d" x h"	Weight
Left Pedestal	
72 x 36 x 29	275
72 x 30 x 29	255
66 x 36 x 29	260
66 x 30 x 29	225
Right Pedestal	
72 x 36 x 29	275
72 x 30 x 29	255
66 x 36 x 29	260
66 x 30 x 29	225

	Standard Veneer Top Standard Veneer Chassis		Premium Veneer Top Premium Veneer Chassis		High Pressure Laminate Top Veneer Chassis		Thermally Fused Laminate Top Thermally Fused Laminate Chassis	
WAC	CPC7236DS634W	3909	CPC7236DS634P	4299	CPC7236DS634G	3909	CPC7236DS634M	2165
WIC	CPC7230DS634W	3675	CPC7230DS634P	4042	CPC7230DS634G	3675	CPC7230DS634M	2033
WHC	CPC6636DS634W	3818	CPC6636DS634P	4198	CPC6636DS634G	3818	CPC6636DS634M	2114
WOC	CPC6630DS634W	3593	CPC6630DS634P	3951	CPC6630DS634G	3593	CPC6630DS634M	1984
WEC								
WAM	CPC7236DS633W	3909	CPC7236DS633P	4299	CPC7236DS633G	3909	CPC7236DS633M	2165
WCM	CPC7230DS633W	3675	CPC7230DS633P	4042	CPC7230DS633G	3675	CPC7230DS633M	2033
WCM	CPC6636DS633W	4008	CPC6636DS633P	4408	CPC6636DS633G	4008	CPC6636DS633M	2114
WEW	CPC6630DS633W	3593	CPC6630DS633P	3953	CPC6630DS633G	3593	CPC6630DS633M	1984
WGW								
WBW								
WSW								
TBCO								
TBSW								
TSTV								
TSMV								
TSLV								
TOBW								
WMO								
WNO								
WSO								
GAC +10%								
GIC GSLV								
GHC +10%								
GOC GWL								
GEC								
GAM								
GCM								
GEW								
GNW								
GSTV								
MAC								
MOC								
MEC								
MGW								
MTW								
MSW								
MWL								
MNA								

Product Features

- Box/Box/File
- Hookup hardware
- Legal/Letter filing
- "W" & "G" SKUs feature soft close suspensions, "M" SKUs feature ball bearing suspensions. Both suspensions are full extension.

Notes

- 12" Recessed Modesty
- 30"D Has 24"D Chassis
- 36"D Has 30"D Chassis
- All units are standard w/ flush ends

Options

Accessories

- K28: Articulating Keyboard w/ Mouse - \$390
- K31: Center drawer - \$205

Drawer

- P6: Modify Box/Box/File to File/File - \$55 per pedestal
- P33: Wood Drawer Upgrade - \$45 per drawer
- WPD3061: Designer White - \$80 per pedestal

Grommets (Standard Location)

- Specify Color and Left/Right - \$50 ea.
- Black: TM30-R (Right), TM30-L (Left)
 - Silver: TM31-R (Right), TM31-L (Left)
 - Antique Brass: TM33-R (Right), TM33-L (Left)

Grommets (Non-Standard Location)

- Provide drawing w/ Grommet Location and Specify Color - \$95 ea.
- Black: TM30-NS
 - Silver: TM31-NS
 - Antique Brass: TM33-NS

Modesty

- M39: SilverLuma Frame w/ Frost insert (full modesty) - \$650
- HM39: SilverLuma Frame w/ Frost insert (half modesty) - \$340

2 Select Finish

[Click to view finishes](#)

WAC	WNW
WIC	WWP
WHC	WNF(Natural
WOC	Oak on Flat
WEC	Cut)
WAM	WSF(Salted
WCM	Oak on Flat
WEW	Cut)
WGW	WMF(Mocha
WBW	Oak on Flat
WSW	Cut)

3 Select Edge

[Click to view edges](#)

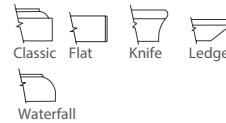
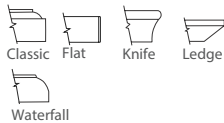

4 Select Hardware

[Click to view details](#)

See Intro Page
for Pull Options

See Intro Page
for Pull Options

See Intro Page
for Pull Options

See Intro Page
for Pull Options

Central Park

Double Breakfront / Single Pedestal Desks
Bowfront Conference Overhang Single Full Pedestal

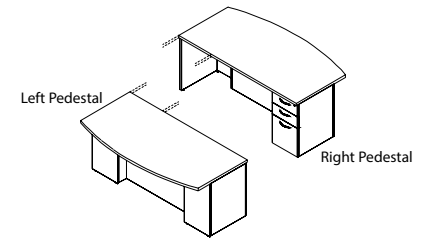

[Click here to view statement of line](#)

1 Select Model

w" x d" x h"	Weight
Left Pedestal	
72 x 36/42 x 29	285
72 x 30/36 x 29	265
66 x 30/36 x 29	245
Right Pedestal	
72 x 36/42 x 29	285
72 x 30/36 x 29	265
66 x 30/36 x 29	245

Standard Veneer Top Standard Veneer Chassis		Premium Veneer Top Premium Veneer Chassis		High Pressure Laminate Top Veneer Chassis		Thermally Fused Laminate Top Thermally Fused Laminate Chassis	
CPC7242DS636W	4268	CPC7242DS636P	4695	CPC7242DS636G	4268	CPC7242DS636M	2257
CPC7236DS636W	4177	CPC7236DS636P	4596	CPC7236DS636G	4177	CPC7236DS636M	2129
CPC6636DS636W	4116	CPC6636DS636P	4528	CPC6636DS636G	4116	CPC6636DS636M	2078
CPC7242DS635W	4268	CPC7242DS635P	4695	CPC7242DS635G	4268	CPC7242DS635M	2257
CPC7236DS635W	4177	CPC7236DS635P	4596	CPC7236DS635G	4177	CPC7236DS635M	2129
CPC6636DS635W	4116	CPC6636DS635P	4528	CPC6636DS635G	4116	CPC6636DS635M	2078

Product Features

- Box/Box/File
- Hookup hardware
- Legal/Letter filing
- "W" & "G" SKUs feature soft close suspensions, "M" SKUs feature ball bearing suspensions. Both suspensions are full extension.

Notes

- 18" Recessed Modesty
- 36/42 has 30" D chassis
- 30/36 has 24" D chassis
- All units are standard w/ flush ends

Options

Accessories

- K28: Articulating Keyboard w/ Mouse - \$390
- K31: Center drawer - \$205

Drawer

- P6: Modify Box/Box/File to File/File - \$55 per pedestal
- P33: Wood Drawer Upgrade - \$45 per drawer
- WPD3061: Designer White - \$80 per pedestal

Grommets (Standard Location)

Specify Color and Left/Right - \$50 ea.

- Black: TM30-R (Right), TM30-L (Left)
- Silver: TM31-R (Right), TM31-L (Left)
- Antique Brass: TM33-R (Right), TM33-L (Left)

Grommets (Non-Standard Location)

Provide drawing w/ Grommet Location and Specify Color - \$95 ea.

- Black: TM30-NS
- Silver: TM31-NS
- Antique Brass: TM33-NS

Modesty

- M39: SilverLuma Frame w/ Frost insert (full modesty) - \$650
- HM39: SilverLuma Frame w/ Frost insert (half modesty) - \$340

2 Select Finish

[Click to view finishes](#)

WAC	WNW
WIC	WWP
WHC	WNF(Natural
WOC	Oak on Flat
WEC	Cut)
WAM	WSF(Salted
WCM	Oak on Flat
WEW	Cut)
WGW	WMF(Mocha
WBW	Oak on Flat
WSW	Cut)

TBCO
TBSW
TSTV
TSMV
TSLV
TOBW
WMO
WNO
WSO

GAC +10%
GIC GSLV
GHC +10%
GOC GWL
GEC
GAM
GCM
GEW
GNW
GSTV

MAC
MOC
MEC
MGW
MTW
MSW
MWL
MNA

3 Select Edge

[Click to view edges](#)

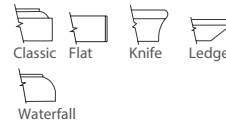
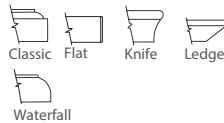

4 Select Hardware

[Click to view details](#)

[See Intro Page for Pull Options](#)

[See Intro Page for Pull Options](#)

[See Intro Page for Pull Options](#)

[See Intro Page for Pull Options](#)

Central Park

Double Breakfront / Single Pedestal Desks
Height Adjustable Single Full Pedestal

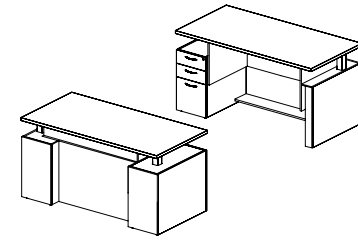

[Click here to view statement of line](#)

1 Select Model

w" x d" x h"	Weight
Left Pedestal	
72 x 36 x 29-47.5	275
72 x 30 x 29-47.5	265
66 x 36 x 29-47.5	265
66 x 30 x 29-47.5	225
Right Pedestal	
72 x 36 x 29-47.5	275
72 x 30 x 29-47.5	265
66 x 36 x 29-47.5	265
66 x 30 x 29-47.5	225

Standard Veneer Top Standard Veneer Chassis		Premium Veneer Top Premium Veneer Chassis		High Pressure Laminate Top Veneer Chassis		Thermally Fused Laminate Top Thermally Fused Laminate Chassis	
CPC7236DS742W	8314	CPC7236DS742P	9146	CPC7236DS742G	8314	CPC7236DS742M	6487
CPC7230DS742W	7999	CPC7230DS742P	8799	CPC7230DS742G	7999	CPC7230DS742M	6036
CPC6636DS742W	8135	CPC6636DS742P	8949	CPC6636DS742G	8135	CPC6636DS742M	6368
CPC6630DS742W	7825	CPC6630DS742P	8607	CPC6630DS742G	7825	CPC6630DS742M	5893
CPC7236DS743W	8314	CPC7236DS743P	9146	CPC7236DS743G	8314	CPC7236DS743M	6487
CPC7230DS743W	7999	CPC7230DS743P	8799	CPC7230DS743G	7999	CPC7230DS743M	6036
CPC6636DS743W	8135	CPC6636DS743P	8949	CPC6636DS743G	8135	CPC6636DS743M	6368
CPC6630DS743W	7825	CPC6630DS743P	8607	CPC6630DS743G	7825	CPC6630DS743M	5893

Product Features

- Adjustable height from 29" to 47.5" with a maximum weight capacity of 350 lbs.
- Box/Box/File
- "W" & "G" SKUs feature soft close suspensions, "M" SKUs feature ball bearing suspensions. Both suspensions are full extension.
- Lift available in MFS Silver (standard) or MFB Black (optional)
- Metal parts include 5 year warranty
- Privacy Surround Panels
- Programmable height adjustable mechanism, motor includes 2 year warranty

Notes

- 6" Recessed Modesty
- All units are standard w/ flush ends
- Hookup hardware

Options

Accessories

- K28: Articulating Keyboard w/ Mouse - \$390
- K31: Center drawer - \$205

Drawer

- P6: Modify Box/Box/File to File/File - \$55 per pedestal
- P33: Wood Drawer Upgrade - \$45 per drawer
- WPD3061: Designer White - \$80 per pedestal fronts

Grommets (Standard Location)

- Specify Color and Left/Right - \$50 ea.
- Black: TM30-R (Right), TM30-L (Left)
 - Silver: TM31-R (Right), TM31-L (Left)
 - Antique Brass: TM33-R (Right), TM33-L (Left)

Grommets (Non-Standard Location)

- Provide drawing w/ Grommet Location and Specify Color - \$95 ea.
- Black: TM30-NS
 - Silver: TM31-NS
 - Antique Brass: TM33-NS

Modesty

- M39: SilverLuma Frame w/ Frost insert (full modesty) - \$650

Wire Management

- LWMB: Lift wire management box with flip down door - \$365
- Power strip with five outlets and 12' cord, mesh wire cover, 6" deep black box

2 Select Finish

[Click to view finishes](#)

WAC	WNW
WIC	WWP
WHC	WNF(Natural
WOC	Oak on Flat
WEC	Cut)
WAM	WSF(Salted
WCM	Oak on Flat
WEW	Cut)
WGW	WMF(Mocha
WBW	Oak on Flat
WSW	Cut)

TBCO
TBSW
TSTV
TSMV
TSLV
TOBW
WMO
WNO
WSO

GAC +10%
GIC GSLV
GHC +10%
GOC GWL
GEC
GAM
GCM
GEW
GNW
GSTV

MAC
MOC
MEC
MGW
MTW
MSW
MWL
MNA

3 Select Edge

[Click to view edges](#)

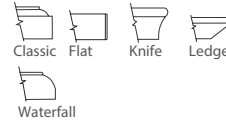
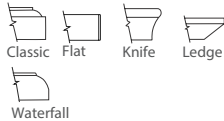

4 Select Hardware

[Click to view details](#)

[See Intro Page for Pull Options](#)

[See Intro Page for Pull Options](#)

[See Intro Page for Pull Options](#)

[See Intro Page for Pull Options](#)

Central Park

Flush Chassis Single Pedestal Desks W/ Overhang Top
Single Full Pedestal

[Click here to view statement of line](#)

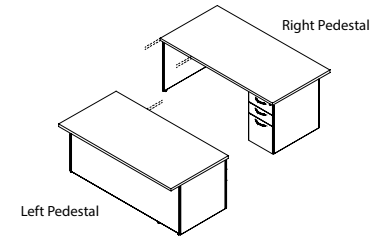

1 Select Model

w" x d" x h"
Left Pedestal
72 x 36 x 29
72 x 30 x 29
66 x 36 x 29
66 x 30 x 29
Right Pedestal
72 x 36 x 29
72 x 30 x 29
66 x 36 x 29
66 x 30 x 29

Weight	Standard Veneer Top Standard Veneer Chassis		Premium Veneer Top Premium Veneer Chassis		High Pressure Laminate Top Veneer Chassis		Thermally Fused Laminate Top Thermally Fused Laminate Chassis	
275	CPC7236DS640W	3716	CPC7236DS640P	4088	CPC7236DS640G	3716	CPC7236DS640M	2165
255	CPC7230DS640W	3675	CPC7230DS640P	4043	CPC7230DS640G	3675	CPC7230DS640M	2033
255	CPC6636DS640W	3656	CPC6636DS640P	4023	CPC6636DS640G	3656	CPC6636DS640M	2114
220	CPC6630DS640W	3593	CPC6630DS640P	3953	CPC6630DS640G	3593	CPC6630DS640M	1984
275	CPC7236DS639W	3716	CPC7236DS639P	4088	CPC7236DS639G	3409	CPC7236DS639M	2165
255	CPC7230DS639W	3675	CPC7230DS639P	4043	CPC7230DS639G	3675	CPC7230DS639M	1865
255	CPC6636DS639W	3656	CPC6636DS639P	4023	CPC6636DS639G	3656	CPC6636DS639M	2114
220	CPC6630DS639W	3593	CPC6630DS639P	3953	CPC6630DS639G	3593	CPC6630DS639M	1984

Product Features

- 6" Overhang
- All units are standard w/ flush ends
- Box/Box/File
- Hookup hardware
- "W" & "G" SKUs feature soft close suspensions, "M" SKUs feature ball bearing suspensions. Both suspensions are full extension.

Notes

- 30"D Has 24"D Chassis
- 36"D Has 30"D Chassis

Options

Accessories

- K28: Articulating Keyboard w/ Mouse - \$390
- K31: Center drawer - \$205

Drawer

- P6: Modify Box/Box/File to File/File - \$55 per pedestal
- P33: Wood Drawer Upgrade - \$45 per drawer
- WPD3061: Designer White - \$80 per pedestal

Grommets (Standard Location)

- Specify Color and Left/Right - \$50 ea.
- Black: TM30-R (Right), TM30-L (Left)
 - Silver: TM31-R (Right), TM31-L (Left)
 - Antique Brass: TM33-R (Right), TM33-L (Left)

Grommets (Non-Standard Location)

- Provide drawing w/ Grommet Location and Specify Color - \$95 ea.
- Black: TM30-NS
 - Silver: TM31-NS
 - Antique Brass: TM33-NS

Flush Top

- T6: Modify rectangle overhang top to flush top - N/C
- Unit will be 6" smaller when T6 flush top option is specified

2 Select Finish

[Click to view finishes](#)

WAC	WNW
WIC	WWP
WHC	WNF(Natural
WOC	Oak on Flat
WEC	Cut)
WAM	WSF(Salted
WCM	Oak on Flat
WEW	Cut)
WGW	WMF(Mocha
WBW	Oak on Flat
WSW	Cut)

TBCO
TBSW
TSTV
TSMV
TSLV
TOBW
WMO
WNO
WSO

GAC +10%
GIC GSLV
GHC +10%
GOC GWL
GEC
GAM
GCM
GEW
GNW
GSTV

MAC
MOC
MEC
MGW
MTW
MSW
MWL
MNA

3 Select Edge

[Click to view edges](#)

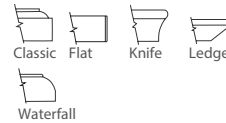
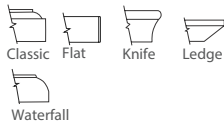

4 Select Hardware

[Click to view details](#)

See Intro Page
for Pull Options

See Intro Page
for Pull Options

See Intro Page
for Pull Options

See Intro Page
for Pull Options

Central Park

Flush Chassis Single Pedestal Desks W/ Overhang Top
Height Adjustable Single Full Pedestal

[Click here to view statement of line](#)

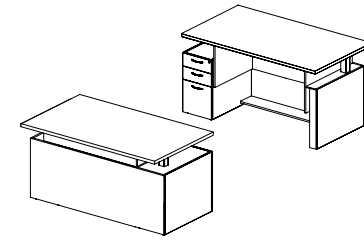

1 Select Model

w" x d" x h"	Weight
Left Pedestal	
72 x 36 x 29	275
72 x 30 x 29	255
66 x 36 x 29	255
66 x 30 x 29	220
Right Pedestal	
72 x 36 x 29	275
72 x 30 x 29	255
66 x 36 x 29	255
66 x 30 x 29	220

Standard Veneer Top Standard Veneer Chassis		Premium Veneer Top Premium Veneer Chassis		High Pressure Laminate Top Veneer Chassis		Thermally Fused Laminate Top Thermally Fused Laminate Chassis	
CPC7236DS642W	8342	CPC7236DS642P	9177	CPC7236DS642G	8342	CPC7236DS642M	6442
CPC7230DS642W	8013	CPC7230DS642P	8815	CPC7230DS642G	8013	CPC7230DS642M	5984
CPC6636DS642W	8156	CPC6636DS642P	8972	CPC6636DS642G	8156	CPC6636DS642M	6328
CPC6630DS642W	7833	CPC6630DS642P	8617	CPC6630DS642G	7833	CPC6630DS642M	5831
CPC7236DS641W	8342	CPC7236DS641P	9177	CPC7236DS641G	8342	CPC7236DS641M	6442
CPC7230DS641W	8013	CPC7230DS641P	8815	CPC7230DS641G	8013	CPC7230DS641M	5984
CPC6636DS641W	8156	CPC6636DS641P	8972	CPC6636DS641G	8156	CPC6636DS641M	6328
CPC6630DS641W	7833	CPC6630DS641P	8617	CPC6630DS641G	7833	CPC6630DS641M	5831

Product Features

- Box/Box/File
- Hookup hardware
- Lift available in MFS Silver (standard) or MFB Black (optional)
- Metal parts include 5 year warranty
- Privacy surround panels
- Programmable height adjustable mechanism, motor includes 2 year warranty
- "W" & "G" SKUs feature soft close suspensions, "M" SKUs feature ball bearing suspensions. Both suspensions are full extension.

Notes

- 30"D Has 24"D Chassis
- 36"D Has 30"D Chassis
- 6" Overhang
- All units are standard w/ flush ends

Options

Accessories

- K28: Articulating Keyboard w/ Mouse - \$390
- K31: Center drawer - \$205

Drawer

- P6: Modify Box/Box/File to File/File - \$55 per pedestal
- P33: Wood Drawer Upgrade - \$45 per drawer
- WPD3061: Designer White - \$80 per pedestal fronts

Grommets (Standard Location)

- Specify Color and Left/Right - \$50 ea.
- Black: TM30-R (Right), TM30-L (Left)
- Silver: TM31-R (Right), TM31-L (Left)
- Antique Brass: TM33-R (Right), TM33-L (Left)

Grommets (Non-Standard Location)

- Provide drawing w/ Grommet Location and Specify Color - \$95 ea.
- Black: TM30-NS
- Silver: TM31-NS
- Antique Brass: TM33-NS

Wire Management

- LWMB: Lift wire management box with flip down door - \$365
- Power strip with five outlets and 12' cord, mesh wire cover, 6" deep black box

2 Select Finish

[Click to view finishes](#)

WAC	WNW
WIC	WWP
WHC	WNF(Natural
WOC	Oak on Flat
WEC	Cut)
WAM	WSF(Salted
WCM	Oak on Flat
WEW	Cut)
WGW	WMF(Mocha
WBW	Oak on Flat
WSW	Cut)

TBCO
TBSW
TSTV
TSMV
TSLV
TOBW
WMO
WNO
WSO

GAC +10%
GIC GSLV
GHC +10%
GOC GWL
GEC
GAM
GCM
GEW
GNW
GSTV

MAC
MOC
MEC
MGW
MTW
MSW
MWL
MNA

3 Select Edge

[Click to view edges](#)

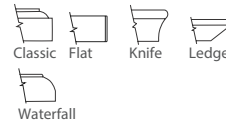
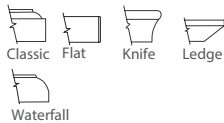

4 Select Hardware

[Click to view details](#)

[See Intro Page for Pull Options](#)

[See Intro Page for Pull Options](#)

[See Intro Page for Pull Options](#)

[See Intro Page for Pull Options](#)

Central Park

Flush Modesty Single Pedestal Desks
Bowfront Single Full Pedestal

[Click here to view statement of line](#)

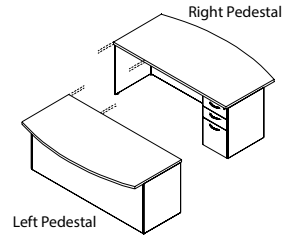

1 Select Model

w" x d" x h"	Weight
Left Pedestal	
72 x 36/42 x 29	295
72 x 30/36 x 29	295
66 x 30/36 x 29	270
Right Pedestal	
72 x 36/42 x 29	295
72 x 30/36 x 29	285
66 x 30/36 x 29	270

Standard Veneer Top Standard Veneer Chassis		Premium Veneer Top Premium Veneer Chassis		High Pressure Laminate Top Veneer Chassis		Thermally Fused Laminate Top Thermally Fused Laminate Chassis	
CPC7242DS749W	4577	CPC7242DS749P	5035	CPC7242DS749G	4577	CPC7242DS749M	2444
CPC7236DS749W	4512	CPC7236DS749P	4963	CPC7236DS749G	4512	CPC7236DS749M	2165
CPC6636DS749W	4444	CPC6636DS749P	4889	CPC6636DS749G	4444	CPC6636DS749M	2114
CPC7242DS748W	4577	CPC7242DS748P	5035	CPC7242DS748G	4577	CPC7242DS748M	2444
CPC7236DS748W	4512	CPC7236DS748P	4963	CPC7236DS748G	4512	CPC7236DS748M	2165
CPC6636DS748W	4444	CPC6636DS748P	4889	CPC6636DS748G	4444	CPC6636DS748M	2114

Product Features

- Box/Box/File
- Hookup hardware
- Lift available in MFS Silver (standard) or MFB Black (optional)
- Metal parts include 5 year warranty
- Privacy surround panels
- Programmable height adjustable mechanism, motor includes 2 year warranty
- "W" & "G" SKUs feature soft close suspensions, "M" SKUs feature ball bearing suspensions. Both suspensions are full extension.

Notes

- Modesty is recessed 12"
- All units are standard w/ flush ends
- 36/42 has 30" D chassis
- 30/36 has 24" D chassis

Options

Accessories

- K28: Articulating Keyboard w/ Mouse - \$390
- K31: Center drawer - \$205

Drawer

- P6: Modify Box/Box/File to File/File - \$55 per pedestal
- P33: Wood Drawer Upgrade - \$45 per drawer
- WPD3061: Designer White - \$80 per pedestal

Grommets (Standard Location)

- Specify Color and Left/Right - \$50 ea.
- Black: TM30-R (Right), TM30-L (Left)
- Silver: TM31-R (Right), TM31-L (Left)
- Antique Brass: TM33-R (Right), TM33-L (Left)

Grommets (Non-Standard Location)

- Provide drawing w/ Grommet Location and Specify Color - \$95 ea.
- Black: TM30-NS
- Silver: TM31-NS
- Antique Brass: TM33-NS

2 Select Finish

[Click to view finishes](#)

WAC	WNW	TBCO
WIC	WWP	TBSW
WHC	WNF(Natural	TSTV
WOC	Oak on Flat	TSMV
WEC	Cut)	TSLV
WAM	WSF(Salted	TOBW
WCM	Oak on Flat	WMO
WEW	Cut)	WNO
WGW	WMF(Mocha	WSO
WBW	Oak on Flat	
WSW	Cut)	

3 Select Edge

[Click to view edges](#)

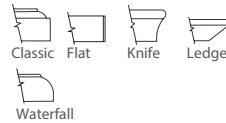
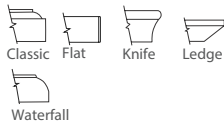

4 Select Hardware

[Click to view details](#)

See Intro Page
for Pull Options

See Intro Page
for Pull Options

See Intro Page
for Pull Options

See Intro Page
for Pull Options

Central Park

Non-Handed Desk Units
Flush Modesty Shell W/ Overhang Top

[Click here to view statement of line](#)

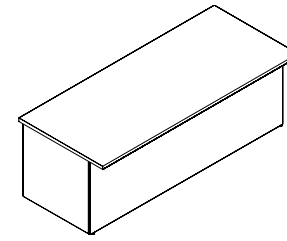

1 Select Model

w" x d" x h"	Weight
72 x 36 x 29	210
72 x 30 x 29	200
66 x 30 x 29	190

Standard Veneer Top Standard Veneer Chassis		Premium Veneer Top Premium Veneer Chassis		High Pressure Laminate Top Veneer Chassis		Thermally Fused Laminate Top Thermally Fused Laminate Chassis	
CPC7236DS896W	3502	CPC7236DS896P	3853	CPC7236DS896G	3502	CPC7236DS896M	1469
CPC7230DS896W	3208	CPC7230DS896P	3530	CPC7230DS896G	3208	CPC7230DS896M	1233
CPC6630DS896W	3152	CPC6630DS896P	3468	CPC6630DS896G	3152	CPC6630DS896M	1196

Product Features

- 6" Overhang
- Fully Assembled
- Metal to metal fasteners

Notes

- All Top Edge Hookups Are Shape To Shape Only
- BUDGET TIP: Modular shell and non-attached pedestals reduce installation cost 50%-60% vs. pan/pedestal components requiring extensive assembly. Reconfiguration cost difference is 70%-80% vs. assembled units.
- Order freestanding pedestals under shell

Options

Accessories

- K28: Articulating Keyboard w/ Mouse - \$390
- K31: Center drawer - \$205

Grommets (Standard Location)

Specify Color and Left/Right - \$50 ea.

- Black: TM30-R (Right), TM30-L (Left)
- Silver: TM31-R (Right), TM31-L (Left)
- Antique Brass: TM33-R (Right), TM33-L (Left)

Grommets (Non-Standard Location)

Provide drawing w/ Grommet Location and Specify Color - \$95 ea.

- Black: TM30-NS
- Silver: TM31-NS
- Antique Brass: TM33-NS

Flush Top

- T6: Modify rectangle overhang top to flush top - N/C
- Unit will be 6" smaller when T6 flush top option is specified

2 Select Finish

[Click to view finishes](#)

WAC	WNW	TBCO
WIC	WWP	TBSW
WHC	WNF(Natural	TSTV
WOC	Oak on Flat	TSMV
WEC	Cut)	TSLV
WAM	WSF(Salted	TOBW
WCM	Oak on Flat	WMO
WEW	Cut)	WNO
WGW	WMF(Mocha	WSO
WBW	Oak on Flat	
WSW	Cut)	

3 Select Edge

[Click to view edges](#)



4 Select Hardware

[Click to view details](#)

Hardware N/A	Hardware N/A	Hardware N/A	Hardware N/A
-----------------	-----------------	-----------------	-----------------

Central Park

Desk Shell
Height Adjustable Overhang

[Click here to view statement of line](#)

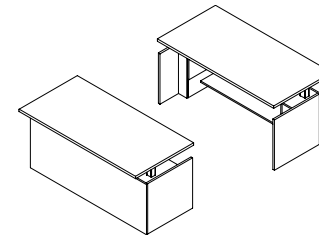

1 Select Model

w" x d" x h"	Weight
72 x 36 x 29-47.5	225
72 x 30 x 29-47.5	205
66 x 36 x 29-47.5	205
66 x 30 x 29-47.5	185

Standard Veneer Top Standard Veneer Chassis	Premium Veneer Top Premium Veneer Chassis	High Pressure Laminate Top Veneer Chassis	Thermally Fused Laminate Top Thermally Fused Laminate Chassis
CPC7236DS897W 7277	CPC7236DS897P 8005	CPC7236DS897G 7277	CPC7236DS897M 5810
CPC7230DS897W 7135	CPC7230DS897P 7848	CPC7230DS897G 7135	CPC7230DS897M 5498
CPC6636DS897W 7215	CPC6636DS897P 7937	CPC6636DS897G 7215	CPC6636DS897M 5752
CPC6630DS897W 7102	CPC6630DS897P 7813	CPC6630DS897G 7102	CPC6630DS897M 5504

Product Features

- Adjustable height from 29" to 47.5" with a maximum weight capacity of 350 lbs.
- Fully assembled
- Height adjustable shells are finished all sides - open plan
- Lift available in MFS Silver (standard) or MFB Black (optional)
- Metal parts include 5 year warranty
- Programmable height adjustable mechanism, motor includes 2 year warranty
- Order freestanding pedestals under shell

Notes

- Modesty surround lifts w/ work surface

Options

Accessories

- K28: Articulating Keyboard w/ Mouse - \$390
- K31: Center drawer - \$205

Grommets (Standard Location)

Specify Color and Left/Right - \$50 ea.

- Black: TM30-R (Right), TM30-L (Left)
- Silver: TM31-R (Right), TM31-L (Left)
- Antique Brass: TM33-R (Right), TM33-L (Left)

Grommets (Non-Standard Location)

Provide drawing w/ Grommet Location and Specify Color - \$95 ea.

- Black: TM30-NS
- Silver: TM31-NS
- Antique Brass: TM33-NS

Wire Management

- LWMB: Lift wire management box with flip down door - \$365
- Power strip with five outlets and 12' cord, mesh wire cover, 6" deep black box

2 Select Finish

[Click to view finishes](#)

WAC	WNW
WIC	WWP
WHC	WNF(Natural
WOC	Oak on Flat
WEC	Cut)
WAM	WSF(Salted
WCM	Oak on Flat
WEW	Cut)
WGW	WMF(Mocha
WBW	Oak on Flat
WSW	Cut)

TBCO
TBSW
TSTV
TSMV
TSLV
TOBW
WMO
WNO
WSO

GAC +10%
GIC GSLV
GHC +10%
GOC GWL
GEC
GAM
GCM
GEW
GNW
GSTV

MAC
MOC
MEC
MGW
MTW
MSW
MWL
MNA

3 Select Edge

[Click to view edges](#)

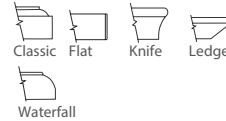
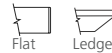
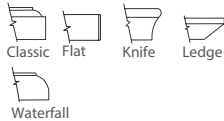

4 Select Hardware

[Click to view details](#)

Hardware
N/A

Hardware
N/A

Hardware
N/A

Hardware
N/A

Central Park

Height Adjustable Box/Box/File Pedestal With Bridge
 "L" Double Breakfont / Single Pedestal Desks With 42" Bridge

[Click here to view statement of line](#)

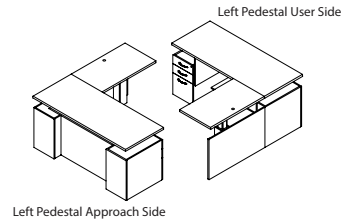

1 Select Model

w" x d" x h"	Weight
Left Pedestal	
84 x 36/78 x 29-47.5	415
72 x 30/72 x 29-47.5	355
66 x 30/72 x 29-47.5	335
Right Pedestal	
84 x 36/78 x 29-47.5	415
72 x 30/72 x 29-47.5	355
66 x 30/72 x 29-47.5	335

Standard Veneer Top Standard Veneer Chassis		Premium Veneer Top Premium Veneer Chassis		High Pressure Laminate Top Veneer Chassis		Thermally Fused Laminate Top Thermally Fused Laminate Chassis	
CPC8436DS739W	10572	CPC8436DS739P	11630	CPC8436DS739G	10572	CPC8436DS739M	8412
CPC7230DS739W	10048	CPC7230DS739P	11053	CPC7230DS739G	10048	CPC7230DS739M	7965
CPC6630DS739W	9964	CPC6630DS739P	10962	CPC6630DS739G	9964	CPC6630DS739M	7441
CPC8436DS738W	10572	CPC8436DS738P	11630	CPC8436DS738G	10572	CPC8436DS738M	8412
CPC7230DS738W	10048	CPC7230DS738P	11053	CPC7230DS738G	10048	CPC7230DS738M	7965
CPC6630DS738W	9964	CPC6630DS738P	10962	CPC6630DS738G	9964	CPC6630DS738M	7441

Product Features

- 1 Standard grommet - matches pull finish or specify black TM30, silver TM31 or antique brass TM33
- Adjustable height from 29" to 47.5" with a maximum weight capacity of 375 lbs.
- Box/Box/File
- Lift available in MFS Silver (standard) or MFB Black (optional)
- Metal parts include 5 year warranty
- Programmable height adjustable mechanism, motor includes 2 year warranty

Notes

- Modesty surround lifts w/ work surface

Options

Accessories

- K31: Center drawer - \$205

Bridge

- MOD48: Modify 42" bridge to 48" - \$75

Drawer

- P6: Modify Box/Box/File to File/File - \$55 per pedestal
- P33: Wood Drawer Upgrade - \$45 per drawer
- WPD3061: Designer White - \$80 per pedestal fronts

Grommets (Non-Standard Location)

Provide drawing w/ Grommet Location and Specify Color - \$95 ea.

- Black: TM30-NS
- Silver: TM31-NS
- Antique Brass: TM33-NS

Wire Management

- LWMB: Lift wire management box with flip down door - \$365
- Power strip with five outlets and 12' cord, mesh wire cover, 6" deep black box

2 Select Finish

[Click to view finishes](#)

WAC	WNW
WIC	WWP
WHC	WNF(Natural
WOC	Oak on Flat
WEC	Cut)
WAM	WSF(Salted
WCM	Oak on Flat
WEW	Cut)
WGW	WMF(Mocha
WBW	Oak on Flat
WSW	Cut)

TBCO
TBSW
TSTV
TSMV
TSLV
TOBW
WMO
WNO
WSO

GAC +10%
GIC GSLV
GHC +10%
GOC GWL
GEC
GAM
GCM
GEW
GNW
GSTV

MAC
MOC
MEC
MGW
MTW
MSW
MWL
MNA

3 Select Edge

[Click to view edges](#)

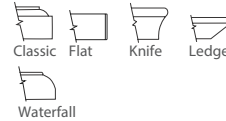
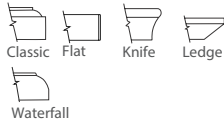

4 Select Hardware

[Click to view details](#)

[See Intro Page for Pull Options](#)

[See Intro Page for Pull Options](#)

[See Intro Page for Pull Options](#)

[See Intro Page for Pull Options](#)

Central Park

Height Adjustable Box/Box/File Pedestal With Bridge
 "L" Flush Front / Single Pedestal Desks With 42" Bridge

[Click here to view statement of line](#)

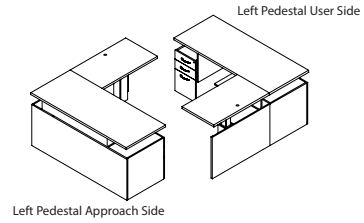

1 Select Model

w" x d" x h"	Weight
Left Pedestal	
84 x 36/78 x 29-47.5	415
72 x 30/72 x 29-47.5	355
66 x 30/72 x 29-47.5	335
Right Pedestal	
84 x 36/78 x 29-47.5	415
72 x 30/72 x 29-47.5	355
66 x 30/72 x 29-47.5	335

Standard Veneer Top Standard Veneer Chassis		Premium Veneer Top Premium Veneer Chassis		High Pressure Laminate Top Veneer Chassis		Thermally Fused Laminate Top Thermally Fused Laminate Chassis	
CPC8436DS644W	10703	CPC8436DS644P	11774	CPC8436DS644G	10703	CPC8436DS644M	8439
CPC7230DS644W	10139	CPC7230DS644P	11153	CPC7230DS644G	10139	CPC7230DS644M	7978
CPC6630DS644W	10050	CPC6630DS644P	11055	CPC6630DS644G	10050	CPC6630DS644M	7435
CPC8436DS643W	10703	CPC8436DS643P	11774	CPC8436DS643G	10703	CPC8436DS643M	8439
CPC7230DS643W	10139	CPC7230DS643P	11153	CPC7230DS643G	10139	CPC7230DS643M	7978
CPC6630DS643W	10050	CPC6630DS643P	11055	CPC6630DS643G	10050	CPC6630DS643M	7435

Product Features

- 1 Standard grommet - matches pull finish or specify black TM30, silver TM31 or antique brass TM33
- Adjustable height from 29" to 47.5" with a maximum weight capacity of 375 lbs.
- Box/Box/File
- Lift available in MFS Silver (standard) or MFB Black (optional)
- Metal parts include 5 year warranty
- Programmable height adjustable mechanism, motor includes 2 year warranty

Notes

- Modesty surround lifts w/ work surface

Options

Accessories

- K31: Center drawer - \$205

Bridge

- MOD48: Modify 42" bridge to 48" - \$75

Drawer

- P6: Modify Box/Box/File to File/File - \$55 per pedestal
- P33: Wood Drawer Upgrade - \$45 per drawer
- WPD3061: Designer White - \$80 per pedestal fronts

Grommets (Non-Standard Location)

Provide drawing w/ Grommet Location and Specify Color - \$95 ea.

- Black: TM30-NS
- Silver: TM31-NS
- Antique Brass: TM33-NS

Wire Management

- LWMB: Lift wire management box with flip down door - \$365
- Power strip with five outlets and 12' cord, mesh wire cover, 6" deep black box

2 Select Finish

[Click to view finishes](#)

WAC	WNW
WIC	WWP
WHC	WNF(Natural
WOC	Oak on Flat
WEC	Cut)
WAM	WSF(Salted
WCM	Oak on Flat
WEW	Cut)
WGW	WMF(Mocha
WBW	Oak on Flat
WSW	Cut)

TBCO
TBSW
TSTV
TSMV
TSLV
TOBW
WMO
WNO
WSO

GAC +10%
GIC GSLV
GHC +10%
GOC GWL
GEC
GAM
GCM
GEW
GNW
GSTV

MAC
MOC
MEC
MGW
MTW
MSW
MWL
MNA

3 Select Edge

[Click to view edges](#)

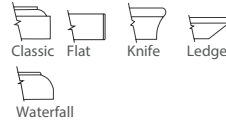
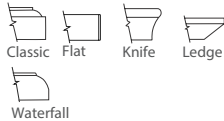

4 Select Hardware

[Click to view details](#)

[See Intro Page for Pull Options](#)

[See Intro Page for Pull Options](#)

[See Intro Page for Pull Options](#)

[See Intro Page for Pull Options](#)

Central Park

Double Breakfront Height Adjustable Box / Box / File Pedestal Desk
42" Return Shell

[Click here to view statement of line](#)

Left Pedestal User Side

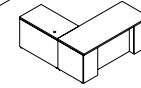
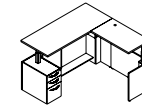

Left Pedestal Approach Side

1 Select Model

w" x d" x h"

Weight	84 x 36/78 x 29-47.5	72 x 30/72 x 29-47.5	66 x 30/72 x 29-47.5
Left Pedestal	420	360	340
Right Pedestal	420	360	340

Standard Veneer Top Standard Veneer Chassis		Premium Veneer Top Premium Veneer Chassis		High Pressure Laminate Top Veneer Chassis		Thermally Fused Laminate Top Thermally Fused Laminate Chassis	
CPC8436DS789W	10827	CPC8436DS789P	11911	CPC8436DS789G	10827	CPC8436DS789M	8602
CPC7230DS789W	10302	CPC7230DS789P	11333	CPC7230DS789G	10302	CPC7230DS789M	8155
CPC6630DS789W	10218	CPC6630DS789P	11241	CPC6630DS789G	10218	CPC6630DS789M	7633
CPC8436DS788W	10827	CPC8436DS788P	11911	CPC8436DS788G	10827	CPC8436DS788M	8602
CPC7230DS788W	10302	CPC7230DS788P	11333	CPC7230DS788G	10302	CPC7230DS788M	8155
CPC6630DS788W	10218	CPC6630DS788P	11241	CPC6630DS788G	10218	CPC6630DS788M	7633

Product Features

- 1 Standard grommet - matches pull finish or specify black TM30, silver TM31 or antique brass TM33
- Adjustable height from 29" to 47.5" with a maximum weight capacity of 375 lbs.
- Box/Box/File
- Lift available in MFS Silver (standard) or MFB Black (optional)
- Metal parts include 5 year warranty
- Programmable height adjustable mechanism, motor includes 2 year warranty

Notes

- Modesty surround lifts w/ work surface

Options

Accessories

- K31: Center drawer - \$205

Return

- MOD48: Modify 42" return to 48" - \$75

Drawer

- P6: Modify Box/Box/File to File/File - \$55 per pedestal
- P33: Wood Drawer Upgrade - \$45 per drawer
- WPD3061: Designer White - \$80 per pedestal fronts

Grommets (Non-Standard Location)

Provide drawing w/ Grommet Location and Specify Color - \$95 ea.

- Black: TM30-NS
- Silver: TM31-NS
- Antique Brass: TM33-NS

Wire Management

- LWMB: Lift wire management box with flip down door - \$365
- Power strip with five outlets and 12' cord, mesh wire cover, 6" deep black box

2 Select Finish

[Click to view finishes](#)

WAC	WNW
WIC	WWP
WHC	WNF(Natural
WOC	Oak on Flat
WEC	Cut)
WAM	WSF(Salted
WCM	Oak on Flat
WEW	Cut)
WGW	WMF(Mocha
WBW	Oak on Flat
WSW	Cut)

TBCO
TBSW
TSTV
TSMV
TSLV
TOBW
WMO
WNO
WSO

GAC +10%
GIC GSLV
GHC +10%
GOC GWL
GEC
GAM
GCM
GEW
GNW
GSTV

MAC
MOC
MEC
MGW
MTW
MSW
MWL
MNA

3 Select Edge

[Click to view edges](#)

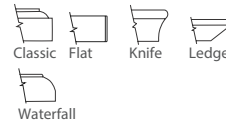
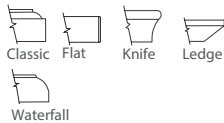

4 Select Hardware

[Click to view details](#)

See Intro Page
for Pull Options

See Intro Page
for Pull Options

See Intro Page
for Pull Options

See Intro Page
for Pull Options

Central Park

Double Breakfront Height Adjustable Box / Box / File Pedestal Desk
42" File / File Pedestal Return

[Click here to view statement of line](#)

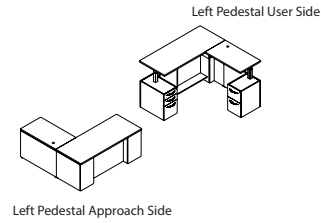

1 Select Model

w" x d" x h"	Weight
Left Desk Pedestal	
84 x 36/78 x 29-47.5	480
72 x 30/72 x 29-47.5	420
66 x 30/72 x 29-47.5	400
Right Desk Pedestal	
84 x 36/78 x 29-47.5	480
72 x 30/72 x 29-47.5	420
66 x 30/72 x 29-47.5	400

Standard Veneer Top Standard Veneer Chassis		Premium Veneer Top Premium Veneer Chassis		High Pressure Laminate Top Veneer Chassis		Thermally Fused Laminate Top Thermally Fused Laminate Chassis	
CPC8436DS791W	11686	CPC8436DS791P	12856	CPC8436DS791G	11686	CPC8436DS791M	9287
CPC7230DS791W	11161	CPC7230DS791P	12277	CPC7230DS791G	11161	CPC7230DS791M	8840
CPC6630DS791W	11078	CPC6630DS791P	12187	CPC6630DS791G	11078	CPC6630DS791M	8315
CPC8436DS790W	11686	CPC8436DS790P	12856	CPC8436DS790G	11686	CPC8436DS790M	9287
CPC7230DS790W	11161	CPC7230DS790P	12277	CPC7230DS790G	11161	CPC7230DS790M	8840
CPC6630DS790W	11078	CPC6630DS790P	12187	CPC6630DS790G	11078	CPC6630DS790M	8315

Product Features

- 1 Standard grommet - matches pull finish or specify black TM30, silver TM31 or antique brass TM33
- Adjustable height from 29" to 47.5" with a maximum weight capacity of 375 lbs.
- Box/Box/File
- Lift available in MFS Silver (standard) or MFB Black (optional)
- Metal parts include 5 year warranty
- Programmable height adjustable mechanism, motor includes 2 year warranty

Notes

- Modesty surround lifts w/ work surface

Options

Accessories

- K31: Center drawer - \$205

Return

- MOD48: Modify 42" return to 48" - \$75

Drawer

- P6: Modify Box/Box/File to File/File - \$55 per pedestal
- P33: Wood Drawer Upgrade - \$45 per drawer
- WPD3061: Designer White - \$80 per pedestal fronts

Grommets (Non-Standard Location)

Provide drawing w/ Grommet Location and Specify Color - \$95 ea.

- Black: TM30-NS
- Silver: TM31-NS
- Antique Brass: TM33-NS

Wire Management

- LWMB: Lift wire management box with flip down door - \$365
- Power strip with five outlets and 12' cord, mesh wire cover, 6" deep black box

2 Select Finish

[Click to view finishes](#)

WAC	WNW
WIC	WWP
WHC	WNF(Natural
WOC	Oak on Flat
WEC	Cut)
WAM	WSF(Salted
WCM	Oak on Flat
WEW	Cut)
WGW	WMF(Mocha
WBW	Oak on Flat
WSW	Cut)

TBCO
TBSW
TSTV
TSMV
TSLV
TOBW
WMO
WNO
WSO

GAC +10%
GIC GSLV
GHC +10%
GOC GWL
GEC
GAM
GCM
GEW
GNW
GSTV

MAC
MOC
MEC
MGW
MTW
MSW
MWL
MNA

3 Select Edge

[Click to view edges](#)

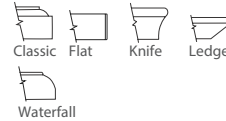
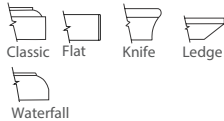

4 Select Hardware

[Click to view details](#)

[See Intro Page for Pull Options](#)

[See Intro Page for Pull Options](#)

[See Intro Page for Pull Options](#)

[See Intro Page for Pull Options](#)

Central Park

Flush Chassis Height Adjustable Box / Box / File Pedestal Desk
42" Return Shell

[Click here to view statement of line](#)

Left Pedestal User Side

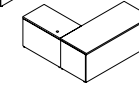
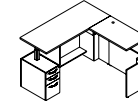

Left Pedestal Approach Side

1 Select Model

w" x d" x h"	Weight
84 X 36 x 29	420
72 x 30 x 29	360
66 x 30 x 29	340
Right Pedestal	
84 x 36 x 29	420
72 x 30 x 29	360
66 x 30 x 29	340

Standard Veneer Top Standard Veneer Chassis		Premium Veneer Top Premium Veneer Chassis		High Pressure Laminate Top Veneer Chassis		Thermally Fused Laminate Top Thermally Fused Laminate Chassis	
CPC8436DS646W	10957	CPC8436DS646P	12054	CPC8436DS646G	10957	CPC8436DS646M	8616
CPC7230DS646W	10394	CPC7230DS646P	11434	CPC7230DS646G	10394	CPC7230DS646M	8169
CPC6630DS646W	10304	CPC6630DS646P	11335	CPC6630DS646G	10304	CPC6630DS646M	7625
CPC8436DS645W	10957	CPC8436DS645P	12054	CPC8436DS645G	10957	CPC8436DS645M	8616
CPC7230DS645W	10394	CPC7230DS645P	11434	CPC7230DS645G	10394	CPC7230DS645M	8169
CPC6630DS645W	10304	CPC6630DS645P	11335	CPC6630DS645G	10304	CPC6630DS645M	7625

Product Features

- 1 Standard grommet - matches pull finish or specify black TM30, silver TM31 or antique brass TM33
- Adjustable height from 29" to 47.5" with a maximum weight capacity of 375 lbs.
- Box/Box/File
- Lift available in MFS Silver (standard) or MFB Black (optional)
- Metal parts include 5 year warranty
- Programmable height adjustable mechanism, motor includes 2 year warranty

Notes

- Modesty surround lifts w/ work surface

Options

Accessories

- K31: Center drawer - \$205

Return

- MOD48: Modify 42" return to 48" - \$75

Drawer

- P6: Modify Box/Box/File to File/File - \$55 per pedestal
- P33: Wood Drawer Upgrade - \$45 per drawer
- WPD3061: Designer White - \$80 per pedestal fronts

Grommets (Non-Standard Location)

Provide drawing w/ Grommet Location and Specify Color - \$95 ea.

- Black: TM30-NS
- Silver: TM31-NS
- Antique Brass: TM33-NS

Wire Management

- LWMB: Lift wire management box with flip down door - \$365
- Power strip with five outlets and 12' cord, mesh wire cover, 6" deep black box

2 Select Finish

[Click to view finishes](#)

WAC	WNW
WIC	WWP
WHC	WNF(Natural
WOC	Oak on Flat
WEC	Cut)
WAM	WSF(Salted
WCM	Oak on Flat
WEW	Cut)
WGW	WMF(Mocha
WBW	Oak on Flat
WSW	Cut)

TBCO
TBSW
TSTV
TSMV
TSLV
TOBW
WMO
WNO
WSO

GAC +10%
GIC GSLV
GHC +10%
GOC GWL
GEC
GAM
GCM
GEW
GNW
GSTV

MAC
MOC
MEC
MGW
MTW
MSW
MWL
MNA

3 Select Edge

[Click to view edges](#)

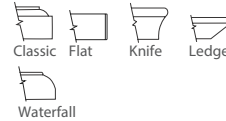
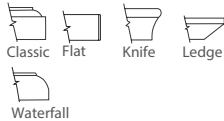

4 Select Hardware

[Click to view details](#)

[See Intro Page for Pull Options](#)

[See Intro Page for Pull Options](#)

[See Intro Page for Pull Options](#)

[See Intro Page for Pull Options](#)

Central Park

Height Adjustable Desk Shell
42" Return Shell

[Click here to view statement of line](#)

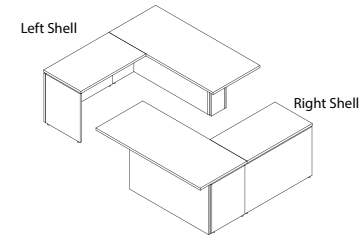

1 Select Model

w" x d" x h"	Weight
Left Return Shell	
84 x 30/72 x 29-47.5	360
72 x 30/72 x 29-47.5	310
66 x 30/72 x 29-47.5	290
Right Return Shell	
84 x 30/72 x 29-47.5	360
72 x 30/72 x 29-47.5	310
66 x 30/72 x 29-47.5	290

Standard Veneer Top Standard Veneer Chassis		Premium Veneer Top Premium Veneer Chassis		High Pressure Laminate Top Veneer Chassis		Thermally Fused Laminate Top Thermally Fused Laminate Chassis	
CPC8430DS649W	8966	CPC8430DS649P	9863	CPC8430DS649G	8966	CPC8430DS649M	6742
CPC7230DS649W	8688	CPC7230DS649P	9557	CPC7230DS649G	8688	CPC7230DS649M	6524
CPC6630DS649W	8546	CPC6630DS649P	9401	CPC6630DS649G	8546	CPC6630DS649M	6421
CPC8430DS650W	8966	CPC8430DS650P	9863	CPC8430DS650G	8966	CPC8430DS650M	6742
CPC7230DS650W	8688	CPC7230DS650P	9557	CPC7230DS650G	8688	CPC7230DS650M	6524
CPC6630DS650W	8546	CPC6630DS650P	9401	CPC6630DS650G	8546	CPC6630DS650M	6421

Product Features

- Wire Management chassis with drop door access.
- Adjustable height from 29" to 47.5" with a maximum weight capacity of 375 lbs.
- Metal parts include 5 year warranty
- Programmable height adjustable mechanism, motor includes 2 year warranty
- Conference overhangs on the approach end side

Notes

- Metal Column with grommet for wire management on desk.

Options

Accessories

- K31: Center drawer - \$205

Return

- MOD48: Modify 42" return to 48" - \$75

Grommets (Standard Location)

Specify Color and Left/Right - \$50 ea.

- Black: TM30-R (Right), TM30-L (Left)
- Silver: TM31-R (Right), TM31-L (Left)
- Antique Brass: TM33-R (Right), TM33-L (Left)

Grommets (Non-Standard Location)

Provide drawing w/ Grommet Location and Specify Color - \$95 ea.

- Black: TM30-NS
- Silver: TM31-NS
- Antique Brass: TM33-NS

2 Select Finish

[Click to view finishes](#)

WAC	WNW
WIC	WWP
WHC	WNF(Natural
WOC	Oak on Flat
WEC	Cut)
WAM	WSF(Salted
WCM	Oak on Flat
WEW	Cut)
WGW	WMF(Mocha
WBW	Oak on Flat
WSW	Cut)

TBCO
TBSW
TSTV
TSMV
TSLV
TOBW
WMO
WNO
WSO

GAC +10%
GIC GSLV
GHC +10%
GOC GWL
GEC
GAM
GCM
GEW
GNW
GSTV

MAC
MOC
MEC
MGW
MTW
MSW
MWL
MNA

3 Select Edge

[Click to view edges](#)

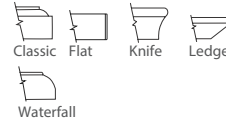
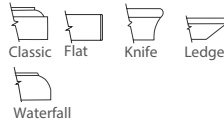

4 Select Hardware

[Click to view details](#)

Hardware
N/A

Hardware
N/A

Hardware
N/A

Hardware
N/A

Central Park

Flush Chassis Height Adjustable Box / Box / File Pedestal Desk
42" File / File Pedestal Return

[Click here to view statement of line](#)

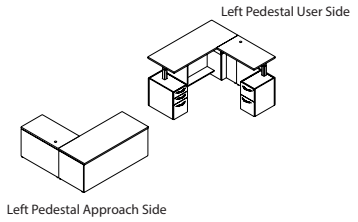

1 Select Model

w" x d" x h"	Weight
Left Desk Pedestal	
84 x 36/78 x 29-47.5	480
72 x 30/72 x 29-47.5	420
66 x 30/72 x 29-47.5	400
Right Desk Pedestal	
84 x 36/78 x 29-47.5	480
72 x 30/72 x 29-47.5	420
66 x 30/72 x 29-47.5	400

Standard Veneer Top Standard Veneer Chassis		Premium Veneer Top Premium Veneer Chassis		High Pressure Laminate Top Veneer Chassis		Thermally Fused Laminate Top Thermally Fused Laminate Chassis	
CPC8436DS648W	11817	CPC8436DS648P	13000	CPC8436DS648G	11817	CPC8436DS648M	9316
CPC7230DS648W	11253	CPC7230DS648P	12379	CPC7230DS648G	11253	CPC7230DS648M	8852
CPC6630DS648W	11163	CPC6630DS648P	12280	CPC6630DS648G	11163	CPC6630DS648M	8310
CPC8436DS647W	11817	CPC8436DS647P	13000	CPC8436DS647G	11817	CPC8436DS647M	9316
CPC7230DS647W	11253	CPC7230DS647P	12379	CPC7230DS647G	11253	CPC7230DS647M	8852
CPC6630DS647W	11163	CPC6630DS647P	12280	CPC6630DS647G	11163	CPC6630DS647M	8310

Product Features

- 1 Standard grommet - matches pull finish or specify black TM30, silver TM31 or antique brass TM33
- Adjustable height from 29" to 47.5" with a maximum weight capacity of 375 lbs.
- Box/Box/File
- Lift available in MFS Silver (standard) or MFB Black (optional)
- Metal parts include 5 year warranty
- Programmable height adjustable mechanism, motor includes 2 year warranty

Notes

- Modesty surround lifts w/ work surface

Options

Accessories

- K31: Center drawer - \$205

Return

- MOD48: Modify 42" return to 48" - \$75

Drawer

- P6: Modify Box/Box/File to File/File - \$55 per pedestal
- P33: Wood Drawer Upgrade - \$45 per drawer
- WPD3061: Designer White - \$80 per pedestal fronts

Grommets (Non-Standard Location)

Provide drawing w/ Grommet Location and Specify Color - \$95 ea.

- Black: TM30-NS
- Silver: TM31-NS
- Antique Brass: TM33-NS

Wire Management

- LWMB: Lift wire management box with flip down door - \$365
- Power strip with five outlets and 12' cord, mesh wire cover, 6" deep black box

2 Select Finish

[Click to view finishes](#)

WAC	WNW
WIC	WWP
WHC	WNF(Natural
WOC	Oak on Flat
WEC	Cut)
WAM	WSF(Salted
WCM	Oak on Flat
WEW	Cut)
WGW	WMF(Mocha
WBW	Oak on Flat
WSW	Cut)

TBCO
TBSW
TSTV
TSMV
TSLV
TOBW
WMO
WNO
WSO

GAC +10%
GIC GSLV
GHC +10%
GOC GWL
GEC
GAM
GCM
GEW
GNW
GSTV

MAC
MOC
MEC
MGW
MTW
MSW
MWL
MNA

3 Select Edge

[Click to view edges](#)

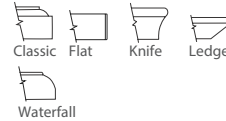
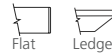
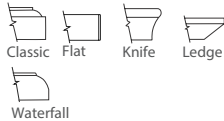

4 Select Hardware

[Click to view details](#)

[See Intro Page for Pull Options](#)

[See Intro Page for Pull Options](#)

[See Intro Page for Pull Options](#)

[See Intro Page for Pull Options](#)

Central Park

Height Adjustable Work Wall Desk
Work Wall Shell

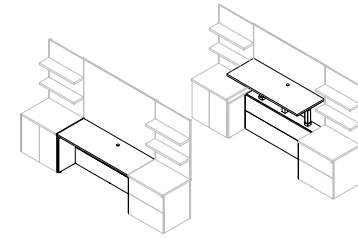

[Click here to view statement of line](#)

1 Select Model

w" x d" x h"	Weight
42 x 24 x 29	100
48 x 24 x 29	110
60 x 24 x 29	130
72 x 24 x 29	150

Standard Veneer Top Standard Veneer Chassis		Premium Veneer Top Premium Veneer Chassis		High Pressure Laminate Top Veneer Chassis		Thermally Fused Laminate Top Thermally Fused Laminate Chassis	
CPC4224DS005W	5092	CPC4224DS005P	5602	CPC4224DS005G	5092	CPC4224DS005M	4074
CPC4824DS005W	5347	CPC4824DS005P	5882	CPC4824DS005G	5347	CPC4824DS005M	4277
CPC6024DS005W	5602	CPC6024DS005P	6162	CPC6024DS005G	5602	CPC6024DS005M	4481
CPC7224DS005W	5856	CPC7224DS005P	6442	CPC7224DS005G	5856	CPC7224DS005M	5371

Product Features

- Metal column with grommet for wire management
- Full depth end panels, wall attachment not required
- 1 Standard grommet - matches pull finish or specify black TM30, silver TM31 or antique brass TM33
- Adjustable height from 29" to 47.5" with a maximum weight capacity of 350 lbs.
- Lift available in MFS Silver (standard) or MFB Black (optional)
- Metal parts include 5 year warranty
- Programmable height adjustable mechanism, motor includes 2 year warranty

Notes

- Top is 1/2" shorter each side, 1-1/2" short in depth.
- 58"- 70" work wall shell comes with double modesty doors.

Options

Modify For 90 Degree Bench Application

- MODB-R Modify Height Adjustable Desk Shell for Right Side 90 degree bench- \$125
- MODB-L Modify Height Adjustable Desk Shell for Left Side 90 degree bench- \$125

2 Select Finish

[Click to view finishes](#)

WAC	WNW
WIC	WWP
WHC	WNF(Natural
WOC	Oak on Flat
WEC	Cut)
WAM	WSF(Salted
WCM	Oak on Flat
WEW	Cut)
WGW	WMF(Mocha
WBW	Oak on Flat
WSW	Cut)

TBCO
TBSW
TSTV
TSMV
TSLV
TOBW
WMO
WNO
WSO

GAC +10%
GIC GSLV
GHC +10%
GOC GWL
GEC
GAM
GCM
GEW
GNW
GSTV

MAC
MOC
MEC
MGW
MTW
MSW
MWL
MNA

3 Select Edge

[Click to view edges](#)

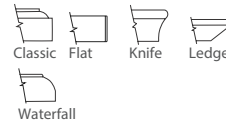
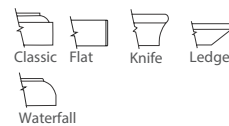
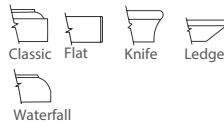

4 Select Hardware

[Click to view details](#)

Hardware
N/A

Hardware
N/A

Hardware
N/A

Hardware
N/A

Central Park

Height Adjustable Work Wall Shell

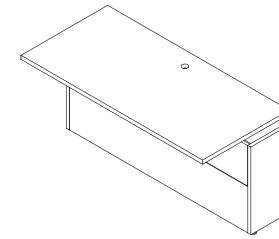

[Click here to view statement of line](#)

1 Select Model

w" x d" x h"	Weight
47 x 30 x 29	170
58 x 30 x 29	190
70 x 30 x 29	210

Standard Veneer Top Standard Veneer Chassis		Premium Veneer Top Premium Veneer Chassis		High Pressure Laminate Top Veneer Chassis		Thermally Fused Laminate Top Thermally Fused Laminate Chassis	
CPC4730DS003W	5434	CPC4730DS003P	5978	CPC4730DS003G	5434	CPC4730DS003M	4327
CPC5830DS003W	5711	CPC5830DS003P	6282	CPC5830DS003G	5711	CPC5830DS003M	4544
CPC7030DS003W	5987	CPC7030DS003P	6586	CPC7030DS005G	5987	CPC7030DS003M	4759

2 Select Finish

[Click to view finishes](#)

WAC	WNW
WIC	WWP
WHC	WNF(Natural
WOC	Oak on Flat
WEC	Cut)
WAM	WSF(Salted
WCM	Oak on Flat
WEW	Cut)
WGW	WMF(Mocha
WBW	Oak on Flat
WSW	Cut)

3 Select Edge

[Click to view edges](#)

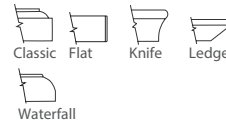
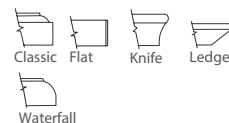
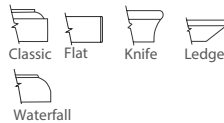

4 Select Hardware

[Click to view details](#)

Hardware
N/A

Hardware
N/A

Hardware
N/A

Hardware
N/A

Product Features

- Metal column with grommet for wire management
- Unit mounts to wall.
- 1 Standard grommet - matches pull finish or specify black TM30, silver TM31 or antique brass TM33
- Adjustable height from 29" to 47.5" with a maximum weight capacity of 350 lbs.
- Lift available in MFS Silver (standard) or MFB Black (optional)
- Metal parts include 5 year warranty
- Programmable height adjustable mechanism, motor includes 2 year warranty

Notes

- Top is 1/2" shorter each side, 1-1/2" short in depth.
- 58"- 70" work wall shell comes with double modesty doors.
- 8" deep wire management full width box with drop door wall access.

Options

Modify For 90 Degree Bench Application

- MODB-R Modify Height Adjustable Desk Shell for Right Side 90 degree bench- \$125
- MODB-L Modify Height Adjustable Desk Shell for Left Side 90 degree bench- \$125

Grommets (Standard Location)

- Specify Color and Left/Right - \$50 ea.
- Black: TM30-R (Right), TM30-L (Left)
 - Silver: TM31-R (Right), TM31-L (Left)
 - Antique Brass: TM33-R (Right), TM33-L (Left)

Grommets (Non-Standard Location)

- Provide drawing w/ Grommet Location and Specify Color - \$95 ea.
- Black: TM30-NS
 - Silver: TM31-NS
 - Antique Brass: TM33-NS

Central Park

Height Adjustable Table Desk Table Desks

[Click here to view statement of line](#)

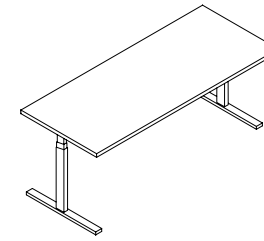

1 Select Model

w" x d" x h"	Weight
72 x 36 x 1.125	245
72 x 30 x 1.125	230
66 x 30 x 1.125	215
60 x 30 x 1.125	200

Standard Veneer Top Standard Veneer Chassis		Premium Veneer Top Premium Veneer Chassis		High Pressure Laminate Top Veneer Chassis		Thermally Fused Laminate Top Thermally Fused Laminate Chassis	
CPC7236DT090W	3800	CPC7236DT090P	4181	CPC7236DT090G	3800	CPC7236DT090M	3305
CPC7230DT090W	3726	CPC7230DT090P	4099	CPC7230DT090G	3726	CPC7230DT090M	3266
CPC6630DT090W	3704	CPC6630DT090P	4075	CPC6630DT090G	3704	CPC6630DT090M	3251
CPC6030DT090W	3686	CPC6030DT090P	4055	CPC6030DT090G	3686	CPC6030DT090M	3160

Product Features

- Adjustable height from 29" to 47.5" with a maximum weight capacity of 220 lbs.
- Lift available in MFS Silver (standard) or MFB Black (optional)
- Metal parts include 5 year warranty
- Programmable height adjustable mechanism, motor includes 2 year warranty

2 Select Finish

[Click to view finishes](#)

WAC	WNW
WIC	WWP
WHC	WNF(Natural
WOC	Oak on Flat
WEC	Cut)
WAM	WSF(Salted
WCM	Oak on Flat
WEW	Cut)
WGW	WMF(Mocha
WBW	Oak on Flat
WSW	Cut)

TBCO
TBSW
TSTV
TSMV
TSLV
TOBW
WMO
WNO
WSO

GAC +10%
GIC GSLV
GHC +10%
GOC GWL
GEC
GAM
GCM
GEW
GNW
GSTV

MAC
MOC
MEC
MGW
MTW
MSW
MWL
MNA

3 Select Edge

[Click to view edges](#)

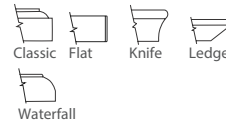
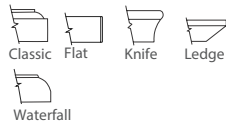

4 Select Hardware

[Click to view details](#)

Hardware
N/A

Hardware
N/A

Hardware
N/A

Hardware
N/A

Options

Grommets (Standard Location)

Specify Color and Location (Right/Left/Center) - \$50 ea.

- Black: TM30-R (Right), TM30-L (Left), TM30-C (Center)
- Silver: TM31-R (Right), TM31-L (Left), TM31-C (Center)
- White: TM34-R (Right), TM34-L (Left), TM34-C (Center)

Grommets (Non-Standard Location)

Provide drawing w/ Grommet Location and Specify Color - \$95 ea.

- Black: TM30-NS
- Silver: TM31-NS
- White: TM34-NS

Exposed Plywood Edge

- WEPB: Exposed Plywood Edge w/ Baltic Birch Veneer - n/c
- Only available with WCF - Clear Coat Finish

Modesty

- HM3: Veneer Half Modesty - \$260 (For "W" and "G")
- HM3M: Melamine Half Modesty - \$205 (For "M")

Central Park

Height Adjustable Bridges
Open Back

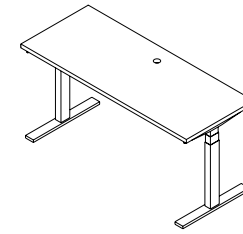

[Click here to view statement of line](#)

1 Select Model

w" x d" x h"	Weight
60 x 24 x 29	105
54 x 24 x 29	100
48 x 24 x 29	95
42 x 24 x 29	90

Standard Veneer Top Standard Veneer Chassis		Premium Veneer Top Premium Veneer Chassis		High Pressure Laminate Top Veneer Chassis		Thermally Fused Laminate Top Thermally Fused Laminate Chassis																																																																																																	
CPC6024LB151W	3459	CPC6024LB151P	3806	CPC6024LB151G	3459	CPC6024LB151M	3100																																																																																																
CPC5424LB151W	3327	CPC5424LB151P	3661	CPC5424LB151G	3327	CPC5424LB151M	3074																																																																																																
CPC4824LB151W	3206	CPC4824LB151P	3528	CPC4824LB151G	3206	CPC4824LB151M	3047																																																																																																
CPC4224LB151W	3161	CPC4224LB151P	3478	CPC4224LB151G	3161	CPC4224LB151M	3019																																																																																																
<p>2 Select Finish Click to view finishes</p> <table border="0"> <tr> <td>WAC</td> <td>WNW</td> <td>TBCO</td> <td>GAC</td> <td>+10%</td> <td>MAC</td> </tr> <tr> <td>WIC</td> <td>WWP</td> <td>TBSW</td> <td>GIC</td> <td>GSLV</td> <td>MOC</td> </tr> <tr> <td>WHC</td> <td>WNF(Natural</td> <td>TSTV</td> <td>GHC</td> <td>+10%</td> <td>MEC</td> </tr> <tr> <td>WOC</td> <td>Oak on Flat</td> <td>TSMV</td> <td>GOC</td> <td>GWL</td> <td>MGW</td> </tr> <tr> <td>WEC</td> <td>Cut)</td> <td>TSLV</td> <td>GEC</td> <td></td> <td>MTW</td> </tr> <tr> <td>WAM</td> <td>WSF(Salted</td> <td>TOBW</td> <td>GAM</td> <td></td> <td>MSW</td> </tr> <tr> <td>WCM</td> <td>Oak on Flat</td> <td>WMO</td> <td>GCM</td> <td></td> <td>MWL</td> </tr> <tr> <td>WEW</td> <td>Cut)</td> <td>WNO</td> <td>GEW</td> <td></td> <td>MNA</td> </tr> <tr> <td>WGW</td> <td>WMF(Mocha</td> <td>WSO</td> <td>GNW</td> <td></td> <td></td> </tr> <tr> <td>WBW</td> <td>Oak on Flat</td> <td></td> <td>GSTV</td> <td></td> <td></td> </tr> <tr> <td>WSW</td> <td>Cut)</td> <td></td> <td></td> <td></td> <td></td> </tr> </table>		WAC	WNW	TBCO	GAC	+10%	MAC	WIC	WWP	TBSW	GIC	GSLV	MOC	WHC	WNF(Natural	TSTV	GHC	+10%	MEC	WOC	Oak on Flat	TSMV	GOC	GWL	MGW	WEC	Cut)	TSLV	GEC		MTW	WAM	WSF(Salted	TOBW	GAM		MSW	WCM	Oak on Flat	WMO	GCM		MWL	WEW	Cut)	WNO	GEW		MNA	WGW	WMF(Mocha	WSO	GNW			WBW	Oak on Flat		GSTV			WSW	Cut)					<p>3 Select Edge Click to view edges</p> <table border="0"> <tr> <td></td> <td></td> <td></td> <td></td> <td></td> <td></td> <td></td> <td></td> <td></td> <td></td> <td></td> <td></td> </tr> <tr> <td>Classic</td> <td>Flat</td> <td>Knife</td> <td>Ledge</td> <td>Flat</td> <td>Ledge</td> <td>Classic</td> <td>Flat</td> <td>Knife</td> <td>Ledge</td> <td>Waterfall</td> <td>Flat</td> </tr> </table>														Classic	Flat	Knife	Ledge	Flat	Ledge	Classic	Flat	Knife	Ledge	Waterfall	Flat	<p>4 Select Hardware Click to view details</p> <table border="0"> <tr> <td>Hardware</td> <td>N/A</td> <td>Hardware</td> <td>N/A</td> <td>Hardware</td> <td>N/A</td> <td>Hardware</td> <td>N/A</td> </tr> </table>		Hardware	N/A	Hardware	N/A	Hardware	N/A	Hardware	N/A
WAC	WNW	TBCO	GAC	+10%	MAC																																																																																																		
WIC	WWP	TBSW	GIC	GSLV	MOC																																																																																																		
WHC	WNF(Natural	TSTV	GHC	+10%	MEC																																																																																																		
WOC	Oak on Flat	TSMV	GOC	GWL	MGW																																																																																																		
WEC	Cut)	TSLV	GEC		MTW																																																																																																		
WAM	WSF(Salted	TOBW	GAM		MSW																																																																																																		
WCM	Oak on Flat	WMO	GCM		MWL																																																																																																		
WEW	Cut)	WNO	GEW		MNA																																																																																																		
WGW	WMF(Mocha	WSO	GNW																																																																																																				
WBW	Oak on Flat		GSTV																																																																																																				
WSW	Cut)																																																																																																						
Classic	Flat	Knife	Ledge	Flat	Ledge	Classic	Flat	Knife	Ledge	Waterfall	Flat																																																																																												
Hardware	N/A	Hardware	N/A	Hardware	N/A	Hardware	N/A																																																																																																

Product Features

- 1 Standard grommet - matches pull finish or specify black TM30, silver TM31 or antique brass TM33
- Adjustable height from 29" to 47.5" with a maximum weight capacity of 220 lbs.
- Metal parts include 5 year warranty
- Lift available in MFS Silver (standard) or MFB Black (optional)
- Programmable height adjustable mechanism, motor includes 2 year warranty

Options

Curved Bridge

- CBT1: Modify to Curved Bridge - \$55

Grommets (Non-Standard Location)

Provide drawing w/ Grommet Location and Specify Color - \$95 ea.

- Black: TM30-NS
- Silver: TM31-NS
- Antique Brass: TM33-NS

Central Park

Conference Desks

Elliptical Conference Desk

[Click here to view statement of line](#)

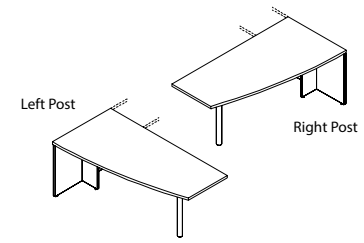

1 Select Model

w" x d" x h"	Weight
Left Post	
72 x 36/24 x 29	155
66 x 36/24 x 29	145
66 x 30/24 x 29	110
Right Post	
72 x 36/24 x 29	155
66 x 36/24 x 29	145
66 x 30/24 x 29	110

	Standard Veneer Top Standard Veneer Chassis	Premium Veneer Top Premium Veneer Chassis	High Pressure Laminate Top Veneer Chassis	Thermally Fused Laminate Top Thermally Fused Laminate Chassis
	CPC7236DC720W 3348 CPC6636DC720W 3296 CPC6630DC720W 3181	CPC7236DC720P 3684 CPC6636DC720P 3626 CPC6630DC720P 3499	CPC7236DC720G 3348 CPC6636DC720G 3296 CPC6630DC720G 3181	CPC7236DC720M 1469 CPC6636DC720M 1424 CPC6630DC720M 1228
	CPC7236DC719W 3348 CPC6636DC719W 3296 CPC6630DC719W 3181	CPC7236DC719P 3684 CPC6636DC719P 3626 CPC6630DC719P 3499	CPC7236DC719G 3348 CPC6636DC719G 3296 CPC6630DC719G 3181	CPC7236DC719M 1469 CPC6636DC719M 1424 CPC6630DC719M 1228
		TBCO TBSW TSTV TSMV TSLV TOBW WMO WNO WSO	GAC +10% GIC GSLV GHC +10% GOC GWL GEC GAM GCM GEW GNW GSTV	MAC MOC MEC MGW MTW MSW MWL MNA
	Classic Flat Knife Ledge Waterfall	Flat Ledge	Classic Flat Knife Ledge Waterfall	Flat
	Hardware N/A	Hardware N/A	Hardware N/A	Hardware N/A

Product Features

- 3" Silver anodized aluminum post leg standard (Optional black leg - n/c)
- Hookup hardware
- "T" Panel end

Notes

- All units are standard w/ flush ends
- Not Recommended for Freestanding Use
- See Options Sections for Additional Bases Available.

Options

Accessories

- K31: Center drawer - \$205
- K31-SK: Center drawer w/ skirt - \$310

Base

- SSB24: 24" Silver metal sleigh base - \$470
- SSB30: 30" metal sleigh base - \$495

Grommets (Standard Location)

Specify Color - \$50 ea.

- Black: TM30-C (Center)
- Silver: TM31-C (Center)
- Antique Brass: TM33-C (Center)

Grommets (Non-Standard Location)

Provide drawing w/ Grommet Location and Specify Color - \$95 ea.

- Black: TM30-NS
- Silver: TM31-NS
- Antique Brass: TM33-NS

Modesty

- HM45: SilverLuma frame/frost insert (half modesty) - \$415
- MC51: Half veneer/laminate modesty - \$130

2 Select Finish

[Click to view finishes](#)

Metal Finish

MFS Silver (standard),
MFB Black (optional)

WAC	WNW
WIC	WWP
WHC	WNF(Natural
WOC	Oak on Flat
WEC	Cut)
WAM	WSF(Salted
WCM	Oak on Flat
WEW	Cut)
WGW	WMF(Mocha
WBW	Oak on Flat
WSW	Cut)

3 Select Edge

[Click to view edges](#)

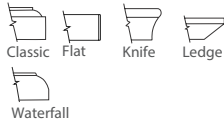

4 Select Hardware

[Click to view details](#)

Hardware
N/A

Central Park

Conference Desks Bullet Conference Desk

[Click here to view statement of line](#)

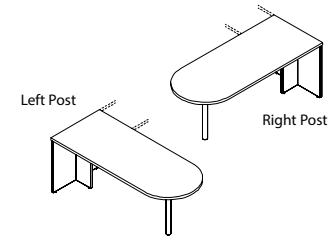

1 Select Model

w" x d" x h"

Left Post	Weight	Standard Veneer Top Standard Veneer Chassis	Premium Veneer Top Premium Veneer Chassis	High Pressure Laminate Top Veneer Chassis	Thermally Fused Laminate Top Thermally Fused Laminate Chassis
72 x 36 x 29	160	CPC7236DC716W 3540	CPC7236DC716P 3895	CPC7236DC716G 3540	CPC7236DC716M 1777
72 x 30 x 29	150	CPC7230DC716W 3402	CPC7230DC716P 3744	CPC7230DC716G 3402	CPC7230DC716M 1751
66 x 30 x 29	125	CPC6630DC716W 3348	CPC6630DC716P 3684	CPC6630DC716G 3348	CPC6630DC716M 1721
60 x 30 x 29	110	CPC6030DC716W 3296	CPC6030DC716P 3626	CPC6030DC716G 3296	CPC6030DC716M 1656
Right Post					
72 x 36 x 29	160	CPC7236DC715W 3540	CPC7236DC715P 3895	CPC7236DC715G 3540	CPC7236DC715M 1777
72 x 30 x 29	150	CPC7230DC715W 3402	CPC7230DC715P 3744	CPC7230DC715G 3121	CPC7230DC715M 1751
66 x 30 x 29	125	CPC6630DC715W 3348	CPC6630DC715P 3684	CPC6630DC715G 3348	CPC6630DC715M 1721
60 x 30 x 29	110	CPC6030DC715W 3296	CPC6030DC715P 3626	CPC6030DC715G 3296	CPC6030DC715M 1656

2 Select Finish

[Click to view finishes](#)

Metal Finish

MFS Silver (standard),
MFB Black (optional)

WAC	WNW	TBCO
WIC	WWP	TBSW
WHC	WNF(Natural	TSTV
WOC	Oak on Flat	TSMV
WEC	Cut)	TSLV
WAM	WSF(Salted	TOBW
WCM	Oak on Flat	WMO
WEW	Cut)	WNO
WGW	WMF(Mocha	WSO
WBW	Oak on Flat	
WSW	Cut)	

GAC +10%	MAC
GIC GSLV	MOC
GHC +10%	MEC
GOC GWL	MGW
GEC	MTW
GAM	MSW
GCM	MWL
GEW	MNA
GNW	
GSTV	

3 Select Edge

[Click to view edges](#)

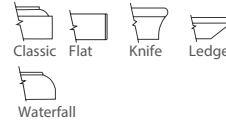
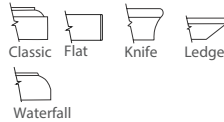

4 Select Hardware

[Click to view details](#)

Hardware
N/A

Hardware
N/A

Hardware
N/A

Hardware
N/A

Product Features

- 3" Silver anodized aluminum post leg standard (Optional black leg - n/c)
- Hookup hardware
- "T" Panel end

Notes

- All units are standard w/ flush ends
- Not Recommended for Freestanding Use
- See Options Sections for Additional Bases Available.

Options

Accessories

- K28: Articulating Keyboard w/ Mouse - \$390
- K31: Center drawer - \$205
- K31-SK: Center drawer w/ skirt - \$310

Grommets (Standard Location)

Specify Color - \$50 ea.

- Black: TM30-C (Center)
- Silver: TM31-C (Center)
- Antique Brass: TM33-C (Center)

Grommets (Non-Standard Location)

Provide drawing w/ Grommet Location and Specify Color - \$95 ea.

- Black: TM30-NS
- Silver: TM31-NS
- Antique Brass: TM33-NS

Modesty

- MC51: Half veneer/laminate modesty - \$130

Central Park

Conference Desks "P" Conference Desk

[Click here to view statement of line](#)

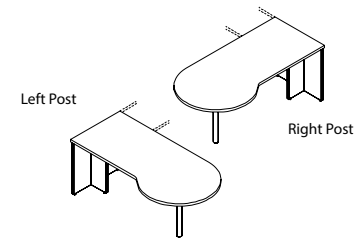

1 Select Model

w" x d" x h"	Weight
Left Post	
72 x 36/42 x 29	185
72 x 30/36 x 29	165
66 x 30/36 x 29	155
Right Post	
72 x 36/42 x 29	185
72 x 30/36 x 29	165
66 x 30/36 x 29	155

	Standard Veneer Top Standard Veneer Chassis	Premium Veneer Top Premium Veneer Chassis	High Pressure Laminate Top Veneer Chassis	Thermally Fused Laminate Top Thermally Fused Laminate Chassis
WAC	CPC7242DC028W 3709	CPC7242DC028P 4080	CPC7242DC028G 3709	CPC7242DC028M 2069
WIC	CPC7236DC028W 3604	CPC7236DC028P 3965	CPC7236DC028G 3604	CPC7236DC028M 2031
WHC	CPC6636DC028W 3506	CPC6636DC028P 3857	CPC6636DC028G 3506	CPC6636DC028M 2006
WOC				
WEC	CPC7242DC027W 3709	CPC7242DC027P 4080	CPC7242DC027G 3709	CPC7242DC027M 2069
WAM	CPC7236DC027W 3604	CPC7236DC027P 3965	CPC7236DC027G 3604	CPC7236DC027M 2031
WCM	CPC6636DC027W 3506	CPC6636DC027P 3857	CPC6636DC027G 3506	CPC6636DC027M 2006
WEW				
WGW				
WBW				
WSW				
TBCO				
TBSW				
TSTV				
TSMV				
TSLV				
TOBW				
WMO				
WNO				
WSO				
GAC +10%				
GIC GSLV				
GHC +10%				
GOC GWL				
GEC				
GAM				
GCM				
GEW				
GNW				
GSTV				
MAC				
MOC				
MEC				
MGW				
MTW				
MSW				
MWL				
MNA				

2 Select Finish

[Click to view finishes](#)

Metal Finish

MFS Silver (standard),
MFB Black (optional)

WAC	WNW
WIC	WWP
WHC	WNF(Natural
WOC	Oak on Flat
WEC	Cut)
WAM	WSF(Salted
WCM	Oak on Flat
WEW	Cut)
WGW	WMF(Mocha
WBW	Oak on Flat
WSW	Cut)

3 Select Edge

[Click to view edges](#)

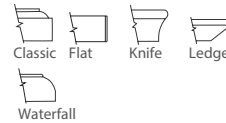
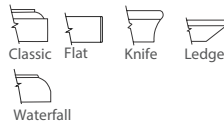

4 Select Hardware

[Click to view details](#)

Hardware
N/A

Hardware
N/A

Hardware
N/A

Hardware
N/A

Product Features

- 3" Silver anodized aluminum post leg standard (Optional black leg - n/c)
- Hookup hardware
- "T" Panel end

Notes

- All units are standard w/ flush ends
- Not Recommended for Freestanding Use
- See Options Sections for Additional Bases Available.

Options

Accessories

- K28: Articulating Keyboard w/ Mouse - \$390
- K31: Center drawer - \$205
- K31-SK: Center drawer w/ skirt - \$310

Grommets (Standard Location)

Specify Color - \$50 ea.

- Black: TM30-C (Center)
- Silver: TM31-C (Center)
- Antique Brass: TM33-C (Center)

Grommets (Non-Standard Location)

Provide drawing w/ Grommet Location and Specify Color - \$95 ea.

- Black: TM30-NS
- Silver: TM31-NS
- Antique Brass: TM33-NS

Modesty

- HM45: SilverLuma frame/frost insert (half modesty) - \$415
- MC51: Half veneer/laminate modesty - \$130

Central Park

Conference Desks
 Rectangle Conference Desk with (2)Angled Metal Legs

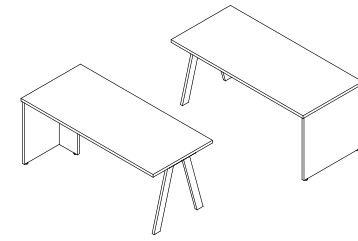

[Click here to view statement of line](#)

1 Select Model

w" x d" x h"
 Angled Legs Left
 72 x 36 x 29
 72 x 30 x 29
 66 x 36 x 29
 60 x 30 x 29
 Angled Legs Right
 72 x 36 x 29
 72 x 30 x 29
 66 X 36 X 29
 60 x 30 x 29

Weight	Standard Veneer Top Standard Veneer Chassis	Premium Veneer Top Premium Veneer Chassis	High Pressure Laminate Top Veneer Chassis	Thermally Fused Laminate Top Thermally Fused Laminate Chassis
160	CPC7236DC669W 3243	CPC7236DC669P 3568	CPC7236DC669G 3243	CPC7236DC669M 2497
150	CPC7230DC669W 2933	CPC7230DC669P 3226	CPC7230DC669G 2933	CPC7230DC669M 2246
155	CPC6636DC669W 3178	CPC6636DC669P 3496	CPC6636DC669G 3178	CPC6636DC669M 2453
110	CPC6630DC669W 2867	CPC6630DC669P 3154	CPC6630DC669G 2867	CPC6630DC669M 2202
160	CPC7236DC670W 3243	CPC7236DC670P 3568	CPC7236DC670G 3243	CPC7236DC670M 2497
150	CPC7230DC670W 2933	CPC7230DC670P 3226	CPC7230DC670G 2933	CPC7230DC670M 2246
155	CPC6636DC670W 3178	CPC6636DC670P 3496	CPC6636DC670G 3178	CPC6636DC670M 2453
110	CPC6030DC670W 2867	CPC6030DC670P 3154	CPC6030DC670G 2867	CPC6030DC670M 2202

Product Features

- 2 Silver Angled Metal Legs
- "T" support panel end

Notes

- Not Recommended for Freestanding Use

Options

Base

- AML-B Legs Black -- N/C
- AML-CH Legs Chrome \$125

Grommets (Standard Location)

- Specify Color and Left/Right - \$50 ea.
- Black: TM30-R (Right), TM30-L (Left)
 - Silver: TM31-R (Right), TM31-L (Left)
 - Antique Brass: TM33-R (Right), TM33-L (Left)

Grommets (Non-Standard Location)

Provide drawing w/ Grommet Location and Specify Color - \$95 ea.

- Black: TM30-NS
- Silver: TM31-NS
- Antique Brass: TM33-NS

Premium Finish Option

- MFGM: Matte Gold Metal Finish - \$160 per base
- MFDB: Dark Bronze Metal Finish - \$160 per base

Modesty

- HM45: SilverLuma frame/frost insert (half modesty) - \$415
- MC51: Half veneer/laminate modesty - \$130

2 Select Finish

[Click to view finishes](#)

Metal Finish
 MFS Silver (standard)

WAC	WNW
WIC	WWP
WHC	WNF(Natural
WOC	Oak on Flat
WEC	Cut)
WAM	WSF(Salted
WCM	Oak on Flat
WEW	Cut)
WGW	WMF(Mocha
WBW	Oak on Flat
WSW	Cut)

TBCO
 TBSW
 TSTV
 TSMV
 TSLV
 TOBW
 WMO
 WNO
 WSO

GAC +10%
 GIC GSLV
 GHC +10%
 GOC GWL
 GEC
 GAM
 GCM
 GEW
 GNW
 GSTV

MAC
 MOC
 MEC
 MGW
 MTW
 MSW
 MWL
 MNA

3 Select Edge

[Click to view edges](#)

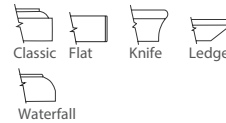
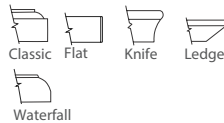

4 Select Hardware

[Click to view details](#)

Hardware
 N/A

Hardware
 N/A

Hardware
 N/A

Hardware
 N/A

Central Park

Conference Desks Rectangle Conference Desk With Sleigh Base

[Click here to view statement of line](#)

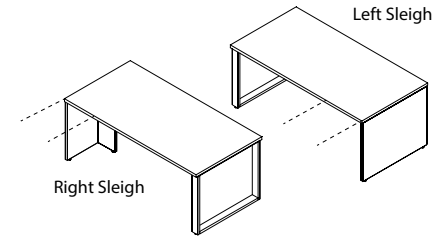

1 Select Model

w" x d" x h"	Weight
Left Sleigh Leg	
72 x 36 x 29	160
72 x 30 x 29	150
66 x 36 x 29	155
60 x 30 x 29	110
Right Sleigh Leg	
72 x 36 x 29	160
72 x 30 x 29	150
66 x 36 x 29	155
60 x 30 x 29	110

	Standard Veneer Top Standard Veneer Chassis		Premium Veneer Top Premium Veneer Chassis		High Pressure Laminate Top Veneer Chassis		Thermally Fused Laminate Top Thermally Fused Laminate Chassis	
WAC	CPC7236DC767W	3517	CPC7236DC767P	3869	CPC7236DC767G	3517	CPC7236DC767M	1729
WIC	CPC7230DC767W	3375	CPC7230DC767P	3713	CPC7230DC767G	3375	CPC7230DC767M	1530
WHC	CPC6636DC767W	3375	CPC6636DC767P	3713	CPC6636DC767G	3375	CPC6636DC767M	1530
WOC	CPC6030DC767W	3270	CPC6030DC767P	3597	CPC6030DC767G	3270	CPC6030DC767M	1457
WEC	CPC7236DC766W	3517	CPC7236DC766P	3869	CPC7236DC766G	3517	CPC7236DC766M	1729
WAM	CPC7230DC766W	3375	CPC7230DC766P	3713	CPC7230DC766G	3375	CPC7230DC766M	1530
WCM	CPC6636DC766W	3375	CPC6636DC766P	3713	CPC6636DC766G	3375	CPC6636DC766M	1530
WEW	CPC6030DC766W	3270	CPC6030DC766P	3597	CPC6030DC766G	3270	CPC6030DC766M	1457
WGW								
WBW								
WSW								
TBCO								
TBSW								
TSTV								
TSMV								
TSLV								
TOBV								
WMO								
WNO								
WSO								
GAC +10%								
GIC GSLV								
GHC +10%								
GOC GWL								
GEC								
GAM								
GCM								
GEW								
GNW								
GSTV								
MAC								
MOC								
MEC								
MGW								
MTW								
MSW								
MWL								
MNA								

2 Select Finish

Click to view finishes

WAC	WNW
WIC	WWP
WHC	WNF(Natural
WOC	Oak on Flat
WEC	Cut)
WAM	WSF(Salted
WCM	Oak on Flat
WEW	Cut)
WGW	WMF(Mocha
WBW	Oak on Flat
WSW	Cut)

TBCO
TBSW
TSTV
TSMV
TSLV
TOBV
WMO
WNO
WSO

GAC +10%
GIC GSLV
GHC +10%
GOC GWL
GEC
GAM
GCM
GEW
GNW
GSTV

MAC
MOC
MEC
MGW
MTW
MSW
MWL
MNA

3 Select Edge

Click to view edges

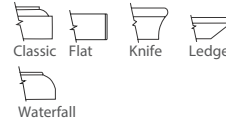
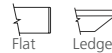
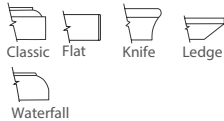

4 Select Hardware

Click to view details

Hardware
N/A

Hardware
N/A

Hardware
N/A

Hardware
N/A

Product Features

- Hookup hardware
- Metal sleigh base - standard silver finish
- "T" Panel end

Notes

- All units are standard w/ flush ends

Options

Accessories

- K28: Articulating Keyboard w/ Mouse - \$390
- K31: Center drawer - \$205
- K31-SK: Center drawer w/ skirt - \$310

Base

- RDL-S: Silver round post leg - deduct \$260
- RDL-S: Silver round post leg - deduct \$260
- SQL-S: Silver square post leg - deduct \$260
- SQL-B: Black square post leg - deduct \$260

Grommets (Standard Location)

Specify Color - \$50 ea.

- Black: TM30-C (Center)
- Silver: TM31-C (Center)
- Antique Brass: TM33-C (Center)

Grommets (Non-Standard Location)

Provide drawing w/ Grommet Location and Specify Color - \$95 ea.

- Black: TM30-NS
- Silver: TM31-NS
- Antique Brass: TM33-NS

Modesty

- HM45: SilverLuma frame/frost insert (half modesty) - \$415
- MC51: Half veneer/laminate modesty - \$130

Premium Finish Option

- MFB: Black Metal Finish - \$160 per base

Central Park

Conference Runoff Desks
Bullet Runoff Desk

[Click here to view statement of line](#)

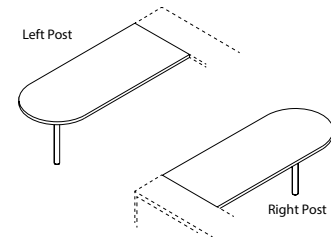

1 Select Model

w" x d" x h"

Weight	Standard Veneer Top Standard Veneer Chassis	Premium Veneer Top Premium Veneer Chassis	High Pressure Laminate Top Veneer Chassis	Thermally Fused Laminate Top Thermally Fused Laminate Chassis
Left Post				
72 x 30 x 29	155	CPC7230DR745W 2479	CPC7230DR745P 2728	CPC7230DR745G 2479
66 x 30 x 29	145	CPC6630DR745W 2356	CPC6630DR745P 2593	CPC6630DR745G 2356
60 x 30 x 29	135	CPC6030DR745W 2278	CPC6030DR745P 2505	CPC6030DR745G 2278
54 x 30 x 29	125	CPC5430DR745W 2197	CPC5430DR745P 2417	CPC5430DR745G 2197
Right Post				
72 x 30 x 29	155	CPC7230DR744W 2479	CPC7230DR744P 2728	CPC7230DR744G 2479
66 x 30 x 29	145	CPC6630DR744W 2356	CPC6630DR744P 2593	CPC6630DR744G 2356
60 x 30 x 29	135	CPC6030DR744W 2278	CPC6030DR744P 2505	CPC6030DR744G 2278
54 x 30 x 29	125	CPC5430DR744W 2197	CPC5430DR744P 2417	CPC5430DR744G 2197

2 Select Finish

[Click to view finishes](#)

Metal Finish

MFS Silver (standard),
MFB Black (optional)

WAC	WNW	TBCO	GAC +10%	MAC
WIC	WWP	TBSW	GIC GSLV	MOC
WHC	WNF(Natural	TSTV	GHC +10%	MEC
WOC	Oak on Flat	TSMV	GOC GWL	MGW
WEC	Cut)	TSLV	GEC	MTW
WAM	WSF(Salted	TOBW	GAM	MSW
WCM	Oak on Flat	WMO	GCM	MWL
WEW	Cut)	WNO	GEW	MNA
WGW	WMF(Mocha	WSO	GNW	
WBW	Oak on Flat		GSTV	
WSW	Cut)			

3 Select Edge

[Click to view edges](#)

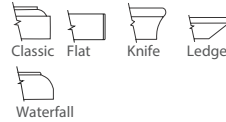
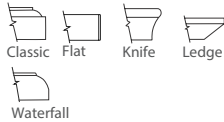

4 Select Hardware

[Click to view details](#)

Hardware
N/A

Hardware
N/A

Hardware
N/A

Hardware
N/A

Product Features

- 3" Silver anodized aluminum post leg standard (Optional black leg - n/c)
- Hookup hardware

Notes

- "P" Tops and Bullets are not intended to be freestanding
- Verify Desk Kneespace On Sizes Under 66"W
- See Bench Runoff Supports when using with Bench Credenza

Options

Accessories

- K28: Articulating Keyboard w/ Mouse - \$390
- K31: Center drawer - \$205
- K31-SK: Center drawer w/ skirt - \$310

Grommets (Standard Location)

Specify Color - \$50 ea.

- Black: TM30-C (Center)
- Silver: TM31-C (Center)
- Antique Brass: TM33-C (Center)

Grommets (Non-Standard Location)

Provide drawing w/ Grommet Location and Specify Color - \$95 ea.

- Black: TM30-NS
- Silver: TM31-NS
- Antique Brass: TM33-NS

Modesty

- HM45: SilverLuma frame/frost insert (half modesty) - \$415
- MC51: Half veneer/laminate modesty - \$130

Central Park

Conference Runoff Desks
Rectangle Runoff Desk

[Click here to view statement of line](#)

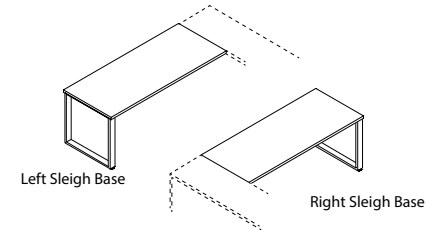

1 Select Model

w" x d" x h"	Weight
Left Sleigh	
72 x 30 x 29	155
66 x 30 x 29	145
60 x 30 x 29	135
54 x 30 x 29	125
Right Sleigh	
72 x 30 x 29	155
66 x 30 x 29	145
60 x 30 x 29	135
54 x 30 x 29	125

	Standard Veneer Top Standard Veneer Chassis		Premium Veneer Top Premium Veneer Chassis		High Pressure Laminate Top Veneer Chassis		Thermally Fused Laminate Top Thermally Fused Laminate Chassis				
WAC			TBCO		GAC +10%		MAC				
WIC	WNW		TBSW		GIC GSLV		MOC				
WHC	WNP(Natural		TSTV		GHC +10%		MEC				
WOC	Oak on Flat		TSMV		GOC GWL		MGW				
WEC	Cut)		TSLV		GEC		MTW				
WAM	WSF(Salted		TOBV		GAM		MSW				
WCM	Oak on Flat		WMO		GCM		MWL				
WEW	Cut)		WNO		GEW		MNA				
WGW	WMF(Mocha		WSO		GNW						
WBW	Oak on Flat				GSTV						
WSW	Cut)										
Classic	Flat	Knife	Ledge	Flat	Ledge	Classic	Flat	Knife	Ledge	Waterfall	Flat
Hardware	N/A		Hardware	N/A		Hardware	N/A		Hardware	N/A	

Product Features

- Hookup hardware
- Metal sleigh base - standard silver finish

Notes

- See Bench Runoff Supports when using with Bench Credenza

Options

Accessories

- K28: Articulating Keyboard w/ Mouse - \$390
- K31: Center drawer - \$205
- K31-SK: Center drawer w/ skirt - \$310

Base

- RDL-S: Silver round post leg - deduct \$260
- RDL-S: Silver round post leg - deduct \$260
- SQL-S: Silver square post leg - deduct \$260
- SQL-B: Black square post leg - deduct \$260

Grommets (Standard Location)

Specify Color and Left/Right/Center - \$50 ea.

- Black: TM30-R (Right), TM30-L (Left), TM30-C (Center)
- Silver: TM31-R (Right), TM31-L (Left), TM31-C (Center)
- Antique Brass: TM33-R (Right), TM33-L (Left), TM33-C (Center)

Grommets (Non-Standard Location)

Provide drawing w/ Grommet Location and Specify Color - \$95 ea.

- Black: TM30-NS
- Silver: TM31-NS
- Antique Brass: TM33-NS

Modesty

- HM45: SilverLuma frame/frost insert (half modesty) - \$415
- MC51: Half veneer/laminate modesty - \$130

Premium Finish Option

- MFB: Black Metal Finish - \$160 per base

2 Select Finish

[Click to view finishes](#)

Metal Finish

MFS Silver. Additional

Metal Finishes are available, options

3 Select Edge

[Click to view edges](#)

4 Select Hardware

[Click to view details](#)

Central Park

Service Workstation Desks
Breakfront Modesty Full Pedestal

[Click here to view statement of line](#)

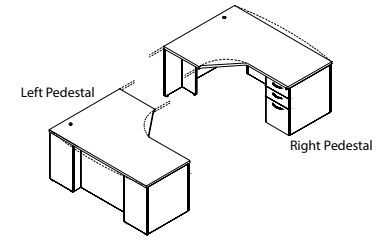

1 Select Model

w" x d" x h"	Weight
Left Pedestal	
72 x 30/48 x 29	310
66 x 30/48 x 29	290
66 x 24/42 x 29	260
Right Pedestal	
72 x 30/48 x 29	310
66 x 30/48 x 29	290
66 x 24/42 x 29	260

Standard Veneer Top Standard Veneer Chassis		Premium Veneer Top Premium Veneer Chassis		High Pressure Laminate Top Veneer Chassis		Thermally Fused Laminate Top Thermally Fused Laminate Chassis	
WAC WNW		TBCO		GAC +10%		MAC	
WIC WWP		TBSW		GIC GSLV		MOC	
WHC WNF(Natural		TSTV		GHC +10%		MEC	
WOC Oak on Flat		TSMV		GOC GWL		MGW	
WEC Cut)		TSLV		GEC		MTW	
WAM WSF(Salted		TOBW		GAM		MSW	
WCM Oak on Flat		WMO		GCM		MWL	
WEW Cut)		WNO		GEW		MNA	
WGW WMF(Mocha		WSO		GNW			
WBW Oak on Flat				GSTV			
WSW Cut)							
<p>4 Select Hardware</p> <p>Click to view details</p> <p>See Intro Page for Pull Options</p>		<p>See Intro Page for Pull Options</p>		<p>See Intro Page for Pull Options</p>		<p>See Intro Page for Pull Options</p>	

Product Features

- 1 Standard grommet - matches pull finish or specify black TM30, silver TM31 or antique brass TM33
- Box/Box/File
- "W" & "G" SKUs feature soft close suspensions, "M" SKUs feature ball bearing suspensions. Both suspensions are full extension.

Notes

- All units are standard w/ flush ends
- Modesty is recessed 6"

Options

Accessories

- K28: Articulating Keyboard w/ Mouse - \$390
- K31: Center drawer - \$205
- N/A with T80 or T90 options

Drawer

- P6: Modify Box/Box/File to File/File - \$55 per pedestal
- P33: Wood Drawer Upgrade - \$45 per drawer
- WPD3061: Designer White - \$80 per pedestal

Grommets (Non-Standard Location)

- Provide drawing w/ Grommet Location and Specify Color - \$95 ea.
- Black: TM30-NS
- Silver: TM31-NS
- Antique Brass: TM33-NS

Modesty

- M39: SilverLuma Frame w/ Frost insert (full modesty) - \$650
- HM39: SilverLuma Frame w/ Frost insert (half modesty) - \$340

Service Desks

- For Ledge, Classic, Flat, Knife, and Waterfall edges, specify T80 or T81
- T80: Edge Curve User Side - n/c
- T81: Edge Approach Side Bowfront Edge - \$80

Central Park

Service Workstation Desks
 Flush Modesty Full Pedestal W/ Overhang Top

[Click here to view statement of line](#)

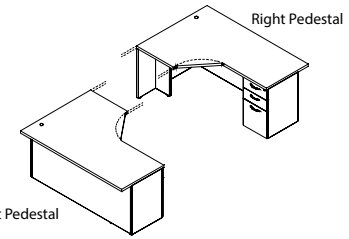

1 Select Model

w" x d" x h"	Weight
Left Pedestal	
72 x 30/48 x 29	300
66 x 30/48 x 29	280
66 x 24/42 x 29	250
Right Pedestal	
72 x 30/48 x 29	300
66 x 30/48 x 29	280
66 x 24/42 x 29	250

Standard Veneer Top Standard Veneer Chassis		Premium Veneer Top Premium Veneer Chassis		High Pressure Laminate Top Veneer Chassis		Thermally Fused Laminate Top Thermally Fused Laminate Chassis	
CPC7248DS760W	4818	CPC7248DS760P	5300	CPC7248DS760G	4818	CPC7248DS760M	2339
CPC6648DS760W	4722	CPC6648DS760P	5195	CPC6648DS760G	4722	CPC6648DS760M	2291
CPC6642DS760W	4269	CPC6642DS760P	4696	CPC6642DS760G	4269	CPC6642DS760M	2252
CPC7248DS759W	4818	CPC7248DS759P	5300	CPC7248DS759G	4818	CPC7248DS759M	2339
CPC6648DS759W	4722	CPC6648DS759P	5195	CPC6648DS759G	4722	CPC6648DS759M	2291
CPC6642DS759W	4269	CPC6642DS759P	4696	CPC6642DS759G	4269	CPC6642DS759M	2252

Product Features

- 1 Standard grommet - matches pull finish or specify black TM30, silver TM31 or antique brass TM33
- Box/Box/File
- "W" & "G" SKUs feature soft close suspensions, "M" SKUs feature ball bearing suspensions. Both suspensions are full extension.

Notes

- 24"/42" D Have 18" Pedestal
- 30"/48" D Have 24" Pedestal
- 6" Overhang on Approach
- All units are standard w/ flush ends

Options

Accessories

- K28: Articulating Keyboard w/ Mouse - \$390
- K31: Center drawer - \$205

Drawer

- P6: Modify Box/Box/File to File/File - \$55 per pedestal
- P33: Wood Drawer Upgrade - \$45 per drawer
- WPD3061: Designer White - \$80 per pedestal

Grommets (Non-Standard Location)

- Provide drawing w/ Grommet Location and Specify Color - \$95 ea.
- Black: TM30-NS
- Silver: TM31-NS
- Antique Brass: TM33-NS

Service Desks

- For Ledge, Classic, Flat, Knife, and Waterfall edges, specify T80 or T81
- T80: Edge Curve User Side - n/c
- T81: Edge Approach Side Bowfront Edge - \$80

2 Select Finish

[Click to view finishes](#)

WAC	WNW
WIC	WWP
WHC	WNF(Natural
WOC	Oak on Flat
WEC	Cut)
WAM	WSF(Salted
WCM	Oak on Flat
WEW	Cut)
WGW	WMF(Mocha
WBW	Oak on Flat
WSW	Cut)

TBCO
 TBSW
 TSTV
 TSMV
 TSLV
 TOBW
 WMO
 WNO
 WSO

GAC +10%
 GIC GSLV
 GHC +10%
 GOC GWL
 GEC
 GAM
 GCM
 GEW
 GNW
 GSTV

MAC
 MOC
 MEC
 MGW
 MTW
 MSW
 MWL
 MNA

3 Select Edge

[Click to view edges](#)

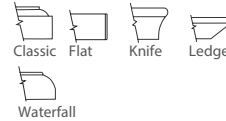
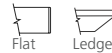
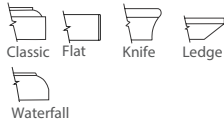

4 Select Hardware

[Click to view details](#)

[See Intro Page for Pull Options](#)

[See Intro Page for Pull Options](#)

[See Intro Page for Pull Options](#)

[See Intro Page for Pull Options](#)

Central Park

Service Workstation Desks
Bullet Service Desk

[Click here to view statement of line](#)

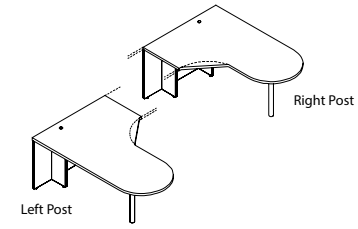

1 Select Model

w" x d" x h"	Weight
72 x 30/48 x 29	200
66 x 30/48 x 29	190
66 x 24/42 x 29	160
72 x 30/48 x 29	200
66 x 30/48 x 29	190
66 x 24/42 x 29	160

Standard Veneer Top Standard Veneer Chassis		Premium Veneer Top Premium Veneer Chassis		High Pressure Laminate Top Veneer Chassis		Thermally Fused Laminate Top Thermally Fused Laminate Chassis	
CPC7248DS737W	4119	CPC7248DS737P	4531	CPC7248DS737G	4119	CPC7248DS737M	1574
CPC6648DS737W	4008	CPC6648DS737P	4410	CPC6648DS737G	4008	CPC6648DS737M	1549
CPC6642DS737W	3824	CPC6642DS737P	4207	CPC6642DS737G	3824	CPC6642DS737M	1525
CPC7248DS736W	4119	CPC7248DS736P	4531	CPC7248DS736G	4119	CPC7248DS736M	1574
CPC6648DS736W	4008	CPC6648DS736P	4410	CPC6648DS736G	4008	CPC6648DS736M	1549
CPC6642DS736W	3824	CPC6642DS736P	4207	CPC6642DS736G	3824	CPC6642DS736M	1525

Product Features

- 1 Standard grommet - matches pull finish or specify black TM30, silver TM31 or antique brass TM33
- 3" Silver anodized aluminum post leg standard (Optional black leg - n/c)

Notes

- All units are standard w/ flush ends
- See Options Sections For Additional Support Legs Available.

Options

Accessories

- K28: Articulating Keyboard w/ Mouse - \$390
- K31: Center drawer - \$205
- K31-SK: Center drawer w/ skirt - \$310

Grommets (Non-Standard Location)

- Provide drawing w/ Grommet Location and Specify Color - \$95 ea.
- Black: TM30-NS
- Silver: TM31-NS
- Antique Brass: TM33-NS

Modesty

- M45: SilverLuma frame/frost insert (Full Modesty) - \$755
- HM45: SilverLuma frame/frost insert (half modesty) - \$415
- MC51: Half veneer/laminate modesty - \$130

Service Desks

- For Ledge, Classic, Flat, Knife, and Waterfall edges, specify T80 or T81
- T80: Edge Curve User Side - n/c
- T81: Edge Approach Side Bowfront Edge - \$80

2 Select Finish

[Click to view finishes](#)

Metal Finish

MFS Silver (standard),
MFB Black (optional)

WAC	WNW
WIC	WWP
WHC	WNF(Natural
WOC	Oak on Flat
WEC	Cut)
WAM	WSF(Salted
WCM	Oak on Flat
WEW	Cut)
WGW	WMF(Mocha
WBW	Oak on Flat
WSW	Cut)

TBCO
TBSW
TSTV
TSMV
TSLV
TOBW
WMO
WNO
WSO

GAC +10%
GIC GSLV
GHC +10%
GOC GWL
GEC
GAM
GCM
GEW
GNW
GSTV

MAC
MOC
MEC
MGW
MTW
MSW
MWL
MNA

3 Select Edge

[Click to view edges](#)

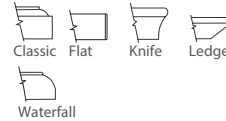
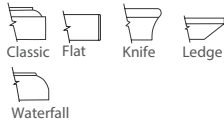

4 Select Hardware

[Click to view details](#)

Hardware
N/A

Hardware
N/A

Hardware
N/A

Hardware
N/A

Central Park

Workstation Runoff Desks Single Full Pedestal
Breakfront Runoff

[Click here to view statement of line](#)

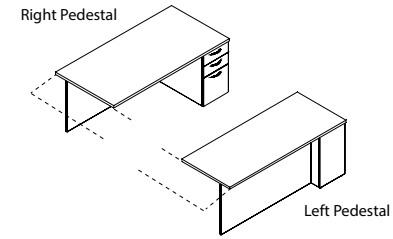

1 Select Model

w" x d" x h"	Weight
84 x 36 x 29	260
78 x 36 x 29	245
72 x 36 x 29	250
72 x 30 x 29	230
66 x 30 x 29	210
60 x 30 x 29	200
54 x 30 x 29	180
84 x 36 x 29	260
78 x 36 x 29	245
72 x 36 x 29	250
72 x 30 x 29	230
66 x 30 x 29	210
60 x 30 x 29	200
54 x 30 x 29	180

	Standard Veneer Top Standard Veneer Chassis	Premium Veneer Top Premium Veneer Chassis	High Pressure Laminate Top Veneer Chassis	Thermally Fused Laminate Top Thermally Fused Laminate Chassis
Standard Veneer Top	CPC8436DR019W 4289	CPC8436DR019P 4718	CPC8436DR019G 4289	CPC8436DR019M 2226
	CPC7836DR019W 3920	CPC7836DR019P 4313	CPC7836DR019G 3920	CPC7836DR019M 2209
	CPC7236DR019W 3648	CPC7236DR019P 4013	CPC7236DR019G 3648	CPC7236DR019M 2189
	CPC7230DR019W 3553	CPC7230DR019P 3908	CPC7230DR019G 3553	CPC7230DR019M 1941
	CPC6630DR019W 3402	CPC6630DR019P 3744	CPC6630DR019G 3402	CPC6630DR019M 1909
	CPC6030DR019W 3296	CPC6030DR019P 3626	CPC6030DR019G 3296	CPC6030DR019M 1880
	CPC5430DR019W 3199	CPC5430DR019P 3519	CPC5430DR019G 3199	CPC5430DR019M 1848
Right Pedestal				
	CPC8436DR020W 4289	CPC8436DR020P 4718	CPC8436DR020G 4289	CPC8436DR020M 2226
	CPC7836DR020W 3920	CPC7836DR020P 4313	CPC7836DR020G 3920	CPC7836DR020M 2209
	CPC7236DR020W 3648	CPC7236DR020P 4013	CPC7236DR020G 3648	CPC7236DR020M 2189
	CPC7230DR020W 3553	CPC7230DR020P 3908	CPC7230DR020G 3553	CPC7230DR020M 1941
	CPC6630DR020W 3402	CPC6630DR020P 3744	CPC6630DR020G 3402	CPC6630DR020M 1909
	CPC6030DR020W 3296	CPC6030DR020P 3626	CPC6030DR020G 3296	CPC6030DR020M 1880
	CPC5430DR020W 3199	CPC5430DR020P 3519	CPC5430DR020G 3199	CPC5430DR020M 1848
2 Select Finish				
Click to view finishes	WAC WNW WIC WWP WHC WNF(Natural WOC Oak on Flat WEC Cut) WAM WSF(Salted WCM Oak on Flat WEW Cut) WGW WMF(Mocha WBW Oak on Flat WSW Cut)	TBCO TBSW TSTV TSMV TSLV TOBW WMO WNO WSO	GAC +10% GIC GSLV GHC +10% GOC GWL GEC GAM GCM GEW GNW GSTV	MAC MOC MEC MGW MTW MSW MWL MNA
3 Select Edge				
Click to view edges				
4 Select Hardware				
Click to view details	See Intro Page for Pull Options	See Intro Page for Pull Options	See Intro Page for Pull Options	See Intro Page for Pull Options

Product Features

- Box/Box/File
- Full fixed modesty w/ "L" support end
- Hookup hardware
- "W" & "G" SKUs feature soft close suspensions, "M" SKUs feature ball bearing suspensions. Both suspensions are full extension.

Notes

- 6" Recessed Modesty
- All units are standard w/ flush ends
- Hooks to credenzas
- See Bench Runoff Supports when using with Bench Credenza

Options

Accessories

- K28: Articulating Keyboard w/ Mouse - \$390
- K31: Center drawer - \$205

Drawer

- P6: Modify Box/Box/File to File/File - \$55 per pedestal
- P33: Wood Drawer Upgrade - \$45 per drawer
- WPD3061: Designer White - \$80 per pedestal

Grommets (Standard Location)

- Specify Color and Left/Right - \$50 ea.
- Black: TM30-R (Right), TM30-L (Left)
- Silver: TM31-R (Right), TM31-L (Left)
- Antique Brass: TM33-R (Right), TM33-L (Left)

Grommets (Non-Standard Location)

- Provide drawing w/ Grommet Location and Specify Color - \$95 ea.
- Black: TM30-NS
- Silver: TM31-NS
- Antique Brass: TM33-NS

Modesty

- DM55: Delete Modesty Panel - Deduct \$75

Central Park

Conference Runoff Desk
 Rectangle Conference Runoff with Angled Legs

[Click here to view statement of line](#)

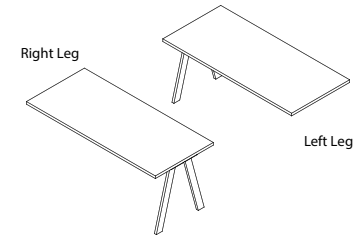

1 Select Model

w" x d" x h"	Weight
Angled Legs Left	
72 x 36 x 29	135
72 x 30 x 29	125
66 x 36 x 29	130
60 x 30 x 29	120
Angled Legs Right	
72 x 36 x 29	135
72 x 30 x 29	125
66 x 36 x 29	130
60 x 30 x 29	125

	Standard Veneer Top Standard Veneer Chassis	Premium Veneer Top Premium Veneer Chassis	High Pressure Laminate Top Veneer Chassis	Thermally Fused Laminate Top Thermally Fused Laminate Chassis
CPC7236DR652W 2943	CPC7236DR652P 3238	CPC7236DR652G 2943	CPC7236DR652M 2268	
CPC7230DR652W 2660	CPC7230DR652P 2926	CPC7230DR652G 2660	CPC7230DR652M 2050	
CPC6636DR652W 2884	CPC6636DR652P 3172	CPC6636DR652G 2884	CPC6636DR652M 2224	
CPC6030DR652W 2595	CPC6030DR652P 2854	CPC6030DR652G 2595	CPC6030DR652M 2006	
CPC7236DR653W 2943	CPC7236DR653P 3238	CPC7236DR653G 2943	CPC7236DR653M 2268	
CPC7230DR653W 2660	CPC7230DR653P 2926	CPC7230DR653G 2660	CPC7230DR653M 2050	
CPC6636DR653W 2884	CPC6636DR653P 3172	CPC6636DR653G 2884	CPC6636DR653M 2224	
CPC6030DR653W 2595	CPC6030DR653P 2854	CPC6030DR653G 2595	CPC6030DR653M 2006	
WAC WNW TBCO	WIC WWP TBSW	GAC +10% GSLV	MAC	
WHC WNF(Natural	WOC Oak on Flat	GHC +10% GWL	MOC	
WEC Cut)	WAM WSF(Salted	GOC GWL	MEC	
WCM Oak on Flat	WMO Cut)	GEC	MGW	
WEW Cut)	WNO WNO	GAM	MTW	
WGW WMF(Mocha	WSO WSO	GCM	MSW	
WBW Oak on Flat		GEW	MWL	
WSW Cut)		GNW	MNA	
		GSTV		
Classic Flat Knife Ledge	Flat Ledge	Classic Flat Knife Ledge	Flat	
Waterfall		Waterfall		
Hardware N/A	Hardware N/A	Hardware N/A	Hardware N/A	

Product Features

- 2 Silver Angled Metal Legs

Options

Accessories

- K28: Articulating Keyboard w/ Mouse - \$390
- K31: Center drawer - \$205
- K31-SK: Center drawer w/ skirt - \$310

Base

- AML-B Legs Black -- N/C
- AML-CH Legs Chrome \$125

Grommets (Standard Location)

Specify Color and Left/Right - \$50 ea.

- Black: TM30-R (Right), TM30-L (Left)
- Silver: TM31-R (Right), TM31-L (Left)
- Antique Brass: TM33-R (Right), TM33-L (Left)

Grommets (Non-Standard Location)

Provide drawing w/ Grommet Location and Specify Color - \$95 ea.

- Black: TM30-NS
- Silver: TM31-NS
- Antique Brass: TM33-NS

Premium Finish Option

- MFGM: Matte Gold Metal Finish - \$160 per base
- MFDB: Dark Bronze Metal Finish - \$160 per base

Modesty

- HM45: SilverLuma frame/frost insert (half modesty) - \$415
- MC51: Half veneer/laminate modesty - \$130

2 Select Finish

[Click to view finishes](#)

WAC	WNW
WIC	WWP
WHC	WNF(Natural
WOC	Oak on Flat
WEC	Cut)
WAM	WSF(Salted
WCM	Oak on Flat
WEW	Cut)
WGW	WMF(Mocha
WBW	Oak on Flat
WSW	Cut)

3 Select Edge

[Click to view edges](#)

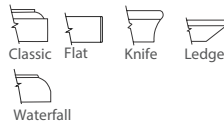

4 Select Hardware

[Click to view details](#)

Hardware
N/A

Hardware
N/A

Hardware
N/A

Hardware
N/A

Central Park

Height Adjustable Workstation Runoff Desks
Height Adjustable Runoff Desk

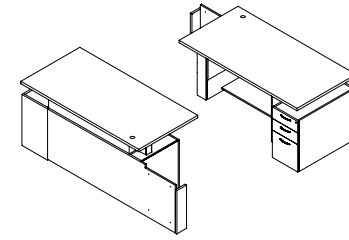

[Click here to view statement of line](#)

1 Select Model

w" x d" x h"	Weight
Left Pedestal	
72 x 36 x 29-47.5	275
72 x 30 x 29-47.5	255
66 x 36 x 29-47.5	255
66 x 30 x 29-47.5	235
Right Pedestal	
72 x 36 x 29-47.5	275
72 x 30 x 29-47.5	255
66 x 36 x 29-47.5	255
66 x 30 x 29-47.5	235

Standard Veneer Top Standard Veneer Chassis		Premium Veneer Top Premium Veneer Chassis		High Pressure Laminate Top Veneer Chassis		Thermally Fused Laminate Top Thermally Fused Laminate Chassis	
CPC7236DR710W	7830	CPC7236DR710P	8614	CPC7236DR710G	7830	CPC7236DR710M	6340
CPC7230DR710W	7554	CPC7230DR710P	8310	CPC7230DR710G	7554	CPC7230DR710M	5924
CPC6636DR710W	7673	CPC6636DR710P	8440	CPC6636DR710G	7673	CPC6636DR710M	6221
CPC6630DR710W	7332	CPC6630DR710P	8065	CPC6630DR710G	7332	CPC6630DR710M	5793
CPC7236DR709W	7830	CPC7236DR709P	8614	CPC7236DR709G	7830	CPC7236DR709M	6340
CPC7230DR709W	7554	CPC7230DR709P	8310	CPC7230DR709G	7554	CPC7230DR709M	5924
CPC6636DR709W	7673	CPC6636DR709P	8440	CPC6636DR709G	7673	CPC6636DR709M	6221
CPC6630DR709W	7332	CPC6630DR709P	8065	CPC6630DR709G	7332	CPC6630DR709M	5793

Product Features

- 1 Standard grommet - matches pull finish or specify black TM30, silver TM31 or antique brass TM33
- Adjustable height from 29" to 47.5" with a maximum weight capacity of 350 lbs.
- Box/Box/File
- Fully assembled
- Full fixed modesty
- Hookup hardware
- Lift available in MFS Silver (standard) or MFB Black (optional)
- Metal parts include 5 year warranty
- Programmable height adjustable mechanism, motor includes 2 year warranty

Notes

- Modesty surround lifts w/ work surface
- Extended section slides under credenza

Options

Accessories

- K31: Center drawer - \$205

Drawer

- P6: Modify Box/Box/File to File/File - \$55 per pedestal
- P33: Wood Drawer Upgrade - \$45 per drawer
- WPD3061: Designer White - \$80 per pedestal fronts

Grommets (Standard Location)

- Specify Color - \$50 ea.
- Black: TM30-C (Center)
- Silver: TM31-C (Center)
- Antique Brass: TM33-C (Center)

Grommets (Non-Standard Location)

- Provide drawing w/ Grommet Location and Specify Color - \$95 ea.
- Black: TM30-NS
- Silver: TM31-NS
- Antique Brass: TM33-NS

Wire Management

- LWMB: Lift wire management box with flip down door - \$365
- Power strip with five outlets and 12' cord, mesh wire cover, 6" deep black box

2 Select Finish

[Click to view finishes](#)

WAC	WNW
WIC	WWP
WHC	WNF(Natural
WOC	Oak on Flat
WEC	Cut)
WAM	WSF(Salted
WCM	Oak on Flat
WEW	Cut)
WGW	WMF(Mocha
WBW	Oak on Flat
WSW	Cut)

TBCO
TBSW
TSTV
TSMV
TSLV
TOBW
WMO
WNO
WSO

GAC +10%
GIC GSLV
GHC +10%
GOC GWL
GEC
GAM
GCM
GEW
GNW
GSTV

MAC
MOC
MEC
MGW
MTW
MSW
MWL
MNA

3 Select Edge

[Click to view edges](#)

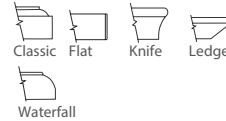
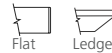
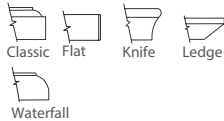

4 Select Hardware

[Click to view details](#)

[See Intro Page for Pull Options](#)

[See Intro Page for Pull Options](#)

[See Intro Page for Pull Options](#)

[See Intro Page for Pull Options](#)

Central Park

Height Adjustable Runoff Desk
 Height Adjustable Runoff with Angled Metal Shroud

[Click here to view statement of line](#)

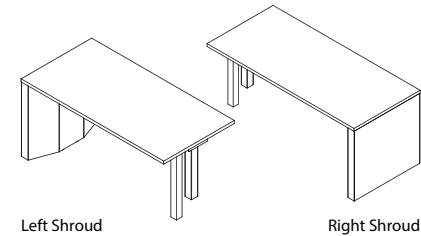

1 Select Model

w" x d" x h"	Weight
Left Angled Metal Shroud	
84 x 30 x 29/47.5	290
72 x 30 x 29/47.5	250
66 x 30 x 29/47.5	230
60 x 30 x 29-47.5	210
54 x 30 x 29-47.5	190
Right Angled Metal Shroud	
84 x 30 x 29-47.5	290
72 x 30 x 29-47.5	250
66 x 30 x 29-47.5	230
60 x 30 x 29-47.5	210
54 x 30 x 29-47.5	190

	Standard Veneer Top Standard Veneer Chassis		Premium Veneer Top Premium Veneer Chassis		High Pressure Laminate Top Veneer Chassis		Thermally Fused Laminate Top Thermally Fused Laminate Chassis	
2 Select Finish Click to view finishes	WAC WIC WHC WOC WEC WAM WCM WEW WGW WBW WSW	WNW WWP WNF(Natural Oak on Flat Cut) WSF(Salted Oak on Flat Cut) WMF(Mocha Oak on Flat Cut)	TBCO TBSW TSTV TSMV TSLV TOBW WMO WNO WSO		GAC +10% GIC GSLV GHC +10% GOC GWL GEC GAM GCM GEW GNW GSTV		MAC MOC MEC MGW MTW MSW MWL MNA	
3 Select Edge Click to view edges	Classic Flat Knife Ledge Waterfall		Flat Ledge		Classic Flat Knife Ledge Waterfall		Flat	
4 Select Hardware Click to view details	Hardware N/A		Hardware N/A		Hardware N/A		Hardware N/A	

Product Features

- Metal wire management column with grommet.
- Adjustable height from 29" to 47.5" with a maximum weight capacity of 350 lbs

Notes

- Unit to be used with bench credenza.
- Metal Shroud Standard in MFB (Black)
- Lift column Standard in MFB (Black)

Options

Modesty

- HM45: SilverLuma frame/frost insert (half modesty) - \$415
- MC51: Half veneer/laminate modesty - \$130

Grommets (Standard Location)

- Specify Color - \$50 ea.
- Black: TM30-C (Center)
 - Silver: TM31-C (Center)
 - Antique Brass: TM33-C (Center)

Grommets (Non-Standard Location)

- Provide drawing w/ Grommet Location and Specify Color - \$95 ea.
- Black: TM30-NS
 - Silver: TM31-NS
 - Antique Brass: TM33-NS

Central Park

Height Adjustable Runoff Desk
Workstation with Adjustable Column Box

[Click here to view statement of line](#)

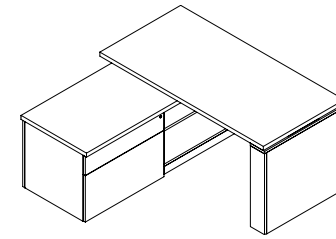

1 Select Model

w" x d" x h"	Weight
72 x 30 x 29-47.5	210
66 x 30 x 29-47.5	190
60 x 30 x 29-47.5	170
54 x 30 x 29-47.5	150
Right Pedestal	
72 x 30 x 29-47.5	210
66 x 30 x 29-47.5	190
60 x 30 x 29-47.5	170
54 x 30 x 29-47.5	150

Standard Veneer Top Standard Veneer Chassis		Premium Veneer Top Premium Veneer Chassis		High Pressure Laminate Top Veneer Chassis		Thermally Fused Laminate Top Thermally Fused Laminate Chassis	
CPC7230DR034W	5283	CPC7230DR034P	5811	CPC7230DR034G	5283	CPC7230DR034M	4340
CPC6630DR034W	5239	CPC6630DR034P	5763	CPC6630DR034G	5239	CPC6630DR034M	4309
CPC6030DR034W	5197	CPC6030DR034P	5716	CPC6030DR034G	5197	CPC6030DR034M	4278
CPC5430DR034W	5154	CPC5430DR034P	5670	CPC5430DR034G	5154	CPC5430DR034M	4248
CPC7230DR035W	5283	CPC7230DR035P	5811	CPC7230DR035G	5283	CPC7230DR035M	4340
CPC6630DR035W	5239	CPC6630DR035P	5763	CPC6630DR035G	5239	CPC6630DR035M	4309
CPC6030DR035W	5197	CPC6030DR035P	5716	CPC6030DR035G	5197	CPC6030DR035M	4278
CPC5430DR035W	5154	CPC5430DR035P	5670	CPC5430DR035G	5154	CPC5430DR035M	4248

Product Features

- Adjustable height from 29" to 47.5" with a maximum weight capacity of 350 lbs.
- Programmable height adjustable mechanism, motor includes 2 year warranty
- Standard 20" high suspended privacy panel
- Metal column with grommet for wire management

Notes

- Unit only used with 90 degrees bench credenza

Options

Accessories

- K31: Center drawer - \$205

Grommets (Standard Location)

Specify Color - \$50 ea.

- Black: TM30-C (Center)
- Silver: TM31-C (Center)
- Antique Brass: TM33-C (Center)

Grommets (Non-Standard Location)

Provide drawing w/ Grommet Location and Specify Color - \$95 ea.

- Black: TM30-NS
- Silver: TM31-NS
- Antique Brass: TM33-NS

2 Select Finish

[Click to view finishes](#)

WAC	WNW
WIC	WWP
WHC	WNF(Natural
WOC	Oak on Flat
WEC	Cut)
WAM	WSF(Salted
WCM	Oak on Flat
WEW	Cut)
WGW	WMF(Mocha
WBW	Oak on Flat
WSW	Cut)

TBCO
TBSW
TSTV
TSMV
TSLV
TOBW
WMO
WNO
WSO

GAC +10%
GIC GSLV
GHC +10%
GOC GWL
GEC
GAM
GCM
GEW
GNW
GSTV

MAC
MOC
MEC
MGW
MTW
MSW
MWL
MNA

3 Select Edge

[Click to view edges](#)

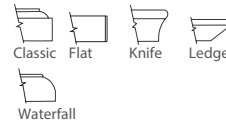
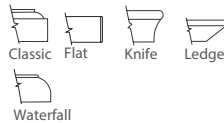

4 Select Hardware

[Click to view details](#)

See Intro Page
for Pull Options

See Intro Page
for Pull Options

See Intro Page
for Pull Options

See Intro Page
for Pull Options

Central Park

Runoff Desk
Shell Unit

[Click here to view statement of line](#)

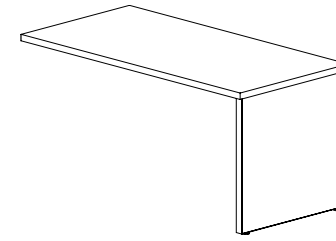

1 Select Model

w" x d" x h"	Weight
Left Pedestal	
72 x 30 x 29	155
66 x 30 x 29	145
60 x 30 x 29	135
54 x 30 x 29	125
Right Pedestal	
72 x 30 x 29	155
66 x 30 x 29	145
60 x 30 x 29	135
54 x 30 x 29	125

	Standard Veneer Top Standard Veneer Chassis		Premium Veneer Top Premium Veneer Chassis		High Pressure Laminate Top Veneer Chassis		Thermally Fused Laminate Top Thermally Fused Laminate Chassis	
WAC	CPC7230DR021W	2767	CPC7230DR021P	3044	CPC7230DR021G	2767	CPC7230DR021M	1642
WIC	CPC6630DR021W	2724	CPC6630DR021P	2997	CPC6630DR021G	2724	CPC6630DR021M	1617
WHC	CPC6030DR021W	2682	CPC6030DR021P	2950	CPC6030DR021G	2682	CPC6030DR021M	1592
WOC	CPC5430DR021W	2638	CPC5430DR021P	2902	CPC5430DR021G	2638	CPC5430DR021M	1568
WEC								
WAM	CPC7230DR022W	2767	CPC7230DR022P	3044	CPC7230DR022G	2767	CPC7230DR022M	1642
WCM	CPC6630DR022W	2724	CPC6630DR022P	2997	CPC6630DR022G	2724	CPC6630DR022M	1617
WEW	CPC6030DR022W	2682	CPC6030DR022P	2950	CPC6030DR022G	2682	CPC6030DR022M	1592
WGW	CPC5430DR022W	2638	CPC5430DR022P	2902	CPC5430DR022G	2638	CPC5430DR022M	1568
WBW								
WSW								
TBCO								
TBSW								
TSTV								
TSMV								
TSLV								
TOBW								
WMO								
WNO								
WSO								
GAC +10%								
GIC GSLV								
GHC +10%								
GOC GWL								
GEC								
GAM								
GCM								
GEW								
GNW								
GSTV								
MAC								
MOC								
MEC								
MGW								
MTW								
MSW								
MWL								
MNA								

2 Select Finish

[Click to view finishes](#)

WAC	WNW
WIC	WWP
WHC	WNF(Natural
WOC	Oak on Flat
WEC	Cut)
WAM	WSF(Salted
WCM	Oak on Flat
WEW	Cut)
WGW	WMF(Mocha
WBW	Oak on Flat
WSW	Cut)

3 Select Edge

[Click to view edges](#)

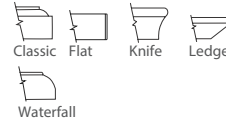
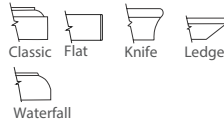

4 Select Hardware

[Click to view details](#)

Hardware
N/A

Hardware
N/A

Hardware
N/A

Hardware
N/A

Product Features

- No visible hardware
- Runoff Desk shell only available in 30" depth, it cannot be modified.

Notes

- Unit only for credenzas and bench credenzas
- See bench runoff supports when using bench credenzas

Options

Accessories

- K31: Center drawer - \$205

Grommets (Standard Location)

Specify Color - \$50 ea.

- Black: TM30-C (Center)
- Silver: TM31-C (Center)
- Antique Brass: TM33-C (Center)

Grommets (Non-Standard Location)

Provide drawing w/ Grommet Location and Specify Color - \$95 ea.

- Black: TM30-NS
- Silver: TM31-NS
- Antique Brass: TM33-NS

Modesty

- HM45L: Silverluma half modesty - \$515
- M45L: Silverluma full modesty - \$830
- ML51: Half Veneer/Laminate Modesty - \$185
- ML50: Full Veneer/Laminate Modesty - \$195

Central Park

Workstation Shells - Used Next to Single Pedestal or Shell Lift Desk
Open Back

[Click here to view statement of line](#)

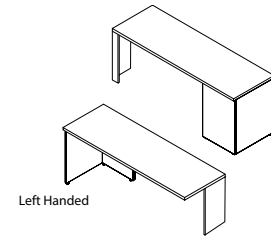

1 Select Model

Weight	w" x d" x h"	Left Handed Return Shell
110	72 x 24 x 29	
100	66 x 24 x 29	
95	60 x 24 x 29	
90	54 x 24 x 29	
85	48 x 24 x 29	
Right Handed Return Shell		
110	72 x 24 x 29	
100	66 x 24 x 29	
95	60 x 24 x 29	
90	54 x 24 x 29	
85	48 x 24 x 29	

Standard Veneer Top Standard Veneer Chassis	Premium Veneer Top Premium Veneer Chassis	High Pressure Laminate Top Veneer Chassis	Thermally Fused Laminate Top Thermally Fused Laminate Chassis
CPC7224RE691W 2271	CPC7224RE691P 2499	CPC7224RE691G 2271	CPC7224RE691M 1193
CPC6624RE691W 2177	CPC6624RE691P 2395	CPC6624RE691G 2177	CPC6624RE691M 1168
CPC6024RE691W 2080	CPC6024RE691P 2288	CPC6024RE691G 2080	CPC6024RE691M 1081
CPC5424RE691W 1982	CPC5424RE691P 2180	CPC5424RE691G 1982	CPC5424RE691M 1061
CPC4824RE691W 1877	CPC4824RE691P 2066	CPC4824RE691G 1877	CPC4824RE691M 1043
CPC7224RE693W 2271	CPC7224RE693P 2499	CPC7224RE693G 2271	CPC7224RE693M 1193
CPC6624RE693W 2177	CPC6624RE693P 2395	CPC6624RE693G 2177	CPC6624RE693M 1168
CPC6024RE693W 2080	CPC6024RE693P 2288	CPC6024RE693G 2080	CPC6024RE693M 1081
CPC5424RE693W 1982	CPC5424RE693P 2180	CPC5424RE693G 1982	CPC5424RE693M 1061
CPC4824RE693W 1877	CPC4824RE693P 2066	CPC4824RE693G 1877	CPC4824RE693M 1043

Product Features

- 4"H back rail - open back

Notes

- All units are standard w/ flush ends
- Grain Direction Runs Front To Back On All "W" Units and Up to 60" on "G" and "M" Units
- Grain Runs End To End On 66"/72" Sizes on "G" and "M" styles
- If grommet is added then unit will become handed
- Unit ships assembled

Options

Accessories

- K28: Articulating Keyboard w/ Mouse - \$390
- K31: Center drawer - \$205

Grommets (Standard Location)

Specify Color and Left/Right - \$50 ea.

- Black: TM30-R (Right), TM30-L (Left)
- Silver: TM31-R (Right), TM31-L (Left)
- Antique Brass: TM33-R (Right), TM33-L (Left)

Grommets (Non-Standard Location)

Provide drawing w/ Grommet Location and Specify Color - \$95 ea.

- Black: TM30-NS
- Silver: TM31-NS
- Antique Brass: TM33-NS

Modesty

- M34T-O: "W" "G" Style Drop Door Tech Modesty - \$310
- M34TM-O: "M" Style Drop Door Tech Modesty - \$235
- M37: "W" "G" Style Fixed Full Modesty - \$130
- M37M: "M" Style Fixed Full Modesty - \$80

2 Select Finish

[Click to view finishes](#)

WAC	WNW
WIC	WWP
WHC	WNF(Natural
WOC	Oak on Flat
WEC	Cut)
WAM	WSF(Salted
WCM	Oak on Flat
WEW	Cut)
WGW	WMF(Mocha
WBW	Oak on Flat
WSW	Cut)

TBCO
TBSW
TSTV
TSMV
TSLV
TOBW
WMO
WNO
WSO

GAC +10%
GIC GSLV
GHC +10%
GOC GWL
GEC
GAM
GCM
GEW
GNW
GSTV

MAC
MOC
MEC
MGW
MTW
MSW
MWL
MNA

3 Select Edge

[Click to view edges](#)

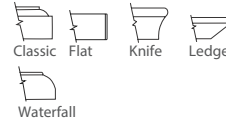
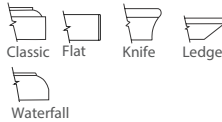

4 Select Hardware

[Click to view details](#)

Hardware
N/A

Hardware
N/A

Hardware
N/A

Hardware
N/A

Central Park

"L" Workstation Returns
 "L" Workstation Return - File/File

[Click here to view statement of line](#)

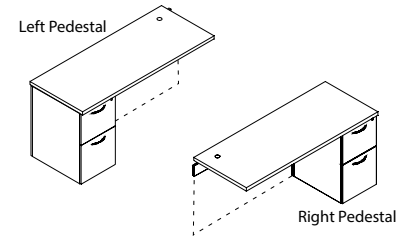

1 Select Model

Weight	w" x d" x h"
130	60 x 24 x 29
125	48 x 24 x 29
120	42 x 24 x 29
130	60 x 24 x 29
125	48 x 24 x 29
120	42 x 24 x 29

Standard Veneer Top Standard Veneer Chassis		Premium Veneer Top Premium Veneer Chassis		High Pressure Laminate Top Veneer Chassis		Thermally Fused Laminate Top Thermally Fused Laminate Chassis	
CPC6024RE222W	2751	CPC6024RE222P	3026	CPC6024RE222G	2751	CPC6024RE222M	1488
CPC4824RE222W	2602	CPC4824RE222P	2863	CPC4824RE222G	2602	CPC4824RE222M	1462
CPC4224RE222W	2533	CPC4224RE222P	2787	CPC4224RE222G	2533	CPC4224RE222M	1444
CPC6024RE223W	2751	CPC6024RE223P	3026	CPC6024RE223G	2751	CPC6024RE223M	1488
CPC4824RE223W	2602	CPC4824RE223P	2863	CPC4824RE223G	2602	CPC4824RE223M	1462
CPC4224RE223W	2533	CPC4224RE223P	2787	CPC4224RE223G	2533	CPC4224RE223M	1444

Product Features

- 1 Standard grommet - matches pull finish or specify black TM30, silver TM31 or antique brass TM33
- 4"H back rail - open back
- "W" & "G" SKUs feature soft close suspensions, "M" SKUs feature ball bearing suspensions. Both suspensions are full extension.

Notes

- All units are standard w/ flush ends
- Grain Direction Runs Front To Back On All "W" Units and Up to 60" on "G" and "M" Units

Options

Accessories

- K28: Articulating Keyboard w/ Mouse - \$390

Drawer

- P6: Modify File/File to Box/Box/File - \$55 per pedestal
- P33: Wood Drawer Upgrade - \$45 per drawer
- P40W: extra Box/Box/File or File/File to Kneespace - \$910 (W,G)
- P40M: extra Box/Box/File or File/File to Kneespace - \$720 (M)
- WPD3061: Designer White - \$80 per pedestal

Grommets (Non-Standard Location)

- Provide drawing w/ Grommet Location and Specify Color - \$95 ea.
- Black: TM30-NS
- Silver: TM31-NS
- Antique Brass: TM33-NS

Modesty

- M34T-O: "W" "G" Style Drop Door Tech Modesty - \$310
- M34TM-O: "M" Style Drop Door Tech Modesty - \$235
- M37: "W" "G" Style Fixed Full Modesty - \$130
- M37M: "M" Style Fixed Full Modesty - \$80

2 Select Finish

[Click to view finishes](#)

WAC	WNW	TBCO	GAC	+10%	MAC
WIC	WWP	TBSW	GIC	GSLV	MOC
WHC	WNF(Natural	TSTV	GHC	+10%	MEC
WOC	Oak on Flat	TSMV	GOC	GWL	MGW
WEC	Cut)	TSLV	GEC		MTW
WAM	WSF(Salted	TOBW	GAM		MSW
WCM	Oak on Flat	WMO	GCM		MWL
WEW	Cut)	WNO	GEW		MNA
WGW	WMF(Mocha	WSO	GNW		
WBW	Oak on Flat		GSTV		
WSW	Cut)				

3 Select Edge

[Click to view edges](#)



4 Select Hardware

[Click to view details](#)

See Intro Page
for Pull Options

See Intro Page
for Pull Options

See Intro Page
for Pull Options

See Intro Page
for Pull Options

Central Park

"L" Workstation Returns
 "L" Workstation Return - Lateral File

[Click here to view statement of line](#)

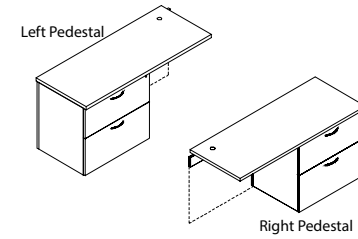

1 Select Model

w" x d" x h"
 Left Pedestal
 72 x 24 x 29
 66 x 24 x 29
 60 x 24 x 29
 48 x 24 x 29
 Right Pedestal
 72 x 24 x 29
 66 x 24 x 29
 60 x 24 x 29
 48 x 24 x 29

Weight	Standard Veneer Top Standard Veneer Chassis		Premium Veneer Top Premium Veneer Chassis		High Pressure Laminate Top Veneer Chassis		Thermally Fused Laminate Top Thermally Fused Laminate Chassis	
200	CPC7224RE206W	3586	CPC7224RE206P	3944	CPC7224RE206G	3586	CPC7224RE206M	1737
190	CPC6624RE206W	3411	CPC6624RE206P	3752	CPC6624RE206G	3411	CPC6624RE206M	1699
175	CPC6024RE206W	3252	CPC6024RE206P	3578	CPC6024RE206G	3252	CPC6024RE206M	1617
165	CPC4824RE206W	3085	CPC4824RE206P	3394	CPC4824RE206G	3085	CPC4824RE206M	1581
200	CPC7224RE208W	3586	CPC7224RE208P	3944	CPC7224RE208G	3586	CPC7224RE208M	1737
190	CPC6624RE208W	3411	CPC6624RE208P	3752	CPC6624RE208G	3411	CPC6624RE208M	1699
175	CPC6024RE208W	3252	CPC6024RE208P	3578	CPC6024RE208G	3252	CPC6024RE208M	1617
165	CPC4824RE208W	3085	CPC4824RE208P	3394	CPC4824RE208G	3085	CPC4824RE208M	1581

Product Features

- 1 Standard grommet - matches pull finish or specify black TM30, silver TM31 or antique brass TM33
- 4"H back rail - open back
- Legal/Double letter filing
- Features ball bearing suspensions, suspensions are full extension

Notes

- All units are standard w/ flush ends
- Grain Direction Runs Front To Back On All "W" Units and Up to 60" on "G" and "M" Units
- Grain Runs End To End On 66"/72" Sizes on "G" and "M" styles
- Keyboard N/A on 48" return

Options

Accessories

- K28: Articulating Keyboard w/ Mouse - \$390

Drawer

- P33: Wood Drawer Upgrade - \$45 per drawer
- P40W: extra Box/Box/File or File/File to Kneespace - \$910 (N/A on 48") (W,G)
- P40M: extra Box/Box/File or File/File to Kneespace - \$720 (N/A on 48") (M)
- WPD3061: Designer White - \$160 per lateral pedestal

Grommets (Non-Standard Location)

- Provide drawing w/ Grommet Location and Specify Color - \$95 ea.
- Black: TM30-NS
- Silver: TM31-NS
- Antique Brass: TM33-NS

Modesty

- M34T-O: "W" "G" Style Drop Door Tech Modesty - \$310
- M34TM-O: "M" Style Drop Door Tech Modesty - \$235
- M37: "W" "G" Style Fixed Full Modesty - \$130
- M37M: "M" Style Fixed Full Modesty - \$80

2 Select Finish

[Click to view finishes](#)

WAC	WNW
WIC	WWP
WHC	WNF(Natural
WOC	Oak on Flat
WEC	Cut)
WAM	WSF(Salted
WCM	Oak on Flat
WEW	Cut)
WGW	WMF(Mocha
WBW	Oak on Flat
WSW	Cut)

TBCO
 TBSW
 TSTV
 TSMV
 TSLV
 TOBW
 WMO
 WNO
 WSO

GAC +10%
 GIC GSLV
 GHC +10%
 GOC GWL
 GEC
 GAM
 GCM
 GEW
 GNW
 GSTV

MAC
 MOC
 MEC
 MGW
 MTW
 MSW
 MWL
 MNA

3 Select Edge

[Click to view edges](#)

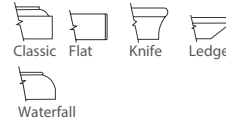
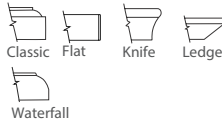

4 Select Hardware

[Click to view details](#)

[See Intro Page for Pull Options](#)

[See Intro Page for Pull Options](#)

[See Intro Page for Pull Options](#)

[See Intro Page for Pull Options](#)

Central Park

"L" Workstation Returns
 "L" Workstation Return - Multi-File

[Click here to view statement of line](#)

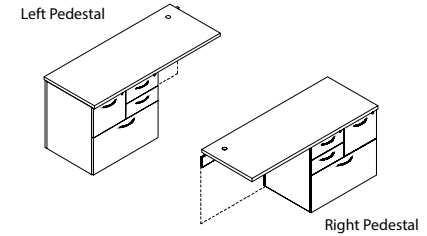

1 Select Model

w" x d" x h"

Weight	Model	Price
Left Pedestal		
72 x 24 x 29		200
66 x 24 x 29		190
60 x 24 x 29		175
48 x 24 x 29		165
Right Pedestal		
72 x 24 x 29		200
66 x 24 x 29		190
60 x 24 x 29		175
48 x 24 x 29		165

	Standard Veneer Top Standard Veneer Chassis		Premium Veneer Top Premium Veneer Chassis		High Pressure Laminate Top Veneer Chassis		Thermally Fused Laminate Top Thermally Fused Laminate Chassis	
CPC7224RE197W	3795	CPC7224RE197P	4175	CPC7224RE197G	3795	CPC7224RE197M	1828	
CPC6624RE197W	3629	CPC6624RE197P	3992	CPC6624RE197G	3629	CPC6624RE197M	1791	
CPC6024RE197W	3471	CPC6024RE197P	3819	CPC6024RE197G	3471	CPC6024RE197M	1737	
CPC4824RE197W	3296	CPC4824RE197P	3626	CPC4824RE197G	3296	CPC4824RE197M	1675	
CPC7224RE198W	3795	CPC7224RE198P	4175	CPC7224RE198G	3795	CPC7224RE198M	1828	
CPC6624RE198W	3629	CPC6624RE198P	3992	CPC6624RE198G	3629	CPC6624RE198M	1791	
CPC6024RE198W	3471	CPC6024RE198P	3819	CPC6024RE198G	3471	CPC6024RE198M	1737	
CPC4824RE198W	3296	CPC4824RE198P	3626	CPC4824RE198G	3296	CPC4824RE198M	1675	

Product Features

- 1 Standard grommet - matches pull finish or specify black TM30, silver TM31 or antique brass TM33
- 4"H back rail - open back
- Full extension drawers - locking
- Legal/Double letter filing
- "W" & "G" SKUs feature soft close suspensions(Lateral Drawers feature ball bearing suspensions), "M" SKUs feature ball bearing suspensions. Both suspensions are full extension.

Notes

- All units are standard w/ flush ends
- Grain Direction Runs Front To Back On All "W" Units and Up to 60" on "G" and "M" Units
- Grain Runs End To End On 66"/ 72" Sizes on "G" and "M" styles
- Keyboard N/A on 48" return

Options

Accessories

- K28: Articulating Keyboard w/ Mouse - \$390

Drawer

- P33: Wood Drawer Upgrade - \$45 per drawer
- P40W: extra Box/Box/File or File/File to Kneespace - \$910 (N/A on 48")
- P40M: extra Box/Box/File or File/File to Kneespace - \$720 (N/A on 48")
- WPD3061: Designer White - \$80 per pedestal

Grommets (Non-Standard Location)

- Provide drawing w/ Grommet Location and Specify Color - \$95 ea.
- Black: TM30-NS
- Silver: TM31-NS
- Antique Brass: TM33-NS

Modesty

- M34T-O: "W" "G" Style Drop Door Tech Modesty - \$310
- M34TM-O: "M" Style Drop Door Tech Modesty - \$235
- M37: "W" "G" Style Fixed Full Modesty - \$130
- M37M: "M" Style Fixed Full Modesty - \$80

2 Select Finish

[Click to view finishes](#)

WAC	WNW
WIC	WWP
WHC	WNF(Natural
WOC	Oak on Flat
WEC	Cut)
WAM	WSF(Salted
WCM	Oak on Flat
WEW	Cut)
WGW	WMF(Mocha
WBW	Oak on Flat
WSW	Cut)

TBCO
TBSW
TSTV
TSMV
TSLV
TOBW
WMO
WNO
WSO

GAC +10%
GIC GSLV
GHC +10%
GOC GWL
GEC
GAM
GCM
GEW
GNW
GSTV

MAC
MOC
MEC
MGW
MTW
MSW
MWL
MNA

3 Select Edge

[Click to view edges](#)

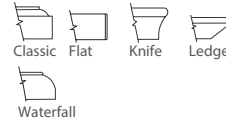
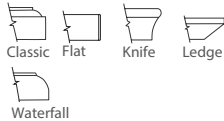

4 Select Hardware

[Click to view details](#)

[See Intro Page for Pull Options](#)

[See Intro Page for Pull Options](#)

[See Intro Page for Pull Options](#)

[See Intro Page for Pull Options](#)

Central Park

"L" Workstation Returns
 "L" Workstation Return - File/File

[Click here to view statement of line](#)

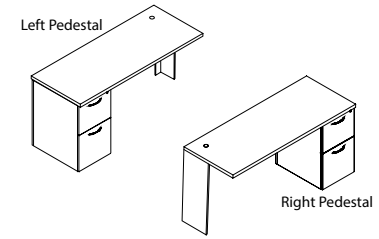

1 Select Model

w" x d" x h"	Weight
Left Pedestal	
60 x 24 x 29	130
48 x 24 x 29	125
42 x 24 x 29	120
Right Pedestal	
60 x 24 x 29	130
48 x 24 x 29	125
42 x 24 x 29	120

	Standard Veneer Top Standard Veneer Chassis		Premium Veneer Top Premium Veneer Chassis		High Pressure Laminate Top Veneer Chassis		Thermally Fused Laminate Top Thermally Fused Laminate Chassis	
	CPC6024RE694W	2941	CPC6024RE694P	3236	CPC6024RE694G	2941	CPC6024RE694M	1616
	CPC4824RE694W	2793	CPC4824RE694P	3073	CPC4824RE694G	2793	CPC4824RE694M	1590
	CPC4224RE694W	2723	CPC4224RE694P	2996	CPC4224RE694G	2723	CPC4224RE694M	1570
	CPC6024RE695W	2941	CPC6024RE695P	3236	CPC6024RE695G	2941	CPC6024RE695M	1616
	CPC4824RE695W	2793	CPC4824RE695P	3073	CPC4824RE695G	2793	CPC4824RE695M	1590
	CPC4224RE695W	2723	CPC4224RE695P	2996	CPC4224RE695G	2723	CPC4224RE695M	1570

Product Features

- 1 Standard grommet - matches pull finish or specify black TM30, silver TM31 or antique brass TM33
- 4"H back rail - open back
- "W" & "G" SKUs feature soft close suspensions, "M" SKUs feature ball bearing suspensions. Both suspensions are full extension.

Notes

- All units are standard w/ flush ends
- Grain Direction Runs Front To Back On All "W" Units and Up to 60" on "G" and "M" Units
- Unit is to be used with height adjustable desk

Options

Accessories

- K28: Articulating Keyboard w/ Mouse - \$390

Drawer

- P6: Modify File/File to Box/Box/File - \$55 per pedestal
- P33: Wood Drawer Upgrade - \$45 per drawer
- P40W: extra Box/Box/File or File/File to Kneespace - \$910 (W,G)
- P40M: extra Box/Box/File or File/File to Kneespace - \$720 (M)
- WPD3061: Designer White - \$80 per pedestal

Grommets (Non-Standard Location)

- Provide drawing w/ Grommet Location and Specify Color - \$95 ea.
- Black: TM30-NS
- Silver: TM31-NS
- Antique Brass: TM33-NS

Modesty

- M34T-O: "W" "G" Style Drop Door Tech Modesty - \$310
- M34TM-O: "M" Style Drop Door Tech Modesty - \$235
- M37: "W" "G" Style Fixed Full Modesty - \$130
- M37M: "M" Style Fixed Full Modesty - \$80

2 Select Finish

[Click to view finishes](#)

WAC	WNW	TBCO
WIC	WWP	TBSW
WHC	WNF(Natural	TSTV
WOC	Oak on Flat	TSMV
WEC	Cut)	TSLV
WAM	WSF(Salted	TOBW
WCM	Oak on Flat	WMO
WEW	Cut)	WNO
WGW	WMF(Mocha	WSO
WBW	Oak on Flat	
WSW	Cut)	

GAC	+10%	MAC
GIC	GSLV	MOC
GHC	+10%	MEC
GOC	GWL	MGW
GEC		MTW
GAM		MSW
GCM		MWL
GEW		MNA
GNW		
GSTV		

3 Select Edge

[Click to view edges](#)

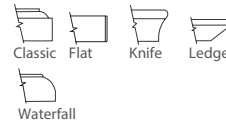
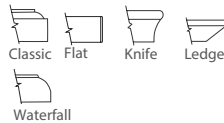

4 Select Hardware

[Click to view details](#)

See Intro Page
for Pull Options

See Intro Page
for Pull Options

See Intro Page
for Pull Options

See Intro Page
for Pull Options

Central Park

"L" Workstation Returns
 "L" Workstation Return - Lateral File

[Click here to view statement of line](#)

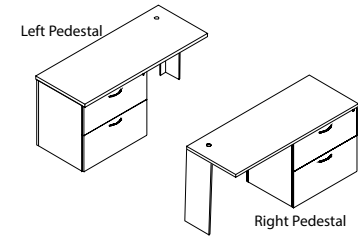

1 Select Model

w" x d" x h"
 Left Pedestal
 72 x 24 x 29
 66 x 24 x 29
 60 x 24 x 29
 48 x 24 x 29
 Right Pedestal
 72 x 24 x 29
 66 x 24 x 29
 60 x 24 x 29
 48 x 24 x 29

Weight	Standard Veneer Top Standard Veneer Chassis	Premium Veneer Top Premium Veneer Chassis	High Pressure Laminate Top Veneer Chassis	Thermally Fused Laminate Top Thermally Fused Laminate Chassis
200	CPC7224RE696W 3777	CPC7224RE696P 4156	CPC7224RE696G 3777	CPC7224RE696M 1864
190	CPC6624RE696W 3602	CPC6624RE696P 3963	CPC6624RE696G 3602	CPC6624RE696M 1826
175	CPC6024RE696W 3443	CPC6024RE696P 3787	CPC6024RE696G 3443	CPC6024RE696M 1744
165	CPC4824RE696W 3277	CPC4824RE696P 3605	CPC4824RE696G 3277	CPC4824RE696M 1709
200	CPC7224RE697W 3777	CPC7224RE697P 4156	CPC7224RE697G 3777	CPC7224RE697M 1864
190	CPC6624RE697W 3602	CPC6624RE697P 3963	CPC6624RE697G 3602	CPC6624RE697M 1826
175	CPC6024RE697W 3443	CPC6024RE697P 3787	CPC6024RE697G 3443	CPC6024RE697M 1744
165	CPC4824RE697W 3277	CPC4824RE697P 3605	CPC4824RE697G 3277	CPC4824RE697M 1709

Product Features

- 1 Standard grommet - matches pull finish or specify black TM30, silver TM31 or antique brass TM33
- 4"H back rail - open back
- Legal/Double letter filing
- Features ball bearing suspensions, suspensions are full extension

Notes

- All units are standard w/ flush ends
- Grain Direction Runs Front To Back On All "W" Units and Up to 60" on "G" and "M" Units
- Grain Runs End To End On 66"/72" Sizes on "G" and "M" styles
- Keyboard N/A on 48" return
- Unit is to be used with height adjustable desk

Options

Accessories

- K28: Articulating Keyboard w/ Mouse - \$390

Drawer

- P33: Wood Drawer Upgrade - \$45 per drawer
- P40W: extra Box/Box/File or File/File to Kneespace - \$910 (N/A on 48") (W,G)
- P40M: extra Box/Box/File or File/File to Kneespace - \$720 (N/A on 48") (M)
- WPD3061: Designer White - \$160 per lateral pedestal

Grommets (Non-Standard Location)

- Provide drawing w/ Grommet Location and Specify Color - \$95 ea.
- Black: TM30-NS
- Silver: TM31-NS
- Antique Brass: TM33-NS

Modesty

- M34T-O: "W" "G" Style Drop Door Tech Modesty - \$310
- M34TM-O: "M" Style Drop Door Tech Modesty - \$235
- M37: "W" "G" Style Fixed Full Modesty - \$130
- M37M: "M" Style Fixed Full Modesty - \$80

2 Select Finish

[Click to view finishes](#)

WAC	WNW
WIC	WWP
WHC	WNF(Natural
WOC	Oak on Flat
WEC	Cut)
WAM	WSF(Salted
WCM	Oak on Flat
WEW	Cut)
WGW	WMF(Mocha
WBW	Oak on Flat
WSW	Cut)

TBCO
 TBSW
 TSTV
 TSMV
 TSLV
 TOBW
 WMO
 WNO
 WSO

GAC +10%
 GIC GSLV
 GHC +10%
 GOC GWL
 GEC
 GAM
 GCM
 GEW
 GNW
 GSTV

MAC
 MOC
 MEC
 MGW
 MTW
 MSW
 MWL
 MNA

3 Select Edge

[Click to view edges](#)

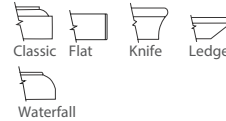
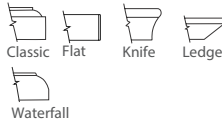

4 Select Hardware

[Click to view details](#)

[See Intro Page for Pull Options](#)

[See Intro Page for Pull Options](#)

[See Intro Page for Pull Options](#)

[See Intro Page for Pull Options](#)

Central Park

"L" Workstation Returns
 "L" Workstation Return - Multi-File

[Click here to view statement of line](#)

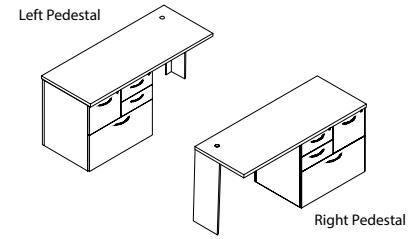

1 Select Model

w" x d" x h"	Weight
Left Pedestal	
72 x 24 x 29	200
66 x 24 x 29	190
60 x 24 x 29	175
48 x 24 x 29	165
Right Pedestal	
72 x 24 x 29	200
66 x 24 x 29	190
60 x 24 x 29	175
48 x 24 x 29	165

Standard Veneer Top Standard Veneer Chassis		Premium Veneer Top Premium Veneer Chassis		High Pressure Laminate Top Veneer Chassis		Thermally Fused Laminate Top Thermally Fused Laminate Chassis	
CPC7224RE698W	3986	CPC7224RE698P	4384	CPC7224RE698G	3986	CPC7224RE698M	1956
CPC6624RE698W	3821	CPC6624RE698P	4204	CPC6624RE698G	3821	CPC6624RE698M	1920
CPC6024RE698W	3662	CPC6024RE698P	4028	CPC6024RE698G	3662	CPC6024RE698M	1864
CPC4824RE698W	3487	CPC4824RE698P	3836	CPC4824RE698G	3487	CPC4824RE698M	1802
CPC7224RE699W	3986	CPC7224RE699P	4384	CPC7224RE699G	3986	CPC7224RE699M	1956
CPC6624RE699W	3821	CPC6624RE699P	4204	CPC6624RE699G	3821	CPC6624RE699M	1920
CPC6024RE699W	3662	CPC6024RE699P	4028	CPC6024RE699G	3662	CPC6024RE699M	1864
CPC4824RE699W	3487	CPC4824RE699P	3836	CPC4824RE699G	3487	CPC4824RE699M	1802

Product Features

- 1 Standard grommet - matches pull finish or specify black TM30, silver TM31 or antique brass TM33
- 4"H back rail - open back
- Legal/Double letter filing
- "W" & "G" Box and File Drawers feature soft close suspensions (Lateral Drawers Feature ball bearing suspensions), "M" SKUs feature ball bearing suspensions. Both suspensions are full extension.

Notes

- All units are standard w/ flush ends
- Grain Direction Runs Front To Back On All "W" Units and Up to 60" on "G" and "M" Units
- Grain Runs End To End On 66"/ 72" Sizes on "G" and "M" styles
- Keyboard N/A on 48" return
- Unit is to be used with height adjustable desk

Options

Accessories

- K28: Articulating Keyboard w/ Mouse - \$390

Drawer

- P33: Wood Drawer Upgrade - \$45 per drawer
- P40W: extra Box/Box/File or File/File to Kneespace - \$910 (N/A on 48")
- P40M: extra Box/Box/File or File/File to Kneespace - \$720 (N/A on 48")
- WPD3061: Designer White - \$80 per pedestal

Grommets (Non-Standard Location)

- Provide drawing w/ Grommet Location and Specify Color - \$95 ea.
- Black: TM30-NS
- Silver: TM31-NS
- Antique Brass: TM33-NS

Modesty

- M34T-O: "W" "G" Style Drop Door Tech Modesty - \$310
- M34TM-O: "M" Style Drop Door Tech Modesty - \$235
- M37: "W" "G" Style Fixed Full Modesty - \$130
- M37M: "M" Style Fixed Full Modesty - \$80

2 Select Finish

[Click to view finishes](#)

WAC	WNW
WIC	WWP
WHC	WNF(Natural
WOC	Oak on Flat
WEC	Cut)
WAM	WSF(Salted
WCM	Oak on Flat
WEW	Cut)
WGW	WMF(Mocha
WBW	Oak on Flat
WSW	Cut)

TBCO
TBSW
TSTV
TSMV
TSLV
TOBW
WMO
WNO
WSO

GAC +10%
GIC GSLV
GHC +10%
GOC GWL
GEC
GAM
GCM
GEW
GNW
GSTV

MAC
MOC
MEC
MGW
MTW
MSW
MWL
MNA

3 Select Edge

[Click to view edges](#)

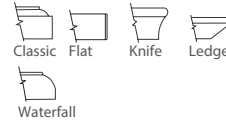
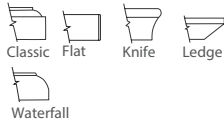

4 Select Hardware

[Click to view details](#)

[See Intro Page for Pull Options](#)

[See Intro Page for Pull Options](#)

[See Intro Page for Pull Options](#)

[See Intro Page for Pull Options](#)

Central Park

Conference Runoff Desk
Height Adjustable Bench Credenza Conference Runoff Desk

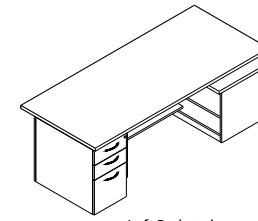

Left Pedestal

[Click here to view statement of line](#)

1 Select Model

w" x d" x h"	Weight
84 x 36 x 29	425
72 x 36 x 29	405
72 x 30 x 29	375
84 x 36 x 29	425
72 x 36 x 29	405
72 x 30 x 29	375

	Standard Veneer Top		Premium Veneer Top		High Pressure Laminate Top		Thermally Fused Laminate Top	
Left Pedestal	CPC8436DR723W	11355	CPC8436DR723P	12491	CPC8436DR723G	11355	CPC8436DR723M	8743
72 x 36 x 29	CPC7236DR723W	10672	CPC7236DR723P	11739	CPC7236DR723G	10672	CPC7236DR723M	8217
72 x 30 x 29	CPC7230DR723W	10270	CPC7230DR723P	11298	CPC7230DR723G	10270	CPC7230DR723M	8113
Right Pedestal	CPC8436DR722W	11355	CPC8436DR722P	12491	CPC8436DR722G	11355	CPC8436DR722M	8743
84 x 36 x 29	CPC7236DR722W	10672	CPC7236DR722P	11739	CPC7236DR722G	10672	CPC7236DR722M	8217
72 x 30 x 29	CPC7230DR722W	10270	CPC7230DR722P	11298	CPC7230DR722G	10270	CPC7230DR722M	8113

Product Features

- Adjustable height from 29" to 47.5" with a maximum weight capacity of 350 lbs
- Lift available in MFS Silver (standard) or MFB Black (optional)
- Metal parts include 5 year warranty
- Programmable height adjustable mechanism, motor includes 2 year warranty
- Box/Box/File
- Legal/letter filing
- "W" & "G" SKUs feature soft close suspensions, "M" SKUs feature ball bearing suspensions. Both suspensions are full extension.
- Flush front chassis (recessed 6")
- Privacy surround panels with concealed wire management box and pole

Notes

- For use with 24" deep benches (23" height)
- Ships KD in 3 boxes

Options

Accessories

- K28: Articulating Keyboard w/ Mouse - \$390
- K31: Center drawer - \$205

Drawer

- P6: Modify Box/Box/File to File/File - \$55 per pedestal
- P33: Wood Drawer Upgrade - \$45 per drawer
- WPD3061: Designer White painted drawer fronts - \$80 per pedestal front

Grommets (Standard Location)

- Specify Color and Left/Right - \$50 ea.
- Black: TM30-R (Right), TM30-L (Left)
 - Silver: TM31-R (Right), TM31-L (Left)
 - Antique Brass: TM33-R (Right), TM33-L (Left)

Grommets (Non-Standard Location)

Provide drawing w/ Grommet Location and Specify Color - \$95 ea.

- Black: TM30-NS
- Silver: TM31-NS
- Antique Brass: TM33-NS

Wire Management

- LWMB: Lift wire management box with flip down door - \$365
- Power strip with five outlets and 12' cord, mesh wire cover, 6" deep black box

2 Select Finish

[Click to view finishes](#)

WAC	WNW
WIC	WWP
WHC	WNF(Natural
WOC	Oak on Flat
WEC	Cut)
WAM	WSF(Salted
WCM	Oak on Flat
WEW	Cut)
WGW	WMF(Mocha
WBW	Oak on Flat
WSW	Cut)

TBCO
TBSW
TSTV
TSMV
TSLV
TOBW
WMO
WNO
WSO

GAC +10%
GIC GSLV
GHC +10%
GOC GWL
GEC
GAM
GCM
GEW
GNW
GSTV

MAC
MOC
MEC
MGW
MTW
MSW
MWL
MNA

3 Select Edge

[Click to view edges](#)

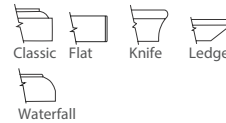
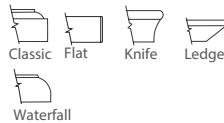

4 Select Hardware

[Click to view details](#)

[See Intro Page for Pull Options](#)

[See Intro Page for Pull Options](#)

[See Intro Page for Pull Options](#)

[See Intro Page for Pull Options](#)

Central Park

Bridges
Open Back With Half End Panel

[Click here to view statement of line](#)

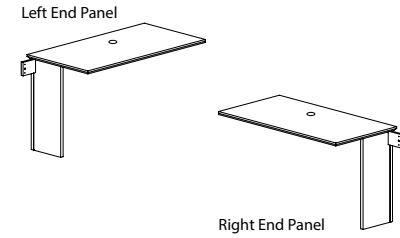

1 Select Model

w" x d" x h"	Weight
Left End Panel	
48 x 24 x 29	70
42 x 24 x 29	65
36 x 24 x 29	60
Right End Panel	
48 x 24 x 29	70
42 x 24 x 29	65
36 x 24 x 29	60

	Standard Veneer Top Standard Veneer Chassis	Premium Veneer Top Premium Veneer Chassis	High Pressure Laminate Top Veneer Chassis	Thermally Fused Laminate Top Thermally Fused Laminate Chassis
Standard Veneer Top	CPC4824BR149W 959	CPC4824BR149P 1055	CPC4824BR149G 959	CPC4824BR149M 704
Premium Veneer Top	CPC4224BR149W 915	CPC4224BR149P 1007	CPC4224BR149G 915	CPC4224BR149M 676
High Pressure Laminate Top	CPC3624BR149W 904	CPC3624BR149P 995	CPC3624BR149G 904	CPC3624BR149M 649
Thermally Fused Laminate Top	CPC4824BR148W 959	CPC4824BR148P 1055	CPC4824BR148G 959	CPC4824BR148M 704
Standard Veneer Top	CPC4224BR148W 915	CPC4224BR148P 1007	CPC4224BR148G 915	CPC4224BR148M 676
Premium Veneer Top	CPC3624BR148W 904	CPC3624BR148P 995	CPC3624BR148G 904	CPC3624BR148M 649

Product Features

- 1 Standard grommet - matches pull finish or specify black TM30, silver TM31 or antique brass TM33
- Unit to be used with height adjustable desk

Options

Accessories

- K28: Articulating Keyboard w/ Mouse - \$390
- K31: Center drawer - \$205

Grommets (Non-Standard Location)

- Provide drawing w/ Grommet Location and Specify Color - \$95 ea.
- Black: TM30-NS
- Silver: TM31-NS
- Antique Brass: TM33-NS

Modesty

- M34T-O: "W" "G" Style Drop Door Tech Modesty - \$310
- M34TM-O: "M" Style Drop Door Tech Modesty - \$235
- M37: "W" "G" Style Fixed Full Modesty - \$130
- M37M: "M" Style Fixed Full Modesty - \$80

2 Select Finish

[Click to view finishes](#)

WAC	WNW
WIC	WWP
WHC	WNF(Natural
WOC	Oak on Flat
WEC	Cut)
WAM	WSF(Salted
WCM	Oak on Flat
WEW	Cut)
WGW	WMF(Mocha
WBW	Oak on Flat
WSW	Cut)

TBCO
TBSW
TSTV
TSMV
TSLV
TOBW
WMO
WNO
WSO

GAC	+10%
GIC	GSLV
GHC	+10%
GOC	GWL
GEC	
GAM	
GCM	
GEW	
GNW	
GSTV	

MAC
MOC
MEC
MGW
MTW
MSW
MWL
MNA

3 Select Edge

[Click to view edges](#)

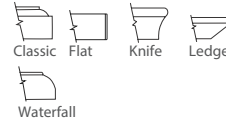
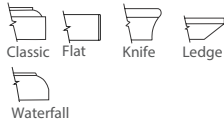

4 Select Hardware

[Click to view details](#)

Hardware
N/A

Hardware
N/A

Hardware
N/A

Hardware
N/A

Central Park

Bridges

Open Back With 4"H Wire Management Rail

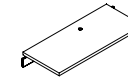

[Click here to view statement of line](#)

1 Select Model

w" x d" x h"
24"D

Weight	Standard Veneer Top Standard Veneer Chassis	Premium Veneer Top Premium Veneer Chassis	High Pressure Laminate Top Veneer Chassis	Thermally Fused Laminate Top Thermally Fused Laminate Chassis
48 x 24 x 29	55 CPC4824BR151W 768	CPC4824BR151P 845	CPC4824BR151G 768	CPC4824BR151M 576
42 x 24 x 29	50 CPC4224BR151W 723	CPC4224BR151P 796	CPC4224BR151G 723	CPC4224BR151M 549
36 x 24 x 29	45 CPC3624BR151W 688	CPC3624BR151P 758	CPC3624BR151G 688	CPC3624BR151M 522

2 Select Finish

[Click to view finishes](#)

WAC	WNW
WIC	WWP
WHC	WNF(Natural
WOC	Oak on Flat
WEC	Cut)
WAM	WSF(Salted
WCM	Oak on Flat
WEW	Cut)
WGW	WMF(Mocha
WBW	Oak on Flat
WSW	Cut)

TBCO
TBSW
TSTV
TSMV
TSLV
TOBW
WMO
WNO
WSO

GAC +10%
GIC GSLV
GHC +10%
GOC GWL
GEC
GAM
GCM
GEW
GNW
GSTV

MAC
MOC
MEC
MGW
MTW
MSW
MWL
MNA

3 Select Edge

[Click to view edges](#)

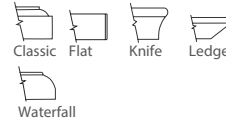
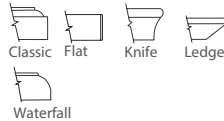

4 Select Hardware

[Click to view details](#)

Hardware
N/A

Hardware
N/A

Hardware
N/A

Hardware
N/A

Product Features

- 1 Standard grommet - matches pull finish or specify black TM30, silver TM31 or antique brass TM33

Options

Accessories

- K28: Articulating Keyboard w/ Mouse - \$390
- K31: Center drawer - \$205

Curved Bridge

- CBT1: Modify to Curved Bridge - \$55

Grommets (Non-Standard Location)

Provide drawing w/ Grommet Location and Specify Color - \$95 ea.

- Black: TM30-NS
- Silver: TM31-NS
- Antique Brass: TM33-NS

Modesty

- M34T-O: "W" "G" Style Drop Door Tech Modesty - \$310
- M34TM-O: "M" Style Drop Door Tech Modesty - \$235
- M37: "W" "G" Style Fixed Full Modesty - \$130
- M37M: "M" Style Fixed Full Modesty - \$80

Central Park

Full Pedestal Credenzas
File Storage Credenza

[Click here to view statement of line](#)

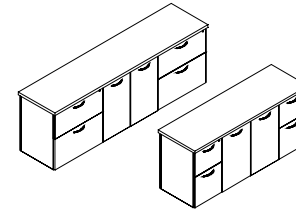

1 Select Model

w" x d" x h" Weight

Lateral File Storage Credenza		
93 x 24 x 29	320	
87 x 24 x 29	310	
File/ File Storage Credenza		
70 x 24 x 29	270	
64 x 24 x 29	255	
58 x 24 x 29	240	

	Standard Veneer Top Standard Veneer Chassis	Premium Veneer Top Premium Veneer Chassis	High Pressure Laminate Top Veneer Chassis	Thermally Fused Laminate Top Thermally Fused Laminate Chassis
	CPC9324CA651W 5924	CPC9324CA651P 6517	CPC9324CA651G 5924	CPC9324CA651M 3270
	CPC8724CA651W 5553	CPC8724CA651P 6109	CPC8724CA651G 5553	CPC8724CA651M 3197
	CPC7024CA050W 4208	CPC7024CA050P 4629	CPC7024CA050G 4208	CPC7024CA050M 2481
	CPC6424CA050W 3802	CPC6424CA050P 4183	CPC6424CA050G 3802	CPC6424CA050M 2452
	CPC5824CA050W 3752	CPC5824CA050P 4128	CPC5824CA050G 3752	CPC5824CA050M 2419
2 Select Finish Click to view finishes	WAC WIC WHC WOC WEC WAM WCM WEW WGW WBW WSW WNW WWP WNF(Natural Oak on Flat Cut) WSF(Salted Oak on Flat Cut) WMF(Mocha Oak on Flat Cut)	TBCO TBSW TSTV TSMV TSLV TOBW WMO WNO WSO	GAC +10% GIC GSLV GHC +10% GOC GWL GEC GAM GCM GEW GNW GSTV	MAC MOC MEC MGW MTW MSW MWL MNA
3 Select Edge Click to view edges				
4 Select Hardware Click to view details	See Intro Page for Pull Options	See Intro Page for Pull Options	See Intro Page for Pull Options	See Intro Page for Pull Options

Product Features

- Black adjustable shelf behind door set ("W", "P" & "G" styles)
- File/File
- "M" Styles have matching "M" Finish Shelf
- Lateral File anti-tilt
- "W" & "G" SKUs feature soft close suspensions(Lateral Drawers feature ball bearing suspensions), "M" SKUs feature ball bearing suspensions. Both suspensions are full extension.

Notes

- All units are standard w/ flush ends
- Unit has black back panel and is not designed for Open Plan use. Select OPB Option for Open Plan application

Options

Door

- D2: Wood Door Lock - \$100 per door set
- D6A: "W"/"G" Styles - Delete Doors and replace black laminate shelf with finished shelf - n/c
- D9SC: Soft Close Door Hinges - \$20 per door
- WPD3061: Designer White - \$80 per door

Drawer

- P6: Modify File/File to Box/Box/File - \$55 per pedestal (CA050 only)
- P33: Wood Drawer Upgrade - \$45 per drawer
- WPD3061: Designer White - \$80 per pedestal F/F pedestal
- WPD3061: Designer White - \$160 per lateral pedestal

Grommets (Standard Location)

- Specify Color and Left/Right/Center - \$50 ea.
- Black: TM30-R (Right), TM30-L (Left), TM30-C (Center)
 - Silver: TM31-R (Right), TM31-L (Left), TM31-C (Center)
 - Antique Brass: TM33-R (Right), TM33-L (Left), TM33-C (Center)

Grommets (Non-Standard Location)

- Provide drawing w/ Grommet Location and Specify Color - \$95 ea.
- Black: TM30-NS
 - Silver: TM31-NS
 - Antique Brass: TM33-NS

Grommets (Vertical Surface)

- Standard Location - \$50 ea.
- Black Plastic Vertical Surface: TM50-C (Bottom Center)
 - Non-Standard Location - \$95 ea.
 - Black Plastic Vertical Surface: TM50-NS

Open Plan _ Finished Back

- OPB:"W" "G" Style - Modify Unit for Open Plan Application - \$195
- OPBM: "M" Style - Modify Unit for Open Plan Application - \$95

Shelf

- S25: Replace Black Laminate Shelf with Finished Shelf - \$80 per shelf ("W", "P" & "G" styles)

Central Park

Full Pedestal Credenzas
Kneespace Credenza

[Click here to view statement of line](#)

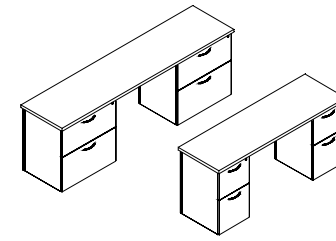

1 Select Model

w" x d" x h"

Lateral File Kneespace Credenza

93 x 24 x 29	300
87 x 24 x 29	290

File/File Kneespace Credenza

70 x 24 x 29	220
64 x 24 x 29	210
58 x 24 x 29	200

Weight

Standard Veneer Top Standard Veneer Chassis	Premium Veneer Top Premium Veneer Chassis	High Pressure Laminate Top Veneer Chassis	Thermally Fused Laminate Top Thermally Fused Laminate Chassis
CPC9324CA052W 4841	CPC9324CA052P 5326	CPC9324CA052G 4841	CPC9324CA052M 2674
CPC8724CA052W 4746	CPC8724CA052P 5222	CPC8724CA052G 4746	CPC8724CA052M 2648
CPC7024CA054W 3885	CPC7024CA054P 4274	CPC7024CA054G 3885	CPC7024CA054M 2215
CPC6424CA054W 3788	CPC6424CA054P 4168	CPC6424CA054G 3788	CPC6424CA054M 2185
CPC5824CA054W 3691	CPC5824CA054P 4061	CPC5824CA054G 3691	CPC5824CA054M 2139

2 Select Finish

[Click to view finishes](#)

WAC	WNW
WIC	WWP
WHC	WNF(Natural
WOC	Oak on Flat
WEC	Cut)
WAM	WSF(Salted
WCM	Oak on Flat
WEW	Cut)
WGW	WMF(Mocha
WBW	Oak on Flat
WSW	Cut)

TBCO
TBSW
TSTV
TSMV
TSLV
TOBW
WMO
WNO
WSO

GAC +10%
GIC GSLV
GHC +10%
GOC GWL
GEC
GAM
GCM
GEW
GNW
GSTV

MAC
MOC
MEC
MGW
MTW
MSW
MWL
MNA

3 Select Edge

[Click to view edges](#)

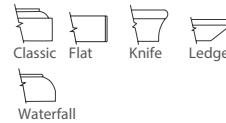
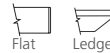
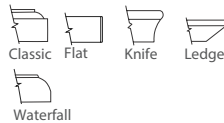

4 Select Hardware

[Click to view details](#)

[See Intro Page for Pull Options](#)

[See Intro Page for Pull Options](#)

[See Intro Page for Pull Options](#)

[See Intro Page for Pull Options](#)

Product Features

- Anti-tilt safety feature 93"/87" units
- Full extension drawers - locking
- Kneespace w/ 4" H rail - Open back
- Lateral file or File/File
- "W" & "G" SKUs feature soft close suspensions(Lateral Drawers feature ball bearing suspensions), "M" SKUs feature ball bearing suspensions. Both suspensions are full extension.

Notes

- All units are standard w/ flush ends
- Unit has black back panel and is not designed for Open Plan use. Select OPB Option for Open Plan application

Options

Accessories

- K28: Articulating Keyboard w/ Mouse - \$390

Drawer

- P6: Modify File/File to Box/Box/File - \$55 per pedestal (CA054 only)
- P33: Wood Drawer Upgrade - \$45 per drawer
- WPD3061: Designer White - \$80 per pedestal F/F pedestal
- WPD3061: Designer White - \$160 per lateral pedestal

Grommets (Standard Location)

- Specify Color - \$50 ea.
- Black: TM30-C (Center)
 - Silver: TM31-C (Center)
 - Antique Brass: TM33-C (Center)

Grommets (Non-Standard Location)

- Provide drawing w/ Grommet Location and Specify Color - \$95 ea.
- Black: TM30-NS
 - Silver: TM31-NS
 - Antique Brass: TM33-NS

Modesty

- M34T-O: "W" "G" Style Drop Door Tech Modesty - \$310
- M34TM-O: "M" Style Drop Door Tech Modesty - \$235
- M37: "W" "G" Style Fixed Full Modesty - \$130
- M37M: "M" Style Fixed Full Modesty - \$80

Open Plan _ Finished Back

- OPB:"W" "G" Style - Modify Unit for Open Plan Application - \$250 (includes modesty)
- OPBM: "M" Style - Modify Unit for Open Plan Application - \$195 (includes modesty)

Central Park

Full Pedestal Credenzas
Storage Credenza

[Click here to view statement of line](#)

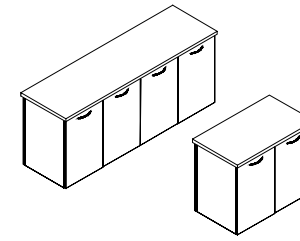

1 Select Model

w" x d" x h"

70 x 24 x 29	225
58 x 24 x 29	195
35 x 24 x 29	130
29 x 24 x 29	115

Weight

Standard Veneer Top Standard Veneer Chassis		Premium Veneer Top Premium Veneer Chassis		High Pressure Laminate Top Veneer Chassis		Thermally Fused Laminate Top Thermally Fused Laminate Chassis	
CPC7024CA125W	4110	CPC7024CA125P	4521	CPC7024CA125G	4110	CPC7024CA125M	2238
CPC5824CA125W	3696	CPC5824CA125P	4065	CPC5824CA125G	3696	CPC5824CA125M	2109
CPC3524CA125W	2250	CPC3524CA125P	2476	CPC3524CA125G	2250	CPC3524CA125M	1358
CPC2924CA125W	2094	CPC2924CA125P	2305	CPC2924CA125G	2094	CPC2924CA125M	1263

Product Features

- Black adjustable shelf behind door set ("W", "P" & "G" styles)
- "M" Styles have matching "M" Finish Shelf

Notes

- All units are standard w/ flush ends
- Unit has black back panel and is not designed for Open Plan use. Select OPB Option for Open Plan application

Options

Door

- D2: Wood Door Lock - \$100 per door set
- D6A: "W"/"G" Styles - Delete Doors and replace black laminate shelf with finished shelf - n/c
- D9SC: Soft Close Door Hinges - \$20 per door
- WPD3061: Designer White - \$80 per door

Grommets (Standard Location)

- Specify Color and Left/Right/Center - \$50 ea.
- Black: TM30-R (Right), TM30-L (Left), TM30-C (Center)
 - Silver: TM31-R (Right), TM31-L (Left), TM31-C (Center)

Grommets (Non-Standard Location)

- Provide drawing w/ Grommet Location and Specify Color - \$95 ea.
- Black: TM30-NS
 - Silver: TM31-NS
 - Antique Brass: TM33-NS

Grommets (Vertical Surface)

- Standard Location - \$50 ea.
- Black Plastic Vertical Surface: TM50-C (Bottom Center)
 - Non-Standard Location - \$95 ea.
 - Black Plastic Vertical Surface: TM50-NS

Open Plan _ Finished Back

- OPB: "W" "G" Style - Modify Unit for Open Plan Application - \$195
- OPB: "M" Style - Modify Unit for Open Plan Application - \$95

Shelf

- S25: Replace Black Laminate Shelf with Finished Shelf - \$80 per shelf ("W", "P" & "G" styles)

2 Select Finish

[Click to view finishes](#)

WAC	WNW
WIC	WWP
WHC	WNF(Natural
WOC	Oak on Flat
WEC	Cut)
WAM	WSF(Salted
WCM	Oak on Flat
WEW	Cut)
WGW	WMF(Mocha
WBW	Oak on Flat
WSW	Cut)

TBCO
TBSW
TSTV
TSMV
TSLV
TOBW
WMO
WNO
WSO

GAC +10%
GIC GSLV
GHC +10%
GOC GWL
GEC
GAM
GCM
GEW
GNW
GSTV

MAC
MOC
MEC
MGW
MTW
MSW
MWL
MNA

3 Select Edge

[Click to view edges](#)

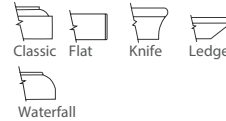
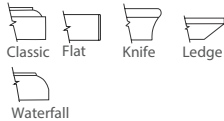

4 Select Hardware

[Click to view details](#)

See Intro Page
for Pull Options

See Intro Page
for Pull Options

See Intro Page
for Pull Options

See Intro Page
for Pull Options

Central Park

Full Pedestal Credenzas
Horizontal Lateral File

[Click here to view statement of line](#)

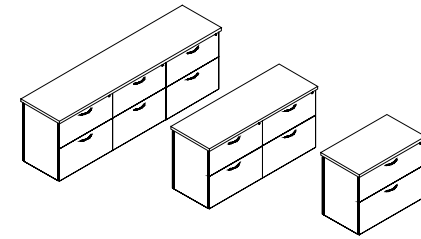

1 Select Model

w" x d" x h"	Weight
93 x 24 x 29	415
87 x 24 x 29	400
70 x 24 x 29	310
58 x 24 x 29	280
41 x 24 x 29	180
35 x 24 x 29	160
29 x 24 x 29	145

Standard Veneer Top Standard Veneer Chassis		Premium Veneer Top Premium Veneer Chassis		High Pressure Laminate Top Veneer Chassis		Thermally Fused Laminate Top Thermally Fused Laminate Chassis	
CPC9324CA104W	6527	CPC9324CA104P	7180	CPC9324CA104G	6527	CPC9324CA104M	3514
CPC8724CA104W	6157	CPC8724CA104P	6773	CPC8724CA104G	6157	CPC8724CA104M	3445
CPC7024CA104W	4676	CPC7024CA104P	5143	CPC7024CA104G	4676	CPC7024CA104M	2674
CPC5824CA104W	4561	CPC5824CA104P	5018	CPC5824CA104G	4561	CPC5824CA104M	2502
CPC4124CA104W	2780	CPC4124CA104P	3058	CPC4124CA104G	2780	CPC4124CA104M	1766
CPC3524CA104W	2479	CPC3524CA104P	2728	CPC3524CA104G	2479	CPC3524CA104M	1556
CPC2924CA104W	2258	CPC2924CA104P	2485	CPC2924CA104G	2258	CPC2924CA104M	1444

Product Features

- Anti-tilt safety feature
- Legal/Double letter filing
- Features ball bearing suspensions, suspensions are full extension.

Notes

- All units are standard w/ flush ends
- Unit has black back panel and is not designed for Open Plan use. Select OPB Option for Open Plan application

Options

Drawer

- P33: Wood Drawer Upgrade - \$45 per drawer
- WPD3061: Designer White - \$160 per lateral pedestal

Open Plan _ Finished Back

- OPB: "W" "G" Style - Modify Unit for Open Plan Application - \$195
- OPB: "M" Style - Modify Unit for Open Plan Application - \$95

2 Select Finish

[Click to view finishes](#)

WAC	WNW
WIC	WWP
WHC	WNF(Natural
WOC	Oak on Flat
WEC	Cut)
WAM	WSF(Salted
WCM	Oak on Flat
WEW	Cut)
WGW	WMF(Mocha
WBW	Oak on Flat
WSW	Cut)

TBCO
TBSW
TSTV
TSMV
TSLV
TOBW
WMO
WNO
WSO

GAC +10%
GIC GSLV
GHC +10%
GOC GWL
GEC
GAM
GCM
GEW
GNW
GSTV

MAC
MOC
MEC
MGW
MTW
MSW
MWL
MNA

3 Select Edge

[Click to view edges](#)

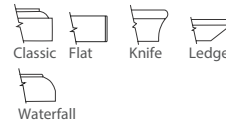
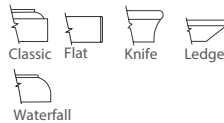

4 Select Hardware

[Click to view details](#)

See Intro Page
for Pull Options

See Intro Page
for Pull Options

See Intro Page
for Pull Options

See Intro Page
for Pull Options

Central Park

Full Pedestal Credenzas
Vertical Lateral File

[Click here to view statement of line](#)

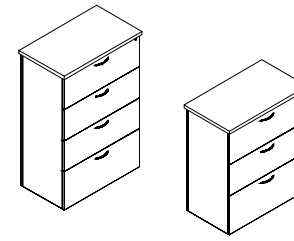

1 Select Model

w" x d" x h"

Weight	4 Drawer	3 Drawer
35 x 24 x 54	270	205
29 x 24 x 54	245	185
35 x 24 x 42		
29 x 24 x 42		

Standard Veneer Top Standard Veneer Chassis	Premium Veneer Top Premium Veneer Chassis	High Pressure Laminate Top Veneer Chassis	Thermally Fused Laminate Top Thermally Fused Laminate Chassis
CPC3524FI111W 4105	CPC3524FI111P 4516	CPC3524FI111G 4105	CPC3524FI111M 2518
CPC2924FI111W 3532	CPC2924FI111P 3885	CPC2924FI111G 3532	CPC2924FI111M 2151
CPC3524FI112W 3665	CPC3524FI112P 4032	CPC3524FI112G 3665	CPC3524FI112M 2339
CPC2924FI112W 3197	CPC2924FI112P 3518	CPC2924FI112G 3197	CPC2924FI112M 2009

Product Features

- Anti-tilt safety feature
- Legal/Double letter filing
- Features ball bearing suspensions, suspensions are full extension.

Notes

- All units are standard w/ flush ends
- Unit has black back panel and is not designed for Open Plan use. Select OPB Option for Open Plan application

Options

Drawer

- P33: Wood Drawer Upgrade - \$45 per drawer
- WPD3061: Designer White - \$160 per lateral pedestal

Open Plan _ Finished Back

- OPB: "W" "G" Style - Modify Unit for Open Plan Application - \$195
- OPB: "M" Style - Modify Unit for Open Plan Application - \$95

2 Select Finish

[Click to view finishes](#)

WAC	WNW
WIC	WWP
WHC	WNF(Natural
WOC	Oak on Flat
WEC	Cut)
WAM	WSF(Salted
WCM	Oak on Flat
WEW	Cut)
WGW	WMF(Mocha
WBW	Oak on Flat
WSW	Cut)

TBCO
TBSW
TSTV
TSMV
TSLV
TOBW
WMO
WNO
WSO

GAC +10%
GIC GSLV
GHC +10%
GOC GWL
GEC
GAM
GCM
GEW
GNW
GSTV

MAC
MOC
MEC
MGW
MTW
MSW
MWL
MNA

3 Select Edge

[Click to view edges](#)

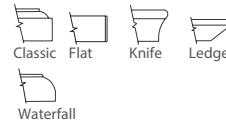
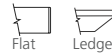
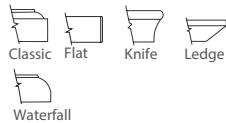

4 Select Hardware

[Click to view details](#)

See Intro Page
for Pull Options

See Intro Page
for Pull Options

See Intro Page
for Pull Options

See Intro Page
for Pull Options

Central Park

Workstation Credenzas

"U" Workstation Credenza - File / File

[Click here to view statement of line](#)

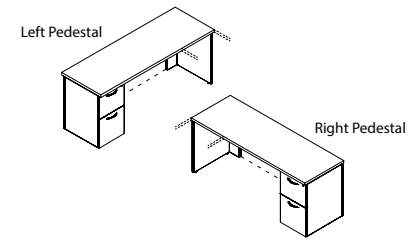

1 Select Model

Weight	w" x d" x h"
200	87 x 24 x 29
190	83 x 24 x 29
180	70 x 24 x 29
170	64 x 24 x 29
160	58 x 24 x 29
200	87 x 24 x 29
190	83 x 24 x 29
180	70 x 24 x 29
170	64 x 24 x 29
160	58 x 24 x 29

Standard Veneer Top Standard Veneer Chassis		Premium Veneer Top Premium Veneer Chassis		High Pressure Laminate Top Veneer Chassis		Thermally Fused Laminate Top Thermally Fused Laminate Chassis	
CPC8724CA086W	3418	CPC8724CA086P	3760	CPC8724CA086G	3418	CPC8724CA086M	1766
CPC8324CA086W	3217	CPC8324CA086P	3540	CPC8324CA086G	3217	CPC8324CA086M	1748
CPC7024CA086W	2832	CPC7024CA086P	3116	CPC7024CA086G	2832	CPC7024CA086M	1675
CPC6424CA086W	2788	CPC6424CA086P	3067	CPC6424CA086G	2788	CPC6424CA086M	1655
CPC5824CA086W	2743	CPC5824CA086P	3018	CPC5824CA086G	2743	CPC5824CA086M	1635
CPC8724CA087W	3418	CPC8724CA087P	3760	CPC8724CA087G	3418	CPC8724CA087M	1766
CPC8324CA087W	3217	CPC8324CA087P	3540	CPC8324CA087G	3217	CPC8324CA087M	1748
CPC7024CA087W	2832	CPC7024CA087P	3116	CPC7024CA087G	2832	CPC7024CA087M	1675
CPC6424CA087W	2788	CPC6424CA087P	3067	CPC6424CA087G	2788	CPC6424CA087M	1655
CPC5824CA087W	2743	CPC5824CA087P	3018	CPC5824CA087G	2743	CPC5824CA087M	1635

2 Select Finish

[Click to view finishes](#)

WAC	WNW
WIC	WWP
WHC	WNF(Natural
WOC	Oak on Flat
WEC	Cut)
WAM	WSF(Salted
WCM	Oak on Flat
WEW	Cut)
WGW	WMF(Mocha
WBW	Oak on Flat
WSW	Cut)

TBCO
TBSW
TSTV
TSMV
TSLV
TOBW
WMO
WNO
WSO

GAC +10%
GIC GSLV
GHC +10%
GOC GWL
GEC
GAM
GCM
GEW
GNW
GSTV

MAC
MOC
MEC
MGW
MTW
MSW
MWL
MNA

3 Select Edge

[Click to view edges](#)

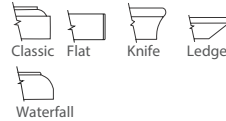
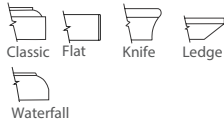

4 Select Hardware

[Click to view details](#)

[See Intro Page for Pull Options](#)

[See Intro Page for Pull Options](#)

[See Intro Page for Pull Options](#)

[See Intro Page for Pull Options](#)

Product Features

- 4"H back rail - open back
- Hookup hardware
- Legal/Double letter filing
- "W" & "G" SKUs feature soft close suspensions, "M" SKUs feature ball bearing suspensions. Both suspensions are full extension.

Notes

- All units are standard w/ flush ends
- Unit has black back panel and is not designed for Open Plan use. Select OPB Option for Open Plan application

Options

Accessories

- K28: Articulating Keyboard w/ Mouse - \$390

Drawer

- P6: Modify File/File to Box/Box/File - \$55 per pedestal
- P33: Wood Drawer Upgrade - \$45 per drawer
- P40W: extra Box/Box/File or File/File to Kneespace - \$910 (W, G)
- P40M: extra Box/Box/File or File/File to Kneespace - \$720 (M)
- WPD3061: Designer White - \$80 per F/F pedestal

Grommets (Standard Location)

Specify Color - \$50 ea.

- Black: TM30-C (Center)
- Silver: TM31-C (Center)
- Antique Brass: TM33-C (Center)

Grommets (Non-Standard Location)

Provide drawing w/ Grommet Location and Specify Color - \$95 ea.

- Black: TM30-NS
- Silver: TM31-NS
- Antique Brass: TM33-NS

Modesty

- M34T-O: "W" "G" Style Drop Door Tech Modesty - \$310
- M34TM-O: "M" Style Drop Door Tech Modesty - \$235
- M37: "W" "G" Style Fixed Full Modesty - \$130
- M37M: "M" Style Fixed Full Modesty - \$80

Open Plan _ Finished Back

- OPB: "W" "G" Style - Modify Unit for Open Plan Application - \$250 (includes modesty)
- OPB: "M" Style - Modify Unit for Open Plan Application - \$195 (includes modesty)

Central Park

Workstation Credenzas
 "U" Workstation Credenza - Lateral File

[Click here to view statement of line](#)

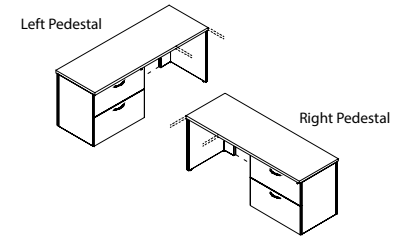

1 Select Model

w" x d" x h"	Weight
93 x 24 x 29	240
87x 24 x 29	225
83 x 24 x 29	220
* 70 x 24 x 29	215
* 64 x 24 x 29	200
* 58 x 24 x 29	190
Right Pedestal	
93 x 24 x 29	240
87 x 24 x 29	225
83 x 24 x 29	220
* 70 x 24 x 29	215
* 64 x 24 x 29	200
* 58 x 24 x 29	190

Standard Veneer Top Standard Veneer Chassis		Premium Veneer Top Premium Veneer Chassis		High Pressure Laminate Top Veneer Chassis		Thermally Fused Laminate Top Thermally Fused Laminate Chassis	
CPC9324CA066W	3849	CPC9324CA066P	4235	CPC9324CA066G	3849	CPC9324CA066M	2046
CPC8724CA066W	3771	CPC8724CA066P	4148	CPC8724CA066G	3771	CPC8724CA066M	2015
CPC8324CA066W	3586	CPC8324CA066P	3944	CPC8324CA066G	3586	CPC8324CA066M	1997
CPC7024CA066W	3199	CPC7024CA066P	3519	CPC7024CA066G	3199	CPC7024CA066M	1762
CPC6424CA066W	3157	CPC6424CA066P	3473	CPC6424CA066G	3157	CPC6424CA066M	1822
CPC5824CA066W	3136	CPC5824CA066P	3450	CPC5824CA066G	3136	CPC5824CA066M	1804
CPC9324CA067W	3849	CPC9324CA067P	4235	CPC9324CA067G	3849	CPC9324CA067M	2046
CPC8724CA067W	3771	CPC8724CA067P	4148	CPC8724CA067G	3771	CPC8724CA067M	2015
CPC8324CA067W	3586	CPC8324CA067P	3944	CPC8324CA067G	3586	CPC8324CA067M	1997
CPC7024CA067W	3199	CPC7024CA067P	3519	CPC7024CA067G	3199	CPC7024CA067M	1762
CPC6424CA067W	3157	CPC6424CA067P	3473	CPC6424CA067G	3157	CPC6424CA067M	1671
CPC5824CA067W	3136	CPC5824CA067P	3450	CPC5824CA067G	3136	CPC5824CA067M	1804

Product Features

- 4"H back rail - open back
- Hookup hardware
- Legal/Double letter filing
- Features ball bearing suspensions, suspensions are full extension.

Notes

- (*) Denotes Units w/ Kneespace Not Sufficient For Keyboard
- All units are standard w/ flush ends
- Unit has black back panel and is not designed for Open Plan use. Select OPB Option for Open Plan application

Options

Accessories

- K28: Articulating Keyboard w/ Mouse - \$390

Drawer

- P33: Wood Drawer Upgrade - \$45 per drawer
- P40W: extra Box/Box/File or File/File to Kneespace - \$910 (N/A on 58") (W,G)
- P40M: extra Box/Box/File or File/File to Kneespace - \$720 (N/A on 58") (M)
- WPD3061: Designer White - \$160 per lateral pedestal

Grommets (Standard Location)

- Specify Color - \$50 ea.
- Black: TM30-C (Center)
- Silver: TM31-C (Center)
- Antique Brass: TM33-C (Center)

Grommets (Non-Standard Location)

- Provide drawing w/ Grommet Location and Specify Color - \$95 ea.
- Black: TM30-NS
- Silver: TM31-NS
- Antique Brass: TM33-NS

Modesty

- M34T-O: "W" "G" Style Drop Door Tech Modesty - \$310
- M34TM-O: "M" Style Drop Door Tech Modesty - \$235
- M37: "W" "G" Style Fixed Full Modesty - \$130
- M37M: "M" Style Fixed Full Modesty - \$80

Open Plan _ Finished Back

- OPB: "W" "G" Style - Modify Unit for Open Plan Application - \$250 (includes modesty)
- OPB: "M" Style - Modify Unit for Open Plan Application - \$195 (includes modesty)

2 Select Finish

[Click to view finishes](#)

WAC	WNW
WIC	WWP
WHC	WNF(Natural
WOC	Oak on Flat
WEC	Cut)
WAM	WSF(Salted
WCM	Oak on Flat
WEW	Cut)
WGW	WMF(Mocha
WBW	Oak on Flat
WSW	Cut)

TBCO
TBSW
TSTV
TSMV
TSLV
TOBW
WMO
WNO
WSO

GAC +10%
GIC GSLV
GHC +10%
GOC GWL
GEC
GAM
GCM
GEW
GNW
GSTV

MAC
MOC
MEC
MGW
MTW
MSW
MWL
MNA

3 Select Edge

[Click to view edges](#)

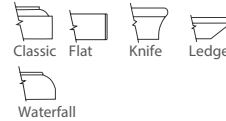
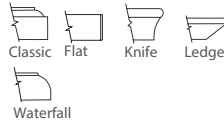

4 Select Hardware

[Click to view details](#)

[See Intro Page for Pull Options](#)

[See Intro Page for Pull Options](#)

[See Intro Page for Pull Options](#)

[See Intro Page for Pull Options](#)

Central Park

Workstation Credenzas
 "U" Workstation Credenza - Multi-File

[Click here to view statement of line](#)

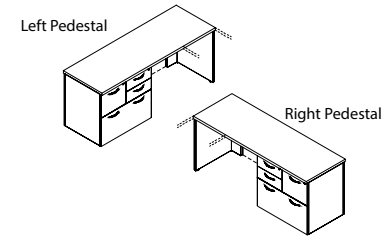

1 Select Model

Weight	w" x d" x h"
	Left Pedestal
240	93 x 24 x 29
225	87 x 24 x 29
220	83 x 24 x 29
215	* 70 x 24 x 29
200	* 64 x 24 x 29
190	* 58 x 24 x 29
	Right Pedestal
240	93 x 24 x 29
225	87 x 24 x 29
220	83 x 24 x 29
215	* 70 x 24 x 29
200	* 64 x 24 x 29
190	* 58 x 24 x 29

Standard Veneer Top Standard Veneer Chassis		Premium Veneer Top Premium Veneer Chassis		High Pressure Laminate Top Veneer Chassis		Thermally Fused Laminate Top Thermally Fused Laminate Chassis	
CPC9324CA667W	4314	CPC9324CA667P	4745	CPC9324CA667G	4314	CPC9324CA667M	2139
CPC8724CA667W	4228	CPC8724CA667P	4650	CPC8724CA667G	4228	CPC8724CA667M	2109
CPC8324CA667W	4043	CPC8324CA667P	4448	CPC8324CA667G	4043	CPC8324CA667M	2091
CPC7024CA667W	3656	CPC7024CA667P	4023	CPC7024CA667G	3656	CPC7024CA667M	1935
CPC6424CA667W	3612	CPC6424CA667P	3974	CPC6424CA667G	3612	CPC6424CA667M	1917
CPC5824CA667W	3594	CPC5824CA667P	3954	CPC5824CA667G	3594	CPC5824CA667M	1898
CPC9324CA668W	4314	CPC9324CA668P	4745	CPC9324CA668G	4314	CPC9324CA668M	2139
CPC8724CA668W	4228	CPC8724CA668P	4650	CPC8724CA668G	4228	CPC8724CA668M	2109
CPC8324CA668W	4043	CPC8324CA668P	4448	CPC8324CA668G	4043	CPC8324CA668M	2091
CPC7024CA668W	3656	CPC7024CA668P	4023	CPC7024CA668G	3656	CPC7024CA668M	1935
CPC6424CA668W	3612	CPC6424CA668P	3974	CPC6424CA668G	3612	CPC6424CA668M	1758
CPC5824CA668W	3594	CPC5824CA668P	3954	CPC5824CA668G	3594	CPC5824CA668M	1898

Product Features

- 4"H back rail - open back
- Hookup hardware
- Multi-file provides legal-double letter filing
- "W" & "G" SKUs feature soft close suspensions(Lateral Drawer features ball bearing suspensions), "M" SKUs feature ball bearing suspensions. Both suspensions are full extension.

Notes

- (*) Denotes Units w/ Kneespace Not Sufficient For Keyboard
- All units are standard w/ flush ends
- Unit has black back panel and is not designed for Open Plan use. Select OPB Option for Open Plan application

Options

Accessories

- K28: Articulating Keyboard w/ Mouse - \$390

Drawer

- P33: Wood Drawer Upgrade - \$45 per drawer
- P40W: extra Box/Box/File or File/File to Kneespace - \$910 (N/A on 58") (W,G)
- P40M: extra Box/Box/File or File/File to Kneespace - \$720 (N/A on 58") (M)
- WPD3061: Designer White - \$80 per F/F pedestal
- WPD3061: Designer White - \$160 per lateral pedestal

Grommets (Standard Location)

- Specify Color - \$50 ea.
- Black: TM30-C (Center)
- Silver: TM31-C (Center)
- Antique Brass: TM33-C (Center)

Grommets (Non-Standard Location)

- Provide drawing w/ Grommet Location and Specify Color - \$95 ea.
- Black: TM30-NS
- Silver: TM31-NS
- Antique Brass: TM33-NS

Modesty

- M34T-O: "W" "G" Style Drop Door Tech Modesty - \$310
- M34TM-O: "M" Style Drop Door Tech Modesty - \$235
- M37: "W" "G" Style Fixed Full Modesty - \$130
- M37M: "M" Style Fixed Full Modesty - \$80

Open Plan _ Finished Back

- OPB: "W" "G" Style - Modify Unit for Open Plan Application - \$250 (includes modesty)
- OPB: "M" Style - Modify Unit for Open Plan Application - \$195 (includes modesty)

2 Select Finish

[Click to view finishes](#)

WAC	WNW
WIC	WWP
WHC	WNF(Natural
WOC	Oak on Flat
WEC	Cut)
WAM	WSF(Salted
WCM	Oak on Flat
WEW	Cut)
WGW	WMF(Mocha
WBW	Oak on Flat
WSW	Cut)

TBCO
TBSW
TSTV
TSMV
TSLV
TOBW
WMO
WNO
WSO

GAC +10%
GIC GSLV
GHC +10%
GOC GWL
GEC
GAM
GCM
GEW
GNW
GSTV

MAC
MOC
MEC
MGW
MTW
MSW
MWL
MNA

3 Select Edge

[Click to view edges](#)

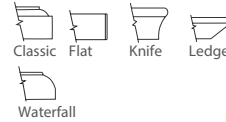
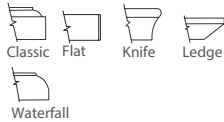

4 Select Hardware

[Click to view details](#)

See Intro Page
for Pull Options

See Intro Page
for Pull Options

See Intro Page
for Pull Options

See Intro Page
for Pull Options

Central Park

Workstation Return Shells
Open Back

[Click here to view statement of line](#)

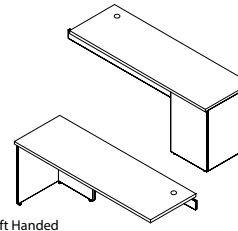

Left Handed

1 Select Model

w" x d" x h"	Weight
Left Handed Return Shell	
72 x 24 x 29	110
66 x 24 x 29	100
60 x 24 x 29	95
54 x 24 x 29	90
48 x 24 x 29	85
Right Handed Return Shell	
72 x 24 x 29	110
66 x 24 x 29	100
60 x 24 x 29	95
54 x 24 x 29	90
48 x 24 x 29	85

	Standard Veneer Top Standard Veneer Chassis		Premium Veneer Top Premium Veneer Chassis		High Pressure Laminate Top Veneer Chassis		Thermally Fused Laminate Top Thermally Fused Laminate Chassis	
WAC	CPC7224RE213W	2080	CPC7224RE213P	2288	CPC7224RE213G	2080	CPC7224RE213M	1065
WIC	CPC6624RE213W	1986	CPC6624RE213P	2186	CPC6624RE213G	1986	CPC6624RE213M	1040
WHC	CPC6024RE213W	1891	CPC6024RE213P	2080	CPC6024RE213G	1891	CPC6024RE213M	954
WOC	CPC5424RE213W	1790	CPC5424RE213P	1970	CPC5424RE213G	1790	CPC5424RE213M	934
WEC	CPC4824RE213W	1687	CPC4824RE213P	1856	CPC4824RE213G	1687	CPC4824RE213M	916
WAM	CPC7224RE214W	2080	CPC7224RE214P	2288	CPC7224RE214G	2080	CPC7224RE214M	1065
WCM	CPC6624RE214W	1986	CPC6624RE214P	2186	CPC6624RE214G	1986	CPC6624RE214M	1040
WCM	CPC6024RE214W	1891	CPC6024RE214P	2080	CPC6024RE214G	1891	CPC6024RE214M	954
WEW	CPC5424RE214W	1790	CPC5424RE214P	1970	CPC5424RE214G	1790	CPC5424RE214M	934
WGW	CPC4824RE214W	1687	CPC4824RE214P	1856	CPC4824RE214G	1687	CPC4824RE214M	916
WBW								
WSW								
WNV			TBCO		GAC +10%		MAC	
WNP			TBSW		GIC GSLV		MOC	
WNF(Natural			TSTV		GHC +10%		MEC	
WOF			TSMV		GOC GWL		MGW	
WEC			TSLV		GEC		MTW	
WAM			TOBW		GAM		MSW	
WCM			WMO		GCM		MWL	
WEW			WNO		GEW		MNA	
WGW			WSO		GNW			
WBW					GSTV			
WSW								
Classic			Flat		Classic		Flat	
Flat			Ledge		Flat			
Knife					Knife			
Ledge					Ledge			
Waterfall					Waterfall			
Hardware			Hardware		Hardware		Hardware	
N/A			N/A		N/A		N/A	

Product Features

- 4"H back rail - open back
- Standard with grommet

Notes

- All units are standard w/ flush ends
- Grain Direction Runs Front To Back On All "W" Units and Up to 60" on "G" and "M" Units
- Grain Runs End To End On 66"/ 72" Sizes on "G" and "M" styles
- Unit ships assembled

Options

Accessories

- K28: Articulating Keyboard w/ Mouse - \$390
- K31: Center drawer - \$205

Grommets (Non-Standard Location)

Provide drawing w/ Grommet Location and Specify Color - \$95 ea.

- Black: TM30-NS
- Silver: TM31-NS
- Antique Brass: TM33-NS

Modesty

- M34T-O: "W" "G" Style Drop Door Tech Modesty - \$310
- M34TM-O: "M" Style Drop Door Tech Modesty - \$235
- M37: "W" "G" Style Fixed Full Modesty - \$130
- M37M: "M" Style Fixed Full Modesty - \$80

Return Shell

- RE202: Non-Handed/Reconfigurable Return Shell - n/c

2 Select Finish

[Click to view finishes](#)

WAC	WNW
WIC	WWP
WHC	WNF(Natural
WOC	Oak on Flat
WEC	Cut)
WAM	WSF(Salted
WCM	Oak on Flat
WEW	Cut)
WGW	WMF(Mocha
WBW	Oak on Flat
WSW	Cut)

3 Select Edge

[Click to view edges](#)

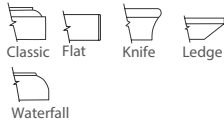

4 Select Hardware

[Click to view details](#)

Hardware
N/A

Hardware
N/A

Hardware
N/A

Hardware
N/A

Central Park

Workstation Freestanding Credenza Shells
Open Back

[Click here to view statement of line](#)

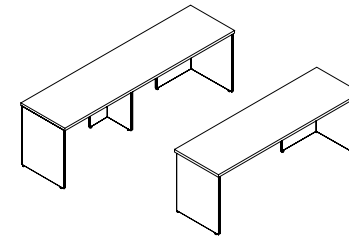

1 Select Model

w" x d" x h"	Weight
93 x 24 x 29	225
87 x 24 x 29	205
83 x 24 x 29	175
77 x 24 x 29	165
70 x 24 x 29	155
64 x 24 x 29	145
58 x 24 x 29	135

Standard Veneer Top Standard Veneer Chassis		Premium Veneer Top Premium Veneer Chassis		High Pressure Laminate Top Veneer Chassis		Thermally Fused Laminate Top Thermally Fused Laminate Chassis	
CPC9324CA082W	3260	CPC9324CA082P	3586	CPC9324CA082G	3260	CPC9324CA082M	1407
CPC8724CA082W	2902	CPC8724CA082P	3193	CPC8724CA082G	2902	CPC8724CA082M	1332
CPC8324CA082W	2514	CPC8324CA082P	2766	CPC8324CA082G	2514	CPC8324CA082M	1307
CPC7724CA082W	2426	CPC7724CA082P	2669	CPC7724CA082G	2426	CPC7724CA082M	1270
CPC7024CA082W	2339	CPC7024CA082P	2573	CPC7024CA082G	2339	CPC7024CA082M	1233
CPC6424CA082W	2284	CPC6424CA082P	2513	CPC6424CA082G	2284	CPC6424CA082M	1196
CPC5824CA082W	2234	CPC5824CA082P	2457	CPC5824CA082G	2234	CPC5824CA082M	1157
WAC WNW TBCO WIC WWP TBSW WHC WNF(Natural TSTV WOC Oak on Flat TSMV WEC Cut) TSLV WAM WSF(Salted TOBW WCM Oak on Flat WMO WEW Cut) WNO WGW WMF(Mocha WSO WBW Oak on Flat WSW Cut)		GAC +10% GIC GSLV GHC +10% GOC GWL GEC GAM GCM GEW GNW GSTV		MAC MOC MEC MGW MTW MSW MWL MNA			
2 Select Finish Click to view finishes		3 Select Edge Click to view edges		4 Select Hardware Click to view details		Product Features	
Classic Flat Knife Ledge Waterfall		Flat Ledge		Classic Flat Knife Ledge Waterfall		Notes <ul style="list-style-type: none"> - 93" Units w/ Center "T" Support - All units are standard w/ flush ends - Can Be Used Freestanding Or Create "L" And "U" Workstations Using Runoff Desk, With Bench Credenza, Return, or Bridge. - Half support end when runoff is attached w/ modesty - When ganging multiple modular pedestals together (without kneespace) under shell units, contact factory to confirm size availability. 	
Hardware N/A		Hardware N/A		Hardware N/A		Options <p>Accessories</p> <ul style="list-style-type: none"> - K28: Articulating Keyboard w/ Mouse - \$390 <p>Grommets (Standard Location)</p> Specify Color and Left/Right/Center - \$50 ea. <ul style="list-style-type: none"> - Black: TM30-R (Right), TM30-L (Left), TM30-C (Center) - Silver: TM31-R (Right), TM31-L (Left), TM31-C (Center) - Antique Brass: TM33-R (Right), TM33-L (Left), TM33-C (Center) <p>Grommets (Non-Standard Location)</p> Provide drawing w/ Grommet Location and Specify Color - \$95 ea. <ul style="list-style-type: none"> - Black: TM30-NS - Silver: TM31-NS - Antique Brass: TM33-NS <p>Modesty</p> <ul style="list-style-type: none"> - M34T-O: "W" "G" Style Drop Door Tech Modesty - \$310 - M34TM-O: "M" Style Drop Door Tech Modesty - \$235 - M37: "W" "G" Style Fixed Full Modesty - \$130 - M37M: "M" Style Fixed Full Modesty - \$80 	

Central Park

Single Height Bench Cabinets
One, Two And Three Section Storage

[Click here to view statement of line](#)

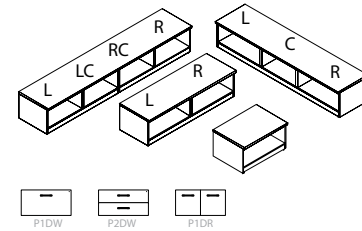

1 Select Model

w" x d" x h"
Three Section Storage
93 x 24 x 19
87 x 24 x 19
Two Section Storage
70 x 24 x 19
58 x 24 x 19
One Section Storage

Weight	Standard Veneer Top Standard Veneer Chassis		Premium Veneer Top Premium Veneer Chassis		High Pressure Laminate Top Veneer Chassis		Thermally Fused Laminate Top Thermally Fused Laminate Chassis	
235	CPC9324CA062W	3586	CPC9324CA062P	3944	CPC9324CA062G	3586	CPC9324CA062M	2171
225	CPC8724CA062W	3488	CPC8724CA062P	3837	CPC8724CA062G	3488	CPC8724CA062M	1959
185	CPC7024CA062W	2428	CPC7024CA062P	2671	CPC7024CA062G	2428	CPC7024CA062M	1635
165	CPC5824CA062W	2346	CPC5824CA062P	2582	CPC5824CA062G	2346	CPC5824CA062M	1520
80	CPC3524CA062W	1214	CPC3524CA062P	1336	CPC3524CA062G	1214	CPC3524CA062M	668
75	CPC2924CA062W	1173	CPC2924CA062P	1291	CPC2924CA062G	1173	CPC2924CA062M	641

2 Select Finish

Click to view finishes

WAC	WNW
WIC	WWP
WHC	WNF(Natural
WOC	Oak on Flat
WEC	Cut)
WAM	WSF(Salted
WCM	Oak on Flat
WEW	Cut)
WGW	WMF(Mocha
WBW	Oak on Flat
WSW	Cut)

TBCO
TBSW
TSTV
TSMV
TSLV
TOBW
WMO
WNO
WSO

GAC +10%
GIC GSLV
GHC +10%
GOC GWL
GEC
GAM
GCM
GEW
GNW
GSTV

MAC
MOC
MEC
MGW
MTW
MSW
MWL
MNA

3 Select Edge

Click to view edges



4 Select Hardware

Click to view details

See Intro Page
for Pull Options

See Intro Page
for Pull Options

See Intro Page
for Pull Options

See Intro Page
for Pull Options

Product Features

- 6 Wire dividers per open cabinet
- Finished back - open plan
- Top w/ flat edges

Notes

- All units are standard w/ flush ends
- To Use Runoff Desk With Bench Cabinets, Order Bench Runoff Support Ends: See Bench Accessory Page 71-72

Options

Cushion

- BC24: Bench Cushion
- Specify location, number of cushions and fabric grade.
- Cushions sold individually w/a max width 35" (to match storage section depth). 29" W requires .75 yd, 35" W requires 1 yd.

Grommets (Standard Location)

- Specify Color and Left/Right/Center - \$50 ea.
- Black: TM30-R (Right), TM30-L (Left), TM30-C (Center)
- Silver: TM31-R (Right), TM31-L (Left), TM31-C (Center)
- Antique Brass: TM33-R (Right), TM33-L (Left), TM33-C (Center)

Grommets (Vertical Surface)

- Standard Location - \$50 ea.
- Black Plastic Vertical Surface: TM50-C (Bottom Center)
- Non-Standard Location - \$95 ea.
- Black Plastic Vertical Surface: TM50-NS

Storage

- Specify pull with storage option/ Specify location of each cabinet
- Lateral file - P1DW: \$515 for "W" and "G" / P1DM: \$260 for "M"
- Two Box - P2DW: \$515 for "W" and "G" / P1DM: \$260 for "M"
- Two Door Storage - P1DR: \$205 for "W" and "G" / P1DM: \$130 for "M"

Modify For Height Adjustable Runoff

- Must be in Open Storage area on Bench. Includes False back inside and cutout in. back for wall access.
- HAR-L -Option Left pedestal- \$250
- HAR-R Option Right Pedestal - \$250
- HAR-C Option Center Pedestal- \$250
- HAR-CL - Option Center Left Pedestal (116" Bench) - \$250
- HAR-CR Option Center Right Pedestal (116" Bench) -\$250

BC24 Bench Cushion fabric grades.

COM	COL	1	2	3
270	289	298	312	326
4	5	6	7	8
340	354	368	382	396
9	10	11/ L1	12	13/ L2
410	424	438	452	480

Central Park

Double Height Bench Cabinets
One, Two And Three Section Storage

[Click here to view statement of line](#)

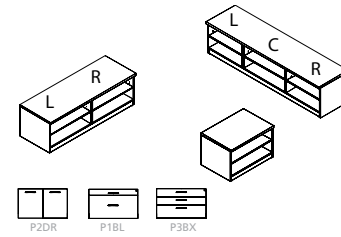

1 Select Model

w" x d" x h"

Weight	Three Section Storage	Two Section Storage	One Section Storage
300	93 x 24 x 23	70 x 24 x 23	35 x 24 x 23
290	87 x 24 x 23	58 x 24 x 23	29 x 24 x 23

	Standard Veneer Top Standard Veneer Chassis		Premium Veneer Top Premium Veneer Chassis		High Pressure Laminate Top Veneer Chassis		Thermally Fused Laminate Top Thermally Fused Laminate Chassis	
WAC	CPC9324CA063W	4443	CPC9324CA063P	4888	CPC9324CA063G	4443	CPC9324CA063M	2550
WIC	CPC8724CA063W	4110	CPC8724CA063P	4521	CPC8724CA063G	4110	CPC8724CA063M	2301
WNC	CPC7024CA063W	2937	CPC7024CA063P	3231	CPC7024CA063G	2937	CPC7024CA063M	1922
WOC	CPC5824CA063W	2771	CPC5824CA063P	3049	CPC5824CA063G	2771	CPC5824CA063M	1786
WEC	CPC3524CA063W	1550	CPC3524CA063P	1706	CPC3524CA063G	1550	CPC3524CA063M	785
WAM	CPC2924CA063W	1507	CPC2924CA063P	1658	CPC2924CA063G	1507	CPC2924CA063M	755
WCM								
WEW								
WGW								
WBW								
WSW								
WNW			TBCO		GAC +10%		MAC	
WNP			TBSW		GIC GSLV		MOC	
WNF(Natural			TSTV		GHC +10%		MEC	
WOak on Flat			TSMV		GOC GWL		MGW	
WCut)			TSLV		GEC		MTW	
WSF(Salted			TOBW		GAM		MSW	
WOak on Flat			WMO		GCM		MWL	
WCut)			WNO		GEW		MNA	
WMF(Mocha			WSO		GNW			
WOak on Flat					GSTV			
WCut)								

2 Select Finish

[Click to view finishes](#)

WAC	WNW
WIC	WNP
WNC	WNF(Natural
WOC	WOak on Flat
WEC	WCut)
WAM	WSF(Salted
WCM	WOak on Flat
WEW	WCut)
WGW	WMF(Mocha
WBW	WOak on Flat
WSW	WCut)

3 Select Edge

[Click to view edges](#)



Flat



Flat



Flat



Flat

4 Select Hardware

[Click to view details](#)

See Intro Page
for Pull Options

See Intro Page
for Pull Options

See Intro Page
for Pull Options

See Intro Page
for Pull Options

Product Features

- Finished back - open plan
- Top w/ flat edges

Notes

- All units are standard w/ flush ends
- To Use Runoff Desk With Bench Cabinets, Order Bench Runoff Support Ends: See Bench Accessory Page 71-72

Options

Cushion

- BC24: Bench Cushion
- Specify location, number of cushions and fabric grade.
- Cushions sold individually w/a max width 35" (to match storage section depth). 29" W requires .75 yd, 35" W requires 1 yd.

Grommets (Standard Location)

Specify Color and Left/Right/Center - \$50 ea.

- Black: TM30-R (Right), TM30-L (Left), TM30-C (Center)
- Silver: TM31-R (Right), TM31-L (Left), TM31-C (Center)
- Antique Brass: TM33-R (Right), TM33-L (Left), TM33-C (Center)

Grommets (Vertical Surface)

Standard Location - \$50 ea.

- Black Plastic Vertical Surface: TM50-C (Bottom Center)
- Non-Standard Location - \$95 ea.
- Black Plastic Vertical Surface: TM50-NS

Storage

Specify pull with storage option/ Specify location of each cabinet

- P1BL: Box/Lateral File - \$315 M / \$620 W
- P2DR: Storage Door - \$185 M / \$290 W
- P2PP: Open Printer Pullout - \$235 M / \$340 W
- P3BX: Three Box Drawers - \$315 M / \$620 W

Modify For Height Adjustable Runoff

Must be in Open Storage area on Bench. Includes False back inside and cutout in. back for wall access.

- HAR-L -Option Left pedestal- \$251
- HAR-R Option Right Pedestal - \$251
- HAR-C Option Center Pedestal- \$251
- HAR-CL - Option Center Left Pedestal (116" Bench) - \$251
- HAR-CR Option Center Right Pedestal (116" Bench) - \$251

BC24 Bench Cushion fabric grades.

COM	COL	1	2	3
270	289	298	312	326
4	5	6	7	8
340	354	368	382	396
9	10	11/ L1	12	13/ L2
410	424	438	452	480

Central Park

Bench Accessories

Bench Runoff Support Wood "T" Panel

[Click here to view statement of line](#)

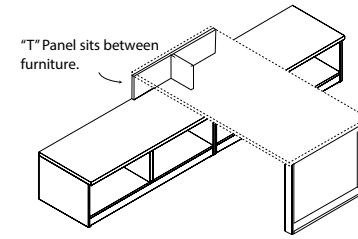

1 Select Model

w" x d" x h"
 For 19" Bench
 36" Runoff
 30" Runoff
 For 23" Bench
 36" Runoff
 30" Runoff

Weight	Standard Veneer Top Standard Veneer Chassis	Premium Veneer Top Premium Veneer Chassis	High Pressure Laminate Top Veneer Chassis	Thermally Fused Laminate Top Thermally Fused Laminate Chassis
20	19BRT36W 612	19BRT36P 674	"G" Option N/A	19BRT36M 387
15	19BRT30W 563	19BRT30P 620	"G" Option N/A	19BRT30M 362
25	23BRT36W 531	23BRT36P 585	"G" Option N/A	23BRT36M 339
20	23BRT30W 481	23BRT30P 530	"G" Option N/A	23BRT30M 313

Product Features

Notes

- Used when specifying runoff desk for use with bench credenzas
- Wood "T" Panel (Factory Installed) on runoff

2 Select Finish

[Click to view finishes](#)

WAC	WNW
WIC	WWP
WHC	WNF(Natural
WOC	Oak on Flat
WEC	Cut)
WAM	WSF(Salted
WCM	Oak on Flat
WEW	Cut)
WGW	WMF(Mocha
WBW	Oak on Flat
WSW	Cut)

TBCO
 TBSW
 TSTV
 TSMV
 TSLV
 TOBW
 WMO
 WNO
 WSO

MAC
 MOC
 MEC
 MGW
 MTW
 MSW
 MWL
 MNA

3 Select Edge

[Click to view edges](#)

Edge
 N/A

Edge
 N/A

Edge
 N/A

4 Select Hardware

[Click to view details](#)

Hardware
 N/A

Hardware
 N/A

Hardware
 N/A

Central Park

Bench Accessories
Bench Runoff Technology Support

[Click here to view statement of line](#)

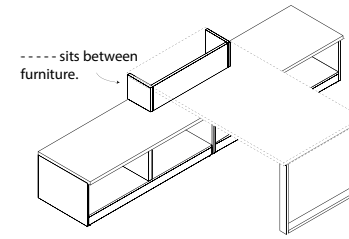

1 Select Model

w" x d" x h"
For 19" Bench
36" Runoff
30" Runoff
For 23" Bench
36" Runoff
30" Runoff

Weight	Standard Veneer Top Standard Veneer Chassis	Premium Veneer Top Premium Veneer Chassis	High Pressure Laminate Top Veneer Chassis	Thermally Fused Laminate Top Thermally Fused Laminate Chassis
20	19BRN36W 724	19BRN36P 797	"G" Option N/A	19BRN36M 456
15	19BRN30W 694	19BRN30P 763	"G" Option N/A	19BRN30M 430
25	23BRN36W 643	23BRN36P 707	"G" Option N/A	23BRN36M 406
20	23BRN30W 612	23BRN30P 674	"G" Option N/A	23BRN30M 381

2 Select Finish	Standard Veneer Top	Premium Veneer Top	High Pressure Laminate Top	Thermally Fused Laminate Top
Click to view finishes	WAC WNW WIC WWP WHC WNF(Natural WOC Oak on Flat WEC Cut) WAM WSF(Salted WCM Oak on Flat WEW Cut) WGW WMF(Mocha WBW Oak on Flat WSW Cut)	TBCO TBSW TSTV TSMV TSLV TOBW WMO WNO WSO		MAC MOC MEC MGW MTW MSW MWL MNA
3 Select Edge	Edge N/A	Edge N/A		Edge N/A
4 Select Hardware	Hardware N/A	Hardware N/A		Hardware N/A

Product Features

Notes

- Cavity is 7.75" D X 8.25" I x 5" H
- Order Power/Data Modules Separately - See Option Page

Central Park

Mobile Pedestals
Open Plan Mobile Desk Pedestal With Casters

[Click here to view statement of line](#)

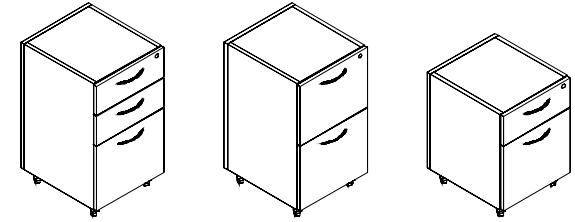

1 Select Model

w" x d" x h"
Box/Box/File
16 x 18 x 27
File/File
16 x 18 x 27
Box/File
16 x 18 x 23

Weight	Standard Veneer Top Standard Veneer Chassis	Premium Veneer Top Premium Veneer Chassis	High Pressure Laminate Top Veneer Chassis	Thermally Fused Laminate Top Thermally Fused Laminate Chassis
70	CPC1618PD424W 1451	CPC1618PD424P 1597	"G" Option N/A	CPC1618PD424M 1089
70	CPC1618PD425W 1331	CPC1618PD425P 1597	"G" Option N/A	CPC1618PD425M 1089
55	CPC1618PD423W 1307	CPC1618PD423P 1438	"G" Option N/A	CPC1618PD423M 979
	WAC WNW WIC WWP WHC WNF(Natural WOC Oak on Flat WEC Cut) WAM WSF(Salted WCM Oak on Flat WEW Cut) WGW WMF(Mocha WBW Oak on Flat WSW Cut)	TBCO TBSW TSTV TSMV TSLV TOBW WMO WNO WSO		MAC MOC MEC MGW MTW MSW MWL MNA
	Edge N/A	Edge N/A		Edge N/A
	See Intro Page for Pull Options	See Intro Page for Pull Options	See Intro Page for Pull Options	See Intro Page for Pull Options

2 Select Finish

Click to view finishes

3 Select Edge

Click to view edges

4 Select Hardware

Click to view details

Product Features

- Anti-tilt safety feature
- Finished all sides and top - open plan
- Full extension drawers - locking

Notes

- Pedestal Cushion can be specified on all pedestals, but on Box/ Box/ File and File/File unit will not fit under work surface w/ cushion.

Options

Cushion

- BC16: Bench Cushion
- Specify fabric grade (1 yd. required)

Drawer

- P33: Wood Drawer Upgrade - \$45 per drawer
- WPD3061: Designer White - \$80 per pedestal

BC16 Cushion fabric grades

COM	COL	1	2	3
224	N/A	261	279	297
4	5	6	7	8
315	333	351	369	387
9	10	11/ L1	12	13/ L2
405	423	441	459	495

Central Park
 Modular Pedestals
 Undersurface Pedestal

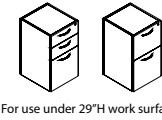

For use under 29"H work surfaces

[Click here to view statement of line](#)

1 Select Model

w" x d" x h"
 Box/Box/File
 16 x 18 x 27
 File/File
 16 x 18 x 27

Weight	Standard Veneer Top Standard Veneer Chassis	Premium Veneer Top Premium Veneer Chassis	High Pressure Laminate Top Veneer Chassis	Thermally Fused Laminate Top Thermally Fused Laminate Chassis
70	CPC1618PD440W 1365	CPC1618PD440P 1503	"G" Option N/A	CPC1618PD440M 1051
70	CPC1618PD441W 1365	CPC1618PD441P 1503	"G" Option N/A	CPC1618PD441M 1051

Product Features

- Anti-tilt safety feature
- Finished all sides and top - open plan
- Full extension drawers - locking
- "W" & "G" SKUs feature soft close suspensions, "M" SKUs feature ball bearing suspensions. Both suspensions are full extension.

Options

- Drawer**
- P33: Wood Drawer Upgrade - \$45 per drawer
 - WPD3061: Designer White - \$80 per pedestal

2 Select Finish

[Click to view finishes](#)

WAC
 WIC
 WHC
 WOC
 WEC
 WAM
 WCM
 WEW
 WGW
 WBW
 WSW

WNW
 WWP
 WNF(Natural
 Oak on Flat
 Cut)
 WSF(Salted
 Oak on Flat
 Cut)
 WMF(Mocha
 Oak on Flat
 Cut)

TBCO
 TBSW
 TSTV
 TSMV
 TSLV
 TOBW
 WMO
 WNO
 WSO

MAC
 MOC
 MEC
 MGW
 MTW
 MSW
 MWL
 MNA

3 Select Edge

[Click to view edges](#)

Edge
 N/A

Edge
 N/A

Edge
 N/A

4 Select Hardware

[Click to view details](#)

See Intro Page
 for Pull Options

See Intro Page
 for Pull Options

See Intro Page
 for Pull Options

See Intro Page
 for Pull Options

Central Park

Pedestals Undersurface Lateral File Pedestals

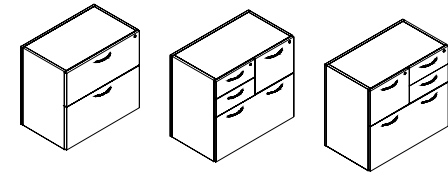

[Click here to view statement of line](#)

For use under 29"H work surfaces

1 Select Model

w" x d" x h"

	Weight	Standard Veneer Top Standard Veneer Chassis	Premium Veneer Top Premium Veneer Chassis	High Pressure Laminate Top Veneer Chassis	Thermally Fused Laminate Top Thermally Fused Laminate Chassis
2 Drawer Lateral File Pedestal 29 x 18 x 27	135	CPC2918PD433W 1676	CPC2918PD433P 1844	"G" Option N/A	CPC2918PD433M 1314
Box/Box/File - Lateral (Box/Box-Left) 31 x 18 x 27	145	CPC3118PD443W 1772	CPC3118PD443P 1949	"G" Option N/A	CPC3118PD443M 1388
Box/Box/File-Lateral (Box/Box-Right) 31 x 18 x 27	145	CPC3118PD444W 1772	CPC3118PD444P 1949	"G" Option N/A	CPC3118PD444M 1388

Product Features

- Anti-tilt safety feature
- Legal/Letter filing
- Finished all sides and top - open plan
- "W" & "G" Box and File Drawers feature soft close suspensions (Lateral Drawers Feature ball bearing suspensions), "M" SKUs feature ball bearing suspensions. Both suspensions are full extension

2 Select Finish

[Click to view finishes](#)

WAC	WNW
WIC	WWP
WHC	WNF(Natural
WOC	Oak on Flat
WEC	Cut)
WAM	WSF(Salted
WCM	Oak on Flat
WEW	Cut)
WGW	WMF(Mocha
WBW	Oak on Flat
WSW	Cut)

TBCO
TBSW
TSTV
TSMV
TSLV
TOBW
WMO
WNO
WSO

MAC
MOC
MEC
MGW
MTW
MSW
MWL
MNA

3 Select Edge

[Click to view edges](#)

Edge
N/A

Edge
N/A

Edge
N/A

4 Select Hardware

[Click to view details](#)

See Intro Page
for Pull Options

See Intro Page
for Pull Options

See Intro Page
for Pull Options

See Intro Page
for Pull Options

Central Park

Single Storage Overhead Console
14" D Panel Door - 2/4/6 Section

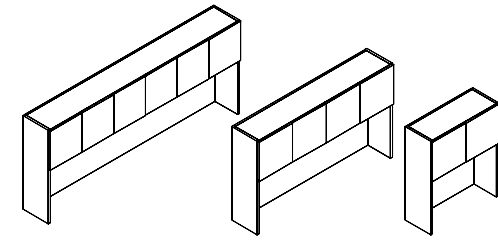

[Click here to view statement of line](#)

1 Select Model

Weight	w" x d" x h"
6 Door / 3 Section	93 x 14 x 42
	87 x 14 x 42
4 Door / 2 Section	83 x 14 x 42
	76 x 14 x 42
	70 x 14 x 42
	64 x 14 x 42
	58 x 14 x 42
	47 x 14 x 42
2 Door / 1 Section	35 x 14 x 42
	29 x 14 x 42

	Standard Veneer Top Standard Veneer Chassis		Premium Veneer Top Premium Veneer Chassis		High Pressure Laminate Top Veneer Chassis	Thermally Fused Laminate Top Thermally Fused Laminate Chassis
	CPC9342OH325W	4049	CPC9342OH325P	4454	"G" Option N/A	CPC9342OH325M 2644
	CPC8742OH325W	3823	CPC8742OH325P	4206	"G" Option N/A	CPC8742OH325M 2502
	CPC8342OH325W	3666	CPC8342OH325P	4033	"G" Option N/A	CPC8342OH325M 2033
	CPC7642OH325W	3395	CPC7642OH325P	3735	"G" Option N/A	CPC7642OH325M 1953
	CPC7042OH325W	3136	CPC7042OH325P	3450	"G" Option N/A	CPC7042OH325M 1675
	CPC6442OH325W	3107	CPC6442OH325P	3418	"G" Option N/A	CPC6442OH325M 1601
	CPC5842OH325W	3035	CPC5842OH325P	3339	"G" Option N/A	CPC5842OH325M 1536
	CPC4742OH325W	2959	CPC4742OH325P	3255	"G" Option N/A	CPC4742OH325M 1401
	CPC3542OH325W	2195	CPC3542OH325P	2415	"G" Option N/A	CPC3542OH325M 1237
	CPC2942OH325W	2161	CPC2942OH325P	2378	"G" Option N/A	CPC2942OH325M 1196
			TBCO			MAC
			TBSW			MOC
			TSTV			MEC
			TSMV			MGW
			TSLV			MTW
			TOBW			MSW
			WMO			MWL
			WNO			MNA
			WSO			
			Edge N/A			Edge N/A

Product Features

- Finished top
- Interior cabinet depth 12.5"
- Panel doors with concealed finger pull
- 5/8" grommet(s) included for task light wire management

Notes

- All units are standard w/ flush ends
- Unit has black back panel and is not designed for Open Plan use. Select OPB Option for Open Plan application

Options

Door

- D2: Door Lock - \$100 per door set
- D6: Delete doors - n/c
- D9SC: Soft Close Door Hinges - \$20 per door
- RF375AW: Aluminum/White Glass - \$395 per door
- WPD3061: Designer White - \$80 per door

Grommets (Vertical Surface)

- Standard Location - \$50 ea.
- Black Plastic Vertical Surface: TM50-C (Bottom Center)
- Non-Standard Location - \$95 ea.
- Black Plastic Vertical Surface: TM50-NS

Legal Depth

- MLD1: Modify to legal depth 18" - 10% upcharge

Open Plan _ Finished Back

- OPB: "W" "G" Style - Modify Unit for Open Plan Application - \$310
- OPB: "M" Style - Modify Unit for Open Plan Application - \$100

Task Lighting

Overhead task light cord is located on the right facing side. If the opposite location is required please contact customer service.

- LT-LED24: 24" LED Task light - \$215
- LT-LED48: 48" LED Task light - \$270
- LT-LED60: 60" LED Task light - \$335
- LT-LED72: 72" LED Task light - \$360

2 Select Finish

[Click to view finishes](#)

WAC	WNW
WIC	WWP
WHC	WNF(Natural
WOC	Oak on Flat
WEC	Cut)
WAM	WSF(Salted
WCM	Oak on Flat
WEW	Cut)
WGW	WMF(Mocha
WBW	Oak on Flat
WSW	Cut)

3 Select Edge

[Click to view edges](#)

Edge
N/A

4 Select Hardware

[Click to view details](#)

See Intro Page
for Pull Options

See Intro Page
for Pull Options

See Intro Page
for Pull Options

See Intro Page
for Pull Options

Central Park

Single Storage Overhead Console
 14" D SilverLuma Frame Doors / Frosted Inserts - 2/4/6 Section

[Click here to view statement of line](#)

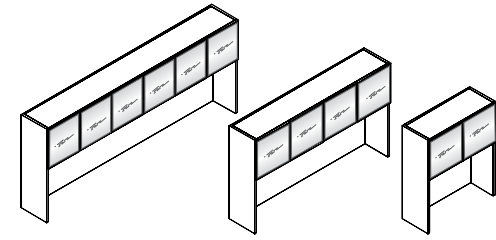

1 Select Model

w" x d" x h"

- 6 Door / 3 Section
- 93 x 14 x 42
- 87 x 14 x 42
- 4 Door / 2 Section
- 83 x 14 x 42
- 76 x 14 x 42
- 70 x 14 x 42
- 64 x 14 x 42
- 58 x 14 x 42
- 47 x 14 x 42
- 2 Door / 1 Section
- 35 x 14 x 42
- 29 x 14 x 42

Weight

- 315
- 285
- 275
- 255
- 240
- 225
- 210
- 190
- 120
- 105

Standard Veneer Top Standard Veneer Chassis	Premium Veneer Top Premium Veneer Chassis	High Pressure Laminate Top Veneer Chassis	Thermally Fused Laminate Top Thermally Fused Laminate Chassis
CPC9342OH321W 4985	CPC9342OH321P 5484	"G" Option N/A	CPC9342OH321M 3054
CPC8742OH321W 4759	CPC8742OH321P 5236	"G" Option N/A	CPC8742OH321M 2911
CPC8342OH321W 4293	CPC8342OH321P 4722	"G" Option N/A	CPC8342OH321M 2307
CPC7642OH321W 4017	CPC7642OH321P 4419	"G" Option N/A	CPC7642OH321M 2226
CPC7042OH321W 3760	CPC7042OH321P 4136	"G" Option N/A	CPC7042OH321M 1947
CPC6442OH321W 3730	CPC6442OH321P 4104	"G" Option N/A	CPC6442OH321M 1872
CPC5842OH321W 3660	CPC5842OH321P 4026	"G" Option N/A	CPC5842OH321M 1812
CPC4742OH321W 3580	CPC4742OH321P 3939	"G" Option N/A	CPC4742OH321M 1675
CPC3542OH321W 2491	CPC3542OH321P 2741	"G" Option N/A	CPC3542OH321M 1372
CPC2942OH321W 2460	CPC2942OH321P 2706	"G" Option N/A	CPC2942OH321M 1326

Product Features

- Finished top
- Interior cabinet depth 12.5"
- SilverLuma frame doors with frosted inserts
- 5/8" grommet(s) included for task light wire management

Notes

- Unit has black back panel and is not designed for Open Plan use. Select OPB Option for Open Plan application

Options

Door

- D2: Door Lock - \$100 per door set
- D9SC: Soft Close Door Hinges - \$20 per door
- DWF1: 2" Wood frame replaces SilverLuma Frame - n/c ("W" only)
- DWF2: 2" Wood frame w/ pull replaces SilverLuma Frame - \$20 per door ("W" only)

Grommets (Vertical Surface)

- Standard Location - \$50 ea.
- Black Plastic Vertical Surface: TM50-C (Bottom Center)
- Non-Standard Location - \$95 ea.
- Black Plastic Vertical Surface: TM50-NS

Interior Cabinet Light

- LEDPK starter kit includes Infeed, 1 Puck Interior Light and the ability to daisy chain up to 6 total Puck Lights
- LEDPK: LED Puck Starter Kit - \$310
- PK: 1 LED Interior Light - \$130 ea.

Legal Depth

- MLD1: Modify to legal depth 18" - 10% upcharge

Task Lighting

- Overhead task light cord is located on the right facing side. If the opposite location is required please contact customer service.
- LT-LED24: 24" LED Task light - \$215
- LT-LED48: 48" LED Task light - \$270
- LT-LED60: 60" LED Task light - \$335
- LT-LED72: 72" LED Task light - \$360

Open Plan _ Finished Back

- OPB: "W" "G" Style - Modify Unit for Open Plan Application - \$295
- OPB: "M" Style - Modify Unit for Open Plan Application - \$95

2 Select Finish

[Click to view finishes](#)

- WAC
- WIC
- WHC
- WOC
- WEC
- WAM
- WCM
- WEW
- WGW
- WBW
- WSW

- WNW
- WWP
- WNF(Natural Oak on Flat Cut)
- WSF(Salted Oak on Flat Cut)
- WMO (Oak on Flat Cut)
- WNO
- WSO
- WMF(Mocha Oak on Flat Cut)

- TBCO
- TBSW
- TSTV
- TSMV
- TSLV
- TOBW
- WMO
- WNO
- WSO

- MAC
- MOC
- MEC
- MGW
- MTW
- MSW
- MWL
- MNA

3 Select Edge

[Click to view edges](#)

- Edge
- N/A

- Edge
- N/A

- Edge
- N/A

4 Select Hardware

[Click to view details](#)

- Hardware
- N/A

- Hardware
- N/A

- Hardware
- N/A

Central Park

Single Storage Overhead Console
14" D Open Storage Console - 2/3 Section

[Click here to view statement of line](#)

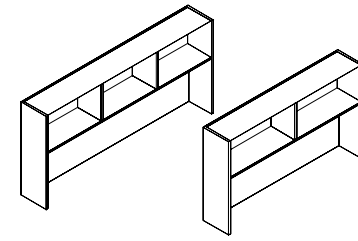

1 Select Model

w" x d" x h"
3 Section
93 x 14 x 42
87 x 14 x 42
83 x 14 x 42
76 x 14 x 42
2 Section
70 x 14 x 42
64 x 14 x 42
58 x 14 x 42

Weight

	Standard Veneer Top Standard Veneer Chassis	Premium Veneer Top Premium Veneer Chassis	High Pressure Laminate Top Veneer Chassis	Thermally Fused Laminate Top Thermally Fused Laminate Chassis
310	CPC9342OH346W 3580	CPC9342OH346P 3939	"G" Option N/A	CPC9342OH346M 2295
280	CPC8742OH346W 3358	CPC8742OH346P 3693	"G" Option N/A	CPC8742OH346M 2151
265	CPC8342OH346W 3278	CPC8342OH346P 3606	"G" Option N/A	CPC8342OH346M 1681
250	CPC7642OH346W 3082	CPC7642OH346P 3390	"G" Option N/A	CPC7642OH346M 1605
240	CPC7042OH346W 3071	CPC7042OH346P 3378	"G" Option N/A	CPC7042OH346M 1758
225	CPC6442OH346W 3043	CPC6442OH346P 3348	"G" Option N/A	CPC6442OH346M 1686
205	CPC5842OH346W 2975	CPC5842OH346P 3273	"G" Option N/A	CPC5842OH346M 1627

Product Features

- Finished top
- Interior cabinet depth 12.5"
- 5/8" grommet(s) included for task light wire management

Notes

- 2 section overhead available w/ 1 sliding door
- 3 Section Overhead Available w/ 1 or 2 Sliding Doors
- Unit has black back panel and is not designed for Open Plan use. Select OPB Option for Open Plan application

Options

Door

- RF550AW: Aluminum/White Glass - \$575 per door
- SLD17WD: Panel Door ("W" only) - \$260 per door
- SLD17LD: White Laminate Door ("W" only) - \$205 per door
- SLD17FD: SilverLuma / Frost Door ("W", "M" only) - \$365 per door
- SLD17MD: Panel Door ("M" only) - \$160

Interior Cabinet Light

- LEDPK starter kit includes Infeed, 1 Puck Interior Light and the ability to daisy chain up to 6 total Puck Lights
- LEDPK: LED Puck Starter Kit - \$310
- PK: 1 LED Interior Light - \$130 ea.

Legal Depth

- MLD1: Modify to legal depth 18" - 10% upcharge

Task Lighting

- Overhead task light cord is located on the right facing side. If the opposite location is required please contact customer service.
- LT-LED24: 24" LED Task light - \$215
- LT-LED48: 48" LED Task light - \$270
- LT-LED60: 60" LED Task light - \$335
- LT-LED72: 72" LED Task light - \$360

Open Plan _ Finished Back

- OPB: "W" "G" Style - Modify Unit for Open Plan Application - \$295
- OPB: "M" Style - Modify Unit for Open Plan Application - \$95

2 Select Finish

[Click to view finishes](#)

WAC
WIC
WHC
WOC
WEC
WAM
WCM
WEW
WGW
WBW
WSW

WNW
WWP
WNF(Natural
Oak on Flat
Cut)
WSF(Salted
Oak on Flat
Cut)
WMF(Mocha
Oak on Flat
Cut)

TBCO
TBSW
TSTV
TSMV
TSLV
TOBW
WMO
WNO
WSO

MAC
MOC
MEC
MGW
MTW
MSW
MWL
MNA

3 Select Edge

[Click to view edges](#)

Edge
N/A

Edge
N/A

Edge
N/A

4 Select Hardware

[Click to view details](#)

Hardware
N/A

Hardware
N/A

Hardware
N/A

Central Park

Double Storage Overhead Console
14" D Panel Door - 2/4/6 Section

[Click here to view statement of line](#)

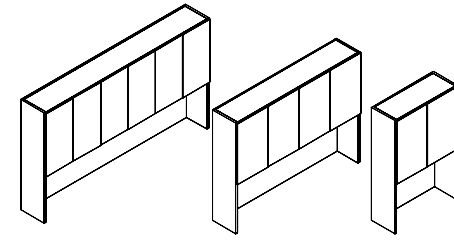

1 Select Model

w" x d" x h"	Weight
6 Door / 3 Section	
93 x 14 x 54	300
87 x 14 x 54	300
4 Door / 2 Section	
70 x 14 x 54	250
64 x 14 x 54	230
58 x 14 x 54	215
2 Door / 1 Section	
35 x 14 x 54	160
29 x 14 x 54	150

Standard Veneer Top Standard Veneer Chassis		Premium Veneer Top Premium Veneer Chassis		High Pressure Laminate Top Veneer Chassis		Thermally Fused Laminate Top Thermally Fused Laminate Chassis	
CPC9354OH325W	4985	CPC9354OH325P	5484	"G" Option N/A		CPC9354OH325M	3219
CPC8754OH325W	4673	CPC8754OH325P	5141	"G" Option N/A		CPC8754OH325M	3096
CPC7054OH325W	3940	CPC7054OH325P	4334	"G" Option N/A		CPC7054OH325M	2252
CPC6454OH325W	3823	CPC6454OH325P	4206	"G" Option N/A		CPC6454OH325M	2171
CPC5854OH325W	3745	CPC5854OH325P	4120	"G" Option N/A		CPC5854OH325M	1880
CPC3554OH325W	2638	CPC3554OH325P	2902	"G" Option N/A		CPC3554OH325M	1550
CPC2954OH325W	2607	CPC2954OH325P	2868	"G" Option N/A		CPC2954OH325M	1516

Product Features

- Adjustable finished shelf behind each door section
- Black painted top
- Interior cabinet depth 12.5"
- Panel doors with concealed finger pull
- 5/8" grommet(s) included for task light wire management

Notes

- "M" Styles have matching "M" Finish Shelf
- Unit has black back panel and is not designed for Open Plan use. Select OPB Option for Open Plan application

Options

Accessories

- D2: Door Lock - \$100 per door set
- D9SC: Soft Close Door Hinges - \$20 per door
- RF475AW: Aluminum/White Glass - \$495 per door
- WPD3061: Designer White - \$80 per door

Door

- D6: Delete doors - n/c

Grommets (Vertical Surface)

- Standard Location - \$50 ea.
- Black Plastic Vertical Surface: TM50-C (Bottom Center)
- Non-Standard Location - \$95 ea.
- Black Plastic Vertical Surface: TM50-NS

Legal Depth

- MLD1: Modify to legal depth 18" - 10% upcharge

Open Plan _ Finished Back

- OPB: "W" "G" Style - Modify Unit for Open Plan Application - \$295
- OPB: "M" Style - Modify Unit for Open Plan Application - \$95

Shelves

- S714F: Heavy Duty Lumber 1" Shelves - \$80 per shelf ("M" Styles - n/a)

Task Lighting (Recessed)

- Overhead task light cord is located on the right facing side. If the opposite location is required please contact customer service.
- LT-LED24: 24" LED Task light - \$215
- LT-LED48: 48" LED Task light - \$270
- LT-LED60: 60" LED Task light - \$335
- LT-LED72: 72" LED Task light - \$360

2 Select Finish

[Click to view finishes](#)

WAC	WNW	TBCO	MAC
WIC	WWP	TBSW	MOC
WHC	WNF(Natural	TSTV	MEC
WOC	Oak on Flat	TSMV	MGW
WEC	Cut)	TSLV	MTW
WAM	WSF(Salted	TOBW	MSW
WCM	Oak on Flat	WMO	MWL
WEW	Cut)	WNO	MNA
WGW	WMF(Mocha	WSO	
WBW	Oak on Flat		
WSW	Cut)		

3 Select Edge

[Click to view edges](#)

Edge
N/A

Edge
N/A

Edge
N/A

4 Select Hardware

[Click to view details](#)

See Intro Page
for Pull Options

See Intro Page
for Pull Options

See Intro Page
for Pull Options

See Intro Page
for Pull Options

Central Park

Double Storage Overhead Console
 14" D SilverLuma Frame Doors / Frosted Inserts - 2/4/6 Section

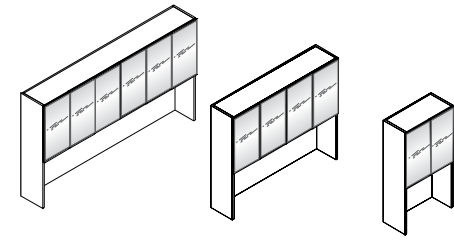

[Click here to view statement of line](#)

1 Select Model

w" x d" x h"
 6 Door / 3 Section
 93 x 14 x 54
 87 x 14 x 54
 4 Door / 2 Section
 70 x 14 x 54
 64 x 14 x 54
 58 x 14 x 54
 2 Door / 1 Section
 35 x 14 x 54
 29 x 14 x 54

Weight	Standard Veneer Top Standard Veneer Chassis		Premium Veneer Top Premium Veneer Chassis		High Pressure Laminate Top Veneer Chassis		Thermally Fused Laminate Top Thermally Fused Laminate Chassis	
300	CPC9354OH321W	5920	CPC9354OH321P	6513	"G" Option N/A	CPC9354OH321M	3905	
300	CPC8754OH321W	5609	CPC8754OH321P	6170	"G" Option N/A	CPC8754OH321M	3777	
250	CPC7054OH321W	4563	CPC7054OH321P	5020	"G" Option N/A	CPC7054OH321M	2705	
230	CPC6454OH321W	4447	CPC6454OH321P	4891	"G" Option N/A	CPC6454OH321M	2631	
215	CPC5854OH321W	4368	CPC5854OH321P	4805	"G" Option N/A	CPC5854OH321M	2332	
160	CPC3554OH321W	2936	CPC3554OH321P	3230	"G" Option N/A	CPC3554OH321M	1771	
150	CPC2954OH321W	2904	CPC2954OH321P	3195	"G" Option N/A	CPC2954OH321M	1727	

2 Select Finish

[Click to view finishes](#)

WAC WNW
 WIC WWP
 WHC WNF(Natural
 WOC Oak on Flat
 WEC Cut)
 WAM WSF(Salted
 WCM Oak on Flat
 WEW Cut)
 WGW WMF(Mocha
 WBW Oak on Flat
 WSW Cut)

TBCO
 TBSW
 TSTV
 TSMV
 TSLV
 TOBW
 WMO
 WNO
 WSO

MAC
 MOC
 MEC
 MGW
 MTW
 MSW
 MWL
 MNA

3 Select Edge

[Click to view edges](#)

Edge
 N/A

Edge
 N/A

Edge
 N/A

4 Select Hardware

[Click to view details](#)

Hardware
 N/A

Hardware
 N/A

Hardware
 N/A

Product Features

- Adjustable finished shelf behind each door section
- Black painted top
- Interior cabinet depth 12.5"
- SilverLuma frame doors with frosted inserts
- 5/8" grommet(s) included for task light wire management

Notes

- "M" Styles have matching "M" Finish Shelf
- Unit has black back panel and is not designed for Open Plan use. Select OPB Option for Open Plan application

Options

Door

- D2: Door Lock - \$100 per door set
- D9SC: Soft Close Door Hinges - \$20 per door
- DWF1: 2" Wood frame replaces SilverLuma Frame - n/c ("W" only)
- DWF2: 2" Wood frame w/ pull replaces SilverLuma Frame - \$20 per door ("W" only)

Grommets (Vertical Surface)

- Standard Location - \$50 ea.
- Black Plastic Vertical Surface: TM50-C (Bottom Center)
- Non-Standard Location - \$95 ea.
- Black Plastic Vertical Surface: TM50-NS

Interior Cabinet Light

- LEDPK starter kit includes Infeed, 1 Puck Interior Light and the ability to daisy chain up to 6 total Puck Lights
- LEDPK: LED Puck Starter Kit - \$310
- PK: 1 LED Interior Light - \$130 ea.

Legal Depth

- MLD1: Modify to legal depth 18" - 10% upcharge

Task Lighting

Overhead task light cord is located on the right facing side. If the opposite location is required please contact customer service.

- LT-LED24: 24" LED Task light - \$215
- LT-LED48: 48" LED Task light - \$270
- LT-LED60: 60" LED Task light - \$335
- LT-LED72: 72" LED Task light - \$360

Open Plan _ Finished Back

- OPB: "W" "G" Style - Modify Unit for Open Plan Application - \$295
- OPB: "M" Style - Modify Unit for Open Plan Application - \$95

Shelves

- GS14F: Replace Standard Shelves with Glass Shelves - \$90 per shelf
- S714F: Heavy Duty Lumber 1" Shelves - \$80 per shelf ("M" Styles - n/a)

Overhead tackboards
Full width tackboards

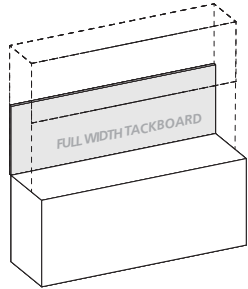

Product Width	Panel Dimension	SKU	COM	1	2	3	4	5	6	7	8	9	10	11/L1	12	13/L2
93"	91 x .75 x 21	FTOC9121	379	480	531	582	633	684	735	786	837	888	939	990	1041	1143
87"	85 x .75 x 21	FTOC8521	358	449	497	545	593	641	689	737	785	833	881	929	977	1073
83"	81 x .75 x 21	FTOC8121	336	428	474	520	566	612	658	704	750	796	842	888	934	1026
76"	74 x .75 x 21	FTOC7421	309	392	435	478	521	564	607	650	693	736	779	822	865	951
70"	68 x .75 x 21	FTOC6821	282	361	401	441	481	521	561	601	641	681	721	761	801	881
64"	62 x .75 x 21	FTOC6221	256	330	366	402	438	474	510	546	582	618	654	690	726	798
58"	56 x .75 x 21	FTOC5621	234	299	331	363	395	427	459	491	523	555	587	619	651	715
47"	45 x .75 x 21	FTOC4521	187	242	269	296	323	350	377	404	431	458	485	512	539	593
35"	33 x .75 x 21	FTOC3321	141	180	200	220	240	260	280	300	320	340	360	380	400	440
29"	27 x .75 x 21	FTOC2721	112	149	166	183	200	217	234	251	268	285	302	319	336	370

Overhead tackboards
Half width tackboards

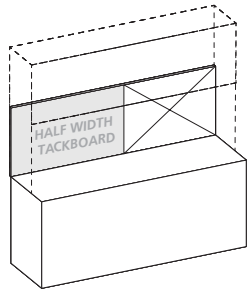

Standard Features

- Constructed of .5" thick fiberboard
- Hung with Z-Strip mounting system

- Fabric is precisely aligned and fitted to the tackboard
- Adhered to the rigid hardboard with glue

Product Width	Panel Dimension	SKU	COM	1	2	3	4	5	6	7	8	9	10	11/L1	12	13/L2
93 Half Width	46.5 x .75 x 21	FTOC4621	189	240	266	292	318	344	370	396	422	448	474	500	526	578
87 Half Width	43.5 x .75 x 21	FTOC4321	179	225	249	273	297	321	345	369	393	417	441	465	489	537
83 Half Width	41.5 x .75 x 21	FTOC4121	168	214	237	260	283	306	329	352	375	398	421	444	467	513
76 Half Width	38 x .75 x 21	FTOC3821	155	196	217	238	259	280	301	322	343	364	385	406	427	469
70 Half Width	35 x .75 x 21	FTOC3521	141	180	200	220	240	260	280	300	320	340	360	380	400	440
64 Half Width	32 x .75 x 21	FTOC3221	128	165	183	201	219	237	255	273	291	309	327	345	363	399

Standard Features

- Constructed of .5" thick fiberboard
- Fabric is precisely aligned and fitted to the tackboard
- Adhered to the rigid hardboard with glue
- Hung with Z-Strip mounting system

Notes

- Half width tackboards can be specified and combined with Marker Board, Slot Wall and Glass Board options. See "Half Width" items under product width.
- Must specify right or left facing tackboard

Overhead dry marker board
Full width dry marker boards

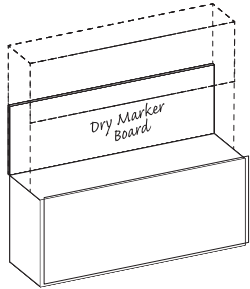

Product Width	Panel Dimension	SKU	List
93"	91 x .5 x 21	DMOC9121	1136
87"	85 x .5 x 21	DMOC8521	1061
83"	81 x .5 x 21	DMOC8121	1011
76"	74 x .5 x 21	DMOC7421	924
70"	68 x .5 x 21	DMOC6821	849
64"	62 x .5 x 21	DMOC6221	774
58"	56 x .5 x 21	DMOC5621	699
47"	45 x .5 x 21	DMOC4521	587
35"	33 x .5 x 21	DMOC3321	437
29"	27 x .5 x 21	DMOC2721	337

Overhead dry marker board
Half width dry marker boards

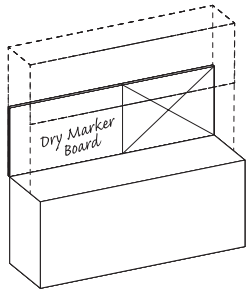

Standard Features

- Dry marker panel has edge trim molding
- Standard magnetic surface
- Hung with Z-Strip mounting system

Product Width	Panel Dimension	SKU	List
93 Half Width	45.5 x .5 x 21	DMOC4521	555
87 Half Width	42.5 x .5 x 21	DMOC4221	518
83 Half Width	40.5 x .5 x 21	DMOC4021	493
76 Half Width	37 x .5 x 21	DMOC3721	449
70 Half Width	34 x .5 x 21	DMOC3421	437
64 Half Width	31 x .5 x 21	DMOC3121	374

Standard Features

- Dry marker panel has edge trim molding
- Standard magnetic surface
- Hung with Z-Strip mounting system

Notes

- Half width dry marker boards can be specified and combined with a Tackboard, Veneer Panel, Slat Wall or Glass Board. See "Half Width" items under product width.
- Specify right or left facing dry marker board

Overhead glassboard
Full width glassboards

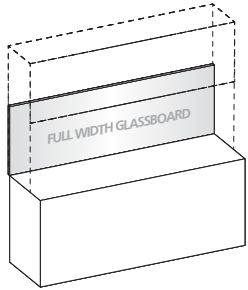

Product Width	Panel Dimension	SKU	List
93"	91 x .5 x 21	GBOC9121	2975
87"	85 x .5 x 21	GBOC8521	2815
83"	81 x .5 x 21	GBOC8121	2710
76"	74 x .5 x 21	GBOC7421	2525
70"	68 x .5 x 21	GBOC6821	2365
64"	62 x .5 x 21	GBOC6221	2210
58"	56 x .5 x 21	GBOC5621	2075
47"	45 x .5 x 21	GBOC4521	1760
35"	33 x .5 x 21	GBOC3321	1380
29"	27 x .5 x 21	GBOC2721	1220

Standard Features

- 4 mm tempered glass
- Hung with Z-Strip mounting system

Notes

- Standard dry erase markers may be used
- Earth magnets are required to hold items securely in place
- Use glass cleaner or alcohol to clean

Overhead glassboard
Half width glassboards

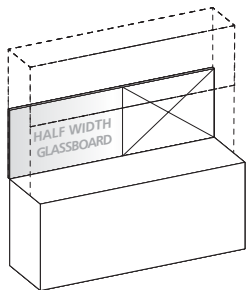

Product Width	Panel Dimension	SKU	List
93 Half Width	45.5 x .5 x 21	GBOC4521	1730
87 Half Width	42.5 x .5 x 21	GBOC4221	1650
83 Half Width	40.5 x .5 x 21	GBOC4021	1590
76 Half Width	37 x .5 x 21	GBOC3721	1500
70 Half Width	34 x .5 x 21	GBOC3421	1410
64 Half Width	31 x .5 x 21	GBOC3121	1320

Standard Features

- 4 mm tempered glass
- Hung with Z-Strip mounting system

Notes

- Half width glassboards can be specified and combined with a Tackboard, Veneer panel, Marker Board or Slat Wall. See "Half Width" items under product width.
- Specify right or left facing glassboard
- Use glass cleaner or alcohol to clean
- Standard dry erase markers may be used
- Earth magnets are required to hold items securely in place

Overhead slat wall
Half width slat wall

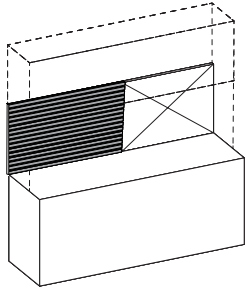

Product Width	Panel Dimension	SKU	List
93 Half Width	44.5 x .5 x 21	SWOC4421	463
87 Half Width	41.5 x .5 x 21	SWOC4121	432
83 Half Width	39.5 x .5 x 21	SWOC3921	411
76 Half Width	36 x .5 x 21	SWOC3621	374
70 Half Width	33 x .5 x 21	SWOC3321	343
64 Half Width	30 x .5 x 21	SWOC3021	312

Standard Features

- Available in silver or black
- Hung with Z-Strip mounting system

Notes

- Half width slat walls can be specified and combined with a Tackboard, Veneer panel, Marker Board or Glassboard. See "Half Width" items under product width.
- Must specify right or left facing slat wall

Central Park

Single Height Wall Hung Overheads
14" D Panel Doors - 1/2/3 Section

[Click here to view statement of line](#)

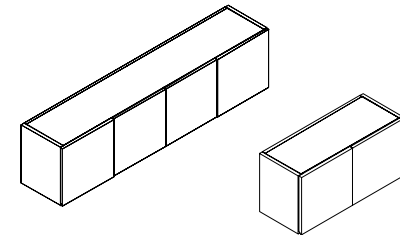

1 Select Model

w" x d" x h"	Weight
6 Door / 3 Section	
93 x 14 x 18	240
87 x 14 x 18	225
4 Door / 2 Section	
83 x 14 x 18	210
76 x 14 x 18	195
70 x 14 x 18	180
64 x 14 x 18	160
58 x 14 x 18	135
47 x 14 x 18	125
2 Door / 1 Section	
35 x 14 x 18	75
29 x 14 x 18	65

	Standard Veneer Top Standard Veneer Chassis		Premium Veneer Top Premium Veneer Chassis		High Pressure Laminate Top Veneer Chassis	Thermally Fused Laminate Top Thermally Fused Laminate Chassis
	CPC9318WH330W	4098	CPC9318WH330P	4508	"G" Option N/A	CPC9318WH330M 2606
	CPC8718WH330W	3939	CPC8718WH330P	4333	"G" Option N/A	CPC8718WH330M 2463
	CPC8318WH330W	3849	CPC8318WH330P	4235	"G" Option N/A	CPC8318WH330M 1941
	CPC7618WH330W	3781	CPC7618WH330P	4159	"G" Option N/A	CPC7618WH330M 1798
	CPC7018WH330W	3160	CPC7018WH330P	3477	"G" Option N/A	CPC7018WH330M 1661
	CPC6418WH330W	3112	CPC6418WH330P	3424	"G" Option N/A	CPC6418WH330M 1479
	CPC5818WH330W	3066	CPC5818WH330P	3373	"G" Option N/A	CPC5818WH330M 1562
	CPC4718WH330W	2343	CPC4718WH330P	2577	"G" Option N/A	CPC4718WH330M 1488
	CPC3518WH330W	1759	CPC3518WH330P	1935	"G" Option N/A	CPC3518WH330M 1059
	CPC2918WH330W	1729	CPC2918WH330P	1903	"G" Option N/A	CPC2918WH330M 1014

2 Select Finish

[Click to view finishes](#)

WAC	WNW
WIC	WWP
WHC	WNF(Natural
WOC	Oak on Flat
WEC	Cut)
WAM	WSF(Salted
WCM	Oak on Flat
WEW	Cut)
WGW	WMF(Mocha
WBW	Oak on Flat
WSW	Cut)

TBCO
TBSW
TSTV
TSMV
TSLV
TOBV
WMO
WNO
WSO

MAC
MOC
MEC
MGW
MTW
MSW
MWL
MNA

3 Select Edge

[Click to view edges](#)

Edge N/A

Edge N/A

Edge N/A

4 Select Hardware

[Click to view details](#)

See Intro Page
for Pull Options

See Intro Page
for Pull Options

See Intro Page
for Pull Options

See Intro Page
for Pull Options

Product Features

- Doors fully matched set
- Finished top
- Interior cabinet depth 12"
- Mounting wall rail included
- Panel doors with concealed finger pull

Notes

- All units are standard w/ flush ends
- The DARRAN wall mounted cabinet(or shelf) must be hung on a weight-bearing wall. The suitability of the wall supporting the wall mounted cabinet, and the installation and maintenance of the wall-mounted cabinet, is the sole responsibility of the customer. Failure to correctly install and/or exceed the loaded weight capacity of this product may cause it to fall, resulting in damage to the product, adjacent property and/or bodily injury.

Options

Door

- D2: Door Lock - \$100 per door set
- D6: Delete doors - n/c
- D9SC: Soft Close Door Hinges - \$20 per door
- RF375AW: Aluminum/White Glass - \$395 per door
- WPD3061: Designer White - \$80 per door

Legal Depth

- MLD1: Modify to legal depth 18" - 10% upcharge

Task Lighting

- Overhead task light cord is located on the right facing side. If the opposite location is required please contact customer service.
- LT-LED24: 24" LED Task light - \$215
- LT-LED48: 48" LED Task light - \$270
- LT-LED60: 60" LED Task light - \$335
- LT-LED72: 72" LED Task light - \$360

Central Park

Single Height Wall Hung Overheads
14" D Silverluma Frame / Frosted Doors - 1/2/3 Section

[Click here to view statement of line](#)

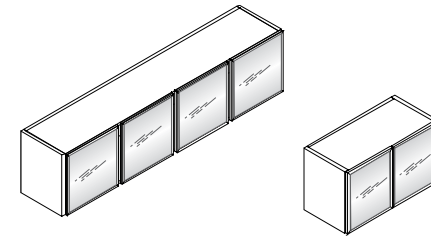

1 Select Model

w" x d" x h"
6 Door / 3 Section
93 x 14 x 18
87 x 14 x 18
4 Door / 2 Section
83 x 14 x 18
76 x 14 x 18
70 x 14 x 18
64 x 14 x 18
58 x 14 x 18
47 x 14 x 18
2 Door / 1 Section
35 x 14 x 18
29 x 14 x 18

Weight	Standard Veneer Top Standard Veneer Chassis	Premium Veneer Top Premium Veneer Chassis	High Pressure Laminate Top Veneer Chassis	Thermally Fused Laminate Top Thermally Fused Laminate Chassis
240	CPC9318WH331W 4633	CPC9318WH331P 5096	"G" Option N/A	CPC9318WH331M 3058
225	CPC8718WH331W 4545	CPC8718WH331P 4999	"G" Option N/A	CPC8718WH331M 2916
210	CPC8318WH331W 4447	CPC8318WH331P 4891	"G" Option N/A	CPC8318WH331M 2247
195	CPC7618WH331W 4387	CPC7618WH331P 4826	"G" Option N/A	CPC7618WH331M 2103
180	CPC7018WH331W 3663	CPC7018WH331P 4029	"G" Option N/A	CPC7018WH331M 1959
160	CPC6418WH331W 3546	CPC6418WH331P 3902	"G" Option N/A	CPC6418WH331M 1909
135	CPC5818WH331W 3437	CPC5818WH331P 3782	"G" Option N/A	CPC5818WH331M 1860
125	CPC4718WH331W 2630	CPC4718WH331P 2893	"G" Option N/A	CPC4718WH331M 1791
75	CPC3518WH331W 2005	CPC3518WH331P 2206	"G" Option N/A	CPC3518WH331M 1182
65	CPC2918WH331W 1915	CPC2918WH331P 2106	"G" Option N/A	CPC2918WH331M 1140

2 Select Finish

[Click to view finishes](#)

WAC	WNW
WIC	WWP
WHC	WNF(Natural
WOC	Oak on Flat
WEC	Cut)
WAM	WSF(Salted
WCM	Oak on Flat
WEW	Cut)
WGW	WMF(Mocha
WBW	Oak on Flat
WSW	Cut)

TBCO
TBSW
TSTV
TSMV
TSLV
TOBW
WMO
WNO
WSO

MAC
MOC
MEC
MGW
MTW
MSW
MWL
MNA

3 Select Edge

[Click to view edges](#)

Edge
N/A

Edge
N/A

Edge
N/A

4 Select Hardware

[Click to view details](#)

Hardware
N/A

Hardware
N/A

Hardware
N/A

Product Features

- Finished top
- Interior cabinet depth 12"
- Mounting wall rail included

Notes

- All units are standard w/ flush ends
- The DARRAN wall mounted cabinet(or shelf) must be hung on a weight-bearing wall. The suitability of the wall supporting the wall mounted cabinet, and the installation and maintenance of the wall-mounted cabinet, is the sole responsibility of the customer. Failure to correctly install and/or exceed the loaded weight capacity of this product may cause it to fall, resulting in damage to the product, adjacent property and/or bodily injury.

Options

Door

- D2: Door Lock - \$100 per door set
- D9SC: Soft Close Door Hinges - \$20 per door
- DWF1: 2" Wood frame replaces SilverLuma Frame - n/c ("W" only)
- DWF2: 2" Wood frame w/ pull replaces SilverLuma Frame - \$20 per door ("W" only)

Interior Cabinet Light

- LEDPK starter kit includes Infeed, 1 Puck Interior Light and the ability to daisy chain up to 6 total Puck Lights
- LEDPK: LED Puck Starter Kit - \$310
- PK: 1 LED Interior Light - \$130 ea.

Legal Depth

- MLD1: Modify to legal depth 18" - 10% upcharge

Task Lighting

Overhead task light cord is located on the right facing side. If the opposite location is required please contact customer service.

- LT-LED24: 24" LED Task light - \$215
- LT-LED48: 48" LED Task light - \$270
- LT-LED60: 60" LED Task light - \$335
- LT-LED72: 72" LED Task light - \$360

Central Park

Single Height Wall Hung Overheads
14" D Open Storage Cabinet - 1/2/3 Section

[Click here to view statement of line](#)

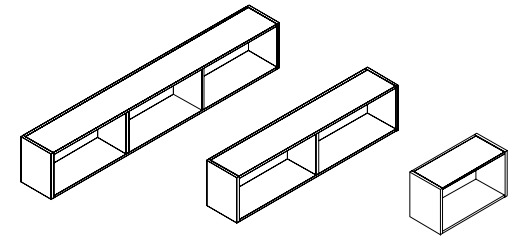

1 Select Model

w" x d" x h"	Weight
3 Section	
93 x 14 x 18	225
87 x 14 x 18	210
83 x 14 x 18	200
76 x 14 x 18	185
2 Section	
70 x 14 x 18	170
64 x 14 x 18	150
58 x 14 x 18	125
47 x 14 x 18	115
1 Section	
35 x 14 x 18	60
29 x 14 x 18	50

	Standard Veneer Top Standard Veneer Chassis	Premium Veneer Top Premium Veneer Chassis	High Pressure Laminate Top Veneer Chassis	Thermally Fused Laminate Top Thermally Fused Laminate Chassis
	CPC9318WH332W 3774	CPC9318WH332P 4152	"G" Option N/A	CPC9318WH332M 2209
	CPC8718WH332W 3739	CPC8718WH332P 4113	"G" Option N/A	CPC8718WH332M 2070
	CPC8318WH332W 3704	CPC8318WH332P 4075	"G" Option N/A	CPC8318WH332M 1556
	CPC7618WH332W 3663	CPC7618WH332P 4029	"G" Option N/A	CPC7618WH332M 1475
	CPC7018WH332W 2996	CPC7018WH332P 3296	"G" Option N/A	CPC7018WH332M 1395
	CPC6418WH332W 2949	CPC6418WH332P 3244	"G" Option N/A	CPC6418WH332M 1352
	CPC5818WH332W 2908	CPC5818WH332P 3199	"G" Option N/A	CPC5818WH332M 1301
	CPC4718WH332W 2171	CPC4718WH332P 2389	"G" Option N/A	CPC4718WH332M 1228
	CPC3518WH332W 1632	CPC3518WH332P 1796	"G" Option N/A	CPC3518WH332M 916
	CPC2918WH332W 1614	CPC2918WH332P 1775	"G" Option N/A	CPC2918WH332M 871
		TBCO		MAC
		TBSW		MOC
		TSTV		MEC
		TSMV		MGW
		TSLV		MTW
		TOBW		MSW
		WMO		MWL
		WNO		MNA
		WSO		
		Edge N/A		Edge N/A
		Hardware N/A		Hardware N/A

Product Features

- Finished top
- Interior cabinet depth 12"
- Mounting wall rail included

Notes

- 3 Section Overhead Available w/ 1 or 2 Sliding Doors
- 2 Section available w/ 1 sliding door
- All units are standard w/ flush ends
- The DARRAN wall mounted cabinet(or shelf) must be hung on a weight-bearing wall. The suitability of the wall supporting the wall mounted cabinet, and the installation and maintenance of the wall-mounted cabinet, is the sole responsibility of the customer. Failure to correctly install and/or exceed the loaded weight capacity of this product may cause it to fall, resulting in damage to the product, adjacent property and/or bodily injury.

Options

Door

- Not available in 29" and 35"
- RF550AW: Aluminum/White Glass - \$575 per door
- SLD17WD: Panel Door ("W" only) - \$250 per door
- SLD17LD: White Laminate Door ("W" only) - \$205 per door
- SLD17FD: SilverLuma / Frost Door ("W", "M" only) - \$365 per door
- SLD17MD: Panel Door ("M" only) - \$160

Interior Cabinet Light

- LEDPK starter kit includes Infeed, 1 Puck Interior Light and the ability to daisy chain up to 6 total Puck Lights
- LEDPK: LED Puck Starter Kit - \$310
- PK: 1 LED Interior Light - \$130 ea.

Legal Depth

- MLD1: Modify to legal depth 18" - 10% upcharge

Task Lighting

- Overhead task light cord is located on the right facing side. If the opposite location is required please contact customer service.
- LT-LED24: 24" LED Task light - \$215
- LT-LED48: 48" LED Task light - \$270
- LT-LED60: 60" LED Task light - \$335
- LT-LED72: 72" LED Task light - \$360

2 Select Finish

[Click to view finishes](#)

WAC	WNW
WIC	WWP
WHC	WNF(Natural
WOC	Oak on Flat
WEC	Cut)
WAM	WSF(Salted
WCM	Oak on Flat
WEW	Cut)
WGW	WMF(Mocha
WBW	Oak on Flat
WSW	Cut)

3 Select Edge

[Click to view edges](#)

Edge N/A

4 Select Hardware

[Click to view details](#)

Hardware N/A

Central Park

Double Height Wall Hung Overheads
14" D Panel Doors - 2/4/6 Section

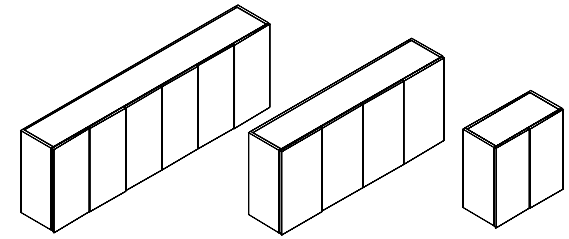

[Click here to view statement of line](#)

1 Select Model

w" x d" x h"	Weight
6 Door / 3 Section	
93 x 14 x 29	265
87 x 14 x 29	220
4 Door / 2 Section	
70 x 14 x 29	220
64 x 14 x 29	200
58 x 14 x 29	180
2 Door / 1 Section	
35 x 14 x 29	85
29 x 14 x 29	75

Standard Veneer Top Standard Veneer Chassis		Premium Veneer Top Premium Veneer Chassis		High Pressure Laminate Top Veneer Chassis		Thermally Fused Laminate Top Thermally Fused Laminate Chassis	
CPC9329WH330W	4764	CPC9329WH330P	5240	"G" Option N/A		CPC9329WH330M	3203
CPC8729WH330W	4689	CPC8729WH330P	5158	"G" Option N/A		CPC8729WH330M	3058
CPC7029WH330W	3897	CPC7029WH330P	4287	"G" Option N/A		CPC7029WH330M	2146
CPC6429WH330W	3863	CPC6429WH330P	4250	"G" Option N/A		CPC6429WH330M	2103
CPC5829WH330W	3787	CPC5829WH330P	4166	"G" Option N/A		CPC5829WH330M	2015
CPC3529WH330W	2046	CPC3529WH330P	2251	"G" Option N/A		CPC3529WH330M	1444
CPC2929WH330W	1998	CPC2929WH330P	2199	"G" Option N/A		CPC2929WH330M	1401

Product Features

- Adjustable finished shelf behind each door section
- Black painted top
- Doors fully matched set
- Interior cabinet depth 12"
- Mounting wall rail included

Notes

- "M" Styles have matching "M" Finish Shelf
- The DARRAN wall mounted cabinet(or shelf) must be hung on a weight-bearing wall. The suitability of the wall supporting the wall mounted cabinet, and the installation and maintenance of the wall-mounted cabinet, is the sole responsibility of the customer. Failure to correctly install and/or exceed the loaded weight capacity of this product may cause it to fall, resulting in damage to the product, adjacent property and/or bodily injury.

Options

Door

- D2: Door Lock - \$100 per door set
- D9SC: Soft Close Door Hinges - \$20 per door
- RF475AW: Aluminum/White Glass - \$495 per door
- WPD3061: Designer White - \$80 per door

Legal Depth

- MLD1: Modify to legal depth 18" - 10% upcharge

Shelves

- S714F: Heavy Duty Lumber 1" Shelves - \$80 per shelf ("M" Styles - n/a)

Task Lighting

- Overhead task light cord is located on the right facing side. If the opposite location is required please contact customer service.
- LT-LED24: 24" LED Task light - \$215
- LT-LED48: 48" LED Task light - \$270
- LT-LED60: 60" LED Task light - \$335
- LT-LED72: 72" LED Task light - \$360

2 Select Finish

[Click to view finishes](#)

WAC	WNW	TBCO	MAC
WIC	WWP	TBSW	MOC
WHC	WNF(Natural	TSTV	MEC
WOC	Oak on Flat	TSMV	MGW
WEC	Cut)	TSLV	MTW
WAM	WSF(Salted	TOBW	MSW
WCM	Oak on Flat	WMO	MWL
WEW	Cut)	WNO	MNA
WGW	WMF(Mocha	WSO	
WBW	Oak on Flat		
WSW	Cut)		

3 Select Edge

[Click to view edges](#)

Edge
N/A

Edge
N/A

Edge
N/A

4 Select Hardware

[Click to view details](#)

See Intro Page
for Pull Options

See Intro Page
for Pull Options

See Intro Page
for Pull Options

See Intro Page
for Pull Options

Central Park

Double Height Wall Hung Overheads
 14" D Silverluma Frame / Frosted Doors - 2/4/6 Section

[Click here to view statement of line](#)

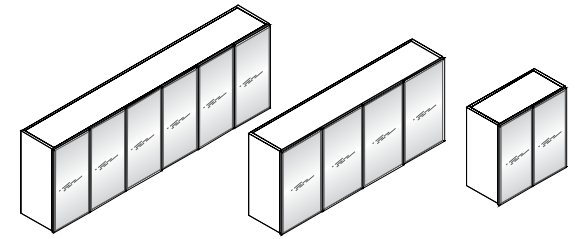

1 Select Model

w" x d" x h"	Weight
6 Door / 3 Section	
93 x 14 x 29	265
87 x 14 x 29	250
4 Door / 2 Section	
70 x 14 x 29	220
64 x 14 x 29	200
58 x 14 x 29	180
2 Door / 1 Section	
35 x 14 x 29	85
29 x 14 x 29	75

Standard Veneer Top Standard Veneer Chassis		Premium Veneer Top Premium Veneer Chassis		High Pressure Laminate Top Veneer Chassis		Thermally Fused Laminate Top Thermally Fused Laminate Chassis	
CPC9329WH331W	5886	CPC9329WH331P	6475	"G" Option N/A		CPC9329WH331M	3954
CPC8729WH331W	5708	CPC8729WH331P	6279	"G" Option N/A		CPC8729WH331M	3812
CPC7029WH331W	4676	CPC7029WH331P	5143	"G" Option N/A		CPC7029WH331M	2648
CPC6429WH331W	4551	CPC6429WH331P	5007	"G" Option N/A		CPC6429WH331M	2606
CPC5829WH331W	4374	CPC5829WH331P	4812	"G" Option N/A		CPC5829WH331M	2518
CPC3529WH331W	2479	CPC3529WH331P	2728	"G" Option N/A		CPC3529WH331M	1687
CPC2929WH331W	2343	CPC2929WH331P	2577	"G" Option N/A		CPC2929WH331M	1650
WAC	WNW	TBCO				MAC	
WIC	WWP	TBSW				MOC	
WHC	WNF(Natural	TSTV				MEC	
WOC	Oak on Flat	TSMV				MGW	
WEC	Cut)	TSLV				MTW	
WAM	WSF(Salted	TOBW				MSW	
WCM	Oak on Flat	WMO				MWL	
WEW	Cut)	WNO				MNA	
WGW	WMF(Mocha	WSO					
WBW	Oak on Flat						
WSW	Cut)						
Edge N/A		Edge N/A				Edge N/A	
Hardware N/A		Hardware N/A				Hardware N/A	

2 Select Finish

[Click to view finishes](#)

3 Select Edge

[Click to view edges](#)

4 Select Hardware

[Click to view details](#)

Product Features

- Adjustable finished shelf behind each door section
- Black painted top
- Interior cabinet depth 12"
- Mounting wall rail included

Notes

- The DARRAN wall mounted cabinet(or shelf) must be hung on a weight-bearing wall. The suitability of the wall supporting the wall mounted cabinet, and the installation and maintenance of the wall-mounted cabinet, is the sole responsibility of the customer. Failure to correctly install and/or exceed the loaded weight capacity of this product may cause it to fall, resulting in damage to the product, or adjacent property and/or bodily injury.

Options

Door

- D2: Door Lock - \$100 per door set
- D9SC: Soft Close Door Hinges - \$20 per door
- DWF1: 2" Wood frame replaces SilverLuma Frame - n/c ("W" only)
- DWF2: 2" Wood frame w/ pull replaces SilverLuma Frame - \$20 per door ("W" only)

Interior Cabinet Light

LEDPK starter kit includes Infeed, 1 Puck Interior Light and the ability to daisy chain up to 6 total Puck Lights

- LEDPK: LED Puck Starter Kit - \$310
- PK: 1 LED Interior Light - \$130 ea.

Legal Depth

- MLD1: Modify to legal depth 18" - 10% upcharge

Task Lighting

Overhead task light cord is located on the right facing side. If the opposite location is required please contact customer service.

- LT-LED24: 24" LED Task light - \$215
- LT-LED48: 48" LED Task light - \$270
- LT-LED60: 60" LED Task light - \$335
- LT-LED72: 72" LED Task light - \$360

Shelves

- GS14F: Replace Standard Shelves with Glass Shelves - \$90 per shelf
- S714F: Heavy Duty Lumber 1" Shelves - \$80 per shelf ("M" Styles - n/a)

Central Park

Double Height Wall Hung Overheads
14" D Open Storage Cabinet - 1/2/3 Section

[Click here to view statement of line](#)

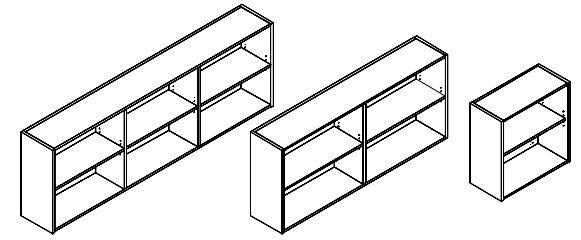

1 Select Model

w" x d" x h"	Weight
3 Section	
93 x 14 x 29	205
87 x 14 x 29	190
2 Section	
70 x 14 x 29	190
64 x 14 x 29	170
58 x 14 x 29	150
1 Section	
35 x 14 x 29	70
29 x 14 x 29	60

	Standard Veneer Top Standard Veneer Chassis		Premium Veneer Top Premium Veneer Chassis		High Pressure Laminate Top Veneer Chassis	Thermally Fused Laminate Top Thermally Fused Laminate Chassis
2 Select Finish Click to view finishes	WAC	WNW	TBCO			MAC
	WIC	WWP	TBSW			MOC
	WHC	WNF(Natural	TSTV			MEC
	WOC	Oak on Flat	TSMV			MGW
	WEC	Cut)	TSLV			MTW
	WAM	WSF(Salted	TOBW			MSW
	WCM	Oak on Flat	WMO			MWL
	WEW	Cut)	WNO			MNA
	WGW	WMF(Mocha	WSO			
	WBW	Oak on Flat				
	WSW	Cut)				
3 Select Edge Click to view edges		Edge N/A	Edge N/A			Edge N/A
4 Select Hardware Click to view details	Hardware N/A		Hardware N/A			Hardware N/A

Product Features

- Adjustable finished shelf
- Black painted top
- Interior cabinet depth 12"

Notes

- 2 section overhead available w/ 1 sliding door
- 3 Section Overhead Available w/ 1 or 2 Sliding Doors
- The DARRAN wall mounted cabinet(or shelf) must be hung on a weight-bearing wall. The suitability of the wall supporting the wall mounted cabinet, and the installation and maintenance of the wall-mounted cabinet, is the sole responsibility of the customer. Failure to correctly install and/or exceed the loaded weight capacity of this product may cause it to fall, resulting in damage to the product, adjacent property and/or bodily injury.

Options

Door

- Not available on one section units
- RF850AW: Aluminum/White Glass - \$1090
- SLD29WD: Wood/Laminate Panel Door ("W" only) - \$310 per door
- SLD29LD: White Laminate Door ("W" only) - \$260 per door
- SLD29FD: SilverLuma / Frost Door ("W", "M" only) - \$415 per door
- SLD29MD: Panel Door ("M" only) - \$205

Interior Cabinet Light

- LEDPK starter kit includes Infeed, 1 Puck Interior Light and the ability to daisy chain up to 6 total Puck Lights
- LEDPK: LED Puck Starter Kit - \$310
- PK: 1 LED Interior Light - \$130 ea.

Legal Depth

- MLD1: Modify to legal depth 18" - 10% upcharge

Task Lighting

- Overhead task light cord is located on the right facing side. If the opposite location is required please contact customer service.
- LT-LED24: 24" LED Task light - \$215
- LT-LED48: 48" LED Task light - \$270
- LT-LED60: 60" LED Task light - \$335
- LT-LED72: 72" LED Task light - \$360

Shelves

- GS14F: Replace Standard Shelves with Glass Shelves - \$90 per shelf
- S714F: Heavy Duty Lumber 1" Shelves - \$80 per shelf ("M" Styles - n/a)

Wall hung tackboards
Full width tackboards

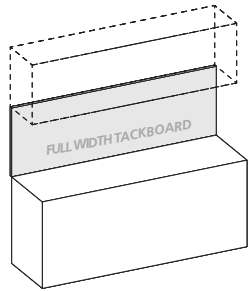

Product Width	Panel Dimension	SKU	COM	1	2	3	4	5	6	7	8	9	10	11/L1	12	13/L2
93	93 x .75 x 24	FTWH9324	465	576	627	678	729	780	831	882	933	984	1035	1086	1137	1239
87	87 x .75 x 24	FTWH8724	448	539	587	635	683	731	779	827	875	923	971	1019	1067	1163
83	83 x .75 x 24	FTWH8324	422	514	560	606	652	698	744	790	836	882	928	974	1020	1112
76	76 x .75 x 24	FTWH7624	388	471	514	557	600	643	686	729	772	815	858	901	944	1030
70	70 x .75 x 24	FTWH7024	355	434	474	514	554	594	634	674	714	754	794	834	874	954
64	64 x .75 x 24	FTWH6424	322	396	432	468	504	540	576	612	648	684	720	756	792	864
58	58 x .75 x 24	FTWH5824	294	359	391	423	455	487	519	551	583	615	647	679	711	775
47	47 x .75 x 24	FTWH4724	236	291	318	345	372	399	426	453	480	507	534	561	588	642
35	35 x .75 x 24	FTWH3524	176	217	237	257	277	297	317	337	357	377	397	417	437	477
29	29 x .75 x 24	FTWH2924	142	179	196	213	230	247	264	281	298	315	332	349	366	400

Standard Features

- Adhered to the rigid hardboard with glue

- Constructed of .5" thick fiberboard
- Fabric is precisely aligned and fitted to the tackboard
- Hung with Z-Strip mounting system

Wall hung tackboards
Half width tackboards

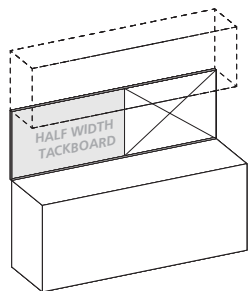

Product Width	Panel Dimension	SKU	COM	1	2	3	4	5	6	7	8	9	10	11/L1	12	13/L2
93 Half Width	46.5 x .75 x 24	FTWH4624	233	288	313	338	363	388	413	438	463	488	513	538	563	613
87 Half Width	43.5 x .75 x 24	FTWH4324	225	270	294	318	342	366	390	414	438	462	486	510	534	582
83 Half Width	41.5 x .75 x 24	FTWH4124	211	257	280	303	326	349	372	395	418	441	464	487	510	556
76 Half Width	38 x .75 x 24	FTWH3824	194	235	256	277	298	319	340	361	382	403	424	445	466	508
70 Half Width	35 x .75 x 24	FTWH3524	178	217	237	257	277	297	317	337	357	377	397	417	437	477
64 Half Width	32 x .75 x 24	FTWH3224	161	198	216	234	252	270	288	306	324	342	360	378	396	432

Standard Features

Notes

- Constructed of .5" thick fiberboard
- Fabric is precisely aligned and fitted to the tackboard
- Adhered to the rigid hardboard with glue
- Hung with Z-Strip mounting system

- Half width tackboards can be specified and combined with a Veneer Panel, Marker Board, Slat Wall or Glass Board. See "Half Width" items under product width.
- Specify right or left facing tackboard

Wall hung dry marker board
Full width dry marker board

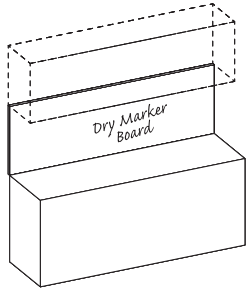

Product Width	Panel Dimension	SKU	List
93	93 x .75 x 24	DMWH9324	1161
87	87 x .75 x 24	DMWH8724	1086
83	83 x .75 x 24	DMWH8324	1023
76	76 x .75 x 24	DMWH7624	948
70	70 x .75 x 24	DMWH7024	874
64	64 x .75 x 24	DMWH6424	799
58	58 x .75 x 24	DMWH5824	724
47	47 x .75 x 24	DMWH4724	587
35	35 x .75 x 24	DMWH3524	437
29	29 x .75 x 24	DMWH2924	362

Wall hung dry marker board
Half width dry marker board

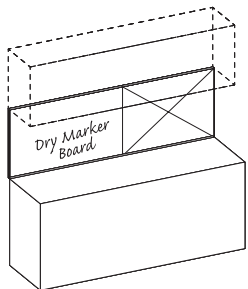

Standard Features

- Dry marker panel has edge trim molding
- Standard magnetic surface
- Hung with Z-Strip mounting system

Product Width	Panel Dimension	SKU	List
93 Half Width	46.5 x .75 x 24	DMWH4624	580
87 Half Width	43.5 x .75 x 24	DMWH4324	543
83 Half Width	41.5 x .75 x 24	DMWH4124	518
76 Half Width	38 x .75 x 24	DMWH3824	474
70 Half Width	35 x .75 x 24	DMWH3524	437
64 Half Width	32 x .75 x 24	DMWH3224	399

Standard Features

- Dry marker panel has edge trim molding
- Standard magnetic surface
- Hung with Z-Strip mounting system

Notes

- Half width dry marker boards can be specified and combined with a Tackboard, Veneer Panel, Slat Wall or Glass Board. See "Half Width" items under product width.
- Specify right or left facing dry marker board

Wall hung veneer panel
Full width veneer panel

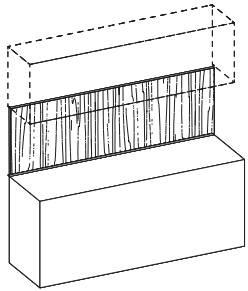

Product Width	Panel Dimension	SKU	List
93	93 x .75 x 24	VPWH9324	967
87	87 x .75 x 24	VPWH8724	905
83	83 x .75 x 24	VPWH8324	853
76	76 x .75 x 24	VPWH7624	790
70	70 x .75 x 24	VPWH7024	728
64	64 x .75 x 24	VPWH6424	666
58	58 x .75 x 24	VPWH5824	603
47	47 x .75 x 24	VPWH4724	489
35	35 x .75 x 24	VPWH3524	364
29	29 x .75 x 24	VPWH2924	302

Standard Features

- Veneer edges
- Hung with Z-Strip mounting system

Notes

- Vertical wire channels on back for task light cords
- Steel mounting wall channel is recessed for flush mounting

Wall hung veneer panel
Half width veneer panel

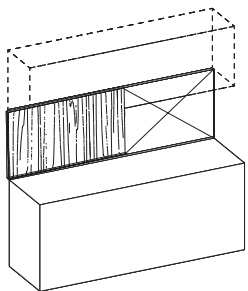

Product Width	Panel Dimension	SKU	List
93 Half Width	46.5 x .75 x 24	VPWH4624	484
87 Half Width	43.5 x .75 x 24	VPWH4324	452
83 Half Width	41.5 x .75 x 24	VPWH4124	432
76 Half Width	38 x .75 x 24	VPWH3824	395
70 Half Width	35 x .75 x 24	VPWH3524	364
64 Half Width	32 x .75 x 24	VPWH3224	333

Standard Features

- Veneer edges
- Vertical wire channels on back for task light cords
- Steel mounting wall channel is recessed for flush mounting
- Hung with Z-Strip mounting system

Notes

- Half width veneer panels can be specified and combined with a Tackboard, Marker Board, Slat Wall or Glass Board. See "Half Width" items under product width.
- Specify right or left facing veneer panel
- Can be used with or without overhead cabinet
- Required for other accessory panels

Wall hung glassboard
Full width glass

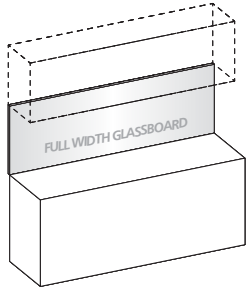

Product Width	Panel Dimension	SKU	List
93	93 x .75 x 24	GBWH9324	3110
87	87 x .75 x 24	GBWH8724	2945
83	83 x .75 x 24	GBWH8324	2835
76	76 x .75 x 24	GBWH7624	2645
70	70 x .75 x 24	GBWH7024	2480
64	64 x .75 x 24	GBWH6424	2320
58	58 x .75 x 24	GBWH5824	2155
47	47 x .75 x 24	GBWH4724	1855
35	35 x .75 x 24	GBWH3524	1525
29	29 x .75 x 24	GBWH2924	1300

Standard Features

- 4 mm tempered glass

Notes

- Earth magnets are required to hold items securely in place
- Hung with Z-Strip mounting system
- Use glass cleaner or alcohol to clean
- Standard dry erase markers may be used

Wall hung glassboard
Half width glass

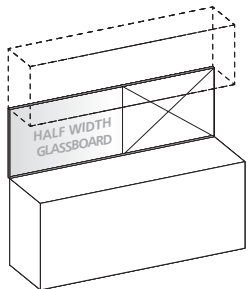

Product Width	Panel Dimension	SKU	List
93 Half Width	46.5 x .75 x 24	GBWH4624	1461
87 Half Width	43.5 x .75 x 24	GBWH4324	1378
83 Half Width	41.5 x .75 x 24	GBWH4124	1323
76 Half Width	38 x .75 x 24	GBWH3824	1232
70 Half Width	35 x .75 x 24	GBWH3524	1142
64 Half Width	32 x .75 x 24	GBWH3224	1059

Standard Features

- 4 mm tempered glass

Notes

- Half width glassboards can be specified and combined with a Tackboard, Veneer panel, Marker Board or Slat Wall. See "Half Width" items under product width.
- Specify right or left facing glassboard
- Use glass cleaner or alcohol to clean
- Standard dry erase markers may be used
- Earth magnets are required to hold items securely in place
- Hung with Z-Strip mounting system

Wall hung slat wall
Half width slat wall

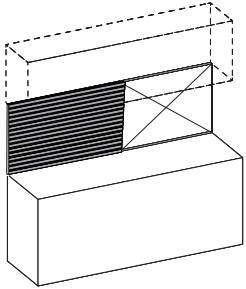

Product Width	Panel Dimension	SKU	List
93 Half Width	46.5 x .75 x 24	SWWH4624	484
87 Half Width	43.5 x .75 x 24	SWWH4324	452
83 Half Width	41.5 x .75 x 24	SWWH4124	432
76 Half Width	38 x .75 x 24	SWWH3824	395
70 Half Width	35 x .75 x 24	SWWH3524	364
64 Half Width	32 x .75 x 24	SWWH3224	333

Standard Features

- Available in silver or black
- Hung with Z-Strip mounting system

Notes

- Half width slat walls can be specified and combined with a Tackboard, Veneer panel, Marker Board or Glassboard. See "Half Width" items under product width.
- Specify right or left facing slat wall

Central Park
Glass Wall Hung Board

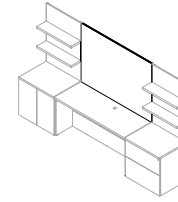

[Click here to view statement of line](#)

1 Select Model

Weight

w" x d" x h"
72 x .75 x 42
60 x .75 x 42
48 x .75 x 42
42 x .75 x 42

White Glass Wall Hung Board				
GBWH7242	3887			
GBWH6042	3435			
GBWH4842	2877			
GBWH4242	2650			

Product Features

- 4 mm tempered glass
- Hung with Z-Strip mounting system

Notes

- Standard dry erase markers may be used
- Earth magnets are required to hold items securely in place
- Use glass cleaner or alcohol to clean

2 Select Finish

[Click to view finishes](#)

Finishes N/A

3 Select Edge

[Click to view edges](#)

Edge
N/A

4 Select Hardware

[Click to view details](#)

Hardware
N/A

Central Park

Single Height Wall Hung Shelf
Open Endless Shelf - 2 Shelves

[Click here to view statement of line](#)

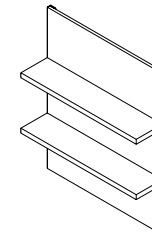

1 Select Model

w" x d" x h"
29 x 9 x 42
35 x 9 x 42

Weight

Standard Veneer Top Standard Veneer Chassis	Premium Veneer Top Premium Veneer Chassis	High Pressure Laminate Top Veneer Chassis	Thermally Fused Laminate Top Thermally Fused Laminate Chassis
CPC2942WH337W 1402 CPC3542WH337W 1650	CPC2942WH337P 1543 CPC3542WH337P 1815	"G" Option N/A "G" Option N/A	CPC2942WH337M 1128 CPC3542WH337M 1326
WAC WNW WIC WWP WHC WNF(Natural WOC Oak on Flat WEC Cut) WAM WSF(Salted WCM Oak on Flat WEW Cut) WGW WMF(Mocha WBW Oak on Flat WSW Cut)	TBCO TBSW TSTV TSMV TSLV TOBW WMO WNO WSO	Edge N/A	MAC MOC MEC MGW MTW MSW MWL MNA Edge N/A
3 Select Edge Click to view edges	Hardware N/A	Hardware N/A	Hardware N/A

Product Features

- Mounting rails included
- Distance between shelves is 13-1/4"
- Shelving will not align with other wall shelf or cabinet units

Notes

- The DARRAN wall mounted cabinet(or shelf) must be hung on a weight-bearing wall. The suitability of the wall supporting the wall mounted cabinet, and the installation and maintenance of the wall-mounted cabinet, is the sole responsibility of the customer. Failure to correctly install and/or exceed the loaded weight capacity of this product may cause it to fall, resulting in damage to the product, adjacent property and/or bodily injury.
- 93" shelf will support 28lbs of additional weight, 87" shelf will support 29lbs, 83" shelf will support 31lbs, 76" shelf will support 22lbs, 70"shelf will support 24lbs, 64" shelf will support 25lbs, 58" shelf will support 16lbs, 47" shelf will support 18lbs, 35" shelf will support 22lbs, 29" shelf will support 23lbs.

Options

Task Lighting

- Overhead task light cord is located on the right facing side. If the opposite location is required please contact customer service.
- LT-LED24: 24" LED Task light - \$215

Central Park

Double Height Wall Hung Shelf
Open Endless Shelf - 3 Shelves

[Click here to view statement of line](#)

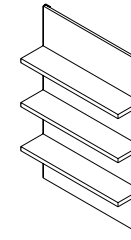

1 Select Model

w" x d" x h"
29 x 9 x 54
35 x 9 x 54

Weight

Standard Veneer Top Standard Veneer Chassis	Premium Veneer Top Premium Veneer Chassis	High Pressure Laminate Top Veneer Chassis	Thermally Fused Laminate Top Thermally Fused Laminate Chassis
CPC2954WH337W 1553 CPC3554WH337W 1826	CPC2954WH337P 1709 CPC3554WH337P 2009	"G" Option N/A "G" Option N/A	CPC2954WH337M 1246 CPC3554WH337M 1468
WAC WNW WIC WWP WHC WNF(Natural WOC Oak on Flat WEC Cut) WAM WSF(Salted WCM Oak on Flat WEW Cut) WGW WMF(Mocha WBW Oak on Flat WSW Cut)	TBCO TBSW TSTV TSMV TSLV TOBW WMO WNO WSO	Edge N/A	MAC MOC MEC MGW MTW MSW MWL MNA Edge N/A
Edge N/A	Hardware N/A	Hardware N/A	Hardware N/A

2 Select Finish

[Click to view finishes](#)

3 Select Edge

[Click to view edges](#)

4 Select Hardware

[Click to view details](#)

Hardware
N/A

Product Features

- Mounting rails included
- Distance between shelves is 12-1/2"
- Shelving will not align with other wall shelf or cabinet units

Notes

- The DARRAN wall mounted cabinet(or shelf) must be hung on a weight-bearing wall. The suitability of the wall supporting the wall mounted cabinet, and the installation and maintenance of the wall-mounted cabinet, is the sole responsibility of the customer. Failure to correctly install and/or exceed the loaded weight capacity of this product may cause it to fall, resulting in damage to the product, adjacent property and/or bodily injury.
- 93" shelf will support 28lbs of additional weight, 87" shelf will support 29lbs, 83" shelf will support 31lbs, 76" shelf will support 22lbs, 70"shelf will support 24lbs, 64" shelf will support 25lbs, 58" shelf will support 16lbs, 47" shelf will support 18lbs, 35" shelf will support 22lbs, 29" shelf will support 23lbs.

Options

Task Lighting

- Overhead task light cord is located on the right facing side. If the opposite location is required please contact customer service.
- LT-LED24: 24" LED Task light - \$215

Central Park

Single Height Wall Hung Overheads
Open Endless Shelf Single Height

[Click here to view statement of line](#)

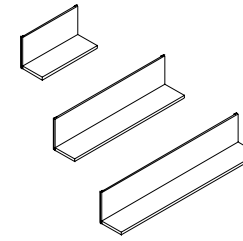

1 Select Model

w" x d" x h"	Weight
93 x 9 x 18	100
87 x 9 x 18	95
83 x 9 x 18	90
76 x 9 x 18	85
70 x 9 x 18	80
64 x 9 x 18	75
58 x 9 x 18	70
47 x 9 x 18	50
35 x 9 x 18	35
29 x 9 x 18	30

Standard Veneer Top Standard Veneer Chassis		Premium Veneer Top Premium Veneer Chassis		High Pressure Laminate Top Veneer Chassis		Thermally Fused Laminate Top Thermally Fused Laminate Chassis	
CPC9318WH336W	3320	CPC9318WH336P	3652	"G" Option N/A		CPC9318WH336M	2012
CPC8718WH336W	3112	CPC8718WH336P	3424	"G" Option N/A		CPC8718WH336M	1937
CPC8318WH336W	2974	CPC8318WH336P	3272	"G" Option N/A		CPC8318WH336M	1874
CPC7618WH336W	2733	CPC7618WH336P	3007	"G" Option N/A		CPC7618WH336M	1814
CPC7018WH336W	2528	CPC7018WH336P	2781	"G" Option N/A		CPC7018WH336M	1772
CPC6418WH336W	2321	CPC6418WH336P	2553	"G" Option N/A		CPC6418WH336M	1662
CPC5818WH336W	2115	CPC5818WH336P	2327	"G" Option N/A		CPC5818WH336M	1584
CPC4718WH336W	1833	CPC4718WH336P	2017	"G" Option N/A		CPC4718WH336M	1282
CPC3518WH336W	1407	CPC3518WH336P	1547	"G" Option N/A		CPC3518WH336M	1053
CPC2918WH336W	1201	CPC2918WH336P	1322	"G" Option N/A		CPC2918WH336M	971
2 Select Finish Click to view finishes WAC WNW WIC WWP WHC WNF(Natural WOC Oak on Flat WEC Cut) WAM WSF(Salted WCM Oak on Flat WEW Cut) WGW WMF(Mocha WBW Oak on Flat WSW Cut)		TBCO TBSW TSTV TSMV TSLV TOBW WMO WNO WSO		Finish N/A		MAC MOC MEC MGW MTW MSW MWL	
3 Select Edge Click to view edges Edge N/A		Edge N/A		Edge N/A		Edge N/A	
4 Select Hardware Click to view details Hardware N/A		Hardware N/A		Hardware N/A		Hardware N/A	

Product Features

- Mounting rails included

Notes

- The DARRAN wall mounted cabinet(or shelf) must be hung on a weight-bearing wall. The suitability of the wall supporting the wall mounted cabinet, and the installation and maintenance of the wall-mounted cabinet, is the sole responsibility of the customer. Failure to correctly install and/or exceed the loaded weight capacity of this product may cause it to fall, resulting in damage to the product, adjacent property and/or bodily injury.
 - 93" shelf will support 28lbs of additional weight, 87" shelf will support 29lbs, 83" shelf will support 31lbs, 76" shelf will support 22lbs, 70"shelf will support 24lbs, 64" shelf will support 25lbs, 58" shelf will support 16lbs, 47" shelf will support 18lbs, 35" shelf will support 22lbs, 29" shelf will support 23lbs.

Options

Task Lighting

Overhead task light cord is located on the right facing side. If the oppo- site location is required please contact customer service.

- LT-LED24: 24" LED Task light - \$215
- LT-LED48: 48" LED Task light - \$270
- LT-LED60: 60" LED Task light - \$335
- LT-LED72: 72" LED Task light - \$360

Central Park

Double Height Wall Hung Overheads
Open Endless Shelf Double Height

[Click here to view statement of line](#)

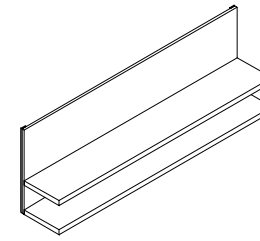

1 Select Model

w" x d" x h"	Weight
93 x 9 x 29	160
87 x 9 x 29	150
83 x 9 x 29	140
76 x 9 x 29	130
70 x 9 x 29	120
64 x 9 x 29	110
58 x 9 x 29	100
47 x 9 x 29	80
35 x 9 x 29	60
29 x 9 x 29	50

Standard Veneer Top Standard Veneer Chassis		Premium Veneer Top Premium Veneer Chassis		High Pressure Laminate Top Veneer Chassis	Thermally Fused Laminate Top Thermally Fused Laminate Chassis																																												
CPC9329WH336W	3932	CPC9329WH336P	4326	"G" Option N/A	CPCS9329WH336M 2369																																												
CPC8729WH336W	3686	CPC8729WH336P	4055	"G" Option N/A	CPC8729WH336M 2288																																												
CPC8329WH336W	3520	CPC8329WH336P	3872	"G" Option N/A	CPC8329WH336M 2208																																												
CPC7629WH336W	3230	CPC7629WH336P	3554	"G" Option N/A	CPC7629WH336M 2131																																												
CPC7029WH336W	2983	CPC7029WH336P	3281	"G" Option N/A	CPC7029WH336M 2079																																												
CPC6429WH336W	2733	CPC6429WH336P	3007	"G" Option N/A	CPC6429WH336M 1948																																												
CPC5829WH336W	2487	CPC5829WH336P	2736	"G" Option N/A	CPC5829WH336M 1856																																												
CPC4729WH336W	2148	CPC4729WH336P	2363	"G" Option N/A	CPC4729WH336M 1494																																												
CPC3529WH336W	1640	CPC3529WH336P	1804	"G" Option N/A	CPC3529WH336M 1218																																												
CPC2929WH336W	1394	CPC2929WH336P	1533	"G" Option N/A	CPC2929WH336M 1119																																												
<p>2 Select Finish Click to view finishes</p> <table border="0"> <tr><td>WAC</td><td>WNW</td><td>TBCO</td><td>MAC</td></tr> <tr><td>WIC</td><td>WWP</td><td>TBSW</td><td>MOC</td></tr> <tr><td>WHC</td><td>WNF(Natural</td><td>TSTV</td><td>MEC</td></tr> <tr><td>WOC</td><td>Oak on Flat</td><td>TSMV</td><td>MGW</td></tr> <tr><td>WEC</td><td>Cut)</td><td>TSLV</td><td>MTW</td></tr> <tr><td>WAM</td><td>WSF(Salted</td><td>TOBW</td><td>MSW</td></tr> <tr><td>WCM</td><td>Oak on Flat</td><td>WMO</td><td>MWL</td></tr> <tr><td>WEW</td><td>Cut)</td><td>WNO</td><td></td></tr> <tr><td>WGW</td><td>WMF(Mocha</td><td>WSO</td><td></td></tr> <tr><td>WBW</td><td>Oak on Flat</td><td></td><td></td></tr> <tr><td>WSW</td><td>Cut)</td><td></td><td></td></tr> </table>		WAC	WNW	TBCO	MAC	WIC	WWP	TBSW	MOC	WHC	WNF(Natural	TSTV	MEC	WOC	Oak on Flat	TSMV	MGW	WEC	Cut)	TSLV	MTW	WAM	WSF(Salted	TOBW	MSW	WCM	Oak on Flat	WMO	MWL	WEW	Cut)	WNO		WGW	WMF(Mocha	WSO		WBW	Oak on Flat			WSW	Cut)			<p>Edge N/A</p>		<p>Edge N/A</p>	
WAC	WNW	TBCO	MAC																																														
WIC	WWP	TBSW	MOC																																														
WHC	WNF(Natural	TSTV	MEC																																														
WOC	Oak on Flat	TSMV	MGW																																														
WEC	Cut)	TSLV	MTW																																														
WAM	WSF(Salted	TOBW	MSW																																														
WCM	Oak on Flat	WMO	MWL																																														
WEW	Cut)	WNO																																															
WGW	WMF(Mocha	WSO																																															
WBW	Oak on Flat																																																
WSW	Cut)																																																
<p>3 Select Edge Click to view edges</p>		<p>Hardware N/A</p>		<p>Hardware N/A</p>																																													
<p>4 Select Hardware Click to view details</p>																																																	

Product Features

- Mounting rails included

Notes

- The DARRAN wall mounted cabinet(or shelf) must be hung on a weight-bearing wall. The suitability of the wall supporting the wall mounted cabinet, and the installation and maintenance of the wall-mounted cabinet, is the sole responsibility of the customer. Failure to correctly install and/or exceed the loaded weight capacity of this product may cause it to fall, resulting in damage to the product, adjacent property and/or bodily injury.

- 93" shelf will support 28lbs of additional weight, 87" shelf will support 29lbs, 83" shelf will support 31lbs, 76" shelf will support 22lbs, 70"shelf will support 24lbs, 64" shelf will support 25lbs, 58" shelf will support 16lbs, 47" shelf will support 18lbs, 35" shelf will support 22lbs, 29" shelf will support 23lbs.

Options

Task Lighting

Overhead task light cord is located on the right facing side. If the opposite location is required please contact customer service.

- LT-LED24: 24" LED Task light - \$215
- LT-LED48: 48" LED Task light - \$270
- LT-LED60: 60" LED Task light - \$335
- LT-LED72: 72" LED Task light - \$360

Central Park

Floating Wall Mounted Shelf

Single Shelf

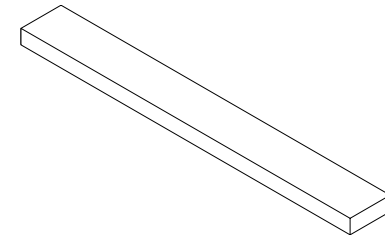

[Click here to view statement of line](#)

1 Select Model

w" x d" x h"	Weight
93 x 9 x 1	22
87 x 8 x 1	21
83 x 8 x 1	19
76 x 8 x 1	18
70 x 8 x 1	16
64 x 8 x 1	15
58 x 8 x 1	14
47 x 8 x 1	12
35 x 8 x 1	8
29 x 8 x 1	7

Standard Veneer Top Standard Veneer Chassis		Premium Veneer Top Premium Veneer Chassis		High Pressure Laminate Top Veneer Chassis	Thermally Fused Laminate Top Thermally Fused Laminate Chassis
CPC9309WH338W	857	CPC9308WH338P	943	"G" Option N/A	CPC9308WH338M 566
CPC8708WH338W	811	CPC8708WH338P	893	"G" Option N/A	CPC8708WH338M 545
CPC8308WH338W	783	CPC8308WH338P	862	"G" Option N/A	CPC8308WH338M 530
CPC7608WH338W	738	CPC7608WH338P	813	"G" Option N/A	CPC7608WH338M 505
CPC7008WH338W	694	CPC7008WH338P	763	"G" Option N/A	CPC7008WH338M 482
CPC6408WH338W	650	CPC6408WH338P	716	"G" Option N/A	CPC6408WH338M 460
CPC5808WH338W	605	CPC5808WH338P	666	"G" Option N/A	CPC5808WH338M 439
CPC4708WH338W	525	CPC4708WH338P	578	"G" Option N/A	CPC4708WH338M 398
CPC3508WH338W	438	CPC3508WH338P	482	"G" Option N/A	CPC3508WH338M 354
CPC2908WH338W	393	CPC2908WH338P	432	"G" Option N/A	CPC2908WH338M 333
2 Select Finish Click to view finishes WAC WNW WIC WWP WHC WNF(Natural WOC Oak on Flat WEC Cut) WAM WSF(Salted WCM Oak on Flat WEW Cut) WGW WMF(Mocha WBW Oak on Flat WSW Cut)		TBCO TBSW TSTV TSMV TSLV TOBW WMO WNO WSO		Finish N/A	MAC MOC MEC MGW MTW MSW MWL MNA
3 Select Edge Click to view edges Edge N/A		Edge N/A		Edge N/A	Edge N/A
4 Select Hardware Click to view details Hardware N/A		Hardware N/A		Hardware N/A	Hardware N/A

Product Features

- Wall brackets included
- Wall brackets provide horizontal and vertical adjustments

Notes

- The DARRAN wall mounted cabinet(or shelf) must be hung on a weight-bearing wall. The suitability of the wall supporting the wall mounted cabinet, and the installation and maintenance of the wall-mounted cabinet, is the sole responsibility of the customer. Failure to correctly install and/or exceed the loaded weight capacity of this product may cause it to fall, resulting in damage to the product, adjacent property and/or bodily injury.
- 93" shelf will support 28lbs of additional weight, 87" shelf will support 29lbs, 83" shelf will support 31lbs, 76" shelf will support 22lbs, 70"shelf will support 24lbs, 64" shelf will support 25lbs, 58" shelf will support 16lbs, 47" shelf will support 18lbs, 35" shelf will support 22lbs, 29" shelf will support 23lbs.

Wall hung tackboards
30" height

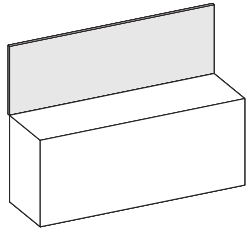

Product Width	Panel Dimension	SKU	COM	1	2	3	4	5	6	7	8	9	10	11/L1	12	13/L2
93"	93 x .75 x 30	FTWH9330	518	624	675	726	777	828	879	930	981	1032	1-83	1134	1185	1287
87"	87 x .75 x 30	FTWH8730	498	597	645	693	741	789	837	885	933	981	1029	1077	1125	1221
83"	83 x .75 x 30	FTWH8330	469	564	610	656	702	748	794	840	886	932	978	1024	1070	1162
76"	76 x .75 x 30	FTWH7630	431	518	561	604	647	690	733	776	819	862	905	948	991	1077
70"	70 x .75 x 30	FTWH7030	395	475	515	555	595	635	675	715	755	795	835	875	915	995
64"	64 x .75 x 30	FTWH6430	359	432	468	504	540	576	612	648	684	720	756	792	828	900
58"	58 x .75 x 30	FTWH5830	327	426	459	492	525	558	591	624	657	690	723	756	789	855
47"	47 x .75 x 30	FTWH4730	263	317	344	371	398	425	452	479	506	533	560	587	614	668
35"	35 x .75 x 30	FTWH3530	196	236	256	276	296	316	336	356	376	396	416	436	456	496
29"	29 x .75 x 30	FTWH2930	159	193	209	225	241	257	273	289	305	321	337	353	369	401

36" height

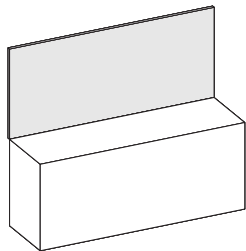

Product Width	Panel Dimension	SKU	COM	1	2	3	4	5	6	7	8	9	10	11/L1	12	13/L2
93"	93 x .75 x 36	FTWH9336	571	677	728	779	830	881	932	983	1034	1085	1136	1187	1238	1340
87"	87 x .75 x 36	FTWH8736	547	646	694	742	790	838	886	934	982	1030	1078	1126	1174	1270
83"	83 x .75 x 36	FTWH8336	517	612	658	704	750	796	842	888	934	980	1026	1072	1118	1210
76"	76 x .75 x 36	FTWH7636	475	562	605	648	691	734	777	820	863	906	949	992	1035	1121
70"	70 x .75 x 36	FTWH7036	435	515	555	595	635	675	715	755	795	835	875	915	995	1075
64"	64 x .75 x 36	FTWH6436	395	468	504	540	576	612	648	684	720	756	792	828	864	936
58"	58 x .75 x 36	FTWH5836	360	426	459	492	525	558	591	624	657	690	723	756	789	855
47"	47 x .75 x 36	FTWH4736	290	344	371	398	425	452	479	506	533	560	587	614	641	695
35"	35 x .75 x 36	FTWH3536	216	256	276	296	316	336	356	376	396	416	436	456	476	516
29"	29 x .75 x 36	FTWH2936	175	209	225	241	257	273	289	305	321	337	353	369	385	417

Wall hung tackboards
42" height

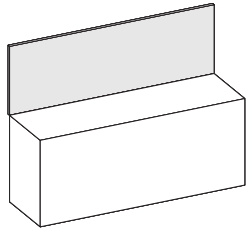

Product Width	Panel Dimension	SKU	COM	1	2	3	4	5	6	7	8	9	10	11/L1	12	13/L2
93"	93 x .75 x 42	FTWH9342	624	730	781	832	883	934	985	1036	1087	1138	1189	1240	1291	1393
87"	87 x .75 x 42	FTWH8742	597	696	744	792	840	888	936	984	1032	1080	1128	1176	1224	1320
83"	83 x .75 x 42	FTWH8342	564	659	705	751	797	843	889	935	981	1027	1073	1119	1165	1257
76"	76 x .75 x 42	FTWH7642	518	605	648	691	734	777	820	863	906	949	992	1035	1078	1164
70"	70 x .75 x 42	FTWH7042	475	555	595	635	675	715	755	795	835	875	915	955	995	1075
64"	64 x .75 x 42	FTWH6442	432	505	541	577	613	649	685	721	757	793	829	865	901	973
58"	58 x .75 x 42	FTWH5842	393	459	492	525	558	591	624	657	690	723	756	789	822	888
47"	47 x .75 x 42	FTWH4742	317	371	398	425	452	479	506	533	560	587	614	641	668	722
35"	35 x .75 x 42	FTWH3542	236	276	296	316	336	356	376	396	416	436	456	476	496	536
29"	29 x .75 x 42	FTWH2942	192	226	242	258	274	290	306	322	338	354	370	286	402	434

48" height

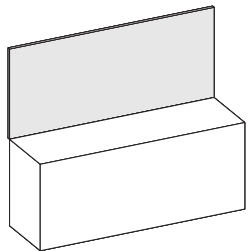

Product Width	Panel Dimension	SKU	COM	1	2	3	4	5	6	7	8	9	10	11/L1	12	13/L2
93"	93 x .75 x 48	FTWH9348	678	784	835	886	937	988	1039	1090	1141	1192	1243	1294	1345	1447
87"	87 x .75 x 48	FTWH8748	647	746	794	842	890	938	986	1034	1082	1086	1130	1178	1226	1322
83"	83 x .75 x 48	FTWH8348	612	707	753	799	845	891	937	983	1029	1075	1121	1167	1213	1305
76"	76 x .75 x 48	FTWH7648	562	649	692	735	778	821	864	907	950	993	1036	1079	1122	1208
70"	70 x .75 x 48	FTWH7048	515	595	635	675	715	755	795	835	875	915	955	995	1035	1115
64"	64 x .75 x 48	FTWH6448	468	541	577	613	649	685	721	757	793	829	865	901	937	1009
58"	58 x .75 x 48	FTWH5848	427	493	459	492	525	558	591	624	657	690	723	756	789	855
47"	47 x .75 x 48	FTWH4748	343	397	424	451	478	505	532	559	586	613	640	667	694	748
35"	35 x .75 x 48	FTWH3548	256	296	316	336	356	376	396	416	436	456	476	296	516	556
29"	29 x .75 x 48	FTWH2948	208	242	258	274	290	306	322	338	354	370	386	402	418	450

Wall hung glassboard
24" height

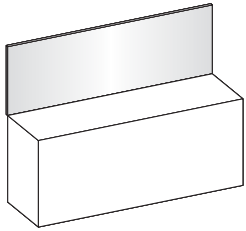

Product Width	Panel Dimension	SKU	List
93	93 x .75 x 24	GBWH9324	3110
87	87 x .75 x 24	GBWH8724	2945
83	83 x .75 x 24	GBWH8324	2835
76	76 x .75 x 24	GBWH7624	2645
70	70 x .75 x 24	GBWH7024	2480
64	64 x .75 x 24	GBWH6424	2320
58	58 x .75 x 24	GBWH5824	2155
47	47 x .75 x 24	GBWH4724	1855
35	35 x .75 x 24	GBWH3524	1525
29	29 x .75 x 24	GBWH2924	1300

Notes

- Ice white back painted glass
- Earth magnets are required to hold items securely in place
- Hanging hardware included
- Use glass cleaner or alcohol to clean
- Standard dry erase markers may be used
- Use with 29"h credenzas and 18" h wall cabinets. Finish height 53" AFF.

30" height

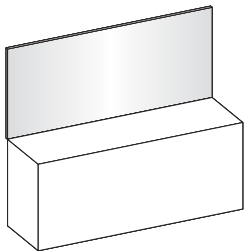

Product Width	Panel Dimension	SKU	List
93	93 x .75 x 30	GBWH9330	3690
87	87 x .75 x 30	GBWH8730	3500
83	83 x .75 x 30	GBWH8330	3370
76	76 x .75 x 30	GBWH7630	3025
70	70 x .75 x 30	GBWH7030	2835
64	64 x .75 x 30	GBWH6430	2645
58	58 x .75 x 30	GBWH5830	2455
47	47 x .75 x 30	GBWH4730	2110
35	35 x .75 x 30	GBWH3530	1730
29	29 x .75 x 30	GBWH2930	1540

Notes

- Ice white back painted glass
- Earth magnets are required to hold items securely in place
- Hanging hardware included
- Use glass cleaner or alcohol to clean
- Standard dry erase markers may be used
- Use with 23"h bench credenzas and 18" h wall cabinets. Finish height 53" AFF.

Wall hung glassboard
36" height

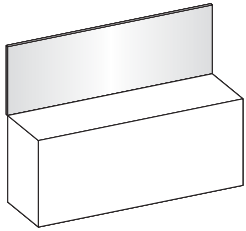

Product Width	Panel Dimension	SKU	List
93	93 x .75 x 36	GBWH9336	4140
87	87 x .75 x 36	GBWH8736	3925
83	83 x .75 x 36	GBWH8336	3870
76	76 x .75 x 36	GBWH7636	3530
70	70 x .75 x 36	GBWH7036	3315
64	64 x .75 x 36	GBWH6436	2970
58	58 x .75 x 36	GBWH5836	2755
47	47 x .75 x 36	GBWH4736	2360
35	35 x .75 x 36	GBWH3536	1930
29	29 x .75 x 36	GBWH2936	1715

Notes

- Ice white back painted glass
- Earth magnets are required to hold items securely in place
- Hanging hardware included
- Use glass cleaner or alcohol to clean
- Standard dry erase markers may be used
- Use with 29"h credenzas and 18" h wall cabinets. Finish height 65" AFF.

42" height

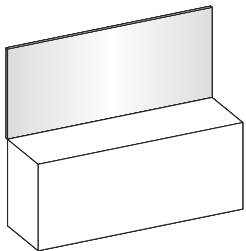

Product Width	Panel Dimension	SKU	List
93	93 x .75 x 42	GBWH9342	4595
87	87 x .75 x 42	GBWH8742	4355
83	83 x .75 x 42	GBWH8342	4190
76	76 x .75 x 42	GBWH7642	3910
70	70 x .75 x 42	GBWH7042	3670
64	64 x .75 x 42	GBWH6442	3440
58	58 x .75 x 42	GBWH5842	3185
47	47 x .75 x 42	GBWH4742	2615
35	35 x .75 x 42	GBWH3542	2130
29	29 x .75 x 42	GBWH2942	1895

Notes

- Ice white back painted glass
- Earth magnets are required to hold items securely in place
- Hanging hardware included
- Use glass cleaner or alcohol to clean
- Standard dry erase markers may be used
- Use with 29"h credenzas. Finish height 71" AFF.

Wall hung glassboard
48" height

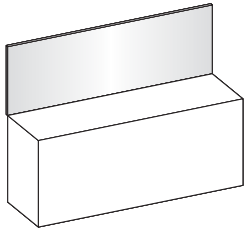

Product Width	Panel Dimension	SKU	List
93	93 x .75 x 48	GBWH9348	5045
87	87 x .75 x 48	GBWH8748	4780
83	83 x .75 x 48	GBWH8348	4600
76	76 x .75 x 48	GBWH7648	4290
70	70 x .75 x 48	GBWH7048	4020
64	64 x .75 x 48	GBWH6448	3755
58	58 x .75 x 48	GBWH5848	3490
47	47 x .75 x 48	GBWH4748	2870
35	35 x .75 x 48	GBWH3548	2325
29	29 x .75 x 48	GBWH2948	2070

Notes

- Ice white back painted glass
- Earth magnets are required to hold items securely in place
- Hanging hardware included
- Use glass cleaner or alcohol to clean
- Standard dry erase markers may be used
- Use with 23"h bench credenzas. Finish height 71" AFF.

54" height

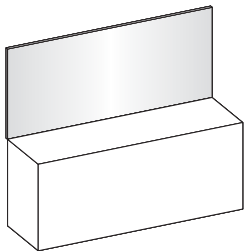

Product Width	Panel Dimension	SKU	List
93	93 x .75 x 54	GBWH9354	5500
87	87 x .75 x 54	GBWH8754	5210
83	83 x .75 x 54	GBWH8354	5010
76	76 x .75 x 54	GBWH7654	4670
70	70 x .75 x 54	GBWH7054	4375
64	64 x .75 x 54	GBWH6454	4085
58	58 x .75 x 54	GBWH5854	3610
47	47 x .75 x 54	GBWH4754	3255
35	35 x .75 x 54	GBWH3554	2525
29	29 x .75 x 54	GBWH2954	2250

Notes

- Ice white back painted glass
- Earth magnets are required to hold items securely in place
- Hanging hardware included
- Use glass cleaner or alcohol to clean
- Standard dry erase markers may be used
- Use with 29"h credenzas. Finish height 71" AFF.

Wall hung glassboard
60" height

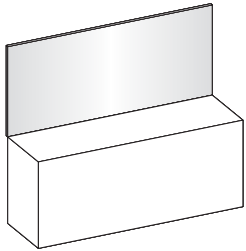

Product Width	Panel Dimension	SKU	List
93	93 x .75 x 60	GBWH9360	5950
87	87 x .75 x 60	GBWH8760	5635
83	83 x .75 x 60	GBWH8360	5420
76	76 x .75 x 60	GBWH7660	5045
70	70 x .75 x 60	GBWH7060	4730
64	64 x .75 x 60	GBWH6460	4410
58	58 x .75 x 60	GBWH5860	4090
47	47 x .75 x 60	GBWH4760	3510
35	35 x .75 x 60	GBWH3560	2725
29	29 x .75 x 60	GBWH2960	2420

Notes

- Ice white back painted glass
- Earth magnets are required to hold items securely in place
- Hanging hardware included
- Use glass cleaner or alcohol to clean
- Standard dry erase markers may be used
- Use with 23"h bench credenzas. Finish height 83" AFF.

Wall hung Veneer panels
30" height

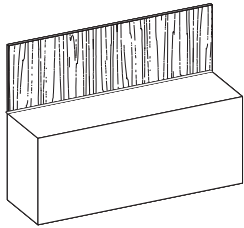

Product Width	Panel Dimension	SKU	List
93	93 x 1 x 30	VPWH9330	1210
87	87 x 1 x 30	VPWH8730	1130
83	83 x 1 x 30	VPWH8330	1080
76	76 x 1 x 30	VPWH7630	990
70	70 x 1 x 30	VPWH7030	910
64	64 x 1 x 30	VPWH6430	830
58	58 x 1 x 30	VPWH5824	755
47	47 x 1 x 30	VPWH4724	610
35	35 x 1 x 30	VPWH3524	455
29	29 x 1 x 30	GBWH2930	380

Notes

- Use with 23" h bench credenzas and 18" h wall cabinets. Finish height is 53" AFF.
- Hanging hardware included.
- Vertical grain direction.
- Add 10% for Premium finishes.
- Wall boards selected in veneer are not standard from the same flitch so grain pattern will vary. Light finishes may have some color variation.
- If matching panels are required, contact Customer Service for quote.

36" height

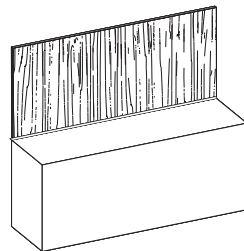

Product Width	Panel Dimension	SKU	List
93	93 x 1 x 36	VPWH9336	1450
87	87 x 1 x 36	VPWH8736	1360
83	83 x 1 x 36	VPWH8336	1295
76	76 x 1 x 36	VPWH7636	1185
70	70 x 1 x 36	VPWH7036	1090
64	64 x 1 x 36	VPWH6436	1000
58	58 x 1 x 36	VPWH5836	905
47	47 x 1 x 36	VPWH4736	735
35	35 x 1 x 36	VPWH3536	545
29	29 x 1 x 36	VPWH2936	450

Notes

- Use with 29" h floor credenzas and 18" h wall cabinets. Finish height is 65" AFF.
- Hanging hardware included.
- Vertical grain direction.
- Add 10% for Premium finishes.
- Wall boards selected in veneer are not standard from the same flitch so grain pattern will vary. Light finishes may have some color variation.
- If matching panels are required, contact Customer Service for quote.

Wall hung Veneer panels
42" height

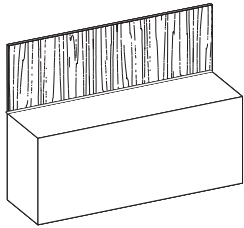

Product Width	Panel Dimension	SKU	List
93	93 x 1 x 42	VPWH9342	1695
87	87 x 1 x 42	VPWH8742	1585
83	83 x 1 x 42	VPWH8342	1510
76	76 x 1 x 42	VPWH7642	1385
70	70 x 1 x 42	VPWH7042	1275
64	64 x 1 x 42	VPWH6442	1165
58	58 x 1 x 42	VPWH5842	1055
47	47 x 1 x 42	VPWH4742	855
35	35 x 1 x 42	VPWH3542	640
29	29 x 1 x 42	GBWH2942	530

Notes

- Use with 29" h floor credenzas. Finish height is 71" AFF.
- Hanging hardware included.
- Vertical grain direction.
- Add 10% for Premium finishes.
- Wall boards selected in veneer are not standard from the same flitch so grain pattern will vary. Light finishes may have some color variation.
- If matching panels are required, contact Customer Service for quote.

48" height

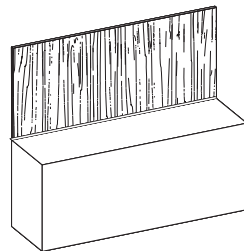

Product Width	Panel Dimension	SKU	List
93	93 x 1 x 48	VPWH9348	1935
87	87 x 1 x 48	VPWH8748	1810
83	83 x 1 x 48	VPWH8348	1725
76	76 x 1 x 48	VPWH7648	1580
70	70 x 1 x 48	VPWH7048	1455
64	64 x 1 x 48	VPWH6448	1330
58	58 x 1 x 48	VPWH5848	1205
47	47 x 1 x 48	VPWH4748	980
35	35 x 1 x 48	VPWH3548	730
29	29 x 1 x 48	VPWH2948	605

Notes

- Use with 23" h bench credenzas. Finish height is 71" AFF.
- Hanging hardware included.
- Vertical grain direction.
- Add 10% for Premium finishes.
- Wall boards selected in veneer are not standard from the same flitch so grain pattern will vary. Light finishes may have some color variation.
- If matching panels are required, contact Customer Service for quote.

Wall hung Veneer panels
54" height

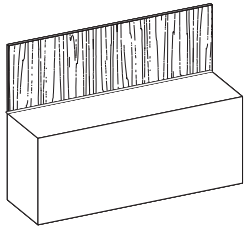

Product Width	Panel Dimension	SKU	List
93	93 x 1 x 54	VPWH9354	2175
87	87 x 1 x 54	VPWH8754	2035
83	83 x 1 x 54	VPWH8354	1940
76	76 x 1 x 54	VPWH7654	1780
70	70 x 1 x 54	VPWH7054	1640
64	64 x 1 x 54	VPWH6454	1500
58	58 x 1 x 54	VPWH5854	1360
47	47 x 1 x 54	VPWH4754	1100
35	35 x 1 x 54	VPWH3554	820
29	29 x 1 x 54	GBWH2954	680

Notes

- Use with 29" h floor credenzas. Finish height is 83" AFF.
- Hanging hardware included.
- Vertical grain direction.
- Add 10% for Premium finishes.
- Wall boards selected in veneer are not standard from the same flitch so grain pattern will vary. Light finishes may have some color variation.
- If matching panels are required, contact Customer Service for quote.

60" height

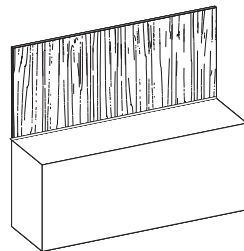

Product Width	Panel Dimension	SKU	List
93	93 x 1 x 60	VPWH9360	2420
87	87 x 1 x 60	VPWH8760	2260
83	83 x 1 x 60	VPWH8360	2160
76	76 x 1 x 60	VPWH7660	1975
70	70 x 1 x 60	VPWH7060	1820
64	64 x 1 x 60	VPWH6460	1665
58	58 x 1 x 60	VPWH5860	1510
47	47 x 1 x 60	VPWH4760	1220
35	35 x 1 x 60	VPWH3560	910
29	29 x 1 x 60	VPWH2960	755

Notes

- Use with 23" h bench credenzas. Finish height is 83" AFF.
- Hanging hardware included.
- Vertical grain direction.
- Add 10% for Premium finishes.
- Wall boards selected in veneer are not standard from the same flitch so grain pattern will vary. Light finishes may have some color variation.
- If matching panels are required, contact Customer Service for quote.

Wall hung TFL panels
30" height

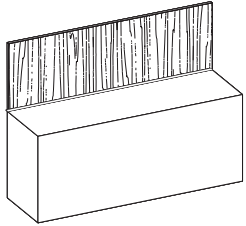

Product Width	Panel Dimension	SKU	List
93	93 x 1 x 30	MPWH9330	725
87	87 x 1 x 30	MPWH8730	680
83	83 x 1 x 30	MPWH8330	650
76	76 x 1 x 30	MPWH7630	595
70	70 x 1 x 30	MPWH7030	545
64	64 x 1 x 30	MPWH6430	500
58	58 x 1 x 30	MPWH5830	455
47	47 x 1 x 30	MPWH4730	365
35	35 x 1 x 30	MPWH3530	275
29	29 x 1 x 30	MPWH2930	230

Notes

- Use with 23" h bench credenzas and 18"h wall cabinets. Finish height is 53" AFF.
- Hanging hardware included.
- Horizontal grain direction.

36" height

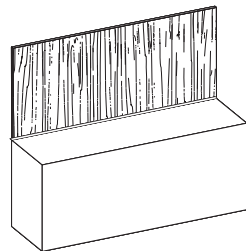

Product Width	Panel Dimension	SKU	List
93	93 x 1 x 36	MPWH9336	870
87	87 x 1 x 36	MPWH8736	815
83	83 x 1 x 36	MPWH8336	780
76	76 x 1 x 36	MPWH7636	710
70	70 x 1 x 36	MPWH7036	655
64	64 x 1 x 36	MPWH6436	600
58	58 x 1 x 36	MPWH5836	545
47	47 x 1 x 36	MPWH4736	440
35	35 x 1 x 36	MPWH3536	330
29	29 x 1 x 36	MPWH2936	270

Notes

- Use with 29"h bench credenzas. Finish height is 65" AFF.
- Hanging hardware included.
- Horizontal grain direction.

Wall hung TFL panels
42" height

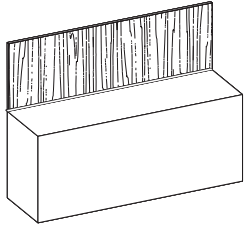

Product Width	Panel Dimension	SKU	List
93	93 x 1 x 42	MPWH9342	1015
87	87 x 1 x 42	MPWH8742	950
83	83 x 1 x 42	MPWH8342	905
76	76 x 1 x 42	MPWH7642	830
70	70 x 1 x 42	MPWH7642	765
64	64 x 1 x 42	MPWH6442	700
58	58 x 1 x 42	MPWH5842	635
47	47 x 1 x 42	MPWH4742	515
35	35 x 1 x 42	MPWH3542	385
29	29 x 1 x 42	MPWH2942	320

Notes

- Use with 29" h bench credenzas. Finish height is 71" AFF.
- Hanging hardware included.
- Horizontal grain direction.

48" height

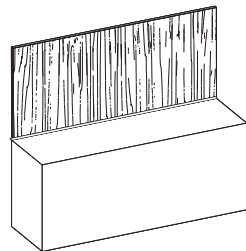

Product Width	Panel Dimension	SKU	List
93	93 x 1 x 48	MPWH9348	1160
87	87 x 1 x 48	MPWH8748	1085
83	83 x 1 x 48	MPWH8348	1035
76	76 x 1 x 48	MPWH7648	950
70	70 x 1 x 48	MPWH7048	880
64	64 x 1 x 48	MPWH6448	800
58	58 x 1 x 48	MPWH5848	725
47	47 x 1 x 48	MPWH4748	590
35	35 x 1 x 48	MPWH3548	440
29	29 x 1 x 48	MPWH2948	365

Notes

- Use with 23" h bench credenzas. Finish height is 71" AFF.
- Hanging hardware included.
- Horizontal grain direction.

Wall hung TFL panels
54" height

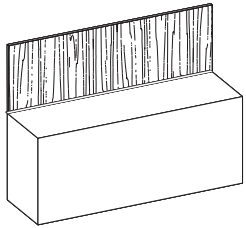

Product Width	Panel Dimension	SKU	List
93	93 x 1 x 54	MPWH9354	1305
87	87 x 1 x 54	MPWH8754	1220
83	83 x 1 x 54	MPWH8354	1165
76	76 x 1 x 54	MPWH7654	1065
70	70 x 1 x 54	MPWH7654	985
64	64 x 1 x 54	MPWH6454	900
58	58 x 1 x 54	MPWH5854	815
47	47 x 1 x 54	MPWH4754	660
35	35 x 1 x 54	MPWH3554	490
29	29 x 1 x 54	MPWH2954	410

Notes

- Use with 29" h floor credenzas. Finish height is 83" AFF.
- Hanging hardware included.
- Horizontal grain direction.

60" height

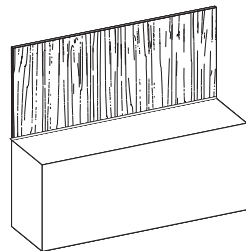

Product Width	Panel Dimension	SKU	List
93	93 x 1 x 60	MPWH9360	1450
87	87 x 1 x 60	MPWH8760	1355
83	83 x 1 x 60	MPWH8360	1295
76	76 x 1 x 60	MPWH7660	1185
70	70 x 1 x 60	MPWH7060	1090
64	64 x 1 x 60	MPWH6460	1000
58	58 x 1 x 60	MPWH5860	905
47	47 x 1 x 60	MPWH4760	730
35	35 x 1 x 60	MPWH3560	545
29	29 x 1 x 60	MPWH2960	455

Notes

- Use with 23" h bench credenzas. Finish height is 83" AFF.
- Hanging hardware included.
- Horizontal grain direction.

Central Park

Overhead Half Towers
14" D Panel Doors / Storage

[Click here to view statement of line](#)

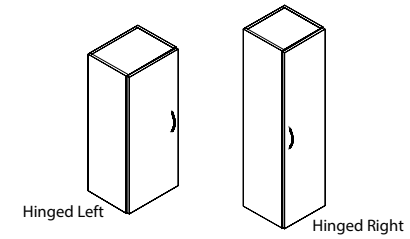

1 Select Model

w" x d" x h"
Hinged Left
17.5 x 14 x 42
14.5 x 14 x 42
17.5 x 14 x 54
14.5 x 14 x 54
Hinged Right
17.5 x 14 x 42
14.5 x 14 x 42
17.5 x 14 x 54
14.5 x 14 x 54

Weight	Standard Veneer Top Standard Veneer Chassis	Premium Veneer Top Premium Veneer Chassis	High Pressure Laminate Top Veneer Chassis	Thermally Fused Laminate Top Thermally Fused Laminate Chassis
80	CPC1742OH340W 1680	CPC1742OH340P 1849	"G" Option N/A	CPC1742OH340M 954
75	CPC1442OH340W 1602	CPC1442OH340P 1762	"G" Option N/A	CPC1442OH340M 922
90	CPC1754OH340W 1952	CPC1754OH340P 2147	"G" Option N/A	CPC1754OH340M 1021
85	CPC1454OH340W 1873	CPC1454OH340P 2061	"G" Option N/A	CPC1454OH340M 990
80	CPC1742OH341W 1680	CPC1742OH341P 1849	"G" Option N/A	CPC1742OH341M 954
75	CPC1442OH341W 1602	CPC1442OH341P 1762	"G" Option N/A	CPC1442OH341M 922
90	CPC1754OH341W 1952	CPC1754OH341P 2147	"G" Option N/A	CPC1754OH341M 1021
85	CPC1454OH341W 1873	CPC1454OH341P 2061	"G" Option N/A	CPC1454OH341M 990

Product Features

- 42" H Storage w/ 2 Finished adjustable shelves
- 54" H Storage w/ 3 Finished adjustable shelves
- "W" styles - 42" H units finished top, 54" H units black painted top
- Interior cabinet depth 12.5"

Notes

- Unit has black back panel and is not designed for Open Plan use. Select OPB Option for Open Plan application

Options

- Door**
- D2: Door lock - \$100
 - D6: Delete doors - n/c
 - D9SC: Soft Close Door Hinges - \$20 per door
 - WPD3061: Designer White - \$80 per door

Legal Depth

- MLD1: Modify to legal depth 18" - 10% upcharge

Open Plan _ Finished Back

- OPB: "W" "G" Style - Modify Unit for Open Plan Application - \$310
- OPB: "M" Style - Modify Unit for Open Plan Application - \$100

2 Select Finish

[Click to view finishes](#)

WAC	WNW
WIC	WWP
WHC	WNF(Natural
WOC	Oak on Flat
WEC	Cut)
WAM	WSF(Salted
WCM	Oak on Flat
WEW	Cut)
WGW	WMF(Mocha
WBW	Oak on Flat
WSW	Cut)

TBCO
TBSW
TSTV
TSMV
TSLV
TOBW
WMO
WNO
WSO

MAC
MOC
MEC
MGW
MTW
MSW
MWL
MNA

3 Select Edge

[Click to view edges](#)

Edge
N/A

Edge
N/A

Edge
N/A

4 Select Hardware

[Click to view details](#)

See Intro Page
for Pull Options

See Intro Page
for Pull Options

See Intro Page
for Pull Options

See Intro Page
for Pull Options

Central Park

Overhead Half Towers
14" D Panel Door - Storage / Organizer

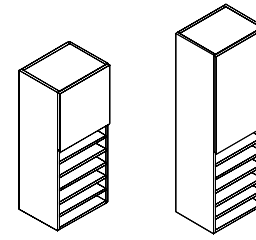

[Click here to view statement of line](#)

1 Select Model

w" x d" x h"
Hinged Left
17.5 x 14 x 42
14.5 x 14 x 42
17.5 x 14 x 54
14.5 x 14 x 54
Hinged Right
17.5 x 14 x 42
14.5 x 14 x 42
17.5 x 14 x 54
14.5 x 14 x 54

Weight	Standard Veneer Top Standard Veneer Chassis	Premium Veneer Top Premium Veneer Chassis	High Pressure Laminate Top Veneer Chassis	Thermally Fused Laminate Top Thermally Fused Laminate Chassis
80	CPC1742OH408W 1912	CPC1742OH408P 2104	"G" Option N/A	CPC1742OH408M 1077
75	CPC1442OH408W 1834	CPC1442OH408P 2018	"G" Option N/A	CPC1442OH408M 1040
90	CPC1754OH408W 2186	CPC1754OH408P 2405	"G" Option N/A	CPC1754OH408M 1146
85	CPC1454OH408W 2107	CPC1454OH408P 2319	"G" Option N/A	CPC1454OH408M 1116
80	CPC1742OH409W 1912	CPC1742OH409P 2104	"G" Option N/A	CPC1742OH409M 1077
75	CPC1442OH409W 1834	CPC1442OH409P 2018	"G" Option N/A	CPC1442OH409M 1040
90	CPC1754OH409W 2186	CPC1754OH409P 2405	"G" Option N/A	CPC1754OH409M 1146
85	CPC1454OH409W 2107	CPC1454OH409P 2319	"G" Option N/A	CPC1454OH409M 1116

Product Features

- 54" H has finished adjustable shelf behind door
- Interior cabinet depth 12.5"
- Organizer w/ 5 shelves (wood)
- "W" styles - 42" H units finished top, 54" H units black painted top

Notes

- Unit has black back panel and is not designed for Open Plan use. Select OPB Option for Open Plan application

Options

Door

- D2: Door lock - \$100
- D6: Delete doors - n/c
- D9SC: Soft Close Door Hinges - \$20 per door
- WPD3061: Designer White - \$80 per door

Legal Depth

- MLD1: Modify to legal depth 18" - 10% upcharge

Open Plan _ Finished Back

- OPB: "W" "G" Style - Modify Unit for Open Plan Application - \$310
- OPB: "M" Style - Modify Unit for Open Plan Application - \$100

2 Select Finish

[Click to view finishes](#)

WAC	WNW
WIC	WWP
WHC	WNF(Natural
WOC	Oak on Flat
WEC	Cut)
WAM	WSF(Salted
WCM	Oak on Flat
WEW	Cut)
WGW	WMF(Mocha
WBW	Oak on Flat
WSW	Cut)

TBCO
TBSW
TSTV
TSMV
TSLV
TOBW
WMO
WNO
WSO

MAC
MOC
MEC
MGW
MTW
MSW
MWL
MNA

3 Select Edge

[Click to view edges](#)

Edge
N/A

Edge
N/A

Edge
N/A

4 Select Hardware

[Click to view details](#)

Hardware
N/A

Hardware
N/A

Hardware
N/A

Central Park

Overhead Half Towers

14" D Silverluma Frame Door/Frosted Insert - Storage/Organizer

[Click here to view statement of line](#)

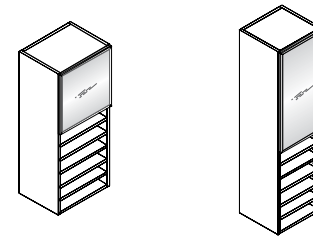

1 Select Model

w" x d" x h"
 Hinged Left
 17.5 x 14 x 42
 14.5 x 14 x 42
 17.5 x 14 x 54
 14.5 x 14 x 54
 Hinged Right
 17.5 x 14 x 42
 14.5 x 14 x 42
 17.5 x 14 x 54
 14.5 x 14 x 54

Weight	Standard Veneer Top Standard Veneer Chassis		Premium Veneer Top Premium Veneer Chassis		High Pressure Laminate Top Veneer Chassis	Thermally Fused Laminate Top Thermally Fused Laminate Chassis
85	CPC1742OH416W	2069	CPC1742OH416P	2276	"G" Option N/A	CPC1742OH416M 1171
80	CPC1442OH416W	1989	CPC1442OH416P	2188	"G" Option N/A	CPC1442OH416M 1140
95	CPC1754OH416W	2343	CPC1754OH416P	2577	"G" Option N/A	CPC1754OH416M 1245
90	CPC1454OH416W	2264	CPC1454OH416P	2491	"G" Option N/A	CPC1454OH416M 1213
85	CPC1742OH417W	2069	CPC1742OH417P	2276	"G" Option N/A	CPC1742OH417M 1171
80	CPC1442OH417W	1989	CPC1442OH417P	2188	"G" Option N/A	CPC1442OH417M 1140
95	CPC1754OH417W	2343	CPC1754OH417P	2577	"G" Option N/A	CPC1754OH417M 1245
90	CPC1454OH417W	2264	CPC1454OH417P	2491	"G" Option N/A	CPC1454OH417M 1213

2 Select Finish

[Click to view finishes](#)

WAC	WNW
WIC	WWP
WHC	WNF(Natural
WOC	Oak on Flat
WEC	Cut)
WAM	WSF(Salted
WCM	Oak on Flat
WEW	Cut)
WGW	WMF(Mocha
WBW	Oak on Flat
WSW	Cut)

TBCO
 TBSW
 TSTV
 TSMV
 TSLV
 TOBW
 WMO
 WNO
 WSO

MAC
 MOC
 MEC
 MGW
 MTW
 MSW
 MWL
 MNA

3 Select Edge

[Click to view edges](#)

Edge
 N/A

Edge
 N/A

Edge
 N/A

4 Select Hardware

[Click to view details](#)

Hardware
 N/A

Hardware
 N/A

Hardware
 N/A

Product Features

- 54" H has finished adjustable shelf behind door
- Interior cabinet depth 16.5"
- Organizer w/ 5 shelves (wood or laminate)
- "W" styles - 42" H units finished top, 54" H units black painted top

Notes

- Unit has black back panel and is not designed for Open Plan use. Select OPB Option for Open Plan application

Options

Door

- D2: Door Lock - \$100 per door
- D9SC: Soft Close Door Hinges - \$20 per door
- DWF1: 2" Wood frame replaces SilverLuma Frame - n/c ("W" only)
- DWF2: 2" Wood frame w/ pull replaces SilverLuma Frame - \$20 per door ("W" only)

Interior Cabinet Light

- LEDPK starter kit includes Infeed, 1 Puck Interior Light and the ability to daisy chain up to 6 total Puck Lights
- LEDPK: LED Puck Starter Kit - \$310
- PK: 1 LED Interior Light - \$130 ea.

Legal Depth

- MLD1: Modify to legal depth 18" - 10% upcharge

Open Plan _ Finished Back

- OPB: "W" "G" Style - Modify Unit for Open Plan Application - \$295
- OPB: "M" Style - Modify Unit for Open Plan Application - \$95

Shelves

- GS14H: Replace Standard Shelves with Glass Shelves - \$90 per shelf (behind silverluma door only)

Central Park

Overhead Bookcases
14" D Panel Doors / Storage

[Click here to view statement of line](#)

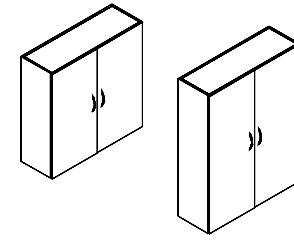

1 Select Model

w" x d" x h"	Weight
41 x 14 x 42	150
35 x 14 x 42	130
29 x 14 x 42	120
54" Height	
41 x 14 x 54	165
35 x 14 x 54	145
29 x 14 x 54	135

Standard Veneer Top Standard Veneer Chassis		Premium Veneer Top Premium Veneer Chassis		High Pressure Laminate Top Veneer Chassis		Thermally Fused Laminate Top Thermally Fused Laminate Chassis																																													
CPC4142OH383W	2684	CPC4142OH383P	2953	"G" Option N/A		CPC4142OH383M	1318																																												
CPC3542OH383W	2329	CPC3542OH383P	2562	"G" Option N/A		CPC3542OH383M	1239																																												
CPC2942OH383W	2237	CPC2942OH383P	2462	"G" Option N/A		CPC2942OH383M	1202																																												
CPC4154OH383W	3019	CPC4154OH383P	3321	"G" Option N/A		CPC4154OH383M	1450																																												
CPC3554OH383W	2796	CPC3554OH383P	3142	"G" Option N/A		CPC3554OH383M	1368																																												
CPC2954OH383W	2705	CPC2954OH383P	2976	"G" Option N/A		CPC2954OH383M	1332																																												
<p>2 Select Finish Click to view finishes</p> <table border="0"> <tr><td>WAC</td><td>WNW</td><td>TBCO</td><td>MAC</td></tr> <tr><td>WIC</td><td>WWP</td><td>TBSW</td><td>MOC</td></tr> <tr><td>WHC</td><td>WNF(Natural</td><td>TSTV</td><td>MEC</td></tr> <tr><td>WOC</td><td>Oak on Flat</td><td>TSMV</td><td>MGW</td></tr> <tr><td>WEC</td><td>Cut)</td><td>TSLV</td><td>MTW</td></tr> <tr><td>WAM</td><td>WSF(Salted</td><td>TOBW</td><td>MSW</td></tr> <tr><td>WCM</td><td>Oak on Flat</td><td>WMO</td><td>MWL</td></tr> <tr><td>WEW</td><td>Cut)</td><td>WNO</td><td>MNA</td></tr> <tr><td>WGW</td><td>WMF(Mocha</td><td>WSO</td><td></td></tr> <tr><td>WBW</td><td>Oak on Flat</td><td></td><td></td></tr> <tr><td>WSW</td><td>Cut)</td><td></td><td></td></tr> </table>		WAC	WNW	TBCO	MAC	WIC	WWP	TBSW	MOC	WHC	WNF(Natural	TSTV	MEC	WOC	Oak on Flat	TSMV	MGW	WEC	Cut)	TSLV	MTW	WAM	WSF(Salted	TOBW	MSW	WCM	Oak on Flat	WMO	MWL	WEW	Cut)	WNO	MNA	WGW	WMF(Mocha	WSO		WBW	Oak on Flat			WSW	Cut)			<p>Edge N/A</p>		<p>Edge N/A</p>		<p>Edge N/A</p>	
WAC	WNW	TBCO	MAC																																																
WIC	WWP	TBSW	MOC																																																
WHC	WNF(Natural	TSTV	MEC																																																
WOC	Oak on Flat	TSMV	MGW																																																
WEC	Cut)	TSLV	MTW																																																
WAM	WSF(Salted	TOBW	MSW																																																
WCM	Oak on Flat	WMO	MWL																																																
WEW	Cut)	WNO	MNA																																																
WGW	WMF(Mocha	WSO																																																	
WBW	Oak on Flat																																																		
WSW	Cut)																																																		
<p>3 Select Edge Click to view edges</p>		<p>Edge N/A</p>		<p>Edge N/A</p>		<p>Edge N/A</p>																																													
<p>4 Select Hardware Click to view details</p>		<p>See Intro Page for Pull Options</p>		<p>See Intro Page for Pull Options</p>		<p>See Intro Page for Pull Options</p>																																													

Product Features

- 42" H Storage w/ 2 Finished adjustable shelves
- 54" H Storage w/ 3 Finished adjustable shelves
- Interior cabinet depth 12.5"
- "W" styles - 42" H units finished top, 54" H units black painted top

Notes

- Unit has black back panel and is not designed for Open Plan use. Select OPB Option for Open Plan application

Options

Door

- D2: Door Lock - \$100 per door
- D6: Delete doors - n/c
- D9SC: Soft Close Door Hinges - \$20 per door
- WPD3061: Designer White - \$80 per door

Legal Depth

- MLD1: Modify to legal depth 18" - 10% upcharge

Open Plan _ Finished Back

- OPB: "W" "G" Style - Modify Unit for Open Plan Application - \$295
- OPB: "M" Style - Modify Unit for Open Plan Application - \$95

Shelves

- S714F: Replace Standard Shelf with Heavy Duty Lumber 1" Shelf - \$80 per shelf ("M" Styles - n/a)

Central Park

Vertical Half Towers
Storage Wardrobe - Panel Door

[Click here to view statement of line](#)

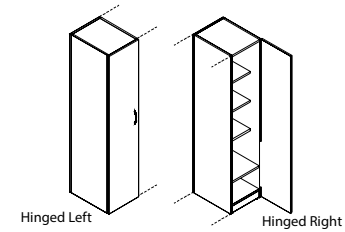

1 Select Model

w" x d" x h"	Weight
Door Hinged Left	
16 x 24 x 71	175
16 x 24 x 83	190
Door Hinged Right	
16 x 24 x 71	175
16 x 24 x 83	190

Standard Veneer Top Standard Veneer Chassis		Premium Veneer Top Premium Veneer Chassis		High Pressure Laminate Top Veneer Chassis		Thermally Fused Laminate Top Thermally Fused Laminate Chassis	
				"G" Option N/A		CPC1671TW283M	1635
				"G" Option N/A		CPC1683TW283M	1819
				"G" Option N/A		CPC1671TW284M	1635
				"G" Option N/A		CPC1683TW284M	1819

Product Features

- 71" has 3 finished adjustable shelves/1 fixed
- 83" has 4 finished adjustable shelves/1 fixed
- Wardrobe w/ coat rod & hook
- "W" styles - 71" H units finished top, 83" H units black painted top

Notes

- Unit has black back panel and is not designed for Open Plan use. Select OPB Option for Open Plan application

Options

Door

- D2: Door lock - \$100
- D6: Delete doors - n/c
- D9SC: Soft Close Door Hinges - \$20 per door
- WPD3061: Designer White - \$80 per door

Open Plan _ Finished Back

- OPB: "W" "G" Style - Modify Unit for Open Plan Application - \$295
- OPB: "M" Style - Modify Unit for Open Plan Application - \$95

2 Select Finish

[Click to view finishes](#)

WAC	WNW
WIC	WWP
WHC	WNF(Natural
WOC	Oak on Flat
WEC	Cut)
WAM	WSF(Salted
WCM	Oak on Flat
WEW	Cut)
WGW	WMF(Mocha
WBW	Oak on Flat
WSW	Cut)

TBCO
TBSW
TSTV
TSMV
TSLV
TOBW
WMO
WNO
WSO

MAC
MOC
MEC
MGW
MTW
MSW
MWL
MNA

3 Select Edge

[Click to view edges](#)

Edge
N/A

Edge
N/A

Edge
N/A

4 Select Hardware

[Click to view details](#)

See Intro Page
for Pull Options

See Intro Page
for Pull Options

See Intro Page
for Pull Options

See Intro Page
for Pull Options

Central Park

Vertical Half Towers
Storage / File - Panel Door

[Click here to view statement of line](#)

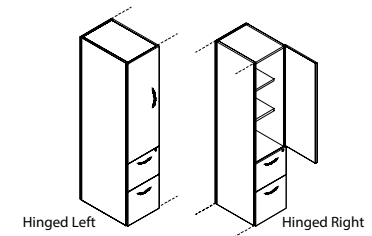

1 Select Model

w" x d" x h"

Door Hinged Left
16 x 24 x 71
16 x 24 x 83
Door Hinged Right
16 x 24 x 71
16 x 24 x 83

Weight	Standard Veneer Top Standard Veneer Chassis	Premium Veneer Top Premium Veneer Chassis	High Pressure Laminate Top Veneer Chassis	Thermally Fused Laminate Top Thermally Fused Laminate Chassis
195	CPC1671TW291W 3850	CPC1671TW291P 4236	"G" Option N/A	CPC1671TW291M 1967
210	CPC1683TW291W 4087	CPC1683TW291P 4496	"G" Option N/A	CPC1683TW291M 2157
195	CPC1671TW292W 3850	CPC1671TW292P 4236	"G" Option N/A	CPC1671TW292M
210	CPC1683TW292W 4087	CPC1683TW292P 4496	"G" Option N/A	CPC1683TW292M 2157

Product Features

- 71" has 2 finished adjustable shelves
- 83" has 3 finished adjustable shelves
- Full extension drawers - locking
- "W" & "G" SKUs feature soft close suspensions, "M" SKUs feature ball bearing suspensions. Both suspensions are full extension.
- "W" styles - 71" H units finished top, 83" H units black painted top

Notes

- All units are standard w/ flush ends
- Unit has black back panel and is not designed for Open Plan use. Select OPB Option for Open Plan application

Options

Door

- D2: Door lock - \$100
- D6: Delete doors - n/c
- D9SC: Soft Close Door Hinges - \$20 per door
- WPD3061: Designer White - \$80 per door

Drawer

- P6: Modify File/File to Box/Box/File - \$55 per pedestal
- P33: Wood Drawer Upgrade - \$45 per drawer
- WPD3061: Designer White - \$80 per pedestal

Open Plan _ Finished Back

- OPB: "W" "G" Style - Modify Unit for Open Plan Application - \$295
- OPB: "M" Style - Modify Unit for Open Plan Application - \$95

2 Select Finish

[Click to view finishes](#)

WAC	WNW
WIC	WWP
WHC	WNF(Natural
WOC	Oak on Flat
WEC	Cut)
WAM	WSF(Salted
WCM	Oak on Flat
WEW	Cut)
WGW	WMF(Mocha
WBW	Oak on Flat
WSW	Cut)

TBCO
TBSW
TSTV
TSMV
TSLV
TOBW
WMO
WNO
WSO

MAC
MOC
MEC
MGW
MTW
MSW
MWL
MNA

3 Select Edge

[Click to view edges](#)

Edge
N/A

Edge
N/A

Edge
N/A

4 Select Hardware

[Click to view details](#)

See Intro Page
for Pull Options

See Intro Page
for Pull Options

See Intro Page
for Pull Options

See Intro Page
for Pull Options

Central Park

Vertical Full Towers
Wardrobe

[Click here to view statement of line](#)

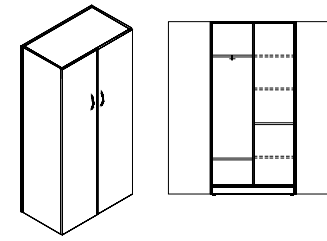

1 Select Model

w" x d" x h"	Weight
35 x 24 x 71	285
29 x 24 x 71	240
35 x 24 x 83	310
29 x 24 x 83	265

Standard Veneer Top Standard Veneer Chassis		Premium Veneer Top Premium Veneer Chassis		High Pressure Laminate Top Veneer Chassis		Thermally Fused Laminate Top Thermally Fused Laminate Chassis																																													
CPC3571TW275W	4904	CPC3571TW275P	5395	"G" Option N/A	CPC3571TW275M	2307																																													
CPC2971TW275W	4562	CPC2971TW275P	5019	"G" Option N/A	CPC2971TW275M	2242																																													
CPC3583TW275W	5216	CPC3583TW275P	5738	"G" Option N/A	CPC3583TW275M	2555																																													
CPC2983TW275W	4875	CPC2983TW275P	5363	"G" Option N/A	CPC2983TW275M	2485																																													
<p>2 Select Finish Click to view finishes</p> <table border="0"> <tr><td>WAC</td><td>WNW</td><td>TBCO</td><td>MAC</td></tr> <tr><td>WIC</td><td>WWP</td><td>TBSW</td><td>MOC</td></tr> <tr><td>WHC</td><td>WNF(Natural</td><td>TSTV</td><td>MEC</td></tr> <tr><td>WOC</td><td>Oak on Flat</td><td>TSMV</td><td>MGW</td></tr> <tr><td>WEC</td><td>Cut)</td><td>TSLV</td><td>MTW</td></tr> <tr><td>WAM</td><td>WSF(Salted</td><td>TOBW</td><td>MSW</td></tr> <tr><td>WCM</td><td>Oak on Flat</td><td>WMO</td><td>MWL</td></tr> <tr><td>WEW</td><td>Cut)</td><td>WNO</td><td>MNA</td></tr> <tr><td>WGW</td><td>WMF(Mocha</td><td>WSO</td><td></td></tr> <tr><td>WBW</td><td>Oak on Flat</td><td></td><td></td></tr> <tr><td>WSW</td><td>Cut)</td><td></td><td></td></tr> </table>		WAC	WNW	TBCO	MAC	WIC	WWP	TBSW	MOC	WHC	WNF(Natural	TSTV	MEC	WOC	Oak on Flat	TSMV	MGW	WEC	Cut)	TSLV	MTW	WAM	WSF(Salted	TOBW	MSW	WCM	Oak on Flat	WMO	MWL	WEW	Cut)	WNO	MNA	WGW	WMF(Mocha	WSO		WBW	Oak on Flat			WSW	Cut)			<p>Edge N/A</p>		<p>Edge N/A</p>			
WAC	WNW	TBCO	MAC																																																
WIC	WWP	TBSW	MOC																																																
WHC	WNF(Natural	TSTV	MEC																																																
WOC	Oak on Flat	TSMV	MGW																																																
WEC	Cut)	TSLV	MTW																																																
WAM	WSF(Salted	TOBW	MSW																																																
WCM	Oak on Flat	WMO	MWL																																																
WEW	Cut)	WNO	MNA																																																
WGW	WMF(Mocha	WSO																																																	
WBW	Oak on Flat																																																		
WSW	Cut)																																																		
<p>4 Select Hardware Click to view details</p> <p>See Intro Page for Pull Options</p>		<p>See Intro Page for Pull Options</p>		<p>See Intro Page for Pull Options</p>		<p>See Intro Page for Pull Options</p>																																													

Product Features

- 71" has 3 finished adjustable shelves, 2 fixed shelves
- 83" has 4 finished adjustable shelves, 2 fixed shelves
- Wardrobe w/ coat rod & hook
- "W" styles - 71" H units finished top, 83" H units black painted top

Notes

- Unit has black back panel and is not designed for Open Plan use. Select OPB Option for Open Plan application

Options

Door

- D2: Door Lock - \$100 per door
- D6: Delete doors - n/c
- D9SC: Soft Close Door Hinges - \$20 per door
- WPD3061: Designer White - \$80 per door

Open Plan _ Finished Back

- OPB: "W" "G" Style - Modify Unit for Open Plan Application - \$295
- OPB: "M" Style - Modify Unit for Open Plan Application - \$95

Shelves

- MOD31: 83" Delete center partition & add 1 fixed shelf, 4 adjustable shelves - \$295
- MOD31: 71" Delete center partition & add 1 fixed shelf, 3 adjustable shelves - \$295

Central Park

Vertical Full Towers
Storage / File

[Click here to view statement of line](#)

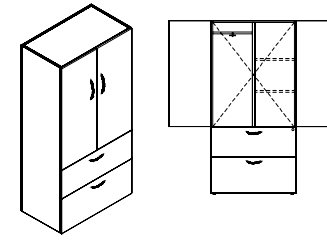

1 Select Model

w" x d" x h"	Weight
35 x 24 x 71	325
29 x 24 x 71	295
35 x 24 x 83	350
29 x 24 x 83	325

Standard Veneer Top Standard Veneer Chassis	Premium Veneer Top Premium Veneer Chassis	High Pressure Laminate Top Veneer Chassis	Thermally Fused Laminate Top Thermally Fused Laminate Chassis
CPC3571TW281W 5430	CPC3571TW281P 5974	"G" Option N/A	CPC3571TW281M 2621
CPC2971TW281W 5185	CPC2971TW281P 5703	"G" Option N/A	CPC2971TW281M 2567
CPC3583TW281W 5740	CPC3583TW281P 6315	"G" Option N/A	CPC3583TW281M 2864
CPC2983TW281W 5497	CPC2983TW281P 6048	"G" Option N/A	CPC2983TW281M 2816
	TBCO		MAC
	TBSW		MOC
	TSTV		MEC
	TSMV		MGW
	TSLV		MTW
	TOBW		MSW
	WMO		MWL
	WNO		MNA
	WSO		
	Edge N/A		Edge N/A
	See Intro Page for Pull Options	See Intro Page for Pull Options	See Intro Page for Pull Options

Product Features

- 71" has 2 finished adjustable shelves
- 83" has 3 finished adjustable shelves
- Features ball bearing suspensions, suspensions are full extension.
- Wardrobe w/ coat rod & hook
- "W" styles - 71" H units finished top, 83" H units black painted top

Notes

- Unit has black back panel and is not designed for Open Plan use. Select OPB Option for Open Plan application

Options

Door

- D2: Door Lock - \$100 per door
- D6: Delete doors - n/c
- D9SC: Soft Close Door Hinges - \$20 per door
- WPD3061: Designer White - \$80 per door

Drawer

- P33: Wood Drawer Upgrade - \$45 per drawer
- WPD3061: Designer White - \$80 per door

Open Plan _ Finished Back

- OPB: "W" "G" Style - Modify Unit for Open Plan Application - \$295
- OPB: "M" Style - Modify Unit for Open Plan Application - \$95

Shelves

- MOD30: 83" Delete center partition & Add 3 full width shelves - \$295
- MOD30: 71" Delete center partition & Add 2 full width shelves - \$295

2 Select Finish

[Click to view finishes](#)

WAC	WNW
WIC	WWP
WHC	WNF(Natural
WOC	Oak on Flat
WEC	Cut)
WAM	WSF(Salted
WCM	Oak on Flat
WEW	Cut)
WGW	WMF(Mocha
WBW	Oak on Flat
WSW	Cut)

3 Select Edge

[Click to view edges](#)

Edge
N/A

4 Select Hardware

[Click to view details](#)

See Intro Page
for Pull Options

Central Park

Right Angle Open Tower
Storage/Wardrobe

[Click here to view statement of line](#)

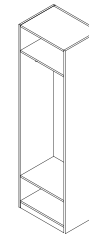

1 Select Model

w" x d" x h"
18 x 24 x 71
18 x 24 x 83

Weight
200
220

Standard Veneer Top Standard Veneer Chassis		Premium Veneer Top Premium Veneer Chassis		High Pressure Laminate Top Veneer Chassis		Thermally Fused Laminate Top Thermally Fused Laminate Chassis	
CPC1871TW270W	3031	CPC1871TW270P	3334	"G" Option N/A		CPC1871TW270M	1581
CPC1883TW270W	3260	CPC1883TW270P	3586	"G" Option N/A		CPC1883TW270M	1701

Product Features

- (2) Fixed shelves, 12" down from top and 12" up from bottom.
- Brushed nickel coat hooks on left and right side panels.

2 Select Finish

[Click to view finishes](#)

WAC
WIC
WHC
WOC
WEC
WAM
WCM
WEW
WGW
WBW
WSW

WNW
WWP
WNF(Natural
Oak on Flat
Cut)
WSF(Salted
Oak on Flat
Cut)
WMF(Mocha
Oak on Flat
Cut)

TBCO
TBSW
TSTV
TSMV
TSLV
TOBW
WMO
WNO
WSO

Finish
N/A

MAC
MOC
MEC
MGW
MTW
MSW
MWL
MNA

3 Select Edge

[Click to view edges](#)

Edge
N/A

Edge
N/A

Edge
N/A

Edge
N/A

4 Select Hardware

[Click to view details](#)

Hardware
N/A

Hardware
N/A

Hardware
N/A

Hardware
N/A

Notes

- Open Plan Back standard.

Central Park

Corner Display Towers
Display Towers

[Click here to view statement of line](#)



Right Corner



Left Corner

1 Select Model

- w" x d" x h"
Left Corner Display
16 x 24 x 71
16 x 24 x 83
Right Corner Display
16 x 24 x 71
16X 24 X 83

Weight	Standard Veneer Top Standard Veneer Chassis		Premium Veneer Top Premium Veneer Chassis		High Pressure Laminate Top Veneer Chassis	Thermally Fused Laminate Top Thermally Fused Laminate Chassis
175	CPC1671TW271W	2709	CPC1671TW271P	2981	"G" Option N/A	CPC1671TW271M 1499
190	CPC1683TW271W	3014	CPC1683TW271P	3316	"G" Option N/A	CPC1683TW271M 1614
175	CPC1671TW272W	2709	CPC1571TW272P	2981	"G" Option N/A	CPC1671TW272M 1499
190	CPC1683TW272W	3014	CPC1671TW272P	3316	"G" Option N/A	CPC1683TW272M 1614

Click to view finishes	WAC	WNW	TBCO	Finish	MAC
	WIC	WWP	TBSW	N/A	MOC
	WHC	WNF(Natural	TSTV		MEC
	WOC	Oak on Flat	TSMV		MGW
	WEC	Cut)	TSLV		MTW
	WAM	WSF(Salted	TOBW		MSW
	WCM	Oak on Flat	WMO		MWL
	WEW	Cut)	WNO		MNA
	WGW	WMF(Mocha	WSO		
	WBW	Oak on Flat			
	WSW	Cut)			

Click to view edges	Edge N/A	Edge N/A	Edge N/A	Edge N/A

Click to view details	Hardware N/A	Hardware N/A	Hardware N/A	Hardware N/A

Product Features

- 1" thick floating shelves

Notes

- Shelves align with the WH338 wall shelves when mounted on wall boards.

Options

Lighting

- LEDPK starter kit includes Infeed, 1 Puck Interior Light and the ability to daisy chain up to 6 total Puck Lights
- LEDPK: LED Puck Starter Kit - \$310
- PK: 1 LED Interior Light - \$130

Central Park

Vertical Full Towers
Storage / File - Mini-Wardrobe

[Click here to view statement of line](#)

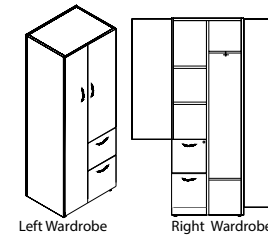

1 Select Model

w" x d" x h"
Wardrobe Left
26 x 24 x 71
26 x 24 x 83
Wardrobe Right
26 x 24 x 71
26 x 24 x 83

Weight	Standard Veneer Top Standard Veneer Chassis		Premium Veneer Top Premium Veneer Chassis		High Pressure Laminate Top Veneer Chassis	Thermally Fused Laminate Top Thermally Fused Laminate Chassis	
					"G" Option N/A		
					"G" Option N/A		
					"G" Option N/A		
					"G" Option N/A		

Product Features

- 71" has 2 finished adjustable shelves
- 83" has 3 finished adjustable shelves
- Full extension drawers - locking
- "W" & "G" SKUs feature soft close suspensions, "M" SKUs feature ball bearing suspensions. Both suspensions are full extension.
- Wardrobe w/ coat rod & hook
- "W" styles - 71" H units finished top, 83" H units black painted top

Notes

- Unit has black back panel and is not designed for Open Plan use. Select OPB Option for Open Plan application

Options

Door

- D2: Door Lock - \$100 per door
- D6: Delete doors - n/c
- D9SC: Soft Close Door Hinges - \$20 per door
- WPD3061: Designer White - \$80 per door

Drawer

- P6: Modify File/File to Box/Box/File - \$55 per pedestal
- P33: Wood Drawer Upgrade - \$45 per drawer
- WPD3061: Designer White - \$80 per door

Open Plan _ Finished Back

- OPB: "W" "G" Style - Modify Unit for Open Plan Application - \$295
- OPB: "M" Style - Modify Unit for Open Plan Application - \$95

2 Select Finish

[Click to view finishes](#)

WAC	WNW
WIC	WWP
WHC	WNF(Natural
WOC	Oak on Flat
WEC	Cut)
WAM	WSF(Salted
WCM	Oak on Flat
WEW	Cut)
WGW	WMF(Mocha
WBW	Oak on Flat
WSW	Cut)

TBCO
TBSW
TSTV
TSMV
TSLV
TOBW
WMO
WNO
WSO

MAC
MOC
MEC
MGW
MTW
MSW
MWL
MNA

3 Select Edge

[Click to view edges](#)

Edge
N/A

Edge
N/A

Edge
N/A

4 Select Hardware

[Click to view details](#)

[See Intro Page
for Pull Options](#)

[See Intro Page
for Pull Options](#)

[See Intro Page
for Pull Options](#)

[See Intro Page
for Pull Options](#)

Central Park

Workcenter 54" Full Tower Components
Lateral File X2 / Open Storage

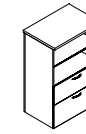

[Click here to view statement of line](#)

1 Select Model

w" x d" x h"	Weight
35 x 24 x 54	200
31 x 24 x 54	195
29 x 24 x 54	185

Standard Veneer Top Standard Veneer Chassis		Premium Veneer Top Premium Veneer Chassis		High Pressure Laminate Top Veneer Chassis		Thermally Fused Laminate Top Thermally Fused Laminate Chassis	
CPC3554WC282W	3035	CPC3554WC282P	3339	CPC3554WC282G	3035	CPC3554WC282M	1930
CPC3154WC282W	2959	CPC3154WC282P	3255	CPC3154WC282G	2959	CPC3154WC282M	1880
CPC2954WC282W	2888	CPC2954WC282P	3177	CPC2954WC282G	2888	CPC2954WC282M	1835

Product Features

- Anti-tilt safety feature
- Finished back - open plan
- Finished top
- Legal/Letter filing
- Features ball bearing suspensions, suspensions are full extension

Notes

- All units are standard w/ flush ends

Options

Door

- D12: Panel Door for upper section- \$200

Drawer

- P33: Wood Drawer Upgrade - \$45 per drawer
- WPD3061: Designer White - \$80 per door

Shelf

- S721F: 1" wood shelf 24" deep - \$100 each

2 Select Finish

[Click to view finishes](#)

WAC	WNW
WIC	WWP
WHC	WNF(Natural
WOC	Oak on Flat
WEC	Cut)
WAM	WSF(Salted
WCM	Oak on Flat
WEW	Cut)
WGW	WMF(Mocha
WBW	Oak on Flat
WSW	Cut)

TBCO
TBSW
TSTV
TSMV
TSLV
TOBW
WMO
WNO
WSO

GAC +10%
GIC GSLV
GHC +10%
GOC GWL
GEC
GAM
GCM
GEW
GNW
GSTV

MAC
MOC
MEC
MGW
MTW
MSW
MWL
MNA

3 Select Edge

[Click to view edges](#)

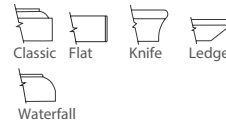
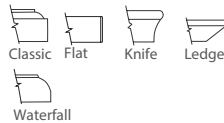

4 Select Hardware

[Click to view details](#)

See Intro Page
for Pull Options

See Intro Page
for Pull Options

See Intro Page
for Pull Options

See Intro Page
for Pull Options

Central Park

Bookcases
14" D Open Bookcase

[Click here to view statement of line](#)

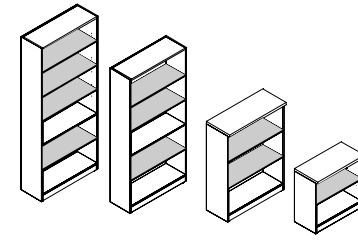

1 Select Model

w" x d" x h"	Weight
35" Width	
35 x 14 x 83	180
35 x 14 x 71	160
35 x 14 x 48	125
35 x 14 x 30.75	115
29" Width	
29 x 14 x 83	160
29 x 14 x 71	140
29 x 14 x 48	105
29 x 14 x 30.75	90

Standard Veneer Top Standard Veneer Chassis		Premium Veneer Top Premium Veneer Chassis		High Pressure Laminate Top Veneer Chassis		Thermally Fused Laminate Top Thermally Fused Laminate Chassis																																																																			
CPC3583BK250W	2727	CPC3583BK250P	3000	"G" Option N/A		CPC3583BK250M	1494																																																																		
CPC3571BK250W	2496	CPC3571BK250P	2745	"G" Option N/A		CPC3571BK250M	1376																																																																		
CPC3548BK250W	2031	CPC3548BK250P	2235	CPC3548BK250G	2031	CPC3548BK250M	1160																																																																		
CPC3530BK250W	1821	CPC3530BK250P	2003	CPC3530BK250G	1821	CPC3530BK250M	888																																																																		
CPC2983BK250W	2541	CPC2983BK250P	2796	"G" Option N/A		CPC2983BK250M	1460																																																																		
CPC2971BK250W	2312	CPC2971BK250P	2545	"G" Option N/A		CPC2971BK250M	1350																																																																		
CPC2948BK250W	1847	CPC2948BK250P	2032	CPC2948BK250G	1847	CPC2948BK250M	1135																																																																		
CPC2930BK250W	1635	CPC2930BK250P	1799	CPC2930BK250G	1635	CPC2930BK250M	837																																																																		
<p>2 Select Finish Click to view finishes</p> <table border="0"> <tr> <td>WAC</td> <td>WNW</td> <td>TBCO</td> <td>GAC</td> <td>+10%</td> <td>MAC</td> </tr> <tr> <td>WIC</td> <td>WWP</td> <td>TBSW</td> <td>GIC</td> <td>GSLV</td> <td>MOC</td> </tr> <tr> <td>WHC</td> <td>WNF(Natural</td> <td>TSTV</td> <td>GHC</td> <td>+10%</td> <td>MEC</td> </tr> <tr> <td>WOC</td> <td>Oak on Flat</td> <td>TSMV</td> <td>GOC</td> <td>GWL</td> <td>MGW</td> </tr> <tr> <td>WEC</td> <td>Cut)</td> <td>TSLV</td> <td>GEC</td> <td></td> <td>MTW</td> </tr> <tr> <td>WAM</td> <td>WSF(Salted</td> <td>TOBW</td> <td>GAM</td> <td></td> <td>MSW</td> </tr> <tr> <td>WCM</td> <td>Oak on Flat</td> <td>WMO</td> <td>GCM</td> <td></td> <td>MWL</td> </tr> <tr> <td>WEW</td> <td>Cut)</td> <td>WNO</td> <td>GEW</td> <td></td> <td>MNA</td> </tr> <tr> <td>WGW</td> <td>WMF(Mocha</td> <td>WSO</td> <td>GNW</td> <td></td> <td></td> </tr> <tr> <td>WBW</td> <td>Oak on Flat</td> <td></td> <td>GSTV</td> <td></td> <td></td> </tr> <tr> <td>WSW</td> <td>Cut)</td> <td></td> <td></td> <td></td> <td></td> </tr> </table>		WAC	WNW	TBCO	GAC	+10%	MAC	WIC	WWP	TBSW	GIC	GSLV	MOC	WHC	WNF(Natural	TSTV	GHC	+10%	MEC	WOC	Oak on Flat	TSMV	GOC	GWL	MGW	WEC	Cut)	TSLV	GEC		MTW	WAM	WSF(Salted	TOBW	GAM		MSW	WCM	Oak on Flat	WMO	GCM		MWL	WEW	Cut)	WNO	GEW		MNA	WGW	WMF(Mocha	WSO	GNW			WBW	Oak on Flat		GSTV			WSW	Cut)					<p>Hardware N/A</p>		<p>Hardware N/A</p>		<p>Hardware N/A</p>	
WAC	WNW	TBCO	GAC	+10%	MAC																																																																				
WIC	WWP	TBSW	GIC	GSLV	MOC																																																																				
WHC	WNF(Natural	TSTV	GHC	+10%	MEC																																																																				
WOC	Oak on Flat	TSMV	GOC	GWL	MGW																																																																				
WEC	Cut)	TSLV	GEC		MTW																																																																				
WAM	WSF(Salted	TOBW	GAM		MSW																																																																				
WCM	Oak on Flat	WMO	GCM		MWL																																																																				
WEW	Cut)	WNO	GEW		MNA																																																																				
WGW	WMF(Mocha	WSO	GNW																																																																						
WBW	Oak on Flat		GSTV																																																																						
WSW	Cut)																																																																								

Product Features

- 3/4" Thick finished shelves standard
- Interior cabinet depth 12.5"
- "W" styles - 29", 48", and 71" H units finished top, 83" H units black painted top

Notes

- 30.75"H Open Bookcases are NOT meant to gang with desks, returns and credenzas. Unit is higher than regular worksurfaces to allow double binder storage. If matching height is desired, choose CPC-3524CA125W or CPC2924CA125W with D6A option
- Adjustable shelves shaded
- Only 30.75" and 48"H units have profile edge/ shaped top
- Unit has black back panel and is not designed for Open Plan use. Select OPB Option for Open Plan application

Options

Interior Cabinet Light

- LEDPK starter kit includes Infeed, 1 Puck Interior Light and the ability to daisy chain up to 6 total Puck Lights
- LEDPK: LED Puck Starter Kit - \$310
- PK: 1 LED Interior Light - \$130 ea.

Legal Depth

- MLD1: Modify to legal depth 18" - 10% upcharge

Open Plan _ Finished Back

- OPB: "W" "G" Style - Modify Unit for Open Plan Application - \$295
- OPB: "M" Style - Modify Unit for Open Plan Application - \$95

Shelves

- GS14F: Replace Standard Shelves with Glass Shelves - \$90 per shelf
- S714F: Heavy Duty Lumber 1" Shelves - \$80 per shelf ("M" Styles - n/a)

3 Select Edge

Click to view edges

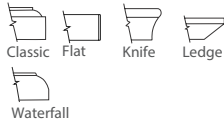

4 Select Hardware

Click to view details

Hardware
N/A

Hardware
N/A

Hardware
N/A

Central Park

Bookcases
14" D Bookcase W/ Doors

[Click here to view statement of line](#)

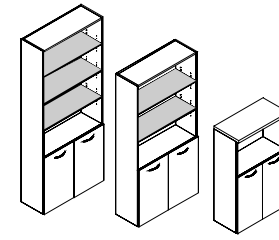

1 Select Model

w" x d" x h"	Weight
35" Width	
35 x 14 x 83	200
35 x 14 x 71	180
35 x 14 x 48	145
29" Width	
29 x 14 x 83	180
29 x 14 x 71	160
29 x 14 x 48	125

Standard Veneer Top Standard Veneer Chassis		Premium Veneer Top Premium Veneer Chassis		High Pressure Laminate Top Veneer Chassis		Thermally Fused Laminate Top Thermally Fused Laminate Chassis	
CPC3583BK251W	3163	CPC3583BK251P	3480	"G" Option N/A		CPC3583BK251M	1675
CPC3571BK251W	2925	CPC3571BK251P	3218	"G" Option N/A		CPC3571BK251M	1562
CPC3548BK251W	2462	CPC3548BK251P	2708	CPC3548BK251G	2462	CPC3548BK251M	1358
CPC2983BK251W	2978	CPC2983BK251P	3277	"G" Option N/A		CPC2983BK251M	1643
CPC2971BK251W	2743	CPC2971BK251P	3018	"G" Option N/A		CPC2971BK251M	1536
CPC2948BK251W	2278	CPC2948BK251P	2505	CPC2948BK251G	2278	CPC2948BK251M	1332

Product Features

- 3/4" Thick finished adjustable shelves standard
- Finished shelves
- Interior cabinet depth 12.5"
- Pulls standard
- "W" styles - 48", 71" H units finished top, 83" H units black painted top

Notes

- Only 48"H units have profile edge/ shaped top
- Unit has black back panel and is not designed for Open Plan use. Select OPB Option for Open Plan application

Options

Door

- D2: Door lock - \$100 per door set
- D9SC: Soft Close Door Hinges - \$20 per door
- WPD3061: Designer White - \$80 per door

Interior Cabinet Light

- LEDPK starter kit includes Infeed, 1 Puck Interior Light and the ability to daisy chain up to 6 total Puck Lights
- LEDPK: LED Puck Starter Kit - \$310
- PK: 1 LED Interior Light - \$130 ea.

Legal Depth

- MLD1: Modify to legal depth 18" - 10% upcharge

Open Plan _ Finished Back

- OPB: "W" "G" Style - Modify Unit for Open Plan Application - \$295
- OPB: "M" Style - Modify Unit for Open Plan Application - \$95

Shelves

- GS14F: Replace Standard Shelves with Glass Shelves - \$90 per shelf
- S714F: Heavy Duty Lumber 1" Shelves - \$80 per shelf ("M" Styles - n/a)

2 Select Finish

[Click to view finishes](#)

WAC	WNW	TBCO	GAC +10%	MAC
WIC	WWP	TBSW	GIC GSLV	MOC
WHC	WNF(Natural	TSTV	GHC +10%	MEC
WOC	Oak on Flat	TSMV	GOC GWL	MGW
WEC	Cut)	TSLV	GEC	MTW
WAM	WSF(Salted	TOBW	GAM	MSW
WCM	Oak on Flat	WMO	GCM	MWL
WEW	Cut)	WNO	GEW	MNA
WGW	WMF(Mocha	WSO	GNW	
WBW	Oak on Flat		GSTV	
WSW	Cut)			

3 Select Edge

[Click to view edges](#)



4 Select Hardware

[Click to view details](#)

[See Intro Page for Pull Options](#)

[See Intro Page for Pull Options](#)

[See Intro Page for Pull Options](#)

[See Intro Page for Pull Options](#)

Central Park

Reception Desk Countertops
12" Rectangle Overhang Counter

[Click here to view statement of line](#)

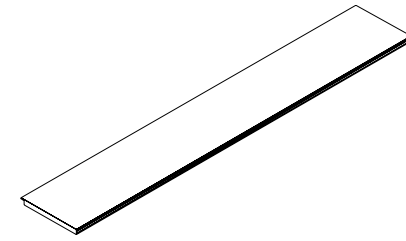

1 Select Model

w" x d" x h"
Full Width Counter Top
84 x 12
72 x 12
66 x 12

Weight

Standard Veneer Top Standard Veneer Chassis	Premium Veneer Top Premium Veneer Chassis	High Pressure Laminate Top Veneer Chassis	Thermally Fused Laminate Top Thermally Fused Laminate Chassis
--	--	--	--

CPC8412TC510W 1382	CPC8412TC510P 1520	CPC8412TC510G 1382	CPC8412TC510M 647
CPC7212TC510W 1197	CPC7212TC510P 1317	CPC7212TC510G 1197	CPC7212TC510M 631
CPC6612TC510W 1155	CPC6612TC510P 1270	CPC6612TC510G 1155	CPC6612TC510M 611

Product Features

- Ships assembled on desk
- Profile edge two long edges

Notes

- 3" Overhang
- For use on 42" H reception desk

Options

Plank Match Veneer

- RPMV: Random Walnut Plank Match Veneer (Horizontal Grain with 25%+ Sap) - Add 10%. Clear coat only.

2 Select Finish

[Click to view finishes](#)

WAC WNW
WIC WWP
WHC WNF(Natural
WOC Oak on Flat
WEC Cut)
WAM WSF(Salted
WCM Oak on Flat
WEW Cut)
WGW WMF(Mocha
WBW Oak on Flat
WSW Cut)

TBCO
TBSW
TSTV
TSMV
TSLV
TOBW
WMO
WNO
WSO

GAC +10%
GIC GSLV
GHC +10%
GOC GWL
GEC
GAM
GCM
GEW
GNW
GSTV

MAC
MOC
MEC
MGW
MTW
MSW
MWL
MNA

3 Select Edge

[Click to view edges](#)

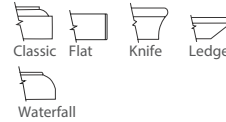
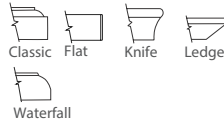

4 Select Hardware

[Click to view details](#)

Hardware
N/A

Hardware
N/A

Hardware
N/A

Hardware
N/A

Central Park

Reception Desk Countertops
Bowfront Overhang Counter

[Click here to view statement of line](#)

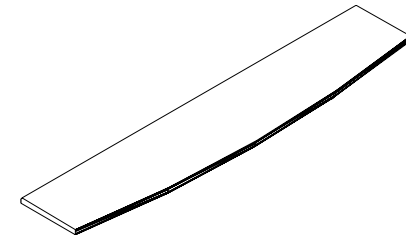

1 Select Model

w" x d" x h"
Full Bowfront Top
84 x 12/15
72 x 12/15
66 x 12/15

Weight

Standard Veneer Top Standard Veneer Chassis		Premium Veneer Top Premium Veneer Chassis		High Pressure Laminate Top Veneer Chassis		Thermally Fused Laminate Top Thermally Fused Laminate Chassis	
--	--	--	--	--	--	--	--

50	CPC8415TC511W	1627	CPC8415TC511P	1790	CPC8415TC511G	1627	CPC8415TC511M	743
45	CPC7215TC511W	1444	CPC7215TC511P	1589	CPC7215TC511G	1444	CPC7215TC511M	723
40	CPC6615TC511W	1382	CPC6615TC511P	1520	CPC6615TC511G	1382	CPC6615TC511M	705

Product Features

- Ships assembled on desk
- Profile edge two long edges

Notes

- 3" /6" Overhang
- For use on 42" H reception desk

Options

Plank Match Veneer

- RPMV: Random Walnut Plank Match Veneer (Horizontal Grain with 25%+ Sap) - Add 10%. Clear coat only.

2 Select Finish

[Click to view finishes](#)

WAC	WNW
WIC	WWP
WHC	WNF(Natural
WOC	Oak on Flat
WEC	Cut)
WAM	WSF(Salted
WCM	Oak on Flat
WEW	Cut)
WGW	WMF(Mocha
WBW	Oak on Flat
WSW	Cut)

TBCO
TBSW
TSTV
TSMV
TSLV
TOBW
WMO
WNO
WSO

GAC +10%
GIC GSLV
GHC +10%
GOC GWL
GEC
GAM
GCM
GEW
GNW
GSTV

MAC
MOC
MEC
MGW
MTW
MSW
MWL
MNA

3 Select Edge

[Click to view edges](#)

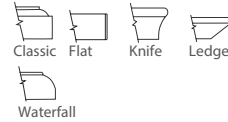
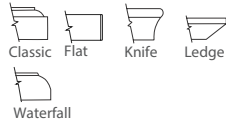

4 Select Hardware

[Click to view details](#)

Hardware
N/A

Hardware
N/A

Hardware
N/A

Hardware
N/A

Central Park

Reception Desk Countertops
Floating Overhang Counter

[Click here to view statement of line](#)

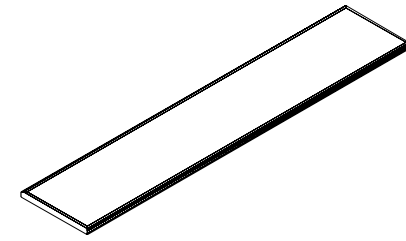

1 Select Model

w" x d" x h"

Weight

		Standard Veneer Top Standard Veneer Chassis		Premium Veneer Top Premium Veneer Chassis		High Pressure Laminate Top Veneer Chassis		Thermally Fused Laminate Top Thermally Fused Laminate Chassis	
72 x 12	50	CPC7212TC512W	1197	CPC7212TC512P	1317	CPC7212TC512G	1197	CPC7212TC512M	747
66 x 12	45	CPC6612TC512W	1155	CPC6612TC512P	1270	CPC6612TC512G	1155	CPC6612TC512M	730
60 x 12	40	CPC6012TC512W	1112	CPC6012TC512P	1223	CPC6012TC512G	1112	CPC6012TC512M	711
54 x 12	35	CPC5412TC512W	1055	CPC5412TC512P	1160	CPC5412TC512G	1055	CPC5412TC512M	693
48 x 12	30	CPC4812TC512W	968	CPC4812TC512P	1065	CPC4812TC512G	968	CPC4812TC512M	673
42 x 12	25	CPC4212TC512W	926	CPC4212TC512P	1019	CPC4212TC512G	926	CPC4212TC512M	656

Product Features

- Ships assembled on desk or return
- Profile edge two long edges

Notes

- 3" Overhang
- For use on 42" H reception desk

Options

Plank Match Veneer

- RPMV: Random Walnut Plank Match Veneer (Horizontal Grain with 25%+ Sap) - Add 10%. Clear coat only.

2 Select Finish

[Click to view finishes](#)

WAC	WNW	TBCO	GAC +10%	MAC
WIC	WWP	TBSW	GIC GSLV	MOC
WHC	WNF(Natural	TSTV	GHC +10%	MEC
WOC	Oak on Flat	TSMV	GOC GWL	MGW
WEC	Cut)	TSLV	GEC	MTW
WAM	WSF(Salted	TOBW	GAM	MSW
WCM	Oak on Flat	WMO	GCM	MWL
WEW	Cut)	WNO	GEW	MNA
WGW	WMF(Mocha	WSO	GNW	
WBW	Oak on Flat		GSTV	
WSW	Cut)			

3 Select Edge

[Click to view edges](#)



4 Select Hardware

[Click to view details](#)

Hardware	Hardware	Hardware	Hardware
N/A	N/A	N/A	N/A

Central Park

Reception Facade Panel Counters
Facade Panel

[Click here to view statement of line](#)

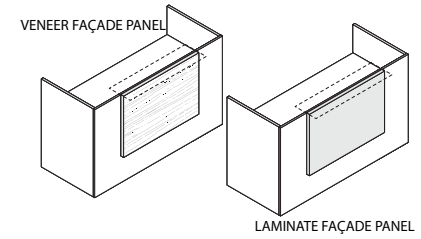

1 Select Model

w" x d" x h"	Weight
72 x 1 x 30	130
66 x 1 x 30	120
60 x 1 x 30	110
54 x 1 x 30	100
48 x 1 x 30	90
42 x 1 x 30	80

Standard Veneer Top Standard Veneer Chassis		Premium Veneer Top Premium Veneer Chassis		High Pressure Laminate Top Veneer Chassis	Thermally Fused Laminate Top Thermally Fused Laminate Chassis
CPC7230FP700W	1259	CPC7230FP700P	1386	"G" Option N/A	CPC7230FP700M 766
CPC6630FP700W	1170	CPC6630FP700P	1288	"G" Option N/A	CPC6630FP700M 755
CPC6030FP700W	1075	CPC6030FP700P	1183	"G" Option N/A	CPC6030FP700M 743
CPC5430FP700W	987	CPC5430FP700P	1086	"G" Option N/A	CPC5430FP700M 730
CPC4830FP700W	889	CPC4830FP700P	978	"G" Option N/A	CPC4830FP700M 717
CPC4230FP700W	802	CPC4230FP700P	882	"G" Option N/A	CPC4230FP700M 705
2 Select Finish Click to view finishes		WAC WNW WIC WWP WHC WNF(Natural WOC Oak on Flat WEC Cut) WAM WSF(Salted WCM Oak on Flat WEW Cut) WGW WMF(Mocha WBW Oak on Flat WSW Cut)		TBCO TBSW TSTV TSMV TSLV TOBW WMO WNO WSO	MAC MOC MEC MGW MTW MSW MWL MNA
3 Select Edge Click to view edges		Edge N/A			
4 Select Hardware Click to view details		Hardware N/A			Hardware N/A

Product Features

- Horizontal reverse slip pattern

Notes

- Facade Panels Can Be Attached To Desks, Bridges, Returns and Crendenzas

- For use on 42" H reception desk

Central Park

Reception Facade Panel Counters
Exotic Facade Panel

[Click here to view statement of line](#)

EXOTIC VENEER FAÇADE PANEL

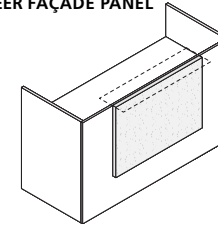

1 Select Model

w" x d" x h"	Weight
72 x 1 x 30	130
66 x 1 x 30	120
60 x 1 x 30	110
54 x 1 x 30	100
48 x 1 x 30	90
42 x 1 x 30	80

Standard Veneer Top Standard Veneer Chassis		Premium Veneer Top Premium Veneer Chassis	High Pressure Laminate Top Veneer Chassis	Thermally Fused Laminate Top Thermally Fused Laminate Chassis
CPC7230EP700W	1985	"P" Option N/A	"G" Option N/A	"M" Option N/A
CPC6630EP700W	1884	"P" Option N/A	"G" Option N/A	"M" Option N/A
CPC6030EP700W	1761	"P" Option N/A	"G" Option N/A	"M" Option N/A
CPC5430EP700W	1667	"P" Option N/A	"G" Option N/A	"M" Option N/A
CPC4830EP700W	1492	"P" Option N/A	"G" Option N/A	"M" Option N/A
CPC4230EP700W	1383	"P" Option N/A	"G" Option N/A	"M" Option N/A

Product Features

- Horizontal reverse slip pattern

Notes

- Choose from Mottled Makore, Birdseye Maple, Figured Sycamore, Figured Eucalyptus and Zebrawood (Could result in extended lead time)
- Facade Panels Can Be Attached To Desks, Bridges, Returns and Credenzas

2 Select Finish

[Click to view finishes](#) WCF

3 Select Edge

[Click to view edges](#) Edge
N/A

4 Select Hardware

[Click to view details](#) Hardware
N/A

Central Park

Reception Desk
Freestanding - Double Pedestal

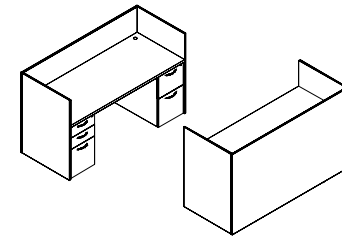

[Click here to view statement of line](#)

1 Select Model

w" x d" x h"	Weight
84 x 30 x 42	425
72 x 30 x 42	385
66 x 30 x 42	350

Standard Veneer Top Standard Veneer Chassis		Premium Veneer Top Premium Veneer Chassis		High Pressure Laminate Top Veneer Chassis		Thermally Fused Laminate Top Thermally Fused Laminate Chassis	
CPC8442RP921W	6405	CPC8442RP921P	7046	CPC8442RP921G	6405	CPC8442RP921M	2935
CPC7242RP921W	5771	CPC7242RP921P	6349	CPC7242RP921G	5771	CPC7242RP921M	2867
CPC6642RP921W	5659	CPC6642RP921P	6225	CPC6642RP921G	5659	CPC6642RP921M	2830

Product Features

- 2 standard grommet - matches pull finish or specify black TM30, silver TM31 or antique brass TM33
- Box/Box/File (left)
- File/File (right)
- "W" & "G" SKUs feature soft close suspensions, "M" SKUs feature ball bearing suspensions. Both suspensions are full extension.

Notes

- All units are standard w/ flush ends

Options

Accessories

- K28: Articulating Keyboard w/ Mouse - \$390
- K31: Center drawer - \$205

Drawer

- P6: Modify File/File to Box/Box/File - \$55 per pedestal
- P33: Wood Drawer Upgrade - \$45 per drawer
- WPD3061: Designer White - \$80 per pedestal

Grommets (Non-Standard Location)

Provide drawing w/ Grommet Location and Specify Color - \$95 ea.

- Black: TM30-NS
- Silver: TM31-NS
- Antique Brass: TM33-NS

Plank Match Veneer

- RPMV: Random Walnut Plank Match Veneer (Horizontal Grain with 25%+ Sap) - Add 10%. Clear coat only.

C157R: Reception counter fabric grades, pricing applies to all sizes

COM	COL	1	2	3
217	N/A	297	337	377
4	5	6	7	8
417	457	497	537	577
9	10	11/ L1	12	13/ L2
617	657	697	737	817

2 Select Finish

[Click to view finishes](#)

WAC	WNW
WIC	WWP
WHC	WNF(Natural
WOC	Oak on Flat
WEC	Cut)
WAM	WSF(Salted
WCM	Oak on Flat
WEW	Cut)
WGW	WMF(Mocha
WBW	Oak on Flat
WSW	Cut)

TBCO
TBSW
TSTV
TSMV
TSLV
TOBW
WMO
WNO
WSO

GAC +10%
GIC GSLV
GHC +10%
GOC GWL
GEC
GAM
GCM
GEW
GNW
GSTV

MAC
MOC
MEC
MGW
MTW
MSW
MWL
MNA

3 Select Edge

[Click to view edges](#)



4 Select Hardware

[Click to view details](#)

[See Intro Page for Pull Options](#)

[See Intro Page for Pull Options](#)

[See Intro Page for Pull Options](#)

[See Intro Page for Pull Options](#)

Central Park

Reception Desk
Single Pedestal Box/Box/File

[Click here to view statement of line](#)

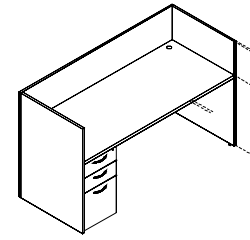

1 Select Model

w" x d" x h"	Weight
Left Pedestal	
84 x 30 x 42	395
72 x 30 x 42	350
66 x 30 x 42	320
Right Pedestal	
84 x 30 x 42	395
72 x 30 x 42	350
66 x 30 x 42	320

Standard Veneer Top Standard Veneer Chassis		Premium Veneer Top Premium Veneer Chassis		High Pressure Laminate Top Veneer Chassis		Thermally Fused Laminate Top Thermally Fused Laminate Chassis	
CPC8442RP925W	6037	CPC8442RP925P	6641	CPC8442RP925G	6037	CPC8442RP925M	2419
CPC7242RP925W	5482	CPC7242RP925P	6030	CPC7242RP925G	5482	CPC7242RP925M	2352
CPC6642RP925W	5298	CPC6642RP925P	5828	CPC6642RP925G	5298	CPC6642RP925M	2315
CPC8442RP924W	6037	CPC8442RP924P	6641	CPC8442RP924G	6037	CPC8442RP924M	2419
CPC7242RP924W	5482	CPC7242RP924P	6030	CPC7242RP924G	5482	CPC7242RP924M	2352
CPC6642RP924W	5298	CPC6642RP924P	5828	CPC6642RP924G	5298	CPC6642RP924M	2315

Product Features

- 2 standard grommet - matches pull finish or specify black TM30, silver TM31 or antique brass TM33
- "W" & "G" SKUs feature soft close suspensions, "M" SKUs feature ball bearing suspensions. Both suspensions are full extension.

Notes

- All units are standard w/ flush ends

Options

Accessories

- K28: Articulating Keyboard w/ Mouse - \$390
- K31: Center drawer - \$205

Drawer

- P6: Modify File/File to Box/Box/File - \$55 per pedestal
- P33: Wood Drawer Upgrade - \$45 per drawer
- WPD3061: Designer White - \$80 per door

Grommets (Non-Standard Location)

Provide drawing w/ Grommet Location and Specify Color - \$95 ea.

- Black: TM30-NS
- Silver: TM31-NS
- Antique Brass: TM33-NS

Plank Match Veneer

- RPMV: Random Walnut Plank Match Veneer (Horizontal Grain with 25%+ Sap) - Add 10%. Clear coat only.

C157R: Reception counter fabric grades, pricing applies to all sizes

COM	COL	1	2	3
217	N/A	297	337	377
4	5	6	7	8
417	457	497	537	577
9	10	11/ L1	12	13/ L2
617	657	697	737	817

2 Select Finish

[Click to view finishes](#)

WAC	WNW
WIC	WWP
WHC	WNF(Natural
WOC	Oak on Flat
WEC	Cut)
WAM	WSF(Salted
WCM	Oak on Flat
WEW	Cut)
WGW	WMF(Mocha
WBW	Oak on Flat
WSW	Cut)

TBCO
TBSW
TSTV
TSMV
TSLV
TOBW
WMO
WNO
WSO

GAC	+10%
GIC	GSLV
GHC	+10%
GOC	GWL
GEC	
GAM	
GCM	
GEW	
GNW	
GSTV	

MAC
MOC
MEC
MGW
MTW
MSW
MWL
MNA

3 Select Edge

[Click to view edges](#)



4 Select Hardware

[Click to view details](#)

See Intro Page
for Pull Options

See Intro Page
for Pull Options

See Intro Page
for Pull Options

See Intro Page
for Pull Options

Central Park

Reception
Inset Reception Counter Top

[Click here to view statement of line](#)

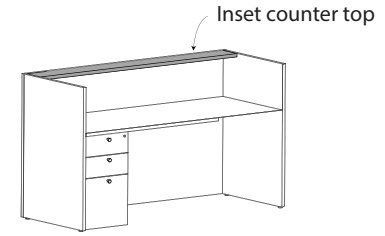

1 Select Model

w" x d" x h"

Weight

	Standard Veneer Top Standard Veneer Chassis	Premium Veneer Top Premium Veneer Chassis	High Pressure Laminate Top Veneer Chassis	Thermally Fused Laminate Top Thermally Fused Laminate Chassis
Counter Top for 84" Reception Desk 82 x 9 x 1.25	35 CPC8209TC513W 1378	CPC8209TC513P 1517	CPC8209TC513G 1378	CPC8209TC513M 647
Counter Top for 72" Reception Desk 70 x 9 x 1.25	30 CPC7009TC513W 1193	CPC7009TC513P 1313	CPC7009TC513G 1193	CPC7009TC513M 631
Counter Top for 66" Reception Desk 64 x 9 x 1.25	25 CPC6409TC513W 1153	CPC6409TC513P 1268	CPC6409TC513G 1153	CPC6409TC513M 611

Product Features

Notes

- Customer must specify counter top in order to specify cliff counter
- Recessed counter

Options

Glass Counter

- Soft etch back painted white glass
- SEGW8209 82" Glass counter - \$1190
- SEGW7009 70" Glass Counter - \$1135
- SEGW6409 64" Glass Counter - \$1105
- Glass pricing option in addition to product pricing

Plank Match Veneer

- RPMV: Random Walnut Plank Match Veneer (Horizontal Grain with 25%+ Sap) - Add 10%. Clear coat only.

2 Select Finish

[Click to view finishes](#)

WAC	WNW
WIC	WWP
WHC	WNF(Natural
WOC	Oak on Flat
WEC	Cut)
WAM	WSF(Salted
WCM	Oak on Flat
WEW	Cut)
WGW	WMF(Mocha
WBW	Oak on Flat
WSW	Cut)

TBCO
TBSW
TSTV
TSMV
TSLV
TOBW
WMO
WNO
WSO

GAC +10%
GIC GSLV
GHC +10%
GOC GWL
GEC
GAM
GCM
GEW
GNW
GSTV

MAC
MOC
MEC
MGW
MTW
MSW
MWL
MNA

3 Select Edge

[Click to view edges](#)



Flat



Flat



Flat



Flat

4 Select Hardware

[Click to view details](#)

Hardware
N/A

Hardware
N/A

Hardware
N/A

Hardware
N/A

Central Park

Reception
Solid Surface Cliff Counter

[Click here to view statement of line](#)

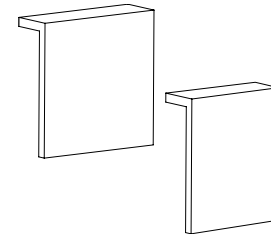

1 Select Model

w" x d" x h"
30 x 10 x 32
20 x 10 x 32

Weight

Cliff Counter Solid Surface

CPC3010CC514	3607
CPC2010CC514	3507

2 Select Finish

[Click to view finishes](#)

G10
G38
G04

3 Select Edge

[Click to view edges](#)

Edge
N/A

4 Select Hardware

[Click to view details](#)

Hardware
N/A

Product Features

Notes

- Customer must specify counter top in order to specify cliff counter

Options.

Solid Surface

- Choose quartz: G10 Black Pearl, G38 Sea Oat Quartz, G04 White Quartz

Central Park

Reception Return
File / File

[Click here to view statement of line](#)

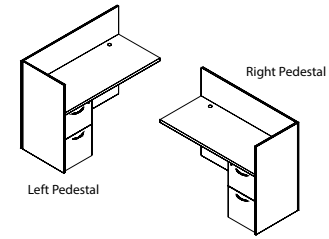

1 Select Model

w" x d" x h"	Weight
Left Pedestal	
60 x 24 x 42	155
54 x 24 x 42	145
48 x 24 x 42	140
42 x 24 x 42	135
Right Pedestal	
60 x 24 x 42	155
54 x 24 x 42	145
48 x 24 x 42	140
42 x 24 x 42	135

Standard Veneer Top Standard Veneer Chassis		Premium Veneer Top Premium Veneer Chassis		High Pressure Laminate Top Veneer Chassis		Thermally Fused Laminate Top Thermally Fused Laminate Chassis	
CPC6042RP930W	3675	CPC6042RP930P	4043	CPC6042RP930G	3675	CPC6042RP930M	1741
CPC5442RP930W	3604	CPC5442RP930P	3965	CPC5442RP930G	3604	CPC5442RP930M	1711
CPC4842RP930W	3523	CPC4842RP930P	3877	CPC4842RP930G	3523	CPC4842RP930M	1681
CPC4242RP930W	3455	CPC4242RP930P	3800	CPC4242RP930G	3455	CPC4242RP930M	1650
CPC6042RP931W	3675	CPC6042RP931P	4043	CPC6042RP931G	3675	CPC6042RP931M	1741
CPC5442RP931W	3604	CPC5442RP931P	3965	CPC5442RP931G	3604	CPC5442RP931M	1711
CPC4842RP931W	3523	CPC4842RP931P	3877	CPC4842RP931G	3523	CPC4842RP931M	1681
CPC4242RP931W	3455	CPC4242RP931P	3800	CPC4242RP931G	3455	CPC4242RP931M	1650

Product Features

- 1 Standard grommet - matches pull finish or specify black TM30, silver TM31 or antique brass TM33
- Finished back - open plan
- "W" & "G" SKUs feature soft close suspensions, "M" SKUs feature ball bearing suspensions. Both suspensions are full extension.

Options

Accessories

- K28: Articulating Keyboard w/ Mouse - \$390

Drawer

- P33: Wood Drawer Upgrade - \$45 per drawer
- P40W: extra Box/Box/File or File/File to Kneespace - \$910 (N/A on 58") (W,G)
- P40M: extra Box/Box/File or File/File to Kneespace - \$720 (N/A on 58") (M)
- WPD3061: Designer White - \$80 per lateral F/F pedestal

Grommets (Non-Standard Location)

Provide drawing w/ Grommet Location and Specify Color - \$95 ea.

- Black: TM30-NS
- Silver: TM31-NS
- Antique Brass: TM33-NS

Plank Match Veneer

- RPMV: Random Walnut Plank Match Veneer (Horizontal Grain with 25%+ Sap) - Add 10%. Clear coat only.

C154R: Reception counter fabric grades. Pricing Applies to All Sizes.

COM	COL	1	2	3
214	N/A	246	262	278
4	5	6	7	8
294	310	326	342	358
9	10	11/ L1	12	13/ L2
374	390	406	422	454

2 Select Finish

[Click to view finishes](#)

WAC	WNW
WIC	WWP
WHC	WNF(Natural
WOC	Oak on Flat
WEC	Cut)
WAM	WSF(Salted
WCM	Oak on Flat
WEW	Cut)
WGW	WMF(Mocha
WBW	Oak on Flat
WSW	Cut)

TBCO
TBSW
TSTV
TSMV
TSLV
TOBW
WMO
WNO
WSO

GAC	+10%
GIC	GSLV
GHC	+10%
GOC	GWL
GEC	
GAM	
GCM	
GEW	
GNW	
GSTV	

MAC
MOC
MEC
MGW
MTW
MSW
MWL
MNA

3 Select Edge

[Click to view edges](#)



Flat



Flat



Flat



Flat

4 Select Hardware

[Click to view details](#)

[See Intro Page for Pull Options](#)

[See Intro Page for Pull Options](#)

[See Intro Page for Pull Options](#)

[See Intro Page for Pull Options](#)

Central Park

Reception Return
Lateral File

[Click here to view statement of line](#)

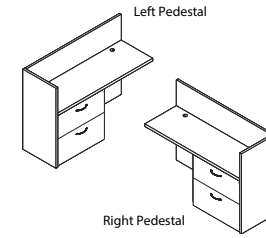

1 Select Model

w" x d" x h"

Weight	Standard Veneer Top Standard Veneer Chassis	Premium Veneer Top Premium Veneer Chassis	High Pressure Laminate Top Veneer Chassis	Thermally Fused Laminate Top Thermally Fused Laminate Chassis
Left Pedestal				
72 x 24 x 42	270	CPC7242RP932W 4509	CPC7242RP932P 4960	CPC7242RP932G 4509
66 x 24 x 42	250	CPC6642RP932W 4333	CPC6642RP932P 4767	CPC6642RP932G 4333
60 x 24 x 42	235	CPC6042RP932W 4168	CPC6042RP932P 4585	CPC6042RP932G 4168
54 x 24 x 42	205	CPC5442RP932W 4087	CPC5442RP932P 4496	CPC5442RP932G 4087
48 x 24 x 42	195	CPC4842RP932W 4008	CPC4842RP932P 4410	CPC4842RP932G 4008
Right Pedestal				
72 x 24 x 42	270	CPC7242RP933W 4509	CPC7242RP933P 4960	CPC7242RP933G 4509
66 x 24 x 42	250	CPC6642RP933W 4333	CPC6642RP933P 4767	CPC6642RP933G 4333
60 x 24 x 42	235	CPC6042RP933W 4168	CPC6042RP933P 4585	CPC6042RP933G 4168
54 x 24 x 42	205	CPC5442RP933W 4087	CPC5442RP933P 4496	CPC5442RP933G 4087
48 x 24 x 42	195	CPC4842RP933W 4008	CPC4842RP933P 4410	CPC4842RP933G 4008

2 Select Finish

[Click to view finishes](#)

WAC	WNW	TBCO	GAC +10%	MAC
WIC	WWP	TBSW	GIC GSLV	MOC
WHC	WNF(Natural	TSTV	GHC +10%	MEC
WOC	Oak on Flat	TSMV	GOC GWL	MGW
WEC	Cut)	TSLV	GEC	MTW
WAM	WSF(Salted	TOBW	GAM	MSW
WCM	Oak on Flat	WMO	GCM	MWL
WEW	Cut)	WNO	GEW	MNA
WGW	WMF(Mocha	WSO	GNW	
WBW	Oak on Flat		GSTV	
WSW	Cut)			

3 Select Edge

[Click to view edges](#)



4 Select Hardware

[Click to view details](#)

[See Intro Page
for Pull Options](#)

[See Intro Page
for Pull Options](#)

[See Intro Page
for Pull Options](#)

[See Intro Page
for Pull Options](#)

Product Features

- 1 Standard grommet - matches pull finish or specify black TM30, silver TM31 or antique brass TM33
- Finished back - open plan
- Features ball bearing suspensions, suspensions are full extension.

Options

Accessories

- K28: Articulating Keyboard w/ Mouse - \$390

Drawer

- P33: Wood Drawer Upgrade - \$45 per drawer
- P40W: extra Box/Box/File or File/File to Kneespace - \$910 (N/A on 58") (W,G)
- P40M: extra Box/Box/File or File/File to Kneespace - \$720 (N/A on 58") (M)
- WPD3061: Designer White - \$80 per lateral pedestal

Grommets (Non-Standard Location)

- Provide drawing w/ Grommet Location and Specify Color - \$95 ea.
- Black: TM30-NS
- Silver: TM31-NS
- Antique Brass: TM33-NS

Plank Match Veneer

- RPMV: Random Walnut Plank Match Veneer (Horizontal Grain with 25%+ Sap) - Add 10%. Clear coat only.

C154R: Reception counter fabric grades. Pricing Applies to All Sizes.

COM	COL	1	2	3
217	N/A	297	337	377
4	5	6	7	8
417	457	497	537	577
9	10	11/ L1	12	13/ L2
617	657	697	737	817

Central Park

Sit-On Reception Counters
Return Gallery

[Click here to view statement of line](#)

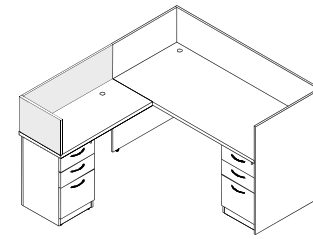

1 Select Model

w" x d" x h"	Weight
Left Hookup	
72 x 22 x 14	65
66 x 22 x 14	60
60 x 22 x 14	55
54 x 22 x 14	50
48 x 22 x 14	45
42 x 22 x 14	40
Right Hookup	
72 x 22 x 14	65
66 x 22 x 14	60
60 x 22 x 14	55
54 x 22 x 14	50
48 x 22 x 14	45
42 x 22 x 14	40

	Standard Veneer Top Standard Veneer Chassis	Premium Veneer Top Premium Veneer Chassis	High Pressure Laminate Top Veneer Chassis	Thermally Fused Laminate Top Thermally Fused Laminate Chassis
	CPC7222AU598W 1997	CPC7222AU598P 2198	"G" Option N/A	"M" Option N/A
	CPC6622AU598W 1813	CPC6622AU598P 1995	"G" Option N/A	"M" Option N/A
	CPC6022AU598W 1627	CPC6022AU598P 1790	"G" Option N/A	CPC6022AU598M 884
	CPC5422AU598W 1444	CPC5422AU598P 1589	"G" Option N/A	CPC5422AU598M 785
	CPC4822AU598W 1259	CPC4822AU598P 1386	"G" Option N/A	CPC4822AU598M 686
	CPC4222AU598W 1075	CPC4222AU598P 1183	"G" Option N/A	CPC4222AU598M 587
	CPC7222AU599W 1997	CPC7222AU599P 2198	"G" Option N/A	"M" Option N/A
	CPC6622AU599W 1813	CPC6622AU599P 1995	"G" Option N/A	"M" Option N/A
	CPC6022AU599W 1627	CPC6022AU599P 1790	"G" Option N/A	CPC6022AU599M 884
	CPC5422AU599W 1444	CPC5422AU599P 1589	"G" Option N/A	CPC5422AU599M 785
	CPC4822AU599W 1259	CPC4822AU599P 1386	"G" Option N/A	CPC4822AU599M 686
	CPC4222AU599W 1075	CPC4222AU599P 1183	"G" Option N/A	CPC4222AU599M 587
	WAC WNW TBCO MAC	WIC WWP TBSW MOC	WHC WNF(Natural) TSTV MEC	WOC Oak on Flat TSMV MGW
	WEC Cut) TSLV MTW	WAM WSF(Salted) TOBW MSW	WCM Oak on Flat WMO MWL	WEW Cut) WNO MNA
	WGW WMF(Mocha) WSO	WBW Oak on Flat	WSW Cut)	
	Edge N/A	Edge N/A	Edge N/A	
	Hardware N/A	Hardware N/A	Hardware N/A	

Product Features

- Alignment pins in unit below

Notes

- For use on standard 29" H desks

C157R: Reception counter fabric grades, pricing applies to all sizes

COM	COL	1	2	3
217	N/A	297	337	377
4	5	6	7	8
417	457	497	537	577
9	10	11/ L1	12	13/ L2
617	657	697	737	817

2 Select Finish

[Click to view finishes](#)

3 Select Edge

[Click to view edges](#)

4 Select Hardware

[Click to view details](#)

Central Park

Reception Bridge
Standard "U" Bridge

[Click here to view statement of line](#)

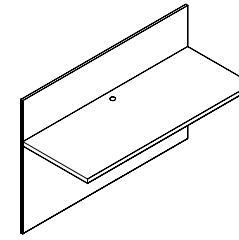

1 Select Model

w" x d" x h"
48 x 24 x 42

Weight
140

Standard Veneer Top Standard Veneer Chassis		Premium Veneer Top Premium Veneer Chassis		High Pressure Laminate Top Veneer Chassis		Thermally Fused Laminate Top Thermally Fused Laminate Chassis	
CPC4842RP164W	1239	CPC4842RP164P	1363	CPC4842RP164G	1239	CPC4842RP164M	1014

Product Features

- 1 Standard grommet - matches pull finish or specify black TM30, silver TM31 or antique brass TM33
- Finished back - open plan

Options

Grommets (Non-Standard Location)

Provide drawing w/ Grommet Location and Specify Color - \$95 ea.

- Black: TM30-NS
- Silver: TM31-NS
- Antique Brass: TM33-NS

Plank Match Veneer

- RPMV: Random Walnut Plank Match Veneer (Horizontal Grain with 25%+ Sap) - Add 10%. Clear coat only.

C157R: Reception counter fabric grades, pricing applies to all sizes

COM	COL	1	2	3
217	N/A	297	337	377
4	5	6	7	8
417	457	497	537	577
9	10	11/ L1	12	13/ L2
617	657	697	737	817

2 Select Finish

[Click to view finishes](#)

WAC	WNW
WIC	WWP
WHC	WNF(Natural
WOC	Oak on Flat
WEC	Cut)
WAM	WSF(Salted
WCM	Oak on Flat
WEW	Cut)
WGW	WMF(Mocha
WBW	Oak on Flat
WSW	Cut)

TBCO
TBSW
TSTV
TSMV
TSLV
TOBW
WMO
WNO
WSO

GAC +10%
GIC GSLV
GHC +10%
GOC GWL
GEC
GAM
GCM
GEW
GNW
GSTV

MAC
MOC
MEC
MGW
MTW
MSW
MWL
MNA

3 Select Edge

[Click to view edges](#)



4 Select Hardware

[Click to view details](#)

Hardware
N/A

Hardware
N/A

Hardware
N/A

Hardware
N/A

Central Park

Standard Reception "U" Credenzas
File / File

[Click here to view statement of line](#)

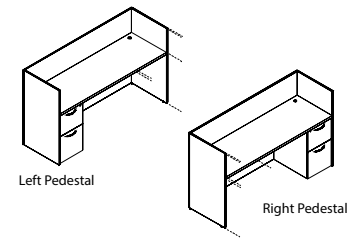

1 Select Model

w" x d" x h"
Left Pedestal
72 x 24 x 42
Right Pedestal
72 x 24 x 42

Weight	Standard Veneer Top Standard Veneer Chassis	Premium Veneer Top Premium Veneer Chassis	High Pressure Laminate Top Veneer Chassis	Thermally Fused Laminate Top Thermally Fused Laminate Chassis
275	CPC7242RP938W 4164	CPC7242RP938P 4581	CPC7242RP938G 4164	CPC7242RP938M 2252
275	CPC7242RP939W 4164	CPC7242RP939P 4581	CPC7242RP939G 4164	CPC7242RP939M 2252

2 Select Finish

[Click to view finishes](#)

WAC	WNW
WIC	WWP
WHC	WNF(Natural
WOC	Oak on Flat
WEC	Cut)
WAM	WSF(Salted
WCM	Oak on Flat
WEW	Cut)
WGW	WMF(Mocha
WBW	Oak on Flat
WSW	Cut)

TBCO
TBSW
TSTV
TSMV
TSLV
TOBW
WMO
WNO
WSO

GAC +10%
GIC GSLV
GHC +10%
GOC GWL
GEC
GAM
GCM
GEW
GNW
GSTV

MAC
MOC
MEC
MGW
MTW
MSW
MWL
MNA

3 Select Edge

[Click to view edges](#)



Flat



Flat



Flat



Flat

4 Select Hardware

[Click to view details](#)

See Intro Page
for Pull Options

See Intro Page
for Pull Options

See Intro Page
for Pull Options

See Intro Page
for Pull Options

Product Features

- 2 standard grommet - matches pull finish or specify black TM30, silver TM31 or antique brass TM33
- Finished back - open plan
- "W" & "G" SKUs feature soft close suspensions, "M" SKUs feature ball bearing suspensions. Both suspensions are full extension.

Options

Accessories

- K28: Articulating Keyboard w/ Mouse - \$390

Drawer

- P33: Wood Drawer Upgrade - \$45 per drawer
- WPD3061: Designer White - \$80 per door

Grommets (Non-Standard Location)

Provide drawing w/ Grommet Location and Specify Color - \$95 ea.

- Black: TM30-NS
- Silver: TM31-NS
- Antique Brass: TM33-NS

Plank Match Veneer

- RPMV: Random Walnut Plank Match Veneer (Horizontal Grain with 25%+ Sap) - Add 10%. Clear coat only.

Storage

- P6: Modify File/File to Box/Box/File - \$55 per pedestal
- P33: Wood Drawer Upgrade - \$45 per drawer
- P40W: extra Box/Box/File or File/File to Kneespace - \$910 (N/A on 58") (W,G)
- P40M: extra Box/Box/File or File/File to Kneespace - \$720 (N/A on 58") (M)

C154R: Reception counter fabric grades. Pricing Applies to All Sizes.

COM	COL	1	2	3
217	N/A	297	337	377
4	5	6	7	8
417	457	497	537	577
9	10	11/ L1	12	13/ L2
617	657	697	737	817

Central Park

Standard Reception "U" Credenzas
Lateral File

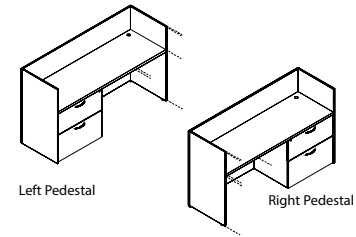

[Click here to view statement of line](#)

1 Select Model

w" x d" x h"	Weight
89 x 24 x 42	395
72 x 24 x 42	300
66 x 24 x 42	285
89 x 24 x 42	395
72 x 24 x 42	300
66 x 24 x 42	285

Standard Veneer Top Standard Veneer Chassis		Premium Veneer Top Premium Veneer Chassis		High Pressure Laminate Top Veneer Chassis		Thermally Fused Laminate Top Thermally Fused Laminate Chassis	
CPC8942RP940W	4803	CPC8942RP940P	5284	CPC8942RP940G	4803	CPC8942RP940M	2569
CPC7242RP940W	4335	CPC7242RP940P	4769	CPC7242RP940G	4335	CPC7242RP940M	2502
CPC6642RP940W	4176	CPC6642RP940P	4595	CPC6642RP940G	4176	CPC6642RP940M	2463
CPC8942RP941W	4803	CPC8942RP941P	5284	CPC8942RP941G	4803	CPC8942RP941M	2569
CPC7242RP941W	4335	CPC7242RP941P	4769	CPC7242RP941G	4335	CPC7242RP941M	2502
CPC6642RP941W	4176	CPC6642RP941P	4595	CPC6642RP941G	4176	CPC6642RP941M	2463

Product Features

- 2 standard grommet - matches pull finish or specify black TM30, silver TM31 or antique brass TM33
- Finished back - open plan
- Features ball bearing suspensions, suspensions are full extension.

Options

Accessories

- K28: Articulating Keyboard w/ Mouse - \$390

Drawer

- P33: Wood Drawer Upgrade - \$45 per drawer
- WPD3061: Designer White - \$160 per lateral pedestal

Grommets (Non-Standard Location)

- Provide drawing w/ Grommet Location and Specify Color - \$95 ea.
- Black: TM30-NS
- Silver: TM31-NS
- Antique Brass: TM33-NS

Plank Match Veneer

- RPMV: Random Walnut Plank Match Veneer (Horizontal Grain with 25%+ Sap) - Add 10%. Clear coat only.

Storage

- P6: Modify File/File to Box/Box/File - \$55 per pedestal
- P33: Wood Drawer Upgrade - \$45 per drawer
- P40W: extra Box/Box/File or File/File to Kneespace - \$910 (N/A on 58") (W,G)
- P40M: extra Box/Box/File or File/File to Kneespace - \$720 (N/A on 58") (M)

C154R: Reception counter fabric grades. Pricing Applies to All Sizes.

COM	COL	1	2	3
217	N/A	297	337	377
4	5	6	7	8
417	457	497	537	577
9	10	11/ L1	12	13/ L2
617	657	697	737	817

2 Select Finish

[Click to view finishes](#)

WAC	WNW
WIC	WWP
WHC	WNF(Natural
WOC	Oak on Flat
WEC	Cut)
WAM	WSF(Salted
WCM	Oak on Flat
WEW	Cut)
WGW	WMF(Mocha
WBW	Oak on Flat
WSW	Cut)

TBCO
TBSW
TSTV
TSMV
TSLV
TOBW
WMO
WNO
WSO

GAC +10%
GIC GSLV
GHC +10%
GOC GWL
GEC
GAM
GCM
GEW
GNW
GSTV

MAC
MOC
MEC
MGW
MTW
MSW
MWL
MNA

3 Select Edge

[Click to view edges](#)



4 Select Hardware

[Click to view details](#)

See Intro Page
for Pull Options

See Intro Page
for Pull Options

See Intro Page
for Pull Options

See Intro Page
for Pull Options

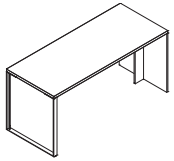

BASE MODIFICATIONS

runoff sleigh base

Style Number	List Price
24" Metal Sleigh Base SSB24	450
30" Metal Sleigh Base SSB30	475
36" Metal Sleigh Base SSB36	495

COMPUTER SUPPORT

single monitor arm

Style Number	List Price
MA1	280

COMPUTER SUPPORT

double monitor arm

Style Number	List Price
MA2	450

COMPUTER SUPPORT

triple monitor arm

Style Number	List Price
MA3	530

Specifications

- Metal Sleigh base - standard in silver finish

Specifications

- Available in black or silver
- Desk clamp and mounting included
- Easy assembly and flexibility
- Elastic painting process for a durable and beautiful finish
- Gas spring tension adjustment for counter-balance height adjustment for monitors 1-8 KG
- Gas spring tested to 50,000 repetitions
- Hidden cable management
- Monitor arm will hold 15"-27"monitors and up to 18lbs

Specifications

- Available in black or silver
- Desk clamp and mounting included
- Easy assembly and flexibility
- Elastic painting process for a durable and beautiful finish
- Gas spring tension adjustment for counter-balance height adjustment for monitors 1-8 KG
- Gas spring tested to 50,000 repetitions
- Hidden cable management
- Monitor arm will hold 15"-27"monitors and up to 18lbs

Specifications

- Available in black or silver
- Desk clamp and mounting included
- Easy assembly and flexibility
- Elastic painting process for a durable and beautiful finish
- Gas spring tension adjustment for counter-balance height adjustment for monitors 1-8 KG
- Gas spring tested to 50,000 repetitions
- Hidden cable management
- Monitor arm will hold 15"-27"monitors and up to 18lbs



COMPUTER SUPPORT
quadruple monitor arm

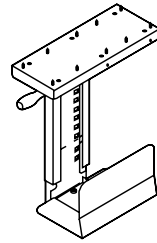

COMPUTER SUPPORT
cpu retractable cradle

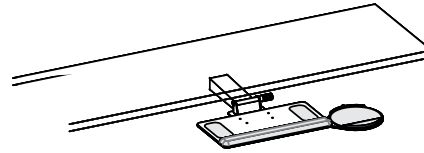

COMPUTER SUPPORT
articulating keyboard tray

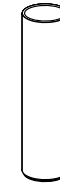

CONFERENCE DESK SUPPORT POST
wood drum

Style Number	List Price
MA4	705

Style Number	List Price
K18	205

Style Number	List Price
Factory Installed K28	395
Field Installed K28F	415

Style Number	List Price
6" Diameter Drum B6	415

Specifications

- Available in black
- Desk clamp and mounting included
- Easy assembly and flexibility
- Elastic painting process for a durable and beautiful finish
- Gas spring tension adjustment for counter-balance height adjustment for monitors 1-8 KG
- Gas spring tested to 50,000 repetitions
- Hidden cable management
- Monitor arm will hold 15"-27" monitors and up to 18lbs

Specifications

- Black Metal CPU Carriage
- Full 360° swivel capability allows easy access to rear of CPU for cables / wires
- Track allows 8- 1/2" extension
- Width Adjustment 5-1/2" to 9-1/4"
- Height adjustment 14- 5/8" to 20- 1/2"
- Black epoxy finish

- Notes
- Factory Installed

Specifications

- Adjusts effortlessly - A simple one-handed motion allows the keyboard to be repositioned instantly, without the use of locks or levers
- Encourages low-risk postures - Maximizes adjustability within a safe operating range.
- Will last a lifetime - Exceeds all applicable BIFMA Standards and comes with a lifetime guarantee.

- Notes
- Available on: Freestanding Desk
 - Factory Installed (standard)
 - FIELD INSTALL - \$415

Specifications

- Available in Walnut / Cherry / Maple
- Adjustable levelers
- Replaces standard metal round legs

- Notes
- Specify Finish
 - Not available in Thermally Fused Laminate

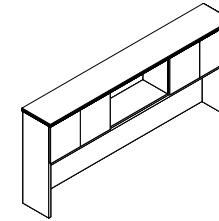
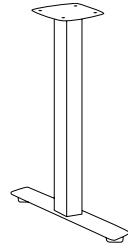
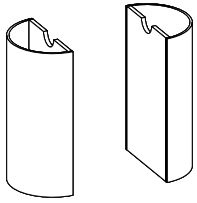

CONFERENCE DESK SUPPORT POST
wood half drum

CONFERENCE DESK SUPPORT POST
metal column t-leg

DOOR MODIFICATIONS
soft close door hinge

DOOR MODIFICATIONS
delete doors

Style Number	List Price
8" Half Drum HC08	725
16" Diameter Drum HC16	935

Style Number	List Price
Silver 32MOTS	485
Black 32MOTB	485

Style Number	List Price
D9SC	20 Per door

Style Number	List Price
D6	N/C

Specifications

- Available in Walnut / Cherry / Maple
- Adjustable levelers

Notes
- Specify Finish

Specifications

- Available with casters
- Recommended top size: 36"D-42"D
- Single column: 2-3/4" x 2-3/4" with 32" foot
- Standard Silver base (optional Black)

Specifications

- Snap onto standard door hinge
- Requires (2) per door
- Max door height 43"
- Factory installed where specified
- Individually shipped for field installation

Notes
- Specify Each Item To Have Slow Close Feature

Specifications

- Standard Door overheads and cabinets can have door deleted for open access. Modification of hinge rails and structural components are made face ready.

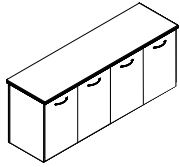

DOOR MODIFICATIONS

delete doors/replace black laminate shelf w/ finished shelf

Style Number	List Price
D6A	N/C

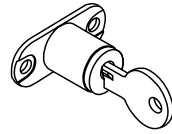

DOOR MODIFICATIONS

panel door lock

Style Number	List Price
D2	100 Per door set

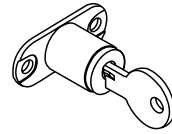

DOOR MODIFICATIONS

glass door lock

Style Number	List Price
D2-G	205 Per door set

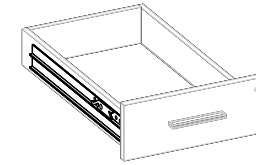

DRAWER OPTIONS

soft close suspension

Style Number	List Price
SCS1	25 Per drawer

Specifications

- Delete doors and replace black laminate shelf with finished shelf

Notes
- Available on: All Storage "W"/"G" Style Credenzas.

Specifications

- Door Locks - 1 Door w/ Lock, Other Door w/ Catch Latch
- Contact Customer Service regarding limited lock locations and keying.

Notes
- Available on: Panel Doors, Wood Frame Doors, and Silverluma doors

Specifications

- Door Locks - 1 Door w/ Lock, Other Door w/ Catch Latch
- Contact Customer Service regarding limited lock locations and keying.

Notes
- Available on: Glass Doors

Specifications

- Factory installed where specified

Notes
- Not recommended for field installation

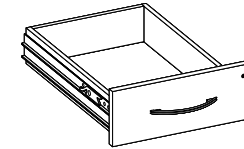
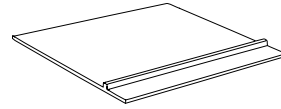
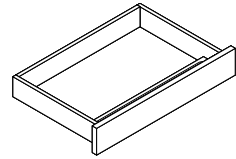
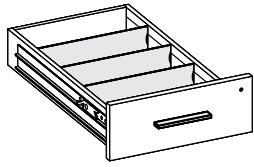

DRAWER OPTIONS
box drawer accessories

DRAWER OPTIONS
finished center drawer

DRAWER OPTIONS - BOTTOM COVER
felt bottom center drawer insert liner

DRAWER OPTIONS - UPGRADE
wood drawer upgrade

Style Number	List Price
Wood Drawer Dividers w/ Clips K-DIV	SET OF 3 - 30
Single Tray - Utility Tray K-Sut	35 ea.

Style Number	List Price
K31	205
Add Skirt Option K31-SK	310

Style Number	List Price
K3	100

Style Number	List Price
P33	45 Per drawer

Specifications

- K-DIV Extra Wood Drawer Dividers with Clips, Top Box drawers standard with 1 divider
- K-SUT Single Tray - Utility Tray, Specify Legal or Letter drawer width

Specifications

- Veneer drawer front finished to match unit W or G style veneer.
- Ball bearing smooth operation
- Drawer has lifetime guarantee
- Standard with matching wood grain pencil tray
- Laminate drawer front to match laminate unit (M style)

Specifications

- Inserts into center drawer and features divider for open pen and pencil storage. Removable for easy cleaning.
- Adds a luxurious touch to center drawers.
- Color: Dark Brown Coal

Specifications

- Dowel joint construction
- Hardwood veneer multi-ply drawer
- UV finish
- 1/4" Wood veneer bottoms
- File drawer bottoms are five block reinforced for heavy weight capacity
- Lifetime guaranteed

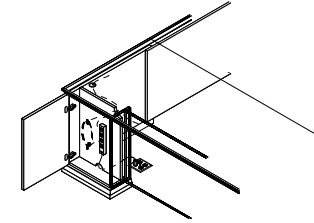
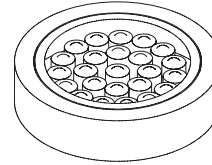

GLASSBOARD ACCESSORIES

glassboard accessory kit

Style Number	List Price
GBKIT	290

TASK LIGHTING

lt-led task light

Style Number	List Price
LT-LED24	215
24" Task light	
LT-LED48	260
48" Task light	
LT-LED60	335
60" Task light	
LT-LED72	360
72" Task light	
OCCA	50
Occupany Switch for recessed LED light	

LIGHTING

led interior cabinet puck light

Style Number	List Price
Starter Kit	
LEDPK	310
1 LED Interior Puck Light	
PK	130

PEDESTAL MODIFICATIONS

breakfront pedestal with wire management cavity door

Style Number	List Price
PC10	100
Power Supply Cordset	
PD717	100

Specifications

- 8 Earth magnets, 1 magnetic marker cup holder and 1 magnetic dry eraser

Specifications

- 6.5' Power cord. Switch with touch dimmer
- 36 LEDs per foot
- 4.6 Watts per foot
- 91 Lumens per watt
- Please note when ganging.
- Overhead tasklight cord is located on the right facing side. If the opposite location is required please contact customer service.

Specifications

- Starter kit includes Infeed, 1 Puck Interior Light and the ability to daisy chain up to 6 total Puck Lights
- (1) LED Puck Light with 30W power drive and switch
- Recessed fixture
- 12V linking cord 98"L
- Silver finish
- 50,000 hour life
- 2 watt per light

Notes

- Available on: Overhead/Tower Units with glass doors or no doors
- Power drive included, Light only

Specifications

- Hinged pedestal front door offers easy access for wire management
- Wire hooks provide wire coil storage
- Wire access openings allow access to floor, cabinets interior and kneespace
- Cabinet interior is black finish
- Top grommet is positioned over cavity for access ease
- (Power Strip Optional)

Notes

- Breakfront Chassis Only

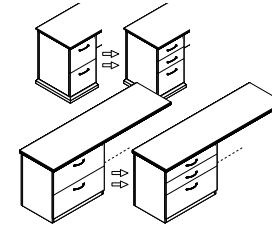
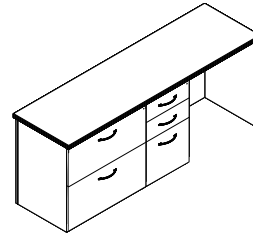
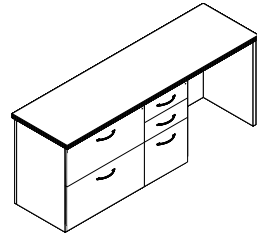
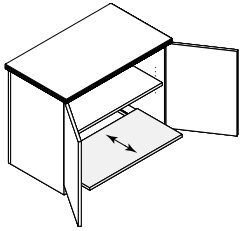

PEDESTAL MODIFICATIONS

black laminate printer pullout bottom shelf

Style Number	List Price
PPOS	225

PEDESTAL MODIFICATIONS

add veneer kneespace cabinets - no base

Style Number	List Price
Add Box/Box/File or File/File P40W	910
Add Lateral File 29" W P41W	1025
Add Multi-File - 31"W P42W	1140
Add Storage With Doors 29"W P43W	1025
Add CPU /Printer Cabinet - Open P44W	1025

PEDESTAL MODIFICATIONS

add melamine (tfl) kneespace cabinets - no base

Style Number	List Price
Add Box/Box/File or File/File P40M	720
Add Lateral File 29" W P41M	890
Add Multi-File - 31"W P42M	1005
Add Storage With Doors 29"W P43M	800
Add CPU /Printer Cabinet - Open P44M	915

PEDESTAL MODIFICATIONS

modify drawer configurations

Style Number	List Price
File/File to Box/Box/File P6	55 Per ped
Box/Box/File to File/File P6	55 Per ped
Lateral File to 2 Box Drawers P8	100 Per ped

Specifications

- Black Laminate pullout shelf on suspension
- Black grommet in back
- Adjustable Shelf

Specifications

- Multi-file specify Box/Box Left or Right

Notes
- Add additional Standard Cabinets To Kneespace Area.

Specifications

- Multi-file specify Box/Box Left or Right

Notes
- Available on: TFL products
- Add additional Standard Cabinets To Kneespace Area.

Specifications

- Modify File/File To Box/Box/File - Any Unit

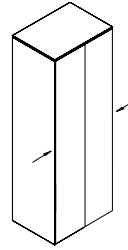
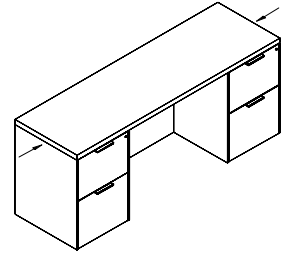
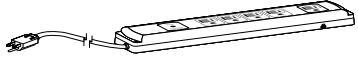

POWER / DATA
power supply cordset

PRODUCT MODIFICATIONS
modify width - open kneespace

PRODUCT MODIFICATIONS
modify width - open/closed storage

PRODUCT MODIFICATIONS
modify width - outside of mod-1, mod-2

Style Number	List Price
PD717	100

Style Number	List Price
MOD-1	125

Style Number	List Price
MOD-2	250

Style Number	List Price
MOD-3	Contact for pricing

Specifications

- SIZE: 10.75"L x 2.0"W x 1.06"H
- (5) Outlets w/ 10' cord
- Surge suppression (720 Joules)
- 15 Amp breaker
- Available on: Vertical Panels, Cabinet Interiors, and under tops

Specifications

- Modify width down on any unit with an open kneespace: desk, workstation credenza, bridge, return

Specifications

- Modify width down on any unit with open or closed storage section: overheads, wall hung units, storage credenzas, towers

Specifications

- Width modification outside of MOD-1 & MOD-2

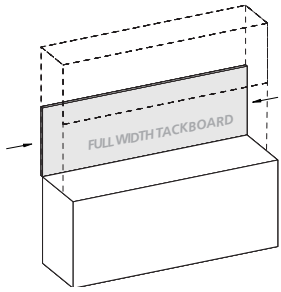

PRODUCT MODIFICATIONS
 modify width - tackboard, slat wall, veneer panel, or a glassboard

Style Number	List Price
MOD-4	50

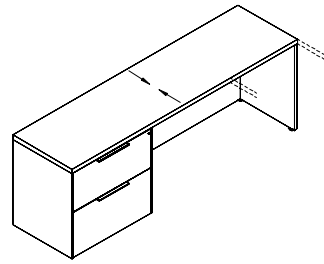

PRODUCT MODIFICATIONS
 modify depth - decrease depth

Style Number	List Price
MOD-5	125

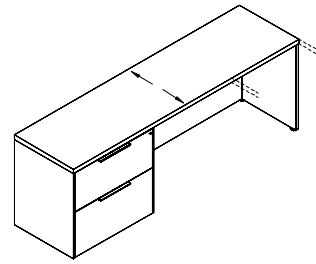

PRODUCT MODIFICATIONS
 modify depth - increase depth

Style Number	List Price
MOD-6	Add 10%

PRODUCT MODIFICATIONS
 modify height

Style Number	List Price
MOD-7	Contact for pricing

Specifications

- Modify width down on tackboard, slat wall, veneer panel, or a overhead glassboard

Specifications

- Modify depth down (minimum depth for a unit with drawers is 21"D)

Notes
 - Ex. 24" to 21", 30" to 24", and 36" to 30"

Specifications

- Increase depth by no more than 6"

Notes
 - Ex. 24" to 30", 30" to 36", and 36" to 42"
 - Add 10% to the unit you want to increase the depth of by no more than 6"

Specifications

- Modify height of a unit

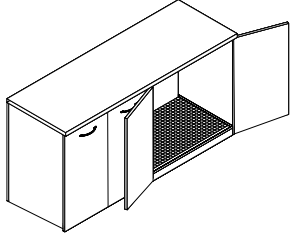

REFRIGERATOR MODIFICATION
refrigerator cabinet modification

SHAPED TOPS
overhead/wall hung shaped top

SHAPED TOPS
bookcase shaped top

SHAPED TOPS
tower shaped top

Style Number	List Price
REF01	205

Style Number	List Price
99"W - 105"W TOH-1	425
58"W - 93"W TOH-2	330
29"W - 47"W TOH-3	215

Style Number	List Price
29"W - 35"W x 15"D TOH-4	215

Style Number	List Price
16" Single Width Tower TOH-5	165
29"W - 46"W Tower TOH-6	215

Specifications

- Open back cutout for venting
- Moisture sponge mat
- Contaminate ledge
- Contact customer service for maximum refrigerator size (Changes based on unit).

Notes

- Available on: 36" and 42" Storage Credenzas

Specifications

- Shaped tops for overheads and wall hungs

Specifications

- 15" D Shaped tops for bookcases
- Shaped on front

Specifications

- 24" deep shaped tops for towers
- Shaped on front

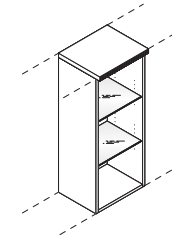
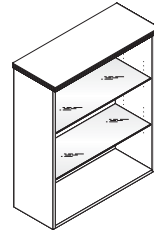

SHAPED TOPS

worksurface shaped top

Style Number	List Price
Shape Four Sides S4S	55
Shape Three Sides S3S	55

SHAPED TOPS

premium edge - shaped worksurface top

Style Number	List Price
Shape Four Sides Premium Edge S4S-PE	Add 10%
Shape Three Sides Premium Edge S3S-PE	Add 10%

SHELF MODIFICATIONS

glass shelves - tempered full width
26" - 35"

Style Number	List Price
26"W - 35"W x 14"D Shelf GS14F	90

SHELF MODIFICATIONS

tempered glass shelves for half cabinet
17- 1/2" widths

Style Number	List Price
14-1/2"W - 17- 1/2"W x 14"D Shelf GS14H	70 ea.

Specifications

- S4S Applies to desk, bridge or any freestanding unit. This adds shapes or copes to two sides (desk, bridges) or one side and back of units (returns).
- S3S Applies to credenza units. This adds shapes to the two sides.
- Credenzas are shaped front standard with flat back

Notes

- Desk, Freestanding and Credenza units will grow 1" in width due to adding shapes on ends of units.

Specifications

- S4S-PE Applies to desk, bridge or any freestanding unit. This adds shapes or copes to two sides (desk, bridges) or one side and back with hardwood rims (returns).
- S3S-PE Shape Three Sides Premium Edge. Applies to credenza units. This adds shape to the two sides with hardwood rims.

Notes

- Desk, Freestanding and Credenza units will grow 1" in width due to adding shapes on ends of units.
- * 10% Upcharge includes 5% for premium edge

Specifications

- Glass Shelves Replace Wood Shelf In Open Or Glass Door Cabinet. Also Order Interior Cabinet Lighting.

Specifications

- Glass Shelves Replace Wood Shelf In Open Or Glass Door Cabinet. Also Order Interior Cabinet Lighting.

Notes

- Replace only adjustable shelves between cabinet light and fixed lower wood shelf.

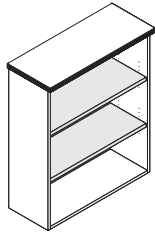

SHELF MODIFICATIONS

heavy duty solid wood bookcase
replacement shelves

Style Number	List Price
1" Wood Shelf 14" Deep S714F	80 ea.
1" Wood Shelf 24" Deep S714FX	160 ea.

SLAT WALL ACCESSORIES

slat wall accessory tray

Style Number	List Price
SWA9	50

SLAT WALL ACCESSORIES

slat wall folder tray

Style Number	List Price
SWA7	50

SLAT WALL ACCESSORIES

slat wall paper tray

Style Number	List Price
SWA2	40

Specifications

- 1" Solid Lumber Core Shelves Replace Standard 3/4" Plywood Adjustable And Fixed Shelves

Specifications

- Specify Black Or Matte Silver

Specifications

- Specify Black Or Matte Silver

Specifications

- Specify Black Or Matte Silver

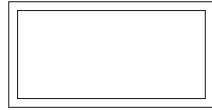

RECTANGLE INLAY

SLAT WALL ACCESSORIES

slat wall pencil holder

Style Number	List Price
SWA4	30

SPECIALTY VENEER ACCENTS

rectangle inlay - ebony hardwood
inlay detail

Style Number	List Price
T10SA	935

Specifications

- Specify Black Or Matte Silver

Specifications

- 3/16" x 3/16" thick hardwood ebony inlay is handfitted and glued into routed top and sanded flush with surface
- Inlay is finished over with all finish steps

Notes

- Ebony inlay not recommended in: Koko Cherry

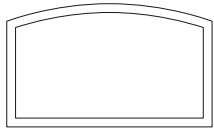

CURVED INLAY

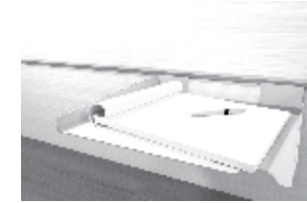
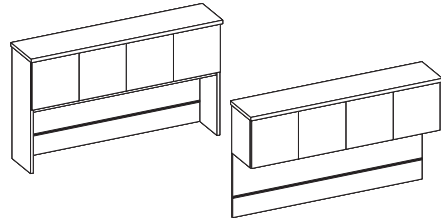

SPECIALTY VENEER ACCENTS

bowfront inlay - ebony hardwood inlay detail

Style Number	List Price
T11SA	1035

TOOL CHANNEL ACCESSORIES

recessed aluminum tool channel

Style Number	List Price
ATB02	5 per 1"W

TOOL CHANNEL ACCESSORIES

iphone holder

Style Number	List Price
ATB31	125

TOOL CHANNEL ACCESSORIES

large shelf

Style Number	List Price
ATB35	135

Specifications

- 3/16" x 3/16" thick hardwood ebony inlay is handfitted and glued into routed top and sanded flush with surface
- Inlay is finished over with all finish steps

Notes
- Ebony inlay not recommended in: Koko Cherry

Specifications

- Anodized aluminum finish
- Fully recessed
- Finish matches anodized aluminum accessories
- Can be specified with fabric tack surface mounted above channel

Notes
- If using tool channel with wallhung overhead, a veneer panel must be specified.

Specifications

- For Console/Wall Hung Back Panels With Optional Tool Bar
- 18 Gauge Steel - Stamp Formed
- Silver Powderdercoat Finish
- 5" x 3 -3/4"W
- Non-slip Neoprene pad

Specifications

- 12"W x 10"D

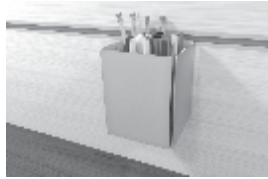

TOOL CHANNEL ACCESSORIES
pencil pen holder

Style Number	List Price
ATB38	120

Specifications

- For Console/Wall Hung Back Panels With Optional Tool Bar
- 18 Gauge Steel - Stamp Formed
- Silver Powderdercoat Finish
- 5"H x 4"W x 4"D



TOOL CHANNEL ACCESSORIES
tablet holder

Style Number	List Price
ATB30	145

Specifications

- For Console/Wall Hung Back Panels With Optional Tool Bar
- 18 Gauge Steel - Stamp Formed
- Silver Powderdercoat Finish
- 10" x 8"W
- Non-slip Neoprene pad

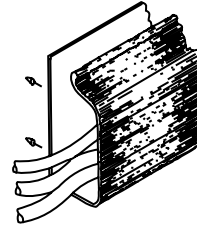

WIRE MANAGEMENT
horizontal j-channel wire management raceway

Style Number	List Price
W1	80 Per 4' section

Specifications

- 4' section for field installation.
- The "J" shape black thermoplastic wire raceway may be added to specified worksurface tops to provide concealed channeling of wires to and from worksurface grommets. For use in open kneespace areas, raceway is attachable to top of back panel with pan head screws. Interior dimensions are 1" x 1- 1/2" providing ample storage for multiple wires and excess cable. Front of raceway flexes out for easy cord insertion.

- Notes
- Units w/ Wire Channel Standard.
 - Field Installation

Central Park Options

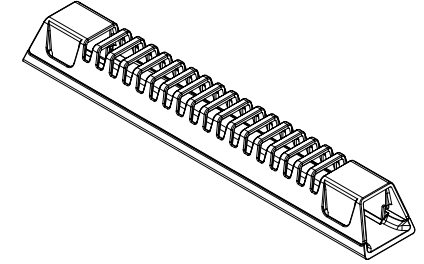

WIRE MANAGEMENT
horizontal wire management raceway

Style Number	List Price
W21	35

Specifications

- 10"W x 1.5"D x 1.25"H
- Grey Wire Manager (10.5")
- Power and data cables can be discretely housed and managed with the W21 Gray Wire Manager. This can be mounted in any location to metal frame or underside of conference tables and runs cables through a 1" channel from power module to hollow steel legs. This keeps cables organized under the table top. Release clips make it simple to snap on and off the Wire Manager for easy organization and access after attached to the table

- Notes
- Field installed

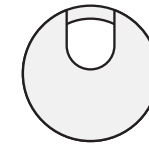
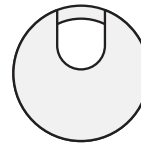

WIRE MANAGEMENT
horizontal u-channel wire management raceway

WIRE MANAGEMENT
coil wire manager

WIRE MANAGEMENT
standard location grommets - factory installed

WIRE MANAGEMENT
non-standard location grommets - factory installed

Style Number	List Price
W2A	80 Per 4' section

Style Number	List Price
W18	160

Style Number	List Price
Standard Location Grommet	
Black	
TM30	50
Silver	
TM31	50
Antique Brass	
TM33	50
White	
TM34	50

Style Number	List Price
Non-Standard Location Grommet	
Black	
TM30 -NS	95
Silver	
TM31 -NS	95
Antique Brass	
TM33 -NS	95
White	
TM34 -NS	95

Specifications

- 4' section for field installation.

- Notes
- Units w/ Wire Channel Standard.
 - Field Installation

Specifications

- Weighted Base, Table attachment plate
- 39- 1/2" Length
- Black

- Notes
- Location

Specifications

- 1 -5/8" Metal Grommet

- Notes
- *Units w/ Grommets Standard Are Noted Under Standard Features. Grommets Match Pull Finish - Standard (Unless Specified Otherwise)

Specifications

- 1 -5/8" Metal Grommet

- Notes
- *Units w/ Grommets Standard Are Noted Under Standard Features. Grommets Match Pull Finish - Standard (Unless Specified Otherwise)



WIRE MANAGEMENT

black plastic vertical surface
grommets - factory installed

Style Number	List Price
Standard Location Grommet TM50-C	50
Non-Standard Location Grommet TM50-NS	95

Specifications

- 2 " Black Plastic Grommet

Notes

- Standard Location is Bottom Center

Aircharge wireless charging grommet

Style Number	List Price
 ACWG WIRELESS GROMMET	\$213

Specifications

- › When used with GROVE Tables an additional \$350 LIST will apply for the special cutout required.
- › AirCharge offers a convenient way to charge any Qi compatible smartphone or device without the need to carry charging cables or find an available power outlet.
- › The Aircharge is powered by the latest Qi compliant IC offering reliable and efficient wireless charging in a convenient 3" grommet hub. Simply place your phone on the Aircharge and an LED will confirm pairing and begin wireless charging.
- › Recess: Efficient space conservation and quick access
- › Input: DC 5V (with included AC power adapter), DC 9V, 1.67A (with optional QC 2.0 power adapter)
- › Output: 5 watts Max. with DC 5V, 2A power adapter, 10 watts Max. with QC 2.0 power adapter
- › Qi V1.2 compliant IC
- › Charging distance: 6mm Max.

Available: All DARRAN collections



Cove power unit - non-linking

Style Number	List Price
 PD-COVE PLUG	\$600
Non-linking version	

Specifications

- › Size 5.75"L x 2.5"W
- › (2) 15 Amp Receptacles and (2) USB charging ports
- › Surface Mount
- › 108" Cord
- › Standard Silver Finish, Available in White or Black Finish upon request
- › ETL Listed

Available: All DARRAN collections



Cove corded series

Style Number	List Price
 PD-COVE-PKO	\$800

Specifications

- > Size 9.5"L x 2.5"W x 3.18"D
- > When used with GROVE Tables an additional \$350 LIST will apply for the special cutout required.
- > (2) Power Receptacles, (2) 2.1 Amp USB charging ports and (1) Telecom Plate Knockout
- > Surface Mount
- > 108" Cord
- > Standard Silver Finish, Available in White or Black Finish upon request
- > ETL Listed

Available: All DARRAN collections

Telecom Plates

RJ45 (1)	\$55
RJ45 (2)	\$110
RJ45 (3)	\$165
USB (1)	\$70
USB (2)	\$140
RJ11/RJ45	\$110
RJ45/USB	\$125
RJ45/HDMI	\$210
HDMI/DVI	\$325
HDMI/USB	\$205
HDMI/VGA	\$240
VGA/MINI-STEREO	\$155
VGA/USB	\$175



This pod can have up to 1 total plates.
 *All telecom connectors sold separately.



DARRAN®

Power & Data Options

FPDB flush power/data bay

Style Number	List Price
 Hardwired	
FPDB-H72 72" Cord	\$1363
FPDB-H108 108" Cord	\$1300
FPDB-H144 144" Cord	\$1350
FPDB-H180 180" Cord	\$1400
 Power/Plug	
FPDB-C72 72" Cord	\$1250
FPDB-C108 108" Cord	\$1300
FPDB-C144 144" Cord	\$1350
FPDB-C180 180" Cord	\$1400

Specifications

- > Size 14.19"L x 6.39"W x 3.38"H
- > (4) 15 Amp receptacles
- > Available in white, silver or black
- > (3) telecom plate cutouts standard
- > (1) Dual USB ports
- > Corded units are UL Listed and CSA Certified. Hardwired Units are CSA Certified
- > Select 72", 108", 144", or 180" power cord or hardwire whip cord

Available: All DARRAN collections, excludes rail and grove

Telecom Plates	
RJ45 (1)	\$55
RJ45 (2)	\$110
RJ45 (3)	\$165
USB (1)	\$70
USB (2)	\$140
RJ11/RJ45	\$110
RJ45/USB	\$125
RJ45/HDMI	\$210
HDMI/DVI	\$325
HDMI/USB	\$205
HDMI/VGA	\$240
VGA/MINI-STEREO	\$155
VGA/USB	\$175

This pod can have up to 3 total plates.
*All telecom connectors sold separately.



Standard underside Convenience plug. Can be used for Daisy Chaining up to (4) total units. Specify hardwired or plug for the first unit in series, daisy chained units will have a plug for connection through convenience plug.

Reef power unit with daisylink

Style Number	List Price
 REF310 PLUG	\$1199

Specifications

- › Size 16.1"L x 6.25"W x 4.89"D
- › When used with GROVE Tables an additional \$350 LIST will apply for the special cutout required.
- › (3) 120V Receptacles, (2) USB charging ports, 1 Data Plate Knockout, (2) Knockouts for RJ45 Data Ports
- › Surface Mount
- › 108" Cord
- › Features Convenience Plug on bottom of unit that allows for max (3) Daisy Chain
- › Standard Black Finish, Available in White or Silver Finish upon request
- › Additional Telecom Plate Knockout
- › RJ45 for Knockouts not required. If not ordered a small hole will be present in the pod in this this location
- › ETL Listed

Available: Conferencing

Telecom Plates	
RJ45 (1)	\$55
RJ45 (2)	\$110
RJ45 (3)	\$165
USB (1)	\$70
USB (2)	\$140
RJ11/RJ45	\$110
RJ45/USB	\$125
RJ45/HDMI	\$210
HDMI/DVI	\$325
HDMI/USB	\$205
HDMI/VGA	\$240
VGA/MINI-STEREO	\$155
VGA/USB	\$175

This pod can have up to 1 total plates.
 *All telecom connectors sold separately.



Soba wire manager

Style Number	List Price
STARTER UNITS	
SCDW	\$218
White wire manager	
SCDB	\$218
Black wire manager	

Specifications

- > Dimensions: 9ft x 9in x 3.15in
- > Zips up, bundles and routes loose, messy cables into a single tube
- > Routes and guides cables behind desks, TVs, and anywhere cables tend to get messy
- > Accommodates large or small cables, up to three cables at once
- > Support channels, used to route cables, include powerful adhesive backing which allows easy attachment to surfaces.

Available: All DARRAN collections



VILLA Power unit - non-linking

Style Number	List Price
 VIL-C PLUG	\$562
Non-Linking	

Specifications

- > Size: Top Grommet 5.68"L X 3.39"W; Under Top 12"L x 3.13"W x 3.08"D
- > (2) Power receptacles; (2) USB charging ports and (1) Knockouts for RJ45 Data Ports
- > Surface Mount
- > 72" Cord (Longer cord available, contact Customer Service)
- > Standard Silver Finish, Black Finish available upon request
- > UL or ETL Certified

Available: All DARRAN collections, excludes Grove

RJ45 Knockout	
RJ45 (1)	\$55





Rift Price List

Effective November 1, 2022

Designed By David Allan Pessa

Date	Page	Modification	Description
11.11.22		Price Increase	9% price increase applied to all items excluding options

Statement of Line
Features & Advantages1
Finishes | Specifications3
Edges | Pulls | Knobs.....4
Grommets | Grommet Reference.....5
Height Reference6
Modesty Reference | Grain Direction.....7
Drawer Dimensions | FILING Reference.....8
Double Pedestal Desk.....9
Table Desk.....12
Single Pedestal Desk.....16
Conference Desk.....18
Runoff Desk.....20
Returns.....22
Bridges26
Freestanding Credenzas27
Workstation Credenzas.....28
Bench Cabinets38
Pedestals40
Single Height Freestanding Overheads.....42
Double Height Freestanding Overheads.....44
Overhead Accessories.....45
Single Height Wall Hung Overheads.....49
Double Height Wall Hung Overheads.....51
Wall Hung Accessories53
Wall Hung Shelves.....58
Overhead Full Towers60
Vertical Half Towers.....61
Vertical Full Towers.....62
Bookcases.....65
Options66
Power & Data.....81

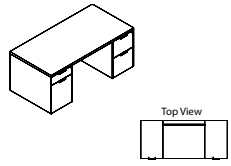

Page 9
Double Pedestal Desks
Breakfront Chassis

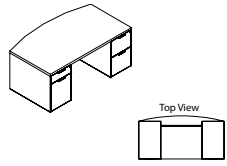

Page 10
Double Pedestal Desks
Bowfront Top Breakfront Chassis

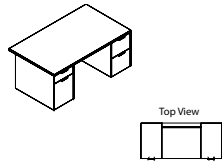

Page 11
Double Pedestal Desks
Overhang/Flush Chassis

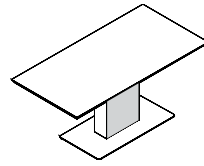

Page 12
Conference Table Desk
Rectangle Table Desk With
Column Base

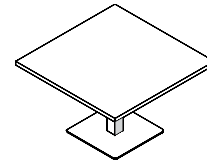

Page 13
Conference Table
Square Conference Table With
Column

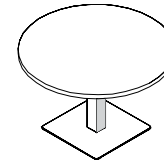

Page 14
Conference Table
Round Conference Table With
Column

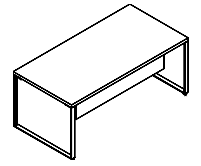

Page 15
Table Desks
Metal Sleigh

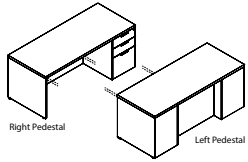

Page 16
Workstation Desks
Rectangle Top Breakfront Chassis

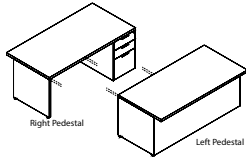

Page 17
Workstation Desks
Rectangle Overhang Top Flush
Chassis

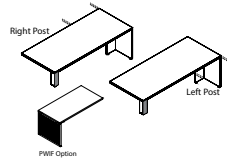

Page 18
Workstation Conference Desks
Rectangle

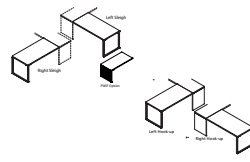

Page 19
Workstation/Bench Runoff Conference
Desks
Rectangle Metal Sleigh Support

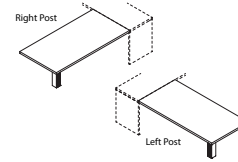

Page 20
Workstation Runoff Conference
Desks
Rectangle Post Support

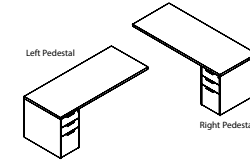

Page 21
Workstation/Bench Runoff Conference
Desks
Rectangle Box/Box/File

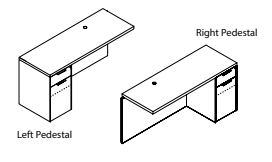

Page 22
"L" Workstation Returns
Box/Hidden Box/File

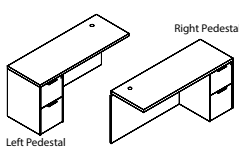

Page 23
"L" Workstation Returns
File/File

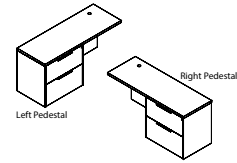

Page 24
"L" Workstation Returns
Lateral File

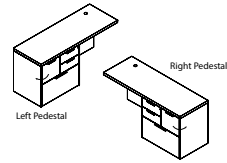

Page 25
"L" Workstation Returns
Box Box/Storage/Lateral File

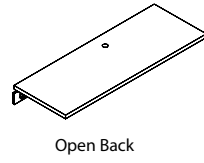

Page 26
Bridges
Open Back

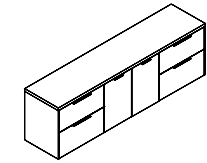

Page 27
Credenzas
File/Storage

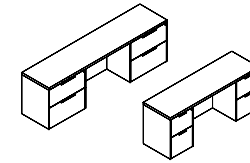

Page 28
Credenzas
Kneespace File/File And Lateral
File

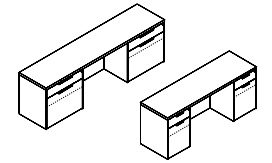

Page 29
Credenzas
Kneespace Box/Hidden Box/File

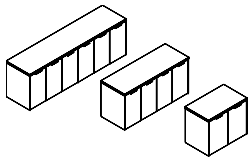

Page 30
Credenzas
Storage With Hinged Doors

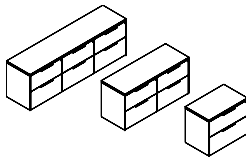

Page 31
Credenzas
Lateral File

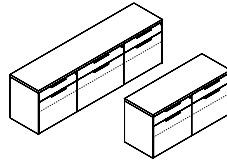

Page 32
Credenzas
Box/Hidden Box/Lateral File

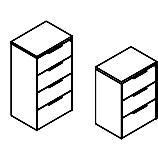

Page 33
Lateral Files
Vertical Lateral File

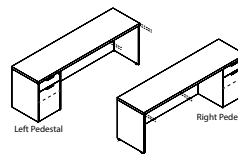

Page 34
Workstation Credenzas
Box/Hidden Box/File

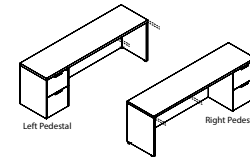

Page 35
Workstation Credenzas
File/File

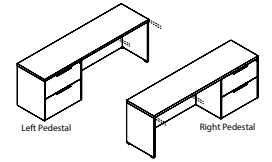

Page 36
Workstation Credenzas
Lateral File

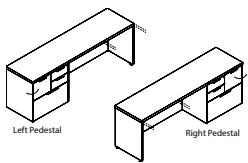

Page 37
Workstation Credenzas
Box/Box/Storage/Lateral File

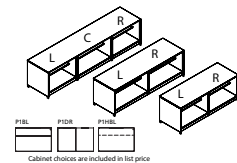

Page 38
Open Plan Bench Credenzas
Full Cabinet Bench

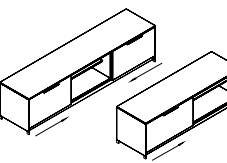

Page 39
Open Plan Bench Credenzas
Full Storage With Sliding Door

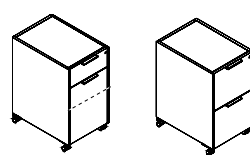

Page 40
Mobile Pedestals
Undersurface Mobile Pedestals

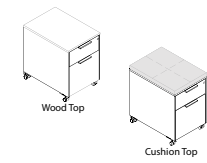

Page 41
Mobile Pedestals
Box/File

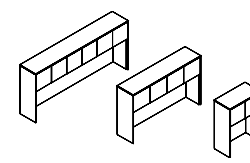

Page 42
Overhead Consoles Single
Height
Hinged Wood Doors

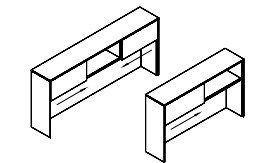

Page 43
Overhead Consoles Single
Height
Sliding Wood Doors

Statement of Line

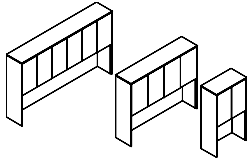

Page 44
Overhead Consoles Double Height
Hinged Wood Doors

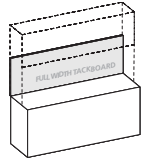

Page 45
Overhead Tackboards

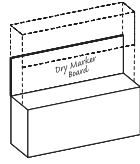

Page 46
Overhead Dry Marker Boards

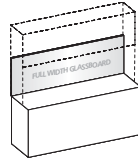

Page 47
Overhead Glassboards

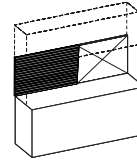

Page 48
Overhead Slat Wall

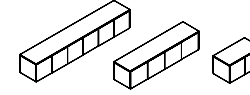

Page 49
Wall Hung Storage Single Height
Hinged Wood Doors

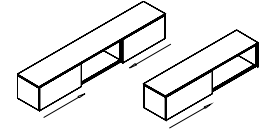

Page 50
Wall Hung Storage Single Height
Sliding Wood Doors

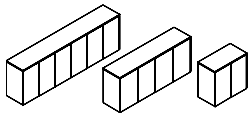

Page 51
Wall Hung Storage Double Height
Hinged Wood Doors

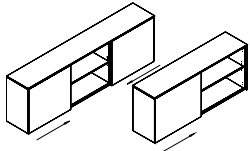

Page 52
Wall Hung Storage Double Height
Sliding Wood Doors

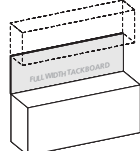

Page 53
Wall Hung Tackboards

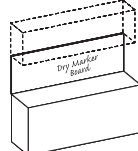

Page 54
Wall Hung Dry Marker Boards

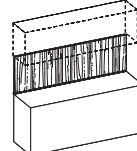

Page 55
Wall Hung Veneer Panels

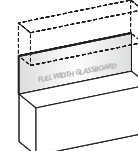

Page 56
Wall Hung Glassboards

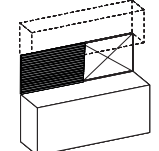

Page 57
Wall Hung Slat Wall

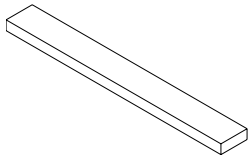

Page 58
Floating Wall Mounted Shelf
Single Shelf

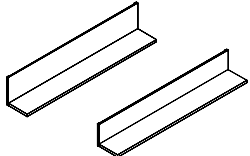

Page 59
Wall Hung Open Shelf
Single Height - 19"/15"H

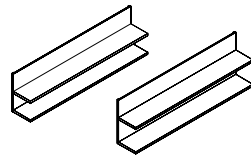

Page 60
Wall Hung Open Shelf
Double Height - 32"/28"H

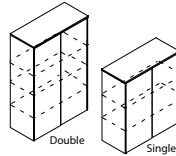

Page 61
Overhead Full Towers
Storage With Hinged Wood Door

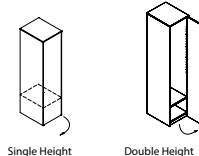

Page 62
Vertical Half Towers
Wardrobe With Door

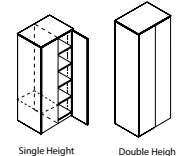

Page 63
Vertical Full Towers
Wardrobe Storage With Double Door

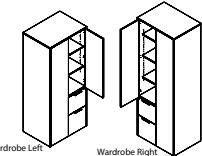

Page 64
Vertical Full Towers
File-File/Storage/Full Wardrobe

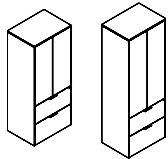

Page 65
Vertical Full Towers
2 Lateral File/Storage Double Door

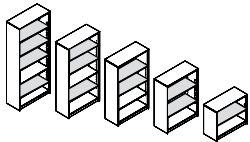

Page 66
Open Bookcases
15" Deep

Veneer tops

Veneer tops and high-pressure laminate tops feature a 45-pound density substrate with balanced 3-ply construction. Primary surface tops are 1-5/16" thick, bench credenzas, towers and overhead tops are 3/4" thick. Rift collection features double cut reconstituted walnut and oak veneer. Veneer tops feature a 3mm external solid hardwood band, HPL tops features a 2mm flat PVC band or a 1mm laminate self-edge. Some collections feature double cut reconstituted walnut and oak veneers.

Cleaning wood & laminate

In addition to regular dusting, give your furniture an occasional cleaning in accordance with our cleaning instructions. DARRAN wood and laminate products can be cleaned with a soft cloth and a mild soap and water mixture. Use approximately 32 oz of water mixed with one tablespoon of dish soap, always wiping with the grain. Dry with a soft cloth, going with the grain, to avoid spotting or streaking.

Wood products should be waxed periodically using a non-wax liquid; please do not use any waxy polish or cleaner. Interior of drawers may also be cleaned with mild soap and water mixture, or any household cleaner that is not petroleum or thinner-based.

Chassis & pedestal

All pedestals and chassis are constructed with 3/4" thick balanced 3-ply panels. Panels are securely fastened together using rails that are bored and doweled, glued, metal reinforcement brackets and wood cleat construction. Thick end panels are pre-bored to accept a tee nut for the adjustable glide and are reinforced with pvc banding to prevent glide tear out. Glue blocks are used where 3/4" thick panels are joined, bored for tee nut to accept adjustable glide.

Overhead cabinet construction Freestanding & wall mount

Freestanding Overhead storage cabinets are constructed of 1" and 3/4" thick core of particle board or MDF rated EPP/SCS/CARB-II material with 3-ply balanced construction. Panels are attached with cam fasteners in conjunction with dowels securely adhered with glue. All surface mount cabinets connect to work surface with anti-slip tape. Wall mount cabinets are mounted to the wall with steel "z" bracket attachment method using 5mm euro screws to attach to the back of the cabinet. All units ship with a steel "z" bracket. This bracket is mounted to the wall by field installers. Installers are responsible for selecting and supplying appropriate fasteners for wall conditions.

Bookcase Construction

All chassis (sides, back, top and bottom panels) are constructed with 3/4" thick core of particle board or MDF rated EPP/SCS/CARB-II material with 3-ply balanced construction. Panels are attached with cam-lock fasteners in conjunction with dowels securely adhered with glue. Shelves on all units are 3/4" thick balance 3 ply panels. Optional heavy duty shelves are 1" thick

lumber core balanced 5 ply construction.

Tackboards

Wall mount tackboards are constructed of .75" thick fiberboard. The fabric is precisely aligned and fitted to the tackboard with a sock on cover. Overhead storage tackboards are constructed of .75" thick fiberboard. The fabric is precisely aligned and fitted to the tackboard and adhered to the rigid hardboard with staples. Wall mount cabinets are mounted to the wall with steel "z" bracket attachment method using 5mm euro screws to attach to the back of the cabinet. All units ship with a steel "z" bracket. This bracket is mounted to the wall by field installers. Installers are responsible for selecting and supplying appropriate fasteners for wall conditions.

Adjustable glides

Glides provide 1" of vertical leveling adjustment. Glide bottom is durable metal. Glides are secured in solid wood blocks that are screwed and glued for durability.

Drawers

All drawers are constructed of four sides and a bottom, which are attached to a drawer front with screws for easy removal. Drawer fronts are vertically matched in balanced sets. Pencil trays are standard in all box drawers. Drawers are constructed of maple veneer 1/2" thick material for drawer sides, fronts and backs with a UV finish for maximum durability. Drawer bottoms are 3/16" thick 3-ply maple veneer. Drawer boxes are assembled at each corner with dowel joinery for maximum drawer strength. Lifetime free replacement warranty.

Drawer fronts

Drawer fronts are vertically matched in balanced sets. Doors feature vertical veneer bookmatched horizontally in sets of 2 / 4 and 6 doors. All drawers and doors have traditional scallop profile edge shape. All tower fronts matched in vertical sets.

Standard wood drawers

Optional hardwood veneer plywood drawers feature banded top and bottom edges for smoothness. Drawers are dowel joint construction with a UV cured finish over maple veneers, plus a lifetime free replacement guarantee.

Suspensions

All casegoods utilize cold rolled steel zinc plated high-grade drawer suspensions. Box and File drawers are full extension, featuring steel ball bearings for a smoother quieter range of motion with soft close operation and are rated 100lbs. Lateral file drawers are a progressive action full extension suspension with the soft close operation and is rated at 150lbs. Lateral files include anti tip mechanism that will allow only one drawer at a time to be opened. All suspensions are soft close and are warranted for the lifetime of the product.

Hinges

Units with doors include 95 degree swing hinges.

Filing

Rift features metal file frames around the perimeter of the drawers with cross bars secured to the drawer sides to support hanging files. A metal adjustable cross bar is standard with all file drawers to support letter/legal filing front to back or side to side. File drawers have one adjustable cross bar and lateral files have two adjustable cross bars. See filing reference for details.

Locks

Locks are Standard on all drawers below the worksurface. Random lock cores are installed at the factory. Some units may be shipped with the same key number. Locks are Silver, Black or Bronze and match pull finish unless otherwise specified.

DARRAN will also send lock cores separately to the dealer at your request. These units will be send with an empty lock core and the Dealer will receive a shipment of the requested lock core/keys.

Keying

Keying is available either factory or field installed. Factory installed keying is random.

Wire management

Wire management capabilities include standard and optional worksurface grommets. Specify W-1 under surface wire channels for organization and management of all communication wires and cords. Horizontal J-Channel wire management (Sku: W-1) is sold separately to conceal wire under worksurfaces.

Grommets

Metal grommets are provided to match the drawer pull selection. Grommet is available in black, silver or white. Must specify standard or non-standard location. Black plastic grommets are available as an option for vertical applications.

Powerports

A large selection of power pods are available and handle power, data, docking stations and communication. See options section for selection.

LED tasklights

LED task lighting provides high efficiency, low energy lighting with a long life. Surface mounted light is encased in silver aluminum channel with milk lense and rounded end caps. Lights are field installed. Product specifications listed below:

- Diffuser creates a softer light and eliminates hot spots
- Touch dimmer switch
- Can be “daisy chained” up to 90W
- 4.6 watts per foot
- 120 LEDs per meter
- Certification: UL Listed
- 50,000 hour life span.

Color Temp is 4000K

STANDARD VENEER	PREMIUM VENEER	HIGH PRESSURE LAMINATE	THERMALLY FUSED LAMINATE
N/A	TBCO Baby's Cheek	N/A	N/A
N/A	TBSW Brown Sugar	N/A	N/A
N/A	TOBW Organic Brown	N/A	N/A
N/A	TSTV Studio Teak Walnut	N/A	N/A
N/A	TSMV Seattle Mist	N/A	N/A
N/A	TSLV Skyline Walnut	N/A	N/A
N/A	WWP Designer White Paint	N/A	N/A

HPL TOPS ON TFL PRODUCTS Add 10% - Available with flat edge only
 Send 3x3 or larger finish chip for color match. Custom finish upcharge is 3% or \$250 Net (whichever is greater).



Finish

Welltech Finish delivers a superior furniture coating with exceptional performance that can withstand stringent cleaning agents and possesses unparalleled durability, allowing DARRAN to provide lasting, sustainable products to our customers.

Standard profile

Flat Edge
Hardwood Rim Band Species Same As Surface Veneer

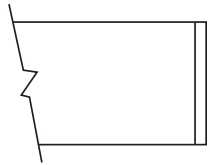

3mm solid
hardwood band

Rift profile

Rift Profile - Only Available on Table Desk where option is shown
Hardwood Rim Band Species Same As Surface Veneer

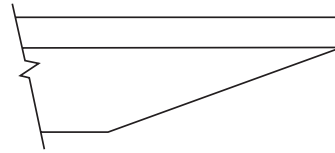

Bases

Column Bases

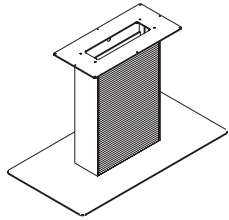

Available as sit/stand lift version on specific units

6" steel end panels

Removeable wood panel inserts both sides

Steel platform base with floor compression stabilizer

Post Leg

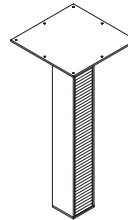

Steel H column
4" x 4"

Wood panel
insert two sides

Floor levelers

Cabinet Leg

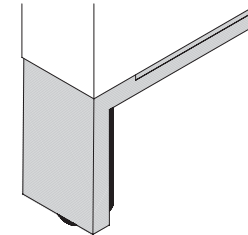

3"H x 1-1/2"W

Cast metal leg

Legs available
on credenzas,
benches and towers

Pulls/knobs

Factory Installed

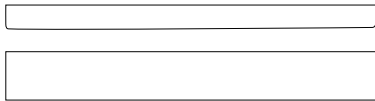

PL-300 Matte Chrome
PL-301 Matte Chrome
PL-302 White
PL-303 White

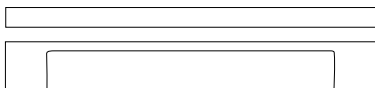

PL-304 Matte Chrome
PL-305 Matte Chrome
PL-306 White
PL-307 White



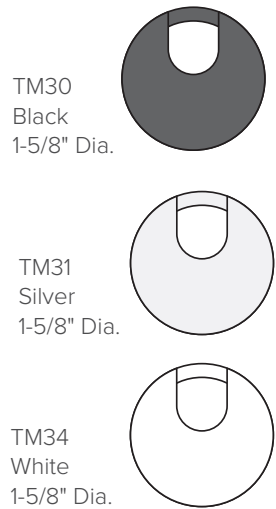

TM30
Black
1-5/8" Dia.

TM31
Silver
1-5/8" Dia.

TM34
White
1-5/8" Dia.

Optional grommets

Factory Installed

Grommets (Standard Location)

Specify Color and Left/Right/Center - \$50 ea.

- Black: TM30-R (Right), TM30-L (Left), TM30-C (Center)

- Silver: TM31-R (Right), TM31-L (Left), TM31-C (Center)

- White: TM34-R (Right), TM34-L (Left), TM34-C (Center)

(Center)

Grommets (Non-Standard Location)

Provide drawing w/ Grommet Location and Specify

Color - \$95 ea.

- Black: TM30-NS

- Silver: TM31-NS

- White: TM34-NS

TM50
Black
1-5/8" Dia.

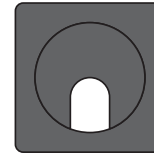

Grommets (vertical surface)

Standard Location - \$50 ea.

- Black Plastic Vertical Surface: TM50-C (Bottom Center)

Non-Standard Location - \$95 ea.

- Black Plastic Vertical Surface: TM50-NS



W1

Horizontal J-channel

Horizontal J-Channel wire management (Sku: W-1) is sold separately to conceal wire under worksurfaces.

Standard grommet location reference

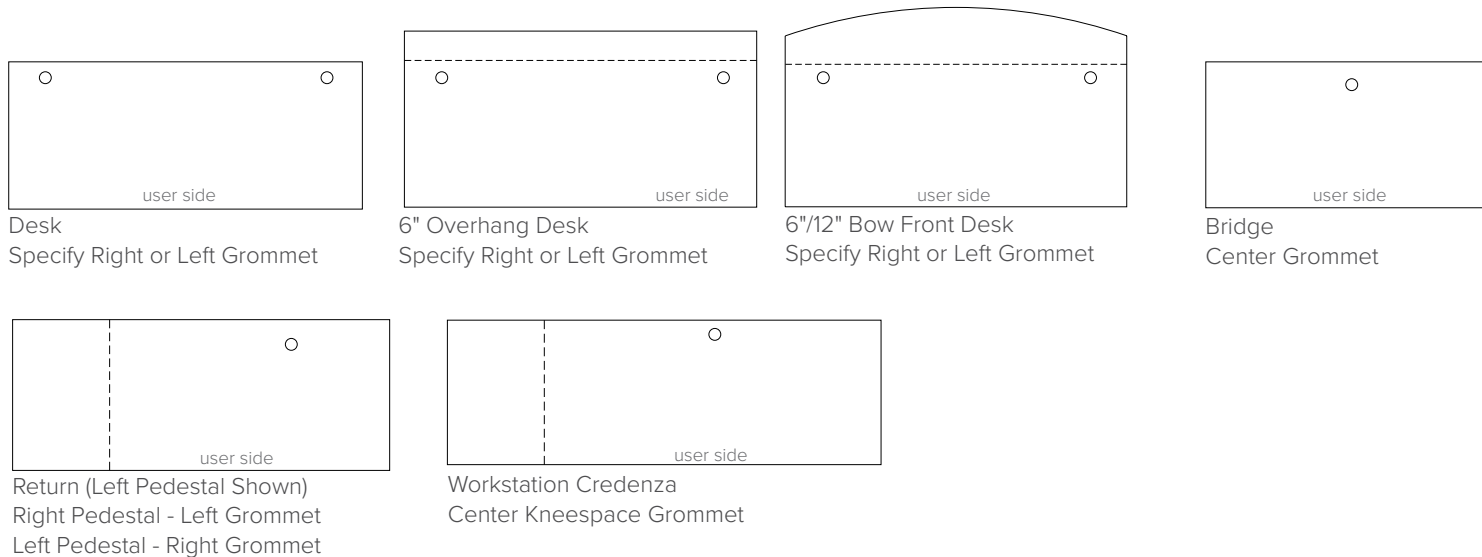

Desk
Specify Right or Left Grommet

6" Overhang Desk
Specify Right or Left Grommet

6"/12" Bow Front Desk
Specify Right or Left Grommet

Bridge
Center Grommet

Return (Left Pedestal Shown)
Right Pedestal - Left Grommet
Left Pedestal - Right Grommet

Workstation Credenza
Center Kneespace Grommet

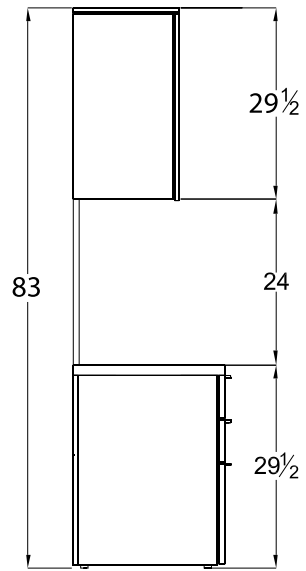

Typical Double Height Side Profile Wall Hung Overhead

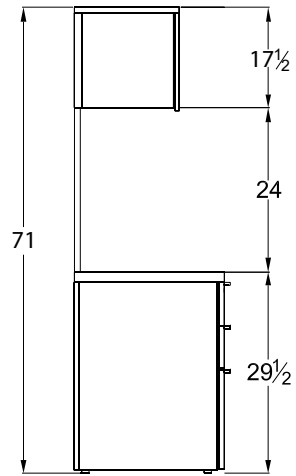

Typical Single Height Side Profile Wall Hung Overhead

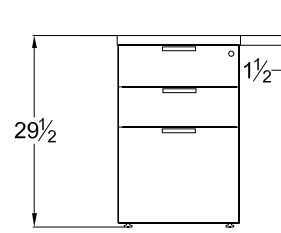

Pedestal Front Profile Box/Box/File

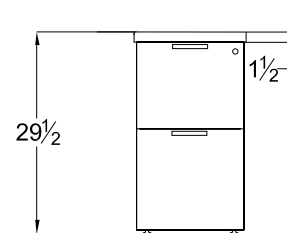

Pedestal Front Profile File/File

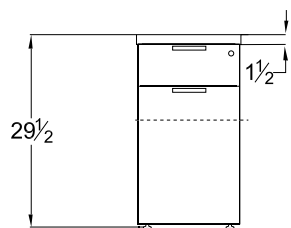

Pedestal Front Profile File/File

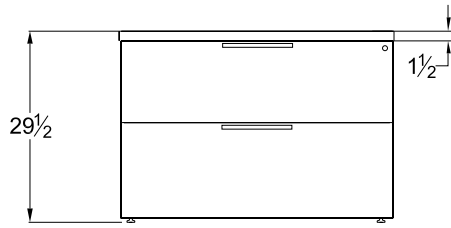

Pedestal Front Profile Lateral File

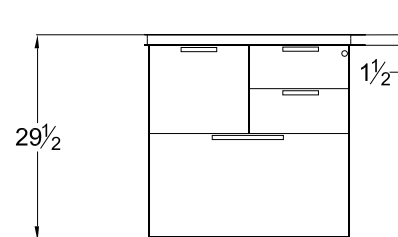

Pedestal Front Profile Multi-File

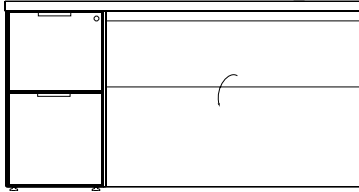

M34
Drop Door Tech Modesty

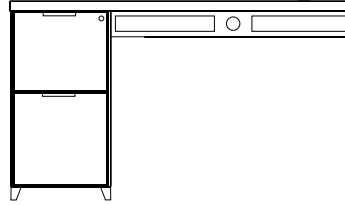
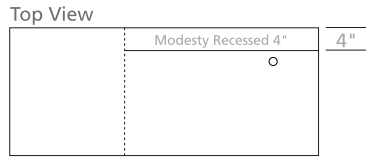

M51
Open Back Modesty with 4" Wire Management Rail

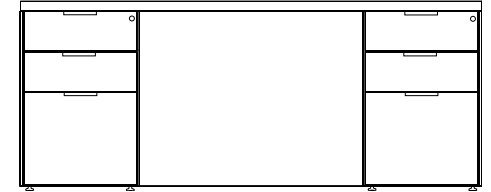

M37
Fixed Full Modesty

Grain direction

Veneer chassis and doors parts are horizontal grain. Doors feature horizontal veneer in sets of 2,4, and 6 doors. Tower fronts are matched in horizontal sets.



Desk

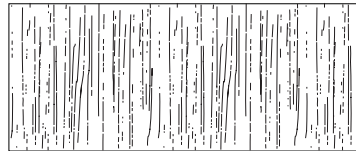

Runoff Desk

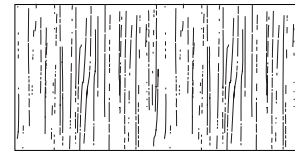

Bridge



Credenza

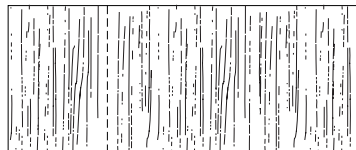

Return

Interior drawer dimensions

UNIT DEPTH	DRAWER	OVERALL DIM			INTERIOR DIM			NOTES
		W	D	H	W	D	H	
10" W	30" Box	7-1/2	19-11/16	4	6-1/2	18-11/16	3-7/16	60" x 30" Workstation Desk
	30" File	7-1/2	19-11/16	9-13/16	6-1/2	18-11/16	9-5/16	60" x 30" Workstation Desk
15-5/8" Letter	30" Box	13-1/8	19-11/16	4	12-1/8	18-11/16	3-7/16	Units less than 72"
	30" File	13-1/8	19-11/16	9-13/16	12-1/8	18-11/16	9-5/16	Units less than 72"
	22" Box	13-1/8	16-1/16	4	12-1/8	15-1/16	3-7/16	Units less than 72"
	22" File	13-1/8	16-1/16	9-13/16	12-1/8	15-1/16	9-5/16	Units less than 72"
18-9/16" Legal	36" Box	16-1/6	19-11/16	4	12-1/8	18-11/16	3-7/16	Units 72" & above
	36" File	16-1/6	19-11/16	9-13/16	12-1/8	18-11/16	9-5/16	Units 72" & above
	30" Box	16-1/6	19-11/16	4	12-1/8	18-11/16	3-7/16	Units 72" & above
	30" File	16-1/6	19-11/16	9-13/16	12-1/8	18-11/16	9-5/16	Units 72" & above
	22" Box	16-1/6	16-1/16	4	12-1/8	15-1/16	3-7/16	Units less than 72"
	22" File	16-1/6	16-1/16	9-13/16	12-1/8	15-1/16	9-5/16	Units less than 72"
30" Lateral	22" Box	27-1/2	16-1/16	4	25-1/2	15-1/16	9-5/16	Workstation Credenzas less than 82"
	22" File	26-1/2	16-1/16	9-13/16	25-1/2	15-1/16	9-5/16	Workstation Credenzas less than 82"
36" Lateral	22" Box	33-1/2	16-1/16	4	32-1/2	15-1/16	3-7/16	Workstation Credenzas over 83"
	22" File	33-1/2	16-1/16	9-13/16	32-1/2	15-1/16	9-5/16	Workstation Credenzas over 83"
42" Lateral	22" Box	39-1/2	16-1/16	9-13/16	38-1/2	15-1/16	9-5/16	

Filing for 24" depth units

13" Wide File Drawer - 16" Deep

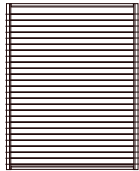

Letter Front to Back

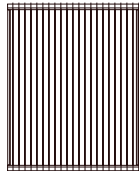

Legal Side to Side with File Rail

29" Lateral file drawer

26-1/2" Wide File Drawer - 16-1/16" Deep

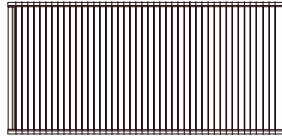

Legal Side to Side

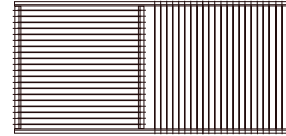

Legal Side to Side Letter Front to Back with File Rail



Letter Front to Back with File Rail

FILING FOR 30" & 36" DEPTH UNITS

13" Wide File Drawer - 20" Deep

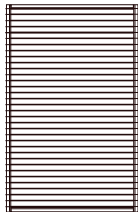

Letter Front to Back



Legal Side to Side with File Rail

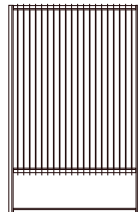

Letter Side to Side with File Rail

35" LATERAL FILE DRAWER

32-1/2" Wide File Drawer - 16-1/16" Deep

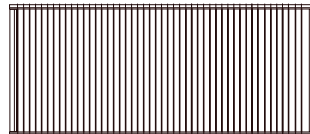

Legal Side to Side

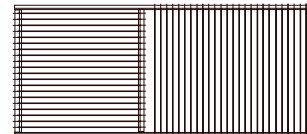

Legal Side to Side Letter Front to Back with File Rail



Letter Front to Back with File Rail

Rift
 Double Pedestal Desks
 Breakfront Chassis

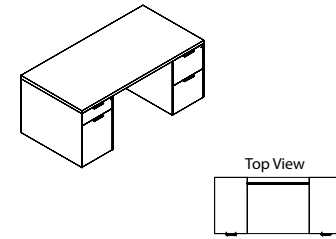

[Click here to view statement of line](#)

1 Select Model

w" x d" x h"	Weight	Options
Legal Width Double Letter Filing		
84 x 36 x 29.5	360	"W" Option N/A
72 x 36 x 29.5	325	"W" Option N/A
Letter Width Legal / Letter Filing		
66 x 30 x 29.5	295	"W" Option N/A
60 x 30 x 29.5	275	"W" Option N/A

Standard Veneer Top Standard Veneer Chassis	Premium Veneer Top Premium Veneer Chassis	High Pressure Laminate Top Veneer Chassis	Thermally Fused Laminate Top Thermally Fused Laminate Chassis
	RFT8436DD000P 5761 RFT7236DD000P 5373 RFT6630DD000P 5046 RFT6030DD000P 4864	"G" Option N/A "G" Option N/A "G" Option N/A "G" Option N/A	"M" Option N/A "M" Option N/A "M" Option N/A "M" Option N/A
	TBCO TBSW TSTV TSMV TSLV TOBW		
	Edge N/A		

Product Features

- 1-5/16" Thick work surface
- Box/Hidden Box/File pedestal and File/File pedestal
- Locking drawers
- Fronts and approach panels are recessed leaving 3/8" "thin" profile
- Soft close suspension drawer(s)
- Solid lumber core banded end panels

Notes

- 6" Recessed Modesty

Options

Accessories

- K1R: Center Drawer - \$290
- K28: Articulating Keyboard w/ Mouse - \$390

Flush Front Chassis

- MODCX: Breakfront chassis converted to flush front chassis - n/c

Grommet (Standard Location)

Specify Color and Location Right/Left - \$50 ea.

- Black: TM30-R (Right), TM30-L (Left)
- Silver: TM31-R (Right), TM31-L (Left)
- White: TM34-R (Right), TM34-L (Left)

Grommets (Non-Standard Location)

Provide drawing w/ Grommet Location and Specify Color - \$95 ea.

- TM30-NS: Black Specify Location
- TM31-NS: Silver Specify Location
- TM34-NS: White Specify Location

2 Select Finish

[Click to view finishes](#)

3 Select Edge

[Click to view edges](#)

4 Select Hardware

[Click to view details](#)

Rift



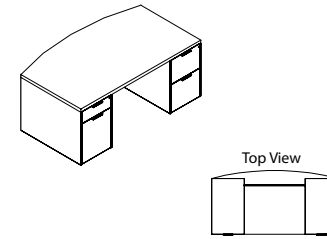

Double Pedestal Desks
Bowfront Top Breakfront Chassis

[Click here to view statement of line](#)



1 Select Model

w" x d" x h"	Weight
Legal Width Double Letter Filing	
84 x 30/36 x 29.5	360
72 x 30/36 x 29.5	330
66 x 30/36 x 29.5	325
60 x 30/36 x 29.5	275

Standard Veneer Top Standard Veneer Chassis	Premium Veneer Top Premium Veneer Chassis	High Pressure Laminate Top Veneer Chassis	Thermally Fused Laminate Top Thermally Fused Laminate Chassis
"W" Option N/A	RFT8436DD006P 6210	"G" Option N/A	"M" Option N/A
"W" Option N/A	RFT7236DD006P 6091	"G" Option N/A	"M" Option N/A
"W" Option N/A	RFT6636DD006P 5811	"G" Option N/A	"M" Option N/A
"W" Option N/A	RFT6036DD006P 5661	"G" Option N/A	"M" Option N/A
TBCO TBSW TSTV TSMV TSLV TOBW			
Edge N/A			
 <small>2023-01-01</small> FL-300 Matte Chrome <small>2023-01-01</small> FL-301 Matte Chrome	 <small>2023-01-01</small> PL-302 White <small>2023-01-01</small> PL-303 White		
 <small>2023-01-01</small> FL-304 Matte Chrome <small>2023-01-01</small> FL-305 Matte Chrome	 <small>2023-01-01</small> PL-306 White <small>2023-01-01</small> PL-307 White		

2 Select Finish

[Click to view finishes](#)

3 Select Edge

[Click to view edges](#)

4 Select Hardware

[Click to view details](#)

Product Features

- 1-5/16" Thick work surface
- Box/Hidden Box/File pedestal and File/File pedestal
- Locking drawers
- Fronts and approach panels are recessed leaving 3/8" "thin" profile
- Soft close suspension drawer(s)
- Solid lumber core banded end panels

Notes

- 12" Recessed Modesty

Options

Accessories

- K1R: Center Drawer - \$290
- K28: Articulating Keyboard w/ Mouse - \$390

Grommet (Standard Location)

Specify Color and Location Right/Left - \$50 ea.

- Black: TM30-R (Right), TM30-L (Left)
- Silver: TM31-R (Right), TM31-L (Left)
- White: TM34-R (Right), TM34-L (Left)

Grommets (Non-Standard Location)

Provide drawing w/ Grommet Location and Specify Color - \$95 ea.

- TM30-NS: Black Specify Location
- TM31-NS: Silver Specify Location
- TM34-NS: White Specify Location

Rift

Double Pedestal Desks
Overhang/Flush Chassis

[Click here to view statement of line](#)

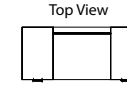
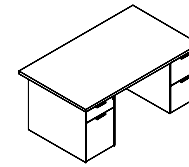

1 Select Model

w" x d" x h"	Weight
84 x 36 x 29.5	310
72 x 36 x 29.5	275
66 x 36 x 29.5	255
60 x 36 x 29.5	235

Standard Veneer Top Standard Veneer Chassis	Premium Veneer Top Premium Veneer Chassis	High Pressure Laminate Top Veneer Chassis	Thermally Fused Laminate Top Thermally Fused Laminate Chassis
"W" Option N/A "W" Option N/A "W" Option N/A "W" Option N/A	RFT8436DD032P 5530 RFT7236DD032P 5285 RFT6636DD032P 5000 RFT6036DD032P 4847	"G" Option N/A "G" Option N/A "G" Option N/A "G" Option N/A	"M" Option N/A "M" Option N/A "M" Option N/A "M" Option N/A
TBCO TBSW TSTV TSMV TSLV TOBW			
Edge N/A			

Product Features

- 1-5/16" Thick work surface
- Box/Hidden Box/File pedestals
- Locking drawers
- Fronts and approach panels are recessed leaving 3/8" "thin" profile
- Soft close suspension drawer(s)
- Solid lumber core banded end panels

Notes

- 6" Overhang

Options

Accessories

- K1R: Center Drawer - \$290
- K28: Articulating Keyboard w/ Mouse - \$390

Flush Front Chassis

- MODCX: Breakfront chassis converted to flush front chassis - n/c

Grommet (Standard Location)

Specify Color and Location Right/Left - \$50 ea.

- Black: TM30-R (Right), TM30-L (Left)
- Silver: TM31-R (Right), TM31-L (Left)
- White: TM34-R (Right), TM34-L (Left)

Grommets (Non-Standard Location)

Provide drawing w/ Grommet Location and Specify Color - \$95 ea.

- TM30-NS: Black Specify Location
- TM31-NS: Silver Specify Location
- TM34-NS: White Specify Location

2 Select Finish

[Click to view finishes](#)

3 Select Edge

[Click to view edges](#)

4 Select Hardware

[Click to view details](#)

Rift

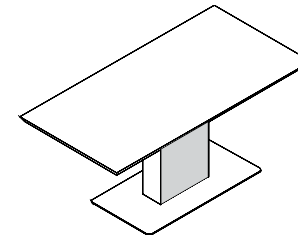

Conference Table Desk
 Rectangle Table Desk With Column Base



[Click here to view statement of line](#)

1 Select Model

w" x d" x h"	Weight
72 x 36 x 29.5	210
66 x 36 x 29.5	200
54 x 30 x 29.5	190

Standard Veneer Top Standard Veneer Chassis	Premium Veneer Top Premium Veneer Chassis	High Pressure Laminate Top Veneer Chassis	Thermally Fused Laminate Top Thermally Fused Laminate Chassis
"W" Option N/A	RFT7236DT090P 5365	"G" Option N/A	"M" Option N/A
"W" Option N/A	RFT6636DT090P 5114	"G" Option N/A	"M" Option N/A
"W" Option N/A	RFT5430DT090P 4840	"G" Option N/A	"M" Option N/A
<p>TBCO TBSW TSTV TSMV TSLV TOBW</p> <p>  Flat  Rift </p> <p>Hardware N/A</p>			

2 Select Finish

[Click to view finishes](#)

3 Select Edge

[Click to view edges](#)

4 Select Hardware

[Click to view details](#)

Product Features

- 1-5/16" Thick work surface
- Beveled Rift edge standard, Flat edge is optional
- Steel column with accent wood panel insert offset for increased kneespace area
- Steel platform with self-leveling cushion bottom

Notes

- Optional height adjustment
- Power cord is 10'

Options

Height Adjustable Lift

- LFT00: Electric Operate Sit/Stand Lift Height Adjustable Lift (Adjusts from 29"-49") - \$2105

Grommet (Standard Location)

Specify Color and Location Right/Left - \$50 ea.

- Black: TM30-R (Right), TM30-L (Left)
- Silver: TM31-R (Right), TM31-L (Left)
- White: TM34-R (Right), TM34-L (Left)

Rift

Conference Table Square Conference Table With Column

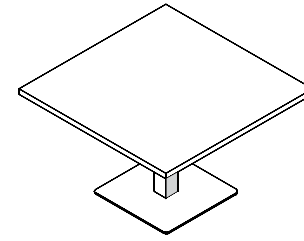

[Click here to view statement of line](#)

1 Select Model

w" x d" x h"	Weight
48 x 48 x 29.5	160
42 x 42 x 29.5	150
36 x 36 x 29.5	140
30 x 30 x 29.5	135

Standard Veneer Top Standard Veneer Chassis	Premium Veneer Top Premium Veneer Chassis	High Pressure Laminate Top Veneer Chassis	Thermally Fused Laminate Top Thermally Fused Laminate Chassis
"W" Option N/A	RFT4848DT088P 3411	"G" Option N/A	"M" Option N/A
"W" Option N/A	RFT4242DT088P 3282	"G" Option N/A	"M" Option N/A
"W" Option N/A	RFT3636DT088P 3179	"G" Option N/A	"M" Option N/A
"W" Option N/A	RFT3030DT088P 3043	"G" Option N/A	"M" Option N/A
<p>TBCO TBSW TSTV TSMV TSLV TOBW</p>			
<p>Flat</p>			
<p>Hardware N/A</p>			

Product Features

- 1-5/16" Thick work surface
- 4" x 4" Steel column with accent wood panel insert centered under top
- Flat edge standard
- Steel platform with self-leveling cushion bottom

2 Select Finish

[Click to view finishes](#)

3 Select Edge

[Click to view edges](#)

4 Select Hardware

[Click to view details](#)

Rift

Conference Table Round Conference Table With Column

[Click here to view statement of line](#)

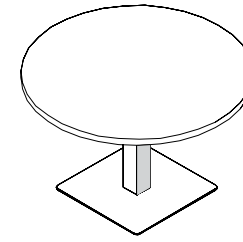

1 Select Model

w" x d" x h"	Weight
48 DIA x 29.5	160
42 DIA x 29.5	150
36 DIA x 29.5	140
30 DIA x 29.5	135

Standard Veneer Top Standard Veneer Chassis	Premium Veneer Top Premium Veneer Chassis	High Pressure Laminate Top Veneer Chassis	Thermally Fused Laminate Top Thermally Fused Laminate Chassis
"W" Option N/A	RFT4848DT089P 3411	"G" Option N/A	"M" Option N/A
"W" Option N/A	RFT4242DT089P 3282	"G" Option N/A	"M" Option N/A
"W" Option N/A	RFT3636DT089P 3179	"G" Option N/A	"M" Option N/A
"W" Option N/A	RFT3030DT089P 3043	"G" Option N/A	"M" Option N/A
<p>TBCO TBSW TSTV TSMV TSLV TOBW</p>			
<p>Flat</p>			
<p>Hardware N/A</p>			

Product Features

- 1-5/16" Thick work surface
- 4" x 4" Steel column with accent wood panel insert centered under top
- Flat edge standard
- Steel platform with self-leveling cushion bottom

2 Select Finish

[Click to view finishes](#)

3 Select Edge

[Click to view edges](#)

4 Select Hardware

[Click to view details](#)

Rift

Table Desks
Metal Sleigh

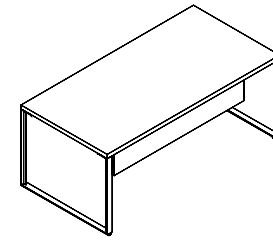

[Click here to view statement of line](#)

1 Select Model

w" x d" x h"	Weight
72 x 36 x 29.5	145
66 x 30 x 29.5	135
60 x 30 x 29.5	125

Standard Veneer Top Standard Veneer Chassis	Premium Veneer Top Premium Veneer Chassis	High Pressure Laminate Top Veneer Chassis	Thermally Fused Laminate Top Thermally Fused Laminate Chassis
"W" Option N/A	RFT7236DT092P 5152	"G" Option N/A	"M" Option N/A
"W" Option N/A	RFT6630DT092P 4932	"G" Option N/A	"M" Option N/A
"W" Option N/A	RFT6030DT092P 4886	"G" Option N/A	"M" Option N/A
<p>2 Select Finish Click to view finishes</p> <p>TBCO TBSW TSTV TSMV TSLV TOBW</p> <p> Flat</p> <p>3 Select Edge Click to view edges</p> <p>4 Select Hardware Click to view details</p> <p>Hardware N/A</p>			

Product Features

- 1-5/16" Thick work surface
- Floating 1/2 height modesty panel. Recessed 6"
- Steel silver sleigh bases

Notes

- Wood insert end panels available for additional privacy

Options

Accessories

- K1R: Center Drawer - \$290
- K28: Articulating Keyboard w/ Mouse - \$390

Grommet (Standard Location)

- Specify Color and Location Right/Left - \$50 ea.
- Black: TM30-R (Right), TM30-L (Left)
 - Silver: TM31-R (Right), TM31-L (Left)
 - White: TM34-R (Right), TM34-L (Left)

Grommets (Non-Standard Location)

Provide drawing w/ Grommet Location and Specify Color - \$95 ea.

- TM30-NS: Black Specify Location
- TM31-NS: Silver Specify Location
- TM34-NS: White Specify Location

Modesty

- DM: Delete Modesty - n/c

Premium Finish Option

- MFW: White Metal Finish - \$160 per base

Wood Insert Panel

- PWIF: Wood Finish Panel - \$340 each
- PWIW: White Paint Panel - \$415 each

Rift

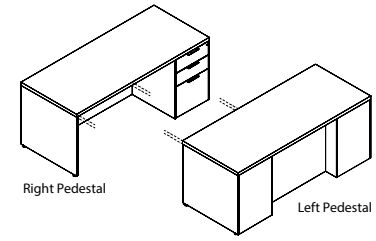

Workstation Desks Rectangle Top Breakfront Chassis

[Click here to view statement of line](#)

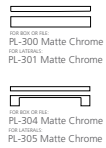

1 Select Model

w" x d" x h"	Weight
Left Pedestal	
84 x 36 x 29.5	320
72 x 36 x 29.5	290
72 x 30 x 29.5	265
66 x 30 x 29.5	240
Right Pedestal	
84 x 36 x 29.5	320
72 x 36 x 29.5	290
72 x 30 x 29.5	265
66 x 30 x 29.5	240

Standard Veneer Top Standard Veneer Chassis	Premium Veneer Top Premium Veneer Chassis	High Pressure Laminate Top Veneer Chassis	Thermally Fused Laminate Top Thermally Fused Laminate Chassis
"W" Option N/A	RFT8436DS009P 5279	"G" Option N/A	"M" Option N/A
"W" Option N/A	RFT7236DS009P 4830	"G" Option N/A	"M" Option N/A
"W" Option N/A	RFT7230DS009P 4661	"G" Option N/A	"M" Option N/A
"W" Option N/A	RFT6630DS009P 4490	"G" Option N/A	"M" Option N/A
"W" Option N/A	RFT8436DS010P 5279	"G" Option N/A	"M" Option N/A
"W" Option N/A	RFT7236DS010P 4830	"G" Option N/A	"M" Option N/A
"W" Option N/A	RFT7230DS010P 4661	"G" Option N/A	"M" Option N/A
"W" Option N/A	RFT6630DS010P 4490	"G" Option N/A	"M" Option N/A
TBCO TBSW TSTV TSMV TSLV TOBW			
Edge N/A			
			
			

Product Features

- 1-5/16" Thick work surface
- Box/box/file drawers standard
- Fronts and approach panels are recessed leaving 3/8" "thin" profile
- Soft close suspension drawer(s)
- Solid lumber core banded end panels

Notes

- 6" recessed modesty
- Metal legs not available on Workstation Desks

Options

Accessories

- K1R: Center Drawer - \$290
- K28: Articulating Keyboard w/ Mouse - \$390

Drawer

- P6: Modify Box/Box/File to File/File - \$55 per pedestal
- WPD3061: Designer White - \$80 per pedestal

Flush Front Chassis

- MODCX: Breakfront chassis converted to flush front chassis - n/c

Grommet (Standard Location)

Specify Color and Location Right/Left - \$50 ea.

- Black: TM30-R (Right), TM30-L (Left)
- Silver: TM31-R (Right), TM31-L (Left)
- White: TM34-R (Right), TM34-L (Left)

Grommets (Non-Standard Location)

Provide drawing w/ Grommet Location and Specify Color - \$95 ea.

- TM30-NS: Black Specify Location
- TM31-NS: Silver Specify Location
- TM34-NS: White Specify Location

2 Select Finish

[Click to view finishes](#)

3 Select Edge

[Click to view edges](#)

4 Select Hardware

[Click to view details](#)

Rift

Workstation Desks Rectangle Overhang Top Flush Chassis

[Click here to view statement of line](#)

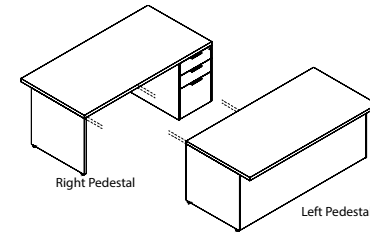

1 Select Model

w" x d" x h"	Weight
Left Pedestal	
84 x 36 x 29.5	340
72 x 36 x 29.5	310
66 x 36 x 29.5	270
Right Pedestal	
84 x 36 x 29.5	340
72 x 36 x 29.5	310
66 x 36 x 29.5	270

Standard Veneer Top Standard Veneer Chassis	Premium Veneer Top Premium Veneer Chassis	High Pressure Laminate Top Veneer Chassis	Thermally Fused Laminate Top Thermally Fused Laminate Chassis
"W" Option N/A	RFT8436DS640P 4919	"G" Option N/A	"M" Option N/A
"W" Option N/A	RFT7236DS640P 4759	"G" Option N/A	"M" Option N/A
"W" Option N/A	RFT6636DS640P 4469	"G" Option N/A	"M" Option N/A
"W" Option N/A	RFT8436DS639P 4919	"G" Option N/A	"M" Option N/A
"W" Option N/A	RFT7236DS639P 4759	"G" Option N/A	"M" Option N/A
"W" Option N/A	RFT6636DS639P 4469	"G" Option N/A	"M" Option N/A
	TBCO TBSW TSTV TSMV TSLV TOBW		
	Edge N/A		
	 PL-300 Matte Chrome PL-301 Matte Chrome PL-304 Matte Chrome PL-305 Matte Chrome	 PL-302 White PL-303 White PL-306 White PL-307 White	

2 Select Finish

[Click to view finishes](#)

3 Select Edge

[Click to view edges](#)

4 Select Hardware

[Click to view details](#)

Product Features

- 1-5/16" Thick work surface
- Box/box/file drawers standard
- Flush front modesty
- Fronts and approach panels are recessed leaving 3/8" "thin" profile
- Soft close suspension drawer(s)
- Solid lumber core banded end panels

Notes

- 6" overhang
- Metal legs not available on Workstation Desks

Options

Accessories

- K1R: Center Drawer - \$290
- K28: Articulating Keyboard w/ Mouse - \$390

Drawer

- P6: Modify Box/Box/File to File/File - \$55 per pedestal
- WPD3061: Designer White - \$80 per pedestal

Grommet (Standard Location)

Specify Color and Location Right/Left - \$50 ea.

- Black: TM30-R (Right), TM30-L (Left)
- Silver: TM31-R (Right), TM31-L (Left)
- White: TM34-R (Right), TM34-L (Left)

Grommets (Non-Standard Location)

Provide drawing w/ Grommet Location and Specify Color - \$95 ea.

- TM30-NS: Black Specify Location
- TM31-NS: Silver Specify Location
- TM34-NS: White Specify Location

Rift

Workstation Conference Desks Rectangle

[Click here to view statement of line](#)

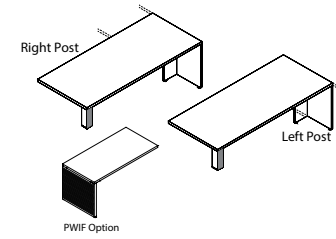

1 Select Model

w" x d" x h"	Weight
Left Post	
84 x 36 x 29.5	175
72 x 36 x 29.5	160
72 x 30 x 29.5	150
66 x 30 x 29.5	125
60 x 30 x 29.5	110
Right Post	
84 x 36 x 29.5	175
72 x 36 x 29.5	160
72 x 30 x 29.5	150
66 x 30 x 29.5	125
60 x 30 x 29.5	110

Standard Veneer Top Standard Veneer Chassis	Premium Veneer Top Premium Veneer Chassis	High Pressure Laminate Top Veneer Chassis	Thermally Fused Laminate Top Thermally Fused Laminate Chassis
"W" Option N/A	RFT8436DC767P 4246	"G" Option N/A	"M" Option N/A
"W" Option N/A	RFT7236DC767P 3923	"G" Option N/A	"M" Option N/A
"W" Option N/A	RFT7230DC767P 3814	"G" Option N/A	"M" Option N/A
"W" Option N/A	RFT6630DC767P 3705	"G" Option N/A	"M" Option N/A
"W" Option N/A	RFT6030DC767P 3653	"G" Option N/A	"M" Option N/A
"W" Option N/A	RFT8436DC766P 4246	"G" Option N/A	"M" Option N/A
"W" Option N/A	RFT7236DC766P 3923	"G" Option N/A	"M" Option N/A
"W" Option N/A	RFT7230DC766P 3814	"G" Option N/A	"M" Option N/A
"W" Option N/A	RFT6630DC766P 3705	"G" Option N/A	"M" Option N/A
"W" Option N/A	RFT6030DC766P 3653	"G" Option N/A	"M" Option N/A
	TBCO TBSW TSTV TSMV TSLV TOBW		
	Edge N/A		
	Hardware N/A		

2 Select Finish

[Click to view finishes](#)

3 Select Edge

[Click to view edges](#)

4 Select Hardware

[Click to view details](#)

Product Features

- 1-5/16" Thick work surface
- 4" Silver square steel H post with finished wood insert detail

Options

Accessories

- K1R: Center Drawer - \$290
- K2R: Center Drawer w/ Skirt - \$390
- K28: Articulating Keyboard w/ Mouse - \$390

Grommet (Standard Location)

Specify Color - \$50 ea.

- Black: TM30-C (Center)
- Silver: TM31-C (Center)
- White: TM34-C (Center)

Grommets (Non-Standard Location)

Provide drawing w/ Grommet Location and Specify Color - \$95 ea.

- TM30-NS: Black Specify Location
- TM31-NS: Silver Specify Location
- TM34-NS: White Specify Location

Leg Options

- RSB23R: Metal Sleigh Base - \$205
- PWIF: Wood Finish Panel Insert for Sleigh Base - \$340

Modesty

- HMI: Veneer half modesty - \$205

Premium Finish Option

- MFW: White Metal Finish - \$160 per base

Rift

Workstation/Bench Runoff Conference Desks
 Rectangle Metal Sleigh Support

[Click here to view statement of line](#)

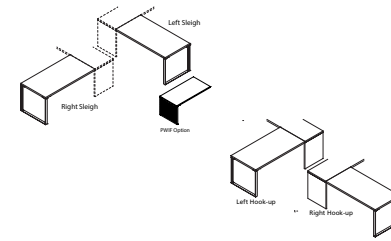

1 Select Model

w" x d" x h"	Weight
Left Sleigh	
84 x 36 x 29.5	205
84 x 30 x 29.5	195
78 x 36 x 29.5	185
78 x 30 x 29.5	175
72 x 30 x 29.5	165
66 x 30 x 29.5	155
60 x 30 x 29.5	145
Right Sleigh	
84 x 36 x 29.5	205
84 x 30 x 29.5	195
78 x 36 x 29.5	185
78 x 30 x 29.5	175
72 x 30 x 29.5	165
66 x 30 x 29.5	155
60 x 30 x 29.5	145

	Standard Veneer Top Standard Veneer Chassis	Premium Veneer Top Premium Veneer Chassis	High Pressure Laminate Top Veneer Chassis	Thermally Fused Laminate Top Thermally Fused Laminate Chassis
"W" Option N/A	RFT8436DR779P	5019	"G" Option N/A	"M" Option N/A
"W" Option N/A	RFT8430DR779P	4814	"G" Option N/A	"M" Option N/A
"W" Option N/A	RFT7836DR779P	4808	"G" Option N/A	"M" Option N/A
"W" Option N/A	RFT7830DR779P	4606	"G" Option N/A	"M" Option N/A
"W" Option N/A	RFT7230DR779P	4071	"G" Option N/A	"M" Option N/A
"W" Option N/A	RFT6630DR779P	3990	"G" Option N/A	"M" Option N/A
"W" Option N/A	RFT6030DR779P	3906	"G" Option N/A	"M" Option N/A
"W" Option N/A	RFT8436DR778P	5019	"G" Option N/A	"M" Option N/A
"W" Option N/A	RFT8430DR778P	4814	"G" Option N/A	"M" Option N/A
"W" Option N/A	RFT7836DR778P	4808	"G" Option N/A	"M" Option N/A
"W" Option N/A	RFT7830DR778P	4606	"G" Option N/A	"M" Option N/A
"W" Option N/A	RFT7230DR778P	4071	"G" Option N/A	"M" Option N/A
"W" Option N/A	RFT6630DR778P	3990	"G" Option N/A	"M" Option N/A
"W" Option N/A	RFT6030DR778P	3906	"G" Option N/A	"M" Option N/A
TBCO				
TBSW				
TSTV				
TSMV				
TSLV				
TOBV				
Edge N/A				
Hardware N/A				

2 Select Finish

[Click to view finishes](#)

3 Select Edge

[Click to view edges](#)

4 Select Hardware

[Click to view details](#)

Product Features

- 1-5/16" Thick work surface
- Silver steel sleigh leg standard

Notes

- Must order Bench Hook-up Support when runoff extends over bench credenza (CA062 or CA063)
- Must be hooked to freestanding unit

Options

Accessories

- K1R: Center Drawer - \$290
- K2R: Center Drawer w/ Skirt - \$390
- K28: Articulating Keyboard w/ Mouse - \$390

Bench Hook-up Support

- BRS30: Runoff desk support for 30" deep top - \$390
- BRS36: Runoff Desk Support for 36" deep top - \$390

Grommet (Standard Location)

Specify Color - \$50 ea.

- Black: TM30-C (Center)
- Silver: TM31-C (Center)
- White: TM34-C (Center)

Grommets (Non-Standard Location)

Provide drawing w/ Grommet Location and Specify Color - \$95 ea.

- TM30-NS: Black Specify Location
- TM31-NS: Silver Specify Location
- TM34-NS: White Specify Location

Modesty

- HM1: Veneer half modesty - \$205

Premium Finish Option

- MFW: White Metal Finish - \$160 per base

Sleigh Base Panel Insert

- PWIF: Wood Finish Panel - \$325
- PWIW: White Paint Panel - \$395

Rift

Workstation Runoff Conference Rectangle Post Support

[Click here to view statement of line](#)

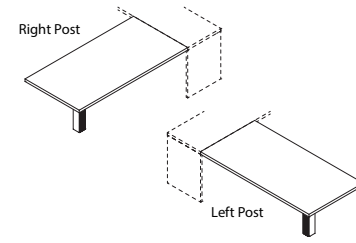

1 Select Model

w" x d" x h"	Weight
Left Post	
84 x 36 x 29.5	205
84 x 30 x 29.5	195
78 x 36 x 29.5	185
78 x 30 x 29.5	175
72 x 30 x 29.5	165
66 x 30 x 29.5	155
60 x 30 x 29.5	145
Right Post	
84 x 36 x 29.5	205
84 x 30 x 29.5	195
78 x 36 x 29.5	185
78 x 30 x 29.5	175
72 x 30 x 29.5	165
66 x 30 x 29.5	155
60 x 30 x 29.5	145

	Standard Veneer Top Standard Veneer Chassis	Premium Veneer Top Premium Veneer Chassis	High Pressure Laminate Top Veneer Chassis	Thermally Fused Laminate Top Thermally Fused Laminate Chassis
	"W" Option N/A	RFT8436DR771P 4247	"G" Option N/A	"M" Option N/A
	"W" Option N/A	RFT8430DR771P 4044	"G" Option N/A	"M" Option N/A
	"W" Option N/A	RFT7836DR771P 4037	"G" Option N/A	"M" Option N/A
	"W" Option N/A	RFT7830DR771P 3832	"G" Option N/A	"M" Option N/A
	"W" Option N/A	RFT7230DR771P 3753	"G" Option N/A	"M" Option N/A
	"W" Option N/A	RFT6630DR771P 3672	"G" Option N/A	"M" Option N/A
	"W" Option N/A	RFT6030DR771P 3590	"G" Option N/A	"M" Option N/A
	"W" Option N/A	RFT8436DR770P 4247	"G" Option N/A	"M" Option N/A
	"W" Option N/A	RFT8430DR770P 4044	"G" Option N/A	"M" Option N/A
	"W" Option N/A	RFT7836DR770P 4037	"G" Option N/A	"M" Option N/A
	"W" Option N/A	RFT7830DR770P 3832	"G" Option N/A	"M" Option N/A
	"W" Option N/A	RFT7230DR770P 3753	"G" Option N/A	"M" Option N/A
	"W" Option N/A	RFT6630DR770P 3672	"G" Option N/A	"M" Option N/A
	"W" Option N/A	RFT6030DR770P 3590	"G" Option N/A	"M" Option N/A
		TBCO		
		TBSW		
		TSTV		
		TSMV		
		TSLV		
		TOBW		
		Edge N/A		
		Hardware N/A		

2 Select Finish

[Click to view finishes](#)

3 Select Edge

[Click to view edges](#)

4 Select Hardware

[Click to view details](#)

Product Features

- 1-5/16" Thick work surface
- 4" Silver square steel H post with finished wood insert

Notes

- Must order Bench Hook-up Support when runoff extends over bench credenza (CA062 or CA063)
- Must be hooked to freestanding unit

Options

Accessories

- K2R: Center Drawer w/ Skirt - \$390
- K28: Articulating Keyboard w/ Mouse - \$390

Bench Hook-up Support

- BRS30: Runoff desk support for 30" deep top - \$390
- BRS36: Runoff Desk Support for 36" deep top - \$390

Grommet (Standard Location)

Specify Color - \$50 ea.

- Black: TM30-C (Center)
- Silver: TM31-C (Center)
- White: TM34-C (Center)

Grommets (Non-Standard Location)

Provide drawing w/ Grommet Location and Specify Color - \$95 ea.

- TM30-NS: Black Specify Location
- TM31-NS: Silver Specify Location
- TM34-NS: White Specify Location

Leg Options

- RSB23R: Metal Sleigh Base - \$205
- PWIF: Wood Finish Panel Insert for Sleigh Base - \$340
- PWIW: White Paint Panel Insert for Sleigh Base- \$415

Modesty

- HMT: Veneer half modesty - \$205

Premium Finish Option

- MFW: White Metal Finish - \$160 per base

Rift

Workstation/Bench Runoff Conference Desks
Rectangle Box/Box/File

[Click here to view statement of line](#)

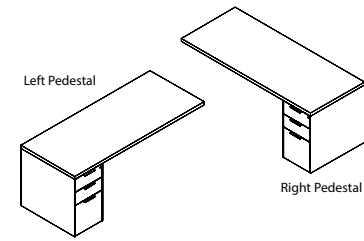

1 Select Model

w" x d" x h"	Weight
Left Pedestal	
84 x 30 x 29.5	220
78 x 30 x 29.5	190
72 x 30 x 29.5	160
66 x 30 x 29.5	150
Right Pedestal	
84 x 30 x 29.5	220
78 x 30 x 29.5	190
72 x 30 x 29.5	160
66 x 30 x 29.5	150

	Standard Veneer Top Standard Veneer Chassis	Premium Veneer Top Premium Veneer Chassis	High Pressure Laminate Top Veneer Chassis	Thermally Fused Laminate Top Thermally Fused Laminate Chassis
	"W" Option N/A	RFT8430DR791P 4744	"G" Option N/A	"M" Option N/A
	"W" Option N/A	RFT7830DR791P 4606	"G" Option N/A	"M" Option N/A
	"W" Option N/A	RFT7230DR791P 4071	"G" Option N/A	"M" Option N/A
	"W" Option N/A	RFT6630DR791P 3990	"G" Option N/A	"M" Option N/A
	"W" Option N/A	RFT8430DR790P 4744	"G" Option N/A	"M" Option N/A
	"W" Option N/A	RFT7830DR790P 4606	"G" Option N/A	"M" Option N/A
	"W" Option N/A	RFT7230DR790P 4071	"G" Option N/A	"M" Option N/A
	"W" Option N/A	RFT6630DR790P 3990	"G" Option N/A	"M" Option N/A
	TBCO			
	TBSW			
	TSTV			
	TSMV			
	TSLV			
	TOBW			
	Edge N/A			

Product Features

- 1-5/16" Thick work surface
- Box/box/file drawers
- File drawer accommodates legal or letter
- Locking drawers
- Soft close suspension drawer(s)

Notes

- Must order Bench Hook-up Support when runoff extends over bench credenza (CA062 or CA063)
- Must be hooked to freestanding unit

Options

Accessories

- K1R: Center Drawer - \$290
- K2R: Center Drawer w/ Skirt - \$390
- K28: Articulating Keyboard w/ Mouse - \$390

Bench Hook-up Support

- BRS30: Runoff desk support for 30" deep top - \$390

Drawer

- P6: Modify Box/Box/File to File/File - \$55 per pedestal
- WPD30G1: Designer White - \$80 per pedestal

Grommet (Standard Location)

Specify Color and Location Right/Left - \$50 ea.

- Black: TM30-R (Right), TM30-L (Left)
- Silver: TM31-R (Right), TM31-L (Left)
- White: TM34-R (Right), TM34-L (Left)

Grommets (Non-Standard Location)

Provide drawing w/ Grommet Location and Specify Color - \$95 ea.

- TM30-NS: Black Specify Location
- TM31-NS: Silver Specify Location
- TM34-NS: White Specify Location

Modesty

- HM1: Veneer half modesty - \$205

2 Select Finish

[Click to view finishes](#)

3 Select Edge

[Click to view edges](#)

4 Select Hardware

[Click to view details](#)

Rift

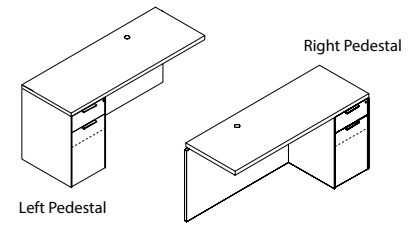

"L" Workstation Returns
Box/Hidden Box/File

[Click here to view statement of line](#)



1 Select Model

w" x d" x h"	Weight
60 x 22 x 29.5	190
54 x 22 x 29.5	180
48 x 22 x 29.5	170
42 x 22 x 29.5	160
60 x 22 x 29.5	190
54 x 22 x 29.5	180
48 x 22 x 29.5	170
42 x 22 x 29.5	160

Standard Veneer Top Standard Veneer Chassis	Premium Veneer Top Premium Veneer Chassis	High Pressure Laminate Top Veneer Chassis	Thermally Fused Laminate Top Thermally Fused Laminate Chassis
"W" Option N/A	RFT6022RE21P 3461	"G" Option N/A	"M" Option N/A
"W" Option N/A	RFT5422RE21P 3373	"G" Option N/A	"M" Option N/A
"W" Option N/A	RFT4822RE21P 3285	"G" Option N/A	"M" Option N/A
"W" Option N/A	RFT4222RE21P 3195	"G" Option N/A	"M" Option N/A
"W" Option N/A	RFT6022RE21P 3461	"G" Option N/A	"M" Option N/A
"W" Option N/A	RFT5422RE21P 3373	"G" Option N/A	"M" Option N/A
"W" Option N/A	RFT4822RE21P 3285	"G" Option N/A	"M" Option N/A
"W" Option N/A	RFT4222RE21P 3195	"G" Option N/A	"M" Option N/A
TBCO TBSW TSTV TSMV TSLV TOBW			
Edge N/A			
			
			

2 Select Finish

[Click to view finishes](#)

3 Select Edge

[Click to view edges](#)

4 Select Hardware

[Click to view details](#)

Product Features

- 1 Standard grommet - matches pull finish or specify black TM30, silver TM31 or white TM34
- Fixed Full Modesty
- Flush back hook-up detailing
- Locking drawers
- Recessed pedestal fronts
- Soft close suspension drawer(s)

Notes

- Top grain runs same as desk

Options

Accessories

- K1R: Center Drawer - \$290
- K28: Articulating Keyboard w/ Mouse - \$390

Drawer

- WPD3061: Designer White - \$80 per pedestal

Grommets (Non-Standard Location)

- Provide drawing w/ Grommet Location and Specify Color - \$95 ea.
- TM30-NS: Black Specify Location
- TM31-NS: Silver Specify Location
- TM34-NS: White Specify Location

Modesty

- M34T: Drop Door Tech Modesty - \$130
- M51: Open Back Modesty with Wire Mgmt Rail - Deduct \$95

Rift

"L" Workstation Returns
File/File

[Click here to view statement of line](#)

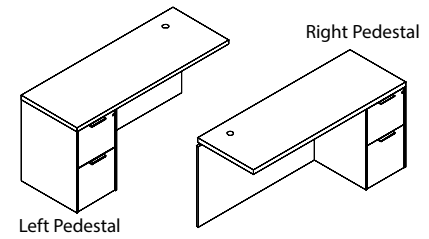

1 Select Model

w" x d" x h"	Weight
60 x 22 x 29.5	190
54 x 22 x 29.5	180
48 x 22 x 29.5	170
42 x 22 x 29.5	160
60 x 22 x 29.5	190
54 x 22 x 29.5	180
48 x 22 x 29.5	170
42 x 22 x 29.5	160

Standard Veneer Top Standard Veneer Chassis	Premium Veneer Top Premium Veneer Chassis	High Pressure Laminate Top Veneer Chassis	Thermally Fused Laminate Top Thermally Fused Laminate Chassis
"W" Option N/A	RFT6022RE195P 3461	"G" Option N/A	"M" Option N/A
"W" Option N/A	RFT5422RE195P 3373	"G" Option N/A	"M" Option N/A
"W" Option N/A	RFT4822RE195P 3285	"G" Option N/A	"M" Option N/A
"W" Option N/A	RFT4222RE195P 3195	"G" Option N/A	"M" Option N/A
"W" Option N/A	RFT6022RE196P 3461	"G" Option N/A	"M" Option N/A
"W" Option N/A	RFT5422RE196P 3373	"G" Option N/A	"M" Option N/A
"W" Option N/A	RFT4822RE196P 3285	"G" Option N/A	"M" Option N/A
"W" Option N/A	RFT4222RE196P 3195	"G" Option N/A	"M" Option N/A
TBCO TBSW TSTV TSMV TSLV TOBW			
Edge N/A			

2 Select Finish

[Click to view finishes](#)

3 Select Edge

[Click to view edges](#)

4 Select Hardware

[Click to view details](#)

Product Features

- 1 Standard grommet - matches pull finish or specify black TM30, silver TM31 or white TM34
- Fixed Full Modesty
- Flush back hook-up detailing
- Locking drawers
- Recessed pedestal fronts
- Soft close suspension drawer(s)

Notes

- Top grain runs same as desk

Options

Accessories

- K1R: Center Drawer - \$290
- K28: Articulating Keyboard w/ Mouse - \$390

Drawer

- WPD3061: Designer White - \$80 per pedestal

Grommets (Non-Standard Location)

- Provide drawing w/ Grommet Location and Specify Color - \$95 ea.
- TM30-NS: Black Specify Location
- TM31-NS: Silver Specify Location
- TM34-NS: White Specify Location

Modesty

- M34T: Drop Door Tech Modesty - \$130
- M51: Open Back Modesty with Wire Mgmt Rail - Deduct \$95

Rift
 "L" Workstation Returns
 Lateral File

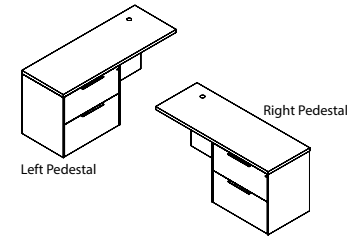

[Click here to view statement of line](#)

1 Select Model

w" x d" x h"	Weight
Left Pedestal	
60 x 22 x 29.5	205
54 x 22 x 29.5	190
48 x 22 x 29.5	180
Right Pedestal	
60 x 22 x 29.5	205
54 x 22 x 29.5	190
48 x 22 x 29.5	180

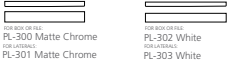
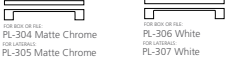
Standard Veneer Top Standard Veneer Chassis	Premium Veneer Top Premium Veneer Chassis	High Pressure Laminate Top Veneer Chassis	Thermally Fused Laminate Top Thermally Fused Laminate Chassis
"W" Option N/A	RFT6022RE187P 4154	"G" Option N/A	"M" Option N/A
"W" Option N/A	RFT5422RE187P 3977	"G" Option N/A	"M" Option N/A
"W" Option N/A	RFT4822RE187P 3798	"G" Option N/A	"M" Option N/A
"W" Option N/A	RFT6022RE188P 4154	"G" Option N/A	"M" Option N/A
"W" Option N/A	RFT5422RE188P 3977	"G" Option N/A	"M" Option N/A
"W" Option N/A	RFT4822RE188P 3798	"G" Option N/A	"M" Option N/A
TBCO TBSW TSTV TSMV TSLV TOBW			
Edge N/A			
 			

Product Features

- 1 Standard grommet - matches pull finish or specify black TM30, silver TM31 or white TM34
- Fixed Full Modesty
- Flush back hook-up detailing
- Lateral file drawers feature Legal/Letter filing
- Locking drawers
- Recessed pedestal fronts
- Features ball bearing suspensions, suspensions are full extension.

Options

Accessories

- K1R: Center Drawer - \$290
- K28: Articulating Keyboard w/ Mouse - \$390

Drawer

- WPD3061: Designer White - \$160 per pedestal

Grommets (Non-Standard Location)

- Provide drawing w/ Grommet Location and Specify Color - \$95 ea.
- TM30-NS: Black Specify Location
 - TM31-NS: Silver Specify Location
 - TM34-NS: White Specify Location

Modesty

- M34T: Drop Door Tech Modesty - \$130
- M51: Open Back Modesty with Wire Mgmt Rail - Deduct \$95

2 Select Finish

[Click to view finishes](#)

3 Select Edge

[Click to view edges](#)

4 Select Hardware

[Click to view details](#)

Rift

"L" Workstation Returns
Box Box/Storage/Lateral File

[Click here to view statement of line](#)

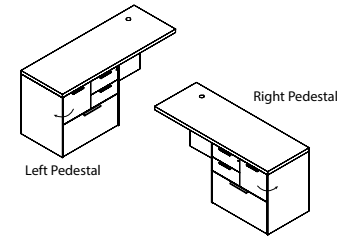

1 Select Model

w" x d" x h"	Weight
Left Pedestal	
60 x 22 x 29.5	205
54 x 22 x 29.5	190
48 x 22 x 29.5	180
Right Pedestal	
60 x 22 x 29.5	205
54 x 22 x 29.5	190
48 x 22 x 29.5	180

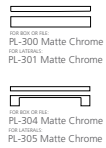
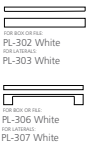
Standard Veneer Top Standard Veneer Chassis	Premium Veneer Top Premium Veneer Chassis	High Pressure Laminate Top Veneer Chassis	Thermally Fused Laminate Top Thermally Fused Laminate Chassis
"W" Option N/A	RFT6022RE218P 4448	"G" Option N/A	"M" Option N/A
"W" Option N/A	RFT5422RE218P 4271	"G" Option N/A	"M" Option N/A
"W" Option N/A	RFT4822RE218P 4093	"G" Option N/A	"M" Option N/A
"W" Option N/A	RFT6022RE219P 4448	"G" Option N/A	"M" Option N/A
"W" Option N/A	RFT5422RE219P 4271	"G" Option N/A	"M" Option N/A
"W" Option N/A	RFT4822RE219P 4093	"G" Option N/A	"M" Option N/A
TBCO			
TBSW			
TSTV			
TSMV			
TSLV			
TOBW			
Edge N/A			
			

2 Select Finish

[Click to view finishes](#)

3 Select Edge

[Click to view edges](#)

4 Select Hardware

[Click to view details](#)

Product Features

- 1 Standard grommet - matches pull finish or specify black TM30, silver TM31 or white TM34
- Door beside box drawers for small personal storage
- Fixed Full Modesty
- Flush back hook-up detailing
- Locking drawers
- Recessed pedestal fronts
- Box and file drawers feature soft close suspensions.(Lateral File drawers feature ball bearing suspensions), both suspensions are full extension.
- Top grain runs same as desk

Options

Accessories

- K1R: Center Drawer - \$290
- K28: Articulating Keyboard w/ Mouse - \$390

Door

- D2: Wood Door Lock - \$100 per door

Drawer

- WPD3061: Designer White - \$160 per pedestal

Grommets (Non-Standard Location)

Provide drawing w/ Grommet Location and Specify Color - \$95 ea.

- TM30-NS: Black Specify Location
- TM31-NS: Silver Specify Location
- TM34-NS: White Specify Location

Modesty

- M34T: Drop Door Tech Modesty - \$130
- M51: Open Back Modesty with Wire Mgmt Rail - Deduct \$95

Rift

Bridges
Open Back

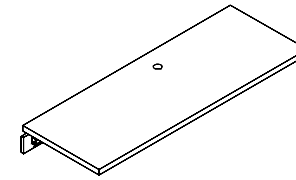

Open Back

[Click here to view statement of line](#)

1 Select Model

w" x d" x h"	Weight
60 x 22 x 29.5	70
54 x 22 x 29.5	65
48 x 22 x 29.5	60
42 x 22 x 29.5	55

Standard Veneer Top Standard Veneer Chassis	Premium Veneer Top Premium Veneer Chassis	High Pressure Laminate Top Veneer Chassis	Thermally Fused Laminate Top Thermally Fused Laminate Chassis
"W" Option N/A	RFT6022BR151P 1659	"G" Option N/A	"M" Option N/A
"W" Option N/A	RFT5422BR151P 1545	"G" Option N/A	"M" Option N/A
"W" Option N/A	RFT4822BR151P 1429	"G" Option N/A	"M" Option N/A
"W" Option N/A	RFT4222BR151P 1342	"G" Option N/A	"M" Option N/A
	TBCO TBSW TSTV TSMV TSLV TOBW		
	Edge N/A		
	Hardware N/A		

Product Features

- 1-5/16" Thick work surface
- 1 Standard grommet - matches pull finish or specify black TM30, silver TM31 or white TM34
- Flush back hook-up
- Top grain runs same as desk

Options

Accessories

- K28: Articulating Keyboard w/ Mouse - \$390

Grommets (Non-Standard Location)

Provide drawing w/ Grommet Location and Specify Color - \$95 ea.

- TM30-NS: Black Specify Location
- TM31-NS: Silver Specify Location
- TM34-NS: White Specify Location

Modesty

- M37: Fixed Full Modesty - \$130
- M34T-O: Drop Door Tech Modesty - \$310

2 Select Finish

[Click to view finishes](#)

3 Select Edge

[Click to view edges](#)

4 Select Hardware

[Click to view details](#)

Rift

Credenzas
File/Storage

[Click here to view statement of line](#)

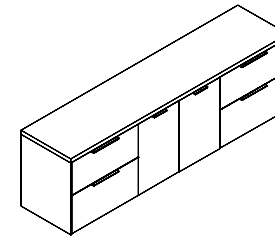









1 Select Model

w" x d" x h"
Lateral File
96 x 22 x 29.5
90 x 22 x 29.5

Weight

325
315

Standard Veneer Top Standard Veneer Chassis	Premium Veneer Top Premium Veneer Chassis	High Pressure Laminate Top Veneer Chassis	Thermally Fused Laminate Top Thermally Fused Laminate Chassis
"W" Option N/A "W" Option N/A	RFT9622CA651P 9341 RFT9022CA651P 8811	"G" Option N/A "G" Option N/A	"M" Option N/A "M" Option N/A
	TBCO TBSW TSTV TSMV TSLV TOBW		
	Edge N/A		
	 <small>PL-300 Matte Chrome</small>  <small>PL-301 Matte Chrome</small>  <small>PL-304 Matte Chrome</small>  <small>PL-305 Matte Chrome</small>	 <small>PL-302 White</small>  <small>PL-303 White</small>  <small>PL-306 White</small>  <small>PL-307 White</small>	

2 Select Finish

[Click to view finishes](#)

3 Select Edge

[Click to view edges](#)

4 Select Hardware

[Click to view details](#)

Product Features

- 1-5/16" Thick work surface
- Center storage has 1 adjustable wood shelf
- Lateral Files feature Legal/Letter filing
- Locking drawers
- Recessed front detailing
- Features ball bearing suspensions, suspensions are full extension.
- Solid lumber core banded end panels

Notes

- Unit has black back panel and is not designed for Open Plan use. Select OPB option for Open Plan application

Options

Accessories

- MTL30-S: Silver metal legs - \$315 unit
- MTL30-W: White metal legs - \$420 unit

Door

- D2: Wood Door Lock - \$100 per door set
- D6: Delete Doors - n/c
- D9SC: Soft Close Door Hinges - \$20 per door

Drawer / Door

- WPD3061: Designer White - \$160 per lateral pedestal
- WPD3061: Designer White - \$80 per credenza door

Grommet (Standard Location)

Specify Color and Location (Right/Left/Center) - \$50 ea.

- Black: TM30-R (Right), TM30-L (Left), TM30-C (Center)
- Silver: TM31-R (Right), TM31-L (Left), TM31-C (Center)
- White: TM34-R (Right), TM34-L (Left), TM34-C (Center)

Open Plan _ Finished Back

- OPB:Modify Unit for Open Plan Application - \$195

Rift

Credenzas

Kneespace File/File And Lateral File

[Click here to view statement of line](#)

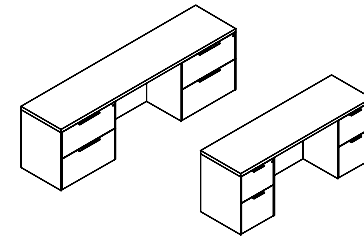

1 Select Model

w" x d" x h"	Weight
Lateral File	
96 x 22 x 29.5	300
90 x 22 x 29.5	290
File/File	
84 x 22 x 29.5	255
72 x 22 x 29.5	220
60 x 22 x 29.5	200

	Standard Veneer Top Standard Veneer Chassis	Premium Veneer Top Premium Veneer Chassis	High Pressure Laminate Top Veneer Chassis	Thermally Fused Laminate Top Thermally Fused Laminate Chassis
	"W" Option N/A	RFT9622CA052P 7356	"G" Option N/A	"M" Option N/A
	"W" Option N/A	RFT9022CA052P 7178	"G" Option N/A	"M" Option N/A
	"W" Option N/A	RFT8422CA054P 5956	"G" Option N/A	"M" Option N/A
	"W" Option N/A	RFT7222CA054P 5710	"G" Option N/A	"M" Option N/A
	"W" Option N/A	RFT6022CA054P 5521	"G" Option N/A	"M" Option N/A
2 Select Finish Click to view finishes		TBCO TBSW TSTV TSMV TSLV TOBW		
3 Select Edge Click to view edges		Edge N/A		
4 Select Hardware Click to view details		<p>PL-300 Matte Chrome PL-301 Matte Chrome PL-304 Matte Chrome PL-305 Matte Chrome</p>	<p>PL-302 White PL-303 White PL-306 White PL-307 White</p>	

Product Features

- 1-5/16" Thick work surface
- Fixed Full Modesty
- Full extension locking drawers
- Legal/Letter filing
- Recessed front detailing
- Box and File drawers feature soft close suspensions(Lateral drawers are ball suspensions), both suspensions are full extension.
- Solid lumber core banded end panels

Notes

- Unit has black back panel and is not designed for Open Plan use. Select OPB option for Open Plan application

Options

Accessories

- K1R: Center Drawer - \$290
- K28: Articulating Keyboard w/ Mouse - \$390
- MTL40-S: Silver metal legs - \$420 unit
- MTL40-W: White metal legs - \$625 unit

Drawer

- WPD3061: Designer White - \$160 per lateral pedestal
- WPD3061: Designer White - \$80 per F/F pedestal

Grommet (Standard Location)

Specify Color - \$50 ea.

- Black: TM30-C (Center)
- Silver: TM31-C (Center)
- White: TM34-C (Center)

Grommets (Non-Standard Location)

Provide drawing w/ Grommet Location and Specify Color - \$95 ea.

- TM30-NS: Black Specify Location
- TM31-NS: Silver Specify Location
- TM34-NS: White Specify Location

Modesty

- M34T: Drop Door Tech Modesty - \$130
- M51: Open Back Modesty with Wire Mgmt Rail - Deduct \$95

Open Plan _ Finished Back

- OPB: Modify Unit for Open Plan Application - \$195

Rift

Credenzas

Kneespace Box/Hidden Box/File

[Click here to view statement of line](#)

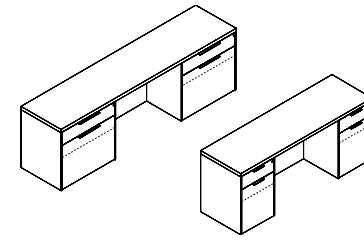

1 Select Model

w" x d" x h"	Weight
4 Box Drawers 2 Lateral Files	
96 x 22 x 29.5	300
90 x 22 x 29.5	290
4 Box Drawers 2 Files	
84 x 22 x 29.5	255
72 x 22 x 29.5	220
60 x 22 x 29.5	200

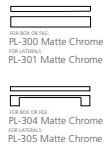
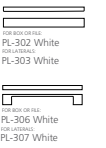
Standard Veneer Top Standard Veneer Chassis	Premium Veneer Top Premium Veneer Chassis	High Pressure Laminate Top Veneer Chassis	Thermally Fused Laminate Top Thermally Fused Laminate Chassis
"W" Option N/A	RFT9622CA684P 7495	"G" Option N/A	"M" Option N/A
"W" Option N/A	RFT9022CA684P 7318	"G" Option N/A	"M" Option N/A
"W" Option N/A	RFT8422CA685P 6096	"G" Option N/A	"M" Option N/A
"W" Option N/A	RFT7222CA685P 5852	"G" Option N/A	"M" Option N/A
"W" Option N/A	RFT6022CA685P 5661	"G" Option N/A	"M" Option N/A
TBCO TBSW TSTV TSMV TSLV TOBW			
Edge N/A			
			

2 Select Finish

[Click to view finishes](#)

3 Select Edge

[Click to view edges](#)

4 Select Hardware

[Click to view details](#)

Product Features

- 1-5/16" Thick work surface
- Fixed Full Modesty
- Legal/Letter filing
- Recessed front detailing
- Solid lumber core banded end panels
- Box and File drawers feature soft close suspensions(Lateral drawers are ball suspensions), both suspensions are full extension.

Notes

- Unit has black back panel and is not designed for Open Plan use. Select OPB option for Open Plan application

Options

Accessories

- K1R: Center Drawer - \$290
- K28: Articulating Keyboard w/ Mouse - \$390
- MTL40-S: Silver metal legs - \$420 unit
- MTL40-W: White metal legs - \$625 unit

Drawer

- WPD3061: Designer White - \$160 per lateral pedestal
- WPD3061: Designer White - \$80 per B/B/F pedestal

Grommet (Standard Location)

Specify Color - \$50 ea.

- Black: TM30-C (Center)
- Silver: TM31-C (Center)
- White: TM34-C (Center)

Grommets (Non-Standard Location)

Provide drawing w/ Grommet Location and Specify Color - \$95 ea.

- TM30-NS: Black Specify Location
- TM31-NS: Silver Specify Location
- TM34-NS: White Specify Location

Modesty

- M34T: Drop Door Tech Modesty - \$130
- M51: Open Back Modesty with Wire Mgmt Rail - Deduct \$95

Open Plan _ Finished Back

- OPB: Modify Unit for Open Plan Application - \$195

Rift

Credenzas
Storage With Hinged Doors

[Click here to view statement of line](#)

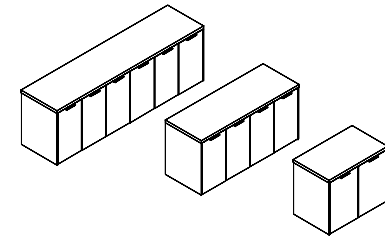

1 Select Model

w" x d" x h"	Weight
6 Door	
96 x 22 x 29.5	285
90 x 22 x 29.5	270
4 Door	
72 x 22 x 29.5	225
60 x 22 x 29.5	195
2 Door	
36 x 22 x 29.5	130
30 x 22 x 29.5	115

	Standard Veneer Top Standard Veneer Chassis	Premium Veneer Top Premium Veneer Chassis	High Pressure Laminate Top Veneer Chassis	Thermally Fused Laminate Top Thermally Fused Laminate Chassis
"W" Option N/A	RFT9622CA125P	7160	"G" Option N/A	"M" Option N/A
"W" Option N/A	RFT9022CA125P	6958	"G" Option N/A	"M" Option N/A
"W" Option N/A	RFT7222CA125P	5621	"G" Option N/A	"M" Option N/A
"W" Option N/A	RFT6022CA125P	5301	"G" Option N/A	"M" Option N/A
"W" Option N/A	RFT3622CA125P	2943	"G" Option N/A	"M" Option N/A
"W" Option N/A	RFT3022CA125P	2708	"G" Option N/A	"M" Option N/A
	TBCO			
	TBSW			
	TSTV			
	TSMV			
	TSLV			
	TOBW			
	Edge N/A			
	<p>PL-300 Matte Chrome PL-301 Matte Chrome PL-304 Matte Chrome PL-305 Matte Chrome</p>	<p>PL-302 White PL-303 White</p>		

2 Select Finish

[Click to view finishes](#)

3 Select Edge

[Click to view edges](#)

4 Select Hardware

[Click to view details](#)

Product Features

- 1-5/16" Thick work surface
- Adjustable finished shelf behind each door section
- Recessed front detailing
- Solid lumber core banded end panels

Notes

- Unit has black back panel and is not designed for Open Plan use. Select OPB option for Open Plan application

Options

Accessories

- MTL30-S: Silver metal legs - \$315 unit
- MTL30-W: White metal legs - \$420 unit

Door

- D2: Wood Door Lock - \$100 per door set
- D6: Delete Doors - n/c
- WPD3061: Designer White - \$80 per door

Grommet (Standard Location)

- Specify Color and Location (Right/Left/Center) - \$50 ea.
- Black: TM30-R (Right), TM30-L (Left), TM30-C (Center)
- Silver: TM31-R (Right), TM31-L (Left), TM31-C (Center)
- White: TM34-R (Right), TM34-L (Left), TM34-C (Center)

Open Plan _ Finished Back

- OPB: Modify Unit for Open Plan Application - \$195

Rift
Credenzas
Lateral File

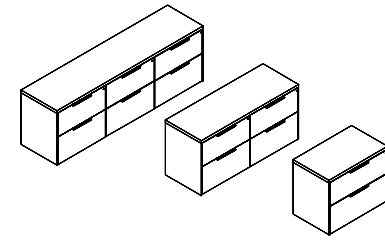

[Click here to view statement of line](#)

1 Select Model

w" x d" x h"	Weight
6 Drawer	
96 x 22 x 29.5	420
90 x 22 x 29.5	410
4 Drawer	
72 x 22 x 29.5	310
60 x 22 x 29.5	280
2 Drawer	
42 x 22 x 29.5	180
36 x 22 x 29.5	160
30 x 22 x 29.5	145

Standard Veneer Top Standard Veneer Chassis	Premium Veneer Top Premium Veneer Chassis	High Pressure Laminate Top Veneer Chassis	Thermally Fused Laminate Top Thermally Fused Laminate Chassis
"W" Option N/A	RFT9622CA104P 9501	"G" Option N/A	"M" Option N/A
"W" Option N/A	RFT9022CA104P 9262	"G" Option N/A	"M" Option N/A
"W" Option N/A	RFT7222CA104P 6346	"G" Option N/A	"M" Option N/A
"W" Option N/A	RFT6022CA104P 6071	"G" Option N/A	"M" Option N/A
"W" Option N/A	RFT4222CA104P 3181	"G" Option N/A	"M" Option N/A
"W" Option N/A	RFT3622CA104P 2869	"G" Option N/A	"M" Option N/A
"W" Option N/A	RFT3022CA104P 2749	"G" Option N/A	"M" Option N/A
<p>TBCO TBSW TSTV TSMV TSLV TOBW</p>			
<p>Edge N/A</p>			
<p> </p>			

2 Select Finish
[Click to view finishes](#)

3 Select Edge
[Click to view edges](#)

4 Select Hardware
[Click to view details](#)

Product Features

- 1-5/16" Thick work surface
- Lateral has legal/ double letter filing
- Locking drawers
- Recessed front detailing
- Features ball bearing suspensions, suspensions are full extension.
- Solid lumber core banded end panels

Notes

- Unit has black back panel and is not designed for Open Plan use. Select OPB option for Open Plan application

Options

Accessories

- MTL30-S: Silver metal legs - \$315 unit
- MTL30-W: White metal legs - \$420 unit

Drawer

- WPD3061: Designer White - \$160 per pedestal

Grommet (Standard Location)

- Specify Color and Location (Right/Left/Center) - \$50 ea.
- Black: TM30-R (Right), TM30-L (Left), TM30-C (Center)
- Silver: TM31-R (Right), TM31-L (Left), TM31-C (Center)
- White: TM34-R (Right), TM34-L (Left), TM34-C (Center)

Open Plan _ Finished Back

- OPB:Modify Unit for Open Plan Application - \$195

Rift

Credenzas
Box/Hidden Box/Lateral File

[Click here to view statement of line](#)

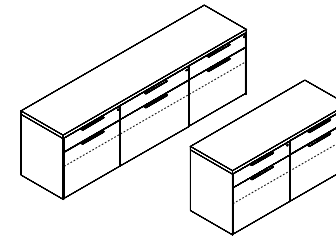

1 Select Model

w" x d" x h"	Weight
6 Box Drawers 3 Lateral Files	
96 x 22 x 29.5	420
90 x 22 x 29.5	400
4 Box Drawers 2 Lateral Files	
72 x 22 x 29.5	310
60 x 22 x 29.5	280

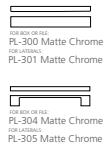
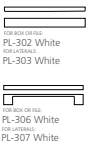
Standard Veneer Top Standard Veneer Chassis	Premium Veneer Top Premium Veneer Chassis	High Pressure Laminate Top Veneer Chassis	Thermally Fused Laminate Top Thermally Fused Laminate Chassis
"W" Option N/A	RFT9622CA671P 9501	"G" Option N/A	"M" Option N/A
"W" Option N/A	RFT9022CA671P 9262	"G" Option N/A	"M" Option N/A
"W" Option N/A	RFT7222CA671P 6346	"G" Option N/A	"M" Option N/A
"W" Option N/A	RFT6022CA671P 6071	"G" Option N/A	"M" Option N/A
TBCO TBSW TSTV TSMV TSLV TOBW			
Edge N/A			
			

Product Features

- 1-5/16" Thick work surface
- Lateral has legal/ double letter filing
- Recessed front detailing
- Features ball bearing suspensions, suspensions are full extension.
- Solid lumber core banded end panels
- Unit features 2 large box drawers and lateral file underneath

Notes

- Unit has black back panel and is not designed for Open Plan use. Select OPB option for Open Plan application

Options

Accessories

- MTL30-S: Silver metal legs - \$315 unit
- MTL30-W: White metal legs - \$420 unit

Drawer

- WPD3061: Designer White - \$160 per pedestal

Grommet (Standard Location)

- Specify Color and Location (Right/Left/Center) - \$50 ea.
- Black: TM30-R (Right), TM30-L (Left), TM30-C (Center)
 - Silver: TM31-R (Right), TM31-L (Left), TM31-C (Center)
 - White: TM34-R (Right), TM34-L (Left), TM34-C (Center)

Open Plan _ Finished Back

- OPB: Modify Unit for Open Plan Application - \$195

Rift

Lateral Files
Vertical Lateral File

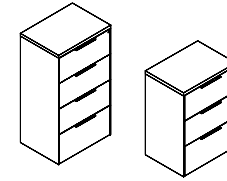

[Click here to view statement of line](#)

1 Select Model

w" x d" x h"	Weight
4 Drawer	
30 x 22 x 54	250
36 x 22 x 54	275
3 Drawer	
30 x 22 x 42	215
36 x 22 x 42	235

Standard Veneer Top Standard Veneer Chassis	Premium Veneer Top Premium Veneer Chassis	High Pressure Laminate Top Veneer Chassis	Thermally Fused Laminate Top Thermally Fused Laminate Chassis
"W" Option N/A	RFT3022F111P 4991	"G" Option N/A	"M" Option N/A
"W" Option N/A	RFT3622F111P 5167	"G" Option N/A	"M" Option N/A
"W" Option N/A	RFT3022F112P 4403	"G" Option N/A	"M" Option N/A
"W" Option N/A	RFT3622F112P 4580	"G" Option N/A	"M" Option N/A
<p>TBCO TBSW TSTV TSMV TSLV TOBW</p>			
<p>Edge N/A</p>			

Product Features

- 1-5/16" Thick work surface
- Lateral has legal/ double letter filing
- Locking drawers
- Recessed front detailing
- Features ball bearing suspensions, suspensions are full extension.
- Solid lumber core banded end panels

Notes

- Unit has black back panel and is not designed for Open Plan use. Select OPB option for Open Plan application

Options

Accessories

- MTL30-S: Silver metal legs - \$315 unit
- MTL30-W: White metal legs - \$420 unit

Drawer

- WPD3061: Designer White - \$160 per pedestal

Open Plan _ Finished Back

- OPB:Modify Unit for Open Plan Application - \$195

2 Select Finish

[Click to view finishes](#)

3 Select Edge

[Click to view edges](#)

4 Select Hardware

[Click to view details](#)

Rift

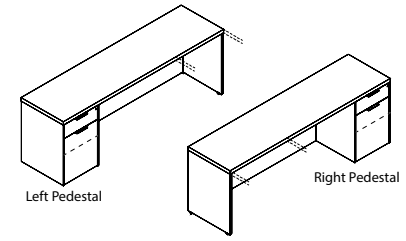

Workstation Credenzas
Box/Hidden Box/File

[Click here to view statement of line](#)

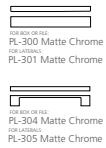

1 Select Model

w" x d" x h"	Weight
Left Pedestal	
96 x 22 x 29.5	210
90 x 22 x 29.5	200
84 x 22 x 29.5	190
72 x 22 x 29.5	180
66 x 22 x 29.5	170
Right Pedestal	
96 x 22 x 29.5	210
90 x 22 x 29.5	200
84 x 22 x 29.5	190
72 x 22 x 29.5	180
66 x 22 x 29.5	170

Standard Veneer Top Standard Veneer Chassis	Premium Veneer Top Premium Veneer Chassis	High Pressure Laminate Top Veneer Chassis	Thermally Fused Laminate Top Thermally Fused Laminate Chassis
"W" Option N/A	RFT9622CA795P 5812	"G" Option N/A	"M" Option N/A
"W" Option N/A	RFT9022CA795P 5446	"G" Option N/A	"M" Option N/A
"W" Option N/A	RFT8422CA795P 4910	"G" Option N/A	"M" Option N/A
"W" Option N/A	RFT7222CA795P 4194	"G" Option N/A	"M" Option N/A
"W" Option N/A	RFT6622CA795P 3939	"G" Option N/A	"M" Option N/A
"W" Option N/A	RFT9622CA796P 5812	"G" Option N/A	"M" Option N/A
"W" Option N/A	RFT9022CA796P 5446	"G" Option N/A	"M" Option N/A
"W" Option N/A	RFT8422CA796P 4910	"G" Option N/A	"M" Option N/A
"W" Option N/A	RFT7222CA796P 4194	"G" Option N/A	"M" Option N/A
"W" Option N/A	RFT6622CA796P 3939	"G" Option N/A	"M" Option N/A
TBCO			
TBSW			
TSTV			
TSMV			
TSLV			
TOBW			
Edge N/A			
			

2 Select Finish

[Click to view finishes](#)

3 Select Edge

[Click to view edges](#)

4 Select Hardware

[Click to view details](#)

Product Features

- 1-5/16" Thick work surface
- Fixed Full Modesty
- Locking drawers
- Recessed front detailing
- Soft close suspension drawer(s)
- Solid lumber core banded end panels

Notes

- Unit has black back panel and is not designed for Open Plan use. Select OPB option for Open Plan application

Options

Accessories

- K28: Articulating Keyboard w/ Mouse - \$390

Drawer

- WPD3061: Designer White - \$80 per pedestal

Grommet (Standard Location)

Specify Color - \$50 ea.

- Black: TM30-C (Center)
- Silver: TM31-C (Center)
- White: TM34-C (Center)

Grommets (Non-Standard Location)

Provide drawing w/ Grommet Location and Specify Color - \$95 ea.

- TM30-NS: Black Specify Location
- TM31-NS: Silver Specify Location
- TM34-NS: White Specify Location

Modesty

- M34T: Drop Door Tech Modesty - \$130
- M51: Open Back Modesty with Wire Mgmt Rail - Deduct \$95

Open Plan _ Finished Back

- OPB: Modify Unit for Open Plan Application - \$195

Rift
Workstation Credenzas
File/File

[Click here to view statement of line](#)

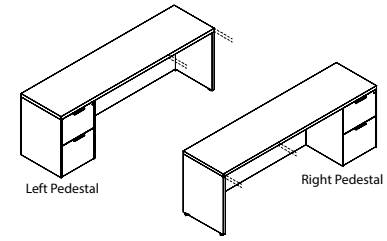

1 Select Model

w" x d" x h"	Weight
Left Pedestal	
96 x 22 x 29.5	210
90 x 22 x 29.5	200
84 x 22 x 29.5	190
72 x 22 x 29.5	180
66 x 22 x 29.5	170
Right Pedestal	
96 x 22 x 29.5	210
90 x 22 x 29.5	200
84 x 22 x 29.5	190
72 x 22 x 29.5	180
66 x 22 x 29.5	170

2 Select Finish

[Click to view finishes](#)

3 Select Edge

[Click to view edges](#)

4 Select Hardware

[Click to view details](#)

Standard Veneer Top Standard Veneer Chassis	Premium Veneer Top Premium Veneer Chassis	High Pressure Laminate Top Veneer Chassis	Thermally Fused Laminate Top Thermally Fused Laminate Chassis
"W" Option N/A	RFT9622CA086P 5728	"G" Option N/A	"M" Option N/A
"W" Option N/A	RFT9022CA086P 5361	"G" Option N/A	"M" Option N/A
"W" Option N/A	RFT8422CA086P 4994	"G" Option N/A	"M" Option N/A
"W" Option N/A	RFT7222CA086P 4109	"G" Option N/A	"M" Option N/A
"W" Option N/A	RFT6622CA086P 3853	"G" Option N/A	"M" Option N/A
"W" Option N/A	RFT9622CA087P 5728	"G" Option N/A	"M" Option N/A
"W" Option N/A	RFT9022CA087P 5361	"G" Option N/A	"M" Option N/A
"W" Option N/A	RFT8422CA087P 4994	"G" Option N/A	"M" Option N/A
"W" Option N/A	RFT7222CA087P 4109	"G" Option N/A	"M" Option N/A
"W" Option N/A	RFT6622CA087P 3853	"G" Option N/A	"M" Option N/A
TBCO TBSW TSTV TSMV TSLV TOBW			
Edge N/A			

Product Features

- 1-5/16" Thick work surface
- File/File
- Fixed Full Modesty
- Locking drawers
- Recessed front detailing
- Soft close suspension drawer(s)
- Solid lumber core banded end panels

Notes

- Unit has black back panel and is not designed for Open Plan use. Select OPB option for Open Plan application

Options

Accessories

- K28: Articulating Keyboard w/ Mouse - \$390

Drawer

- WPD3061: Designer White - \$80 per pedestal

Grommet (Standard Location)

- Specify Color - \$50 ea.
- Black: TM30-C (Center)
- Silver: TM31-C (Center)
- White: TM34-C (Center)

Grommets (Non-Standard Location)

- Provide drawing w/ Grommet Location and Specify Color - \$95 ea.
- TM30-NS: Black Specify Location
- TM31-NS: Silver Specify Location
- TM34-NS: White Specify Location

Modesty

- M34T: Drop Door Tech Modesty - \$130
- M51: Open Back Modesty with Wire Mgmt Rail - Deduct \$95

Open Plan _ Finished Back

- OPB: Modify Unit for Open Plan Application - \$195

Rift
Workstation Credenzas
Lateral File

[Click here to view statement of line](#)

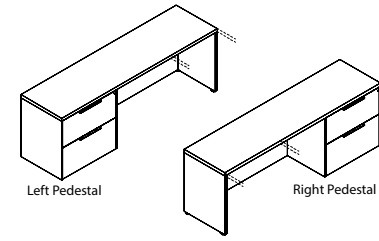

1 Select Model

w" x d" x h"	Weight
Left Pedestal	
96 x 22 x 29.5	245
90 x 22 x 29.5	240
84 x 22 x 29.5	235
72 x 22 x 29.5	230
66 x 22 x 29.5	225
Right Pedestal	
96 x 22 x 29.5	245
90 x 22 x 29.5	240
84 x 22 x 29.5	235
72 x 22 x 29.5	230
66 x 22 x 29.5	225

	Standard Veneer Top Standard Veneer Chassis	Premium Veneer Top Premium Veneer Chassis	High Pressure Laminate Top Veneer Chassis	Thermally Fused Laminate Top Thermally Fused Laminate Chassis
	"W" Option N/A	RFT9622CA066P 5902	"G" Option N/A	"M" Option N/A
	"W" Option N/A	RFT9022CA066P 5658	"G" Option N/A	"M" Option N/A
	"W" Option N/A	RFT8422CA066P 5473	"G" Option N/A	"M" Option N/A
	"W" Option N/A	RFT7222CA066P 4588	"G" Option N/A	"M" Option N/A
	"W" Option N/A	RFT6622CA066P 4411	"G" Option N/A	"M" Option N/A
	"W" Option N/A	RFT9622CA067P 5902	"G" Option N/A	"M" Option N/A
	"W" Option N/A	RFT9022CA067P 5658	"G" Option N/A	"M" Option N/A
	"W" Option N/A	RFT8422CA067P 5473	"G" Option N/A	"M" Option N/A
	"W" Option N/A	RFT7222CA067P 4588	"G" Option N/A	"M" Option N/A
	"W" Option N/A	RFT6622CA067P 4411	"G" Option N/A	"M" Option N/A
		TBCO TBSW TSTV TSMV TSLV TOBW		
		Edge N/A		

Product Features

- 1-5/16" Thick work surface
- Fixed Full Modesty
- Lateral file drawers feature Legal/Letter filing
- Locking drawers
- Recessed front detailing
- Features ball bearing suspensions, suspensions are full extension
- Solid lumber core banded end panels

Notes

- Unit has black back panel and is not designed for Open Plan use. Select OPB option for Open Plan application

Options

Accessories

- K28: Articulating Keyboard w/ Mouse - \$390

Drawer

- WPD3061: Designer White - \$150 per pedestal

Grommet (Standard Location)

- Specify Color - \$50 ea.
- Black: TM30-C (Center)
- Silver: TM31-C (Center)
- White: TM34-C (Center)

Grommets (Non-Standard Location)

- Provide drawing w/ Grommet Location and Specify Color - \$95 ea.
- TM30-NS: Black Specify Location
- TM31-NS: Silver Specify Location
- TM34-NS: White Specify Location

Modesty

- M34T: Drop Door Tech Modesty - \$130
- M51: Open Back Modesty with Wire Mgmt Rail - Deduct \$95

Open Plan _ Finished Back

- OPB: Modify Unit for Open Plan Application - \$195

2 Select Finish

[Click to view finishes](#)

3 Select Edge

[Click to view edges](#)

4 Select Hardware

[Click to view details](#)

Rift

Workstation Credenzas
Box/Box/Storage/Lateral File

[Click here to view statement of line](#)

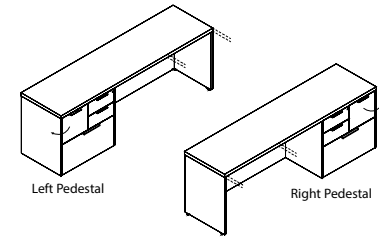

1 Select Model

w" x d" x h"	Weight
Left Pedestal	
96 x 22 x 29.5	245
90 x 22 x 29.5	240
84 x 22 x 29.5	235
72 x 22 x 29.5	230
66 x 22 x 29.5	225
Right Pedestal	
96 x 22 x 29.5	245
90 x 22 x 29.5	240
84 x 22 x 29.5	235
72 x 22 x 29.5	230
66 x 22 x 29.5	225

	Standard Veneer Top Standard Veneer Chassis	Premium Veneer Top Premium Veneer Chassis	High Pressure Laminate Top Veneer Chassis	Thermally Fused Laminate Top Thermally Fused Laminate Chassis
"W" Option N/A	RFT9622CA659P 6302	RFT9022CA659P 6124	"G" Option N/A	"M" Option N/A
"W" Option N/A	RFT8422CA659P 5942	RFT7222CA659P 5157	"G" Option N/A	"M" Option N/A
"W" Option N/A	RFT6622CA659P 4952	RFT9622CA660P 6302	"G" Option N/A	"M" Option N/A
"W" Option N/A	RFT9022CA660P 6124	RFT8422CA660P 5942	"G" Option N/A	"M" Option N/A
"W" Option N/A	RFT7222CA660P 5157	RFT6622CA660P 4952	"G" Option N/A	"M" Option N/A
TBCO				
TBSW				
TSTV				
TSMV				
TSLV				
TOBW				
Edge N/A				
PL-300 Matte Chrome				
PL-301 Matte Chrome				
PL-302 White				
PL-303 White				
PL-304 Matte Chrome				
PL-305 Matte Chrome				
PL-306 White				
PL-307 White				

2 Select Finish

[Click to view finishes](#)

3 Select Edge

[Click to view edges](#)

4 Select Hardware

[Click to view details](#)

Product Features

- 1-5/16" Thick work surface
- Door beside box drawers for small personal storage
- Fixed Full Modesty
- Recessed front detailing
 - "W" & "G" Box and File Drawers feature soft close suspensions (Lateral Drawers Feature ball bearing suspensions)
- Solid lumber core banded end panels

Notes

- Unit has black back panel and is not designed for Open Plan use. Select OPB option for Open Plan application

Options

Accessories

- K28: Articulating Keyboard w/ Mouse - \$390

Door

- D2: Door Lock for Personal Storage Door- \$100 per door

Drawer

- WPD3061: Designer White - \$150 per pedestal

Grommet (Standard Location)

Specify Color - \$50 ea.

- Black: TM30-C (Center)
- Silver: TM31-C (Center)
- White: TM34-C (Center)

Grommets (Non-Standard Location)

Provide drawing w/ Grommet Location and Specify Color - \$95 ea.

- TM30-NS: Black Specify Location
- TM31-NS: Silver Specify Location
- TM34-NS: White Specify Location

Modesty

- M34T: Drop Door Tech Modesty - \$130
- M51: Open Back Modesty with Wire Mgmt Rail - Deduct \$95

Open Plan _ Finished Back

- OPB: Modify Unit for Open Plan Application - \$195

Rift

Open Plan Bench Credenzas
Full Cabinet Bench

[Click here to view statement of line](#)

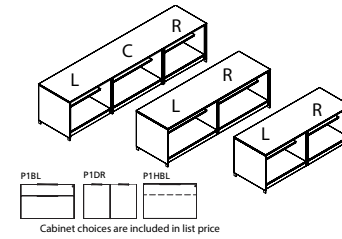

1 Select Model

Weight

w" x d" x h"	
(2) 30"W Cabinet (1) 36"W Cabinet	
96 x 22 x 22.5	"W" Option N/A
(3) 30"W Cabinet	
90 x 22 x 22.5	"W" Option N/A
(2) 36"W Cabinet	
72 x 22 x 22.5	"W" Option N/A
(1) 30"W Cabinet (1) 36"W Cabinet	
66 x 22 x 22.5	"W" Option N/A
(2) 30"W Cabinet	
60 x 22 x 22.5	"W" Option N/A

Standard Veneer Top Standard Veneer Chassis	Premium Veneer Top Premium Veneer Chassis	High Pressure Laminate Top Veneer Chassis	Thermally Fused Laminate Top Thermally Fused Laminate Chassis
	RFT9622CA062P 7276	"G" Option N/A	"M" Option N/A
	RFT9022CA062P 7136	"G" Option N/A	"M" Option N/A
	RFT7222CA062P 6943	"G" Option N/A	"M" Option N/A
	RFT6622CA062P 5755	"G" Option N/A	"M" Option N/A
	RFT6022CA062P 5634	"G" Option N/A	"M" Option N/A
	TBCO TBSW TSTV TSMV TSLV TOBW		
	Edge N/A		
	 PL-300 Matte Chrome PL-301 Matte Chrome PL-304 Matte Chrome PL-305 Matte Chrome	 PL-302 White PL-303 White PL-306 White PL-307 White	

2 Select Finish

[Click to view finishes](#)

3 Select Edge

[Click to view edges](#)

4 Select Hardware

[Click to view details](#)

Product Features

Notes

- Please indicate cabinet sizes (30" - 36") as well as each cabinet's location, from left to right
- Select cabinets and fixed locations
- Silver metal legs

Options

Accessories

- MTL30-W: White metal legs - \$105 unit

Cushion

- BC22: Bench Cushion
- Specify location, number of cushions and fabric grade.
- Cushions sold individually w/a max width 35" (to match storage section depth). 29" W requires .75 yd, 35" W requires 1 yd.

Drawer

- WPD3061: Designer White - \$80 per door
- WPD3061: Designer White - \$160 per pedestal

Storage

Specify pull with storage option/ Specify location of each cabinet

- P1BL: Box/Lateral File - n/c
- P1DR: Two Door Storage - n/c
- P1HBL: Hidden Box Lateral - n/c

BC22 Bench Cushion fabric grades

COM	COL	1	2	3
282	N/A	319	337	355
4	5	6	7	8
373	391	409	427	445
9	10	11/ L1	12	13/ L2
463	481	499	517	553

Rift

Open Plan Bench Credenzas
Full Storage With Sliding Door

[Click here to view statement of line](#)

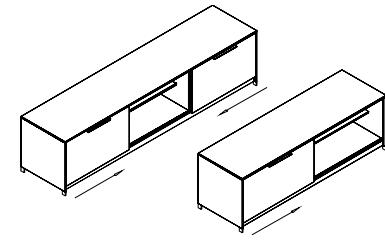

1 Select Model

w" x d" x h"	Weight
Double Door	
96 x 22 x 22.5	305
90 x 22 x 22.5	295
Single Door	
72 x 22 x 22.5	205
60 x 22 x 22.5	175

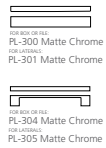
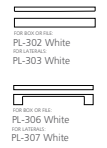
	Standard Veneer Top Standard Veneer Chassis	Premium Veneer Top Premium Veneer Chassis	High Pressure Laminate Top Veneer Chassis	Thermally Fused Laminate Top Thermally Fused Laminate Chassis
	"W" Option N/A	RFT9622CA661P 6723 RFT9022CA661P 6606	"G" Option N/A "G" Option N/A	"M" Option N/A "M" Option N/A
	"W" Option N/A	RFT7222CA661P 5486 RFT6022CA661P 5398	"G" Option N/A "G" Option N/A	"M" Option N/A "M" Option N/A
2 Select Finish Click to view finishes		TBCO TBSW TSTV TSMV TSLV TOBW		
3 Select Edge Click to view edges		Edge N/A		
4 Select Hardware Click to view details		 PL-300 Matte Chrome PL-301 Matte Chrome PL-304 Matte Chrome PL-305 Matte Chrome	 PL-302 White PL-303 White PL-306 White PL-307 White	

Product Features

- Adjustable finished shelf behind each door section
- Benches designed for open plan use

Notes

- Silver metal legs

Options

Accessories

- MTL30-W: White metal legs - \$105 unit

Cushion

- BC22: Bench Cushion
- Specify location, number of cushions and fabric grade.
- Cushions sold individually w/a max width 35" (to match storage section depth). 29" W requires .75 yd, 35" W requires 1 yd.

Door

- WPD3061: Designer White - \$80 per door

BC22 Bench Cushion fabric grades

COM	COL	1	2	3
282	301	319	337	355
4	5	6	7	8
373	391	409	427	445
9	10	11/ L1	12	13/ L2
463	481	499	517	553

Rift

Mobile Pedestals
Undersurface Mobile Pedestals

[Click here to view statement of line](#)

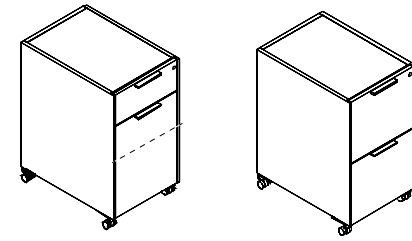

1 Select Model

w" x d" x h"	Weight	
Box/ Hidden Box/ File Undersurface		
16 x 18 x 27.5	75	"W" Option N/A
File/File Undersurface		
16 x 18 x 27.5	75	"W" Option N/A

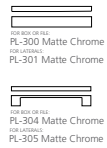
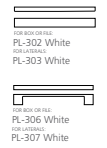
Standard Veneer Top Standard Veneer Chassis	Premium Veneer Top Premium Veneer Chassis	High Pressure Laminate Top Veneer Chassis	Thermally Fused Laminate Top Thermally Fused Laminate Chassis
	RFT1618PD424P 2016	"G" Option N/A	"M" Option N/A
	RFT1618PD425P 2016	"G" Option N/A	"M" Option N/A
	TBCO TBSW TSTV TSMV TSLV TOBW		
	Edge N/A		
	 PL-300 Matte Chrome PL-301 Matte Chrome PL-304 Matte Chrome PL-305 Matte Chrome	 PL-302 White PL-303 White PL-306 White PL-307 White	

Product Features

- Box drawers include divider
- Die cast designer casters
- Finished all sides
- Locking drawers
- Pedestals anti-tilt weighted
- Recessed front detailing

Options

Drawer

- WPD3061: Designer White - \$80 per pedestal

2 Select Finish

[Click to view finishes](#)

3 Select Edge

[Click to view edges](#)

4 Select Hardware

[Click to view details](#)

Rift
Mobile Pedestals
Box/File

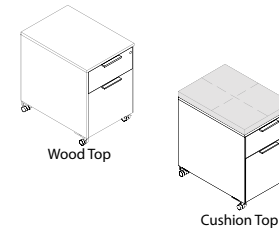

[Click here to view statement of line](#)

1 Select Model

w" x d" x h"
16 x 18 x 22

Weight
65

Standard Veneer Top Standard Veneer Chassis	Premium Veneer Top Premium Veneer Chassis	High Pressure Laminate Top Veneer Chassis	Thermally Fused Laminate Top Thermally Fused Laminate Chassis
"W" Option N/A	RFT1618PD423P 1541	"G" Option N/A	"M" Option N/A
	TBCO TBSW TSTV TSMV TSLV TOBW		
	Edge N/A		
	<p>PL-300 Matte Chrome PL-301 Matte Chrome PL-304 Matte Chrome PL-305 Matte Chrome</p>	<p>PL-302 White PL-303 White</p>	<p>PL-306 White PL-307 White</p>

Product Features

- Box drawers include divider
- Die cast designer casters
- Finished all sides
- Locking drawers
- Pedestals anti-tilt weighted
- Recessed front detailing

Options

Drawer

- WPD3061: Designer White - \$80 per pedestal

Cushion

- BC16: Bench cushion
- Specify fabric grade (1 yd. required)

BC16 Cushion fabric grades

COM	COL	1	2	3
224	N/A	261	279	297
4	5	6	7	8
315	333	351	369	387
9	10	11/ L1	12	13/ L2
405	423	441	459	495

2 Select Finish

[Click to view finishes](#)

3 Select Edge

[Click to view edges](#)

4 Select Hardware

[Click to view details](#)

Rift

Overhead Consoles Single Height
Hinged Wood Doors

[Click here to view statement of line](#)

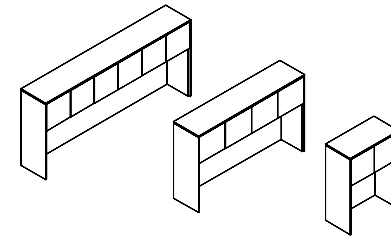

1 Select Model

w" x d" x h"	Weight
6 Door / 3 Section	
96 x 15 x 41	315
90 x 15 x 41	285
84 x 15 x 41	275
4 Door / 2 Section	
72 x 15 x 41	240
66 x 15 x 41	225
60 x 15 x 41	210
2 Door / 1 Section	
36 x 15 x 41	120
30 x 15 x 41	105

2 Select Finish

[Click to view finishes](#)

3 Select Edge

[Click to view edges](#)

4 Select Hardware

[Click to view details](#)

Standard Veneer Top Standard Veneer Chassis	Premium Veneer Top Premium Veneer Chassis	High Pressure Laminate Top Veneer Chassis	Thermally Fused Laminate Top Thermally Fused Laminate Chassis
"W" Option N/A	RFT9641OH325P 5007	"G" Option N/A	"M" Option N/A
"W" Option N/A	RFT9041OH325P 4837	"G" Option N/A	"M" Option N/A
"W" Option N/A	RFT8441OH325P 4585	"G" Option N/A	"M" Option N/A
"W" Option N/A	RFT7241OH325P 4304	"G" Option N/A	"M" Option N/A
"W" Option N/A	RFT6641OH325P 4162	"G" Option N/A	"M" Option N/A
"W" Option N/A	RFT6041OH325P 4024	"G" Option N/A	"M" Option N/A
"W" Option N/A	RFT3641OH325P 2773	"G" Option N/A	"M" Option N/A
"W" Option N/A	RFT3041OH325P 2669	"G" Option N/A	"M" Option N/A
	TBCO TBSW TSTV TSMV TSLV TOBW		
	Edge N/A		
	Hardware N/A		

Product Features

- 3/4" Thick back panel
- Finished top
- Interior cabinet depth 12.5"
- Touch latch
- 5/8" grommet(s) included for task light wire management

Notes

- Unit has black back panel and is not designed for Open Plan use. Select OPB Option for Open Plan application

Options

Door

- D2: Wood Door Lock - \$100 per door set
- D2-G: Door Lock for Glass Doors - \$205 per door set (only when RF375AW is ordered)
- D6: Delete Doors - n/c
- RF375AW: Aluminum/White Glass - \$390 per door
- WPD3061: Designer White - \$35 per door

Grommets (Vertical Surface)

- Standard Location - \$50 ea.
- Black Plastic Vertical Surface: TM50-C (Bottom Center)
- Non-Standard Location - \$95 ea.
- Black Plastic Vertical Surface: TM50-NS

Open Plan _ Finished Back

- OPB: Modify Unit for Open Plan Application - \$295

Task Light

- LT-LED24: 24" LED Task light - \$215
- LT-LED48: 48" LED Task light - \$270
- LT-LED60: 60" LED Task light - \$335
- LT-LED72: 72" LED Task light - \$360

Rift

Overhead Consoles Single Height
Sliding Wood Doors

[Click here to view statement of line](#)

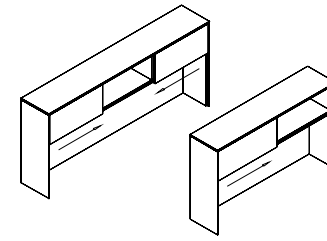

1 Select Model

w" x d" x h"	Weight
2 Door / 3 Section	
96 x 15 x 41	315
90 x 15 x 41	285
84 x 15 x 41	275
1 Door / 2 Section	
72 x 15 x 41	240
66 x 15 x 41	225
60 x 15 x 41	210

Standard Veneer Top Standard Veneer Chassis	Premium Veneer Top Premium Veneer Chassis	High Pressure Laminate Top Veneer Chassis	Thermally Fused Laminate Top Thermally Fused Laminate Chassis
"W" Option N/A	RFT9641OH869P 5287	"G" Option N/A	"M" Option N/A
"W" Option N/A	RFT9041OH869P 5119	"G" Option N/A	"M" Option N/A
"W" Option N/A	RFT8441OH869P 4864	"G" Option N/A	"M" Option N/A
"W" Option N/A	RFT7241OH869P 4514	"G" Option N/A	"M" Option N/A
"W" Option N/A	RFT6641OH869P 4375	"G" Option N/A	"M" Option N/A
"W" Option N/A	RFT6041OH869P 4235	"G" Option N/A	"M" Option N/A
TBCO TBSW TSTV TSMV TSLV TOBW			
Edge N/A			
Hardware N/A			

Product Features

- 3/4" Thick back panel
- Finished top
- Interior cabinet depth 12.5"
- 5/8" grommet(s) included for task light wire management

Notes

- Unit has black back panel and is not designed for Open Plan use. Select OPB Option for Open Plan application

Options

Door

- RF550AW: Aluminum/White Glass - \$575 per door
- WPD3061: Designer White - \$35 per door

Interior Cabinet Lighting

- LEDPK starter kit includes Infeed, 1 Puck Interior Light and the ability to daisy chain up to 6 total Puck Lights
- LEDPK: LED Puck Starter Kit - \$310
- PK: 1 LED Interior Light - \$130

Open Plan _ Finished Back

- OPB: Modify Unit for Open Plan Application - \$295

Task Light

- LT-LED24: 24" LED Task light - \$215
- LT-LED48: 48" LED Task light - \$270
- LT-LED60: 60" LED Task light - \$335
- LT-LED72: 72" LED Task light - \$360

2 Select Finish

[Click to view finishes](#)

3 Select Edge

[Click to view edges](#)

4 Select Hardware

[Click to view details](#)

Rift

Overhead Consoles Double Height
Hinged Wood Doors

[Click here to view statement of line](#)

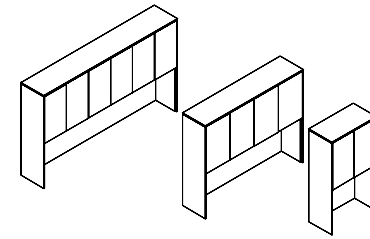

1 Select Model

w" x d" x h"	Weight
6 Door / 3 Section	
96 x 15 x 54	320
90 x 15 x 54	300
84 x 15 x 54	280
4 Door / 2 Section	
72 x 15 x 54	240
66 x 15 x 54	220
60 x 15 x 54	200
2 Door / 1 Section	
36 x 15 x 54	120
30 x 15 x 54	100

2 Select Finish

[Click to view finishes](#)

3 Select Edge

[Click to view edges](#)

4 Select Hardware

[Click to view details](#)

Standard Veneer Top Standard Veneer Chassis	Premium Veneer Top Premium Veneer Chassis	High Pressure Laminate Top Veneer Chassis	Thermally Fused Laminate Top Thermally Fused Laminate Chassis
"W" Option N/A	RFT9654OH325P 5708	"G" Option N/A	"M" Option N/A
"W" Option N/A	RFT9054OH325P 5398	"G" Option N/A	"M" Option N/A
"W" Option N/A	RFT8454OH325P 5258	"G" Option N/A	"M" Option N/A
"W" Option N/A	RFT7254OH325P 4864	"G" Option N/A	"M" Option N/A
"W" Option N/A	RFT6654OH325P 4725	"G" Option N/A	"M" Option N/A
"W" Option N/A	RFT6054OH325P 4585	"G" Option N/A	"M" Option N/A
"W" Option N/A	RFT3654OH325P 3056	"G" Option N/A	"M" Option N/A
"W" Option N/A	RFT3054OH325P 2949	"G" Option N/A	"M" Option N/A
	TBCO TBSW TSTV TSMV TSLV TOBW		
	Edge N/A		
	Hardware N/A		

Product Features

- 3/4" Thick back panel
- Adjustable finished shelf behind each door section
- Black painted top
- Interior shelf depth 12.5"
- Touch latch
- 5/8" grommet(s) included for task light wire management

Notes

- Unit has black back panel and is not designed for Open Plan use. Select OPB Option for Open Plan application

Options

Door

- D2: Wood Door Lock - \$100 per door set
- D2-G: Door Lock for Glass Doors - \$205 per door set (only when RF475AW is ordered)
- D6: Delete Doors - n/c
- RF475AW: Aluminum/White Glass - \$495 per door
- WPD3061: Designer White - \$55 per door

Interior Cabinet Lighting

- LEDPK starter kit includes Infeed, 1 Puck Interior Light and the ability to daisy chain up to 6 total Puck Lights
- LEDPK: LED Puck Starter Kit - \$310
- PK: 1 LED Interior Light - \$130

Task Light

- LT-LED24: 24" LED Task light - \$215
- LT-LED48: 48" LED Task light - \$270
- LT-LED60: 60" LED Task light - \$335
- LT-LED72: 72" LED Task light - \$360

Open Plan _ Finished Back

- OPB: Modify Unit for Open Plan Application - \$295

Shelf

- GS14F: Replace Standard Shelves with Glass Shelves - \$90 per shelf
- S714F: Replace Standard Shelf with Heavy Duty Lumber 1" Shelf - \$80 per shelf

DARRAN®

Overhead tackboard
Full width tackboards

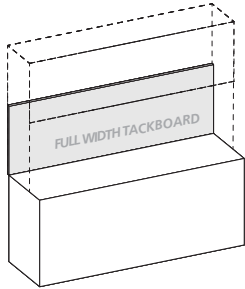

Product Width	Panel Dimension	SKU	COM	1	2	3	4	5	6	7	8	9	10	11/L1	12	13/L2
96	94 x .75 x 26	FTOC9426	389	495	548	601	654	707	760	813	866	919	972	1025	1078	1184
90	88 x .75 x 26	FTOC8826	368	464	513	562	611	660	709	758	807	856	905	954	1003	1101
84	82 x .75 x 26	FTOC8226	336	428	474	520	566	612	658	704	750	796	842	888	934	1026
72	70 x .75 x 26	FTOC7026	292	371	412	453	494	535	576	617	658	699	740	781	822	904
66	64 x .75 x 26	FTOC6426	264	340	377	414	451	488	525	562	599	636	673	710	747	821
60	58 x .75 x 26	FTOC5826	242	309	342	375	408	441	474	507	540	573	606	639	672	738
36	34 x .75 x 26	FTOC3426	148	186	207	228	249	270	291	312	333	354	375	396	417	459
30	28 x .75 x 26	FTOC2826	115	154	172	190	208	226	244	262	280	298	316	334	352	388

Standard Features

- Constructed of .5" thick fiberboard
- Fabric is precisely aligned and fitted to the tackboard
- Adhered to the rigid hardboard with staples
- Hung with Z-Strip mounting system

Notes

- Fabric Tack Panels are raised 3" from bottom edge when TM50 grommet is ordered.

Overhead tackboard
Half width tackboards

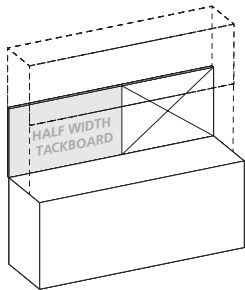

Product Width	Panel Dimension	SKU	COM	1	2	3	4	5	6	7	8	9	10	11/L1	12	13/L2
96 Half Width	47 x .75 x 26	FTOC4726	194	247	273	299	325	351	377	403	429	455	481	507	533	585
90 Half Width	44 x .75 x 26	FTOC4426	184	232	257	282	307	332	357	382	407	432	457	482	507	557
84 Half Width	41 x .75 x 26	FTOC4126	168	214	237	260	283	306	329	352	375	398	421	444	467	513
72 Half Width	35 x .75 x 26	FTOC3526	147	186	206	226	246	266	286	306	326	346	366	386	406	446
66 Half Width	32 x .75 x 26	FTOC3226	132	170	188	206	224	242	260	278	296	314	332	350	368	404
60 Half Width	29 x .75 x 26	FTOC2926	122	155	171	187	203	219	235	251	267	283	299	315	331	363

Standard Features

- Constructed of .5" thick fiberboard
- Fabric is precisely aligned and fitted to the tackboard
- Adhered to the rigid hardboard with staples
- Hung with Z-Strip mounting system

Notes

- Half width tackboards can be specified and combined with a Veneer Panel, Marker Board, Slat Wall or Glass Board. See "Half Width" items under product width.
- Specify right or left facing tackboard
- Fabric Tack Panels are raised 3" from bottom edge when TM50 grommet is ordered.

DARRAN®

Overhead dry marker board
Full width dry marker board

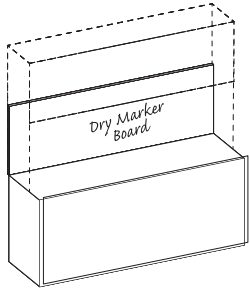

Product Width	Panel Dimension	SKU	List
96	94 x .5 x 26	DMOC9426	1173
90	88 x .5 x 26	DMOC8826	1098
84	82 x .5 x 26	DMOC8226	1023
72	70 x .5 x 26	DMOC7026	874
66	64 x .5 x 26	DMOC6426	799
60	58 x .5 x 26	DMOC5826	724
36	34 x .5 x 26	DMOC3426	399
30	28 x .5 x 26	DMOC2826	349

Standard Features

- Dry marker panel has edge trim molding
- Standard magnetic surface
- Hung with Z-Strip mounting system

Overhead dry marker board
Half width dry marker board

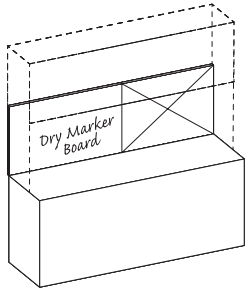

Product Width	Panel Dimension	SKU	List
96 Half Width	47 x .5 x 26	DMOC4726	574
90 Half Width	44 x .5 x 26	DMOC4426	537
84 Half Width	41 x .5 x 26	DMOC4126	499
72 Half Width	35 x .5 x 26	DMOC3526	424
66 Half Width	32 x .5 x 26	DMOC3226	387
60 Half Width	29 x .5 x 26	DMOC2926	349

Standard Features

- Dry marker panel has edge trim molding
- Standard magnetic surface
- Hung with Z-Strip mounting system

Notes

- Half width dry marker boards can be specified and combined with a Tackboard, Veneer Panel, Slat Wall or Glass Board. See "Half Width" items under product width.
- Specify right or left facing dry marker board

DARRAN®

Overhead glassboard Full width glassboards

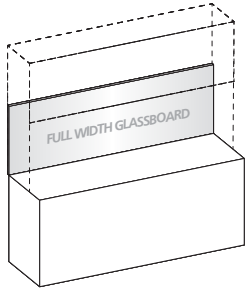

Product Width	Panel Dimension	SKU	List
96	94 x .5 x 26	GBOC9426	2651
90	88 x .5 x 26	GBOC8826	2494
84	82 x .5 x 26	GBOC8226	2337
72	70 x .5 x 26	GBOC7026	2021
66	64 x .5 x 26	GBOC6426	1864
60	58 x .5 x 26	GBOC5826	1732
36	34 x .5 x 26	GBOC3426	1080
30	28 x .5 x 26	GBOC2826	924

Standard Features

- 4 mm tempered glass

Notes

- Use glass cleaner or alcohol to clean
- Standard dry erase markers may be used
- Earth magnets are required to hold items securely in place
- Hung with Z-Strip mounting system

Overhead glassboard Half width glassboards

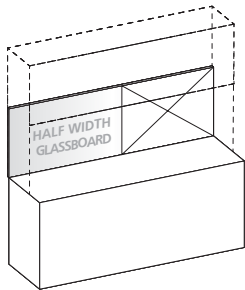

Product Width	Panel Dimension	SKU	List
96 Half Width	47 x .5 x 26	GBOC4726	1325
90 Half Width	45 x .5 x 26	GBOC4526	1247
84 Half Width	41 x .5 x 26	GBOC4126	1169
72 Half Width	35 x .5 x 26	GBOC3526	1011
66 Half Width	32 x .5 x 26	GBOC3226	932
60 Half Width	29 x .5 x 26	GBOC2926	866

Standard Features

- 4 mm tempered glass
- Hung with Z-Strip mounting system

Notes

- Half width glassboards can be specified and combined with a Tackboard, Veneer panel, Marker Board or Slat Wall. See "Half Width" items under product width.
- Must specify Right or left facing glassboard
- Use glass cleaner or alcohol to clean
- Standard dry erase markers may be used
- Earth magnets are required to hold items securely in place

Overhead slat wall
Half width slat wall

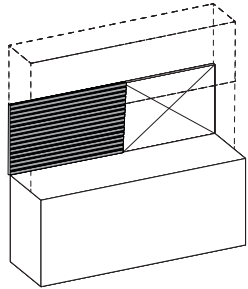

Product Width	Panel Dimension	SKU	List
96 Half Width	47 x .5 x 26	SWOC4726	463
90 Half Width	44 x .5 x 26	SWOC4426	432
84 Half Width	41 x .5 x 26	SWOC4126	411
72 Half Width	35 x .5 x 26	SWOC3526	374
66 Half Width	32 x .5 x 26	SWOC3226	343
60 Half Width	29 x .5 x 26	SWOC2926	300

Standard Features

- Available in silver or black
- For use on 42"/43" height consoles
- Hung with Z-Strip mounting system

Notes

- Half width slat walls can be specified and combined with a Tackboard, Veneer panel, Marker Board or Glassboard. See "Half Width" items under product width.
- Specify right or left facing slat wall
- For use on 42"/43" height consoles

Rift

Wall Hung Storage Single Height
Hinged Wood Doors

[Click here to view statement of line](#)

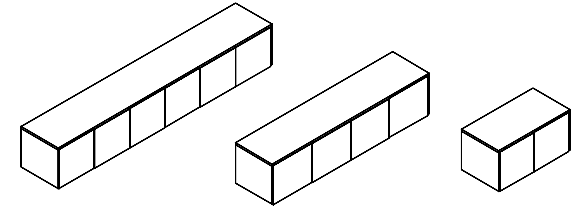

1 Select Model

w" x d" x h"	Weight
6 Door / 3 Section	
96 x 15 x 15	240
90 x 15 x 15	225
84 x 15 x 15	210
4 Door / 2 Section	
72 x 15 x 15	180
66 x 15 x 15	160
60 x 15 x 15	135
2 Door / 1 Section	
36 x 15 x 15	75
30 x 15 x 15	65

	Standard Veneer Top Standard Veneer Chassis	Premium Veneer Top Premium Veneer Chassis	High Pressure Laminate Top Veneer Chassis	Thermally Fused Laminate Top Thermally Fused Laminate Chassis
		RFT9615WH330P 4960	"G" Option N/A	"M" Option N/A
	"W" Option N/A	RFT9015WH330P 4791	"G" Option N/A	"M" Option N/A
	"W" Option N/A	RFT8415WH330P 4538	"G" Option N/A	"M" Option N/A
		RFT7215WH330P 4257	"G" Option N/A	"M" Option N/A
	"W" Option N/A	RFT6615WH330P 4117	"G" Option N/A	"M" Option N/A
	"W" Option N/A	RFT6015WH330P 3976	"G" Option N/A	"M" Option N/A
		RFT3615WH330P 2842	"G" Option N/A	"M" Option N/A
	"W" Option N/A	RFT3015WH330P 2761	"G" Option N/A	"M" Option N/A
		TBCO		
		TBSW		
		TSTV		
		TSMV		
		TSLV		
		TOBW		
		Edge N/A		
		Hardware N/A		

2 Select Finish

[Click to view finishes](#)

3 Select Edge

[Click to view edges](#)

4 Select Hardware

[Click to view details](#)

Product Features

- Finished top
- Interior cabinet depth 12"
- Touch latch

Notes

- The DARRAN wall mounted cabinet(or shelf) must be hung on a weight-bearing wall. The suitability of the wall supporting the wall mounted cabinet, and the installation and maintenance of the wall-mounted cabinet, is the sole responsibility of the customer. Failure to correctly install and/or exceed the loaded weight capacity of this product may cause it to fall, resulting in damage to the product, adjacent property and/or bodily injury.

Options

Door

- D2: Wood Door Lock - \$100 per door set
- D2-G: Door Lock for Glass Doors - \$205 per door set (only when RF375AW is ordered)
- D6: Delete Doors - n/c
- RF375AW: Aluminum/White Glass - \$390 per door
- WPD3061: Designer White - \$35 per door

Task Light

- LT-LED24: 24" LED Task light - \$215
- LT-LED48: 48" LED Task light - \$270
- LT-LED60: 60" LED Task light - \$335
- LT-LED72: 72" LED Task light - \$360

Rift

Wall Hung Storage Single Height Sliding Wood Doors

[Click here to view statement of line](#)

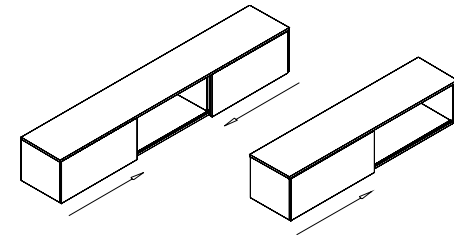

1 Select Model

w" x d" x h"	Weight
3 Section	
96 x 15 x 15	240
90 x 15 x 15	225
84 x 15 x 15	210
2 Section	
72 x 15 x 15	180
66 x 15 x 15	100
60 x 15 x 15	135

	Standard Veneer Top Standard Veneer Chassis	Premium Veneer Top Premium Veneer Chassis	High Pressure Laminate Top Veneer Chassis	Thermally Fused Laminate Top Thermally Fused Laminate Chassis
	"W" Option N/A	RFT9615WH872P 5240	"G" Option N/A	"M" Option N/A
	"W" Option N/A	RFT9015WH872P 5071	"G" Option N/A	"M" Option N/A
	"W" Option N/A	RFT8415WH872P 4819	"G" Option N/A	"M" Option N/A
	"W" Option N/A	RFT7215WH872P 4467	"G" Option N/A	"M" Option N/A
	"W" Option N/A	RFT6615WH872P 4328	"G" Option N/A	"M" Option N/A
	"W" Option N/A	RFT6015WH872P 4187	"G" Option N/A	"M" Option N/A
		TBCO TBSW TSTV TSMV TSLV TOBW		
		Edge N/A		
		Hardware N/A		

2 Select Finish

[Click to view finishes](#)

3 Select Edge

[Click to view edges](#)

4 Select Hardware

[Click to view details](#)

Product Features

- Finished top
- Interior cabinet depth 12"

Notes

- The DARRAN wall mounted cabinet(or shelf) must be hung on a weight-bearing wall. The suitability of the wall supporting the wall mounted cabinet, and the installation and maintenance of the wall-mounted cabinet, is the sole responsibility of the customer. Failure to correctly install and/or exceed the loaded weight capacity of this product may cause it to fall, resulting in damage to the product, adjacent property and/or bodily injury.

Options

Door

- RF550AW: Aluminum/White Glass - \$575 per door
- WPD3061: Designer White - \$35 per door

Interior Cabinet Lighting

- LEDPK starter kit includes Infeed, 1 Puck Interior Light and the ability to daisy chain up to 6 total Puck Lights
- LEDPK: LED Puck Starter Kit - \$310
- PK: 1 LED Interior Light - \$130

Task Light

- LT-LED24: 24" LED Task light - \$215
- LT-LED48: 48" LED Task light - \$270
- LT-LED60: 60" LED Task light - \$335
- LT-LED72: 72" LED Task light - \$360

Rift

Wall Hung Storage Double Height
Hinged Wood Doors

[Click here to view statement of line](#)

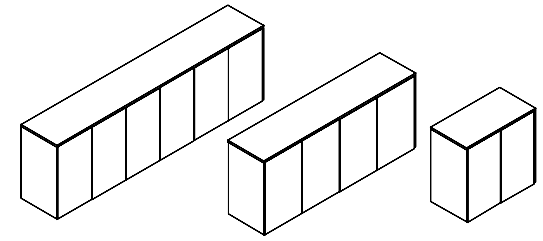

1 Select Model

w" x d" x h"	Weight
6 Door / 3 Section	
96 x 15 x 28.3	295
90 x 15 x 28.3	275
84 x 15 x 28.3	260
4 Door / 2 Section	
72 x 15 x 28.3	220
66 x 15 x 28.3	200
60 x 15 x 28.3	180
2 Door / 1 Section	
36 x 15 x 28.3	110
30 x 15 x 28.3	95

2 Select Finish

[Click to view finishes](#)

3 Select Edge

[Click to view edges](#)

4 Select Hardware

[Click to view details](#)

	Standard Veneer Top Standard Veneer Chassis	Premium Veneer Top Premium Veneer Chassis	High Pressure Laminate Top Veneer Chassis	Thermally Fused Laminate Top Thermally Fused Laminate Chassis
"W" Option N/A	RFT9628WH330P	5661	"G" Option N/A	"M" Option N/A
"W" Option N/A	RFT9028WH330P	5352	"G" Option N/A	"M" Option N/A
"W" Option N/A	RFT8428WH330P	5212	"G" Option N/A	"M" Option N/A
"W" Option N/A	RFT7228WH330P	4819	"G" Option N/A	"M" Option N/A
"W" Option N/A	RFT6628WH330P	4678	"G" Option N/A	"M" Option N/A
"W" Option N/A	RFT6028WH330P	4538	"G" Option N/A	"M" Option N/A
"W" Option N/A	RFT3628WH330P	3148	"G" Option N/A	"M" Option N/A
"W" Option N/A	RFT3028WH330P	3042	"G" Option N/A	"M" Option N/A
TBCO				
TBSW				
TSTV				
TSMV				
TSLV				
TOBW				
Edge N/A				
Hardware N/A				

Product Features

- Adjustable veneer shelf per door section
- Black painted top
- Interior cabinet depth 12"
- Touch latch

Notes

- The DARRAN wall mounted cabinet(or shelf) must be hung on a weight-bearing wall. The suitability of the wall supporting the wall mounted cabinet, and the installation and maintenance of the wall-mounted cabinet, is the sole responsibility of the customer. Failure to correctly install and/or exceed the loaded weight capacity of this product may cause it to fall, resulting in damage to the product, adjacent property and/or bodily injury.

Options

Door

- D2: Wood Door Lock - \$100 per door set
- D2-G: Door Lock for Glass Doors - \$205 per door set (only when RF475AW is ordered)
- D6: Delete Doors - n/c
- RF475AW: Aluminum/White Glass - \$495 per door
- WPD3061: Designer White - \$55 per door

Interior Cabinet Lighting

- LEDPK starter kit includes Infeed, 1 Puck Interior Light and the ability to daisy chain up to 6 total Puck Lights
- LEDPK: LED Puck Starter Kit - \$310
- PK: 1 LED Interior Light - \$130

Shelf

- GS14F: Replace Standard Shelves with Glass Shelves - \$90 per shelf
- S714F: Heavy Duty Lumber 1" Shelves - \$80 per shelf

Task Light

- LT-LED24: 24" LED Task light - \$215
- LT-LED48: 48" LED Task light - \$270
- LT-LED60: 60" LED Task light - \$335
- LT-LED72: 72" LED Task light - \$360

Rift

Wall Hung Storage Double Height Sliding Wood Doors

[Click here to view statement of line](#)

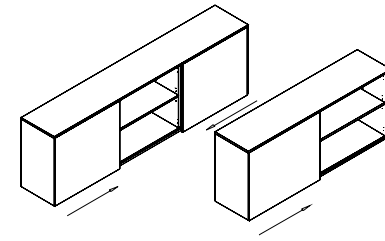

1 Select Model

w" x d" x h"	Weight
3 Section	
96 x 15 x 28.3	290
90 x 15 x 28.3	270
84 x 15 x 28.3	255
2 Section	
72 x 15 x 28.3	215
66 x 15 x 28.3	195
60 x 15 x 28.3	175

	Standard Veneer Top Standard Veneer Chassis	Premium Veneer Top Premium Veneer Chassis	High Pressure Laminate Top Veneer Chassis	Thermally Fused Laminate Top Thermally Fused Laminate Chassis
"W" Option N/A	RFT9628WH872P	5942	"G" Option N/A	"M" Option N/A
"W" Option N/A	RFT9028WH872P	5634	"G" Option N/A	"M" Option N/A
"W" Option N/A	RFT8428WH872P	5493	"G" Option N/A	"M" Option N/A
"W" Option N/A	RFT7228WH872P	5029	"G" Option N/A	"M" Option N/A
"W" Option N/A	RFT6628WH872P	4889	"G" Option N/A	"M" Option N/A
"W" Option N/A	RFT6028WH872P	4749	"G" Option N/A	"M" Option N/A
TBCO				
TBSW				
TSTV				
TSMV				
TSLV				
TOBW				
Edge N/A				
Hardware N/A				

2 Select Finish

[Click to view finishes](#)

3 Select Edge

[Click to view edges](#)

4 Select Hardware

[Click to view details](#)

Product Features

- Adjustable shelf per door section
- Black painted top
- Interior cabinet depth 12"

Notes

- The DARRAN wall mounted cabinet(or shelf) must be hung on a weight-bearing wall. The suitability of the wall supporting the wall mounted cabinet, and the installation and maintenance of the wall-mounted cabinet, is the sole responsibility of the customer. Failure to correctly install and/or exceed the loaded weight capacity of this product may cause it to fall, resulting in damage to the product, adjacent property and/or bodily injury.

Options

Door

- RF850AW: Aluminum/White Glass - \$885 per door
- WPD3061: Designer White - \$55 per door

Interior Cabinet Lighting

- LEDPK starter kit includes Infeed, 1 Puck Interior Light and the ability to daisy chain up to 6 total Puck Lights
- LEDPK: LED Puck Starter Kit - \$310
- PK: 1 LED Interior Light - \$130

Shelf

- GS14F: Replace Standard Shelves with Glass Shelves - \$90 per shelf
- S714F: Heavy Duty Lumber 1" Shelves - \$80 per shelf

Task Light

- LT-LED24: 24" LED Task light - \$215
- LT-LED48: 48" LED Task light - \$270
- LT-LED60: 60" LED Task light - \$335
- LT-LED72: 72" LED Task light - \$360

DARRAN®

Wall hung tackboards Full width tackboards

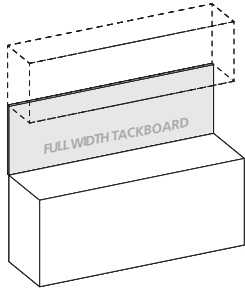

Product Width	Panel Dimension	SKU	COM	1	2	3	4	5	6	7	8	9	10	11/L1	12	13/L2
96	96 x .75 x 26	FTWH9626	484	599	654	709	764	820	875	930	985	1040	1095	1150	1205	1316
90	90 x .75 x 26	FTWH9026	457	562	614	665	717	768	820	870	922	973	1025	1076	1128	1231
84	84 x .75 x 26	FTWH8426	422	518	566	614	661	709	757	805	853	901	948	996	1044	1140
72	72 x .75 x 26	FTWH7226	366	449	493	536	579	622	666	708	752	795	838	881	925	1011
66	66 x .75 x 26	FTWH6626	339	412	451	491	530	570	609	649	688	728	768	807	847	926
60	60 x .75 x 26	FTWH6026	297	374	410	445	480	516	551	587	622	657	693	728	763	834
36	36 x .75 x 26	FTWH3626	181	225	245	266	287	308	329	349	370	391	412	433	453	495
30	30 x .75 x 26	FTWH3026	149	187	205	223	240	258	276	293	311	329	346	364	382	417

Standard Features

- Constructed of .5" thick fiberboard
- Fabric is precisely aligned and fitted to the tackboard
- Adhered to the rigid hardboard with staples
- Hung with Z-Strip mounting system

Wall hung tackboards Half width tackboards

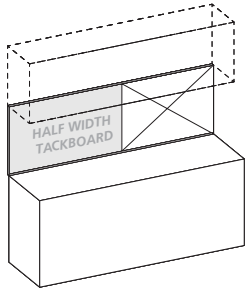

Product Width	Panel Dimension	SKU	COM	1	2	3	4	5	6	7	8	9	10	11/L1	12	13/L2
96 Half Width	48 x .75 x 26	FTWH4826	242	309	336	363	390	417	444	471	498	525	552	579	606	660
90 Half Width	45 x .75 x 26	FTWH4526	229	290	316	342	368	394	420	446	472	498	524	550	576	628
84 Half Width	42 x .75 x 26	FTWH4226	211	267	291	315	339	363	387	411	435	459	483	507	531	579
72 Half Width	36 x .75 x 26	FTWH3626	183	232	254	276	298	320	342	364	386	408	430	452	474	518
66 Half Width	33 x .75 x 26	FTWH3326	170	213	232	251	270	289	308	327	346	365	384	403	422	460
60 Half Width	30 x .75 x 26	FTWH3026	149	193	211	229	247	265	283	301	319	337	355	373	391	427

Standard Features

- Constructed of .5" thick fiberboard
- Fabric is precisely aligned and fitted to the tackboard
- Adhered to the rigid hardboard with staples
- Hung with Z-Strip mounting system

Notes

- Half width tackboards can be specified and combined with a Veneer Panel, Marker Board, Slat Wall or Glass Board. See "Half Width" items under product width.
- Specify right or left facing tackboard

DARRAN®

Wall hung dry marker board
Full width dry marker board

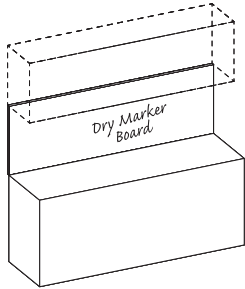

Product Width	Panel Dimension	SKU	List
96	96 x .75 x 26	DMWH9626	1198
90	90 x .75 x 26	DMWH9026	1123
84	84 x .75 x 26	DMWH8426	1048
72	72 x .75 x 26	DMWH7226	899
66	66 x .75 x 26	DMWH6626	824
60	60 x .75 x 26	DMWH6026	749
36	36 x .75 x 26	DMWH3626	449
30	30 x .75 x 26	DMWH3026	374

Standard Features

- Dry marker panel has edge trim molding
- Standard magnetic surface
- Hung with Z-Strip mounting system

Wall hung dry marker board
Half width dry marker board

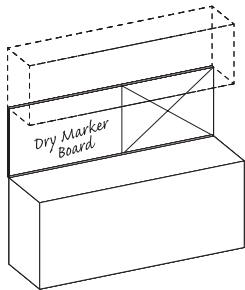

Product Width	Panel Dimension	SKU	List
96 Half Width	48 x .75 x 26	DMWH4826	599
90 Half Width	45 x .75 x 26	DMWH4526	562
84 Half Width	42 x .75 x 26	DMWH4226	524
72 Half Width	36 x .75 x 26	DMWH3626	449
66 Half Width	33 x .75 x 26	DMWH3326	412
60 Half Width	30 x .75 x 26	DMWH3026	374

Standard Features

- Dry marker panel has edge trim molding
- Standard magnetic surface
- Hung with Z-Strip mounting system

Notes

- Half width dry marker boards can be specified and combined with a Tackboard, Veneer Panel, Slat Wall or Glass Board. See "Half Width" items under product width.
- Specify right or left facing dry marker board

Wall hung veneer panel
Full width veneer panel

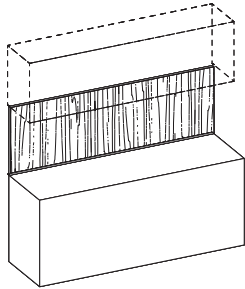

Product Width	Panel Dimension	SKU	List
96	96 x .75 x 26	VPWH9626	998
90	90 x .75 x 26	VPWH9026	936
84	84 x .75 x 26	VPWH8426	874
72	72 x .75 x 26	VPWH7226	749
66	66 x .75 x 26	VPWH6626	686
60	60 x .75 x 26	VPWH6026	624
36	36 x .75 x 26	VPWH3626	374
30	30 x .75 x 26	VPWH3026	312

Standard Features

- Veneer edges

Notes

- Vertical wire channels on back for task light cords
- Steel mounting wall channel is recessed for flush mounting
- Hung with Z-Strip mounting system
- Can be used with or without overhead cabinet
- Required for other accessory panels

Wall hung veneer panel
Half width veneer panels

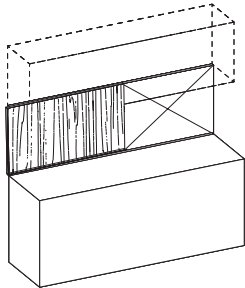

Product Width	Panel Dimension	SKU	List
96 Half Width	48 x .75 x 26	VPWH4826	499
90 Half Width	45 x .75 x 26	VPWH4526	468
84 Half Width	42 x .75 x 26	VPWH4226	437
72 Half Width	36 x .75 x 26	VPWH3626	374
66 Half Width	33 x .75 x 26	VPWH3326	343
60 Half Width	30 x .75 x 26	VPWH3026	312

Standard Features

- Veneer edges
- Vertical wire channels on back for task light cords
- Steel mounting wall channel is recessed for flush mounting
- Hung with Z-Strip mounting system

Notes

- Half width veneer panels can be specified and combined with a Tackboard, Marker Board, Slat Wall or Glass Board. See "Half Width" items under product width.
- Specify right or left facing veneer panel
- Can be used with or without overhead cabinet
- Required for other accessory panels

Wall hung glassboard
Full width glassboards

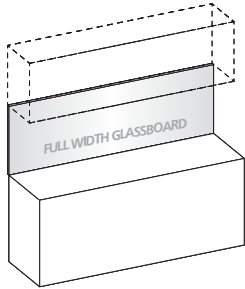

Product Width	Panel Dimension	SKU	List
96	96 x .75 x 26	GBWH9626	3063
90	90 x .75 x 26	GBWH9026	2883
84	84 x .75 x 26	GBWH8426	2706
72	72 x .75 x 26	GBWH7226	2348
66	66 x .75 x 26	GBWH6626	2168
60	60 x .75 x 26	GBWH6026	2012
36	36 x .75 x 26	GBWH3626	1268
30	30 x .75 x 26	GBWH3026	1090

Standard Features

- 4 mm tempered glass

Notes

- Use glass cleaner or alcohol to clean
- Standard dry erase markers may be used
- Earth magnets are required to hold items securely in place
- Hung with Z-Strip mounting system

Wall hung glassboard
Half width glassboards

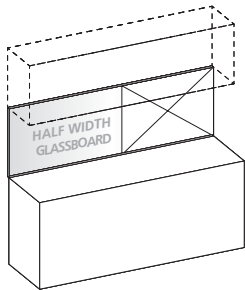

Product Width	Panel Dimension	SKU	List
96 Half Width	48 x .75 x 26	GBWH4826	1532
90 Half Width	45 x .75 x 26	GBWH4526	1442
84 Half Width	42 x .75 x 26	GBWH4226	1353
72 Half Width	36 x .75 x 26	GBWH3626	1175
66 Half Width	33 x .75 x 26	GBWH3326	1085
60 Half Width	30 x .75 x 26	GBWH3026	1007

Standard Features

- 4 mm tempered glass
- Hung with Z-Strip mounting system

Notes

- Half width glassboards can be specified and combined with a Tackboard, Veneer panel, Marker Board or Slat Wall. See "Half Width" items under product width.
- Specify right or left facing glassboard
- Use glass cleaner or alcohol to clean
- Standard dry erase markers may be used
- Earth magnets are required to hold items securely in place

Wall hung slat wall
Half width slat board

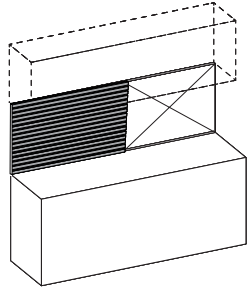

Product Width	Panel Dimension	SKU	List
96 Half Width	48 x .75 x 26	SWWH4826	499
90 Half Width	45 x .75 x 26	SWWH4526	468
84 Half Width	42 x .75 x 26	SWWH4226	437
72 Half Width	36 x .75 x 26	SWWH3626	374
66 Half Width	33 x .75 x 26	SWWH3326	343
60 Half Width	30 x .75 x 26	SWWH3026	312

Standard Features

- Available in silver or black
- Hung with Z-Strip mounting system

Notes

- Half width slat walls can be specified and combined with a Tackboard, Veneer panel, Marker Board or Glassboard. See "Half Width" items under product width.
- Specify right or left facing slat wall
- For use on 42"/43" height consoles

Rift

Floating Wall Mounted Shelf Single Shelf

[Click here to view statement of line](#)

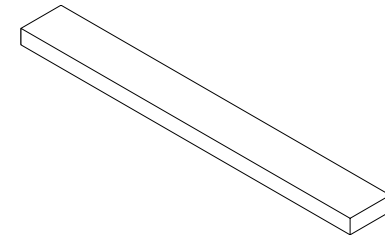

1 Select Model

w" x d" x h"

Weight

96 x 9 x 1	22
90 x 9 x 1	21
84 x 9 x 1	19
72 x 9 x 1	16
66 x 9 x 1	15
60 x 9 x 1	14
36 x 9 x 1	8
30 x 9 x 1	7

Standard Veneer Top Standard Veneer Chassis	Premium Veneer Top Premium Veneer Chassis	High Pressure Laminate Top Veneer Chassis	Thermally Fused Laminate Top Thermally Fused Laminate Chassis
"W" Option N/A	RFT9608WH338P 923	"G" Option N/A	"M" Option N/A
"W" Option N/A	RFT9008WH338P 874	"G" Option N/A	"M" Option N/A
"W" Option N/A	RFT8408WH338P 827	"G" Option N/A	"M" Option N/A
"W" Option N/A	RFT7208WH338P 743	"G" Option N/A	"M" Option N/A
"W" Option N/A	RFT6608WH338P 696	"G" Option N/A	"M" Option N/A
"W" Option N/A	RFT6008WH338P 650	"G" Option N/A	"M" Option N/A
"W" Option N/A	RFT3608WH338P 465	"G" Option N/A	"M" Option N/A
"W" Option N/A	RFT3008WH338P 420	"G" Option N/A	"M" Option N/A
	TBCO TBSW TSTV TSMV TSLV TOBW		
	Edge N/A		
	Hardware N/A		

Product Features

- Wall brackets included
- Wall brackets provide horizontal and vertical adjustments

Notes

- The DARRAN wall mounted cabinet(or shelf) must be hung on a weight-bearing wall. The suitability of the wall supporting the wall mounted cabinet, and the installation and maintenance of the wall-mounted cabinet, is the sole responsibility of the customer. Failure to correctly install and/or exceed the loaded weight capacity of this product may cause it to fall, resulting in damage to the product, adjacent property and/or bodily injury.
- 96" shelf will support 28lbs of additional weight, 90" shelf will support 29lbs, 84" shelf will support 31lbs, 72" shelf will support 24lbs, 66" shelf will support 25lbs, 60" shelf will support 16lbs, 36" shelf will support 12lbs, 30" shelf will support 13lbs.

2 Select Finish

[Click to view finishes](#)

3 Select Edge

[Click to view edges](#)

4 Select Hardware

[Click to view details](#)

Rift

Wall Hung Open Shelf
Single Height - 19"/15"H

[Click here to view statement of line](#)

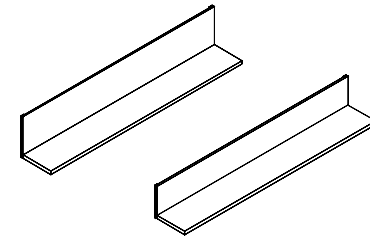

1 Select Model

w" x d" x h"	Weight
19" Height	
96 x 9 x 18.8	105
90 x 9 x 18.8	100
72 x 9 x 18.8	80
66 x 9 x 18.8	75
60 x 9 x 18.8	65
36 x 9 x 18.8	40
30 x 9 x 18.8	35
15" Height	
96 x 9 x 15.3	100
90 x 9 x 15.3	95
72 x 9 x 15.3	75
66 x 9 x 15.3	70
60 x 9 x 15.3	60
36 x 9 x 15.3	35
30 x 9 x 15.3	30

Standard Veneer Top Standard Veneer Chassis	Premium Veneer Top Premium Veneer Chassis	High Pressure Laminate Top Veneer Chassis	Thermally Fused Laminate Top Thermally Fused Laminate Chassis
"W" Option N/A	RFT9619WH336P 3878	"G" Option N/A	"M" Option N/A
"W" Option N/A	RFT9019WH336P 3738	"G" Option N/A	"M" Option N/A
"W" Option N/A	RFT7219WH336P 3036	"G" Option N/A	"M" Option N/A
"W" Option N/A	RFT6619WH336P 2763	"G" Option N/A	"M" Option N/A
"W" Option N/A	RFT6019WH336P 2825	"G" Option N/A	"M" Option N/A
"W" Option N/A	RFT3619WH336P 1773	"G" Option N/A	"M" Option N/A
"W" Option N/A	RFT3019WH336P 1666	"G" Option N/A	"M" Option N/A
"W" Option N/A	RFT9615WH336P 3506	"G" Option N/A	"M" Option N/A
"W" Option N/A	RFT9015WH336P 3364	"G" Option N/A	"M" Option N/A
"W" Option N/A	RFT7215WH336P 2663	"G" Option N/A	"M" Option N/A
"W" Option N/A	RFT6615WH336P 2555	"G" Option N/A	"M" Option N/A
"W" Option N/A	RFT6015WH336P 2455	"G" Option N/A	"M" Option N/A
"W" Option N/A	RFT3615WH336P 1399	"G" Option N/A	"M" Option N/A
"W" Option N/A	RFT3015WH336P 1293	"G" Option N/A	"M" Option N/A
	TBCO TBSW TSTV TSMV TSLV TOBW		
	Edge N/A		
	Hardware N/A		

Product Features

Notes

- Max weight capacity 36 lbs per 1 FT width
- The DARRAN wall mounted cabinet(or shelf) must be hung on a weight-bearing wall. The suitability of the wall supporting the wall mounted cabinet, and the installation and maintenance of the wall-mounted cabinet, is the sole responsibility of the customer. Failure to correctly install and/or exceed the loaded weight capacity of this product may cause it to fall, resulting in damage to the product, adjacent property and/or bodily injury.

Options

Task Light

- LT-LED24: 24" LED Task light - \$215
- LT-LED48: 48" LED Task light - \$270
- LT-LED60: 60" LED Task light - \$335
- LT-LED72: 72" LED Task light - \$360

2 Select Finish

[Click to view finishes](#)

3 Select Edge

[Click to view edges](#)

4 Select Hardware

[Click to view details](#)

Rift

Wall Hung Open Shelf Double Height - 32"/28"H

[Click here to view statement of line](#)

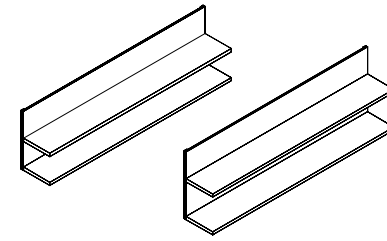

1 Select Model

w" x d" x h"	Weight
32" Height	
96 x 9 x 31.8	165
90 x 9 x 31.8	155
72 x 9 x 31.8	125
66 x 9 x 31.8	115
60 x 9 x 31.8	105
36 x 9 x 31.8	65
30 x 9 x 31.8	55
28" Height	
96 x 9 x 28.3	160
90 x 9 x 28.3	150
72 x 9 x 28.3	120
66 x 9 x 28.3	110
60 x 9 x 28.3	100
36 x 9 x 28.3	60
30 x 9 x 28.3	50

Standard Veneer Top Standard Veneer Chassis	Premium Veneer Top Premium Veneer Chassis	High Pressure Laminate Top Veneer Chassis	Thermally Fused Laminate Top Thermally Fused Laminate Chassis
"W" Option N/A	RFT9632WH336P 4581	"G" Option N/A	"M" Option N/A
"W" Option N/A	RFT9032WH336P 4439	"G" Option N/A	"M" Option N/A
"W" Option N/A	RFT7232WH336P 3738	"G" Option N/A	"M" Option N/A
"W" Option N/A	RFT6632WH336P 3632	"G" Option N/A	"M" Option N/A
"W" Option N/A	RFT6032WH336P 3526	"G" Option N/A	"M" Option N/A
"W" Option N/A	RFT3632WH336P 2054	"G" Option N/A	"M" Option N/A
"W" Option N/A	RFT3032WH336P 1946	"G" Option N/A	"M" Option N/A
"W" Option N/A	RFT9628WH336P 4581	"G" Option N/A	"M" Option N/A
"W" Option N/A	RFT9028WH336P 4439	"G" Option N/A	"M" Option N/A
"W" Option N/A	RFT7228WH336P 3738	"G" Option N/A	"M" Option N/A
"W" Option N/A	RFT6628WH336P 3632	"G" Option N/A	"M" Option N/A
"W" Option N/A	RFT6028WH336P 3526	"G" Option N/A	"M" Option N/A
"W" Option N/A	RFT3628WH336P 2054	"G" Option N/A	"M" Option N/A
"W" Option N/A	RFT3028WH336P 1946	"G" Option N/A	"M" Option N/A
TBCO			
TBSW			
TSTV			
TSMV			
TSLV			
TOBW			
Edge N/A			
Hardware N/A			

Product Features

- Double height with fixed shelf

Notes

- Max weight capacity 36 lbs per 1 FT width
 - The DARRAN wall mounted cabinet(or shelf) must be hung on a weight-bearing wall. The suitability of the wall supporting the wall mounted cabinet, and the installation and maintenance of the wall-mounted cabinet, is the sole responsibility of the customer. Failure to correctly install and/or exceed the loaded weight capacity of this product may cause it to fall, resulting in damage to the product, adjacent property and/or bodily injury.

Options

Task Light

- LT-LED24: 24" LED Task light - \$215
- LT-LED48: 48" LED Task light - \$270
- LT-LED60: 60" LED Task light - \$335
- LT-LED72: 72" LED Task light - \$360

2 Select Finish

[Click to view finishes](#)

3 Select Edge

[Click to view edges](#)

4 Select Hardware

[Click to view details](#)

Rift

Overhead Full Towers
Storage With Hinged Wood Door

[Click here to view statement of line](#)

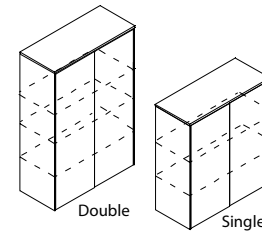

1 Select Model

w" x d" x h"	Weight
36 x 15 x 54	130
30 x 15 x 54	120
36 x 15 x 41	120
30 x 15 x 41	110

	Standard Veneer Top Standard Veneer Chassis	Premium Veneer Top Premium Veneer Chassis	High Pressure Laminate Top Veneer Chassis	Thermally Fused Laminate Top Thermally Fused Laminate Chassis
"W" Option N/A	RFT3654OH383P	3371	"G" Option N/A	"M" Option N/A
"W" Option N/A	RFT3054OH383P	3231	"G" Option N/A	"M" Option N/A
"W" Option N/A	RFT3641OH383P	3091	"G" Option N/A	"M" Option N/A
"W" Option N/A	RFT3041OH383P	2951	"G" Option N/A	"M" Option N/A
TBCO TBSW TSTV TSMV TSLV TOBW				
Edge N/A				
Hardware N/A				

Product Features

- 3/4" Thick back panel
- Adjustable veneer shelves: 41" (2) and 54" (3)
- Interior shelf depth 14"
- Recessed front detailing
- Touch latch
- "W" styles 41" H units finished top, 54" H units black painted top

Notes

- Unit has black back panel and is not designed for Open Plan use. Select OPB Option for Open Plan application

Options

Door

- D6: Delete Doors - n/c
- - RF750AW: Accent Frame w/ White Glass - \$780 per door
- WPD3061: Designer White - \$130 per 41" door
- WPD3061: Designer White - \$160 per 54" door

Interior Cabinet Lighting

- LEDPK starter kit includes Infeed, 1 Puck Interior Light and the ability to daisy chain up to 6 total Puck Lights
- LEDPK: LED Puck Starter Kit - \$310
- PK: 1 LED Interior Light - \$130

Open Plan _ Finished Back

- OPB:Modify Unit for Open Plan Application - \$295

Shelf

- GS14F: Replace Standard Shelves with Glass Shelves - \$90 per shelf
- S714F: Heavy Duty Lumber 1" Shelves - \$80 per shelf

2 Select Finish

[Click to view finishes](#)

3 Select Edge

[Click to view edges](#)

4 Select Hardware

[Click to view details](#)

Rift

Vertical Half Towers Wardrobe With Door

[Click here to view statement of line](#)

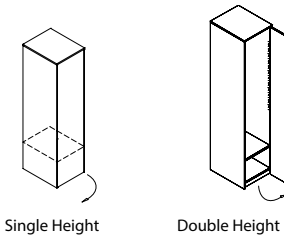

1 Select Model

w" x d" x h"	Weight
Hinged Left - Single Height 18 x 22 x 71	200
Hinged Left - Double Height 18 x 22 x 83	215
Hinged Right - Single Height 18 x 22 x 71	200
Hinged Right - Double Height 18 x 22 x 83	215

Standard Veneer Top Standard Veneer Chassis	Premium Veneer Top Premium Veneer Chassis	High Pressure Laminate Top Veneer Chassis	Thermally Fused Laminate Top Thermally Fused Laminate Chassis
"W" Option N/A	RFT1871TW877P 2894	"G" Option N/A	"M" Option N/A
"W" Option N/A	RFT1883TW877P 3457	"G" Option N/A	"M" Option N/A
"W" Option N/A	RFT1871TW878P 2894	"G" Option N/A	"M" Option N/A
"W" Option N/A	RFT1883TW878P 3457	"G" Option N/A	"M" Option N/A
	TBCO TBSW TSTV TSMV TSLV TOBW		
	Edge N/A		
	Hardware N/A		

2 Select Finish

[Click to view finishes](#)

3 Select Edge

[Click to view edges](#)

4 Select Hardware

[Click to view details](#)

Product Features

- 3/4" Thick back panel
- 71" H - Top is finished, 83" H - Top is painted black
- Adjustable shelves (3)/fixed shelf (1) 71"
- Adjustable shelves (4)/fixed shelf (1) 83"
- Coat rod and hook
- Recessed door detailing
- Touch latch

Notes

- Unit has black back panel and is not designed for Open Plan use. Select OPB Option for Open Plan application

Options

Accessories

- MTL30-S: Silver metal legs - \$315 unit
- MTL30-W: White metal legs - \$420 unit

Door

- D2: Door Lock - \$100 per door
- D2-G: Door Lock for Glass doors - \$205 per door
- D6: Delete Doors - n/c
- RF115AW: Full Height Aluminum/White Glass Doors - \$1200 per door
- WPD3061: Designer White - \$190 per 71" door
- WPD3061: Designer White - \$220 per 83" door

Open Plan _ Finished Back

- OPB:Modify Unit for Open Plan Application - \$295

Shelf

- GS14H: Replace Standard Shelves with Glass Shelves - \$70 per shelf

Rift

Vertical Full Towers
Wardrobe Storage With Double Door

[Click here to view statement of line](#)

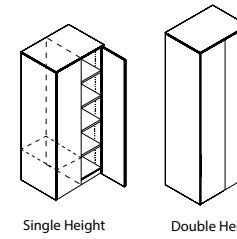

1 Select Model

w" x d" x h"	Weight
Double Height	
36 x 22 x 83	340
30 x 22 x 83	305
Single Height	
36 x 22 x 71	325
30 x 22 x 71	290

Standard Veneer Top Standard Veneer Chassis	Premium Veneer Top Premium Veneer Chassis	High Pressure Laminate Top Veneer Chassis	Thermally Fused Laminate Top Thermally Fused Laminate Chassis
"W" Option N/A	RFT3683TW275P 6194	"G" Option N/A	"M" Option N/A
"W" Option N/A	RFT3083TW275P 6055	"G" Option N/A	"M" Option N/A
"W" Option N/A	RFT3671TW275P 5773	"G" Option N/A	"M" Option N/A
"W" Option N/A	RFT3071TW275P 5634	"G" Option N/A	"M" Option N/A
	TBCO TBSW TSTV TSMV TSLV TOBW		
	Edge N/A		
	Hardware N/A		

Product Features

- 83" Double Height - 1 fixed / 4 adj.
- 71" Single Height 1 fixed, 3 adj.
- Center partition
- Recessed door detailing
- Single height adjustable shelves (3)/fixed shelf (1)
- Touch latch
- Wardrobe w/ coat rod & hook (on Left)
- "W" styles - 71" H units finished top, 83" H units black painted top

Notes

- Unit has black back panel and is not designed for Open Plan use. Select OPB Option for Open Plan application

Options

Accessories

- MTL30-S: Silver metal legs - \$315 unit
- MTL30-W: White metal legs - \$420 unit

Door

- D2: Door Lock - \$100 per door
- D6: Delete Doors. Must specify door (R or L) - n/c
- RF115AW: Full Height Aluminum/White Glass Doors - \$1200 per door
- WPD3061: Designer White - \$190 per 71" door
- WPD3061: Designer White - \$220 per 83" door

Open Plan _ Finished Back

- OPB:Modify Unit for Open Plan Application - \$295

2 Select Finish

[Click to view finishes](#)

3 Select Edge

[Click to view edges](#)

4 Select Hardware

[Click to view details](#)

Rift

Vertical Full Towers
File-File/Storage/Full Wardrobe

[Click here to view statement of line](#)

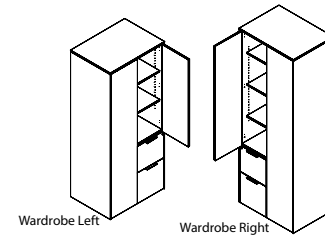

1 Select Model

w" x d" x h"	Weight	
Wardrobe Left - Single Height		
36 x 22 x 71	305	"W" Option N/A
30 x 22 x 71	305	"W" Option N/A
Wardrobe Left - Double Height		
36 x 22 x 83	340	"W" Option N/A
30 x 22 x 83	340	"W" Option N/A
Wardrobe Right - Single Height		
36 x 22 x 71	305	"W" Option N/A
30 x 22 x 71	305	"W" Option N/A
Wardrobe Right - Double Height		
36 x 22 x 83	340	"W" Option N/A
30 x 22 x 83	340	"W" Option N/A

2 Select Finish

[Click to view finishes](#)

TBCO
TBSW
TSTV
TSMV
TSLV
TOBW

3 Select Edge

[Click to view edges](#)

Edge
N/A

4 Select Hardware

[Click to view details](#)

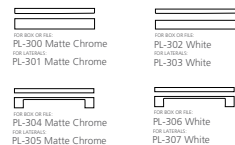

Standard Veneer Top Standard Veneer Chassis	Premium Veneer Top Premium Veneer Chassis	High Pressure Laminate Top Veneer Chassis	Thermally Fused Laminate Top Thermally Fused Laminate Chassis
	RFT3671TW273P 5759	"G" Option N/A	"M" Option N/A
	RFT3071TW273P 5618	"G" Option N/A	"M" Option N/A
	RFT3683TW273P 6180	"G" Option N/A	"M" Option N/A
	RFT3083TW273P 6039	"G" Option N/A	"M" Option N/A
	RFT3671TW274P 5759	"G" Option N/A	"M" Option N/A
	RFT3071TW274P 5618	"G" Option N/A	"M" Option N/A
	RFT3683TW274P 6180	"G" Option N/A	"M" Option N/A
	RFT3083TW274P 6039	"G" Option N/A	"M" Option N/A

Product Features

- Center partition
- Double Height adjustable shelves (3)
- Recessed door detailing
- Single height adjustable shelves (2)
- Soft close suspension drawer(s)
- Touch latch
- Wardrobe w/ coat rod & hook
- "W" styles - 71" H units finished top, 83" H units black painted top

Notes

- Unit has black back panel and is not designed for Open Plan use. Select OPB Option for Open Plan application

Options

Accessories

- MTL30-S: Silver metal legs - \$315 unit
- MTL30-W: White metal legs - \$420 unit

Door

- D2: Door Lock - \$100 per door
- D2-G: Door Lock for Glass Doors - \$205 per door set
- D6: Delete Doors - n/c
- RF115AW: Full Height Aluminum/White Glass Doors - \$1200 per door
- RF750AW: Accent Frame w/ White Glass Half Height - \$780 per door
- WPD3061: Designer White - \$190 per 71" door
- WPD3061: Designer White - \$220 per 83" door

Drawer

- P6: Modify File/File to Box/Box/File - \$55 per pedestal

Open Plan _ Finished Back

- OPB:Modify Unit for Open Plan Application - \$295

Rift

Vertical Full Towers
2 Lateral File/Storage Double Door

[Click here to view statement of line](#)

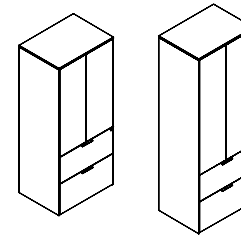

1 Select Model

w" x d" x h"	Weight
Double Height	
36 x 22 x 83	350
30 x 22 x 83	315
Single Height	
36 x 22 x 71	325
30 x 22 x 71	290

	Standard Veneer Top Standard Veneer Chassis	Premium Veneer Top Premium Veneer Chassis	High Pressure Laminate Top Veneer Chassis	Thermally Fused Laminate Top Thermally Fused Laminate Chassis
	"W" Option N/A	RFT3683TW281P 6265	"G" Option N/A	"M" Option N/A
	"W" Option N/A	RFT3083TW281P 6123	"G" Option N/A	"M" Option N/A
	"W" Option N/A	RFT3671TW281P 5843	"G" Option N/A	"M" Option N/A
	"W" Option N/A	RFT3071TW281P 5703	"G" Option N/A	"M" Option N/A
2 Select Finish Click to view finishes		TBCO TBSW TSTV TSMV TSLV TOBW		
3 Select Edge Click to view edges		Edge N/A		
4 Select Hardware Click to view details		<p>PL-300 Matte Chrome PL-301 Matte Chrome PL-304 Matte Chrome PL-305 Matte Chrome</p>	<p>PL-302 White PL-303 White PL-306 White PL-307 White</p>	

Product Features

- Anti-tilt safety drawer lock
- Double Height adjustable shelves (3)
- Locking drawers
- Single height adjustable shelves (2)
- Features ball bearing suspensions, suspensions are full extension
- Touch latch
- Wardrobe and shelves divided by center partition
- "W" styles - 71" H units finished top, 83" H units black painted top

Notes

- Unit has black back panel and is not designed for Open Plan use. Select OPB Option for Open Plan application

Options

Accessories

- MTL30-S: Silver metal legs - \$315 unit
- MTL30-W: White metal legs - \$420 unit

Door

- D2: Door Lock for Glass Doors - \$100 per door set
- D2-G: Door Lock for Glass doors (only when RF750AW is ordered)- \$205 per door set
- D6: Delete Doors - n/c
- RF750AW: Aluminum/White Glass - \$780 per door
- WPD3061: Designer White - \$190 per 71" door
- WPD3061: Designer White - \$220 per 83" door

Open Plan _ Finished Back

- OPB: Modify Unit for Open Plan Application - \$295

Partition

- MOD30: Delete center partition & Add 2 full width shelves - \$295

Rift

Open Bookcases
15" Deep

[Click here to view statement of line](#)

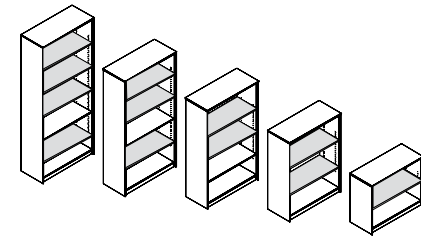

1 Select Model

w" x d" x h"	Weight
83" Height	
36 x 15 x 83	180
30 x 15 x 83	160
71" Height	
36 x 15 x 71	160
30 x 15 x 71	140
60" Height	
36 x 15 x 60	145
30 x 15 x 60	125
48" Height	
36 x 15 x 48	125
30 x 15 x 48	105
29" Height	
36 x 15 x 29	115
30 x 15 x 29	90

2 Select Finish

[Click to view finishes](#)

TBCO
TBSW
TSTV
TSMV
TSLV
TOBW

3 Select Edge

[Click to view edges](#)

Edge
N/A

4 Select Hardware

[Click to view details](#)

Hardware
N/A

	Standard Veneer Top Standard Veneer Chassis	Premium Veneer Top Premium Veneer Chassis	High Pressure Laminate Top Veneer Chassis	Thermally Fused Laminate Top Thermally Fused Laminate Chassis
"G" Option N/A		RFT3683BK250P 4632	"G" Option N/A	"M" Option N/A
"G" Option N/A		RFT3083BK250P 4417	"G" Option N/A	"M" Option N/A
"G" Option N/A		RFT3671BK250P 4341	"G" Option N/A	"M" Option N/A
"G" Option N/A		RFT3071BK250P 3948	"G" Option N/A	"M" Option N/A
"G" Option N/A		RFT3660BK250P 4039	"G" Option N/A	"M" Option N/A
"G" Option N/A		RFT3060BK250P 3618	"G" Option N/A	"M" Option N/A
"G" Option N/A		RFT3648BK250P 3742	"G" Option N/A	"M" Option N/A
"G" Option N/A		RFT3048BK250P 3177	"G" Option N/A	"M" Option N/A
"G" Option N/A		RFT3629BK250P 2504	"G" Option N/A	"M" Option N/A
"G" Option N/A		RFT3029BK250P 1966	"G" Option N/A	"M" Option N/A

Product Features

- 3/4" Thick doweled back
- Adjustable shelves (shaded)
- Interior shelf depth 14"
- "W" styles 29", 48", 60", and 71" H units finished top, 83" H units black painted top

Notes

- Unit has black back panel and is not designed for Open Plan use. Select OPB Option for Open Plan application

Options

Accessories

- MTL30-S: Silver metal legs - \$315 unit
- MTL30-W: White metal legs - \$420 unit

Interior Cabinet Lighting

- LEDPK starter kit includes Infeed, 1 Puck Interior Light and the ability to daisy chain up to 6 total Puck Lights
- LEDPK: LED Puck Starter Kit - \$310
- PK: 1 LED Interior Light - \$130

Open Plan _ Finished Back

- OPB: Modify Unit for Open Plan Application - \$295

Shelf

- GS14F: Replace Standard Shelves with Glass Shelves - \$90 per shelf
- S714F: Heavy Duty Lumber 1" Shelves - \$80 per shelf

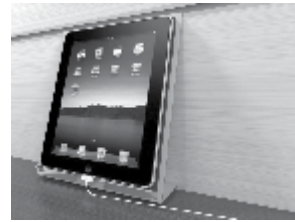
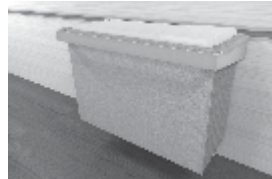
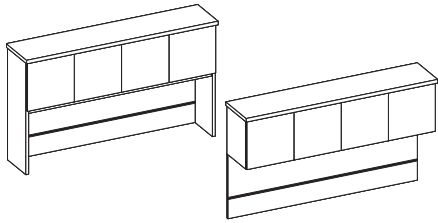

TOOL CHANNEL ACCESSORIES
recessed aluminum tool channel

TOOL CHANNEL ACCESSORIES
file holder

TOOL CHANNEL ACCESSORIES
tablet holder

TOOL CHANNEL ACCESSORIES
iphone holder

Style Number	List Price
ATB02	5 per 1"W

Style Number	List Price
ATB37	105

Style Number	List Price
ATB30	135

Style Number	List Price
ATB31	120

Specifications

- Anodized aluminum finish
- Fully recessed
- Finish matches anodized aluminum accessories
- Can be specified with fabric tack surface mounted above channel

Notes
- If using tool channel with wallhung overhead, a veneer panel must be specified.

Specifications

- For Console/Wall Hung Back Panels With Optional Tool Bar
- 18 Gauge Steel - Stamp Formed
- Silver Powderdercoat Finish

Specifications

- For Console/Wall Hung Back Panels With Optional Tool Bar
- 18 Gauge Steel - Stamp Formed
- Silver Powderdercoat Finish
- 10" x 8"W
- Non-slip Neoprene pad

Specifications

- For Console/Wall Hung Back Panels With Optional Tool Bar
- 18 Gauge Steel - Stamp Formed
- Silver Powderdercoat Finish
- 5" x 3 -3/4"W
- Non-slip Neoprene pad

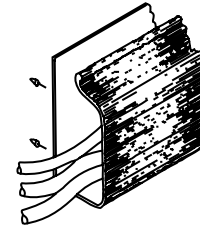
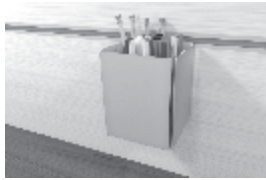
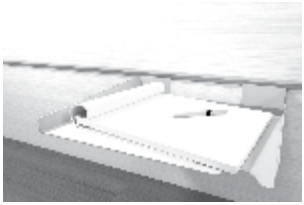

TOOL CHANNEL ACCESSORIES
large shelf

TOOL CHANNEL ACCESSORIES
pencil pen holder

TOOL CHANNEL ACCESSORIES
small shelf

WIRE MANAGEMENT
horizontal j-channel wire
management raceway

Style Number	List Price
ATB35	125

Style Number	List Price
ATB38	115

Style Number	List Price
ATB36	110

Style Number	List Price
W1	75 Per 4' section

Specifications

- 12"W x 10"D

Specifications

- For Console/Wall Hung Back Panels With Optional Tool Bar
- 18 Gauge Steel - Stamp Formed
- Silver Powdercoat Finish
- 5"H x 4"W x 4"D

Specifications

- 12"W x 6 -3/4"D

Specifications

- 4' section for field installation.
- The "J" shape black thermoplastic wire raceway may be added to specified worksurface tops to provide concealed channeling of wires to and from worksurface grommets. For use in open kneespace areas, raceway is attachable to top of back panel with pan head screws. Interior dimensions are 1" x 1- 1/2" providing ample storage for multiple wires and excess cable. Front of raceway flexes out for easy cord insertion.

Notes

- Units w/ Wire Channel Standard.
- Field Installation

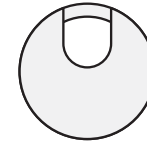
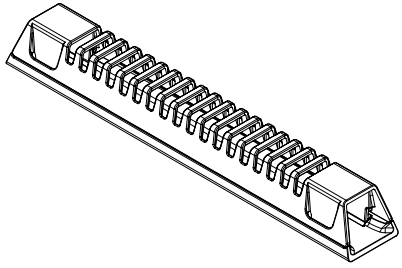

WIRE MANAGEMENT
horizontal wire management raceway

WIRE MANAGEMENT
horizontal u-channel wire management raceway

WIRE MANAGEMENT
coil wire manager

WIRE MANAGEMENT
standard location grommets - factory installed

Style Number	List Price
W21	30

Style Number	List Price
W2A	75 Per 4' section

Style Number	List Price
W18	150

Style Number	List Price
Standard Location Grommet	
Black	
TM30	45
Silver	
TM31	45
Antique Brass	
TM33	45
White	
TM34	45

Specifications

- 10"W x 1.5"D x 1.25"H
- Grey Wire Manager (10.5")
- Power and data cables can be discretely housed and managed with the W21 Gray Wire Manager. This can be mounted in any location to metal frame or underside of conference tables and runs cables through a 1" channel from power module to hollow steel legs. This keeps cables organized under the table top. Release clips make it simple to snap on and off the Wire Manager for easy organization and access after attached to the table

Notes
- Field installed

Specifications

- 4' section for field installation.
- Notes
- Units w/ Wire Channel Standard.
 - Field Installation

Specifications

- Weighted Base, Table attachment plate
 - 39- 1/2" Length
 - Black
- Notes
- Location

Specifications

- 1 -5/8" Metal Grommet
- Notes
- *Units w/ Grommets Standard Are Noted Under Standard Features. Grommets Match Pull Finish - Standard (Unless Specified Otherwise)

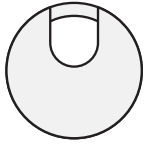

WIRE MANAGEMENT

non-standard location grommets - factory installed

Style Number	List Price
Non-Standard Location Grommet	
Black	
TM30 -NS	90
Silver	
TM31 -NS	90
Antique Brass	
TM33 -NS	90
White	
TM34 -NS	90

WIRE MANAGEMENT

black plastic vertical surface grommets - factory installed

Style Number	List Price
Standard Location Grommet	
TM50-C	45
Non-Standard Location Grommet	
TM50-NS	90

Specifications

- 1-5/8" Metal Grommet

Notes

- *Units w/ Grommets Standard Are Noted Under Standard Features. Grommets Match Pull Finish - Standard (Unless Specified Otherwise)

Specifications

- 2 " Black Plastic Grommet

Notes

- Standard Location is Bottom Center



COMPUTER SUPPORT
single monitor arm

Style Number	List Price
MA1	265



COMPUTER SUPPORT
double monitor arm

Style Number	List Price
MA2	430



COMPUTER SUPPORT
triple monitor arm

Style Number	List Price
MA3	505



COMPUTER SUPPORT
quadruple monitor arm

Style Number	List Price
MA4	675

Specifications

- Available in black or silver
- Desk clamp and mounting included
- Easy assembly and flexibility
- Elastic painting process for a durable and beautiful finish
- Gas spring tension adjustment for counter-balance height adjustment for monitors 1-8 KG
- Gas spring tested to 50,000 repetitions
- Hidden cable management

Specifications

- Available in black or silver
- Desk clamp and mounting included
- Easy assembly and flexibility
- Elastic painting process for a durable and beautiful finish
- Gas spring tension adjustment for counter-balance height adjustment for monitors 1-8 KG
- Gas spring tested to 50,000 repetitions
- Hidden cable management

Specifications

- Available in black or silver
- Desk clamp and mounting included
- Easy assembly and flexibility
- Elastic painting process for a durable and beautiful finish
- Gas spring tension adjustment for counter-balance height adjustment for monitors 1-8 KG
- Gas spring tested to 50,000 repetitions
- Hidden cable management

Specifications

- Available in black
- Desk clamp and mounting included
- Easy assembly and flexibility
- Elastic painting process for a durable and beautiful finish
- Gas spring tension adjustment for counter-balance height adjustment for monitors 1-8 KG
- Gas spring tested to 50,000 repetitions
- Hidden cable management

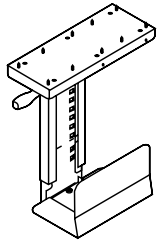

COMPUTER SUPPORT
cpu retractable cradle

Style Number	List Price
K18	195

Specifications

- Black Metal CPU Carriage
- Full 360° swivel capability allows easy access to rear of CPU for cables / wires
- Track allows 8- 1/2" extension
- Width Adjustment 5-1/2" to 9-1/4"
- Height adjustment 14- 5/8" to 20- 1/2"
- Black epoxy finish

Notes
- Factory Installed

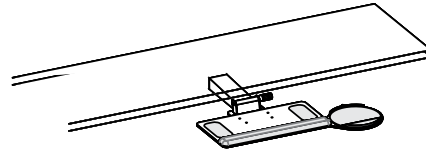

COMPUTER SUPPORT
articulating keyboard tray

Style Number	List Price
Factory Installed K28	375
Field Installed K28F	395

Specifications

- Adjusts effortlessly - A simple one-handed motion allows the keyboard to be repositioned instantly, without the use of locks or levers
- Encourages low-risk postures - Maximizes adjustability within a safe operating range.
- Will last a lifetime - Exceeds all applicable BIFMA Standards and comes with a lifetime guarantee.

Notes
- Available on: Freestanding Desk
- Factory Installed (standard)
- FIELD INSTALL - \$395



DOOR MODIFICATIONS
soft close door hinge

Style Number	List Price
D9SC	15 Per door

Specifications

- Snap onto standard door hinge
- Requires (2) per door
- Max door height 43"
- Factory installed where specified
- Individually shipped for field installation

Notes
- Specify Each Item To Have Slow Close Feature

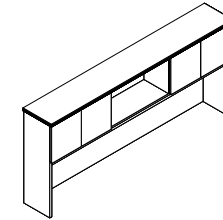

DOOR MODIFICATIONS
delete doors

Style Number	List Price
D6	N/C

Specifications

- Standard Door overheads and cabinets can have door deleted for open access. Modification of hinge rails and structural components are made face ready.

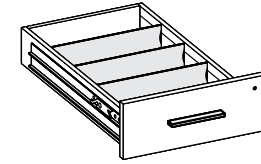
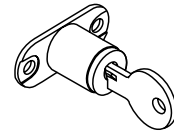
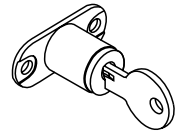
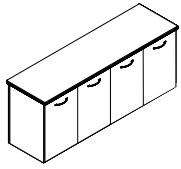

DOOR MODIFICATIONS

delete doors/replace black laminate shelf w/ finished shelf

Style Number	List Price
D6A	N/C

DOOR MODIFICATIONS

panel door lock

Style Number	List Price
D2	95 Per door set

DOOR MODIFICATIONS

glass door lock

Style Number	List Price
D2-G	195 Per door set

DRAWER OPTIONS

box drawer accessories

Style Number	List Price
Wood Drawer Dividers w/ Clips K-DIV	SET OF 3 - 30
Single Tray - Utility Tray K-Sut	30 each

Specifications

- Delete doors and replace black laminate shelf with finished shelf
- Available on: All Storage "W"/"G" Style Credenzas.

Specifications

- Door Locks - 1 Door w/ Lock, Other Door w/ Catch Latch
- Contact Customer Service regarding limited lock locations and keying.

Notes
 - Available on: Panel Doors, Wood Frame Doors, and Silverluma doors

Specifications

- Door Locks - 1 Door w/ Lock, Other Door w/ Catch Latch
- Contact Customer Service regarding limited lock locations and keying.

Notes
 - Available on: Glass Doors

Specifications

- K-DIV Extra Wood Drawer Dividers with Clips, Top Box drawers standard with 1 divider
- K-SUT Single Tray - Utility Tray, Specify Legal or Letter drawer width

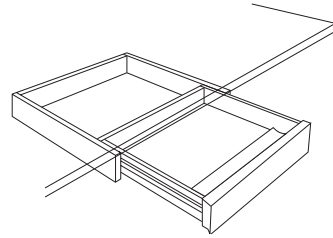
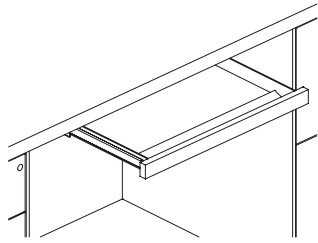

DRAWER OPTIONS
center drawer

Style Number	List Price
Factory Installed K1R	275
Field Installed K1RF	275

DRAWER OPTIONS
center drawer with skirt

Style Number	List Price
Factory Installed K2R	375
Field Installed K2RF	375
Add Skirt Option K2R-SK	475

GLASSBOARD ACCESSORIES
glassboard accessory kit

Style Number	List Price
GBKIT	275

Specifications

- Center Drawer - Factory Installed, Center Drawer - Field Installed

Specifications

- Center Drawer - Factory Installed, Center Drawer - Field Installed

Specifications

- 8 Earth magnets, 1 magnetic marker cup holder and 1 magnetic dry eraser

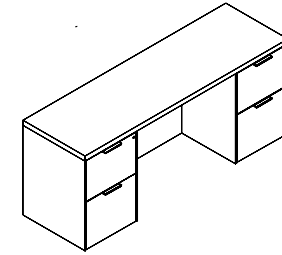
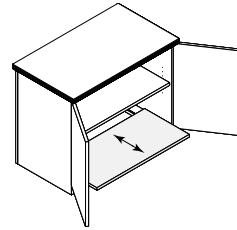
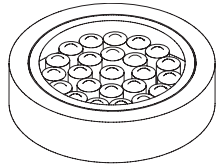

TASK LIGHTING
It-led task light

Style Number	List Price
24" Task light LT-LED24	215
48" Task light LT-LED48	270
60" Task light LT-LED60	335
72" Task light LT-LED72	360

Specifications

- 6.5' Power cord. Switch with touch dimmer
- 36 LEDs per foot
- 4.6 Watts per foot
- 91 Lumens per watt
- Please note when ganging.
- Overhead tasklight cord is located on the right facing side. If the opposite location is required please contact customer service.

LIGHTING
led interior cabinet puck light

Style Number	List Price
Starter Kit LEDPK	295
1 LED Interior Puck Light PK	125

Specifications

- Starter kit includes Infeed, 1 Puck Interior Light and the ability to daisy chain up to 6 total Puck Lights
- (1) LED Puck Light with 30W power drive and switch
- Recessed fixture
- 12V linking cord 98"L
- Silver finish
- 50,000 hour life
- 2 watt per light

Notes

- Available on: Overhead/Tower Units with glass doors or no doors
- Power drive included, Light only

PEDESTAL MODIFICATIONS
black laminate printer pullout bottom shelf

Style Number	List Price
PPOS	214

Specifications

- Black Laminate pullout shelf on suspension
- Black grommet
- Adjustable Shelf

PEDESTAL MODIFICATIONS
add tech veneer kneespace cabinets - no base

Style Number	List Price
Add Box/Box/File or File/File P40T	1100
Add Lateral File 29" W P41T	1210
Add Multi-File - 31"W P42T	1320
Add Storage With Doors 29"W P43T	1210
Add CPU /Printer Cabinet - Open P44T	1210

Specifications

- Multi-file specify Box/Box Left or Right

Notes

- Add additional Standard Cabinets To Kneespace Area.

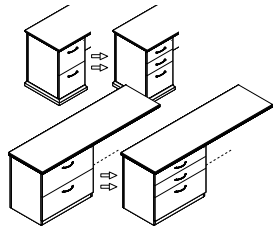

PEDESTAL MODIFICATIONS
modify drawer configurations

Style Number	List Price
File/File to Box/Box/File P6	50 Per ped
Box/Box/File to File/File P6	50 Per ped
Lateral File to 2 Box Drawers P8	95 Per ped

Specifications

- Modify File/File To Box/Box/File - Any Unit

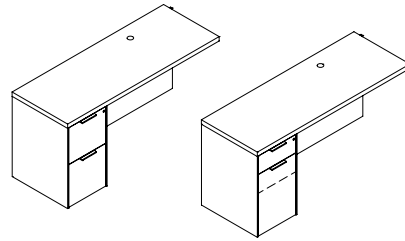

PEDESTAL MODIFICATIONS
modify drawer configurations

Style Number	List Price
File/File to Box/Box/File P6H	95 Per ped
Lateral File to 2 Box Drawers P8	95 Per ped

Specifications

- Modify File/File To Box/Hidden Box/File - Any Unit

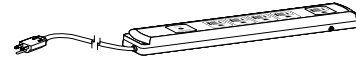

POWER / DATA
power supply cordset

Style Number	List Price
PD717	109

Specifications

- SIZE: 10.75"L x 2.0"W x 1.06"H
- (5) Outlets w/ 10' cord
- Surge suppression (720 Joules)
- 15 Amp breaker
- Available on: Vertical Panels, Cabinet Interiors, and under tops

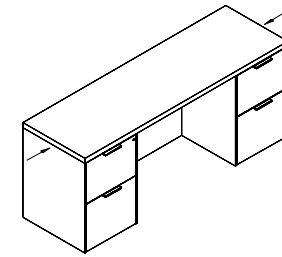

PRODUCT MODIFICATIONS
modify width - open kneespace

Style Number	List Price
MOD-1	125

Specifications

- Modify width down on any unit with an open kneespace: desk, workstation credenza, bridge, return

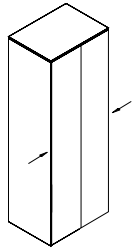

PRODUCT MODIFICATIONS
 modify width - open/closed storage

Style Number	List Price
MOD-2	250

Specifications

- Modify width down on any unit with open or closed storage section: overheads, wall hung units, storage credenzas, towers

PRODUCT MODIFICATIONS
 modify width - outside of mod-1, mod-2

Style Number	List Price
MOD-3	Contact for pricing

Specifications

- Width modification outside of MOD-1 & MOD-2

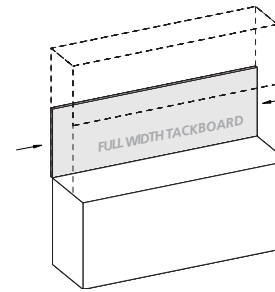

PRODUCT MODIFICATIONS
 modify width - tackboard, slat wall, veneer panel, or a glassboard

Style Number	List Price
MOD-4	50

Specifications

- Modify width down on tackboard, slat wall, veneer panel, or a overhead glassboard

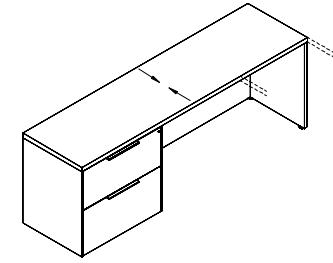

PRODUCT MODIFICATIONS
 modify depth - decrease depth

Style Number	List Price
MOD-5	125

Specifications

- Modify depth down (minimum depth for a unit with drawers is 21"D)

Notes
 - Ex. 24" to 21", 30" to 24", and 36" to 30"

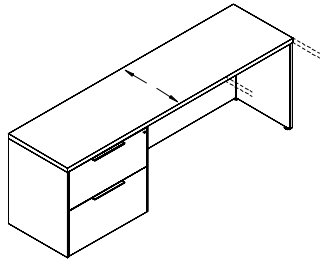

PRODUCT MODIFICATIONS
modify depth - increase depth

Style Number	List Price
MOD-6	Add 10%

Specifications

- Increase depth by no more than 6"

Notes

- Ex. 24" to 30", 30" to 36", and 36" to 42"
- Add 10% to the unit you want to increase the depth of by no more than 6"

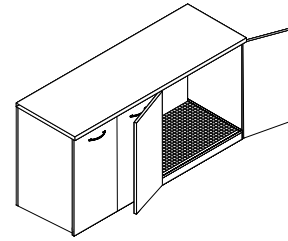

REFRIGERATOR MODIFICATION
refrigerator cabinet modification

Style Number	List Price
REF01	195

Specifications

- Open back cutout for venting
- Moisture sponge mat
- Contaminate ledge
- Contact customer service for maximum refrigerator size (Changes based on unit).
- Available on: 36" and 42" Storage Credenzas

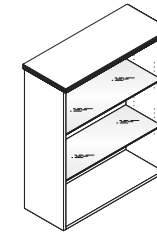

SHELF MODIFICATIONS
glass shelves - tempered full width
26" - 35"

Style Number	List Price
26"W - 35"W x 14"D Shelf GS14F	85

Specifications

- Glass Shelves Replace Wood Shelf In Open Or Glass Door Cabinet. Also Order Interior Cabinet Lighting.

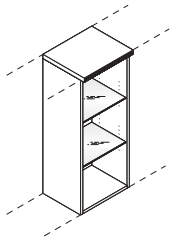

SHELF MODIFICATIONS

tempered glass shelves for half cabinet 17- 1/2" widths

Style Number	List Price
14-1/2"W - 17- 1/2"W x 14"D Shelf GS14H	65 ea

Specifications

- Glass Shelves Replace Wood Shelf In Open Or Glass Door Cabinet. Also Order Interior Cabinet Lighting.

Notes

- Replace only adjustable shelves between cabinet light and fixed lower wood shelf.

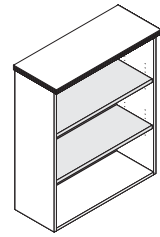

SHELF MODIFICATIONS

heavy duty solid wood bookcase replacement shelves

Style Number	List Price
1" Wood Shelf 14" Deep S714F	75 ea
1" Wood Shelf 24" Deep S714FX	150 each

Specifications

- 1" Solid Lumber Core Shelves Replace Standard 3/4" Plywood Adjustable And Fixed Shelves



SLAT WALL ACCESSORIES

slat wall accessory tray

Style Number	List Price
SWA9	45

Specifications

- Specify Black Or Matte Silver

Aircharge wireless charging grommet

Style Number	List Price
 ACWG WIRELESS GROMMET	\$213

Specifications

- > When used with GROVE Tables an additional \$350 LIST will apply for the special cutout required.
- > AirCharge offers a convenient way to charge any Qi compatible smartphone or device without the need to carry charging cables or find an available power outlet.
- > The Aircharge is powered by the latest Qi compliant IC offering reliable and efficient wireless charging in a convenient 3" grommet hub. Simply place your phone on the Aircharge and an LED will confirm pairing and begin wireless charging.
- > Recess: Efficient space conservation and quick access
- > Input: DC 5V (with included AC power adapter), DC 9V, 1.67A (with optional QC 2.0 power adapter)
- > Output: 5 watts Max. with DC 5V, 2A power adapter, 10 watts Max. with QC 2.0 power adapter
- > Qi V1.2 compliant IC
- > Charging distance: 6mm Max.

Available: All DARRAN collections



Cove power unit - non-linking

Style Number	List Price
 PD-COVE PLUG	\$600
Non-linking version	

Specifications

- > Size 5.75"L x 2.5"W
- > (2) 15 Amp Receptacles and (2) USB charging ports
- > Surface Mount
- > 108" Cord
- > Standard Silver Finish, Available in White or Black Finish upon request
- > ETL Listed

Available: All DARRAN collections



Cove corded series

Style Number

List Price



PD-COVE-PKO

\$872

Specifications

- > Size 9.5"L x 2.5"W x 3.18"D
- > When used with GROVE Tables an additional \$350 LIST will apply for the special cutout required.
- > (2) Power Receptacles, (2) 2.1 Amp USB charging ports and (1) Telecom Plate Knockout
- > Surface Mount
- > 108" Cord
- > Standard Silver Finish, Available in White or Black Finish upon request
- > ETL Listed

Available: All DARRAN collections

Telecom Plates

RJ45 (1)	\$55
RJ45 (2)	\$110
RJ45 (3)	\$165
USB (1)	\$70
USB (2)	\$140
RJ11/RJ45	\$110
RJ45/USB	\$125
RJ45/HDMI	\$210
HDMI/DVI	\$325
HDMI/USB	\$205
HDMI/VGA	\$240
VGA/MINI-STEREO	\$155
VGA/USB	\$175

This pod can have up to 1 total plates.
 *All telecom connectors sold separately.



Soba wire manager

Style Number	List Price
STARTER UNITS	
SCDW	\$218
White wire manager	
SCDB	\$218
Black wire manager	

Specifications

- › Dimensions: 9ft x 9in x 3.15in
- › Zips up, bundles and routes loose, messy cables into a single tube
- › Routes and guides cables behind desks, TVs, and anywhere cables tend to get messy
- › Accommodates large or small cables, up to three cables at once
- › Support channels, used to route cables, include powerful adhesive backing which allows easy attachment to surfaces.

Available: All DARRAN collections



VILLA Power unit - non-linking

Style Number	List Price
 VIL-C PLUG Non-Linking	\$562

Specifications

- > Size: Top Grommet 5.68"L X 3.39"W; Under Top 12"L x 3.13"W x 3.08"D
- > (2) Power receptacles; (2) USB charging ports and (1) Knockouts for RJ45 Data Ports
- > Surface Mount
- > 72" Cord (Longer cord available, contact Customer Service)
- > Standard Silver Finish, Black Finish available upon request
- > UL or ETL Certified

Available: All DARRAN collections, excludes Grove

RJ45 Knockout	
RJ45 (1)	\$55

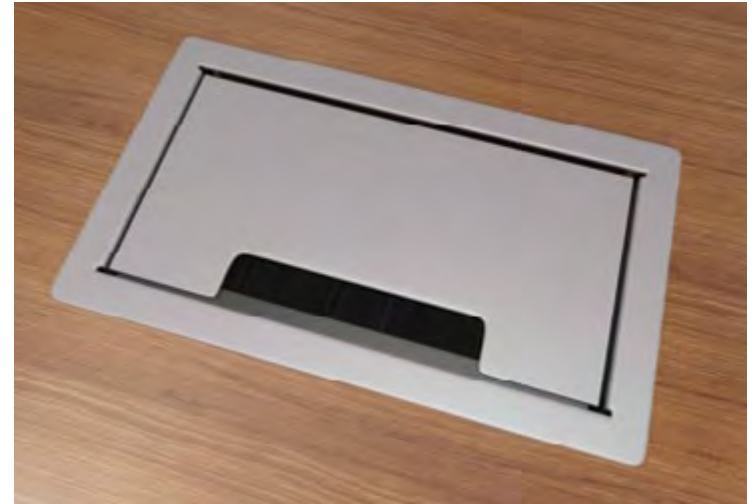



Not So Square Office Price List

Effective November 1, 2022

Date	Page	Modification	Description
11.07.22		Premium Metal Finish	Added Matte Gold and Dark Bronze
11.11.22		Price Increase	9% price increase applied to all items excluding options

Statement of Line
Features & Advantages1
Finishes | Specifications3
Edges | Pulls4
Grommets | Grommet Reference.....5
Ganging | Height Reference6
Metal Legs8
Modesty Reference | Grain Direction.....9
Drawer Dimensions | FILING Reference.....10
Double Pedestal Desk.....11
Table Desk.....12
Freestanding Desks13
Single Pedestal Desk.....14
Conference Desk.....15
Runoff Desk.....17
Returns.....18
Bridges21
Freestanding Credenzas.....22
Workstation Credenzas23
Bench Cabinets30
Pedestals31
Single Height Freestanding Overheads.....32
Double Height Freestanding Overheads.....35
Overhead Accessories.....37
Single Height Wall Hung Overheads.....41
Double Height Wall Hung Overheads.....44
Wall Hung Accessories47
Wall Hung Overheads52
Overhead Bookcases.....54
Vertical Half Towers.....55
Vertical Full Towers.....58
Bookcases.....60
Options61
Power & Data.....74

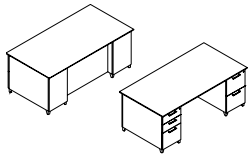

Page 10
Freestanding Desks
Breakfront - Full Pedestal With
Modesty Panel

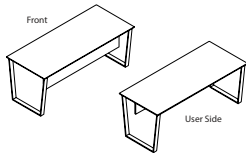

Page 11
Freestanding Desks
Table Desk With Sleigh Base

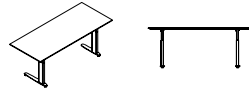

Page 12
Freestanding Desks
Adjustable Desk / Motorized

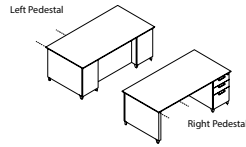

Page 13
Freestanding Workstation Desks
Breakfront Single Pedestal

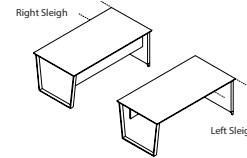

Page 14
Conference Workstation Desks
Rectangle Top With Sleigh Base

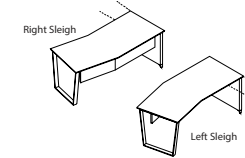

Page 15
Conference Workstation Desks
Angular Top With Sleigh Base

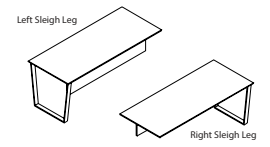

Page 16
Runoff Conference Workstation
Desks
Rectangle Runoff Desk With
Sleigh Base

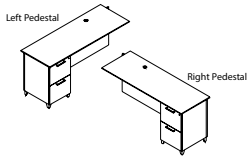

Page 17
"L" Workstation Returns
File/File

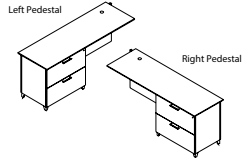

Page 18
"L" Workstation Returns
Lateral File

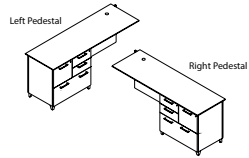

Page 19
"L" Workstation Returns
Multi-File

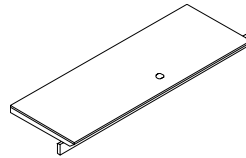

Page 20
Workstation Bridges
Open Back Bridge

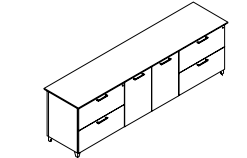

Page 21
Freestanding Lateral File Credenzas
Lateral File/Storage

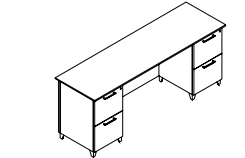

Page 22
File Credenzas
File/File/Kneespace

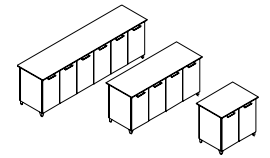

Page 23
Freestanding Storage Credenzas
Storage

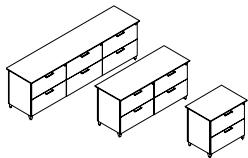

Page 24
Freestanding Lateral File Credenzas
Horizontal Lateral File

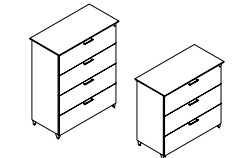

Page 25
Freestanding Lateral File Credenzas
Vertical Lateral File

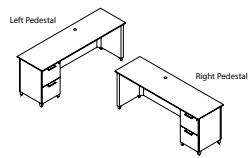

Page 26
Workstation Credenzas
File/File

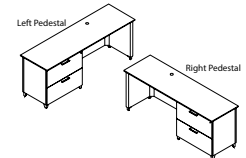

Page 27
Workstation Credenzas
Lateral File

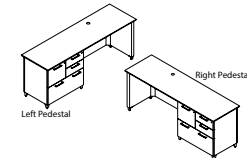

Page 28
Workstation Credenzas
Multi-File

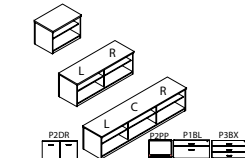

Page 29
Bench Cabinets
One / Two / Three Section
Storage

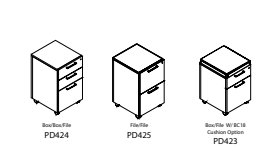

Page 30
Freestanding Mobile Pedestal
Mobile Pedestal - Under Surface
Storage

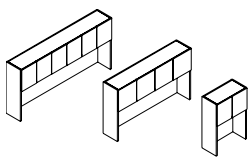

Page 31
Single Storage Overhead
Consoles
Panel Door - 6/4/2 Door

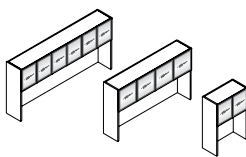

Page 32
Single Storage Overhead
Consoles
Silverluma Frame Doors / 6/4/2
Door

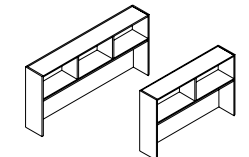

Page 33
Single Storage Overhead
Consoles
Open Storage Console

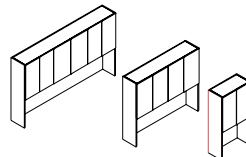

Page 34
Double Height Overhead
Consoles
Panel Door

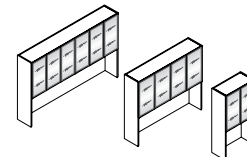

Page 35
Double Height Overhead
Consoles
Silverluma Frame 6/4/2 Doors

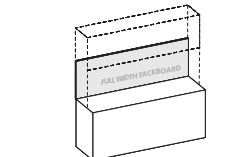

Page 36
Overhead Tackboards

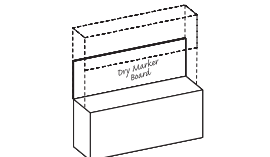

Page 37
Overhead Dry Marker Boards

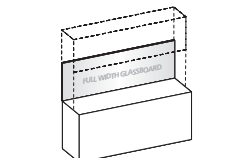

Page 38
Overhead Glassboards

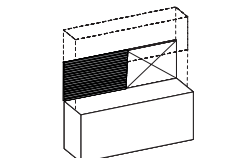

Page 39
Overhead Slat Wall

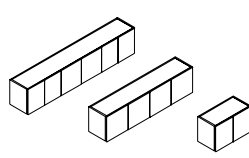

Page 40
Single Height Wall Hung Over-
heads
Panel Doors

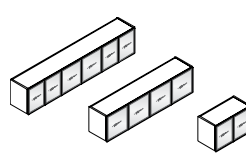

Page 41
Single Height Wall Hung Over-
heads
Silverluma Frame / Doors

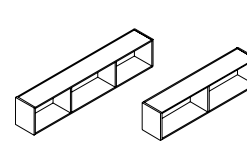

Page 42
Single Height Wall Hung Over-
heads
Open Storage Cabinet

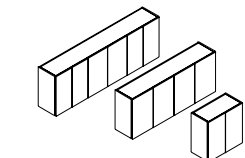

Page 43
Double Height Wall Hung
Overheads
Panel Doors

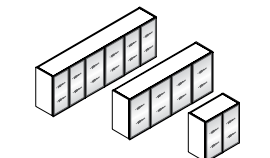

Page 44
Double Height Wall Hung
Overheads
Silverluma Frame / Doors

Statement of Line

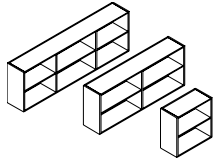

Page 45
Double Height Wall Hung
Overheads
Open Storage Cabinet

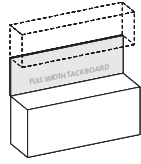

Page 46
Wall Hung Tackboards

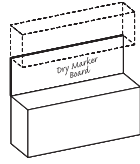

Page 47
Wall Hung Dry Marker Boards

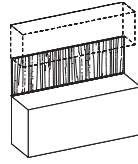

Page 48
Wall Hung Veneer Panels

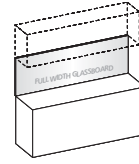

Page 49
Wall Hung Glassboards

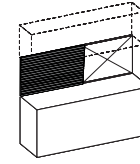

Page 50
Wall Hung Slat Wall

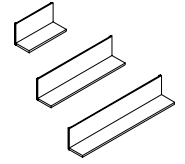

Page 51
Single Height Wall Hung Over-
heads
Open Endless Shelf Single Height

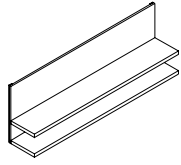

Page 52
Double Height Wall Hung
Overheads
Open Endless Shelf Double
Height

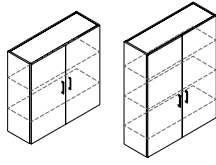

Page 53
Overhead Bookcases
Panel Doors / Storage

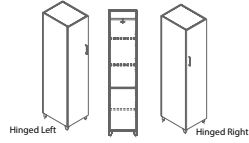

Page 54
Freestanding Half Towers
Wardrobe / Storage

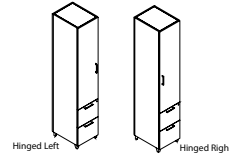

Page 55
Freestanding Half Towers
Storage / File

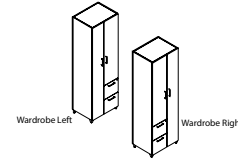

Page 56
Freestanding Towers
Storage / File- Mini-Wardrobe

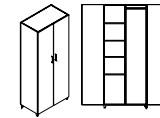

Page 57
Freestanding Towers
Wardrobe / Storage Full Tower



Page 58
Freestanding Towers
Storage / File Full Tower

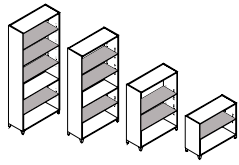

Page 59
Open Bookcases
Freestanding

Veneer

DARRAN only uses HPVA AA Grade Flat Cut Cherry, Maple, and Walnut Veneers and AA Grade Quartered Oak Veneers. Not SO square is also available in double cut reconstituted walnut and oak patterns made from rapidly renewable wood veneer providing a repeatable consistent straight grain pattern. All veneers are selected and matched for balance and consistency.

Veneer Tops

Not SO square veneer tops feature a 45-pound density substrate with balanced 3-ply construction. Tops are 1-1/8" thick on MDF core comprised of 100% recycled and recovered wood fibers. All veneer tops are slipmatched and feature a 3mm external solid hardwood band or profile edge.

Laminate Tops

Not SO square high-pressure laminate tops feature a 45-pound density substrate with balanced 3-ply construction. Tops are 1-1/8" thick on MDF core comprised of 100% recycled and recovered wood fibers. All high pressure laminate tops are available with a profile edge, laminate self-edge or 2mm PVC edge band. Laminates in wood grain patterns feature a fine grain texture that features the polish and luxe of a real wood veneer with a subtle narrow grain structure.

TFL tops

Thermally Fused Laminate tops feature a 45-pound density substrate with balanced 3-ply construction. Tops are 1-1/8" thick on MDF core that is comprised of 100% recycled and recovered wood fibers. All Thermally Fused Laminate tops are available with a 2mm flat PVC band. Laminates in wood grain patterns feature Timberline Texture providing the grain pattern of wood.

Cleaning wood & laminate

In addition to regular dusting, give your furniture an occasional cleaning in accordance with our cleaning instructions. DARRAN wood and laminate products can be cleaned with a soft cloth and a mild soap and water mixture. Use approximately 32 oz of water mixed with one tablespoon of dish soap, always wiping with the grain. Dry with a soft cloth, going with the grain, to avoid spotting or streaking.

Wood products should be waxed periodically using a non-wax liquid; please do not use any waxy polish or cleaner. Interior of drawers may also be cleaned with mild soap and water mixture, or any household cleaner that is not petroleum or thinner-based.

Chassis & pedestal

Chassis components are 3/4" thick core of particle board or MDF rated EPP/SCS/CARB-II material with 3-ply balanced construction. Pedestal and Cabinets feature dowel construction reinforced with steel bracket plates, wood cleats, screws and glue. All units are standard with 1" adjustable glides that allow for leveling of units that are secured in

solid wood glide blocks to prevent tearout.

Overhead cabinet construction Freestanding & wall mount

Freestanding Overhead storage cabinets are constructed of 1" and 3/4" thick core of particle board or MDF rated EPP/SCS/CARB-II material with 3-ply balanced construction. Panels are attached with cam fasteners in conjunction with dowels securely adhered with PVAc glue. All surface mount cabinets connect to work surface with anti-slip tape. Wall mount cabinets are mounted to the wall with steel "z" bracket attachment method using 5mm euro screws to attach to the back of the cabinet. All units ship with a steel "z" bracket. This bracket is mounted to the wall by field installers. Installers are responsible for selecting and supplying appropriate fasteners for wall conditions.

Bookcase Construction

All chassis (sides, back, top and bottom panels) are constructed with 3/4" thick core of particle board or MDF rated EPP/SCS/CARB-II material with 3-ply balanced construction. Panels are attached with cam-lock fasteners in conjunction with dowels securely adhered with glue. Shelves on all units are 3/4" thick balance 3 ply panels. Optional heavy duty shelves are 1" thick lumber core balanced 5 ply construction.

Tackboards

Wall mount tackboards are constructed of .75" thick fiberboard. The fabric is precisely aligned and fitted to the tackboard with a sock on cover. Overhead storage tackboards are constructed of .75" thick fiberboard. The fabric is precisely aligned and fitted to the tackboard and adhered to the rigid hardboard with staples. Wall mount cabinets are mounted to the wall with steel "z" bracket attachment method using 5mm euro screws to attach to the back of the cabinet. All units ship with a steel "z" bracket. This bracket is mounted to the wall by field installers. Installers are responsible for selecting and supplying appropriate fasteners for wall conditions.

Adjustable glides

Glides provide 1" of vertical leveling adjustment. Glide bottom is durable metal. Glides are secured in solid wood blocks that are screwed and glued for durability.

Drawers

All drawers are constructed with mitre joint/dowel construction in a natural maple finish with four sides and a bottom, which are attached to a drawer front with screws for easy removal. Drawer fronts are vertically matched in balanced sets. Pencil trays are standard in all box drawers. Drawers are constructed of 1/2" thick wood grained wrapped 5 sided miter-folded construction with 1/4" thick hardboard bottoms reinforced for heavy weight capacity. Drawers have been tested and pass BIFMA 50,000 cycle test. All drawers are guaranteed lifetime with free replacement warranty.

Optional wood drawers

Optional hardwood veneer plywood drawers feature banded top and bottom edges for smoothness. Drawers are dowel joint construction with a UV cured finish over maple veneers, plus a lifetime free replacement guarantee.

Optional Wood Drawer (Any Size) – Option Code P33...\$45 List Price Per Drawer

Drawer fronts

Drawer fronts are vertically matched in balanced sets. Doors feature vertical veneer bookmatched horizontally in sets of 2 / 4 and 6 doors. All drawers and doors have traditional scallop profile edge shape. All tower fronts matched in vertical sets.

Suspensions

All caseloads utilize cold rolled steel zinc plated high-grade drawer suspensions. All suspensions are warranted for the lifetime of the product. Box and File drawers are full extension, featuring steel ball bearings for a smoother quieter range of motion and are rated 100lbs. Lateral file drawers are a progressive action full extension suspension and is rated at 150lbs. Veneer and High Pressure laminate caseloads feature soft close suspension. Thermally Fused Laminate caseloads feature standard suspensions. Lateral files include anti tip mechanism that allow only one drawer to be opened at a time.

Hinges

Units with doors include 95 degree swing hinges.

Filing

Not SO square features a highly durable black plastic extrusion that is securely fastened into a route on top of the drawer to support hanging files. An adjustable crossbar is provided for all file drawers that enables legal/letter filing front to back or side-to-side based on the drawer size..

Locks

Locks are Standard on all drawers below the worksurface. Random lock cores are installed at the factory. Some units may be shipped with the same key number. Locks are Silver, Black or Bronze and match pull finish unless otherwise specified.

DARRAN will also send lock cores separately to the dealer at your request. These units will be send with an empty lock core and the Dealer will receive a shipment of the requested lock core/keys.

Keying

Keying is available either factory or field installed. Factory installed keying is random.

Wire management

Wire management capabilities include standard and optional worksurface grommets. Specify W-1 under surface wire channels for organization and management of all communication wires and cords. Horizontal J-Channel wire management (Sku: W-1) is sold separately to conceal wire under worksurfaces.

Grommets

Metal grommets are provided to match the drawer pull selection. Grommet is available in black, silver or white. Must specify standard or non-standard location. Black plastic grommets are available as an option for vertical applications.

Powerports

A large selection of power pods are available and handle power, data, docking stations and communication. See options section for selection.

LED tasklights

LED task lighting provides high efficiency, low energy lighting with a long life. Surface mounted light is encased in silver aluminum channel with milk lense and rounded end caps. Lights are field installed. Product specifications listed below:

- Diffuser creates a softer light and eliminates hot spots
- Touch dimmer switch
- Can be “daisy chained” up to 90W
- 4.6 watts per foot
- 120 LEDs per meter
- Certification: UL Listed
- 50,000 hour life span.

Color Temp is 4000K

STANDARD VENEER	PREMIUM VENEER	HIGH PRESSURE LAMINATE	THERMALLY FUSED LAMINATE
WAC Amber Cherry.....	N/A.....	GAC Amber Cherry.....	MAC Amber Cherry
WIC Crimson Cherry.....	N/A.....	GIC Crimson Cherry.....	N/A
WHC Honey Cherry.....	N/A.....	GHC Honey Cherry.....	N/A
WOC KoKo Cherry.....	N/A.....	GOC KoKo Cherry.....	MOC KoKo Cherry
WEC Ebony Cherry.....	N/A.....	GEC Ebony Cherry.....	MEC Ebony Cherry
WAM Alabaster Maple.....	N/A.....	GAM Alabaster Maple.....	N/A
WCM Clear Maple.....	N/A.....	GCM Clear Maple.....	N/A
WEW Executive Walnut.....	N/A.....	GEW Executive Walnut.....	N/A
WGW Gunstock Walnut.....	N/A.....	N/A.....	MGW Gunstock Walnut
WBW Henna Walnut.....	N/A.....	N/A.....	N/A
WSW Smokey Walnut.....	N/A.....	N/A.....	N/A
WNW Natural Walnut.....	N/A.....	GNW Natural Walnut.....	N/A
N/A.....	WMO Mocha Oak.....	N/A.....	N/A
N/A.....	WNO Natural Oak.....	N/A.....	N/A
N/A.....	WSO Salted Oak.....	N/A.....	N/A
WNF Natural Oak on Flat Cut.....	N/A.....	N/A.....	N/A
WMF Mocha Oak on Flat Cut.....	N/A.....	N/A.....	N/A
WSF Salted Oak on Flat Cut.....	N/A.....	N/A.....	N/A
N/A.....	TBCO Baby's Cheek.....	N/A.....	N/A
N/A.....	TBSW Brown Sugar.....	N/A.....	N/A
N/A.....	TSTV Studio Teak Walnut.....	GSTV Studio Teak Walnut +10%.....	MTW Studio Teak Walnut
N/A.....	TSMV Seattle Mist Walnut.....	N/A.....	N/A
N/A.....	TSLV Skyline Walnut.....	GSLV Skyline Walnut +10%.....	MSW Skyline Walnut
WWP Designer White Paint.....	N/A.....	GWL Designer White.....	MWL Designer White

HPL TOPS ON TFL PRODUCTS Add 10% - Available with flat edge only

Send 3x3 or larger finish chip for color match. Custom finish upcharge is 3% or \$250 Net (whichever is greater).



Finish

Welltech Finish delivers a superior furniture coating with exceptional performance that can withstand stringent cleaning agents and possesses unparalleled durability, allowing DARRAN to provide lasting, sustainable products to our customers.

Standard profile

NSS Edge

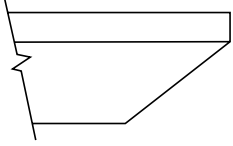

NSS Bevel

"W" 3mm Solid Hardwood Band
"G" HPL Self Edge

NSS Bevel

"M" 2mm PVC Edge with Black Foil



PVC Edgeband

NSS Bevel edge overhang profile is standard on all exposed undersurface edges and black bevel to provide a floating appearance.

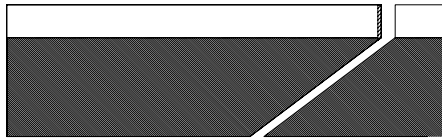

Bridge/return hookup edge

Hookup tops feature reverse cope shaping for custom flush surface appearance and improved use.

Pulls/knobs

Factory Installed

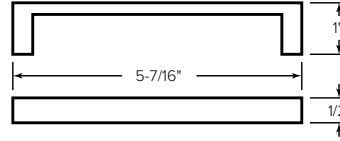

PL-115 Matte Black
PL-116 Matte Nickel

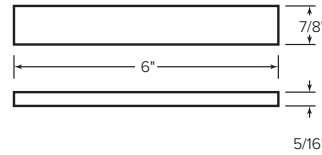

PL-210 Anodized Aluminum



Finger pulls (optional)

Arrow indicates finger pull location(not available on TFL)

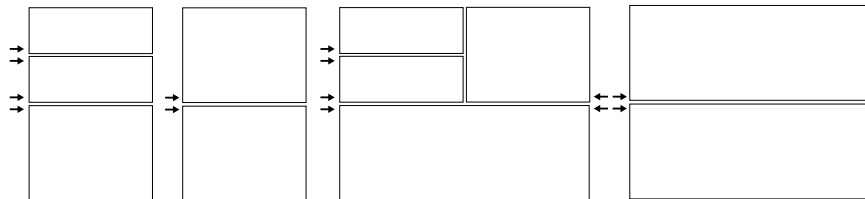

b/b/f

f/f

multi

lateral/lateral

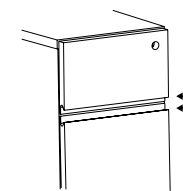

finger pull side view

DARRAN®



TM30
Black
1-5/8" Dia.



TM31
Silver
1-5/8" Dia.



TM34
White
1-5/8" Dia.

Optional grommets

Factory Installed

Grommets (Standard Location)

Specify Color and Left/Right/Center - \$50 ea.

- Black: TM30-R (Right), TM30-L (Left), TM30-C (Center)
- Silver: TM31-R (Right), TM31-L (Left), TM31-C (Center)
- White: TM34-R (Right), TM34-L (Left), TM34-C (Center)

Grommets (Non-Standard Location)

Provide drawing w/ Grommet Location and Specify Color - \$95 ea.

- Black: TM30-NS
- Silver: TM31-NS
- White: TM34-NS

Not So Square Grommets | Grommet Reference

TM50
Black
1-5/8" Dia.



Grommets (vertical surface)

Standard Location - \$50 ea.

- Black Plastic Vertical Surface: TM50-C (Bottom Center)

Non-Standard Location - \$95 ea.

- Black Plastic Vertical Surface: TM50-NS

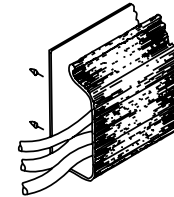

W1

Horizontal J-channel

Horizontal J-Channel wire management (Sku: W-1) is sold separately to conceal wire under worksurfaces.

Standard grommet location reference

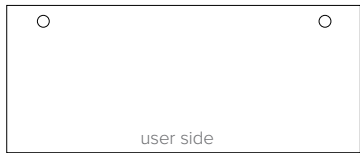

Desk
Specify Right or Left Grommet

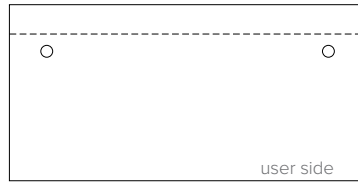

6" Overhang Desk
Specify Right or Left Grommet

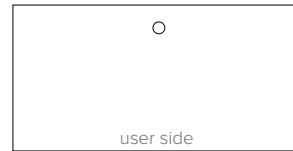

Bridge
Center Grommet



Return (Left Pedestal Shown)
Right Pedestal - Left Grommet
Left Pedestal - Right Grommet

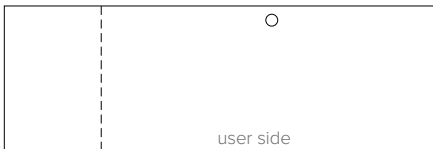

Workstation Credenza
Center Kneespace Grommet

Ganging – flush cut modification

30”H Casework Worksurface & Base Ganging Modifications

To gang two casework units, each unit end to be ganged must be flush cut modified for gapless surfaces and cabinet chassis.

Order Option:

- FC-B: Flush Unit Both Sides(Facing) for Ganging - \$100
- FC-L: Flush Unit Left (Facing) for Ganging - \$100
- FC-R: Flush Unit Right (Facing) for Ganging - \$100

Flush cut modification per unit includes all modifications to gang to one end or both ends when units are ganged. Modification includes tops, base and molding. Modification reduces width size approximately 1” per end.

Example:
 NSS3121100W Two Drawer Lateral File (Left) Flush Cut Right – FC-R...\$100
 NSS7221054 Kneespace Credenza (Right) Flush Cut Left – FC-L...\$100

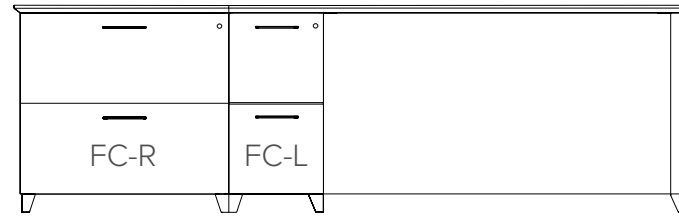

Height reference

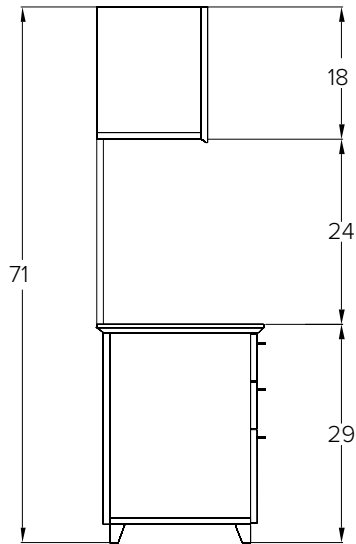

Typical Single Height Side Profile Wall Hung Overhead

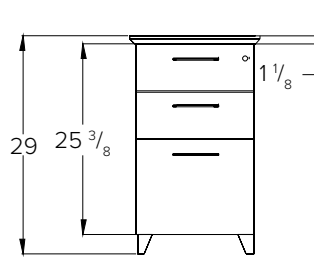

Pedestal Front Profile Box/Box/File

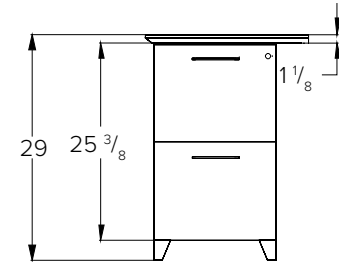

Pedestal Front Profile File/File

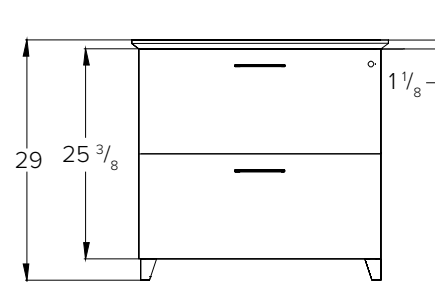

Pedestal Front Profile Lateral File

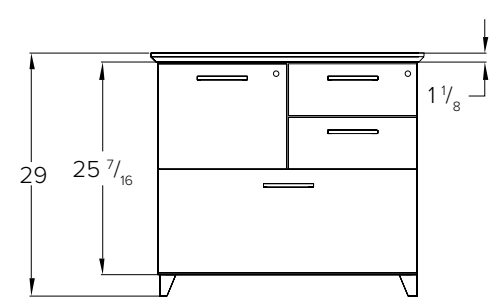

Pedestal Front Profile Multi-File

Credenzas, overheads and towers

Towers and overheads are standard flat top for easy ganging. No modification needed.

Credenza must be specified for flush cut ends when ganging to towers.

Credenza width matches overhead width when both credenza ends are flush cut.

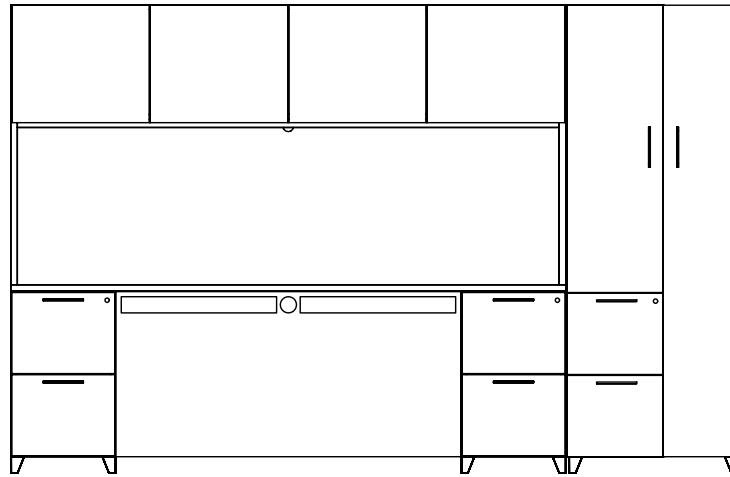

CABINET ANGULAR FOOT
Cast Angular Foot

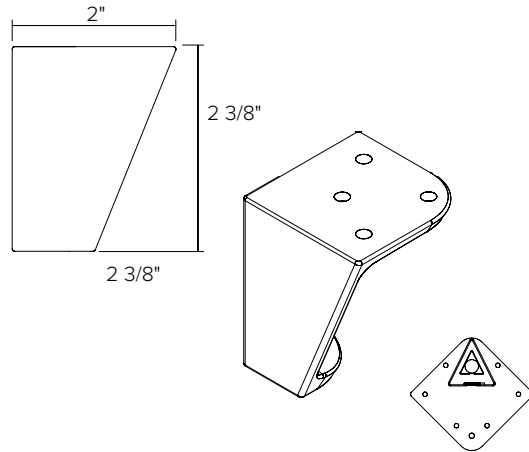

DESK ANGULAR POST

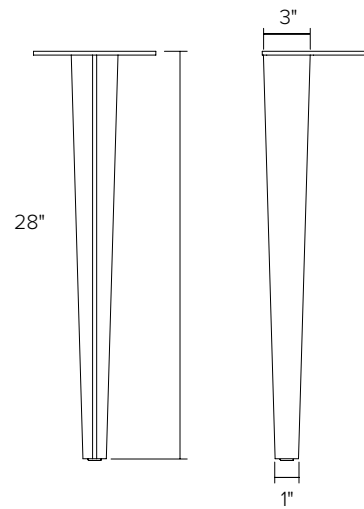

DESK ANGULAR SLEIGH BASE

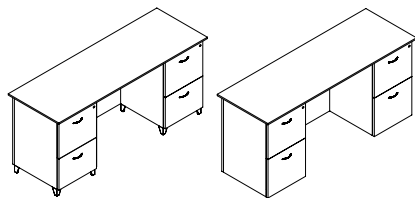
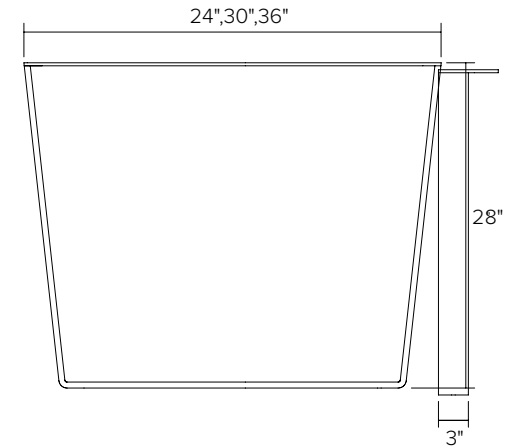

Option: Delete Feet/Extended Fronts

Standard metal feet can be deleted on any unit. Delete foot option extends chassis cabinets to floor. Drawer/Door fronts are extended to within 3/8" of full cabinet height when delete foot option is specified.

Delete Foot Chassis Modification Option:
D8. . .No Charge

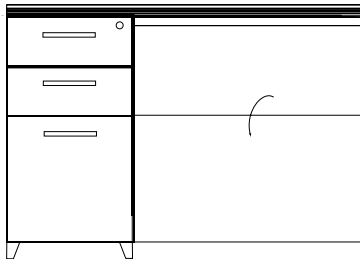

M34
Drop Door Tech Modesty

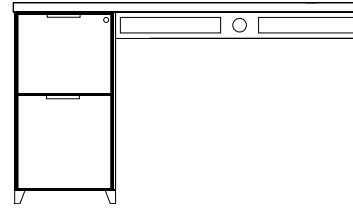

M51
Open Back Modesty with 4"
Wire Management Rail

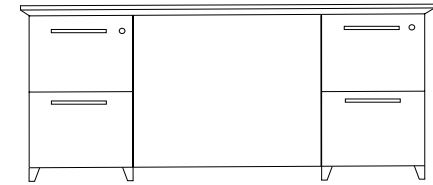

M37
Fixed Full Modesty

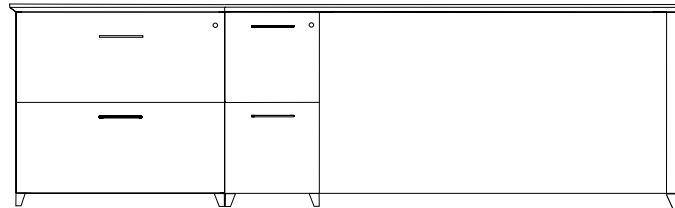

Grain direction

Veneer chassis parts are vertical grain. The backs of Thermally Fused Laminate overheads, wall hungs, wall hung shelves and flush chassis desks are horizontal grain. Bridges, returns, and credenza kneespace Thermally Fused Laminate backs over 60" are horizontal grain. Doors feature vertical veneer bookmatched horizontally in sets of 2,4, and 6 doors. Tower fronts are matched in vertical sets.

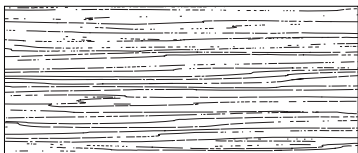

Desk

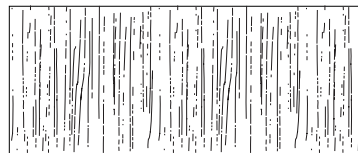

Runoff Desk
Grain Direction on TFL Units
Above 60" runs end to end

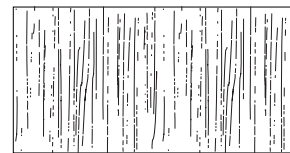

Bridge
Grain Direction on TFL Units
Above 60" runs end to end



Credenza

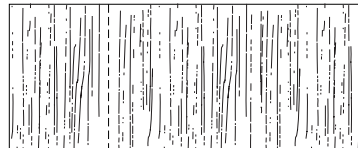

Return
Grain Direction on TFL Units
Above 60" runs end to end

NOT SO square office

Freestanding Desks
Breakfront - Full Pedestal With Modesty Panel

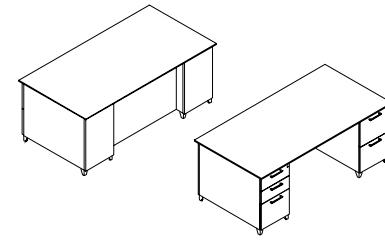

[Click here to view statement of line](#)

1 Select Model

w" x d" x h"

Weight	84 x 36 x 29	72 x 36 x 29	72 x 30 x 29	66 x 30 x 29
350	315	295	270	

Standard Veneer Top Standard Veneer Chassis		Premium Veneer Top Premium Veneer Chassis		High Pressure Laminate Top Veneer Chassis		Thermally Fused Laminate Top Thermally Fused Laminate Chassis	
NSS8436DD000W	5013	NSS8436DD000P	5515	NSS8436DD000G	5013	NSS8436DD000M	3393
NSS7236DD000W	4660	NSS7236DD000P	5127	NSS7236DD000G	4660	NSS7236DD000M	3272
NSS7230DD000W	4447	NSS7230DD000P	4891	NSS7230DD000G	4447	NSS7230DD000M	3228
NSS6630DD000W	4405	NSS6630DD000P	4847	NSS6630DD000G	4405	NSS6630DD000M	3157

Product Features

- 6" recessed modesty
- Breakfront modesty
- Locking drawers
- Soft close suspension drawer(s)
- Standard Silver Feet (optional White, Black)

Options

Accessories

- K28: Articulating Keyboard w/ Mouse - \$390
- K31: Center Drawer w/out Pull - \$205

Chassis

- MODCX: Modify breakfront chassis to flush front chassis - n/c

Drawer

- P6: Modify File/File to Box/Box/File - \$55 per pedestal
- P33: Wood Drawer Upgrade - \$45 per drawer
- WPD3061: Designer White - \$80 per pedestal

Feet

- D8: Delete feet (extend fronts to floor) - n/c

Grommets (Standard Location)

Specify Color and Location Right/Left - \$50 ea.

- Black: TM30-R (Right), TM30-L (Left)
- Silver: TM31-R (Right), TM31-L (Left)
- White: TM34-R (Right), TM34-L (Left)

Grommets (Non-Standard Location)

Provide drawing w/ Grommet Location and Specify Color - \$95 ea.

- Black: TM30-NS
- Silver: TM31-NS
- White: TM34-NS

Modesty

- HM51: Half Modesty - \$205
- HM39: SilverLuma frame/frost (Half Modesty) - \$340

Premium Finish Option

- Specify foot Metal Finish color - \$130 per unit. Contact customer service
- MFB: Black, MFW: White, MFDB: Dark Bronze, MFGM: Matte Gold

2 Select Finish

[Click to view finishes](#)

Metal Finish

MFS Silver. Additional

Metal Finishes are available, options

WAC	WNW
WIC	WWP
WHC	WNF(Natural
WOC	Oak on Flat
WEC	Cut)
WAM	WSF(Salted
WCM	Oak on Flat
WEW	Cut)
WGW	WMF(Mocha
WBW	Oak on Flat
WSW	Cut)

TBCO
TBSW
TSTV
TSMV
TSLV
TOBW
WMO
WNO
WSO

GAC	GSLV
GIC	+10%
GHC	GWL
GOC	
GEC	
GAM	
GCM	
GEW	
GNW	
GSTV	+10%

MAC
MOC
MEC
MGW
MTW
MSW
MWL

3 Select Edge

[Click to view edges](#)



4 Select Hardware

[Click to view details](#)



NOT SO square office

Freestanding Desks
Table Desk With Sleigh Base

[Click here to view statement of line](#)

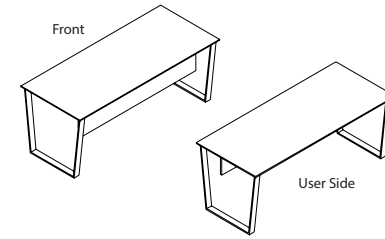

1 Select Model

w" x d" x h"	Weight
72 x 36 x 29	150
72 x 30 x 29	135
66 x 30 x 29	125

Standard Veneer Top Standard Veneer Chassis		Premium Veneer Top Premium Veneer Chassis		High Pressure Laminate Top Veneer Chassis		Thermally Fused Laminate Top Thermally Fused Laminate Chassis	
NSS7236DT107W	4338	NSS7236DT107P	4771	NSS7236DT107G	4338	NSS7236DT107M	2593
NSS7230DT107W	4151	NSS7230DT107P	4567	NSS7230DT107G	4151	NSS7230DT107M	2505
NSS6630DT107W	4098	NSS6630DT107P	4508	NSS6630DT107G	4098	NSS6630DT107M	2414

Product Features

- Half modesty panel standard
- Freestanding use
- Standard table desk sleigh base is silver Metal Finish (optional white or black)

2 Select Finish

[Click to view finishes](#)

Metal Finish

MFS Silver. Additional

Metal Finishes are available, options

WAC	WNW
WIC	WWP
WHC	WNF(Natural
WOC	Oak on Flat
WEC	Cut)
WAM	WSF(Salted
WCM	Oak on Flat
WEW	Cut)
WGW	WMF(Mocha
WBW	Oak on Flat
WSW	Cut)

TBCO
TBSW
TSTV
TSMV
TSLV
TOBW
WMO
WNO
WSO

GAC
GIC
GHC
GOC
GEC
GAM
GCM
GEW
GNW
GSTV +10%

MAC
MOC
MEC
MGW
MTW
MSW
MWL

3 Select Edge

[Click to view edges](#)



4 Select Hardware

[Click to view details](#)

Hardware
N/A

Hardware
N/A

Hardware
N/A

Hardware
N/A

Options

Accessories

- K28: Articulating Keyboard w/ Mouse - \$390
- K31: Center Drawer w/out Pull - \$205
- W17: Wire Mgmt. Cover matches leg finish - \$80

Grommets (Standard Location)

Specify Color and Location Right/Left - \$50 ea.

- Black: TM30-R (Right), TM30-L (Left)
- Silver: TM31-R (Right), TM31-L (Left)
- White: TM34-R (Right), TM34-L (Left)

Grommets (Non-Standard Location)

Provide drawing w/ Grommet Location and Specify Color - \$95 ea.

- Black: TM30-NS
- Silver: TM31-NS
- White: TM34-NS

Premium Finish Option

- Specify foot Metal Finish color - \$160 per unit. Contact customer service
- MFB: Black, MFW: White

NOT SO square office

Freestanding Desks
Adjustable Desk / Motorized

[Click here to view statement of line](#)

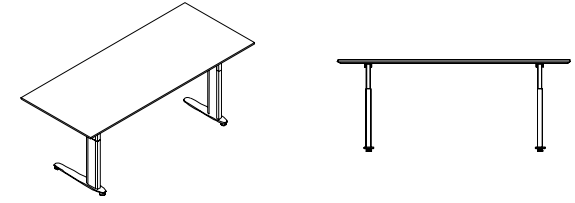

1 Select Model

w" x d" x h"	Weight
72 x 30 x 29-48	230
66 x 30 x 29-48	215
60 x 30 x 29-48	200

Standard Veneer Top Standard Veneer Chassis		Premium Veneer Top Premium Veneer Chassis		High Pressure Laminate Top Veneer Chassis		Thermally Fused Laminate Top Thermally Fused Laminate Chassis	
NSS7230DT090W	4528	NSS7230DT090P	4982	NSS7230DT090G	4528	NSS7230DT090M	3030
NSS6630DT090W	4503	NSS6630DT090P	4955	NSS6630DT090G	4503	NSS6630DT090M	2962
NSS6030DT090W	4475	NSS6030DT090P	4923	NSS6030DT090G	4475	NSS6030DT090M	2886

Product Features

- Adjustable height base - silver, white or black
- Electronic mechanism with programmable lift
- Unit includes 72" power cord

Notes

- Shipped KD

Options

Accessories

- K28: Articulating Keyboard w/ Mouse - \$390
- K31: Center Drawer w/out Pull - \$205
- W18: Coil Cable Manager - \$160

Grommets (Standard Location)

Specify Color and Location Right/Left - \$50 ea.

- Black: TM30-R (Right), TM30-L (Left)
- Silver: TM31-R (Right), TM31-L (Left)
- White: TM34-R (Right), TM34-L (Left)

Grommets (Non-Standard Location)

Provide drawing w/ Grommet Location and Specify Color - \$95 ea.

- Black: TM30-NS
- Silver: TM31-NS
- White: TM34-NS

Modesty

- HM3: Veneer Half Modesty - \$260 (For "W" and "G")
- HM3M: Melamine Half Modesty - \$205 (For "M")

2 Select Finish

[Click to view finishes](#)

WAC	WNW
WIC	WWP
WHC	WNF(Natural
WOC	Oak on Flat
WEC	Cut)
WAM	WSF(Salted
WCM	Oak on Flat
WEW	Cut)
WGW	WMF(Mocha
WBW	Oak on Flat
WSW	Cut)

TBCO
TBSW
TSTV
TSMV
TSLV
TOBW
WMO
WNO
WSO

GAC GSLV
GIC +10%
GHC GWL
GOC
GEC
GAM
GCM
GEW
GNW
GSTV +10%

MAC
MOC
MEC
MGW
MTW
MSW
MWL

3 Select Edge

[Click to view edges](#)



4 Select Hardware

[Click to view details](#)

Hardware
N/A

Hardware
N/A

Hardware
N/A

Hardware
N/A

NOT SO square office

Freestanding Workstation Desks
Breakfront Single Pedestal

[Click here to view statement of line](#)

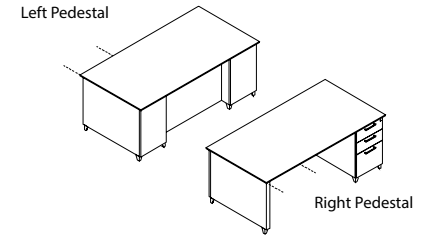

1 Select Model

w" x d" x h"	Weight
Left Pedestal	
72 x 36 x 29	300
72 x 30 x 29	270
66 x 30 x 29	260
Right Pedestal	
72 x 36 x 29	300
72 x 30 x 29	270
66 x 30 x 29	260

Standard Veneer Top Standard Veneer Chassis		Premium Veneer Top Premium Veneer Chassis		High Pressure Laminate Top Veneer Chassis		Thermally Fused Laminate Top Thermally Fused Laminate Chassis	
NSS7236DS009W	4551	NSS7236DS009P	5007	NSS7236DS009G	4551	NSS7236DS009M	2755
NSS7230DS009W	4346	NSS7230DS009P	4781	NSS7230DS009G	4346	NSS7230DS009M	2687
NSS6630DS009W	4309	NSS6630DS009P	4741	NSS6630DS009G	4309	NSS6630DS009M	2636
NSS7236DS010W	4551	NSS7236DS010P	5007	NSS7236DS010G	4551	NSS7236DS010M	2755
NSS7230DS010W	4346	NSS7230DS010P	4781	NSS7230DS010G	4346	NSS7230DS010M	2687
NSS6630DS010W	4309	NSS6630DS010P	4741	NSS6630DS010G	4309	NSS6630DS010M	2636

Product Features

- 6" recessed modesty
- Full extension drawers - locking
- Soft close suspension drawer(s)
- Standard Silver Feet (optional White, Black)

Options

Accessories

- K28: Articulating Keyboard w/ Mouse - \$390
- K31: Center Drawer - \$205

Chassis

- MODCX-1: Modify breakfront chassis to flush front chassis w/ 6" overhang top - n/c

Drawer

- P33: Wood Drawer Upgrade - \$45 per drawer
- WPD3061: Designer White - \$80 per pedestal

Feet

- D8: Delete feet (extend fronts to floor) - n/c

Grommets (Standard Location)

Specify Color and Location Right/Left - \$50 ea.

- Black: TM30-R (Right), TM30-L (Left)
- Silver: TM31-R (Right), TM31-L (Left)
- White: TM34-R (Right), TM34-L (Left)

Grommets (Non-Standard Location)

Provide drawing w/ Grommet Location and Specify Color - \$95 ea.

- Black: TM30-NS
- Silver: TM31-NS
- White: TM34-NS

Modesty

- HM39: SilverLuma frame/frost (Half Modesty) - \$340
- HM51: Half Modesty - \$205

Premium Finish Option

- Specify foot Metal Finish color - \$160 per unit. Contact customer service
- MFB: Black, MFW: White, MFDB: Dark Bronze, MFGM: Matte Gold

2 Select Finish

[Click to view finishes](#)

Metal Finish

MFS Silver. Additional Metal Finishes are available, options

WAC	WNW
WIC	WWP
WHC	WNF(Natural
WOC	Oak on Flat
WEC	Cut)
WAM	WSF(Salted
WCM	Oak on Flat
WEW	Cut)
WGW	WMF(Mocha
WBW	Oak on Flat
WSW	Cut)

TBCO
TBSW
TSTV
TSMV
TSLV
TOBW
WMO
WNO
WSO

GAC	GSLV
GIC	+10%
GHC	GWL
GOC	
GEC	
GAM	
GCM	
GEW	
GNW	
GSTV	+10%

MAC
MOC
MEC
MGW
MTW
MSW
MWL

3 Select Edge

[Click to view edges](#)



4 Select Hardware

[Click to view details](#)



NOT SO square office

Conference Workstation Desks
Rectangle Top With Sleigh Base

[Click here to view statement of line](#)

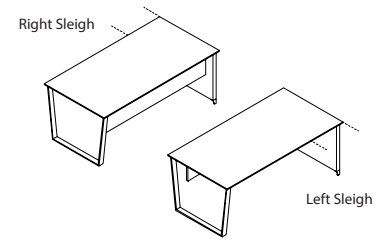

1 Select Model

w" x d" x h"
Right Sleigh Leg

72 x 36 x 29	165
72 x 30 x 29	145
66 x 30 x 29	125
60 x 24 x 29	115
54 x 24 x 29	105
Left Sleigh Leg	
72 x 36 x 29	165
72 x 30 x 29	145
66 x 30 x 29	125
60 x 24 x 29	115
54 x 24 x 29	105

	Standard Veneer Top Standard Veneer Chassis	Premium Veneer Top Premium Veneer Chassis	High Pressure Laminate Top Veneer Chassis	Thermally Fused Laminate Top Thermally Fused Laminate Chassis
NSS7236DC766W 4145	NSS7236DC766P 4560	NSS7236DC766G 4145	NSS7236DC766M 2493	
NSS7230DC766W 3959	NSS7230DC766P 4356	NSS7230DC766G 3959	NSS7230DC766M 2352	
NSS6630DC766W 3919	NSS6630DC766P 4311	NSS6630DC766G 3919	NSS6630DC766M 2279	
NSS6024DC766W 2548	NSS6024DC766P 2804	NSS6024DC766G 2548	NSS6024DC766M 2227	
NSS5424DC766W 2519	NSS5424DC766P 2772	NSS5424DC766G 2519	NSS5424DC766M 2176	

2 Select Finish

[Click to view finishes](#)

Metal Finish

MFS Silver. Additional
Metal Finishes are
available, options

WAC	WNW
WIC	WWP
WHC	WNF(Natural
WOC	Oak on Flat
WEC	Cut)
WAM	WSF(Salted
WCM	Oak on Flat
WEW	Cut)
WGW	WMF(Mocha
WBW	Oak on Flat
WSW	Cut)

TBCO
TBSW
TSTV
TSMV
TSLV
TOBW
WMO
WNO
WSO

GAC	GSLV
GIC	+10%
GHC	GWL
GOC	
GEC	
GAM	
GCM	
GEW	
GNW	
GSTV	+10%

MAC
MOC
MEC
MGW
MTW
MSW
MWL

3 Select Edge

[Click to view edges](#)



4 Select Hardware

[Click to view details](#)

Hardware
N/A

Hardware
N/A

Hardware
N/A

Hardware
N/A

Product Features

- 2" thick end panel
- Angular silver metal sleigh base
- Half modesty
- Standard Silver Feet and Base (optional White, Black)

Notes

- K28 and K31 will not fit on 24" deep units w/ half modesty

Options

Accessories

- K31: Center drawer - \$205
- K28: Articulating Keyboard w/ Mouse - \$390
- W17: Wire Mgmt. Cover, matches leg finish - \$80

Grommets (Standard Location)

- Specify Color - \$50 ea.
- Black: TM30-C (Center)
 - Silver: TM31-C (Center)
 - White: TM34-C (Center)

Grommets (Non-Standard Location)

- Provide drawing w/ Grommet Location and Specify Color - \$95 ea.
- Black: TM30-NS
 - Silver: TM31-NS
 - White: TM34-NS

Modesty

- DM: Delete half modesty - n/c
- HM45: SilverLuma frame/frost insert (half modesty) - \$415

Premium Finish Option

- Specify foot Metal Finish color - \$160 per unit. Contact customer service
- MFB: Black, MFW: White

NOT SO square office

Conference Workstation Desks
Angular Top With Sleigh Base

[Click here to view statement of line](#)

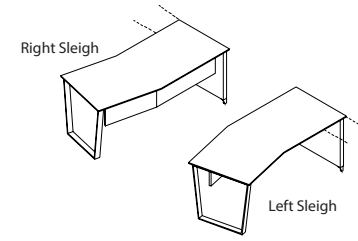

1 Select Model

w" x d" x h"
Left Sleigh leg
84 x 30/36 x 29
72 x 30/36 x 29
Right Sleigh leg
84 x 30/36 x 29
72 x 30/36 x 29

Weight	Standard Veneer Top Standard Veneer Chassis	Premium Veneer Top Premium Veneer Chassis	High Pressure Laminate Top Veneer Chassis	Thermally Fused Laminate Top Thermally Fused Laminate Chassis
180	NSS8436DC785W 4620	NSS8436DC785P 5082	NSS8436DC785G 4620	NSS8436DC785M 3163
155	NSS7236DC785W 4214	NSS7236DC785P 4636	NSS7236DC785G 4214	NSS7236DC785M 2947
180	NSS8436DC784W 4620	NSS8436DC784P 5082	NSS8436DC784G 4620	NSS8436DC784M 3163
155	NSS7236DC784W 4214	NSS7236DC784P 4636	NSS7236DC784G 4214	NSS7236DC784M 2947

Product Features

- 2" thick end panel with metal legs
- Angled half modesty
- Standard Silver Feet and Base (optional White, Black)

Options

Accessories

- K31: Center drawer - \$205
- K28: Articulating Keyboard w/ Mouse - \$390
- W17: Wire Mgmt. Cover, matches leg finish - \$80

Grommets (Standard Location)

Specify Color - \$50 ea.

- Black: TM30-C (Center)
- Silver: TM31-C (Center)
- White: TM34-C (Center)

Grommets (Non-Standard Location)

Provide drawing w/ Grommet Location and Specify Color - \$95 ea.

- Black: TM30-NS
- Silver: TM31-NS
- White: TM34-NS

Modesty

- DM: Delete half modesty - n/c

Premium Finish Option

- Specify foot Metal Finish color - \$160 per unit. Contact customer service
- MFB: Black, MFW: White

2 Select Finish

Click to view finishes

WAC	WNW
WIC	WWP
WHC	WNF(Natural
WOC	Oak on Flat
WEC	Cut)
WAM	WSF(Salted
WCM	Oak on Flat
WEW	Cut)
WGW	WMF(Mocha
WBW	Oak on Flat
WSW	Cut)

TBCO
TBSW
TSTV
TSMV
TSLV
TOBW
WMO
WNO
WSO

GAC GSLV
GIC +10%
GHC GWL
GOC
GEC
GAM
GCM
GEW
GNW
GSTV +10%

MAC
MOC
MEC
MGW
MTW
MSW
MWL

3 Select Edge

Click to view edges



4 Select Hardware

Click to view details

Hardware
N/A

Hardware
N/A

Hardware
N/A

Hardware
N/A

NOT SO square office

Runoff Conference Workstation Desks
 Rectangle Runoff Desk With Sleigh Base

[Click here to view statement of line](#)

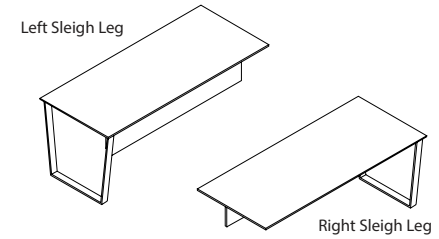

1 Select Model

w" x d" x h"
 Right Sleigh Leg
 72 x 30 x 29
 66 x 30 x 29
 60 x 30 x 29
 54 x 24 x 29
 Left Sleigh Leg
 72 x 30 x 29
 66 x 30 x 29
 60 x 30 x 29
 54 x 24 x 29

Weight

	Standard Veneer Top Standard Veneer Chassis		Premium Veneer Top Premium Veneer Chassis		High Pressure Laminate Top Veneer Chassis		Thermally Fused Laminate Top Thermally Fused Laminate Chassis	
	NSS7230DR770W	3555	NSS7230DR770P	3911	NSS7230DR770G	3555	NSS7230DR770M	1761
	NSS6630DR770W	3527	NSS6630DR770P	3880	NSS6630DR770G	3527	NSS6630DR770M	1642
	NSS6030DR770W	3498	NSS6030DR770P	3848	NSS6030DR770G	3498	NSS6030DR770M	1586
	NSS5424DR770W	2247	NSS5424DR770P	2473	NSS5424DR770G	2247	NSS5424DR770M	1503
	NSS7230DR771W	3555	NSS7230DR771P	3911	NSS7230DR771G	3555	NSS7230DR771M	1761
	NSS6630DR771W	3527	NSS6630DR771P	3880	NSS6630DR771G	3527	NSS6630DR771M	1642
	NSS6030DR771W	3498	NSS6030DR771P	3848	NSS6030DR771G	3498	NSS6030DR771M	1586
	NSS5424DR771W	2247	NSS5424DR771P	2473	NSS5424DR771G	2247	NSS5424DR771M	1503

2 Select Finish

[Click to view finishes](#)

Metal Finish

MFS Silver. Additional

Metal Finishes are available, options

WAC WNW
 WIC WWP
 WHC WNF(Natural
 WOC Oak on Flat
 WEC Cut)
 WAM WSF(Salted
 WCM Oak on Flat
 WEW Cut)
 WGW WMF(Mocha
 WBW Oak on Flat
 WSW Cut)

TBCO
 TBSW
 TSTV
 TSMV
 TSLV
 TOBW
 WMO
 WNO
 WSO

GAC GSLV
 GIC +10%
 GHC GWL
 GOC
 GEC
 GAM
 GCM
 GEW
 GNW
 GSTV +10%

MAC
 MOC
 MEC
 MGW
 MTW
 MSW
 MWL

3 Select Edge

[Click to view edges](#)



4 Select Hardware

[Click to view details](#)

Hardware
 N/A

Hardware
 N/A

Hardware
 N/A

Hardware
 N/A

Product Features

- Half modesty standard
- Standard Silver Base (optional White, Black)

Notes

- When Specifying Runoff Desk w/ Bench Credenzas, You Must: Specify Runoff Desk Bench Support.
- K28 and K31 will not fit on 24" deep units w/ half modesty
- Hooks to freestanding unit

Options

Accessories

- K28: Articulating Keyboard w/ Mouse - \$390
- K31: Center Drawer - \$205
- W17: Wire Mgmt. Cover, matches leg finish - \$80

Bench Support

- 23BRL30: 30" Bench Support - "W" and "G" \$195 - "M" \$130
- 23BRL24: 24" Bench Support - "W" and "G" \$155 - "M" \$115

Grommets (Standard Location)

Specify Color - \$50 ea.

- Black: TM30-C (Center)
- Silver: TM31-C (Center)
- White: TM34-C (Center)

Grommets (Non-Standard Location)

Provide drawing w/ Grommet Location and Specify Color - \$95 ea.

- Black: TM30-NS
- Silver: TM31-NS
- White: TM34-NS

Modesty

- DM: Delete Half Modesty - n/c
- HM45: SilverLuma frame/frost insert (half modesty) - \$395

Premium Finish Option

- Specify foot Metal Finish color - \$160 per unit. Contact customer service
- MFB: Black, MFW: White, MFD: Dark Bronze, MFGM: Matte Gold

NOT SO square office

"L" Workstation Returns
File/File

[Click here to view statement of line](#)

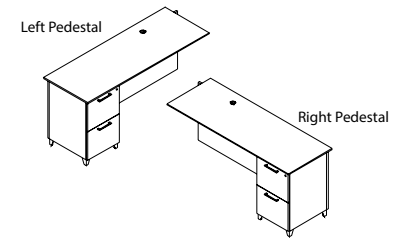

1 Select Model

w" x d" x h"	Weight
Left Pedestal	
60 x 22 x 29	160
54 x 22 x 29	145
48 x 22 x 29	135
42 x 22 x 29	125
Right Pedestal	
60 x 22 x 29	160
54 x 22 x 29	145
48 x 22 x 29	135
42 x 22 x 29	125

	Standard Veneer Top Standard Veneer Chassis		Premium Veneer Top Premium Veneer Chassis		High Pressure Laminate Top Veneer Chassis		Thermally Fused Laminate Top Thermally Fused Laminate Chassis	
WAC			TBCO		GAC	GSLV		MAC
WIC			TBSW		GIC	+10%		MOC
WHC	WNW		TSTV		GHC	GWL		MEC
WOC	WNF(Natural		TSMV		GOC			MGW
WEC	Cut)		TSLV		GEC			MTW
WAM	WSF(Salted		TOBW		GAM			MSW
WCM	Oak on Flat		WMO		GCM			MWL
WEW	Cut)		WNO		GEW			
WGW	WMF(Mocha		WSO		GNW			
WBW	Oak on Flat				GSTV	+10%		
WSW	Cut)							

2 Select Finish

Click to view finishes

Metal Finish

MFS Silver. Additional

Metal Finishes are available, options

WAC	WNW
WIC	WWP
WHC	WNF(Natural
WOC	Oak on Flat
WEC	Cut)
WAM	WSF(Salted
WCM	Oak on Flat
WEW	Cut)
WGW	WMF(Mocha
WBW	Oak on Flat
WSW	Cut)

3 Select Edge

Click to view edges



4 Select Hardware

Click to view details



Product Features

- All drawers lock
- Standard full fixed modesty panel
- Standard metal grommet matches pull finish
- Standard silver feet (optional White, Black)
- Soft close suspension drawer(s)

Notes

- Laminate version "M" standard w/ open plan back
- Returns with Grommets in top will automatically have wire channel and outfeed holes in back.
- Unit not designed for open plan use. Select OPB for Open Plan application

Options

Accessories

- K28: Articulating Keyboard w/ Mouse - \$390

Drawer

- P6: Modify File/File to Box/Box/File - \$55 per pedestal
- P33: Wood Drawer Upgrade - \$45 per drawer
- P40W: extra Box/Box/File or File/File to Knee space - \$910
- P40M: extra Box/Box/File or File/File to Knee space - \$720
- WPD3061: Designer White - \$80 per pedestal

Feet

- D8: Delete feet (extend fronts to floor) - n/c

Flush Cut

- FC-L: Flush Unit Left (Facing) for Ganging - \$55
- FC-R: Flush Unit Right(Facing) for Ganging - \$55

Grommets (Non-Standard Location)

Provide drawing w/ Grommet Location and Specify Color - \$95 ea.

- Black: TM30-NS
- Silver: TM31-NS
- White: TM34-NS

Modesty

- M34T: Drop Door Tech Modesty - \$130
- M34TM: "M" Style Drop Door Tech Modesty - \$130
- M51: Open Back Modesty with Wire Mgmt Rail - Deduct \$95

Open Plan _ Finished Back

- OPB: "W" "G" Style - Modify Unit for Open Plan Application - \$295

Premium Finish Option

- Specify foot Metal Finish color - \$160 per unit. Contact customer service
- MFB: Black, MFW: White, MFDB: Dark Bronze, MFGM: Matte Gold

NOT SO square office

"L" Workstation Returns
Lateral File

[Click here to view statement of line](#)

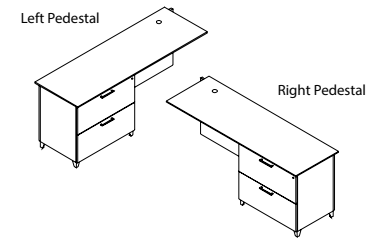

1 Select Model

w" x d" x h"	Weight
Left Pedestal	
72 x 22 x 29	200
66 x 22 x 29	190
60 x 22 x 29	180
54 x 22 x 29	170
48 x 22 x 29	165
Right Pedestal	
72 x 22 x 29	200
66 x 22 x 29	190
60 x 22 x 29	180
54 x 22 x 29	170
48 x 22 x 29	165

Standard Veneer Top Standard Veneer Chassis		Premium Veneer Top Premium Veneer Chassis		High Pressure Laminate Top Veneer Chassis		Thermally Fused Laminate Top Thermally Fused Laminate Chassis	
NSS7222RE187W	3752	NSS7222RE187P	4128	NSS7222RE187G	3752	NSS7222RE187M	2252
NSS6622RE187W	3718	NSS6622RE187P	4091	NSS6622RE187G	3718	NSS6622RE187M	2162
NSS6022RE187W	3663	NSS6022RE187P	4029	NSS6022RE187G	3663	NSS6022RE187M	2073
NSS5422RE187W	3629	NSS5422RE187P	3992	NSS5422RE187G	3629	NSS5422RE187M	1989
NSS4822RE187W	3540	NSS4822RE187P	3894	NSS4822RE187G	3540	NSS4822RE187M	1925
NSS7222RE188W	3752	NSS7222RE188P	4128	NSS7222RE188G	3752	NSS7222RE188M	2252
NSS6622RE188W	3718	NSS6622RE188P	4091	NSS6622RE188G	3718	NSS6622RE188M	2162
NSS6022RE188W	3663	NSS6022RE188P	4029	NSS6022RE188G	3663	NSS6022RE188M	2073
NSS5422RE188W	3629	NSS5422RE188P	3992	NSS5422RE188G	3629	NSS5422RE188M	1989
NSS4822RE188W	3540	NSS4822RE188P	3894	NSS4822RE188G	3540	NSS4822RE188M	1925

Product Features

- Full modesty panel
- Standard Silver Feet (optional White, Black)
- Standard metal grommet matches pull finish
- Features ball bearing suspensions, suspensions are full extension

Notes

- Keyboard not available on noted 48" /54" units. Returns with Grommets in top will automatically have wire channel and outfeed holes in back.
- Laminate version "M" standard w/ open plan back
- Unit not designed for open plan use. Select OPB for Open Plan application

Options

Accessories

- K28: Articulating Keyboard w/ Mouse - \$390

Drawer

- P33: Wood Drawer Upgrade - \$45 per drawer
- P40W: extra Box/Box/File or File/File to Knee space - \$910
- P40M: extra Box/Box/File or File/File to Knee space - \$720
- WPD3061: Designer White - \$80 per pedestal

Feet

- D8: Delete feet (extend fronts to floor) - n/c

Flush Cut

- FC-L: Flush Unit Left (Facing) for Ganging - \$55
- FC-R: Flush Unit Right(Facing) for Ganging - \$55

Grommets (Non-Standard Location)

- Provide drawing w/ Grommet Location and Specify Color - \$95 ea.
- Black: TM30-NS
- Silver: TM31-NS
- White: TM34-NS

Modesty

- M34T: Drop Door Tech Modesty - \$130
- M34TM: "M" Style Drop Door Tech Modesty - \$130
- M51: Open Back Modesty with Wire Mgmt Rail - Deduct \$95

Open Plan _ Finished Back

- OPB: "W" "G" Style - Modify Unit for Open Plan Application - \$295

Premium Finish Option

- Specify foot Metal Finish color - \$160 per unit. Contact customer service
- MFB: Black, MFW: White, MFDB: Dark Bronze, MFGM: Matte Gold

2 Select Finish

[Click to view finishes](#)

Metal Finish

MFS Silver. Additional

Metal Finishes are available, options

WAC	WNW
WIC	WWP
WHC	WNF(Natural
WOC	Oak on Flat
WEC	Cut)
WAM	WSF(Salted
WCM	Oak on Flat
WEW	Cut)
WGW	WMF(Mocha
WBW	Oak on Flat
WSW	Cut)

TBCO
TBSW
TSTV
TSMV
TSLV
TOBW
WMO
WNO
WSO

GAC	GSLV
GIC	+10%
GHC	GWL
GOC	
GEC	
GAM	
GCM	
GEW	
GNW	
GSTV	+10%

MAC
MOC
MEC
MGW
MTW
MSW
MWL

3 Select Edge

[Click to view edges](#)



4 Select Hardware

[Click to view details](#)



NOT SO square office

"L" Workstation Returns
Multi-File

[Click here to view statement of line](#)

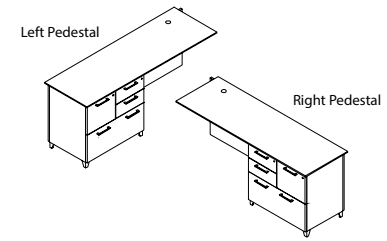

1 Select Model

w" x d" x h"	Weight
Left Pedestal	
72 x 22 x 29	200
66 x 22 x 29	190
60 x 22 x 29	180
54 x 22 x 29	170
48 x 22 x 29	165
Right Pedestal	
72 x 22 x 29	200
66 x 22 x 29	190
60 x 22 x 29	180
54 x 22 x 29	170
48 x 22 x 29	165

Standard Veneer Top Standard Veneer Chassis		Premium Veneer Top Premium Veneer Chassis		High Pressure Laminate Top Veneer Chassis		Thermally Fused Laminate Top Thermally Fused Laminate Chassis	
NSS7222RE218W	3855	NSS7222RE218P	4241	NSS7222RE218G	3855	NSS7222RE218M	2380
NSS6622RE218W	3822	NSS6622RE218P	4205	NSS6622RE218G	3822	NSS6622RE218M	2291
NSS6022RE218W	3768	NSS6022RE218P	4145	NSS6022RE218G	3768	NSS6022RE218M	2199
NSS5422RE218W	3733	NSS5422RE218P	4107	NSS5422RE218G	3733	NSS5422RE218M	2119
NSS4822RE218W	3642	NSS4822RE218P	4007	NSS4822RE218G	3642	NSS4822RE218M	2055
NSS7222RE219W	3855	NSS7222RE219P	4241	NSS7222RE219G	3855	NSS7222RE219M	2380
NSS6622RE219W	3822	NSS6622RE219P	4205	NSS6622RE219G	3822	NSS6622RE219M	2291
NSS6022RE219W	3768	NSS6022RE219P	4145	NSS6022RE219G	3768	NSS6022RE219M	2199
NSS5422RE219W	3733	NSS5422RE219P	4107	NSS5422RE219G	3733	NSS5422RE219M	2119
NSS4822RE219W	3642	NSS4822RE219P	4007	NSS4822RE219G	3642	NSS4822RE219M	2055

2 Select Finish

[Click to view finishes](#)

Metal Finish

MFS Silver. Additional

Metal Finishes are available, options

WAC	WNW
WIC	WWP
WHC	WNF(Natural
WOC	Oak on Flat
WEC	Cut)
WAM	WSF(Salted
WCM	Oak on Flat
WEW	Cut)
WGW	WMF(Mocha
WBW	Oak on Flat
WSW	Cut)

TBCO
TBSW
TSTV
TSMV
TSLV
TOBW
WMO
WNO
WSO

GAC GSVL
GIC +10%
GHC GWL
GOC
GEC
GAM
GCM
GEW
GNW
GSTV +10%

MAC
MOC
MEC
MGW
MTW
MSW
MWL

3 Select Edge

[Click to view edges](#)



4 Select Hardware

[Click to view details](#)



Product Features

- Full modesty panel
- Standard Silver Feet (optional White, Black)
- Pedestal is 31" W
- "W" & "G" Box and File Drawers feature soft close suspensions (Lateral Drawers Feature ball bearing suspensions), "M" SKUs feature ball bearing suspensions. Both suspensions are full extension

Notes

- Keyboard not available on noted 48" /54" units. Returns with Grommets in top will automatically have wire channel and outfeed holes in back.
- Laminate version "M" standard w/ open plan back
- Unit not designed for open plan use. Select OPB for Open Plan application

Options

Accessories

- K28: Articulating Keyboard w/ Mouse - \$390

Drawer

- P33: Wood Drawer Upgrade - \$45 per drawer
- P40W: extra Box/Box/File or File/File to Knee space - \$910
- P40M: extra Box/Box/File or File/File to Knee space - \$720
- WPD3061: Designer White - \$80 per pedestal

Feet

- D8: Delete feet (extend fronts to floor) - n/c

Flush Cut

- FC-L: Flush Unit Left (Facing) for Ganging - \$55
- FC-R: Flush Unit Right(Facing) for Ganging - \$55

Grommets (Non-Standard Location)

Provide drawing w/ Grommet Location and Specify Color - \$95 ea.

- Black: TM30-NS
- Silver: TM31-NS
- White: TM34-NS

Modesty

- M34T: Drop Door Tech Modesty - \$130
- M34TM: "M" Style Drop Door Tech Modesty - \$130
- M51: Open Back Modesty with Wire Mgmt Rail - Deduct \$95

Open Plan _ Finished Back

- OPB: "W" "G" Style - Modify Unit for Open Plan Application - \$295

Premium Finish Option

- Specify foot Metal Finish color - \$160 per unit. Contact customer service
- MFB: Black, MFW: White, MFDB: Dark Bronze, MFGM: Matte Gold

NOT SO square office

Workstation Bridges
Open Back Bridge

[Click here to view statement of line](#)

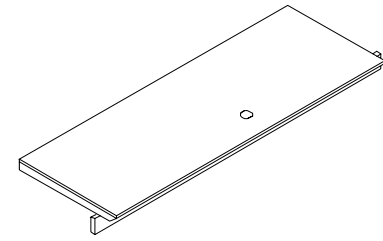

1 Select Model

w" x d" x h"	Weight
48 x 22 x 29	55
42 x 22 x 29	391
36 x 22 x 29	363

Standard Veneer Top Standard Veneer Chassis		Premium Veneer Top Premium Veneer Chassis		High Pressure Laminate Top Veneer Chassis		Thermally Fused Laminate Top Thermally Fused Laminate Chassis	
--	--	--	--	--	--	--	--

NSS4822BR151W	746	NSS4822BR151P	821	NSS4822BR151G	746	NSS4822BR151M	625
NSS4222BR151W	705	NSS4222BR151P	775	NSS4222BR151G	705	NSS4222BR151M	593
NSS3622BR151W	670	NSS3622BR151P	737	NSS3622BR151G	670	NSS3622BR151M	551

Product Features

- Metal grommet matches pull finish
- Standard open back 4" wire management rail

Options

Accessories

- K28: Articulating Keyboard w/ Mouse - \$390
- K31: Center Drawer - \$205

Grommets (Non-Standard Location)

- Provide drawing w/ Grommet Location and Specify Color - \$95 ea.
- Black: TM30-NS
- Silver: TM31-NS
- White: TM34-NS

Modesty

- M34T: Drop Door Tech Modesty - \$130
- M34TM: "M" Style Drop Door Tech Modesty - \$130
- M37: "W" "G" Style Fixed Full Modesty - \$130
- M37M: "M" Style Fixed Full Modesty - \$80

2 Select Finish

[Click to view finishes](#)

WAC	WNW
WIC	WWP
WHC	WNF(Natural
WOC	Oak on Flat
WEC	Cut)
WAM	WSF(Salted
WCM	Oak on Flat
WEW	Cut)
WGW	WMF(Mocha
WBW	Oak on Flat
WSW	Cut)

TBCO
TBSW
TSTV
TSMV
TSLV
TOBW
WMO
WNO
WSO

GAC GSVL
GIC +10%
GHC GWL
GOC
GEC
GAM
GCM
GEW
GNW
GSTV +10%

MAC
MOC
MEC
MGW
MTW
MSW
MWL

3 Select Edge

[Click to view edges](#)



4 Select Hardware

[Click to view details](#)

Hardware
N/A

Hardware
N/A

Hardware
N/A

Hardware
N/A

NOT SO square office

Freestanding Lateral File Credenzas
Lateral File/Storage

[Click here to view statement of line](#)

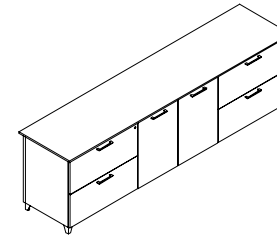

1 Select Model

w" x d" x h"	Weight
95 x 22 x 29	350
89 x 22 x 29	330

Standard Veneer Top Standard Veneer Chassis		Premium Veneer Top Premium Veneer Chassis		High Pressure Laminate Top Veneer Chassis		Thermally Fused Laminate Top Thermally Fused Laminate Chassis	
NSS9522CA651W	5469	NSS9522CA651P	6016	NSS9522CA651G	5469	NSS9522CA651M	4198
NSS8922CA651W	5383	NSS8922CA651P	5921	NSS8922CA651G	5383	NSS8922CA651M	4069

Product Features

- Full height storage has black laminate adjustable shelf
- Full extension drawers - locking
- Features ball bearing suspensions, suspensions are full extension
- Standard Silver Feet (optional White, Black)

Notes

- Unit has black back panel and is not designed for Open Plan use. Select OPB Option for Open Plan application

Options

Door

- D2: Door Lock per door set - \$100
- D6A: "W"/"G" Styles - Delete Doors and replace black laminate shelf with finished shelf - n/c
- D9SC: Soft Close Door Hinges - \$20 per door

Drawer

- P33: Wood Drawer Upgrade - \$45 per drawer
- WPD3061: Designer White - \$80 per pedestal

Feet

- D8: Delete feet (extend fronts to floor) - n/c

Flush Cut

- FC-B: Flush Unit Both Sides(Facing) for Ganging - \$55
- FC-L: Flush Unit Left (Facing) for Ganging - \$55
- FC-R: Flush Unit Right(Facing) for Ganging - \$55

Grommets (Standard Location)

- Specify Color and Location (Right/Left/Center) - \$50 ea.
- Black: TM30-R (Right), TM30-L (Left), TM30-C (Center)
 - Silver: TM31-R (Right), TM31-L (Left), TM31-C (Center)
 - White: TM34-R (Right), TM34-L (Left), TM34-C (Center)

Grommets (Non-Standard Location)

- Provide drawing w/ Grommet Location and Specify Color - \$95 ea.
- Black: TM30-NS
 - Silver: TM31-NS
 - White: TM34-NS

Open Plan _ Finished Back

- OPB: "W" "G" Style - Modify Unit for Open Plan Application - \$295

Shelf

- S714F: Heavy Duty Lumber 1" Shelves - \$80 per shelf ("M" Styles - n/a)

Premium Finish Option

- Specify foot Metal Finish color - \$160 per unit. Contact customer service
- MFB: Black, MFW: White, MFDB: Dark Bronze, MFGM: Matte Gold

2 Select Finish

[Click to view finishes](#)

Metal Finish

MFS Silver. Additional

Metal Finishes are available, options

WAC	WNW
WIC	WWP
WHC	WNF(Natural
WOC	Oak on Flat
WEC	Cut)
WAM	WSF(Salted
WCM	Oak on Flat
WEW	Cut)
WGW	WMF(Mocha
WBW	Oak on Flat
WSW	Cut)

TBCO
TBSW
TSTV
TSMV
TSLV
TOBW
WMO
WNO
WSO

GAC
GIC
GHC
GOC
GEC
GAM
GCM
GEW
GNW
GSTV +10%

MAC
MOC
MEC
MGW
MTW
MSW
MWL

3 Select Edge

[Click to view edges](#)



NSS Bevel



NSS Bevel



NSS Bevel



NSS Bevel

4 Select Hardware

[Click to view details](#)



PL-115 Matte Black
PL-116 Matte Nickel



PL-210 Anodized
Aluminum



PL-115 Matte Black
PL-116 Matte Nickel



PL-210 Anodized
Aluminum



PL-115 Matte Black
PL-116 Matte Nickel



PL-210 Anodized
Aluminum



PL-115 Matte Black
PL-116 Matte Nickel



PL-210 Anodized
Aluminum

NOT SO square office

File Credenzas
File/File/Kneespace

[Click here to view statement of line](#)

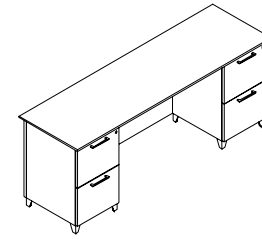

1 Select Model

w" x d" x h"	Weight
84 x 22 x 29	240
72 x 22 x 29	220
66 x 24 x 29	210
60 x 24 x 29	200

Standard Veneer Top Standard Veneer Chassis		Premium Veneer Top Premium Veneer Chassis		High Pressure Laminate Top Veneer Chassis		Thermally Fused Laminate Top Thermally Fused Laminate Chassis	
NSS8422CA054W	4358	NSS8422CA054P	4794	NSS8422CA054G	4358	NSS8422CA054M	2872
NSS7222CA054W	4035	NSS7222CA054P	4439	NSS7222CA054G	4035	NSS7222CA054M	2684
NSS6622CA054W	3992	NSS6622CA054P	4392	NSS6622CA054G	3992	NSS6622CA054M	2633
NSS6022CA054W	3953	NSS6022CA054P	4349	NSS6022CA054G	3953	NSS6022CA054M	2594

Product Features

- Full modesty back
- Full extension drawers - locking
- Soft close suspension drawer(s)
- Standard Silver Feet (optional White, Black)

Notes

- If a grommet is located in top surface over open knee space, an outfeed hole will be provided in modesty panel
- Unit has black back panel and is not designed for Open Plan use. Select OPB Option for Open Plan application

Options

Accessories

- K28: Articulating Keyboard w/ Mouse - \$390

Drawer

- P6: Modify File/File to Box/Box/File - \$55 per pedestal
- P33: Wood Drawer Upgrade - \$45 per drawer
- WPD3061: Designer White - \$80 per pedestal

Feet

- D8: Delete feet (extend fronts to floor) - n/c

Flush Cut

- FC-B: Flush Unit Both Sides(Facing) for Ganging - \$55
- FC-L: Flush Unit Left (Facing) for Ganging - \$55
- FC-R: Flush Unit Right(Facing) for Ganging - \$55

Grommets (Standard Location)

- Specify Color - \$50 ea.
- Black: TM30-C (Center)
 - Silver: TM31-C (Center)
 - White: TM34-C (Center)

Grommets (Non-Standard Location)

- Provide drawing w/ Grommet Location and Specify Color - \$95 ea.
- Black: TM30-NS
 - Silver: TM31-NS
 - White: TM34-NS

Modesty

- M34T: Drop Door Tech Modesty - \$130
- M34TM: "M" Style Drop Door Tech Modesty - \$130
- M51: Open Back Modesty with Wire Mgmt Rail - Deduct \$95

Open Plan _ Finished Back

- OPB: "W" "G" Style - Modify Unit for Open Plan Application - \$295

Premium Finish Option

- Specify foot Metal Finish color - \$160 per unit. Contact customer service
- MFB: Black, MFW: White, MFDB: Dark Bronze, MFGM: Matte Gold

2 Select Finish

[Click to view finishes](#)

Metal Finish

MFS Silver. Additional Metal Finishes are available, options

WAC	WNW	TBCO
WIC	WWP	TBSW
WHC	WNF(Natural	TSTV
WOC	Oak on Flat	TSMV
WEC	Cut)	TSLV
WAM	WSF(Salted	TOBW
WCM	Oak on Flat	WMO
WEW	Cut)	WNO
WGW	WMF(Mocha	WSO
WBW	Oak on Flat	
WSW	Cut)	

TBCO
TBSW
TSTV
TSMV
TSLV
TOBW
WMO
WNO
WSO

GAC
GIC
GHC
GOC
GEC
GAM
GCM
GEW
GNW
GSTV

MAC
MOC
MEC
MGW
MTW
MSW
MWL

3 Select Edge

[Click to view edges](#)



NSS Bevel



NSS Bevel



NSS Bevel



NSS Bevel

4 Select Hardware

[Click to view details](#)



PL-115 Matte Black
PL-116 Matte Nickel



PL-210 Anodized
Aluminum



PL-115 Matte Black
PL-116 Matte Nickel



PL-210 Anodized
Aluminum



PL-115 Matte Black
PL-116 Matte Nickel



PL-210 Anodized
Aluminum



PL-115 Matte Black
PL-116 Matte Nickel



PL-210 Anodized
Aluminum

NOT SO square office

Freestanding Storage Credenzas
Storage

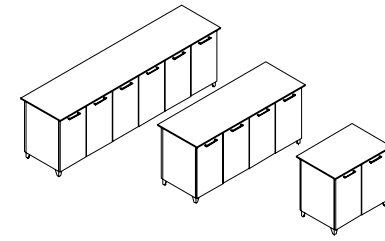

[Click here to view statement of line](#)

1 Select Model

w" x d" x h"	Weight
3 Section	
95 x 22 x 29	325
89 x 22 x 29	300
2 Section	
72 x 22 x 29	275
60 x 22 x 29	250
1 Section	
37 x 22 x 29	145
31 x 22 x 29	135

	Standard Veneer Top Standard Veneer Chassis		Premium Veneer Top Premium Veneer Chassis		High Pressure Laminate Top Veneer Chassis		Thermally Fused Laminate Top Thermally Fused Laminate Chassis	
WAC			TBCO		GAC	GSLV	MAC	
WIC			TBSW		GIC	+10%	MOC	
WHC	WNW		TSTV		GHC	GWL	MEC	
WOC	WNF(Natural		TSMV		GOC		MGW	
WEC	Oak on Flat		TSLV		GEC		MTW	
WAM	Cut)		TOBW		GAM		MSW	
WCM	WSF(Salted		WMO		GCM		MWL	
WEW	Oak on Flat		WNO		GEW			
WGW	Cut)		WSO		GNW			
WBW	WMF(Mocha				GSTV	+10%		
WSW	Oak on Flat							
	Cut)							

2 Select Finish

[Click to view finishes](#)

Metal Finish

MFS Silver. Additional
Metal Finishes are
available, options

WAC	WNW
WIC	WWP
WHC	WNF(Natural
WOC	Oak on Flat
WEC	Cut)
WAM	WSF(Salted
WCM	Oak on Flat
WEW	Cut)
WGW	WMF(Mocha
WBW	Oak on Flat
WSW	Cut)

3 Select Edge

[Click to view edges](#)



NSS Bevel



NSS Bevel



NSS Bevel



NSS Bevel

4 Select Hardware

[Click to view details](#)



PL-115 Matte Black
PL-116 Matte Nickel



PL-210 Anodized
Aluminum



PL-115 Matte Black
PL-116 Matte Nickel



PL-210 Anodized
Aluminum



PL-115 Matte Black
PL-116 Matte Nickel



PL-210 Anodized
Aluminum



PL-115 Matte Black
PL-116 Matte Nickel



PL-210 Anodized
Aluminum

Product Features

- Full height storage has 1 adjustable black laminate shelf per section
- Standard Silver Feet (optional White, Black)

Notes

- Unit has black back panel and is not designed for Open Plan use. Select OPB Option for Open Plan application

Options

Door

- D2: Door lock (only available in panel door) - \$100 per door set
- D6A: "W"/"G" Styles - Delete Doors and replace black laminate shelf with finished shelf - n/c
- D9SC: Soft Close Door Hinges - \$20 per door
- WPD3061: Designer White - \$80 per door

Feet

- D8: Delete feet (extend fronts to floor) - n/c

Flush Cut

- FC-B: Flush Unit Both Sides(Facing) for Ganging - \$55
- FC-L: Flush Unit Left (Facing) for Ganging - \$55
- FC-R: Flush Unit Right(Facing) for Ganging - \$55

Grommets (Standard Location)

- Specify Color and Location (Right/Left/Center) - \$50 ea.
- Black: TM30-R (Right), TM30-L (Left), TM30-C (Center)
 - Silver: TM31-R (Right), TM31-L (Left), TM31-C (Center)
 - White: TM34-R (Right), TM34-L (Left), TM34-C (Center)

Grommets (Non-Standard Location)

- Provide drawing w/ Grommet Location and Specify Color - \$95 ea.
- Black: TM30-NS
 - Silver: TM31-NS
 - White: TM34-NS

Grommets (Vertical Surface)

- Standard Location - \$50 ea.
- Black Plastic Vertical Surface: TM50-C (Bottom Center)
- Non-Standard Location - \$95 ea.
- Black Plastic Vertical Surface: TM50-NS

Open Plan _ Finished Back

- OPB: "W" "G" Style - Modify Unit for Open Plan Application - \$295

Premium Finish Option

- Specify foot Metal Finish color - \$160 per unit. Contact customer service
- MFB: Black, MFW: White

NOT SO square office

Freestanding Lateral File Credenzas
Horizontal Lateral File

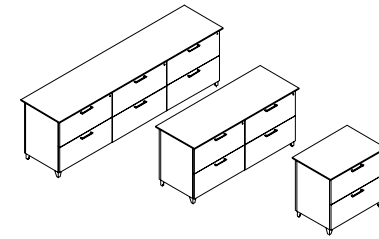

[Click here to view statement of line](#)

1 Select Model

w" x d" x h"	Weight
6 Drawer	
95 x 22 x 29	370
89 x 22 x 29	350
4 Drawer	
72 x 22 x 29	315
60 x 22 x 29	275
2 Drawer	
43 x 22 x 29	175
37 x 22 x 29	160
31 x 22 x 29	150

Standard Veneer Top Standard Veneer Chassis		Premium Veneer Top Premium Veneer Chassis		High Pressure Laminate Top Veneer Chassis		Thermally Fused Laminate Top Thermally Fused Laminate Chassis	
NSS9522CA104W	5564	NSS9522CA104P	6121	NSS9522CA104G	5564	NSS9522CA104M	4193
NSS8922CA104W	5486	NSS8922CA104P	6036	NSS8922CA104G	5486	NSS8922CA104M	4152
NSS7222CA104W	4420	NSS7222CA104P	4864	NSS7222CA104G	4420	NSS7222CA104M	3179
NSS6022CA104W	4297	NSS6022CA104P	4728	NSS6022CA104G	4297	NSS6022CA104M	3092
NSS4322CA104W	2577	NSS4322CA104P	2834	NSS4322CA104G	2577	NSS4322CA104M	2012
NSS3722CA104W	2349	NSS3722CA104P	2585	NSS3722CA104G	2349	NSS3722CA104M	1860
NSS3122CA104W	2261	NSS3122CA104P	2487	NSS3122CA104G	2261	NSS3122CA104M	1809

Product Features

- Anti-tip safety feature (31"-72")
- Full extension drawers - locking
- Features ball bearing suspensions, suspensions are full extension
- Standard Silver Feet (optional White, Black)

Notes

- Unit has black back panel and is not designed for Open Plan use. Select OPB Option for Open Plan application

Options

Drawer

- P33: Wood Drawer Upgrade - \$45 per drawer
- WPD3061: Designer White - \$80 per pedestal

Feet

- D8: Delete feet (extend fronts to floor) - n/c

Flush Cut

- FC-B: Flush Unit Both Sides(Facing) for Ganging - \$55
- FC-L: Flush Unit Left (Facing) for Ganging - \$55
- FC-R: Flush Unit Right(Facing) for Ganging - \$55

Open Plan _ Finished Back

- OPB: "W" "G" Style - Modify Unit for Open Plan Application - \$295

Premium Finish Option

- Specify foot Metal Finish color - \$160 per unit. Contact customer service
- MFB: Black, MFW: White

2 Select Finish

[Click to view finishes](#)

Metal Finish

MFS Silver. Additional

Metal Finishes are available, options

WAC	WNW
WIC	WWP
WHC	WNF(Natural
WOC	Oak on Flat
WEC	Cut)
WAM	WSF(Salted
WCM	Oak on Flat
WEW	Cut)
WGW	WMF(Mocha
WBW	Oak on Flat
WSW	Cut)

TBCO
TBSW
TSTV
TSMV
TSLV
TOBW
WMO
WNO
WSO

GAC GSVL
GIC +10%
GHC GWL
GOC
GEC
GAM
GCM
GEW
GNW
GSTV +10%

MAC
MOC
MEC
MGW
MTW
MSW
MWL

3 Select Edge

[Click to view edges](#)



4 Select Hardware

[Click to view details](#)

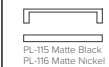
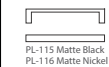

NOT SO square office

Freestanding Lateral File Credenzas
Vertical Lateral File

[Click here to view statement of line](#)

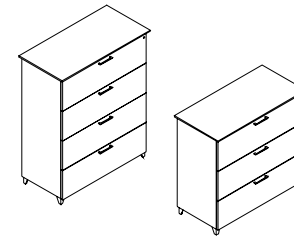

1 Select Model

w" x d" x h"
4 Drawer
43 x 22 x 54
37 x 22 x 54
31 x 22 x 54
3 Drawer
43 x 22 x 42
37 x 22 x 42
31 x 22 x 42

Weight	Standard Veneer Top Standard Veneer Chassis	Premium Veneer Top Premium Veneer Chassis	High Pressure Laminate Top Veneer Chassis	Thermally Fused Laminate Top Thermally Fused Laminate Chassis
290	NSS4322FI111W 4722	NSS4322FI111P 5195	NSS4322FI111G 4722	NSS4322FI111M 3026
270	NSS3722FI111W 4462	NSS3722FI111P 4909	NSS3722FI111G 4462	NSS3722FI111M 2769
245	NSS3122FI111W 4297	NSS3122FI111P 4728	NSS3122FI111G 4297	NSS3122FI111M 2685
255	NSS4322FI112W 4392	NSS4322FI112P 4831	NSS4322FI112G 4392	NSS4322FI112M 2752
235	NSS3722FI112W 4145	NSS3722FI112P 4560	NSS3722FI112G 4145	NSS3722FI112M 2494
215	NSS3122FI112W 3992	NSS3122FI112P 4392	NSS3122FI112G 3992	NSS3122FI112M 2418

Product Features

- Anti-tip safety feature
- Full extension drawers - locking
- Features ball bearing suspensions, suspensions are full extension
- Standard Silver Feet (optional White, Black)

Notes

- Unit has black back panel and is not designed for Open Plan use. Select OPB Option for Open Plan application

Options

Drawer

- P33: Wood Drawer Upgrade - \$45 per drawer
- WPD3061: Designer White - \$80 per pedestal

Feet

- D8: Delete feet (extend fronts to floor) - n/c

Flush Cut

- FC-B: Flush Unit Both Sides(Facing) for Ganging - \$55
- FC-L: Flush Unit Left (Facing) for Ganging - \$55
- FC-R: Flush Unit Right(Facing) for Ganging - \$55

Open Plan _ Finished Back

- OPB: "W" "G" Style - Modify Unit for Open Plan Application - \$295

Premium Finish Option

- Specify foot Metal Finish color - \$160 per unit. Contact customer service
- MFB: Black, MFW: White

2 Select Finish

[Click to view finishes](#)

Metal Finish

MFS Silver. Additional

Metal Finishes are available, options

WAC	WNW
WIC	WWP
WHC	WNF(Natural
WOC	Oak on Flat
WEC	Cut)
WAM	WSF(Salted
WCM	Oak on Flat
WEW	Cut)
WGW	WMF(Mocha
WBW	Oak on Flat
WSW	Cut)

TBCO
TBSW
TSTV
TSMV
TSLV
TOBW
WMO
WNO
WSO

GAC GSLV
GIC +10%
GHC GWL
GOC
GEC
GAM
GCM
GEW
GNW
GSTV +10%

MAC
MOC
MEC
MGW
MTW
MSW
MWL

3 Select Edge

[Click to view edges](#)



NSS Bevel



NSS Bevel



NSS Bevel



NSS Bevel

4 Select Hardware

[Click to view details](#)



PL-115 Matte Black
PL-116 Matte Nickel



PL-210 Anodized
Aluminum



PL-115 Matte Black
PL-116 Matte Nickel



PL-210 Anodized
Aluminum



PL-115 Matte Black
PL-116 Matte Nickel



PL-210 Anodized
Aluminum



PL-115 Matte Black
PL-116 Matte Nickel



PL-210 Anodized
Aluminum

NOT SO square office

Workstation Credenzas
File/File

[Click here to view statement of line](#)

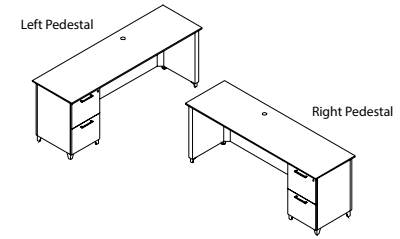

1 Select Model

w" x d" x h"	Weight
Left Pedestal	
89 x 22 x 29	220
84 x 22 x 29	210
72 x 22 x 29	200
66 x 22 x 29	190
Right Pedestal	
89 x 22 x 29	220
84 x 22 x 29	210
72 x 22 x 29	200
66 x 22 x 29	190

Standard Veneer Top Standard Veneer Chassis		Premium Veneer Top Premium Veneer Chassis		High Pressure Laminate Top Veneer Chassis		Thermally Fused Laminate Top Thermally Fused Laminate Chassis	
NSS8922CA086W	4214	NSS8922CA086P	4636	NSS8922CA086G	4214	NSS8922CA086M	2683
NSS8422CA086W	4145	NSS8422CA086P	4560	NSS8422CA086G	4145	NSS8422CA086M	2502
NSS7222CA086W	3827	NSS7222CA086P	4211	NSS7222CA086G	3827	NSS7222CA086M	2317
NSS6622CA086W	3787	NSS6622CA086P	4166	NSS6622CA086G	3787	NSS6622CA086M	2258
NSS8922CA087W	4214	NSS8922CA087P	4636	NSS8922CA087G	4214	NSS8922CA087M	2683
NSS8422CA087W	4145	NSS8422CA087P	4560	NSS8422CA087G	4145	NSS8422CA087M	2502
NSS7222CA087W	3827	NSS7222CA087P	4211	NSS7222CA087G	3827	NSS7222CA087M	2317
NSS6622CA087W	3787	NSS6622CA087P	4166	NSS6622CA087G	3787	NSS6622CA087M	2258

Product Features

- Full modesty back
- Full extension drawers - locking
- Outfeed hole standard in back of credenza
- Soft close suspension drawer(s)
- Standard metal grommet matches pull finish
- Standard Silver Feet (optional White, Black)

Notes

- Laminate version "M" standard w/ open plan back
- Unit has black back panel and is not designed for Open Plan use. Select OPB Option for Open Plan application

Options

Accessories

- K28: Articulating Keyboard w/ Mouse - \$390

Drawer

- P6: Modify File/File to Box/Box/File - \$55 per pedestal
- P33: Wood Drawer Upgrade - \$45 per drawer
- P40W: extra Box/Box/File or File/File to Knee space - \$910
- P40M: extra Box/Box/File or File/File to Knee space - \$720
- WPD3061: Designer White - \$80 per door

Feet

- D8: Delete feet (extend fronts to floor) - n/c

Flush Cut

- FC-B: Flush Unit Both Sides(Facing) for Ganging - \$55
- FC-L: Flush Unit Left (Facing) for Ganging - \$55
- FC-R: Flush Unit Right(Facing) for Ganging - \$55

Grommets (Non-Standard Location)

Provide drawing w/ Grommet Location and Specify Color - \$95 ea.

- Black: TM30-NS
- Silver: TM31-NS
- White: TM34-NS

Modesty

- M34T: Drop Door Tech Modesty - \$130
- M34TM: "M" Style Drop Door Tech Modesty - \$130
- M51: Open Back Modesty with Wire Mgmt Rail - Deduct \$95

Open Plan _ Finished Back

- OPB: "W" "G" Style - Modify Unit for Open Plan Application - \$195

Premium Finish Option

- Specify foot Metal Finish color - \$160 per unit. Contact customer service
- MFB: Black, MFW: White, MFDB: Dark Bronze, MFGM: Matte Gold

2 Select Finish

[Click to view finishes](#)

WAC	WNW
WIC	WWP
WHC	WNF(Natural
WOC	Oak on Flat
WEC	Cut)
WAM	WSF(Salted
WCM	Oak on Flat
WEW	Cut)
WGW	WMF(Mocha
WBW	Oak on Flat
WSW	Cut)

TBCO
TBSW
TSTV
TSMV
TSLV
TOBW
WMO
WNO
WSO

GAC GSVL
GIC +10%
GHC GWL
GOC
GEC
GAM
GCM
GEW
GNW
GSTV +10%

MAC
MOC
MEC
MGW
MTW
MSW
MWL

3 Select Edge

[Click to view edges](#)



4 Select Hardware

[Click to view details](#)



NOT SO square office

Workstation Credenzas
Lateral File

[Click here to view statement of line](#)

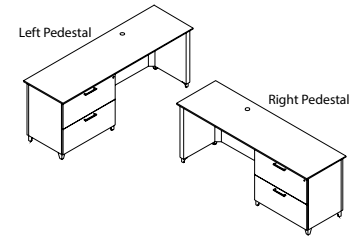

1 Select Model

w" x d" x h"	Weight
Left Pedestal	
95 x 22 x 29	265
89 x 22 x 29	250
84 x 22 x 29	240
72 x 22 x 29	230
66 x 22 x 29	215
Right Pedestal	
95 x 22 x 29	265
89 x 22 x 29	250
84 x 22 x 29	240
72 x 22 x 29	230
66 x 22 x 29	215

	Standard Veneer Top Standard Veneer Chassis		Premium Veneer Top Premium Veneer Chassis		High Pressure Laminate Top Veneer Chassis		Thermally Fused Laminate Top Thermally Fused Laminate Chassis	
2 Select Finish Click to view finishes	WAC	WNW	TBCO		GAC	GSLV	MAC	
	WIC	WWP	TBSW		GIC	+10%	MOC	
	WHC	WNF(Natural	TSTV		GHC	GWL	MEC	
	WOC	Oak on Flat	TSMV		GOC		MGW	
Metal Finish	WEC	Cut)	TSLV		GEC		MTW	
MFS Silver. Additional	WAM	WSF(Salted	TOBW		GAM		MSW	
Metal Finishes are	WCM	Oak on Flat	WMO		GCM		MWL	
available, options	WEW	Cut)	WNO		GEW			
	WGW	WMF(Mocha	WSO		GNW			
	WBW	Oak on Flat			GSTV	+10%		
	WSW	Cut)						
3 Select Edge Click to view edges								
	NSS Bevel		NSS Bevel		NSS Bevel		NSS Bevel	
4 Select Hardware Click to view details								
	PL-115 Matte Black PL-116 Matte Nickel	PL-210 Anodized Aluminum	PL-115 Matte Black PL-116 Matte Nickel	PL-210 Anodized Aluminum	PL-115 Matte Black PL-116 Matte Nickel	PL-210 Anodized Aluminum	PL-115 Matte Black PL-116 Matte Nickel	PL-210 Anodized Aluminum

Product Features

- All drawers lock
- Full modesty back
- Outfeed hole standard in back of credenza
- Features ball bearing suspensions, suspensions are full extension
- Standard metal grommet matches pull finish
- Standard Silver Feet (optional White, Black)

Notes

- 96, 90, 84 W units have 35W lateral
- 72 and 66 W units have 29W lateral
- Keyboard not available on 66"W Lateral File/Multi-File Units
- Unit has black back panel and is not designed for Open Plan use. Select OPB Option for Open Plan application

Options

Accessories

- K28: Articulating Keyboard w/ Mouse - \$390

Drawer

- P33: Wood Drawer Upgrade - \$45 per drawer
- P40W: extra Box/Box/File or File/File to Knee space - \$910 (n/a on 66")
- P40M: extra Box/Box/File or File/File to Knee space - \$720 (n/a on 66")
- WPD3061: Designer White - \$80 per door

Feet

- D8: Delete feet (extend fronts to floor) - n/c

Flush Cut

- FC-B: Flush Unit Both Sides(Facing) for Ganging - \$55
- FC-L: Flush Unit Left (Facing) for Ganging - \$55
- FC-R: Flush Unit Right(Facing) for Ganging - \$55

Grommets (Non-Standard Location)

Provide drawing w/ Grommet Location and Specify Color - \$95 ea.

- Black: TM30-NS
- Silver: TM31-NS
- White: TM34-NS

Modesty

- M34T: Drop Door Tech Modesty - \$130
- M34TM: "M" Style Drop Door Tech Modesty - \$130
- M51: Open Back Modesty with Wire Mgmt Rail - Deduct \$95

Open Plan _ Finished Back

- OPB: "W" "G" Style - Modify Unit for Open Plan Application - \$195

Premium Finish Option

- Specify foot Metal Finish color - \$160 per unit. Contact customer service
- MFB: Black, MFW: White, MFDB: Dark Bronze, MFGM: Matte Gold

NOT SO square office

Workstation Credenzas
Multi-File

[Click here to view statement of line](#)

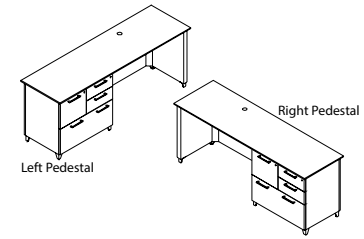

1 Select Model

Weight	w" x d" x h"
	Left Pedestal
265	95 x 22 x 29
250	89 x 22 x 29
240	84 x 22 x 29
230	72 x 22 x 29
215	*66 x 22 x 29
	Right Pedestal
265	95 x 22 x 29
250	89 x 22 x 29
240	84 x 22 x 29
230	72 x 22 x 29
215	*66 x 22 x 29

Standard Veneer Top Standard Veneer Chassis		Premium Veneer Top Premium Veneer Chassis		High Pressure Laminate Top Veneer Chassis		Thermally Fused Laminate Top Thermally Fused Laminate Chassis	
NSS9522CA667W	4528	NSS9522CA667P	4982	NSS9522CA667G	4528	NSS9522CA667M	2983
NSS8922CA667W	4483	NSS8922CA667P	4932	NSS8922CA667G	4483	NSS8922CA667M	2942
NSS8422CA667W	4346	NSS8422CA667P	4781	NSS8422CA667G	4346	NSS8422CA667M	2771
NSS7222CA667W	4069	NSS7222CA667P	4477	NSS7222CA667G	4069	NSS7222CA667M	2597
NSS6622CA667W	4029	NSS6622CA667P	4432	NSS6622CA667G	4029	NSS6622CA667M	2541
NSS9522CA668W	4528	NSS9522CA668P	4982	NSS9522CA668G	4528	NSS9522CA668M	2983
NSS8922CA668W	4483	NSS8922CA668P	4932	NSS8922CA668G	4483	NSS8922CA668M	2942
NSS8422CA668W	4346	NSS8422CA668P	4781	NSS8422CA668G	4346	NSS8422CA668M	2771
NSS7222CA668W	4069	NSS7222CA668P	4477	NSS7222CA668G	4069	NSS7222CA668M	2597
NSS6622CA668W	4029	NSS6622CA668P	4432	NSS6622CA668G	4029	NSS6622CA668M	2541

Product Features

- Full modesty back
- Outfeed hole standard in back of credenza
- "W" & "G" Box and File Drawers feature soft close suspensions (Lateral Drawers Feature ball bearing suspensions), "M" SKUs feature ball bearing suspensions. Both suspensions are full extension
- Standard metal grommet matches pull finish
- Standard Silver Feet (optional White, Black)

Notes

- Keyboard not available on 66"W Lateral File/Multi-File Units
- Unit not designed for open plan use. Select OPB for Open Plan application

Options

Accessories

- K28: Articulating Keyboard w/ Mouse - \$390

Drawer

- P33: Wood Drawer Upgrade - \$45 per drawer
- P40W: extra Box/Box/File or File/File to Knee space - \$910 (n/a on 66")
- P40M: extra Box/Box/File or File/File to Knee space - \$720 (n/a on 66")
- WPD3061: Designer White - \$80 per door

Feet

- D8: Delete feet (extend fronts to floor) - n/c

Flush Cut

- FC-B: Flush Unit Both Sides(Facing) for Ganging - \$55
- FC-L: Flush Unit Left (Facing) for Ganging - \$55
- FC-R: Flush Unit Right(Facing) for Ganging - \$55

Grommets (Non-Standard Location)

Provide drawing w/ Grommet Location and Specify Color - \$95 ea.

- Black: TM30-NS
- Silver: TM31-NS
- White: TM34-NS

Modesty

- M34T: Drop Door Tech Modesty - \$130
- M34TM: "M" Style Drop Door Tech Modesty - \$130
- M51: Open Back Modesty with Wire Mgmt Rail - Deduct \$95

Open Plan _ Finished Back

- OPB: "W" "G" Style - Modify Unit for Open Plan Application - \$195

Premium Finish Option

- Specify foot Metal Finish color - \$160 per unit. Contact customer service
- MFB: Black, MFW: White, MFDB: Dark Bronze, MFGM: Matte Gold

2 Select Finish

[Click to view finishes](#)

WAC	WNW
WIC	WWP
WHC	WNF(Natural
WOC	Oak on Flat
WEC	Cut)
WAM	WSF(Salted
WCM	Oak on Flat
WEW	Cut)
WGW	WMF(Mocha
WBW	Oak on Flat
WSW	Cut)

TBCO
TBSW
TSTV
TSMV
TSLV
TOBW
WMO
WNO
WSO

GAC GSLV
GIC +10%
GHC GWL
GOC
GEC
GAM
GCM
GEW
GNW
GSTV +10%

MAC
MOC
MEC
MGW
MTW
MSW
MWL

3 Select Edge

[Click to view edges](#)



4 Select Hardware

[Click to view details](#)



NOT SO square office

Bench Cabinets
One / Two / Three Section Storage

[Click here to view statement of line](#)

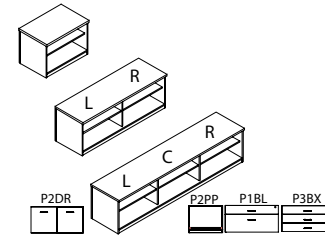

1 Select Model

w" x d" x h"
Three Section
93.5 x 20 x 23
87.5 x 20 x 23
Two Section
70.5 x 20 x 23
58.5 x 20 x 23
One Section
35.5 x 20 x 23
29.5 x 20 x 23

Weight	Standard Veneer Top Standard Veneer Chassis		Premium Veneer Top Premium Veneer Chassis		High Pressure Laminate Top Veneer Chassis		Thermally Fused Laminate Top Thermally Fused Laminate Chassis	
300	NSS9320CA063W	4332	NSS9320CA063P	4766	NSS9320CA063G	4332	NSS9320CA063M	2825
290	NSS8720CA063W	4008	NSS8720CA063P	4410	NSS8720CA063G	4008	NSS8720CA063M	2547
225	NSS7020CA063W	2865	NSS7020CA063P	3152	NSS7020CA063G	2865	NSS7020CA063M	2128
210	NSS5820CA063W	2700	NSS5820CA063P	2971	NSS5820CA063G	2700	NSS5820CA063M	1974
95	NSS3520CA063W	1508	NSS3520CA063P	1659	NSS3520CA063G	1508	NSS3520CA063M	870
90	NSS2920CA063W	1468	NSS2920CA063P	1615	NSS2920CA063G	1468	NSS2920CA063M	832

Product Features

- 1 1/8" top with flat edges
- Open plan - back
- Standard open storage with shelves

Notes

- To use Runoff Desk with Bench Cabinets, order Bench Runoff Support Ends: see Runoff Desk
- Bench Cushion Top factory installed as specified
- Standard without legs
- For drawers, storage and printer cabinets select options below

Options

Cabinet

- P1BL: Box/Lateral File - \$315 M / \$620 W
- P2DR: Storage Door - \$185 M / \$290 W
- P2PP: Open Printer Pullout - \$235 M / \$340 W
- P3BX: Three Box Drawers - \$315 M / \$515 W

Shelf

- S714F: Heavy Duty Lumber 1" Shelves - \$80 per shelf ("M" Styles - n/a)

Feet

- MTL50: 4 Silver Feet - \$205

Grommets (Standard Location)

- Specify Color and Location (Right/Left/Center) - \$50 ea.
- Black: TM30-R (Right), TM30-L (Left), TM30-C (Center)
 - Silver: TM31-R (Right), TM31-L (Left), TM31-C (Center)
 - White: TM34-R (Right), TM34-L (Left), TM34-C (Center)

Grommets (Non-Standard Location)

- Provide drawing w/ Grommet Location and Specify Color - \$95 ea.
- Black: TM30-NS, Silver: TM31-NS, White: TM34-NS

Grommets (Vertical Surface)

- Standard Location Black Plastic Vertical Surface: TM50-C (Bottom Center) - \$50 ea.
- Non-Standard Location Black Plastic Vertical Surface: TM50-NS - \$95 ea.

Cushion

- BC20: Bench Cushion
- Specify location, number of cushions and fabric grade.
- Cushions sold individually w/a max width 35" (to match storage section depth). 29" W requires .75 yd., 35" W requires 1 yd.

BC20 Bench Cushion fabric grades

COM	COL	1	2	3
282	301	319	337	355
4	5	6	7	8
373	391	409	427	445
9	10	11/ L1	12	13/ L2
463	481	499	517	553

2 Select Finish

[Click to view finishes](#)

WAC	WNW
WIC	WWP
WHC	WNF(Natural
WOC	Oak on Flat
WEC	Cut)
WAM	WSF(Salted
WCM	Oak on Flat
WEW	Cut)
WGW	WMF(Mocha
WBW	Oak on Flat
WSW	Cut)

TBCO
TBSW
TSTV
TSMV
TSLV
TOBW
WMO
WNO
WSO

GAC GSLV
GIC +10%
GHC GWL
GOC
GEC
GAM
GCM
GEW
GNW
GSTV +10%

MAC
MOC
MEC
MGW
MTW
MSW
MWL

3 Select Edge

[Click to view edges](#)

Edge
N/A

Edge
N/A

Edge
N/A

Edge
N/A

4 Select Hardware

[Click to view details](#)

Hardware
N/A

Hardware
N/A

Hardware
N/A

Hardware
N/A

NOT SO square office

Freestanding Mobile Pedestal
Mobile Pedestal - Under Surface

[Click here to view statement of line](#)

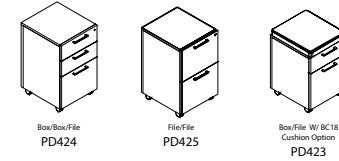

1 Select Model

w" x d" x h"
Box/Box/File
16 x 18 x 27
File/File
16 x 18 x 27
Box/File
16 x 18 x 23

Weight	Standard Veneer Top Standard Veneer Chassis	Premium Veneer Top Premium Veneer Chassis	High Pressure Laminate Top Veneer Chassis	Thermally Fused Laminate Top Thermally Fused Laminate Chassis
90	NSS1618PD424W 1451	NSS1618PD424P 1597	"G" Option N/A	NSS1618PD424M 1089
90	NSS1618PD425W 1451	NSS1618PD425P 1597	"G" Option N/A	NSS1618PD425M 1089
90	NSS1618PD423W 1307	NSS1618PD423P 1438	"G" Option N/A	NSS1618PD423M 980

Product Features

- Anti-tip safety feature
- For open plan use under surfaces
- Full extension drawers - locking

Notes

- Pedestal Cushion can be specified on all pedestals, but on Box/ Box/ File and File/File unit will not fit under work surface w/ cushion.

Options

Cushion

- BC16: Bench Cushion
- Specify fabric grade (1 yd. required)

Drawer

- P33: Wood Drawer Upgrade - \$45 per drawer
- WPD3061: Designer White - \$80 per pedestal

Premium Finish Option

- Specify foot Metal Finish color - \$30 per foot
- MFB: Black, MFW: White

BC16 Cushion fabric grades

COM	COL	1	2	3
224	243	261	279	297
4	5	6	7	8
315	333	351	369	387
9	10	11/ L1	12	13/ L2
405	423	441	459	495

2 Select Finish

Click to view finishes

WAC
WIC
WHC
WOC
WEC
WAM
WCM
WEW
WGW
WBW
WSW

WNW
WWP
WNF(Natural
Oak on Flat
Cut)
WSF(Salted
Oak on Flat
Cut)
WMF(Mocha
Oak on Flat
Cut)

TBCO
TBSW
TSTV
TSMV
TSLV
TOBW
WMO
WNO
WSO

MAC
MOC
MEC
MGW
MTW
MSW
MWL

3 Select Edge

Click to view edges

Edge
N/A

Edge
N/A

Edge
N/A

4 Select Hardware

Click to view details



NOT SO square office

Single Storage Overhead Consoles
Panel Door - 6/4/2 Door

[Click here to view statement of line](#)

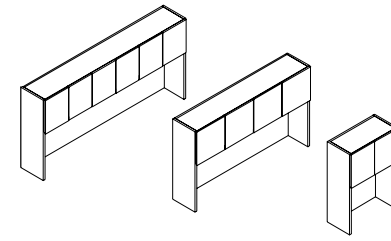

1 Select Model

w" x d" x h"

- 6 Door / 3 Section
- 93 x 14 x 42
- 87 x 14 x 42
- 4 Door / 2 Section
- 83 x 14 x 42
- 76 x 14 x 42
- 70 x 14 x 42
- 64 x 14 x 42
- 58 x 14 x 42
- 47 x 14 x 42
- 2 Door / 1 Section
- 35 x 14 x 42
- 29 x 14 x 42

Weight

		Standard Veneer Top Standard Veneer Chassis	Premium Veneer Top Premium Veneer Chassis	High Pressure Laminate Top Veneer Chassis	Thermally Fused Laminate Top Thermally Fused Laminate Chassis
315	NSS9342OH325W 4387	NSS9342OH325P 4826	"G" Option N/A	NSS9342OH325M 2926	
285	NSS8742OH325W 4229	NSS8742OH325P 4652	"G" Option N/A	NSS8742OH325M 2766	
275	NSS8342OH325W 3844	NSS8342OH325P 4229	"G" Option N/A	NSS8342OH325M 2252	
255	NSS7642OH325W 3580	NSS7642OH325P 3939	"G" Option N/A	NSS7642OH325M 2165	
240	NSS7042OH325W 3320	NSS7042OH325P 3652	"G" Option N/A	NSS7042OH325M 1850	
225	NSS6442OH325W 3238	NSS6442OH325P 3562	"G" Option N/A	NSS6442OH325M 1771	
210	NSS5842OH325W 3154	NSS5842OH325P 3470	"G" Option N/A	NSS5842OH325M 1701	
190	NSS4742OH325W 2990	NSS4742OH325P 3290	"G" Option N/A	NSS4742OH325M 1550	
120	NSS3542OH325W 1956	NSS3542OH325P 2152	"G" Option N/A	NSS3542OH325M 996	
105	NSS2942OH325W 1901	NSS2942OH325P 2092	"G" Option N/A	NSS2942OH325M 947	
2 Select Finish Click to view finishes		WAC	WNW	TBCO	MAC
		WIC	WWP	TBSW	MOC
		WHC	WNF(Natural	TSTV	MEC
		WOC	Oak on Flat	TSMV	MGW
		WEC	Cut)	TSLV	MTW
		WAM	WSF(Salted	TOBW	MSW
		WCM	Oak on Flat	WMO	MWL
		WEW	Cut)	WNO	
		WGW	WMF(Mocha	WSO	
		WBW	Oak on Flat		
		WSW	Cut)		
3 Select Edge Click to view edges		Edge N/A	Edge N/A	Edge N/A	Edge N/A
4 Select Hardware Click to view details		Hardware N/A	Hardware N/A	Hardware N/A	Hardware N/A

Product Features

- Finished top
- Interior cabinet depth 12.5"
- Panel doors with concealed finger pull
- 5/8" grommet(s) included for task light wire management

Notes

- Unit has black back panel and is not designed for Open Plan use. Select OPB Option for Open Plan application

Options

Door

- D2: Door Lock - \$100 per door set
- D6: Delete Doors - n/c
- D9SC: Soft Close Door Hinges - \$20 per door
- WPD3061: Designer White - \$80 per door

Grommets (Vertical Surface)

- Standard Location - \$50 ea.
- Black Plastic Vertical Surface: TM50-C (Bottom Center)
- Non-Standard Location - \$95 ea.
- Black Plastic Vertical Surface: TM50-NS

Interior Cabinet Lighting

- LEDPK starter kit includes Infeed, 1 Puck Interior Light and the ability to daisy chain up to 6 total Puck Lights
- LED Puck Starter Kit - \$310
- PK: 1 LED Interior Light - \$130

Task Lighting

- Overhead task light cord is located on the right facing side. If the opposite location is required please contact customer service.
- LT-LED24: 24" LED Task light - \$215
- LT-LED48: 48" LED Task light - \$270
- LT-LED60: 60" LED Task light - \$335
- LT-LED72: 72" LED Task light - \$360

Open Plan _ Finished Back

- OPB: "W" "G" Style - Modify Unit for Open Plan Application - \$295
- OPBM: "M" Style - Modify Unit for Open Plan Application - \$95

NOT SO square office

Single Storage Overhead Consoles
Silverluma Frame Doors / 6/4/2 Door

[Click here to view statement of line](#)

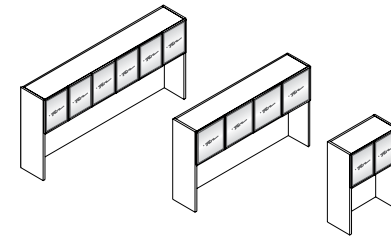

1 Select Model

w" x d" x h"

- 6 Door / 3 Section
- 93 x 14 x 42
- 87 x 14 x 42
- 4 Door / 2 Section
- 83 x 14 x 42
- 76 x 14 x 42
- 70 x 14 x 42
- 64 x 14 x 42
- 58 x 14 x 42
- 47 x 14 x 42
- 2 Door / 1 Section
- 35 x 14 x 42
- 29 x 14 x 42

Weight

		Standard Veneer Top Standard Veneer Chassis		Premium Veneer Top Premium Veneer Chassis		High Pressure Laminate Top Veneer Chassis	Thermally Fused Laminate Top Thermally Fused Laminate Chassis
		NSS9342OH321W	4923	NSS9342OH321P	5416	"G" Option N/A	NSS9342OH321M 3379
		NSS8742OH321W	4800	NSS8742OH321P	5280	"G" Option N/A	NSS8742OH321M 3219
		NSS8342OH321W	4738	NSS8342OH321P	5212	"G" Option N/A	NSS8342OH321M 2551
		NSS7642OH321W	4116	NSS7642OH321P	4528	"G" Option N/A	NSS7642OH321M 2465
		NSS7042OH321W	3827	NSS7042OH321P	4211	"G" Option N/A	NSS7042OH321M 2151
		NSS6442OH321W	3679	NSS6442OH321P	4048	"G" Option N/A	NSS6442OH321M 2073
		NSS5842OH321W	3580	NSS5842OH321P	3939	"G" Option N/A	NSS5842OH321M 2004
		NSS4742OH321W	3450	NSS4742OH321P	3796	"G" Option N/A	NSS4742OH321M 1853
		NSS3542OH321W	2220	NSS3542OH321P	2442	"G" Option N/A	NSS3542OH321M 1147
		NSS2942OH321W	2089	NSS2942OH321P	2298	"G" Option N/A	NSS2942OH321M 1096
				TBCO			MAC
				TBSW			MOC
				TSTV			MEC
				TSMV			MGW
				TSLV			MTW
				TOBW			MSW
				WMO			MWL
				WNO			
				WSO			
				Edge N/A			Edge N/A
				Hardware N/A			Hardware N/A

2 Select Finish

[Click to view finishes](#)

- | | |
|-----|-------------|
| WAC | WNW |
| WIC | WWP |
| WHC | WNF(Natural |
| WOC | Oak on Flat |
| WEC | Cut) |
| WAM | WSF(Salted |
| WCM | Oak on Flat |
| WEW | Cut) |
| WGW | WMF(Mocha |
| WBW | Oak on Flat |
| WSW | Cut) |

3 Select Edge

[Click to view edges](#)

Edge
N/A

4 Select Hardware

[Click to view details](#)

Hardware
N/A

Product Features

- Finished top
- Interior cabinet depth 12.5"
- SilverLuma frame doors with frosted acrylic inserts
- 5/8" grommet(s) included for task light wire management

Notes

- Unit has black back panel and is not designed for Open Plan use. Select OPB Option for Open Plan application

Options

Door

- D2: Door Lock - \$100 per door set
- D6: Delete Doors - n/c
- D9SC: Soft Close Door Hinges - \$20 per door

Grommets (Vertical Surface)

- Standard Location - \$50 ea.
- Black Plastic Vertical Surface: TM50-C (Bottom Center)
- Non-Standard Location - \$95 ea.
- Black Plastic Vertical Surface: TM50-NS

Interior Cabinet Lighting

- LEDPK starter kit includes Infeed, 1 Puck Interior Light and the ability to daisy chain up to 6 total Puck Lights
- LED Puck Starter Kit - \$310
- PK: 1 LED Interior Light - \$130

Task Lighting

- Overhead task light cord is located on the right facing side. If the opposite location is required please contact customer service.
- LT-LED24: 24" LED Task light - \$215
- LT-LED48: 48" LED Task light - \$270
- LT-LED60: 60" LED Task light - \$335
- LT-LED72: 72" LED Task light - \$360

Open Plan _ Finished Back

- OPB: "W" "G" Style - Modify Unit for Open Plan Application - \$295
- OPBM: "M" Style - Modify Unit for Open Plan Application - \$95

NOT SO square office

Single Storage Overhead Consoles
Open Storage Console

[Click here to view statement of line](#)

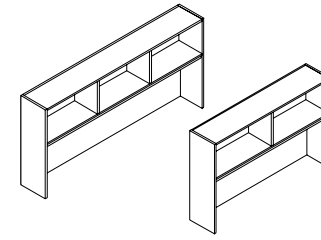

1 Select Model

w" x d" x h"

3 Section

93 x 14 x 42

Weight

310

87 x 14 x 42

280

83 x 14 x 42

265

76 x 14 x 42

250

2 Section

70 x 14 x 42

240

64 x 14 x 42

225

58 x 14 x 42

205

	Standard Veneer Top Standard Veneer Chassis		Premium Veneer Top Premium Veneer Chassis		High Pressure Laminate Top Veneer Chassis	Thermally Fused Laminate Top Thermally Fused Laminate Chassis
	NSS9342OH346W	4008	NSS9342OH346P	4410	"G" Option N/A	NSS9342OH346M 2543
	NSS8742OH346W	3967	NSS8742OH346P	4364	"G" Option N/A	NSS8742OH346M 2382
	NSS8342OH346W	3932	NSS8342OH346P	4326	"G" Option N/A	NSS8342OH346M 1860
	NSS7642OH346W	3388	NSS7642OH346P	3727	"G" Option N/A	NSS7642OH346M 1779
	NSS7042OH346W	3127	NSS7042OH346P	3439	"G" Option N/A	NSS7042OH346M 1597
	NSS6442OH346W	3051	NSS6442OH346P	3357	"G" Option N/A	NSS6442OH346M 1520
	NSS5842OH346W	3002	NSS5842OH346P	3303	"G" Option N/A	NSS5842OH346M 1444
			TBCO			MAC
			TBSW			MOC
			TSTV			MEC
			TSMV			MGW
			TSLV			MTW
			TOBW			MSW
			WMO			MWL
			WNO			
			WSO			
			Edge N/A			Edge N/A
			Hardware N/A			Hardware N/A

Product Features

- Finished top
- Interior cabinet depth 12.5"
- 5/8" grommet(s) included for task light wire management

Notes

- 1 or 2 optional door available
- Sliding Doors Will Not Pass Each Other
- Unit has black back panel and is not designed for Open Plan use. Select OPB Option for Open Plan application

Options

Grommets (Vertical Surface)

- Standard Location - \$50 ea.
- Black Plastic Vertical Surface: TM50-C (Bottom Center)
- Non-Standard Location - \$95 ea.
- Black Plastic Vertical Surface: TM50-NS

Interior Cabinet Lighting

- LEDPK starter kit includes Infeed, 1 Puck Interior Light and the ability to daisy chain up to 6 total Puck Lights
- LED Puck Starter Kit - \$310
- PK: 1 LED Interior Light - \$130

Open Plan _ Finished Back

- OPB: "W" "G" Style - Modify Unit for Open Plan Application - \$295
- OPBM: "M" Style - Modify Unit for Open Plan Application - \$95

Sliding Door

- SLD17LD: Laminate Door - \$205 per door
- SLD17FD: SilverLuma / Frost Door ("W", "M" only) - \$365 per door
- SLD17WD: Wood Door - \$260 per door

Task Lighting

- Overhead task light cord is located on the right facing side. If the opposite location is required please contact customer service.
- LT-LED24: 24" LED Task light - \$215
- LT-LED48: 48" LED Task light - \$270
- LT-LED60: 60" LED Task light - \$335
- LT-LED72: 72" LED Task light - \$360

2 Select Finish

[Click to view finishes](#)

WAC	WNW
WIC	WWP
WHC	WNF(Natural
WOC	Oak on Flat
WEC	Cut)
WAM	WSF(Salted
WCM	Oak on Flat
WEW	Cut)
WGW	WMF(Mocha
WBW	Oak on Flat
WSW	Cut)

3 Select Edge

[Click to view edges](#)

Edge
N/A

4 Select Hardware

[Click to view details](#)

Hardware
N/A

NOT SO square office

Double Height Overhead Consoles
Panel Door

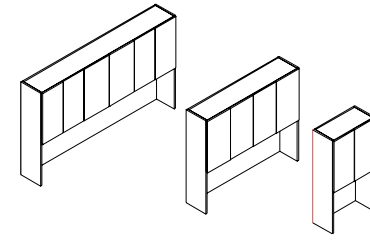

[Click here to view statement of line](#)

1 Select Model

w" x d" x h"

6 Door / 3 Section

93 x 14 x 54

300

NSS9354OH325W 4985

NSS9354OH325P 5484

"G" Option N/A

NSS9354OH325M 3564

87 x 14 x 54

290

NSS8754OH325W 4835

NSS8754OH325P 5319

"G" Option N/A

NSS8754OH325M 3426

83 x 14 x 54

280

NSS8354OH325W 4764

NSS8354OH325P 5240

"G" Option N/A

NSS8354OH325M 2759

4 Door / 2 Section

70 x 14 x 54

250

NSS7054OH325W 4056

NSS7054OH325P 4463

"G" Option N/A

NSS7054OH325M 2491

64 x 14 x 54

230

NSS6454OH325W 3827

NSS6454OH325P 4211

"G" Option N/A

NSS6454OH325M 2406

58 x 14 x 54

215

NSS5854OH325W 3718

NSS5854OH325P 4091

"G" Option N/A

NSS5854OH325M 2078

2 Door / 1 Section

35 x 14 x 54

160

NSS3554OH325W 2283

NSS3554OH325P 2512

"G" Option N/A

NSS3554OH325M 1359

29 x 14 x 54

150

NSS2954OH325W 2202

NSS2954OH325P 2422

"G" Option N/A

NSS2954OH325M 1315

2 Select Finish

[Click to view finishes](#)

WAC

WNW

TBCO

MAC

WIC

WWP

TBSW

MOC

WHC

WNF(Natural

TSTV

MEC

WOC

Oak on Flat

TSMV

MGW

WEC

Cut)

TSLV

MTW

WAM

WSF(Salted

TOBW

MSW

WCM

Oak on Flat

WMO

MWL

WEW

Cut)

WNO

WGW

WMF(Mocha

WSO

WBW

Oak on Flat

WSW

Cut)

3 Select Edge

[Click to view edges](#)

Edge
N/A

Edge
N/A

Edge
N/A

4 Select Hardware

[Click to view details](#)

Hardware
N/A

Hardware
N/A

Hardware
N/A

Product Features

- Finished top
- 1 Adjustable shelf behind each door section
- Interior cabinet depth 12.5"
- Interior shelf depth 12"
- Panel doors with concealed finger pull
- 5/8" grommet(s) included for task light wire management

Notes

- Unit has black back panel and is not designed for Open Plan use. Select OPB Option for Open Plan application.

Options

Door

- D2: Door Lock - \$100 per door set
- D6: Delete Doors - n/c
- D9SC: Soft Close Door Hinges - \$20 per door
- WPD3061: Designer White - \$80 per door

Grommets (Vertical Surface)

- Standard Location - \$50 ea.
- Black Plastic Vertical Surface: TM50-C (Bottom Center)
- Non-Standard Location - \$95 ea.
- Black Plastic Vertical Surface: TM50-NS

Interior Cabinet Lighting

- LEDPK starter kit includes Infeed, 1 Puck Interior Light and the ability to daisy chain up to 6 total Puck Lights
- LED Puck Starter Kit - \$310
- PK: 1 LED Interior Light - \$130

Task Lighting

- Overhead task light cord is located on the right facing side. If the opposite location is required please contact customer service.
- LT-LED24: 24" LED Task light - \$215
- LT-LED48: 48" LED Task light - \$270
- LT-LED60: 60" LED Task light - \$335
- LT-LED72: 72" LED Task light - \$360

Open Plan _ Finished Back

- OPB: "W" "G" Style - Modify Unit for Open Plan Application - \$295
- OPBM: "M" Style - Modify Unit for Open Plan Application - \$95

Shelf

- S714F: Heavy Duty Lumber 1" Shelves - \$80 per shelf ("M" Styles - n/a)

NOT SO square office

Double Height Overhead Consoles
Silverluma Frame 6/4/2 Doors

[Click here to view statement of line](#)

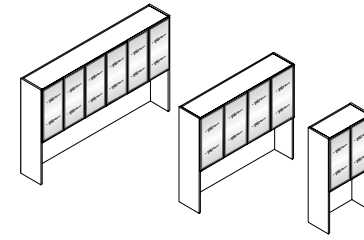

1 Select Model

w" x d" x h"
6 Door / 3 Section
93 x 14 x 54
87 x 14 x 54
4 Door / 2 Section
70 x 14 x 54
64 x 14 x 54
58 x 14 x 54
2 Door / 1 Section
35 x 14 x 54
29 x 14 x 54

Weight	Standard Veneer Top Standard Veneer Chassis		Premium Veneer Top Premium Veneer Chassis		High Pressure Laminate Top Veneer Chassis	Thermally Fused Laminate Top Thermally Fused Laminate Chassis
300	NSS9354OH321W	6114	NSS9354OH321P	6726	"G" Option N/A	NSS9354OH321M 4321
290	NSS8754OH321W	5865	NSS8754OH321P	6451	"G" Option N/A	NSS8754OH321M 4182
250	NSS7054OH321W	5094	NSS7054OH321P	5604	"G" Option N/A	NSS7054OH321M 2996
230	NSS6454OH321W	4511	NSS6454OH321P	4962	"G" Option N/A	NSS6454OH321M 2910
215	NSS5854OH321W	4303	NSS5854OH321P	4733	"G" Option N/A	NSS5854OH321M 2583
160	NSS3554OH321W	2728	NSS3554OH321P	3001	"G" Option N/A	NSS3554OH321M 1610
150	NSS2954OH321W	2548	NSS2954OH321P	2803	"G" Option N/A	NSS2954OH321M 1567

2 Select Finish

[Click to view finishes](#)

WAC WNW
WIC WWP
WHC WNF(Natural
WOC Oak on Flat
WEC Cut)
WAM WSF(Salted
WCM Oak on Flat
WEW Cut)
WGW WMF(Mocha
WBW Oak on Flat
WSW Cut)

TBCO
TBSW
TSTV
TSMV
TSLV
TOBW
WMO
WNO
WSO

MAC
MOC
MEC
MGW
MTW
MSW
MWL

3 Select Edge

[Click to view edges](#)

Edge
N/A

Edge
N/A

Edge
N/A

4 Select Hardware

[Click to view details](#)

Hardware
N/A

Hardware
N/A

Hardware
N/A

Product Features

- Finished top
- 1 Adjustable shelf per section standard
- Interior cabinet depth 12.5"
- Interior shelf depth 12"
- Silverluma doors w/ frosted acrylic inserts
- 5/8" grommet(s) included for task light wire management

Notes

- Unit has black back panel and is not designed for Open Plan use. Select OPB Option for Open Plan application.

Options

Door

- D2: Door Lock - \$100 per door set
- D6: Delete Doors - n/c
- D9SC: Soft Close Door Hinges - \$20 per door

Grommets (Vertical Surface)

- Standard Location - \$50 ea.
- Black Plastic Vertical Surface: TM50-C (Bottom Center)
- Non-Standard Location - \$95 ea.
- Black Plastic Vertical Surface: TM50-NS

Interior Cabinet Lighting

- LEDPK starter kit includes Infeed, 1 Puck Interior Light and the ability to daisy chain up to 6 total Puck Lights
- LED Puck Starter Kit - \$310
- PK: 1 LED Interior Light - \$130

Task Lighting

- Overhead task light cord is located on the right facing side. If the opposite location is required please contact customer service.
- LT-LED24: 24" LED Task light - \$215
- LT-LED48: 48" LED Task light - \$270
- LT-LED60: 60" LED Task light - \$335
- LT-LED72: 72" LED Task light - \$360

Open Plan _ Finished Back

- OPB: "W" "G" Style - Modify Unit for Open Plan Application - \$295
- OPBM: "M" Style - Modify Unit for Open Plan Application - \$95

Shelf

- GS14F: Replace Standard Shelves with Glass Shelves - \$90 per shelf
- S714F: Heavy Duty Lumber 1" Shelves - \$80 per shelf ("M" Styles - n/a)

Overhead tackboard
Full width tackboards

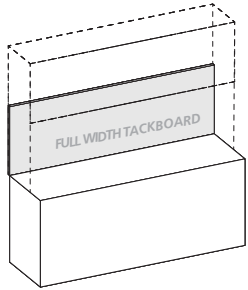

Product Width	Panel Dimension	SKU	COM	1	2	3	4	5	6	7	8	9	10	11/L1	12	13/L2
93	91 x .75 x 21	FTOC9121	379	480	531	582	633	684	735	786	837	888	939	990	1041	1143
87	85 x .75 x 21	FTOC8521	358	449	497	545	593	641	689	737	785	833	881	929	977	1073
83	81 x .75 x 21	FTOC8121	336	428	474	520	566	612	658	704	750	796	842	888	934	1026
76	74 x .75 x 21	FTOC7421	309	392	435	478	521	564	607	650	693	736	779	822	865	951
70	68 x .75 x 21	FTOC6821	282	361	401	441	481	521	561	601	641	681	721	761	801	881
64	62 x .75 x 21	FTOC6221	256	330	366	402	438	474	510	546	582	618	654	690	726	798
58	56 x .75 x 21	FTOC5621	234	299	331	363	395	427	459	491	523	555	587	619	651	715
47	45 x .75 x 21	FTOC4521	187	242	269	296	323	350	377	404	431	458	485	512	539	593
35	33 x .75 x 21	FTOC3321	141	180	200	220	240	260	280	300	320	340	360	380	400	440
29	27 x .75 x 21	FTOC2721	112	149	166	183	200	217	234	251	268	285	302	319	336	370

Standard Features

- Constructed of .5" thick fiberboard
- Fabric is precisely aligned and fitted to the tackboard
- Adhered to the rigid hardboard with staples
- Hung with Z-Strip mounting system

Notes

- Fabric Tack Panels are raised 3" from bottom edge when TM50 grommet is ordered

Overhead tackboard
Half width tackboards

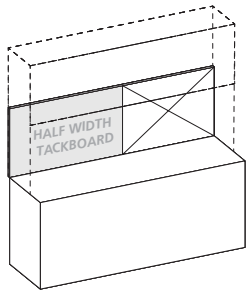

Product Width	Panel Dimension	SKU	COM	1	2	3	4	5	6	7	8	9	10	11/L1	12	13/L2
93 Half Width	45.5 x .75 x 21	FTOC4521	189	240	266	292	318	344	370	396	422	448	474	500	526	578
87 Half Width	42.5 x .75 x 21	FTOC4221	179	225	249	273	297	321	345	369	393	417	441	465	489	537
83 Half Width	40.5 x .75 x 21	FTOC4021	168	214	237	260	283	306	329	352	375	398	421	444	467	513
76 Half Width	37 x .75 x 21	FTOC3721	155	196	217	238	259	280	301	322	343	364	385	406	427	469
70 Half Width	34 x .75 x 21	FTOC3421	141	180	200	220	240	260	280	300	320	340	360	380	400	440
64 Half Width	31 x .75 x 21	FTOC3121	128	165	183	201	219	237	255	273	291	309	327	345	363	399

Standard Features

- Constructed of .5" thick fiberboard
- Fabric is precisely aligned and fitted to the tackboard
- Adhered to the rigid hardboard with staples
- Hung with Z-Strip mounting system

Notes

- Half width tackboards can be specified and combined with a Veneer Panel, Marker Board, Slat Wall or Glass Board. See "Half Width" items under product width.
- Specify right or left facing tackboard
- Fabric Tack Panels are raised 3" from bottom edge when TM50 grommet is ordered.

DARRAN®

Overhead dry marker board
Full width dry marker board

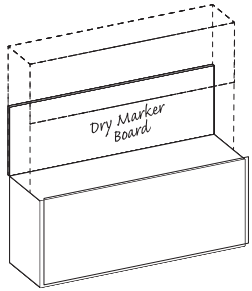

Product Width	Panel Dimension	SKU	List
93	91 x .5 x 21	DMOC9121	1136
87	85 x .5 x 21	DMOC8521	1061
83	81 x .5 x 21	DMOC8121	1011
76	74 x .5 x 21	DMOC7421	924
70	68 x .5 x 21	DMOC6821	849
64	62 x .5 x 21	DMOC6221	774
58	56 x .5 x 21	DMOC5621	699
47	45 x .5 x 21	DMOC4521	587
35	33 x .5 x 21	DMOC3321	437
29	27 x .5 x 21	DMOC2721	337

Standard Features

- Dry marker panel has edge trim molding
- Standard magnetic surface
- Hung with Z-Strip mounting system

Overhead dry marker board
Half width dry marker board

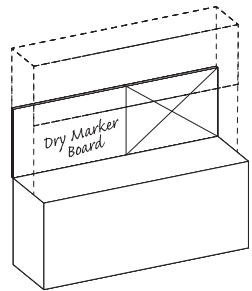

Product Width	Panel Dimension	SKU	List
93 Half Width	45.5 x .5 x 21	DMOC4521	555
87 Half Width	42.5 x .5 x 21	DMOC4221	518
83 Half Width	40.5 x .5 x 21	DMOC4021	493
76 Half Width	37 x .5 x 21	DMOC3721	449
70 Half Width	34 x .5 x 21	DMOC3421	437
64 Half Width	31 x .5 x 21	DMOC3121	374

Standard Features

- Dry marker panel has edge trim molding
- Standard magnetic surface
- Hung with Z-Strip mounting system

Notes

- Half width dry marker boards can be specified and combined with a Tackboard, Veneer Panel, Slat Wall or Glass Board. See "Half Width" items under product width.
- Specify right or left facing dry marker board

NSS Office Tackboards

DARRAN®

Overhead glassboard
Full width glassboard

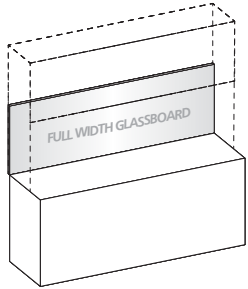

Product Width	Panel Dimension	SKU	List
93	91 x .5 x 21	GBOC9121	2382
87	85 x .5 x 21	GBOC8521	2236
83	81 x .5 x 21	GBOC8121	2138
76	74 x .5 x 21	GBOC7421	1969
70	68 x .5 x 21	GBOC6821	1822
64	62 x .5 x 21	GBOC6221	1676
58	56 x .5 x 21	GBOC5621	1531
47	45 x .5 x 21	GBOC4521	1264
35	33 x .5 x 21	GBOC3321	972
29	27 x .5 x 21	GBOC2721	826

Standard Features

- 4 mm tempered glass
- Use glass cleaner or alcohol to clean
- Standard dry erase markers may be used

Notes

- Earth magnets are required to hold items securely in place
- Hung with Z-Strip mounting system
- Use glass cleaner or alcohol to clean
- Standard dry erase markers may be used

Overhead glassboard
Half width glassboard

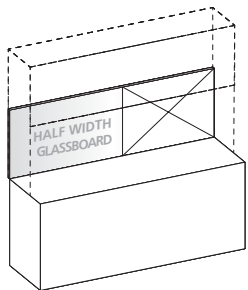

Product Width	Panel Dimension	SKU	List
93 Half Width	45.5 x .5 x 21	GBOC4521	1251
87 Half Width	42.5 x .5 x 21	GBOC4221	1178
83 Half Width	40.5 x .5 x 21	GBOC4021	1129
76 Half Width	37 x .5 x 21	GBOC3721	985
70 Half Width	34 x .5 x 21	GBOC3421	972
64 Half Width	31 x .5 x 21	GBOC3121	899

Standard Features

- 4 mm tempered glass
- Hung with Z-Strip mounting system

Notes

- Half width glassboards can be specified and combined with a Tackboard, Veneer panel, Marker Board or Slat Wall. See "Half Width" items under product width.
- Specify right or left facing glassboard
- Use glass cleaner or alcohol to clean
- Standard dry erase markers may be used
- Earth magnets are required to hold items securely in place

DARRAN®

Overhead slat wall
Half width slat wall

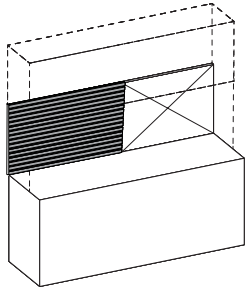

Product Width	Panel Dimension	SKU	List
93 Half Width	45.5 x .5 x 21	SWOC4521	463
87 Half Width	42.5 x .5 x 21	SWOC4221	432
83 Half Width	40.5 x .5 x 21	SWOC4021	411
76 Half Width	37 x .5 x 21	SWOC3721	374
70 Half Width	34 x .5 x 21	SWOC3421	343
64 Half Width	31 x .5 x 21	SWOC3121	300

Standard Features

- Available in silver or black
- Hung with Z-Strip mounting system

Notes

- Half width slat walls can be specified and combined with a Tackboard, Veneer panel, Marker Board or Glassboard. See "Half Width" items under product width.
- Specify right or left facing slat wall
- For use on 42"/43" height consoles
- Specify right or left facing slat wall

NSS Office Tackboards

NOT SO square office

Single Height Wall Hung Overheads
Panel Doors

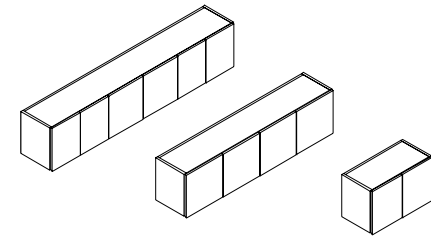

[Click here to view statement of line](#)

1 Select Model

w" x d" x h"	Weight
6 Door / 3 Section	
93 x 14 x 18	240
87 x 14 x 18	225
4 Door / 2 Section	
83 x 14 x 18	210
76 x 14 x 18	195
70 x 14 x 18	180
64 x 14 x 18	160
58 x 14 x 18	135
47 x 14 x 18	125
2 Door / 1 Section	
35 x 14 x 18	75
29 x 14 x 18	65

	Standard Veneer Top Standard Veneer Chassis		Premium Veneer Top Premium Veneer Chassis		High Pressure Laminate Top Veneer Chassis	Thermally Fused Laminate Top Thermally Fused Laminate Chassis
	NSS9318WH330W	4098	NSS9318WH330P	4508	"G" Option N/A	NSS9318WH330M 2886
	NSS8718WH330W	3939	NSS8718WH330P	4333	"G" Option N/A	NSS8718WH330M 2728
	NSS8318WH330W	3849	NSS8318WH330P	4234	"G" Option N/A	NSS8318WH330M 2148
	NSS7618WH330W	3781	NSS7618WH330P	4159	"G" Option N/A	NSS7618WH330M 1991
	NSS7018WH330W	3160	NSS7018WH330P	3477	"G" Option N/A	NSS7018WH330M 1842
	NSS6418WH330W	3112	NSS6418WH330P	3424	"G" Option N/A	NSS6418WH330M 1785
	NSS5818WH330W	3066	NSS5818WH330P	3373	"G" Option N/A	NSS5818WH330M 1729
	NSS4718WH330W	2343	NSS4718WH330P	2577	"G" Option N/A	NSS4718WH330M 1647
	NSS3518WH330W	1759	NSS3518WH330P	1935	"G" Option N/A	NSS3518WH330M 1172
	NSS2918WH330W	1729	NSS2918WH330P	1903	"G" Option N/A	NSS2918WH330M 1124

2 Select Finish

[Click to view finishes](#)

WAC	WNW
WIC	WWP
WHC	WNF(Natural
WOC	Oak on Flat
WEC	Cut)
WAM	WSF(Salted
WCM	Oak on Flat
WEW	Cut)
WGW	WMF(Mocha
WBW	Oak on Flat
WSW	Cut)

TBCO
TBSW
TSTV
TSMV
TSLV
TOBW
WMO
WNO
WSO

MAC
MOC
MEC
MGW
MTW
MSW
MWL

3 Select Edge

[Click to view edges](#)

Edge
N/A

Edge
N/A

Edge
N/A

4 Select Hardware

[Click to view details](#)

Hardware
N/A

Hardware
N/A

Hardware
N/A

Product Features

- Finished top
- Interior cabinet depth 12"
- Mounting wall rail included
- Panel doors with concealed finger pull

Notes

- The DARRAN wall mounted cabinet(or shelf) must be hung on a weight-bearing wall. The suitability of the wall supporting the wall mounted cabinet, and the installation and maintenance of the wall-mounted cabinet, is the sole responsibility of the customer. Failure to correctly install and/or exceed the loaded weight capacity of this product may cause it to fall, resulting in damage to the product, adjacent property and/or bodily injury.

Options

Door

- D2: Door Lock - \$100 per door set
- D6: Delete Doors - n/c
- D9SC: Soft Close Door Hinges - \$20 per door
- WPD3061: Designer White - \$80 per door

Interior Cabinet Lighting

LEDPK starter kit includes Infeed, 1 Puck Interior Light and the ability to daisy chain up to 6 total Puck Lights

- LED Puck Starter Kit - \$310
- PK: 1 LED Interior Light - \$130

Task Lighting

Overhead task light cord is located on the right facing side. If the opposite location is required please contact customer service.

- LT-LED24: 24" LED Task light - \$215
- LT-LED48: 48" LED Task light - \$270
- LT-LED60: 60" LED Task light - \$335
- LT-LED72: 72" LED Task light - \$360

NOT SO square office

Single Height Wall Hung Overheads
Silverluma Frame / Doors

[Click here to view statement of line](#)

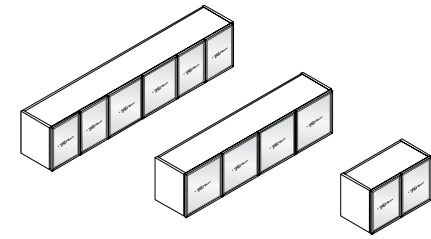

1 Select Model

w" x d" x h"

- 6 Door / 3 Section
- 93 x 15 x 18
- 87 x 15 x 18
- 4 Door / 2 Section
- 83 x 15 x 18
- 76 x 15 x 18
- 70 x 15 x 18
- 64 x 15 x 18
- 58 x 15 x 18
- 47 x 15 x 18
- 2 Door / 1 Section
- 35 x 15 x 18
- 29 x 15 x 18

Weight

		Standard Veneer Top Standard Veneer Chassis		Premium Veneer Top Premium Veneer Chassis		High Pressure Laminate Top Veneer Chassis	Thermally Fused Laminate Top Thermally Fused Laminate Chassis
	240	NSS9318WH331W	4633	NSS9318WH331P	5096	"G" Option N/A	NSS9318WH331M 3388
	225	NSS8718WH331W	4545	NSS8718WH331P	4999	"G" Option N/A	NSS8718WH331M 3230
	210	NSS8318WH331W	4447	NSS8318WH331P	4891	"G" Option N/A	NSS8318WH331M 2487
	195	NSS7618WH331W	4387	NSS7618WH331P	4826	"G" Option N/A	NSS7618WH331M 2329
	180	NSS7018WH331W	3663	NSS7018WH331P	4029	"G" Option N/A	NSS7018WH331M 2171
	160	NSS6418WH331W	3546	NSS6418WH331P	3902	"G" Option N/A	NSS6418WH331M 2115
	135	NSS5818WH331W	3437	NSS5818WH331P	3782	"G" Option N/A	NSS5818WH331M 2060
	125	NSS4718WH331W	2630	NSS4718WH331P	2893	"G" Option N/A	NSS4718WH331M 1984
	75	NSS3518WH331W	2005	NSS3518WH331P	2206	"G" Option N/A	NSS3518WH331M 1311
	65	NSS2918WH331W	1915	NSS2918WH331P	2106	"G" Option N/A	NSS2918WH331M 1262

2 Select Finish

[Click to view finishes](#)

- | | |
|-----|-------------|
| WAC | WNW |
| WIC | WWP |
| WHC | WNF(Natural |
| WOC | Oak on Flat |
| WEC | Cut) |
| WAM | WSF(Salted |
| WCM | Oak on Flat |
| WEW | Cut) |
| WGW | WMF(Mocha |
| WBW | Oak on Flat |
| WSW | Cut) |

- TBCO
- TBSW
- TSTV
- TSMV
- TSLV
- TOBV
- WMO
- WNO
- WSO

- MAC
- MOC
- MEC
- MGW
- MTW
- MSW
- MWL

3 Select Edge

[Click to view edges](#)

Edge
N/A

Edge
N/A

Edge
N/A

4 Select Hardware

[Click to view details](#)

Hardware
N/A

Hardware
N/A

Hardware
N/A

Product Features

- Finished top
- Interior cabinet depth 12"
- Mounting wall rail included
- Silverluma doors w/ frosted acrylic inserts

Notes

- The DARRAN wall mounted cabinet(or shelf) must be hung on a weight-bearing wall. The suitability of the wall supporting the wall mounted cabinet, and the installation and maintenance of the wall-mounted cabinet, is the sole responsibility of the customer. Failure to correctly install and/or exceed the loaded weight capacity of this product may cause it to fall, resulting in damage to the product, adjacent property and/or bodily injury.

Options

Door

- D2: Door Lock - \$100 per door set
- D6: Delete Doors - n/c
- D9SC: Soft Close Door Hinges - \$20 per door

Interior Cabinet Lighting

- LEDPK starter kit includes Infeed, 1 Puck Interior Light and the ability to daisy chain up to 6 total Puck Lights
- LED Puck Starter Kit - \$310
- PK: 1 LED Interior Light - \$130

Task Lighting

- Overhead task light cord is located on the right facing side. If the opposite location is required please contact customer service.
- LT-LED24: 24" LED Task light - \$215
- LT-LED48: 48" LED Task light - \$270
- LT-LED60: 60" LED Task light - \$335
- LT-LED72: 72" LED Task light - \$360

NOT SO square office

Single Height Wall Hung Overheads
Open Storage Cabinet

[Click here to view statement of line](#)

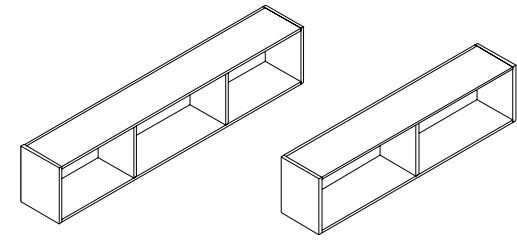

1 Select Model

w" x d" x h"
3 Section
93 x 14 x 18
87 x 14 x 18
83 x 14 x 18
76 x 14 x 18
2 Section
70 x 14 x 18
64 x 14 x 18
58 x 14 x 18
47 x 14 x 18
1 Section
35 x 14 x 18
29 x 14 x 18

Weight

Standard Veneer Top Standard Veneer Chassis	Premium Veneer Top Premium Veneer Chassis	High Pressure Laminate Top Veneer Chassis	Thermally Fused Laminate Top Thermally Fused Laminate Chassis
NSS9318WH332W 3774	NSS9318WH332P 4152	"G" Option N/A	NSS9318WH332M 2448
NSS8718WH332W 3739	NSS8718WH332P 4113	"G" Option N/A	NSS8718WH332M 2291
NSS8318WH332W 3704	NSS8318WH332P 4075	"G" Option N/A	NSS8318WH332M 1718
NSS7618WH332W 3663	NSS7618WH332P 4029	"G" Option N/A	NSS7618WH332M 1630
NSS7018WH332W 2996	NSS7018WH332P 3296	"G" Option N/A	NSS7018WH332M 1545
NSS6418WH332W 2949	NSS6418WH332P 3244	"G" Option N/A	NSS6418WH332M 1495
NSS5818WH332W 2908	NSS5818WH332P 3199	"G" Option N/A	NSS5818WH332M 1437
NSS4718WH332W 2171	NSS4718WH332P 2389	"G" Option N/A	NSS4718WH332M 1355
NSS3518WH332W 1632	NSS3518WH332P 1796	"G" Option N/A	NSS3518WH332M 1011
NSS2918WH332W 1614	NSS2918WH332P 1775	"G" Option N/A	NSS2918WH332M 963

2 Select Finish

[Click to view finishes](#)

WAC WNW
WIC WWP
WHC WNF(Natural
WOC Oak on Flat
WEC Cut)
WAM WSF(Salted
WCM Oak on Flat
WEW Cut)
WGW WMF(Mocha
WBW Oak on Flat
WSW Cut)

TBCO
TBSW
TSTV
TSMV
TSLV
TOBW
WMO
WNO
WSO

MAC
MOC
MEC
MGW
MTW
MSW
MWL

3 Select Edge

[Click to view edges](#)

Edge
N/A

Edge
N/A

Edge
N/A

4 Select Hardware

[Click to view details](#)

Hardware
N/A

Hardware
N/A

Hardware
N/A

Product Features

- Finished top
- Interior cabinet depth 12"
- Mounting wall rail included

Notes

- The DARRAN wall mounted cabinet(or shelf) must be hung on a weight-bearing wall. The suitability of the wall supporting the wall mounted cabinet, and the installation and maintenance of the wall-mounted cabinet, is the sole responsibility of the customer. Failure to correctly install and/or exceed the loaded weight capacity of this product may cause it to fall, resulting in damage to the product, adjacent property and/or bodily injury.
- Sliding doors will not pass each other

Options

Sliding Door

- SLD17LD: Laminate Door - \$205 per door
- SLD17FD: SilverLuma / Frost Door ("W", "M" only) - \$365 per door
- SLD17WD: Wood Door - \$260 per door

Interior Cabinet Lighting

- LEDPK starter kit includes Infeed, 1 Puck Interior Light and the ability to daisy chain up to 6 total Puck Lights
- LED Puck Starter Kit - \$310
- PK: 1 LED Interior Light - \$130

Task Lighting

- Overhead task light cord is located on the right facing side. If the opposite location is required please contact customer service.
- LT-LED24: 24" LED Task light - \$215
- LT-LED48: 48" LED Task light - \$270
- LT-LED60: 60" LED Task light - \$335
- LT-LED72: 72" LED Task light - \$360

NOT SO square office

Double Height Wall Hung Overheads
Panel Doors

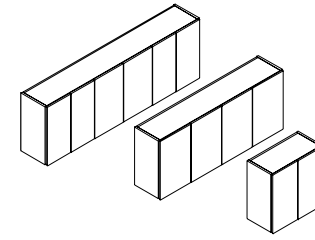

[Click here to view statement of line](#)

1 Select Model

w" x d" x h"	Weight
6 Door / 3 Section	
93 x 14 x 29	265
87 x 14 x 29	250
4 Door / 2 Section	
83 x 14 x 29	235
70 x 14 x 29	220
64 x 14 x 29	200
58 x 14 x 29	180
2 Door / 1 Section	
35 x 14 x 29	85
29 x 14 x 29	75

	Standard Veneer Top Standard Veneer Chassis	Premium Veneer Top Premium Veneer Chassis	High Pressure Laminate Top Veneer Chassis	Thermally Fused Laminate Top Thermally Fused Laminate Chassis
	NSS9329WH330W 4764	NSS9329WH330P 5240	"G" Option N/A	NSS9329WH330M 3545
	NSS8729WH330W 4689	NSS8729WH330P 5158	"G" Option N/A	NSS8729WH330M 3388
	NSS8329WH330W 4620	NSS8329WH330P 5082	"G" Option N/A	NSS8329WH330M 2507
	NSS7029WH330W 3897	NSS7029WH330P 4287	"G" Option N/A	NSS7029WH330M 2377
	NSS6429WH330W 3863	NSS6429WH330P 4250	"G" Option N/A	NSS6429WH330M 2325
	NSS5829WH330W 3787	NSS5829WH330P 4166	"G" Option N/A	NSS5829WH330M 2231
	NSS3529WH330W 2046	NSS3529WH330P 2251	"G" Option N/A	NSS3529WH330M 1600
	NSS2929WH330W 1998	NSS2929WH330P 2199	"G" Option N/A	NSS2929WH330M 1550

2 Select Finish

[Click to view finishes](#)

WAC	WNW	TBCO	MAC
WIC	WWP	TBSW	MOC
WHC	WNF(Natural	TSTV	MEC
WOC	Oak on Flat	TSMV	MGW
WEC	Cut)	TSLV	MTW
WAM	WSF(Salted	TOBW	MSW
WCM	Oak on Flat	WMO	MWL
WEW	Cut)	WNO	
WGW	WMF(Mocha	WSO	
WBW	Oak on Flat		
WSW	Cut)		

3 Select Edge

[Click to view edges](#)

Edge	Edge	Edge
N/A	N/A	N/A

4 Select Hardware

[Click to view details](#)

Hardware	Hardware	Hardware
N/A	N/A	N/A

Product Features

- 1 Adjustable shelf per section standard
- Black painted top
- Interior cabinet depth 12"
- Interior shelf depth 11.5"
- Mounting rails included
- Panel doors with concealed finger pull

Notes

- The DARRAN wall mounted cabinet(or shelf) must be hung on a weight-bearing wall. The suitability of the wall supporting the wall mounted cabinet, and the installation and maintenance of the wall-mounted cabinet, is the sole responsibility of the customer. Failure to correctly install and/or exceed the loaded weight capacity of this product may cause it to fall, resulting in damage to the product, adjacent property and/or bodily injury.

Options

Door

- D2: Door Lock - \$100 per door set
- D6: Delete Doors - n/c
- D9SC: Soft Close Door Hinges - \$20 per door
- WPD3061: Designer White - \$80 per door

Interior Cabinet Lighting

- LEDPK starter kit includes Infeed, 1 Puck Interior Light and the ability to daisy chain up to 6 total Puck Lights
- LED Puck Starter Kit - \$310
- PK: 1 LED Interior Light - \$130

Task Lighting

Overhead task light cord is located on the right facing side. If the opposite location is required please contact customer service.

- LT-LED24: 24" LED Task light - \$215
- LT-LED48: 48" LED Task light - \$270
- LT-LED60: 60" LED Task light - \$335
- LT-LED72: 72" LED Task light - \$360

Shelf

- S714F: Heavy Duty Lumber 1" Shelves - \$80 per shelf ("M" Styles - n/a)

NOT SO square office

Double Height Wall Hung Overheads
Silverluma Frame / Doors

[Click here to view statement of line](#)

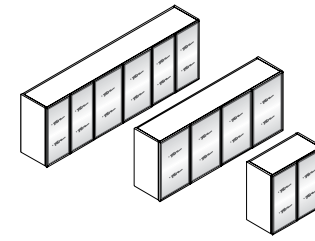

1 Select Model

w" x d" x h"	Weight
6 Door / 3 Section	
93 x 14 x 29	265
87 x 14 x 29	250
4 Door / 2 Section	
70 x 14 x 29	220
64 x 14 x 29	200
58 x 14 x 29	180
2 Door / 1 Section	
35 x 14 x 29	85
29 x 14 x 29	75

Standard Veneer Top Standard Veneer Chassis		Premium Veneer Top Premium Veneer Chassis		High Pressure Laminate Top Veneer Chassis		Thermally Fused Laminate Top Thermally Fused Laminate Chassis	
				"G" Option N/A			
				"G" Option N/A			
				"G" Option N/A			
				"G" Option N/A			
				"G" Option N/A			
				"G" Option N/A			
				"G" Option N/A			
				"G" Option N/A			
				"G" Option N/A			

Product Features

- Black painted top
- Interior cabinet depth 12"
- Interior shelf depth 11.5"
- Mounting rails included
- Silverluma doors w/ frosted acrylic inserts

Notes

- 1 Adjustable Shelf per section
- The DARRAN wall mounted cabinet(or shelf) must be hung on a weight-bearing wall. The suitability of the wall supporting the wall mounted cabinet, and the installation and maintenance of the wall-mounted cabinet, is the sole responsibility of the customer. Failure to correctly install and/or exceed the loaded weight capacity of this product may cause it to fall, resulting in damage to the product, adjacent property and/or bodily injury.

Options

Door

- D2: Door Lock - \$100 per door set
- D6: Delete Doors - n/c
- D9SC: Soft Close Door Hinges - \$20 per door

Interior Cabinet Lighting

- LEDPK starter kit includes Infeed, 1 Puck Interior Light and the ability to daisy chain up to 6 total Puck Lights
- LED Puck Starter Kit - \$310
- PK: 1 LED Interior Light - \$130

Task Lighting

- Overhead task light cord is located on the right facing side. If the opposite location is required please contact customer service.
- LT-LED24: 24" LED Task light - \$215
- LT-LED48: 48" LED Task light - \$270
- LT-LED60: 60" LED Task light - \$335
- LT-LED72: 72" LED Task light - \$360

Shelf

- GS14F: Replace Standard Shelves with Glass Shelves - \$90 per shelf
- S714F: Heavy Duty Lumber 1" Shelves - \$80 per shelf ("M" Styles - n/a)

2 Select Finish

[Click to view finishes](#)

WAC	WNW
WIC	WWP
WHC	WNF(Natural
WOC	Oak on Flat
WEC	Cut)
WAM	WSF(Salted
WCM	Oak on Flat
WEW	Cut)
WGW	WMF(Mocha
WBW	Oak on Flat
WSW	Cut)

TBCO
TBSW
TSTV
TSMV
TSLV
TOBW
WMO
WNO
WSO

MAC
MOC
MEC
MGW
MTW
MSW
MWL

3 Select Edge

[Click to view edges](#)

Edge
N/A

Edge
N/A

Edge
N/A

4 Select Hardware

[Click to view details](#)

Hardware
N/A

Hardware
N/A

Hardware
N/A

NOT SO square office

Double Height Wall Hung Overheads
Open Storage Cabinet

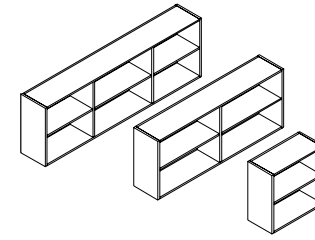

[Click here to view statement of line](#)

1 Select Model

w" x d" x h"	Weight
3 Section	
93 x 14 x 29	215
87 x 14 x 29	200
83 x 14 x 29	190
2 Section	
70 x 14 x 29	180
64 x 14 x 29	170
58 x 14 x 29	150
1 Section	
35 x 14 x 29	70
29 x 14 x 29	60

	Standard Veneer Top Standard Veneer Chassis		Premium Veneer Top Premium Veneer Chassis		High Pressure Laminate Top Veneer Chassis	Thermally Fused Laminate Top Thermally Fused Laminate Chassis	
	NSS9329WH332W	4309	NSS9329WH332P	4741	"G" Option N/A	NSS9329WH332M	2861
	NSS8729WH332W	4229	NSS8729WH332P	4652	"G" Option N/A	NSS8729WH332M	2702
	NSS8329WH332W	4151	NSS8329WH332P	4567	"G" Option N/A	NSS8329WH332M	2055
	NSS7029WH332W	3546	NSS7029WH332P	3902	"G" Option N/A	NSS7029WH332M	1910
	NSS6429WH332W	3478	NSS6429WH332P	3825	"G" Option N/A	NSS6429WH332M	1872
	NSS5829WH332W	3396	NSS5829WH332P	3736	"G" Option N/A	NSS5829WH332M	1780
	NSS3529WH332W	1896	NSS3529WH332P	2086	"G" Option N/A	NSS3529WH332M	1371
	NSS2929WH332W	1853	NSS2929WH332P	2039	"G" Option N/A	NSS2929WH332M	1324

2 Select Finish

[Click to view finishes](#)

WAC	WNW
WIC	WWP
WHC	WNF(Natural
WOC	Oak on Flat
WEC	Cut)
WAM	WSF(Salted
WCM	Oak on Flat
WEW	Cut)
WGW	WMF(Mocha
WBW	Oak on Flat
WSW	Cut)

TBCO
TBSW
TSTV
TSMV
TSLV
TOBW
WMO
WNO
WSO

MAC
MOC
MEC
MGW
MTW
MSW
MWL

3 Select Edge

[Click to view edges](#)

Edge
N/A

Edge
N/A

Edge
N/A

4 Select Hardware

[Click to view details](#)

Hardware
N/A

Hardware
N/A

Hardware
N/A

Product Features

- 1 Adjustable shelf per section
- Black painted top
- Interior cabinet depth 12"
- Interior shelf depth 11.5"
- Mounting rails included

Notes

- 1 or 2 Optional Doors Available
- Sliding doors will not pass each other
- The DARRAN wall mounted cabinet(or shelf) must be hung on a weight-bearing wall. The suitability of the wall supporting the wall mounted cabinet, and the installation and maintenance of the wall-mounted cabinet, is the sole responsibility of the customer. Failure to correctly install and/or exceed the loaded weight capacity of this product may cause it to fall, resulting in damage to the product, adjacent property and/or bodily injury.

Options

Sliding Door

- SLD29LD: Laminate Door - \$260 per door
- SLD29FD: SilverLuma / Frost Door ("W", "M" only) - \$415 per door
- SLD29WD: Wood Door - \$310 per door

Task Lighting

- Overhead task light cord is located on the right facing side. If the opposite location is required please contact customer service.
- LT-LED24: 24" LED Task light - \$215
 - LT-LED48: 48" LED Task light - \$270
 - LT-LED60: 60" LED Task light - \$335
 - LT-LED72: 72" LED Task light - \$360

Shelf

- GS14F: Replace Standard Shelves with Glass Shelves - \$90 per shelf
- S714F: Heavy Duty Lumber 1" Shelves - \$80 per shelf ("M" Styles - n/a)

Wall hung tackboards
Full width tackboards

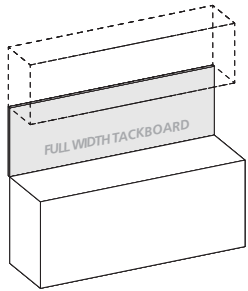

Product Width	Panel Dimension	SKU	COM	1	2	3	4	5	6	7	8	9	10	11/L1	12	13/L2
93"	93 x .75 x 24	FTWH9324	465	576	627	678	729	780	831	882	933	984	1035	1086	1137	1239
87"	87 x .75 x 24	FTWH8724	448	539	587	635	683	731	779	827	875	923	971	1019	1067	1163
83"	83 x .75 x 24	FTWH8324	422	514	560	606	652	698	744	790	836	882	928	974	1020	1112
76"	76 x .75 x 24	FTWH7624	388	471	514	557	600	643	686	729	772	815	858	901	944	1030
70"	70 x .75 x 24	FTWH7024	355	434	474	514	554	594	634	674	714	754	794	834	874	954
64"	64 x .75 x 24	FTWH6424	322	396	432	468	504	540	576	612	648	684	720	756	792	864
58"	58 x .75 x 24	FTWH5824	294	359	391	423	455	487	519	551	583	615	647	679	711	775
47"	47 x .75 x 24	FTWH4724	236	291	318	345	372	399	426	453	480	507	534	561	588	642
35"	35 x .75 x 24	FTWH3524	176	217	237	257	277	297	317	337	357	377	397	417	437	477
29"	29 x .75 x 24	FTWH2924	142	179	196	213	230	247	264	281	298	315	332	349	366	400

Standard Features

- Constructed of .5" thick fiberboard
- Fabric is precisely aligned and fitted to the tackboard
- Adhered to the rigid hardboard with staples

Wall hung tackboards
Half width tackboards

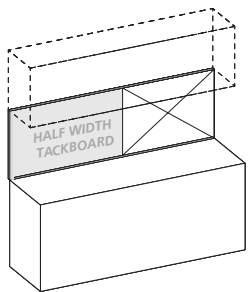

Product Width	Panel Dimension	SKU	COM	1	2	3	4	5	6	7	8	9	10	11/L1	12	13/L2
93 Half Width	46.5 x .75 x 24	FTWH4624	233	288	313	338	363	388	413	438	463	488	513	538	563	613
87 Half Width	43.5 x .75 x 24	FTWH4324	225	270	294	318	342	366	390	414	438	462	486	510	534	582
83 Half Width	41.5 x .75 x 24	FTWH4124	211	257	280	303	326	349	372	395	418	441	464	487	510	556
76 Half Width	38 x .75 x 24	FTWH3824	194	235	256	277	298	319	340	361	382	403	424	445	466	508
70 Half Width	35 x .75 x 24	FTWH3524	178	217	237	257	277	297	317	337	357	377	397	417	437	477
64 Half Width	32 x .75 x 24	FTWH3224	161	198	216	234	252	270	288	306	324	342	360	378	396	432

Standard Features

- Constructed of .5" thick fiberboard
- Fabric is precisely aligned and fitted to the tackboard
- Adhered to the rigid hardboard with staples
- Hung with Z-Strip mounting system

Notes

- Half width tackboards can be specified and combined with a Veneer Panel, Marker Board, Slat Wall or Glass Board. See "Half Width" items under product width.
- Specify right or left facing tackboard

DARRAN®

Wall hung dry marker board
Full width dry marker board

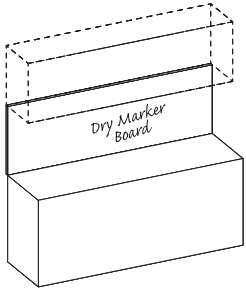

Product Width	Panel Dimension	SKU	List
93	93 x .75 x 24	DMWH9324	1161
87	87 x .75 x 24	DMWH8724	1086
83	83 x .75 x 24	DMWH8324	1023
76	76 x .75 x 24	DMWH7624	948
70	70 x .75 x 24	DMWH7024	874
64	64 x .75 x 24	DMWH6424	799
58	58 x .75 x 24	DMWH5824	724
47	47 x .75 x 24	DMWH4724	587
35	35 x .75 x 24	DMWH3524	437
29	29 x .75 x 24	DMWH2924	362

Standard Features

- Dry marker panel has edge trim molding
- Standard magnetic surface
- Hung with Z-Strip mounting system

Wall hung dry marker board
Half width dry marker board

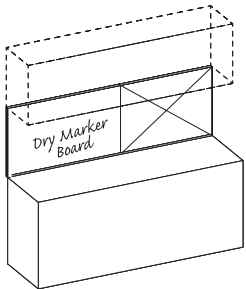

Product Width	Panel Dimension	SKU	List
93 Half Width	46.5 x .75 x 24	DMWH4624	580
87 Half Width	43.5 x .75 x 24	DMWH4324	543
83 Half Width	41.5 x .75 x 24	DMWH4124	518
76 Half Width	38 x .75 x 24	DMWH3824	474
70 Half Width	35 x .75 x 24	DMWH3524	437
64 Half Width	32 x .75 x 24	DMWH3224	399

Standard Features

- Dry marker panel has edge trim molding
- Standard magnetic surface
- Hung with Z-Strip mounting system

Notes

- Half width dry marker boards can be specified and combined with a Tackboard, Veneer Panel, Slat Wall or Glass Board. See "Half Width" items under product width.
- Specify right or left facing dry marker board

DARRAN®

Wall hung veneer panel
Full width veneer panel

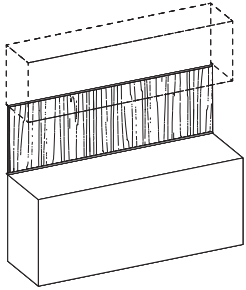

Product Width	Panel Dimension	SKU	List
93	93 x .75 x 24	VPWH9324	967
87	87 x .75 x 24	VPWH8724	905
83	83 x .75 x 24	VPWH8324	853
76	76 x .75 x 24	VPWH7624	790
70	70 x .75 x 24	VPWH7024	728
64	64 x .75 x 24	VPWH6424	666
58	58 x .75 x 24	VPWH5824	603
47	47 x .75 x 24	VPWH4724	489
35	35 x .75 x 24	VPWH3524	364
29	29 x .75 x 24	VPWH2924	302

Standard Features

- Veneer edges

Wall hung veneer panel
Hang width veneer panel

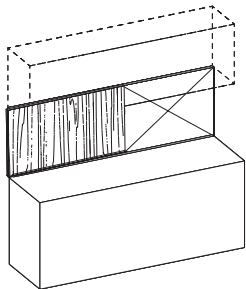

Product Width	Panel Dimension	SKU	List
93 Half Width	46.5 x .75 x 24	VPWH4624	484
87 Half Width	43.5 x .75 x 24	VPWH4324	452
83 Half Width	41.5 x .75 x 24	VPWH4124	432
76 Half Width	38 x .75 x 24	VPWH3824	395
70 Half Width	35 x .75 x 24	VPWH3524	364
64 Half Width	32 x .75 x 24	VPWH3224	333

Standard Features

- Veneer edges
- Vertical wire channels on back for task light cords
- Steel mounting wall channel is recessed for flush mounting
- Hung with Z-Strip mounting system

NSS Office Tackboards

Notes

- Vertical wire channels on back for task light cords
- Steel mounting wall channel is recessed for flush mounting
- Hung with Z-Strip mounting system
- Can be used with or without overhead cabinet
- Required for other accessory panels

Notes

- Half width veneer panels can be specified and combined with a Tackboard, Marker Board, Slat Wall or Glass Board. See "Half Width" items under product width.
- Specify right or left facing veneer panel
- Can be used with or without overhead cabinet
- Required for other accessory panels

Wall hung glassboard
Full width glassboards

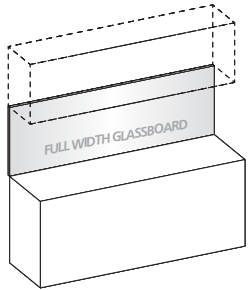

Product Width	Panel Dimension	SKU	List
93	93 x .75 x 24	GBWH9324	2753
87	87 x .75 x 24	GBWH8724	2586
83	83 x .75 x 24	GBWH8324	2475
76	76 x .75 x 24	GBWH7624	2281
70	70 x .75 x 24	GBWH7024	2114
64	64 x .75 x 24	GBWH6424	1948
58	58 x .75 x 24	GBWH5824	1780
47	47 x .75 x 24	GBWH4724	1476
35	35 x .75 x 24	GBWH3524	1142
29	29 x .75 x 24	GBWH2924	976

Standard Features

- 4 mm tempered glass

Notes

- Earth magnets are required to hold items securely in place
- Hung with Z-Strip mounting system
- Use glass cleaner or alcohol to clean
- Standard dry erase markers may be used

Wall hung glassboard
Half width glassboards

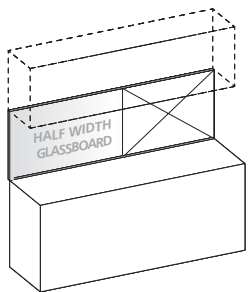

Product Width	Panel Dimension	SKU	List
93 Half Width	46.5 x .75 x 24	GBWH4624	1461
87 Half Width	43.5 x .75 x 24	GBWH4324	1378
83 Half Width	41.5 x .75 x 24	GBWH4124	1323
76 Half Width	38 x .75 x 24	GBWH3824	1232
70 Half Width	35 x .75 x 24	GBWH3524	1142
64 Half Width	32 x .75 x 24	GBWH3224	1059

Standard Features

- 4 mm tempered glass
- Hung with Z-Strip mounting system

Notes

- Half width glassboards can be specified and combined with a Tackboard, Veneer panel, Marker Board or Slat Wall. See "Half Width" items under product width.
- Must specify Right or left facing glassboard
- Use glass cleaner or alcohol to clean
- Standard dry erase markers may be used
- Earth magnets are required to hold items securely in place

DARRAN®

Wall hung slat wall
Half width slat wall

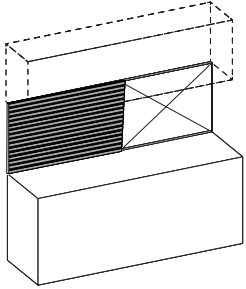

Product Width	Panel Dimension	SKU	List
93 Half Width	46.5 x .75 x 24	SWWH4624	484
87 Half Width	43.5 x .75 x 24	SWWH4324	452
83 Half Width	41.5 x .75 x 24	SWWH4124	432
76 Half Width	38 x .75 x 24	SWWH3824	395
70 Half Width	35 x .75 x 24	SWWH3524	364
64 Half Width	32 x .75 x 24	SWWH3224	333

Standard Features

- Available in silver or black
- Hung with Z-Strip mounting system

Notes

- Half width slat walls can be specified and combined with a Tackboard, Veneer panel, Marker Board or Glassboard. See "Half Width" items under product width.
- Specify right or left facing slat wall
- For use on 42"/43" height consoles

NSS Office Tackboards

NOT SO square office

Single Height Wall Hung Overheads
Open Endless Shelf Single Height

[Click here to view statement of line](#)

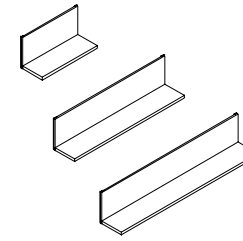

1 Select Model

w" x d" x h"	Height
105 x 9 x 18	110
99 x 9 x 18	105
93 x 9 x 18	100
87 x 9 x 18	95
83 x 9 x 18	90
76 x 9 x 18	85
70 x 9 x 18	80
64 x 9 x 18	75
58 x 9 x 18	70
48 x 9 x 18	50
35 x 9 x 18	35
29 x 9 x 18	30

Standard Veneer Top Standard Veneer Chassis	Premium Veneer Top Premium Veneer Chassis	High Pressure Laminate Top Veneer Chassis	Thermally Fused Laminate Top Thermally Fused Laminate Chassis
NSS10518WH336W 3742	NSS10518WH336P 3777	"G" Option N/A	"M" Option N/A
NSS9918WH336W 3529	NSS9918WH336P 3561	"G" Option N/A	"M" Option N/A
NSS9318WH336W 3320	NSS9318WH336P 3652	"G" Option N/A	NSS9318WH336M 2012
NSS8718WH336W 3112	NSS8718WH336P 3424	"G" Option N/A	NSS8718WH336M 1937
NSS8318WH336W 2974	NSS8318WH336P 3272	"G" Option N/A	NSS8318WH336M 1874
NSS7618WH336W 2733	NSS7618WH336P 3007	"G" Option N/A	NSS7618WH336M 1814
NSS7018WH336W 2528	NSS7018WH336P 2781	"G" Option N/A	NSS7018WH336M 1772
NSS6418WH336W 2321	NSS6418WH336P 2553	"G" Option N/A	NSS6418WH336M 1662
NSS5818WH336W 2115	NSS5818WH336P 2327	"G" Option N/A	NSS5818WH336M 1584
NSS4818WH336W 1833	NSS4818WH336P 2017	"G" Option N/A	NSS4818WH336M 1282
NSS3518WH336W 1407	NSS3518WH336P 1547	"G" Option N/A	NSS3518WH336M 1053
NSS2918WH336W 1201	NSS2918WH336P 1322	"G" Option N/A	NSS2918WH336M 971
	TBCO		MAC
	TBSW		MOC
	TSTV		MEC
	TSMV		MGW
	TSLV		MTW
	TOBW		MSW
	WMO		MWL
	WNO		
	WSO		
	Edge N/A		Edge N/A
	Hardware N/A		Hardware N/A

Product Features

- Mounting rails included

Notes

- The DARRAN wall mounted cabinet(or shelf) must be hung on a weight-bearing wall. The suitability of the wall supporting the wall mounted cabinet, and the installation and maintenance of the wall-mounted cabinet, is the sole responsibility of the customer. Failure to correctly install and/or exceed the loaded weight capacity of this product may cause it to fall, resulting in damage to the product, adjacent property and/or bodily injury.

- Max load per inch is 3lbs

Options

Task Lighting

Overhead task light cord is located on the right facing side. If the opposite location is required please contact customer service.

- LT-LED24: 24" LED Task light - \$215
- LT-LED48: 48" LED Task light - \$270
- LT-LED60: 60" LED Task light - \$335
- LT-LED72: 72" LED Task light - \$360

2 Select Finish

[Click to view finishes](#)

WAC	WNW
WIC	WWP
WHC	WNF(Natural
WOC	Oak on Flat
WEC	Cut)
WAM	WSF(Salted
WCM	Oak on Flat
WEW	Cut)
WGW	WMF(Mocha
WBW	Oak on Flat
WSW	Cut)

3 Select Edge

[Click to view edges](#)

Edge
N/A

4 Select Hardware

[Click to view details](#)

Hardware
N/A

NOT SO square office

Double Height Wall Hung Overheads
Open Endless Shelf Double Height

[Click here to view statement of line](#)

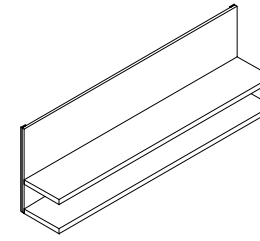

1 Select Model

w" x d" x h"	Weight
105 x 9 x 29	180
99 x 9 x 29	170
93 x 9 x 29	160
87 x 9 x 29	150
83 x 9 x 29	140
76 x 9 x 29	130
70 x 9 x 29	120
64 x 9 x 29	110
58 x 9 x 29	100
48 x 9 x 29	80
35 x 9 x 29	60
29 x 9 x 29	50

Standard Veneer Top Standard Veneer Chassis	Premium Veneer Top Premium Veneer Chassis	High Pressure Laminate Top Veneer Chassis	Thermally Fused Laminate Top Thermally Fused Laminate Chassis
NSS10529WH336W 4442	NSS10518WH336P 4887	"G" Option N/A	"M" Option N/A
NSS9929WH336W 4187	NSS9918WH336P 4607	"G" Option N/A	"M" Option N/A
NSS9329WH336W 3932	NSS9329WH336P 4326	"G" Option N/A	NSS9329WH336M 2369
NSS8729WH336W 3686	NSS8729WH336P 4055	"G" Option N/A	NSS8729WH336M 2288
NSS8329WH336W 3520	NSS8329WH336P 3872	"G" Option N/A	NSS8329WH336M 2208
NSS7629WH336W 3230	NSS7629WH336P 3554	"G" Option N/A	NSS7629WH336M 2131
NSS7029WH336W 2983	NSS7029WH336P 3281	"G" Option N/A	NSS7029WH336M 2079
NSS6429WH336W 2733	NSS6429WH336P 3007	"G" Option N/A	NSS6429WH336M 1948
NSS5829WH336W 2487	NSS5829WH336P 2736	"G" Option N/A	NSS5829WH336M 1856
NSS4829WH336W 2148	NSS4829WH336P 2363	"G" Option N/A	NSS4829WH336M 1494
NSS3529WH336W 1640	NSS3529WH336P 1804	"G" Option N/A	NSS3529WH336M 1218
NSS2929WH336W 1394	NSS2929WH336P 1533	"G" Option N/A	NSS2929WH336M 1119
	TBCO		MAC
	TBSW		MOC
	TSTV		MEC
	TSMV		MGW
	TSLV		MTW
	TOBW		MSW
	WMO		MWL
	WNO		
	WSO		
	Edge N/A		Edge N/A
	Hardware N/A		Hardware N/A

Product Features

- Mounting rails included

Notes

- The DARRAN wall mounted cabinet(or shelf) must be hung on a weight-bearing wall. The suitability of the wall supporting the wall mounted cabinet, and the installation and maintenance of the wall-mounted cabinet, is the sole responsibility of the customer. Failure to correctly install and/or exceed the loaded weight capacity of this product may cause it to fall, resulting in damage to the product, adjacent property and/or bodily injury.

- Max load per inch is 6lbs

Options

Task Lighting

Overhead task light cord is located on the right facing side. If the opposite location is required please contact customer service.

- LT-LED24: 24" LED Task light - \$215
- LT-LED48: 48" LED Task light - \$270
- LT-LED60: 60" LED Task light - \$335
- LT-LED72: 72" LED Task light - \$360

2 Select Finish

[Click to view finishes](#)

WAC	WNW
WIC	WWP
WHC	WNF(Natural
WOC	Oak on Flat
WEC	Cut)
WAM	WSF(Salted
WCM	Oak on Flat
WEW	Cut)
WGW	WMF(Mocha
WBW	Oak on Flat
WSW	Cut)

3 Select Edge

[Click to view edges](#)

Edge
N/A

4 Select Hardware

[Click to view details](#)

Hardware
N/A

NOT SO square office

Overhead Bookcases
Panel Doors / Storage

[Click here to view statement of line](#)

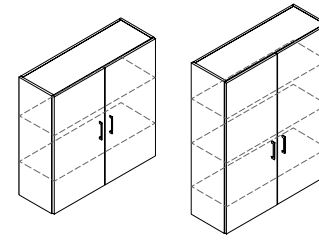

1 Select Model

w" x d" x h"	Weight
42" Height	
42 x 14 x 42	150
35 x 14 x 42	130
29 x 14 x 42	120
54" Height	
42 x 14 x 54	165
35 x 14 x 54	145
29 x 14 x 54	135

	Standard Veneer Top Standard Veneer Chassis		Premium Veneer Top Premium Veneer Chassis		High Pressure Laminate Top Veneer Chassis	Thermally Fused Laminate Top Thermally Fused Laminate Chassis	
2 Select Finish Click to view finishes	WAC WIC WHC WOC WEC WAM WCM WEW WGW WBW WSW	WNW WWP WNF(Natural Oak on Flat Cut) WSF(Salted Oak on Flat Cut) WMF(Mocha Oak on Flat Cut)	TBCO TBSW TSTV TSMV TSLV TOBW WMO WNO WSO		"G" Option N/A "G" Option N/A "G" Option N/A "G" Option N/A "G" Option N/A "G" Option N/A		MAC MOC MEC MGW MTW MSW MWL
3 Select Edge Click to view edges	Edge N/A		Edge N/A				Edge N/A
4 Select Hardware Click to view details	 Touch Latch PL-115 Matte Black PL-116 Matte Nickel PL-210 Anodized Aluminum		 Touch Latch PL-115 Matte Black PL-116 Matte Nickel PL-210 Anodized Aluminum				 Touch Latch PL-115 Matte Black PL-116 Matte Nickel PL-210 Anodized Aluminum

Product Features

- 54" H unit has 1 adjustable shelf behind door
- Adjustable shelves (Full Storage), 42" - 2 shelves, 54" - 3 shelves
- Interior shelf depth 12"
- Interior cabinet depth 12.5"
- "W" styles - 42" H units finished top, 54" H units black painted top

Notes

- 1 Lock needed
- Unit has black back panel and is not designed for Open Plan use. Select OPB Option for Open Plan application.

Options

Door

- D2: Door Lock - \$100 per door set
- D6: Delete Doors - n/c
- D9SC: Soft Close Door Hinges - \$20 per door
- WPD3061: Designer White - \$80 per door

Interior Cabinet Lighting

- LEDPK starter kit includes Infeed, 1 Puck Interior Light and the ability to daisy chain up to 6 total Puck Lights
- LED Puck Starter Kit - \$310
- PK: 1 LED Interior Light - \$130

Open Plan _ Finished Back

- OPB: "W" "G" Style - Modify Unit for Open Plan Application - \$295
- OPBM: "M" Style - Modify Unit for Open Plan Application - \$95

Shelf

- S714F: Heavy Duty Lumber 1" Shelves - \$80 per shelf ("M" Styles - n/a)
- GS14F: Replace Standard Shelves with Glass Shelves - \$90 per shelf

NOT SO square office

Freestanding Half Towers
Wardrobe / Storage

[Click here to view statement of line](#)

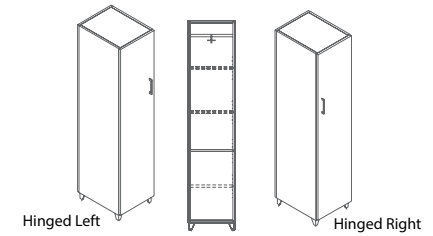

1 Select Model

- w" x d" x h"
Door Hinged Left
16 x 21 x 83
16 x 21 x 71
Door Hinged Right
16 x 21 x 83
16 x 21 x 71

Weight	Standard Veneer Top Standard Veneer Chassis	Premium Veneer Top Premium Veneer Chassis	High Pressure Laminate Top Veneer Chassis	Thermally Fused Laminate Top Thermally Fused Laminate Chassis
180	NSS1683TW283W 3939	NSS1683TW283P 4333	"G" Option N/A	NSS1683TW283M 1886
165	NSS1671TW283W 3746	NSS1671TW283P 4121	"G" Option N/A	NSS1671TW283M 1669
180	NSS1683TW284W 3939	NSS1683TW284P 4333	"G" Option N/A	NSS1683TW284M 1886
165	NSS1671TW284W 3746	NSS1671TW284P 4121	"G" Option N/A	NSS1671TW284M 1669

2 Select Finish

[Click to view finishes](#)

Metal Finish
MFS Silver. Additional
Metal Finishes are
available, options

WAC	WNW
WIC	WWP
WHC	WNF(Natural
WOC	Oak on Flat
WEC	Cut)
WAM	WSF(Salted
WCM	Oak on Flat
WEW	Cut)
WGW	WMF(Mocha
WBW	Oak on Flat
WSW	Cut)

TBCO
TBSW
TSTV
TSMV
TSLV
TOBW
WMO
WNO
WSO

MAC
MOC
MEC
MGW
MTW
MSW
MWL

3 Select Edge

[Click to view edges](#)

Edge
N/A

Edge
N/A

Edge
N/A

4 Select Hardware

[Click to view details](#)

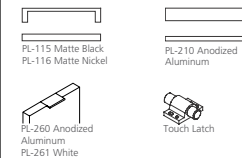
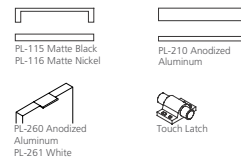
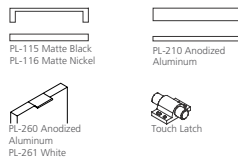

Product Features

- Interior cabinet depth 12.5"
- Standard fixed shelf with 3 adjustable shelves
- Standard Silver Feet (optional White, Black)
- "W" styles - 71" H units finished top, 83" H units black painted top

Notes

- Flush cut credenza ends when ganging towers to credenza
- Unit has black back panel and is not designed for Open Plan use. Select OPB Option for Open Plan application.

Options

Door

- D2: Door Lock - \$100 per door set
- D6: Delete Doors - n/c
- D9SC: Soft Close Door Hinges - \$20 per door
- WPD3061: Designer White - \$80 per door

Feet

- D8: Delete feet (extend fronts to floor) - n/c

Open Plan _ Finished Back

- OPB: "W" "G" Style - Modify Unit for Open Plan Application - \$295
- OPBM: "M" Style - Modify Unit for Open Plan Application - \$95

Premium Finish Option

- MFB: Black Metal Finish - \$30 per foot
- MFW: White Metal Finish - \$30 per foot

NOT SO square office

Freestanding Half Towers
Storage / File

[Click here to view statement of line](#)

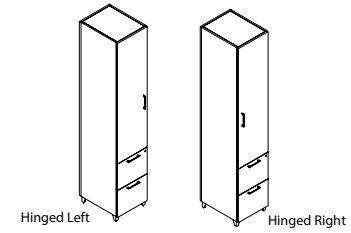

1 Select Model

w" x d" x h"
Door Hinged Left
16 x 21 x 83
16 x 21 x 71
Door Hinged Right
16 x 21 x 83
16 x 21 x 71

Weight	Standard Veneer Top Standard Veneer Chassis		Premium Veneer Top Premium Veneer Chassis		High Pressure Laminate Top Veneer Chassis	Thermally Fused Laminate Top Thermally Fused Laminate Chassis
	190	NSS1683TW291W	4104	NSS1683TW291P	4515	"G" Option N/A
175	NSS1671TW291W	3905	NSS1671TW291P	4296	"G" Option N/A	NSS1671TW291M 2060
190	NSS1683TW292W	4104	NSS1683TW292P	4515	"G" Option N/A	NSS1683TW292M 2275
175	NSS1671TW292W	3905	NSS1671TW292P	4296	"G" Option N/A	NSS1671TW292M 2060

Product Features

- Interior cabinet depth 12.5"
- Soft close suspension drawer(s)
- Standard fixed shelf with 2 adjustable shelves (71")
- Standard fixed shelf with 3 adjustable shelves (83")
- Standard Silver Feet (optional White, Black)
- "W" styles - 71" H units finished top, 83" H units black painted top

Notes

- Flush cut credenza ends when ganging towers to credenza
- Unit has black back panel and is not designed for Open Plan use. Select OPB Option for Open Plan application.

Options

Door

- D2: Door Lock - \$100 per door set
- D6: Delete Doors - n/c
- D9SC: Soft Close Door Hinges - \$20 per door
- WPD3061: Designer White - \$80 per door

Drawer

- P6: Modify File/File to Box/Box/File - \$55 per pedestal
- P33: Wood Drawer Upgrade - \$45 per drawer

Feet

- D8: Delete feet (extend fronts to floor) - n/c

Open Plan _ Finished Back

- OPB: "W" "G" Style - Modify Unit for Open Plan Application - \$295
- OPBM: "M" Style - Modify Unit for Open Plan Application - \$95

Premium Finish Option

- Specify foot Metal Finish color - \$160 per unit. Contact customer service
- MFB: Black, MFW: White

2 Select Finish

[Click to view finishes](#)

WAC	WNW	TBCO	MAC
WIC	WWP	TBSW	MOC
WHC	WNF(Natural	TSTV	MEC
WOC	Oak on Flat	TSMV	MGW
WEC	Cut)	TSLV	MTW
WAM	WSF(Salted	TOBW	MSW
WCM	Oak on Flat	WMO	MWL
WEW	Cut)	WNO	
WGW	WMF(Mocha	WSO	
WBW	Oak on Flat		
WSW	Cut)		

3 Select Edge

[Click to view edges](#)

Edge
N/A

Edge
N/A

Edge
N/A

4 Select Hardware

[Click to view details](#)



NOT SO square office

Freestanding Towers
Storage / File- Mini-Wardrobe

[Click here to view statement of line](#)

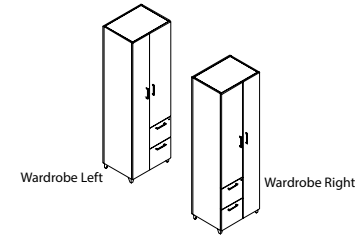

1 Select Model

w" x d" x h"
Wardrobe Left
26 x 21 x 83
26 x 21 x 71
Wardrobe Right
26 x 21 x 83
26 x 21 x 71

Weight	Standard Veneer Top Standard Veneer Chassis	Premium Veneer Top Premium Veneer Chassis	High Pressure Laminate Top Veneer Chassis	Thermally Fused Laminate Top Thermally Fused Laminate Chassis
265	NSS2683TW293W 4929	NSS2683TW293P 5423	"G" Option N/A	NSS2683TW293M 2606
240	NSS2671TW293W 4709	NSS2671TW293P 5180	"G" Option N/A	NSS2671TW293M 2320
265	NSS2683TW294W 4929	NSS2683TW294P 5423	"G" Option N/A	NSS2683TW294M 2606
240	NSS2671TW294W 4709	NSS2671TW294P 5180	"G" Option N/A	NSS2671TW294M 2320

2 Select Finish

Click to view finishes

Metal Finish
MFS Silver. Additional
Metal Finishes are
available, options

WAC	WNW	TBCO
WIC	WWP	TBSW
WHC	WNF(Natural	TSTV
WOC	Oak on Flat	TSMV
WEC	Cut)	TSLV
WAM	WSF(Salted	TOBW
WCM	Oak on Flat	WMO
WEW	Cut)	WNO
WGW	WMF(Mocha	WSO
WBW	Oak on Flat	
WSW	Cut)	

3 Select Edge

Click to view edges

Edge
N/A

Edge
N/A

Edge
N/A

4 Select Hardware

Click to view details

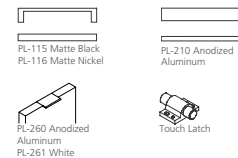
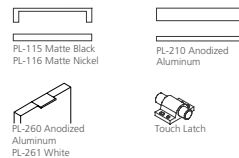
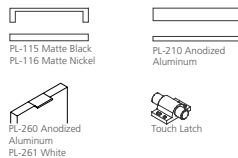

Product Features

- Interior cabinet depth 12.5"
- Full extension drawers
- Locking drawers
- Soft close suspension drawer(s)
- Standard fixed shelf with 2 adjustable shelves (71")
- Standard fixed shelf with 3 adjustable shelves (83")
- Standard Silver Feet (optional White, Black)
- "W" styles - 71" H units finished top, 83" H units black painted top

Notes

- Flush cut credenza ends when ganging towers to credenza

Options

Door

- D2: Door Lock - \$100 per door set
- D6: Delete Doors - n/c
- D9SC: Soft Close Door Hinges - \$20 per door
- WPD3061: Designer White - \$80 per door

Drawer

- P6: Modify File/File to Box/Box/File - \$55 per pedestal
- P33: Wood Drawer Upgrade - \$45 per drawer

Feet

- D8: Delete feet (extend fronts to floor) - n/c

Open Plan _ Finished Back

- OPB: "W" "G" Style - Modify Unit for Open Plan Application - \$295
- OPBM: "M" Style - Modify Unit for Open Plan Application - \$95

Premium Finish Option

- Specify foot Metal Finish color - \$160 per unit. Contact customer service
- MFB: Black, MFW: White

NOT SO square office

Freestanding Towers
Wardrobe / Storage Full Tower

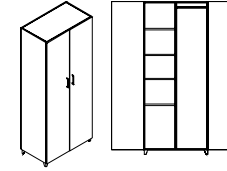

[Click here to view statement of line](#)

1 Select Model

w" x d" x h"	Weight
83" Height	
35 x 21 x 83	310
29 x 21 x 83	265
71" Height	
35 x 21 x 71	285
29 x 21 x 71	240

	Standard Veneer Top Standard Veneer Chassis	Premium Veneer Top Premium Veneer Chassis	High Pressure Laminate Top Veneer Chassis	Thermally Fused Laminate Top Thermally Fused Laminate Chassis
2 Select Finish Click to view finishes	WAC WIC WHC WOC WEC WAM WCM WEW WGW WBW WSW	WNW WWP WNF(Natural Oak on Flat Cut) WSF(Salted Oak on Flat Cut) WMF(Mocha Oak on Flat Cut)	TBCO TBSW TSTV TSMV TSLV TOBW WMO WNO WSO	MAC MOC MEC MGW MTW MSW MWL
3 Select Edge Click to view edges	Edge N/A	Edge N/A	Edge N/A	Edge N/A
4 Select Hardware Click to view details				

Product Features

- Wardrobe left, storage right
- Interior cabinet depth 12.5"
- Standard 2 fixed shelves with 2 adjustable shelves (71")
- Standard 2 fixed shelves with 3 adjustable shelves (83")
- Standard Silver Feet (optional White, Black)
- "W" styles - 71" H units finished top, 83" H units black painted top

Notes

- Flush cut credenza ends when ganging towers to credenza
- Unit has black back panel and is not designed for Open Plan use. Select OPB Option for Open Plan application.
- When specifying MOD310P, 1 lock needed

Options

Door

- D2: Door Lock - \$100 per door set
- D6: Delete Doors - n/c
- D9SC: Soft Close Door Hinges - \$20 per door
- WPD3061: Designer White - \$80 per door

Feet

- D8: Delete feet (extend fronts to floor) - n/c

Open Plan _ Finished Back

- OPB: "W" "G" Style - Modify Unit for Open Plan Application - \$295
- OPBM: "M" Style - Modify Unit for Open Plan Application - \$95

Shelf

- MOD310P: Delete Center Partition / Add (3 - 71" / 4 - 83") Full Width Adj. Shelves & (1) Fixed - \$295

Premium Finish Option

- Specify foot Metal Finish color - \$160 per unit. Contact customer service
- MFB: Black, MFW: White

NOT SO square office

Freestanding Towers
Storage / File Full Tower

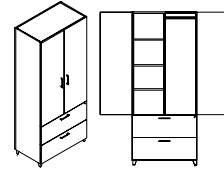

[Click here to view statement of line](#)

1 Select Model

w" x d" x h"
83" Height
35 x 21 x 83
29 x 21 x 83
71" Height
35 x 21 x 71
29 x 21 x 71

Weight	Standard Veneer Top Standard Veneer Chassis	Premium Veneer Top Premium Veneer Chassis	High Pressure Laminate Top Veneer Chassis	Thermally Fused Laminate Top Thermally Fused Laminate Chassis
350	NSS3583TW281W 5582	NSS3583TW281P 6142	"G" Option N/A	NSS3583TW281M 2957
325	NSS2983TW281W 5301	NSS2983TW281P 5832	"G" Option N/A	NSS2983TW281M 2903
325	NSS3571TW281W 4985	NSS3571TW281P 5484	"G" Option N/A	NSS3571TW281M 2670
295	NSS2971TW281W 4738	NSS2971TW281P 5212	"G" Option N/A	NSS2971TW281M 2608

Product Features

- 71" has 2 adj. shelves / 1 fixed shelf
- 83" has 3 adj. shelves / 1 fixed shelf
- Adjustable shelf per door section
- Full extension drawers
- Locking drawers
- Features ball bearing suspensions, suspensions are full extension
- Standard Silver Feet (optional White, Black)
- "W" styles - 71" H units finished top, 83" H units black painted top
- Wardrobe left, storage right

2 Select Finish

[Click to view finishes](#)

WAC
WIC
WHC
WOC
WEC
WAM
WCM
WEW
WGW
WBW
WSW

WNW
WWP
WNF(Natural
Oak on Flat
Cut)
WSF(Salted
Oak on Flat
Cut)
WMF(Mocha
Oak on Flat
Cut)

TBCO
TBSW
TSTV
TSMV
TSLV
TOBW
WMO
WNO
WSO

MAC
MOC
MEC
MGW
MTW
MSW
MWL

3 Select Edge

[Click to view edges](#)

Edge
N/A

Edge
N/A

Edge
N/A

4 Select Hardware

[Click to view details](#)

PL-115 Matte Black
PL-116 Matte Nickel

PL-210 Anodized
Aluminum

PL-115 Matte Black
PL-116 Matte Nickel

PL-210 Anodized
Aluminum

PL-115 Matte Black
PL-116 Matte Nickel

PL-210 Anodized
Aluminum

PL-260 Anodized
Aluminum
PL-261 White

Touch Latch

PL-260 Anodized
Aluminum
PL-261 White

Touch Latch

PL-260 Anodized
Aluminum
PL-261 White

Touch Latch

Notes

- Flush cut credenza ends when ganging towers to credenza
- Unit has black back panel and is not designed for Open Plan use. Select OPB Option for Open Plan application.

Options

Door

- D2: Door Lock - \$100 per door set
- D6: Delete Doors - n/c
- D9SC: Soft Close Door Hinges - \$20 per door
- WPD3061: Designer White - \$80 per door

Drawer

- P33: Wood Drawer Upgrade - \$45 per drawer

Feet

- D8: Delete feet (extend fronts to floor) - n/c

Open Plan _ Finished Back

- OPB: "W" "G" Style - Modify Unit for Open Plan Application - \$295
- OPBM: "M" Style - Modify Unit for Open Plan Application - \$95

Shelf

- MOD300P: Delete Center Partition / Add 2 (71") or 3 (83") Full Width Adj. Shelves - \$295

Premium Finish Option

- Specify foot Metal Finish color - \$160 per unit. Contact customer service
- MFB: Black, MFW: White

NOT SO square office

Open Bookcases
Freestanding

[Click here to view statement of line](#)

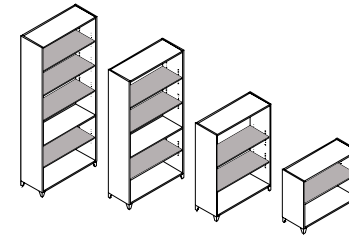

1 Select Model

w" x d" x h"	Weight
35" Width	
35 x 14 x 83	195
35 x 14 x 71	175
35 x 14 x 60	155
35 x 14 x 48	120
35 x 14 x 29	95
29" Width	
29 x 14 x 83	190
29 x 14 x 71	170
29 x 14 x 60	150
29 x 14 x 48	115
29 x 14 x 29	90

	Standard Veneer Top Standard Veneer Chassis	Premium Veneer Top Premium Veneer Chassis	High Pressure Laminate Top Veneer Chassis	Thermally Fused Laminate Top Thermally Fused Laminate Chassis
			"G" Option N/A	NSS3583BK250M 1643
			"G" Option N/A	NSS3571BK250M 1523
			"G" Option N/A	NSS3560BK250M 1436
			"G" Option N/A	NSS3548BK250M 1299
			"G" Option N/A	NSS3529BK250M 1001
			"G" Option N/A	NSS2983BK250M 1613
			"G" Option N/A	NSS2971BK250M 1491
			"G" Option N/A	NSS2960BK250M 1403
			"G" Option N/A	NSS2948BK250M 1264
			"G" Option N/A	NSS2929BK250M 953
		TBCO		MAC
		TBSW		MOC
		TSTV		MEC
		TSMV		MGW
		TSLV		MTW
		TOBW		MSW
		WMO		MWL
		WNO		
		WSO		
		Edge N/A		Edge N/A
		Hardware N/A		Hardware N/A

Product Features

- 3/4" thick back
- Interior shelf depth 12"
- Metal legs standard
- Standard Silver Feet (optional White, Black)
- "W" styles - 29", 48", 60", and 71" H units finished top, 83" H units black painted top

Notes

- Adjustable shelves shaded in gray
- Unit has black back panel and is not designed for Open Plan use. Select OPB Option for Open Plan application.

Options

Feet

- D8: Delete feet - n/c

Interior Cabinet Lighting

- LEDPK starter kit includes Infeed, 1 Puck Interior Light and the ability to daisy chain up to 6 total Puck Lights
- LED Puck Starter Kit - \$310
- PK: 1 LED Interior Light - \$130

Open Plan _ Finished Back

- OPB: "W" "G" Style - Modify Unit for Open Plan Application - \$295
- OPBM: "M" Style - Modify Unit for Open Plan Application - \$95

Shelf

- GS14F: Replace Standard Shelves with Glass Shelves - \$90 per shelf
- S714F: Heavy Duty Lumber 1" Shelves - \$80 per shelf ("M" Styles - n/a)

Premium Finish Option

- Specify foot Metal Finish color - \$160 per unit. Contact customer service
- MFB: Black, MFW: White

2 Select Finish

[Click to view finishes](#)

WAC	WNW
WIC	WWP
WHC	WNF(Natural
WOC	Oak on Flat
WEC	Cut)
WAM	WSF(Salted
WCM	Oak on Flat
WEW	Cut)
WGW	WMF(Mocha
WBW	Oak on Flat
WSW	Cut)

3 Select Edge

[Click to view edges](#)

Edge
N/A

4 Select Hardware

[Click to view details](#)

Hardware
N/A

Interior drawer dimensions

UNIT DEPTH	DRAWER TYPE	OVERALL DIMENSIONS			INTERIOR DRAWER DIMENSIONS			NOTES
		W	D	H	W	D	H	
15-5/8" Letter	36" Box	13-1/8	19-11/16	4	12-1/8	18-11/16	3-7/16	Units less than 72"
	36" File	13-1/8	19-11/16	9-13/16	12-1/8	18-11/16	9-5/16	Units less than 72"
	30" Box	13-1/8	19-11/16	4	12-1/8	18-11/16	3-7/16	Units less than 72"
	30" File	13-1/8	19-11/16	9-13/16	12-1/8	18-11/16	9-5/16	Units less than 72"
	24" Box	13-1/8	16-1/16	4	12-1/8	15-1/16	3-7/16	Units less than 72"
	24" File	13-1/8	16-1/16	9-13/16	12-1/8	15-1/16	9-5/16	Units less than 72"
29" Lateral	24" Box	26-1/2	16-1/16	4	25-1/2	15-1/16	3-7/16	Workstation Credenzas less than 82"
	24" File	26-1/2	16-1/16	9-13/16	25-1/2	15-1/16	9-5/16	Workstation Credenzas less than 82"
31" Lateral	24" File	28-9/16	16-1/16	9-13/16	27-9/16	15-1/16	9-5/16	Multi-File Lateral File
35" Lateral	24" Box	32-1/2	16-1/16	4	31-1/2	15-1/16	3-7/16	Workstation Credenzas over 83"
	24" File	32-1/2	16-1/16	9-13/16	31-1/2	15-1/16	9-5/16	Workstation Credenzas over 83"
41" Lateral	24" File	38-1/2	16-1/16	9-13/16	37-1/2	15-1/16	9-5/16	Wood Drawer Only

Filing for 24" Depth Units

13" Wide File Drawer - 16" Deep

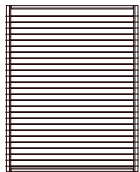

Letter Front to Back

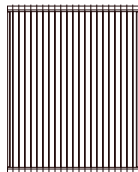

Legal Side to Side with File Rail

29" Lateral File Drawer

26-1/2" Wide File Drawer - 16-1/16" Deep

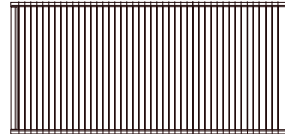

Legal Side to Side

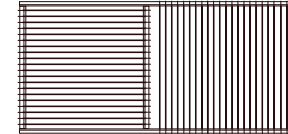

Legal Side to Side Letter Front to Back with File Rail



Letter Front to Back with File Rail

Filing for 30" & 36" Depth Units

13" Wide File Drawer - 20" Deep

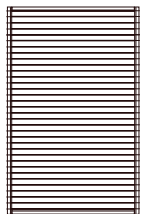

Letter Front to Back

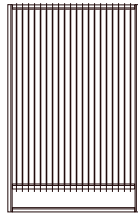

Legal Side to Side with File Rail

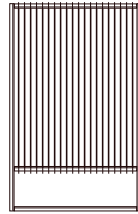

Letter Side to Side with File Rail

35" Lateral File Drawer

32-1/2" Wide File Drawer - 16-1/16" Deep

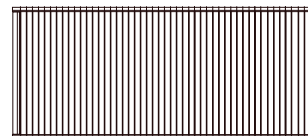

Legal Side to Side

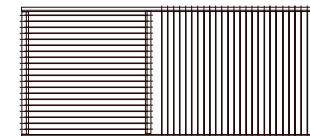

Legal Side to Side Letter Front to Back with File Rail

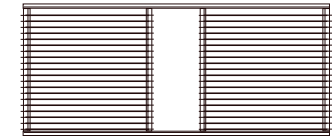

Letter Front to Back with File Rail



COMPUTER SUPPORT
single monitor arm

Style Number	List Price
MA1	280



COMPUTER SUPPORT
double monitor arm

Style Number	List Price
MA2	450



COMPUTER SUPPORT
triple monitor arm

Style Number	List Price
MA3	530



COMPUTER SUPPORT
quadruple monitor arm

Style Number	List Price
MA4	705

Specifications

- Available in black or silver
- Desk clamp and mounting included
- Easy assembly and flexibility
- Elastic painting process for a durable and beautiful finish
- Gas spring tension adjustment for counter-balance height adjustment for monitors 1-8 KG
- Gas spring tested to 50,000 repetitions
- Hidden cable management

Specifications

- Available in black or silver
- Desk clamp and mounting included
- Easy assembly and flexibility
- Elastic painting process for a durable and beautiful finish
- Gas spring tension adjustment for counter-balance height adjustment for monitors 1-8 KG
- Gas spring tested to 50,000 repetitions
- Hidden cable management

Specifications

- Available in black or silver
- Desk clamp and mounting included
- Easy assembly and flexibility
- Elastic painting process for a durable and beautiful finish
- Gas spring tension adjustment for counter-balance height adjustment for monitors 1-8 KG
- Gas spring tested to 50,000 repetitions
- Hidden cable management

Specifications

- Available in black
- Desk clamp and mounting included
- Easy assembly and flexibility
- Elastic painting process for a durable and beautiful finish
- Gas spring tension adjustment for counter-balance height adjustment for monitors 1-8 KG
- Gas spring tested to 50,000 repetitions
- Hidden cable management

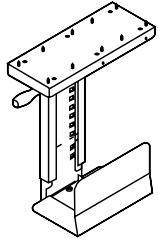

COMPUTER SUPPORT
cpu retractable cradle

Style Number	List Price
K18	205

Specifications

- Black Metal CPU Carriage
- Full 360° swivel capability allows easy access to rear of CPU for cables / wires
- Track allows 8- 1/2" extension
- Width Adjustment 5-1/2" to 9-1/4"
- Height adjustment 14- 5/8" to 20- 1/2"
- Black epoxy finish

Notes
- Factory Installed

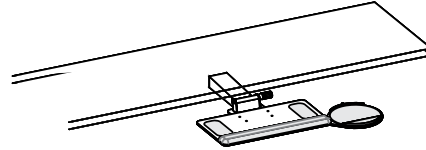

COMPUTER SUPPORT
articulating keyboard tray

Style Number	List Price
Factory Installed K28	395
Field Installed K28F	415

Specifications

- Adjusts effortlessly - A simple one-handed motion allows the keyboard to be repositioned instantly, without the use of locks or levers
- Encourages low-risk postures - Maximizes adjustability within a safe operating range.
- Will last a lifetime - Exceeds all applicable BIFMA Standards and comes with a lifetime guarantee.

Notes
- Available on: Freestanding Desk
- Factory Installed (standard)
- FIELD INSTALL - \$415



DOOR MODIFICATIONS
soft close door hinge

Style Number	List Price
D9SC	20 Per door

Specifications

- Snap onto standard door hinge
- Requires (2) per door
- Max door height 43"
- Factory installed where specified
- Individually shipped for field installation

Notes
- Specify Each Item To Have Slow Close Feature

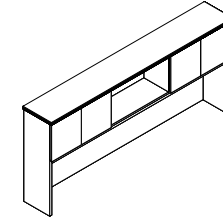

DOOR MODIFICATIONS
delete doors

Style Number	List Price
D6	N/C

Specifications

- Standard Door overheads and cabinets can have door deleted for open access. Modification of hinge rails and structural components are made face ready.

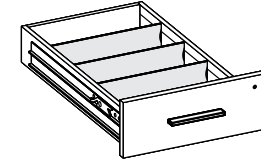
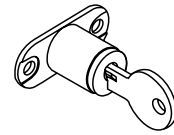
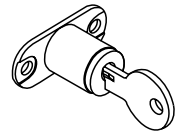
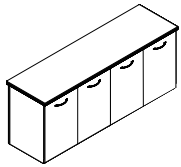

DOOR MODIFICATIONS
delete doors/replace black laminate shelf w/ finished shelf

Style Number	List Price
D6A	N/C

DOOR MODIFICATIONS
panel door lock

Style Number	List Price
D2	100 Per door set

DOOR MODIFICATIONS
glass door lock

Style Number	List Price
D2-G	205 Per door set

DRAWER OPTIONS
box drawer accessories

Style Number	List Price
Wood Drawer Dividers w/ Clips K-DIV	SET OF 3 - 30
Single Tray - Utility Tray K-Sut	35 ea.

Specifications

- Delete doors and replace black laminate shelf with finished shelf

Notes
- Available on: All Storage "W"/"G" Style Credenzas.

Specifications

- Door Locks - 1 Door w/ Lock, Other Door w/ Catch Latch
- Contact Customer Service regarding limited lock locations and keying.

Notes
- Available on: Panel Doors, Wood Frame Doors, and Silverluma doors

Specifications

- Door Locks - 1 Door w/ Lock, Other Door w/ Catch Latch
- Contact Customer Service regarding limited lock locations and keying.

Notes
- Available on: Glass Doors

Specifications

- K-DIV Extra Wood Drawer Dividers with Clips, Top Box drawers standard with 1 divider
- K-SUT Single Tray - Utility Tray, Specify Legal or Letter drawer width

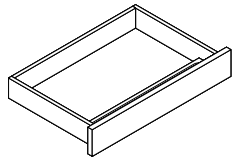

DRAWER OPTIONS
finished center drawer

Style Number	List Price
K31	205
Add Skirt Option K31-SK	310

Specifications

- Veneer drawer front finished to match unit W or G style veneer.
- Ball bearing smooth operation
- Drawer has lifetime guarantee
- Standard with matching wood grain pencil tray
- Laminate drawer front to match laminate unit (M style)

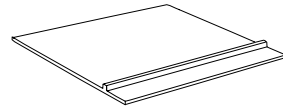

DRAWER OPTIONS - BOTTOM COVER
felt bottom center drawer insert liner

Style Number	List Price
K3	100

Specifications

- Inserts into center drawer and features divider for open pen and pencil storage. Removable for easy cleaning.
- Adds a luxurious touch to center drawers.
- Color: Dark Brown Coal

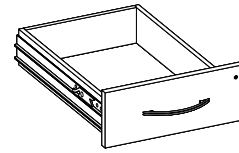

DRAWER OPTIONS - UPGRADE
wood drawer upgrade

Style Number	List Price
P33	45 Per drawer

Specifications

- Dowel joint construction
- Hardwood veneer multi-ply drawer
- UV finish
- 1/4" Wood veneer bottoms
- File drawer bottoms are five block reinforced for heavy weight capacity
- Lifetime guaranteed

GLASSBOARD ACCESSORIES
glassboard accessory kit

Style Number	List Price
GBKIT	290

Specifications

- 8 Earth magnets, 1 magnetic marker cup holder and 1 magnetic dry eraser

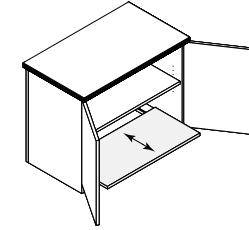
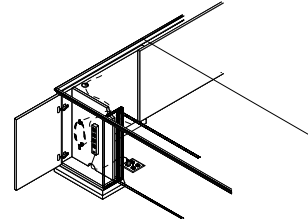
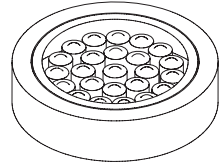

TASK LIGHTING
lt-led task light

Style Number	List Price
LT-LED24	215
LT-LED48	270
LT-LED60	335
LT-LED72	360

Specifications

- 6.5' Power cord. Switch with touch dimmer
- 36 LEDs per foot
- 4.6 Watts per foot
- 91 Lumens per watt
- Please note when ganging.
- Overhead tasklight cord is located on the right facing side. If the opposite location is required please contact customer service.

LIGHTING
led interior cabinet puck light

Style Number	List Price
Starter Kit	
LEDPK	310
1 LED Interior Puck Light	
PK	130

Specifications

- Starter kit includes Infeed, 1 Puck Interior Light and the ability to daisy chain up to 6 total Puck Lights
- (1) LED Puck Light with 30W power drive and switch
- Recessed fixture
- 12V linking cord 98"L
- Silver finish
- 50,000 hour life
- 2 watt per light

Notes

- Available on: Overhead/Tower Units with glass doors or no doors
- Power drive included, Light only

PEDESTAL MODIFICATIONS
breakfront pedestal with wire management cavity door

Style Number	List Price
PC10	100
Power Supply Cordset	
PD717	100

Specifications

- Hinged pedestal front door offers easy access for wire management
- Wire hooks provide wire coil storage
- Wire access openings allow access to floor, cabinets interior and kneespace
- Cabinet interior is black finish
- Top grommet is positioned over cavity for access ease
- (Power Strip Optional)

Notes

- Breakfront Chassis Only

PEDESTAL MODIFICATIONS
black laminate printer pullout bottom shelf

Style Number	List Price
PPOS	225

Specifications

- Black Laminate pullout shelf on suspension
- Black grommet
- Adjustable Shelf

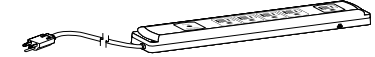
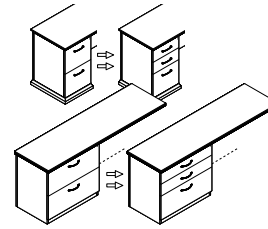
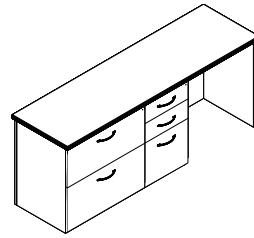
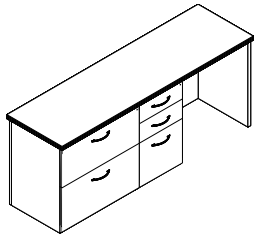

PEDESTAL MODIFICATIONS
add veneer kneespace cabinets - no base

Style Number	List Price
Add Box/Box/File or File/File P40W	910
Add Lateral File 29" W P41W	1025
Add Multi-File - 31"W P42W	1140
Add Storage With Doors 29"W P43W	1025
Add CPU /Printer Cabinet - Open P44W	1025

Specifications

- Multi-file specify Box/Box Left or Right

Notes
- Add additional Standard Cabinets To Kneespace Area.

PEDESTAL MODIFICATIONS
add melamine (tfl) kneespace cabinets - no base

Style Number	List Price
Add Box/Box/File or File/File P40M	720
Add Lateral File 29" W P41M	890
Add Multi-File - 31"W P42M	1005
Add Storage With Doors 29"W P43M	800
Add CPU /Printer Cabinet - Open P44M	915

Specifications

- Multi-file specify Box/Box Left or Right

Notes
- Available on: TFL products
- Add additional Standard Cabinets To Kneespace Area.

PEDESTAL MODIFICATIONS
modify drawer configurations

Style Number	List Price
File/File to Box/Box/File P6	55 Per ped
Box/Box/File to File/File P6	55 Per ped
Lateral File to 2 Box Drawers P8	100 Per ped

Specifications

- Modify File/File To Box/Box/File - Any Unit

POWER / DATA
power supply cordset

Style Number	List Price
PD717	100

Specifications

- SIZE: 10.75"L x 2.0"W x 1.06"H
- (5) Outlets w/ 10' cord
- Surge suppression (720 Joules)
- 15 Amp breaker
- Available on: Vertical Panels, Cabinet Interiors, and under tops

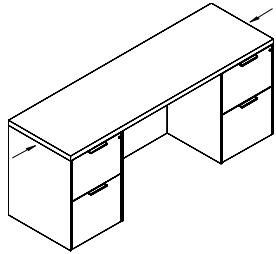

PRODUCT MODIFICATIONS
 modify width - open kneespace

Style Number	List Price
MOD-1	125

Specifications

- Modify width down on any unit with an open kneespace: desk, workstation credenza, bridge, return

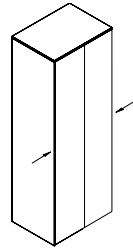

PRODUCT MODIFICATIONS
 modify width - open/closed storage

Style Number	List Price
MOD-2	250

Specifications

- Modify width down on any unit with open or closed storage section: overheads, wall hung units, storage credenzas, towers

PRODUCT MODIFICATIONS
 modify width - outside of mod-1, mod-2

Style Number	List Price
MOD-3	Contact for pricing

Specifications

- Width modification outside of MOD-1 & MOD-2

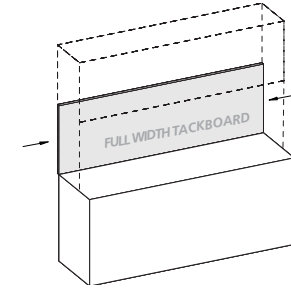

PRODUCT MODIFICATIONS
 modify width - tackboard, slat wall, veneer panel, or a glassboard

Style Number	List Price
MOD-4	50

Specifications

- Modify width down on tackboard, slat wall, veneer panel, or a overhead glassboard

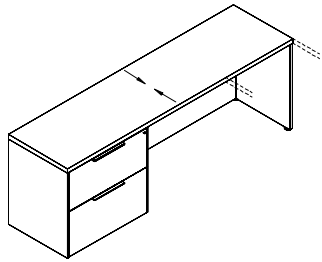

PRODUCT MODIFICATIONS
modify depth - decrease depth

Style Number	List Price
MOD-5	125

Specifications

- Modify depth down (minimum depth for a unit with drawers is 21"D)

Notes
- Ex. 24" to 21", 30" to 24", and 36" to 30"

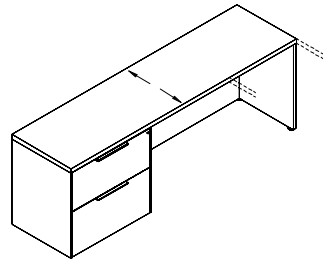

PRODUCT MODIFICATIONS
modify depth - increase depth

Style Number	List Price
MOD-6	Add 10%

Specifications

- Increase depth by no more than 6"

Notes
- Ex. 24" to 30", 30" to 36", and 36" to 42"
- Add 10% to the unit you want to increase the depth of by no more than 6"

PRODUCT MODIFICATIONS
modify height

Style Number	List Price
MOD-7	Contact for pricing

Specifications

- Modify height of a unit

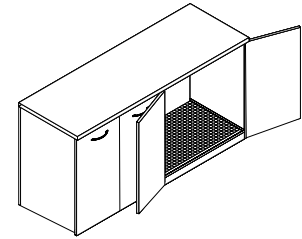

REFRIGERATOR MODIFICATION
refrigerator cabinet modification

Style Number	List Price
REF01	205

Specifications

- Open back cutout for venting
- Moisture sponge mat
- Contaminate ledge
- Contact customer service for maximum refrigerator size (Changes based on unit).

Notes
- Available on: 36" and 42" Storage Credenzas

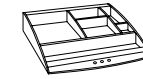
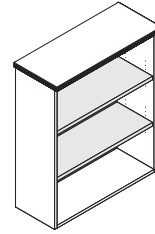
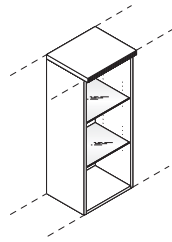
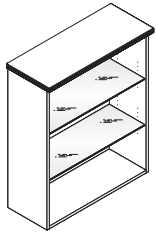

SHELF MODIFICATIONS

glass shelves - tempered full width
26" - 35"

Style Number	List Price
26"W - 35"W x 14"D Shelf GS14F	90

SHELF MODIFICATIONS

tempered glass shelves for half
cabinet 17- 1/2" widths

Style Number	List Price
14-1/2"W - 17- 1/2"W x 14"D Shelf GS14H	70 ea.

SHELF MODIFICATIONS

heavy duty solid wood bookcase
replacement shelves

Style Number	List Price
1" Wood Shelf 14" Deep S714F	80 ea.
1" Wood Shelf 24" Deep S714FX	160 ea.

SLAT WALL ACCESSORIES

slat wall accessory tray

Style Number	List Price
SWA9	50

Specifications

- Glass Shelves Replace Wood Shelf In Open Or Glass Door Cabinet. Also Order Interior Cabinet Lighting.

Specifications

- Glass Shelves Replace Wood Shelf In Open Or Glass Door Cabinet. Also Order Interior Cabinet Lighting.

Notes

- Replace only adjustable shelves between cabinet light and fixed lower wood shelf.

Specifications

- 1" Solid Lumber Core Shelves Replace Standard 3/4" Plywood Adjustable And Fixed Shelves

Specifications

- Specify Black Or Matte Silver

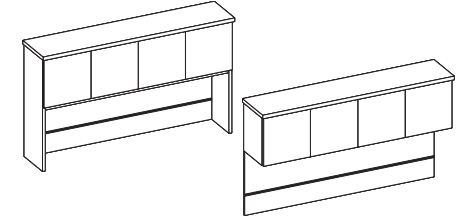
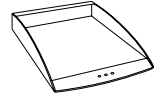

SLAT WALL ACCESSORIES
slat wall folder tray

SLAT WALL ACCESSORIES
slat wall paper tray

SLAT WALL ACCESSORIES
slat wall pencil holder

TOOL CHANNEL ACCESSORIES
recessed aluminum tool channel

Style Number	List Price
SWA7	50

Style Number	List Price
SWA2	40

Style Number	List Price
SWA4	30

Style Number	List Price
ATB02	5 per 1"W

Specifications

- Specify Black Or Matte Silver

Specifications

- Specify Black Or Matte Silver

Specifications

- Specify Black Or Matte Silver

Specifications

- Anodized aluminum finish
- Fully recessed
- Finish matches anodized aluminum accessories
- Can be specified with fabric tack surface mounted above channel

Notes

- If using tool channel with wallhung overhead, a veneer panel must be specified.



TOOL CHANNEL ACCESSORIES
iphone holder

Style Number	List Price
ATB31	125

Specifications

- For Console/Wall Hung Back Panels With Optional Tool Bar
- 18 Gauge Steel - Stamp Formed
- Silver Powdercoat Finish
- 5" x 3 -3/4"W
- Non-slip Neoprene pad

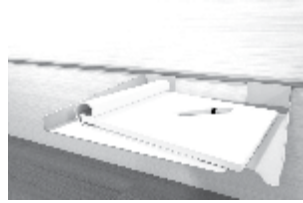

TOOL CHANNEL ACCESSORIES
large shelf

Style Number	List Price
ATB35	135

Specifications

- 12"W x 10"D

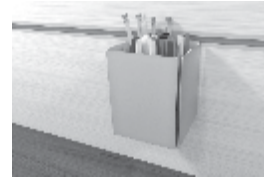

TOOL CHANNEL ACCESSORIES
pencil pen holder

Style Number	List Price
ATB38	120

Specifications

- For Console/Wall Hung Back Panels With Optional Tool Bar
- 18 Gauge Steel - Stamp Formed
- Silver Powdercoat Finish
- 5"H x 4"W x 4"D



TOOL CHANNEL ACCESSORIES
tablet holder

Style Number	List Price
ATB30	145

Specifications

- For Console/Wall Hung Back Panels With Optional Tool Bar
- 18 Gauge Steel - Stamp Formed
- Silver Powdercoat Finish
- 10" x 8"W
- Non-slip Neoprene pad

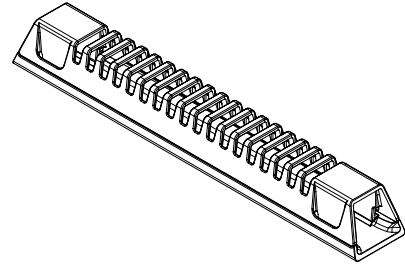
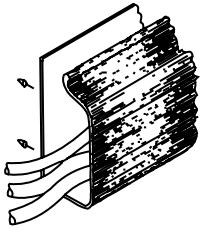

WIRE MANAGEMENT
horizontal j-channel wire management raceway

WIRE MANAGEMENT
horizontal wire management raceway

WIRE MANAGEMENT
horizontal u-channel wire management raceway

WIRE MANAGEMENT
coil wire manager

Style Number	List Price
W1	80 Per 4' section

Style Number	List Price
W21	35

Style Number	List Price
W2A	80 Per 4' section

Style Number	List Price
W18	160

Specifications

- 4' section for field installation.
- The "J" shape black thermoplastic wire raceway may be added to specified worksurface tops to provide concealed channeling of wires to and from worksurface grommets. For use in open kneespace areas, raceway is attachable to top of back panel with pan head screws. Interior dimensions are 1" x 1- 1/2" providing ample storage for multiple wires and excess cable. Front of raceway flexes out for easy cord insertion.

- Notes
- Units w/ Wire Channel Standard.
 - Field Installation

Specifications

- 10"W x 1.5"D x 1.25"H
- Grey Wire Manager (10.5")
- Power and data cables can be discretely housed and managed with the W21 Gray Wire Manager. This can be mounted in any location to metal frame or underside of conference tables and runs cables through a 1" channel from power module to hollow steel legs. This keeps cables organized under the table top. Release clips make it simple to snap on and off the Wire Manager for easy organization and access after attached to the table

- Notes
- Field installed

Specifications

- 4' section for field installation.
- Notes
- Units w/ Wire Channel Standard.
 - Field Installation

Specifications

- Weighted Base, Table attachment plate
 - 39- 1/2" Length
 - Black
- Notes
- Location

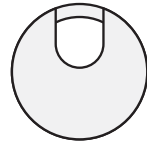
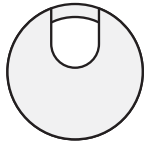

WIRE MANAGEMENT

standard location grommets - factory installed

Style Number	List Price
Standard Location Grommet	
Black	
TM30	50
Silver	
TM31	50
Antique Brass	
TM33	50
White	
TM34	50

WIRE MANAGEMENT

non-standard location grommets - factory installed

Style Number	List Price
Non-Standard Location Grommet	
Black	
TM30 -NS	95
Silver	
TM31 -NS	95
Antique Brass	
TM33 -NS	95
White	
TM34 -NS	95

WIRE MANAGEMENT

black plastic vertical surface grommets - factory installed

Style Number	List Price
Standard Location Grommet	
TM50-C	50
Non-Standard Location Grommet	
TM50-NS	95

Specifications

- 1 -5/8" Metal Grommet

Notes

- *Units w/ Grommets Standard Are Noted Under Standard Features. Grommets Match Pull Finish - Standard (Unless Specified Otherwise)

Specifications

- 1 -5/8" Metal Grommet

Notes

- *Units w/ Grommets Standard Are Noted Under Standard Features. Grommets Match Pull Finish - Standard (Unless Specified Otherwise)

Specifications

- 2 " Black Plastic Grommet

Notes

- Standard Location is Bottom Center

Aircharge wireless charging grommet

Style Number	List Price
ACWG WIRELESS GROMMET	\$195

Specifications

- > When used with GROVE Tables an additional \$350 LIST will apply for the special cutout required.
- > AirCharge offers a convenient way to charge any Qi compatible smartphone or device without the need to carry charging cables or find an available power outlet.
- > The Aircharge is powered by the latest Qi compliant IC offering reliable and efficient wireless charging in a convenient 3" grommet hub. Simply place your phone on the Aircharge and an LED will confirm pairing and begin wireless charging.
- > Recess: Efficient space conservation and quick access
- > Input: DC 5V (with included AC power adapter), DC 9V, 1.67A (with optional QC 2.0 power adapter)
- > Output: 5 watts Max. with DC 5V, 2A power adapter, 10 watts Max. with QC 2.0 power adapter
- > Qi V1.2 compliant IC
- > Charging distance: 6mm Max.

Available: All DARRAN collections



Cove power unit - non-linking

Style Number	List Price
 PD-COVE PLUG Non-linking version	\$550

Specifications

- > Size 5.75"L x 2.5"W
- > (2) 15 Amp Receptacles and (2) USB charging ports
- > Surface Mount
- > 108" Cord
- > Standard Silver Finish, Available in White or Black Finish upon request
- > ETL Listed

Available: All DARRAN collections



Cove corded series

Style Number	List Price
 PD-COVE-PKO	\$800

Specifications

- > Size 9.5"L x 2.5"W x 3.18"D
- > When used with GROVE Tables an additional \$350 LIST will apply for the special cutout required.
- > (2) Power Receptacles, (2) 2.1 Amp USB charging ports and (1) Telecom Plate Knockout
- > Surface Mount
- > 108" Cord
- > Standard Silver Finish, Available in White or Black Finish upon request
- > ETL Listed

Available: All DARRAN collections

Telecom Plates	
RJ45 (1)	\$55
RJ45 (2)	\$110
RJ45 (3)	\$165
USB (1)	\$70
USB (2)	\$140
RJ11/RJ45	\$110
RJ45/USB	\$125
RJ45/HDMI	\$210
HDMI/DVI	\$325
HDMI/USB	\$205
HDMI/VGA	\$240
VGA/MINI-STEREO	\$155
VGA/USB	\$175

This pod can have up to 1 total plates.
 *All telecom connectors sold separately.



Soba wire manager

Style Number	List Price
STARTER UNITS	
SCDW	\$200
White wire manager	
SCDB	\$200
Black wire manager	

Specifications

- > Dimensions: 9ft x 9in x 3.15in
- > Zips up, bundles and routes loose, messy cables into a single tube
- > Routes and guides cables behind desks, TVs, and anywhere cables tend to get messy
- > Accommodates large or small cables, up to three cables at once
- > Support channels, used to route cables, include powerful adhesive backing which allows easy attachment to surfaces.

Available: All DARRAN collections



VILLA Power unit - non-linking

Style Number	List Price
VIL-C PLUG Non-Linking	\$515



Specifications

- > Size: Top Grommet 5.68"L X 3.39"W; Under Top 12"L x 3.13"W x 3.08"D
- > (2) Power receptacles; (2) USB charging ports and (1) Knockouts for RJ45 Data Ports
- > Surface Mount
- > 72" Cord (Longer cord available, contact Customer Service)
- > Standard Silver Finish, Black Finish available upon request
- > UL or ETL Certified

Available: All DARRAN collections, excludes Grove

RJ45 Knockout RJ45 (1)	\$55
---------------------------	------

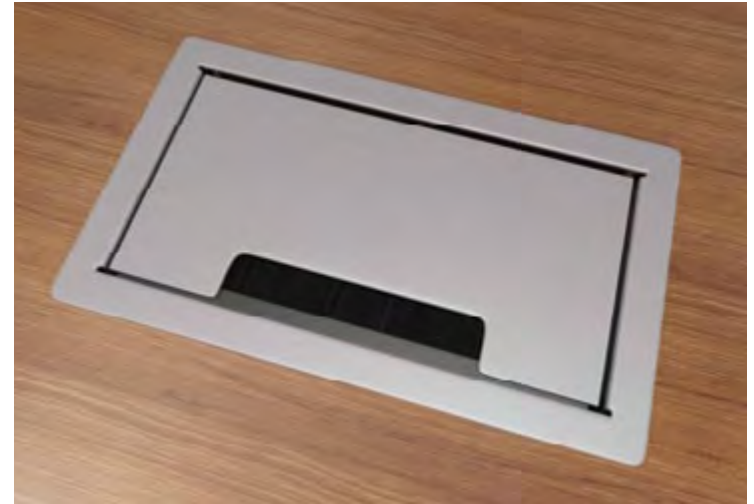

DARRAN®



Prado Price List

Effective November 1, 2022

Designed By David Allan Pessa

Date	Page	Modification	Description
11.11.22		Price Increase	9% price increase applied to all items excluding options
01.18.23	7	Grommets removed from M34 and M51	
02.15.23	59-60	Removed leather inlays	

Statement of Line
Features & Advantages1
Finishes | Specifications3
Edges | Pulls | Knobs.....4
Grommets | Grommet Reference.....5
Ganging | Height Reference6
Modesty Reference | Doors | Grain Direction7
Drawer Dimensions | Filing Reference8
Double Pedestal Desk.....9
Table Desk.....11
Single Pedestal Desk.....12
Returns.....14
Bridges17
Freestanding Credenzas18
Workstation Credenzas25
Single Height Freestanding Overheads.....28
Overhead Accessories.....30
Single Height Wall Hung Overheads.....34
Wall Hung Accessories36
Overhead Half Towers.....41
Overhead Bookcases43
Vertical Half Towers.....44
Vertical Full Towers.....45
Bookcases.....48
Options49
Power & Data.....64

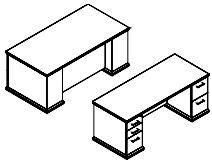

Page 9
Desk
Breakfront - Double Pedestal

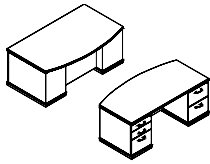

Page 10
Desk
Bowfront / Breakfront Double Pedestal

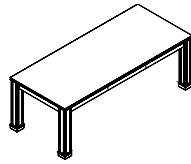

Page 11
Table Desks
Fluted Leg Table Desk

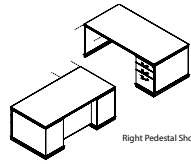

Page 12
Workstation Desks
Breakfront - Single Pedestal

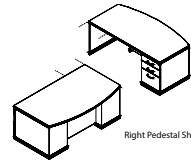

Page 13
Workstation Desks
Bowfront / Breakfront Single Pedestal

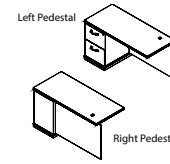

Page 14
Workstation "L" Returns
File / File

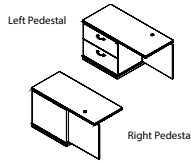

Page 15
Workstation "L" Returns
Lateral File

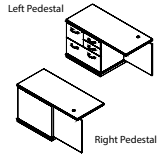

Page 16
Workstation "L" Returns
Multi-File

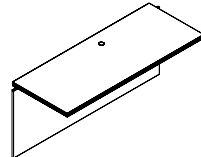

Page 17
Workstation Bridges
Bridge - Fixed Back

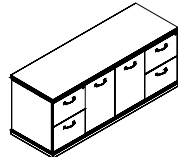

Page 18
Credenzas
File / Storage

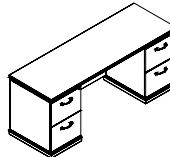

Page 19
Credenzas
Kneespace

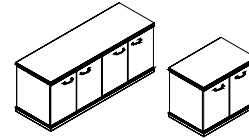

Page 20
Credenzas
Storage Units

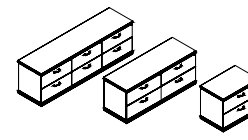

Page 21
Credenzas
Lateral Files



Page 22
Credenzas
Vertical Lateral File

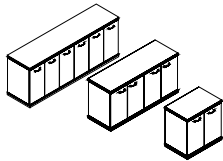

Page 23
Credenzas
Conference Storage

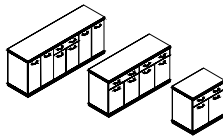

Page 24
Credenzas
Buffet Credenza

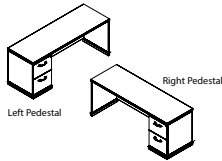

Page 25
Workstation Credenzas
File / File

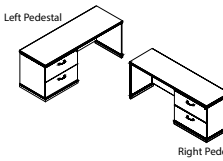

Page 26
Workstation Credenzas
Lateral File

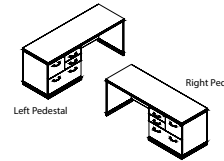

Page 27
Workstation Credenzas
Multi-File

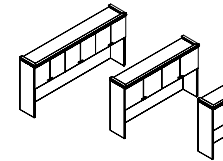

Page 28
Overhead Task
Freestanding Panel Door - 6/4/2 Door

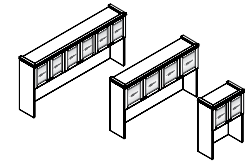

Page 29
Overhead Task
Freestanding Wood Frame Lead-
ed/Beveled Glass Doors

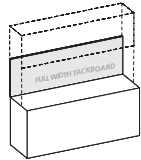

Page 30
Overhead Tackboards

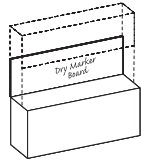

Page 31
Overhead Dry Marker Boards

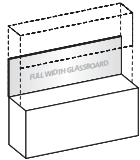

Page 32
Overhead Glassboards

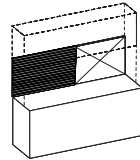

Page 33
Overhead Slat Wall

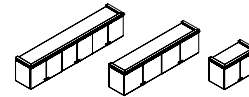

Page 34
Wall Hung Cabinets
Single Height Panel Doors - 6/4/2 Door

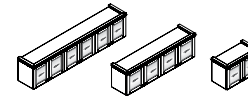

Page 35
Wall Hung Cabinets
Single Height Wood Frame Lead-
ed/Beveled Glass Doors

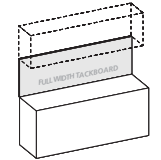

Page 36
Wall Hung Tackboards

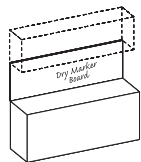

Page 37
Wall Hung Dry Marker Boards

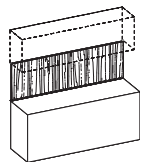

Page 38
Wall Hung Veneer Panels

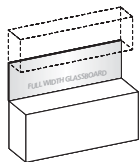

Page 39
Wall Hung Glassboards

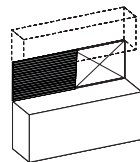

Page 40
Wall Hung Slat Wall

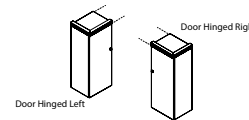

Page 41
Ganging - Overhead Tower -
Panel Doors
Wardrobe / Storage

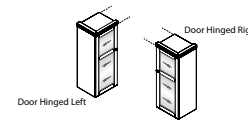

Page 42
Overhead Tower
Ganging Wardrobe / Leaded/Be-
veled Glass Doors

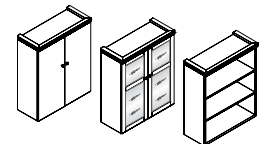

Page 43
Overhead Bookcase Hutches
Bookcase/Hutch Overhead

Statement of Line

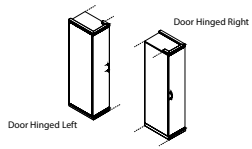

Page 44
Half Towers
Ganging Vertical Wardrobe Panel
Door

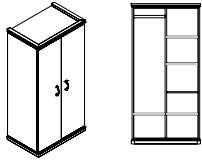

Page 45
Vertical Full Tower
Freestanding Panel Door - Ward-
robe / Storage

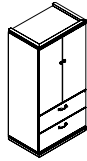

Page 46
Vertical Full Tower
Freestanding File / Wardrobe
- Panel Door

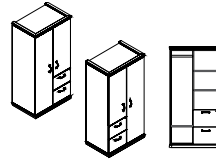

Page 47
Vertical Full Tower Wardrobe /
File / Storage
Freestanding Panel Door

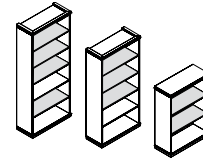

Page 48
Bookcases
Freestanding Open Bookcases

DARRAN®

Veneer

DARRAN only uses HPVA AA Grade Flat Cut Cherry and Walnut Veneers. All veneers are selected and matched for balance and consistency.

Veneer Tops

Prado veneer tops feature a 45-pound density substrate with balanced 3-ply construction. Tops are 1-1/8" thick on MDF core comprised of 100% recycled and recovered wood fibers. All veneer tops are slipmatched and feature a 3mm external solid hardwood band or profile edge.

Laminate Tops

Prado high-pressure laminate tops feature a 45-pound density substrate with balanced 3-ply construction. Tops are 1-1/8" thick on MDF core comprised of 100% recycled and recovered wood fibers. All high pressure laminate tops are available with a profile edge, laminate self-edge or 2mm PVC edge band. Laminates in wood grain patterns feature a fine grain texture that features the polish and luxe of a real wood veneer with a subtle narrow grain structure.

Cleaning wood & laminate

In addition to regular dusting, give your furniture an occasional cleaning in accordance with our cleaning instructions. DARRAN wood and laminate products can be cleaned with a soft cloth and a mild soap and water mixture. Use approximately 32 oz of water mixed with one tablespoon of dish soap, always wiping with the grain. Dry with a soft cloth, going with the grain, to avoid spotting or streaking.

Wood products should be waxed periodically using a non-wax liquid; please do not use any waxy polish or cleaner. Interior of drawers may also be cleaned with mild soap and water mixture, or any household cleaner that is not petroleum or thinner-based.

Chassis & pedestal

Chassis components are ¾" thick core of particle board or MDF rated EPP/SCS/CARB-II material with 3-ply balanced construction. Pedestal and Cabinets feature dowel construction reinforced with steel bracket plates, wood cleats, screws and glue. All units are standard with 1" adjustable glides that allow for leveling of units that are secured in solid wood glide blocks to prevent tear out.

Overhead cabinet construction Freestanding & wall mount

Freestanding Overhead storage cabinets are constructed of 1" and 3/4" thick core of particle board or MDF rated EPP/SCS/CARB-II material with 3-ply balanced construction. Panels are attached with cam fasteners in conjunction with dowels securely adhered with glue. All surface mount cabinets connect to work surface with anti-slip tape. Wall mount cabinets are mounted to the wall with steel "z" bracket attachment method using 5mm euro screws to attach to the back

Prado Features & Advantages

of the cabinet. All units ship with a steel "z" bracket. This bracket is mounted to the wall by field installers. Installers are responsible for selecting and supplying appropriate fasteners for wall conditions.

Bookcase construction

All chassis (sides, back, top and bottom panels) are constructed with 3/4" thick core of particle board or MDF rated EPP/SCS/CARB-II material with 3-ply balanced construction. Panels are attached with cam-lock fasteners in conjunction with dowels securely adhered with glue. Shelves on all units are 3/4" thick balance 3 ply panels. Optional heavy duty shelves are 1" thick lumber core balanced 5 ply construction.

Tackboards

Wall mount tackboards are constructed of .75" thick fiberboard. The fabric is precisely aligned and fitted to the tackboard with a sock on cover. Overhead storage tackboards are constructed of .75" thick fiberboard. The fabric is precisely aligned and fitted to the tackboard and adhered to the rigid hardboard with staples. Wall mount cabinets are mounted to the wall with steel "z" bracket attachment method using 5mm euro screws to attach to the back of the cabinet. All units ship with a steel "z" bracket. This bracket is mounted to the wall by field installers. Installers are responsible for selecting and supplying appropriate fasteners for wall conditions.

Adjustable glides

Glides provide 1" of vertical leveling adjustment. Glide bottom is durable metal. Glides are secured in solid wood blocks that are screwed and glued for durability.

Drawers

All drawers are constructed of four sides and a bottom, which are attached to a drawer front with screws for easy removal. Drawer fronts are vertically matched in balanced sets. Pencil trays are standard in all box drawers. Drawers are constructed of maple veneer 1/2" thick material for drawer sides, fronts and backs with a UV finish for maximum durability. Drawer bottoms are 3/16" thick 3-ply maple veneer. Drawer boxes are assembled at each corner with dowel joinery for maximum drawer strength. Lifetime free replacement warranty.

Drawer Fronts

Drawer fronts are vertically matched in balanced sets. Doors feature vertical veneer bookmatched horizontally in sets of 2 / 4 and 6 doors. All tower fronts matched in vertical sets.

Standard Wood Drawers

Optional hardwood veneer plywood drawers feature banded top and bottom edges for smoothness. Drawers are dowel joint construction with a UV cured finish over maple veneers, plus a lifetime free replacement guarantee.

Suspensions

All caseloads utilize cold rolled steel zinc plated high-grade drawer suspensions. Box and File drawers are full extension, featuring steel ball bearings for a smoother quieter range of motion

DARRAN®

with soft close operation and are rated 100lbs. Lateral file drawers are a progressive action full extension suspension with the soft close operation and is rated at 150lbs. Lateral files include anti tip mechanism that will allow only one drawer at a time to be opened. All suspensions are soft close and are warranted for the lifetime of the product.

Hinges

Units with doors include 95 degree swing hinges.

Filing

Prado features metal file frames around the perimeter of the drawers with cross bars secured to the drawer sides to support hanging files. A metal adjustable cross bar is standard with all file drawers to support letter/legal filing front to back or side to side. File drawers have one adjustable cross bar and lateral files have two adjustable cross bars. See filing reference for details.

Locks

Locks are Standard on all drawers below the worksurface. Random lock cores are installed at the factory. Some units may be shipped with the same key number. Locks are Silver, Black or Bronze and match pull finish unless otherwise specified.

DARRAN will also send lock cores separately to the dealer at your request. These units will be send with an empty lock core and the Dealer will receive a shipment of the requested lock core/keys.

Keying

Keying is available either factory or field installed. Factory installed keying is random.

Wire management

Wire management capabilities include standard and optional worksurface grommets. Specify W-1 under surface wire channels for organization and management of all communication wires and cords. Horizontal J-Channel wire management (Sku: W-1) is sold separately to conceal wire under worksurfaces.

Grommets

Metal grommets are provided to match the drawer pull selection. Grommet is available in black, silver, white or antique brass. Specify standard or non-standard location. Black plastic grommets are available as an option for vertical applications.

Powerports

A large selection of power pods are available and handle power, data, docking stations and communication. See options section for selection..

Prado Features & Advantages

LED tasklights

LED task lighting provides high efficiency, low energy lighting with a long life. Surface mounted light is encased in silver aluminum channel with milk lense and rounded end caps. Lights are field installed.

Product specifications listed below:

- Diffuser creates a softer light and eliminates hot spots
- Touch dimmer switch
- Can be “daisy chained” up to 90W
- 4.6 watts per foot
- 120 LEDs per meter
- Certification: UL Listed
- 50,000 hour life span.

Color Temp is 4000K

STANDARD VENEER	PREMIUM VENEER	HIGH PRESSURE LAMINATE	THERMALLY FUSED LAMINATE
WAC Amber Cherry.....	N/A.....	GAC Amber Cherry.....	N/A
WIC Crimson Cherry.....	N/A.....	GIC Crimson Cherry.....	N/A
WHC Honey Cherry.....	N/A.....	GHC Honey Cherry.....	N/A
WOC Koko Cherry.....	N/A.....	GOC Koko Cherry.....	N/A
WEW Executive Walnut.....	N/A.....	GEW Executive Walnut.....	N/A
WGW Gunstock Walnut.....	N/A.....	N/A.....	N/A
WBW Henna Walnut.....	N/A.....	N/A.....	N/A
WSW Smokey Walnut.....	N/A.....	N/A.....	N/A
WNW Natural Walnut.....	N/A.....	GNW Natural Walnut.....	N/A

Send 3x3 or larger finish chip for color match. Custom finish upcharge is 3% or \$250 Net (whichever is greater).



Finish

Welltech Finish delivers a superior furniture coating with exceptional performance that can withstand stringent cleaning agents and possesses unparalleled durability, allowing DARRAN to provide lasting, sustainable products to our customers.

DARRAN®

Standard profile

Prado Edge
Hardwood Rim Species Same As Surface Veneer

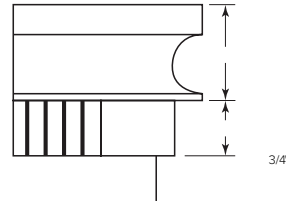

Tops:
1-1/8" thick with 3/4" thick Solid Hardwood Rim profile shaped on 4 sides of desk and 3 sides of credenzas.

Moldings:
3/4" Dentil Moldings and corners are handfitte under top edge profile. (DSM1: Delete moldings - n/c)

Solid Hardwood Base:
Bases are constructed of solid hardwood lumber 2-1/2" x 1-5/8".
1-1/2" x 1-1/2" hardwood corner block with inserted leveler. All units are standard with a 1" adjustable glide.

Cornice Top Profile

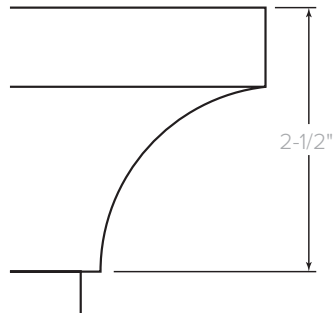

Base profile

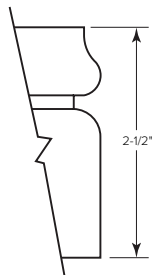

Solid Hardwood Base:
Bases are constructed of solid hardwood lumber 2-1/2" x 1-5/8".
1-1/2" x 1-1/2" hardwood corner block with inserted leveler. All units are standard with a 1" adjustable glide.

Hookup edge profile

Coped Edge

Prado Edges | Pulls | Knobs

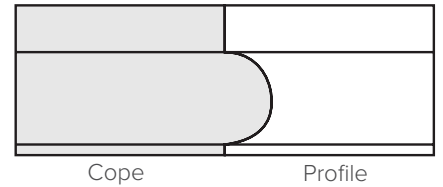

Pulls/knobs

Factory Installed

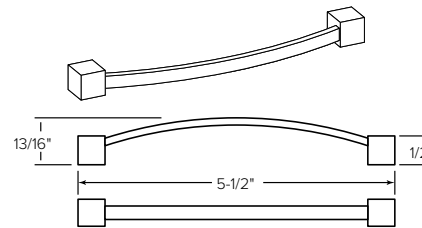

PL-125 Antique Pewter
PL-126 Antique English
PL-127 Matte Black

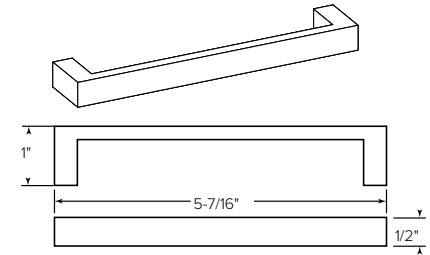

PL-115 Matte Black
PL-116 Matte Nickel

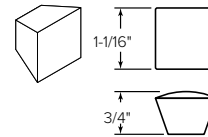

DK-125 Antique Pewter
DK-126 Antique English
DK-127 Matte Black

TM30
Black
1-5/8" Dia.

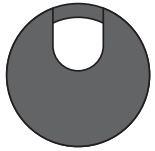

TM31
Silver
1-5/8" Dia.

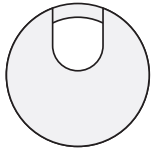

TM33
Antique Brass
1-5/8" Dia.

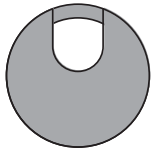

Optional grommets

Factory Installed

Grommets (Standard Location)

Specify Color and Left/Right/Center - \$50 ea.

- Black: TM30-R (Right), TM30-L (Left), TM30-C (Center)
- Silver: TM31-R (Right), TM31-L (Left), TM31-C (Center)
- Antique Brass: TM33-R (Right), TM33-L (Left), TM33-C (Center)

Grommets (Non-Standard Location)

Provide drawing w/ Grommet Location and Specify Color - \$95 ea.

- Black: TM30-NS
- Silver: TM31-NS
- Antique Brass: TM33-NS

Prado Grommets | Grommet Reference

TM50
Black
1-5/8" Dia.



Grommets (vertical surface)

Standard Location - \$50 ea.

- Black Plastic Vertical Surface: TM50-C (Bottom Center)

Non-Standard Location - \$95 ea.

- Black Plastic Vertical Surface: TM50-NS

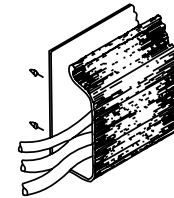

W1

Horizontal J-channel

Horizontal J-Channel wire management (Sku: W-1) is sold separately to conceal wire under worksurfaces.

Standard grommet location reference

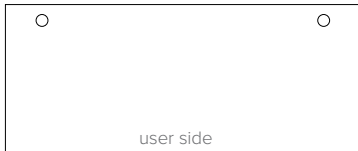

Desk
Specify Right or Left Grommet



6" Overhang Desk
Specify Right or Left Grommet

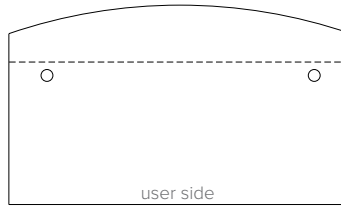

6"/12" Bow Front Desk
Specify Right or Left Grommet

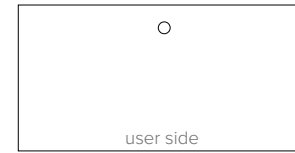

Bridge
Center Grommet

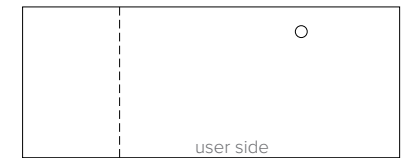

Return (Left Pedestal Shown)
Right Pedestal - Left Grommet
Left Pedestal - Right Grommet

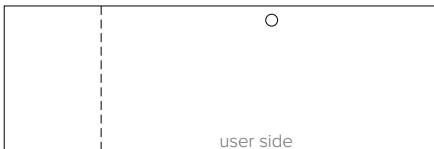

Workstation Credenza
Center Kneespace Grommet

Ganging – Flush Cut Modification

30”H Casework Worksurface & Base Ganging Modifications

To gang two casework units, each unit end to be ganged must be flush cut modified for gapless surfaces and cabinet chassis.

Order Option:

- FC-B: Flush Unit Both Sides(Facing) for Ganging - \$100
- FC-L: Flush Unit Left (Facing) for Ganging - \$100
- FC-R: Flush Unit Right (Facing) for Ganging - \$100

Flush cut modification per unit includes all modifications to gang to one end or both ends when units are ganged. Modification includes tops, base and molding.

Modification reduces width size approximately 1” per end.

Overhead consoles and towers are offered freestanding and ganging – inclusive of flush cut modifications.

Example:

PRA3024CA104W Two Drawer Lateral File (Left) Flush Cut Right – FC-R...\$100

PRA7124CA054W Kneespace Credenza (Right) Flush Cut Left – FC-L...\$100

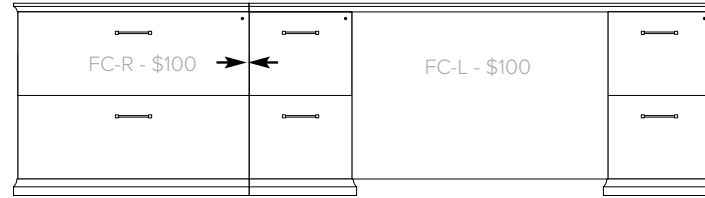

Height reference

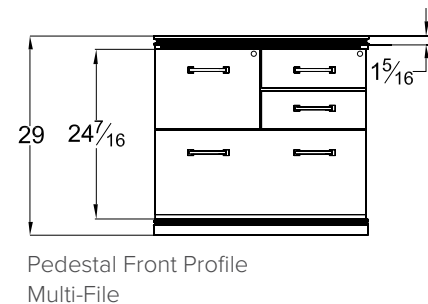
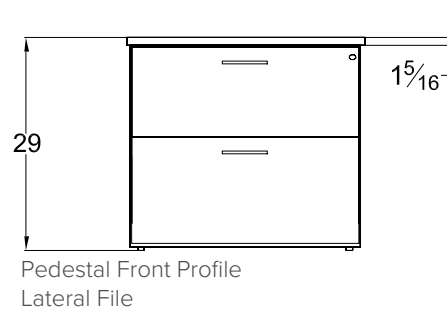
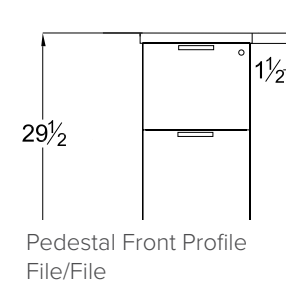
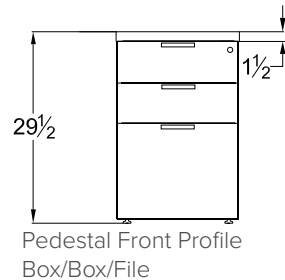
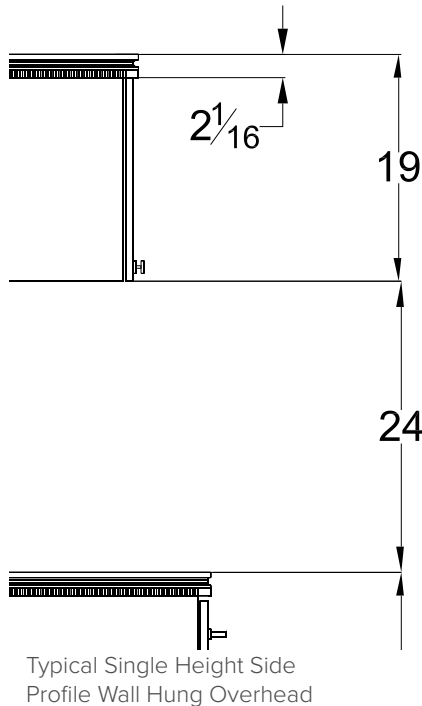

Modesty reference

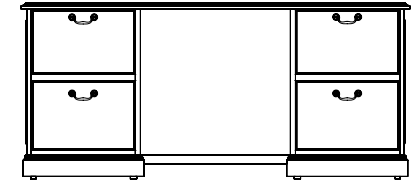
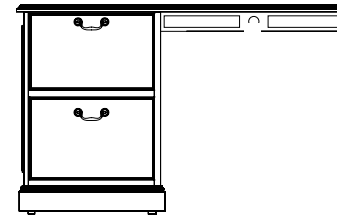
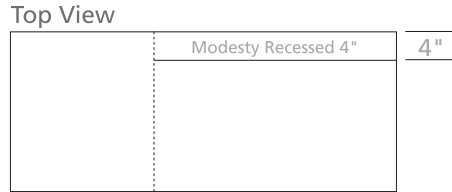
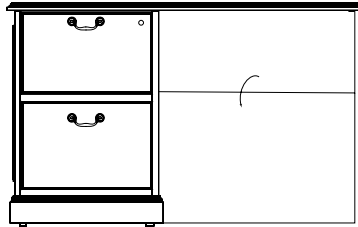

M34
Drop Door Tech Modesty

M51
Open Back Modesty with 4" Wire Management Rail

M37
Fixed Full Modesty

Overhead door

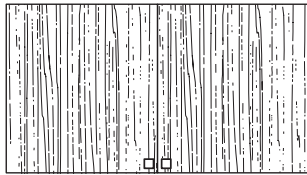

Panel Door

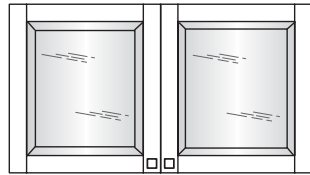

Beveled Glass Door

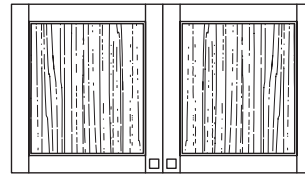

Solid Hardwood Frame Door w/ Veneer Insert - Only Available on "W" Styles

Grain direction

Veneer chassis parts are vertical grain. Doors feature vertical veneer bookmatched horizontally in sets of 2,4, and 6 doors. Tower fronts are matched in vertical sets.



Desk

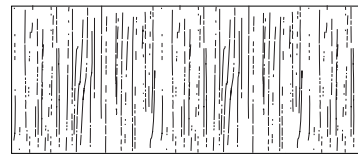

Runoff Desk
Grain Direction on TFL Units Above 66" runs end to end

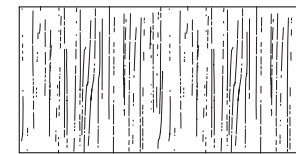

Bridge
Grain Direction on TFL Units Above 66" runs end to end

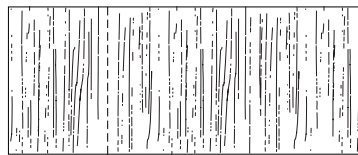

Return
Grain Direction on TFL Units Above 66" runs end to end



Credenza

Interior drawer dimensions

UNIT DEPTH	DRAWER TYPE	OVERALL DIMENSIONS			INTERIOR DRAWER DIMENSIONS			NOTES
		W	D	H	W	D	H	
15-5/8" Letter	30" Box	13-1/8	19-11/16	4	12-1/8	18-11/16	3-7/16	Units less than 72"
	30" File	13-1/8	19-11/16	9-13/16	12-1/8	18-11/16	9-5/16	Units less than 72"
	24" Box	13-1/8	16-1/16	4	12-1/8	15-1/16	3-7/16	Units less than 72"
	24" File	13-1/8	16-1/16	9-13/16	12-1/8	15-1/16	9-5/16	Units less than 72"
18-9/16" Legal	36" Box	16-1/6	19-11/16	4	12-1/8	18-11/16	3-7/16	Units 72" & above
	36" File	16-1/6	19-11/16	9-13/16	12-1/8	18-11/16	9-5/16	Units 72" & above
	30" Box	16-1/6	19-11/16	4	12-1/8	18-11/16	3-7/16	Units 72" & above
	30" File	16-1/6	19-11/16	9-13/16	12-1/8	18-11/16	9-5/16	Units 72" & above
	24" Box	16-1/6	16-1/16	4	12-1/8	15-1/16	3-7/16	Units less than 72"
	24" File	16-1/6	16-1/16	9-13/16	12-1/8	15-1/16	9-5/16	Units less than 72"
29" Lateral	24" File	26-1/2	16-1/16	9-13/16	25-1/2	15-1/16	9-5/16	Workstation Credenzas less than 82"
31" Lateral	24" File	28-9/16	16-1/16	9-13/16	27-9/16	15-1/16	9-5/16	Multi-File Lateral File
35" Lateral	24" File	32-1/2	16-1/16	9-13/16	31-1/2	15-1/16	9-5/16	Workstation Credenzas over 83"

Filing reference

Filing for 24" depth units

13 1/8" Wide File Drawer - 16 1/16" Deep

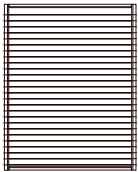

Letter Front to Back

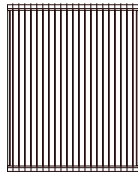

Legal Side to Side with File Rail

29" Lateral file drawer

26-1/2" Wide File Drawer - 16-1/16" Deep

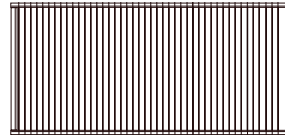

Legal Side to Side

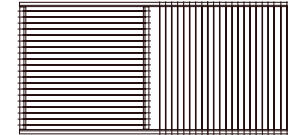

Legal Side to Side
Letter Front to Back with File Rail

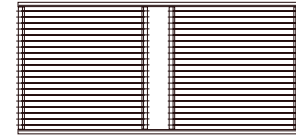

Letter Front to Back with File Rail

Filing for 30" & 36" depth units

13 1/8" Wide File Drawer - 19 11/16" Deep

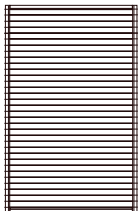

Letter Front to Back

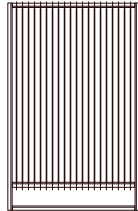

Legal Side to Side with File Rail

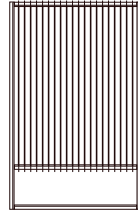

Letter Side to Side with File Rail

35" Lateral file drawer

32-1/2" Wide File Drawer - 16-1/16" Deep

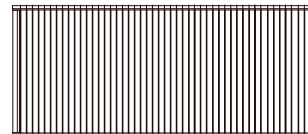

Legal Side to Side

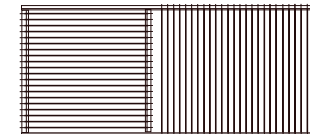

Legal Side to Side
Letter Front to Back with File Rail

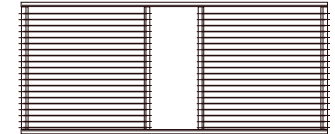

Letter Front to Back with File Rail

Prado

Desk
Breakfront - Double Pedestal

[Click here to view statement of line](#)

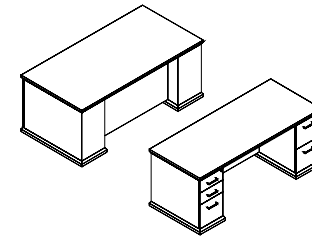

1 Select Model

w" x d" x h"

Legal Width Double Letter Filing	Weight
84 x 36 x 29	395
72 x 36 x 29	375
Letter Width Legal / Letter Filing	Weight
72 x 30 x 29	350
66 x 30 x 29	320

Standard Veneer Top Standard Veneer Chassis	Premium Veneer Top Premium Veneer Chassis	High Pressure Laminate Top Veneer Chassis	Thermally Fused Laminate Top Thermally Fused Laminate Chassis
PRA8436DD000W 6937	"P" Option N/A	PRA8436DD000G 6937	"M" Option N/A
PRA7236DD000W 6288	"P" Option N/A	PRA7236DD000G 6288	"M" Option N/A
PRA7230DD000W 6128	"P" Option N/A	PRA7230DD000G 6128	"M" Option N/A
PRA6630DD000W 5962	"P" Option N/A	PRA6630DD000G 5962	"M" Option N/A

Product Features

- Adjustable glides
- Full extension drawers - locking
- Soft close suspension drawer(s)
- Solid hardwood base/dentil molding

Notes

- Glides adjust 1"

Options

Accessories

- K1: Center Drawer - \$290
- K4: Box Drawer Black Dura-Leather Bottom - \$495
- K28: Articulating keyboard w/ mouse pad (Installed) - \$390
- P1-A: Pullout writing shelf - \$205
- PC10A: desk Pedestal Wire Cavity - \$100

Drawer

- P6: Modify File/File to Box/Box/File - \$55

Grommets (Standard Location)

- Specify Color and Location Right/Left - \$50 ea.
- Black: TM30-R (Right), TM30-L (Left)
 - Silver: TM31-R (Right), TM31-L (Left)
 - Antique Brass: TM33-R (Right), TM33-L (Left)

Grommets (Non-Standard Location)

Provide drawing w/ Grommet Location and Specify Color - \$95 ea.

- Black: TM30-NS
- Silver: TM31-NS
- Antique Brass: TM33-NS

Molding

- DSM1: Delete Dentil Molding Only - n/c

2 Select Finish

[Click to view finishes](#)

- WAC
- WIC
- WHC
- WOC
- WEW
- WGW
- WBW
- WSW
- WNW

- GAC
- GIC
- GHC
- GOC
- GEW
- GNW

3 Select Edge

[Click to view edges](#)



Prado



Prado

4 Select Hardware

[Click to view details](#)



PL-115 Matte Black
PL-116 Matte Nickel

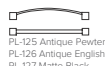

PL-125 Antique Pewter
PL-126 Antique English
PL-127 Matte Black



PL-115 Matte Black
PL-116 Matte Nickel



PL-125 Antique Pewter
PL-126 Antique English
PL-127 Matte Black

Prado

Desk
Bowfront / Breakfront Double Pedestal

[Click here to view statement of line](#)

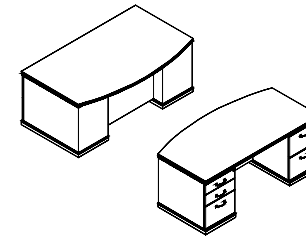

1 Select Model

w" x d" x h"

Legal Width Double Letter Filing
84 x 36/42 x 29 420
72 x 36/42 x 29 390
Letter Width Legal / Letter Filing
72 x 30/36 x 29 345

Weight

Standard Veneer Top Standard Veneer Chassis	Premium Veneer Top Premium Veneer Chassis	High Pressure Laminate Top Veneer Chassis	Thermally Fused Laminate Top Thermally Fused Laminate Chassis
PRA8442DD006W 7912	"P" Option N/A	PRA8442DD006G 7912	"M" Option N/A
PRA7242DD006W 7264	"P" Option N/A	PRA7242DD006G 7264	"M" Option N/A
PRA7236DD006W 7100	"P" Option N/A	PRA7236DD006G 7100	"M" Option N/A

2 Select Finish

Click to view finishes

WAC
WIC
WHC
WOC
WEW
WGW
WBW
WSW
WNW

GAC
GIC
GHC
GOC
GEW
GNW

3 Select Edge

Click to view edges



4 Select Hardware

Click to view details

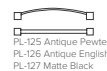
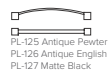

Product Features

- Adjustable glides
- Full extension drawers - locking
- Soft close suspension drawer(s)
- Solid hardwood base/dentil molding

Notes

- Glides adjust 1"

Options

Accessories

- K1: Center Drawer - \$290
- K28: Articulating keyboard w/ mouse pad (installed) - \$390
- P1-A: Pullout writing shelf - \$205
- PC10A: desk Pedestal Wire Cavity - \$100

Drawer

- P6: Modify File/File to Box/Box/File - \$55

Grommets (Standard Location)

Specify Color and Location Right/Left - \$50 ea.

- Black: TM30-R (Right), TM30-L (Left)
- Silver: TM31-R (Right), TM31-L (Left)
- Antique Brass: TM33-R (Right), TM33-L (Left)

Grommets (Non-Standard Location)

Provide drawing w/ Grommet Location and Specify Color - \$95 ea.

- Black: TM30-NS
- Silver: TM31-NS
- Antique Brass: TM33-NS

Molding

- DSM1: Delete Dentil Molding Only - n/c

Prado

Table Desks
Fluted Leg Table Desk

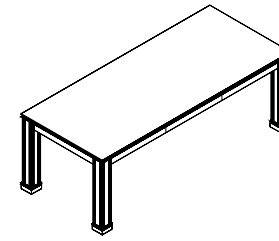

[Click here to view statement of line](#)

1 Select Model

w" x d" x h"
84 x 36 x 29
72 x 36 x 29

Weight
250
235

Standard Veneer Top Standard Veneer Chassis		Premium Veneer Top Premium Veneer Chassis		High Pressure Laminate Top Veneer Chassis		Thermally Fused Laminate Top Thermally Fused Laminate Chassis	
--	--	--	--	--	--	--	--

PRA8436DT107W	6937	"P" Option N/A		PRA8436DT107G	6937	"M" Option N/A	
PRA7236DT107W	6288	"P" Option N/A		PRA7236DT107G	6288	"M" Option N/A	

Product Features

- Adjustable glides
- Dentil molding
- Full extension drawers - locking
- Post leg 4" x 4" w/ flute detailing
- Solid hardwood base/dentil molding
- Utility center drawer w/ black Dura-Leather bottom

Notes

- Glides adjust 1"

Options

Grommets (Standard Location)

Specify Color and Location Right/Left - \$50 ea.

- Black: TM30-R (Right), TM30-L (Left)
- Silver: TM31-R (Right), TM31-L (Left)
- Antique Brass: TM33-R (Right), TM33-L (Left)

Grommets (Non-Standard Location)

Provide drawing w/ Grommet Location and Specify Color - \$95 ea.

- Black: TM30-NS
- Silver: TM31-NS
- Antique Brass: TM33-NS

2 Select Finish

[Click to view finishes](#)

WAC
WIC
WHC
WOC
WEW
WGW
WBW
WSW
WNW

GAC
GIC
GHC
GOC
GEW
GNW

3 Select Edge

[Click to view edges](#)



Prado



Prado

4 Select Hardware

[Click to view details](#)



PL-115 Matte Black
PL-116 Matte Nickel

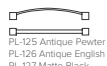

PL-125 Antique Pewter
PL-126 Antique English
PL-127 Matte Black



PL-115 Matte Black
PL-116 Matte Nickel

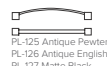

PL-125 Antique Pewter
PL-126 Antique English
PL-127 Matte Black

Prado

Workstation Desks
Breakfront - Single Pedestal

[Click here to view statement of line](#)

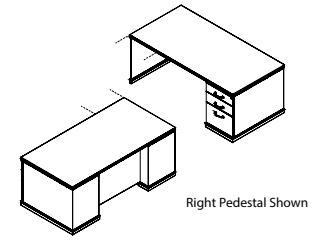

1 Select Model

w" x d" x h"

Weight

	Standard Veneer Top Standard Veneer Chassis	Premium Veneer Top Premium Veneer Chassis	High Pressure Laminate Top Veneer Chassis	Thermally Fused Laminate Top
Legal/dbl Letter Filing (Right Pedestal)				
72 x 36 x 29	300 PRA7236DS010W 5299	"P" Option N/A	PRA7236DS010G 5299	"M" Option N/A
Legal/dbl Letter Filing (Left Pedestal)				
72 x 36 x 29	300 PRA7236DS009W 5299	"P" Option N/A	PRA7236DS009G 5299	"M" Option N/A
legal/letter filing (Right Pedestal)				
72 x 30 x 29	275 PRA7230DS010W 5138	"P" Option N/A	PRA7230DS010G 5138	"M" Option N/A
66 x 30 x 29	250 PRA6630DS010W 4975	"P" Option N/A	PRA6630DS010G 4975	"M" Option N/A
legal/letter filing (Left Pedestal)				
72 x 30 x 29	275 PRA7230DS009W 5138	"P" Option N/A	PRA7230DS009G 5138	"M" Option N/A
66 x 30 x 29	250 PRA6630DS009W 4975	"P" Option N/A	PRA6630DS009G 4975	"M" Option N/A

Product Features

- Adjustable glides
- Breakfront modesty
- Full extension drawers - locking
- Hookup hardware
- Soft close suspension drawer(s)
- Solid hardwood base/dentil molding

Notes

- Glides adjust 1"

Options

Accessories

- K1: Center Drawer - \$290
- K28: Articulating keyboard w/ mouse pad (installed) - \$390
- P1-A: Pullout writing shelf - \$205
- PC10A: desk Pedestal Wire Cavity - \$100

Drawer

- P6: Modify Box/Box/File to File/File - \$55

Grommets (Standard Location)

Specify Color and Location Right/Left - \$50 ea.

- Black: TM30-R (Right), TM30-L (Left)
- Silver: TM31-R (Right), TM31-L (Left)
- Antique Brass: TM33-R (Right), TM33-L (Left)

Grommets (Non-Standard Location)

Provide drawing w/ Grommet Location and Specify Color - \$95 ea.

- Black: TM30-NS
- Silver: TM31-NS
- Antique Brass: TM33-NS

Molding

- DSM1: Delete Dentil Molding Only - n/c

2 Select Finish

[Click to view finishes](#)

- WAC
- WIC
- WHC
- WOC
- WEW
- WGW
- WBW
- WSW
- WNW

- GAC
- GIC
- GHC
- GOC
- GEW
- GNW

3 Select Edge

[Click to view edges](#)



Prado



Prado

4 Select Hardware

[Click to view details](#)



PL-115 Matte Black
PL-116 Matte Nickel

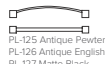

PL-125 Antique Pewter
PL-126 Antique English
PL-127 Matte Black



PL-115 Matte Black
PL-116 Matte Nickel



PL-125 Antique Pewter
PL-126 Antique English
PL-127 Matte Black

Prado

Workstation Desks
Bowfront / Breakfront Single Pedestal

[Click here to view statement of line](#)

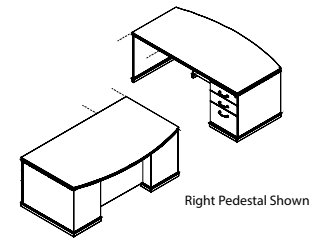

1 Select Model

w" x d" x h"

Weight

		Standard Veneer Top Standard Veneer Chassis	Premium Veneer Top Premium Veneer Chassis	High Pressure Laminate Top Veneer Chassis	Thermally Fused Laminate Top Thermally Fused Laminate Chassis
Legal/dbl Letter Filing (Right Pedestal)					
72 x 36/42 x 29	320	PRA7242DS018W 6110	"P" Option N/A	PRA7242DS018G 6110	"M" Option N/A
Legal/dbl Letter Filing (Left Pedestal)					
72 x 36/42 x 29	320	PRA7242DS017W 6110	"P" Option N/A	PRA7242DS017G 6110	"M" Option N/A
legal/letter filing (Right Pedestal)					
72 x 30/36 x 29	295	PRA7236DS018W 5950	"P" Option N/A	PRA7236DS018G 5950	"M" Option N/A
legal/letter filing (Left Pedestal)					
72 x 30/36 x 29	295	PRA7236DS017W 5950	"P" Option N/A	PRA7236DS017G 5950	"M" Option N/A

Product Features

- Adjustable glides
- Breakfront modesty
- Full extension drawers - locking
- Hookup hardware
- Soft close suspension drawer(s)
- Solid hardwood base/dentil molding

Notes

- Glides adjust 1"

Options

Accessories

- K1: Center Drawer - \$290
- K28: Articulating keyboard w/ mouse pad (installed) - \$390
- P1-A: Pullout writing shelf - \$205
- PC10A: desk Pedestal Wire Cavity - \$100

Drawer

- P6: Modify Box/Box/File to File/File - \$55

Grommets (Standard Location)

Specify Color and Location Right/Left - \$50 ea.

- Black: TM30-R (Right), TM30-L (Left)
- Silver: TM31-R (Right), TM31-L (Left)
- Antique Brass: TM33-R (Right), TM33-L (Left)

Grommets (Non-Standard Location)

Provide drawing w/ Grommet Location and Specify Color - \$95 ea.

- Black: TM30-NS
- Silver: TM31-NS
- Antique Brass: TM33-NS

Molding

- DSM1: Delete Dentil Molding Only - n/c

2 Select Finish

[Click to view finishes](#)

- WAC
- WIC
- WHC
- WOC
- WEW
- WGW
- WBW
- WSW
- WNW

- GAC
- GIC
- GHC
- GOC
- GEW
- GNW

3 Select Edge

[Click to view edges](#)



Prado



Prado

4 Select Hardware

[Click to view details](#)



PL-115 Matte Black
PL-116 Matte Nickel

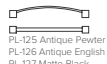

PL-125 Antique Pewter
PL-126 Antique English
PL-127 Matte Black



PL-115 Matte Black
PL-116 Matte Nickel



PL-125 Antique Pewter
PL-126 Antique English
PL-127 Matte Black

Prado

Workstation "L" Returns
File / File

[Click here to view statement of line](#)

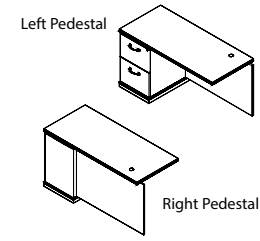

1 Select Model

w" x d" x h"	Weight
Left Pedestal	
60 x 24 x 29	165
54 x 24 x 29	155
48 x 24 x 29	145
42 x 24 x 29	135
Right Pedestal	
60 x 24 x 29	165
54 x 24 x 29	155
48 x 24 x 29	145
42 x 24 x 29	135

	Standard Veneer Top Standard Veneer Chassis	Premium Veneer Top Premium Veneer Chassis	High Pressure Laminate Top Veneer Chassis	Thermally Fused Laminate Top Thermally Fused Laminate Chassis
	PRA6024RE195W 3855	"P" Option N/A	PRA6024RE195G 3855	"M" Option N/A
	PRA5424RE195W 3772	"P" Option N/A	PRA5424RE195G 3772	"M" Option N/A
	PRA4824RE195W 3691	"P" Option N/A	PRA4824RE195G 3691	"M" Option N/A
	PRA4224RE195W 3609	"P" Option N/A	PRA4224RE195G 3609	"M" Option N/A
	PRA6024RE196W 3855	"P" Option N/A	PRA6024RE196G 3855	"M" Option N/A
	PRA5424RE196W 3772	"P" Option N/A	PRA5424RE196G 3772	"M" Option N/A
	PRA4824RE196W 3691	"P" Option N/A	PRA4824RE196G 3691	"M" Option N/A
	PRA4224RE196W 3609	"P" Option N/A	PRA4224RE196G 3609	"M" Option N/A

Product Features

- 1 Standard grommet - matches pull finish or specify black TM30, silver TM31 or antique brass TM33
- Finished back - open plan
- Full extension drawers - locking
- Full fixed modesty
- Soft close suspension drawer(s)
- Solid hardwood base/dentil molding

Notes

- Return Top Grain Direction Same As Desk 42" -60"W

Options

Accessories

- K1: Center Drawer - \$290
- K28: Articulating keyboard w/ mouse pad (Installed) - \$390

Drawer

- P6: Modify File/File to Box/Box/File - \$55 per pedestal
- P40B: extra Box/Box/File or File/File to Kneespace - \$1025

Flush Cut

- FC-R: Flush Unit Right(Facing) for Ganging - \$100
- FC-L: Flush Unit Left (Facing) for Ganging - \$100

Grommets (Non-Standard Location)

- Provide drawing w/ Grommet Location and Specify Color - \$95 ea.
- Black: TM30-NS
- Silver: TM31-NS
- Antique Brass: TM33-NS

Modesty

- M34T: Drop Door Tech Modesty - \$130
- M5t: Open Back Modesty with Wire Mgmt Rail - Deduct \$95

Molding

- DSM1: Delete Dentil Molding Only - n/c

2 Select Finish

[Click to view finishes](#)

- WAC
- WIC
- WHC
- WOC
- WEW
- WGW
- WBW
- WSW
- WNW

- GAC
- GIC
- GHC
- GOC
- GEW
- GNW

3 Select Edge

[Click to view edges](#)



Prado



Prado

4 Select Hardware

[Click to view details](#)



PL-115 Matte Black
PL-116 Matte Nickel

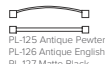

PL-125 Antique Pewter
PL-126 Antique English
PL-127 Matte Black



PL-115 Matte Black
PL-116 Matte Nickel



PL-125 Antique Pewter
PL-126 Antique English
PL-127 Matte Black

Prado

Workstation "L" Returns Lateral File

[Click here to view statement of line](#)

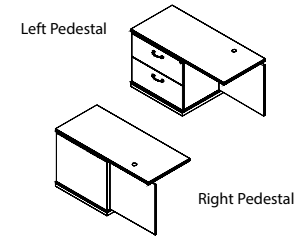

1 Select Model

w" x d" x h"

Weight	Standard Veneer Top Standard Veneer Chassis	Premium Veneer Top Premium Veneer Chassis	High Pressure Laminate Top Veneer Chassis	Thermally Fused Laminate Top Thermally Fused Laminate Chassis
Left Pedestal				
60 x 24 x 29	PRA6024RE187W 4340	"P" Option N/A	PRA6024RE187G 4340	"M" Option N/A
54 x 24 x 29	PRA5424RE187W 4096	"P" Option N/A	PRA5424RE187G 4096	"M" Option N/A
48 x 24 x 29	PRA4824RE187W 4016	"P" Option N/A	PRA4824RE187G 4016	"M" Option N/A
Right Pedestal				
60 x 24 x 29	PRA6024RE188W 4340	"P" Option N/A	PRA6024RE188G 4340	"M" Option N/A
54 x 24 x 29	PRA5424RE188W 4096	"P" Option N/A	PRA5424RE188G 4096	"M" Option N/A
48 x 24 x 29	PRA4824RE188W 4016	"P" Option N/A	PRA4824RE188G 4016	"M" Option N/A

2 Select Finish

[Click to view finishes](#)

- WAC
- WIC
- WHC
- WOC
- WEW
- WGW
- WBW
- WSW
- WNW

- GAC
- GIC
- GHC
- GOC
- GEW
- GNW

3 Select Edge

[Click to view edges](#)



Prado



Prado

4 Select Hardware

[Click to view details](#)



PL-115 Matte Black
PL-116 Matte Nickel

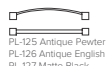

PL-125 Antique Pewter
PL-126 Antique English
PL-127 Matte Black



PL-115 Matte Black
PL-116 Matte Nickel



PL-125 Antique Pewter
PL-126 Antique English
PL-127 Matte Black

Product Features

- 1 Standard grommet - matches pull finish or specify black TM30, silver TM31 or antique brass TM33
- Finished back - open plan
- Full fixed modesty
- Features ball bearing suspensions, suspensions are full extension
- Solid hardwood base/dentil molding

Notes

- Keyboards N/A on 48" Lateral File Returns
- Return Top Grain Direction Same As Desk 42" -60" W

Options

Accessories

- K1: Center Drawer - \$290
- K28: Articulating keyboard w/ mouse pad (Installed) - \$390 (n/a on 48" W units)

Drawer

- P40B: extra Box/Box/File or File/File to Kneespace (n/a on 48") - \$1,025

Flush Cut

- FC-R: Flush Unit Right(Facing) for Ganging - \$100
- FC-L: Flush Unit Left (Facing) for Ganging - \$100

Grommets (Non-Standard Location)

Provide drawing w/ Grommet Location and Specify Color - \$95 ea.

- Black: TM30-NS
- Silver: TM31-NS
- Antique Brass: TM33-NS

Modesty

- M34T: Drop Door Tech Modesty - \$130
- M51: Open Back Modesty with Wire Mgmt Rail - Deduct \$95

Molding

- DSM1: Delete Dentil Molding Only - n/c

Prado

Workstation "L" Returns
Multi-File

[Click here to view statement of line](#)

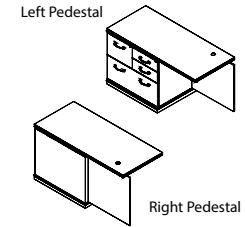

1 Select Model

w" x d" x h"

	Weight	Standard Veneer Top Standard Veneer Chassis	Premium Veneer Top Premium Veneer Chassis	High Pressure Laminate Top Veneer Chassis	Thermally Fused Laminate Top Thermally Fused Laminate Chassis
Left Pedestal					
60 x 24 x 29	200	PRA6024RE218W 4667	"P" Option N/A	PRA6024RE218G 4667	"M" Option N/A
54 x 24 x 29	185	PRA5424RE218W 4420	"P" Option N/A	PRA5424RE218G 4420	"M" Option N/A
48 x 24 x 29	175	PRA4824RE218W 4340	"P" Option N/A	PRA4824RE218G 4340	"M" Option N/A
Right Pedestal					
60 x 24 x 29	200	PRA6024RE219W 4667	"P" Option N/A	PRA6024RE219G 4667	"M" Option N/A
54 x 24 x 29	185	PRA5424RE219W 4420	"P" Option N/A	PRA5424RE219G 4420	"M" Option N/A
48 x 24 x 29	175	PRA4824RE219W 4340	"P" Option N/A	PRA4824RE219G 4340	"M" Option N/A

2 Select Finish

[Click to view finishes](#)

- WAC
- WIC
- WHC
- WOC
- WEW
- WGW
- WBW
- WSW
- WNW

- GAC
- GIC
- GHC
- GOC
- GEW
- GNW

3 Select Edge

[Click to view edges](#)



Prado



Prado

4 Select Hardware

[Click to view details](#)



PL-115 Matte Black
PL-116 Matte Nickel

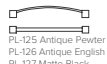

PL-125 Antique Pewter
PL-126 Antique English
PL-127 Matte Black



PL-115 Matte Black
PL-116 Matte Nickel



PL-125 Antique Pewter
PL-126 Antique English
PL-127 Matte Black

Product Features

- 1 Standard grommet - matches pull finish or specify black TM30, silver TM31 or antique brass TM33
- Full fixed modesty
- Multi-File is 31"W
- "W" & "G" Box and File Drawers feature soft close suspensions (Lateral Drawers feature ball bearing suspensions)
- Solid hardwood base/dentil molding

Notes

- Return Top Grain Direction Same As Desk 42" -60"W

Options

Accessories

- K1: Center Drawer - \$290
- K28: Articulating keyboard w/ mouse pad (Installed) - \$390 (n/a on 48" W units)

Drawer

- P40B: extra Box/Box/File or File/File to Kneespace (n/a on 48") - \$1,025

Flush Cut

- FC-R: Flush Unit Right(Facing) for Ganging - \$100
- FC-L: Flush Unit Left (Facing) for Ganging - \$100

Grommets (Non-Standard Location)

Provide drawing w/ Grommet Location and Specify Color - \$95 ea.

- Black: TM30-NS
- Silver: TM31-NS
- Antique Brass: TM33-NS

Modesty

- M34T: Drop Door Tech Modesty - \$130
- M5t: Open Back Modesty with Wire Mgmt Rail - Deduct \$95

Molding

- DSM1: Delete Dentil Molding Only - n/c

Prado

Workstation Bridges
 Bridge - Fixed Back

[Click here to view statement of line](#)

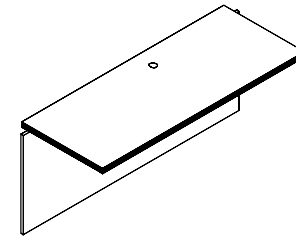

1 Select Model

w" x d" x h"	Weight
48 x 24 x 29	85
42 x 24 x 29	80
36 x 24 x 29	70

Standard Veneer Top Standard Veneer Chassis		Premium Veneer Top Premium Veneer Chassis		High Pressure Laminate Top Veneer Chassis		Thermally Fused Laminate Top Thermally Fused Laminate Chassis	
PRA4824BR150W	1742	"P" Option N/A		PRA4824BR150G	1742	"M" Option N/A	
PRA4224BR150W	1661	"P" Option N/A		PRA4224BR150G	1661	"M" Option N/A	
PRA3624BR150W	1626	"P" Option N/A		PRA3624BR150G	1626	"M" Option N/A	

2 Select Finish

[Click to view finishes](#)

- WAC
- WIC
- WHC
- WOC
- WEW
- WGW
- WBW
- WSW
- WNW

- GAC
- GIC
- GHC
- GOC
- GEW
- GNW

3 Select Edge

[Click to view edges](#)



Prado



Prado

4 Select Hardware

[Click to view details](#)

Hardware
N/A

Hardware
N/A

Product Features

- 1 Standard grommet - matches pull finish or specify black TM30, silver TM31 or antique brass TM33

Notes

- Bridge grain direction same as Desk / Credenza

Options

Accessories

- K28: Articulating keyboard w/ mouse pad (Installed) - \$390

Bridge

- M5t: Open back wall access bridge option - Deduct \$95

- M34T: Drop Door Tech Modesty - \$130

Grommets (Non-Standard Location)

Provide drawing w/ Grommet Location and Specify Color - \$95 ea.

- Black: TM30-NS

- Silver: TM31-NS

- Antique Brass: TM33-NS

Molding

- DSM1: Delete Dentil Molding Only - n/c

Prado

Credenzas
File / Storage

[Click here to view statement of line](#)

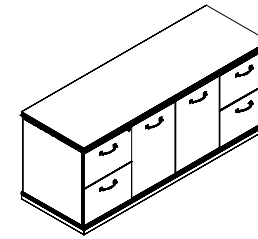

1 Select Model

w" x d" x h"	Weight
71 x 24 x 29	300
65 x 24 x 29	290

Standard Veneer Top Standard Veneer Chassis		Premium Veneer Top Premium Veneer Chassis		High Pressure Laminate Top Veneer Chassis		Thermally Fused Laminate Top Thermally Fused Laminate Chassis	
--	--	--	--	--	--	--	--

PRA7124CA050W	5950	"P" Option N/A		PRA7124CA050G	5950	"M" Option N/A	
PRA6524CA050W	5786	"P" Option N/A		PRA6524CA050G	5786	"M" Option N/A	

Product Features

- 1 Adjustable veneer shelf behind door set
- Adjustable glides
- Full extension drawers - locking
- Legal/Letter filing
- Soft close suspension drawer(s)
- Solid hardwood base/dentil molding

Notes

- Glides adjust 1"
- Unit has black back panel and is not designed for Open Plan use. Select OPB Option for Open Plan application

Options

Door

- D2: Door Lock - \$100 per door set
- D6: Delete Doors - n/c
- D9SC: Soft Close Door Hinges - \$20 per door

Flush Cut

- FC-B: Flush Unit Both Sides(Facing) for Ganging - \$100
- FC-R: Flush Unit Right(Facing) for Ganging - \$100
- FC-L: Flush Unit Left (Facing) for Ganging - \$100

Grommets (Vertical Surface)

- Standard Location - \$50 ea.
- Black Plastic Vertical Surface: TM50-C (Bottom Center)
- Non-Standard Location: Provide drawing w/ Grommet Location and Specify Color - \$95
- Black Plastic Vertical Surface: TM50-NS

Molding

- DSM1: Delete Dentil Molding Only - n/c

Open Plan _ Finished Back

- OPB: W "G" Style - Modify Unit for Open Plan Application - \$295

2 Select Finish

[Click to view finishes](#)

- WAC
- WIC
- WHC
- WOC
- WEW
- WGW
- WBW
- WSW
- WNW

- GAC
- GIC
- GHC
- GOC
- GEW
- GNW

3 Select Edge

[Click to view edges](#)



4 Select Hardware

[Click to view details](#)

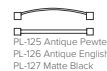
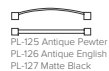

Prado

Credenzas
Kneespace

[Click here to view statement of line](#)

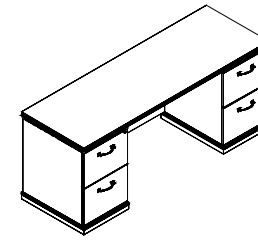









1 Select Model

w" x d" x h"
71 x 24 x 29
65 x 24 x 29

Weight

260
250

Standard Veneer Top Standard Veneer Chassis	Premium Veneer Top Premium Veneer Chassis	High Pressure Laminate Top Veneer Chassis	Thermally Fused Laminate Top Thermally Fused Laminate Chassis
PRA7124CA054W 5138 PRA6524CA054W 4975	"P" Option N/A "P" Option N/A	PRA7124CA054G 5138 PRA6524CA054G 4975	"M" Option N/A "M" Option N/A
WAC WIC WHC WOC WEW WGW WBW WSW WNW	GAC GIC GHC GOC GEW GNW	 Prado	 Prado
  PL-115 Matte Black PL-116 Matte Nickel		  PL-115 Matte Black PL-116 Matte Nickel	   PL-125 Antique Pewter PL-126 Antique English PL-127 Matte Black

2 Select Finish

[Click to view finishes](#)

3 Select Edge

[Click to view edges](#)



4 Select Hardware

[Click to view details](#)



Product Features

- Adjustable glides
- Full extension drawers - locking
- Kneespace w/ fixed full modesty
- Legal/Letter filing
- Soft close suspension drawer(s)
- Solid hardwood base/dentil molding

Notes

- Glides adjust 1"
- Unit has black back panel and is not designed for Open Plan use. Select OPB Option for Open Plan application

Options

Accessories

- K1: Center Drawer - \$290
- K28: Articulating keyboard w/ mouse pad (Installed) - \$390

Drawer

- P6: Modify File/File to Box/Box/File - \$55 per pedestal

Flush Cut

- FC-B: Flush Unit Both Sides(Facing) for Ganging - \$100
- FC-R: Flush Unit Right(Facing) for Ganging - \$100
- FC-L: Flush Unit Left (Facing) for Ganging - \$100

Grommets (Standard Location)

- Specify Color - \$50 ea.
- Black: TM30-C (Center)
 - Silver: TM31-C (Center)
 - Antique Brass: TM33-C (Center)

Grommets (Non-Standard Location)

Provide drawing w/ Grommet Location and Specify Color - \$95 ea.

- Black: TM30-NS
- Silver: TM31-NS
- Antique Brass: TM33-NS

Modesty

- M34T: Drop Door Tech Modesty - \$130
- M51: Open Back Modesty with Wire Mgmt Rail - Deduct \$95

Molding

- DSM1: Delete Dentil Molding Only - n/c

Open Plan _ Finished Back

- OPB: W "G" Style - Modify Unit for Open Plan Application - \$295

Prado

Credenzas
Storage Units

[Click here to view statement of line](#)

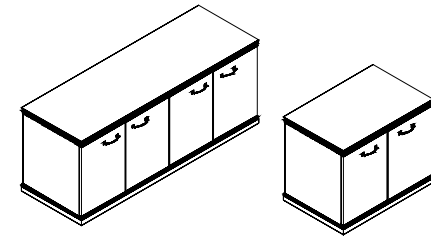

1 Select Model

w" x d" x h"	Weight
4 Door	
71 x 24 x 29	260
59 x 24 x 29	225
2 Door	
36 x 24 x 29	130
30 x 24 x 29	120

Standard Veneer Top Standard Veneer Chassis	Premium Veneer Top Premium Veneer Chassis	High Pressure Laminate Top Veneer Chassis	Thermally Fused Laminate Top Thermally Fused Laminate Chassis
PRA7124CA125W 5477	"P" Option N/A	PRA7124CA125G 5477	"M" Option N/A
PRA5924CA125W 5232	"P" Option N/A	PRA5924CA125G 5232	"M" Option N/A
PRA3624CA125W 3204	"P" Option N/A	PRA3624CA125G 3204	"M" Option N/A
PRA3024CA125W 3042	"P" Option N/A	PRA3024CA125G 3042	"M" Option N/A

2 Select Finish

[Click to view finishes](#)

- WAC
- WIC
- WHC
- WOC
- WEW
- WGW
- WBW
- WSW
- WNW

- GAC
- GIC
- GHC
- GOC
- GEW
- GNW

3 Select Edge

[Click to view edges](#)



4 Select Hardware

[Click to view details](#)

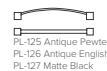
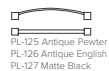

Product Features

- Adjustable glides
- 1 Adjustable veneer shelf behind door set
- Solid hardwood base/dentil molding

Notes

- Glides adjust 1"
- Unit has black back panel and is not designed for Open Plan use. Select OPB Option for Open Plan application

Options

Accessories

- REF-01: Modify storage section for refrigerator (Open back/water mat) - \$205

Door

- D2: Door lock - \$100 per door set
- D6: Delete Doors - n/c
- D9SC: Soft Close Door Hinges - \$20 per door

Flush Cut

- FC-B: Flush Unit Both Sides(Facing) for Ganging - \$100
- FC-R: Flush Unit Right(Facing) for Ganging - \$100
- FC-L: Flush Unit Left (Facing) for Ganging - \$100

Grommets (Standard Location)

- Specify Color and Location (Right/Left/Center) - \$50 ea.
- Black: TM30-R (Right), TM30-L (Left), TM30-C (Center)
 - Silver: TM31-R (Right), TM31-L (Left), TM31-C (Center)
 - Antique Brass: TM33-R (Right), TM33-L (Left), TM33-C (Center)

Grommets (Non-Standard Location)

- Provide drawing w/ Grommet Location and Specify Color - \$95 ea.
- Black: TM30-NS, Silver: TM31-NS, Antique Brass: TM33-NS

Grommets (Vertical Surface)

- Standard Location - \$50 ea. ea.
- Black Plastic Vertical Surface: TM50-C (Bottom Center)
- Non-Standard Location - \$95 ea.
- Black Plastic Vertical Surface: TM50-NS

Molding

- DSM1: Delete Dentil Molding Only - n/c

Open Plan _ Finished Back

- OPB: W "G" Style - Modify Unit for Open Plan Application - \$295

Prado

Credenzas
Lateral Files

[Click here to view statement of line](#)

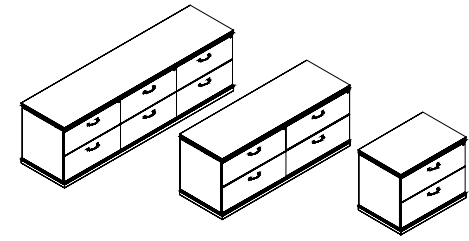

1 Select Model

w" x d" x h"	Weight
6 Drawer	
94 x 24 x 29	525
88 x 24 x 29	490
4 Drawer	
71 x 24 x 29	325
59 x 24 x 29	290
2 Drawer	
36 x 24 x 29	170
30 x 24 x 29	160

Standard Veneer Top Standard Veneer Chassis	Premium Veneer Top Premium Veneer Chassis	High Pressure Laminate Top Veneer Chassis	Thermally Fused Laminate Top Thermally Fused Laminate Chassis
PRA9424CA104W 9639	"P" Option N/A	PRA9424CA104G 9639	"M" Option N/A
PRA8824CA104W 9474	"P" Option N/A	PRA8824CA104G 9474	"M" Option N/A
PRA7124CA104W 7085	"P" Option N/A	PRA7124CA104G 7085	"M" Option N/A
PRA5924CA104W 6762	"P" Option N/A	PRA5924CA104G 6762	"M" Option N/A
PRA3624CA104W 3365	"P" Option N/A	PRA3624CA104G 3365	"M" Option N/A
PRA3024CA104W 3204	"P" Option N/A	PRA3024CA104G 3204	"M" Option N/A

2 Select Finish

[Click to view finishes](#)

- WAC
- WIC
- WHC
- WOC
- WEW
- WGW
- WBW
- WSW
- WNW

- GAC
- GIC
- GHC
- GOC
- GEW
- GNW

3 Select Edge

[Click to view edges](#)



4 Select Hardware

[Click to view details](#)

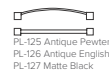
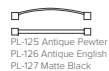

Product Features

- Adjustable glides
- Anti-tilt safety feature
- Legal/Double letter filing
- Features ball bearing suspensions, suspensions are full extension.
- Solid hardwood base/dentil molding

Notes

- Glides adjust 1"
- Unit has black back panel and is not designed for Open Plan use. Select OPB Option for Open Plan application

Options

Drawer

- P13: Modify Lateral File To Storage Cabinet - \$100 per pedestal(Use on 4/6 drawer units)

Flush Cut

- FC-B: Flush Unit Both Sides(Facing) for Ganging - \$100
- FC-R: Flush Unit Right(Facing) for Ganging - \$100
- FC-L: Flush Unit Left (Facing) for Ganging - \$100

Molding

- DSM1: Delete Dentil Molding Only - n/c

Open Plan _ Finished Back

- OPB: W "G" Style - Modify Unit for Open Plan Application - \$295

Prado

Credenzas

Vertical Lateral File

[Click here to view statement of line](#)

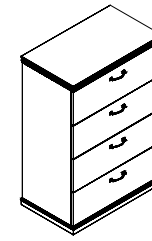

1 Select Model

w" x d" x h"
Freestanding
36 x 24 x 52
30 x 24 x 52

Weight

Standard Veneer Top Standard Veneer Chassis	Premium Veneer Top Premium Veneer Chassis	High Pressure Laminate Top Veneer Chassis	Thermally Fused Laminate Top Thermally Fused Laminate Chassis
--	--	--	--

275
250

PRA3624FI111W 5152
PRA3024FI111W 4991

"P" Option N/A
"P" Option N/A

PRA3624FI111G 5152
PRA3024FI111G 4991

"M" Option N/A
"M" Option N/A

Product Features

- Adjustable glides
- Anti-tilt safety feature
- Legal/Double letter filing
- Features ball bearing suspensions, suspensions are full extension

Notes

- Glides adjust 1"
- Unit has black back panel and is not designed for Open Plan use. Select OPB Option for Open Plan application

Options

Flush Cut

- FC-B: Flush Unit Both Sides(Facing) for Ganging - \$100
- FC-R: Flush Unit Right(Facing) for Ganging - \$100
- FC-L: Flush Unit Left (Facing) for Ganging - \$100

Molding

- DSM1: Delete Dentil Molding Only - n/c

Open Plan _ Finished Back

- OPB: W "G" Style - Modify Unit for Open Plan Application - \$295

2 Select Finish

[Click to view finishes](#)

WAC
WIC
WHC
WOC
WEW
WGW
WBW
WSW
WNW

GAC
GIC
GHC
GOC
GEW
GNW

3 Select Edge

[Click to view edges](#)



Prado



Prado

4 Select Hardware

[Click to view details](#)



PL-115 Matte Black
PL-116 Matte Nickel

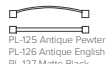

PL-125 Antique Pewter
PL-126 Antique English
PL-127 Matte Black



PL-115 Matte Black
PL-116 Matte Nickel



PL-125 Antique Pewter
PL-126 Antique English
PL-127 Matte Black

Prado

Credenzas
Conference Storage

[Click here to view statement of line](#)

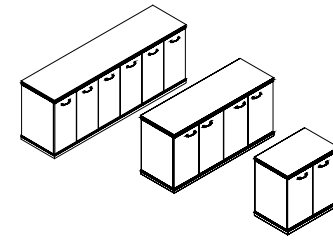

1 Select Model

w" x d" x h"	Weight
6 Door	
94 x 24 x 36	360
88 x 24 x 36	345
4 Door	
71 x 24 x 36	270
59 x 24 x 36	220
2 Door	
36 x 24 x 36	160
30 x 24 x 36	150

Standard Veneer Top Standard Veneer Chassis		Premium Veneer Top Premium Veneer Chassis		High Pressure Laminate Top Veneer Chassis		Thermally Fused Laminate Top Thermally Fused Laminate Chassis	
			"P" Option N/A				"M" Option N/A
			"P" Option N/A				"M" Option N/A
			"P" Option N/A				"M" Option N/A
			"P" Option N/A				"M" Option N/A
			"P" Option N/A				"M" Option N/A
			"P" Option N/A				"M" Option N/A

2 Select Finish

[Click to view finishes](#)

- WAC
- WIC
- WHC
- WOC
- WEW
- WGW
- WBW
- WSW
- WNW

- GAC
- GIC
- GHC
- GOC
- GEW
- GNW

3 Select Edge

[Click to view edges](#)



Prado



Prado

4 Select Hardware

[Click to view details](#)



PL-115 Matte Black
PL-116 Matte Nickel

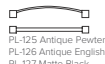

PL-125 Antique Pewter
PL-126 Antique English
PL-127 Matte Black



PL-115 Matte Black
PL-116 Matte Nickel



PL-125 Antique Pewter
PL-126 Antique English
PL-127 Matte Black

Product Features

- Adjustable glides
- 1 Adjustable veneer shelf behind door set
- Solid hardwood base/dentil molding

Notes

- Glides adjust 1"
- Unit has black back panel and is not designed for Open Plan use. Select OPB Option for Open Plan application

Options

Accessories

- REF-01: Modify storage section for refrigerator (Open back/water mat) - \$205

Door

- D2: Door lock - \$100 per door set
- D6: Delete Doors - n/c
- D9SC: Soft Close Door Hinges - \$20 per door

Flush Cut

- FC-B: Flush Unit Both Sides(Facing) for Ganging - \$100
- FC-R: Flush Unit Right(Facing) for Ganging - \$100
- FC-L: Flush Unit Left (Facing) for Ganging - \$100

Grommets (Standard Location)

- Specify Color and Location (Right/Left/Center) - \$50 ea.
- Black: TM30-R (Right), TM30-L (Left), TM30-C (Center)
- Silver: TM31-R (Right), TM31-L (Left), TM31-C (Center)
- Antique Brass: TM33-R (Right), TM33-L (Left), TM33-C (Center)

Grommets (Non-Standard Location)

- Provide drawing w/ Grommet Location and Specify Color - \$95 ea.
- Black: TM30-NS, Silver: TM31-NS, Antique Brass: TM33-NS

Grommets (Vertical Surface)

- Standard Location - \$50 ea. ea.
- Black Plastic Vertical Surface: TM50-C (Bottom Center)
- Non-Standard Location - \$95 ea.
- Black Plastic Vertical Surface: TM50-NS

Molding

- DSM1: Delete Dentil Molding Only - n/c

Open Plan _ Finished Back

- OPB: W "G" Style - Modify Unit for Open Plan Application - \$295

Prado

Credenzas

Buffet Credenza

[Click here to view statement of line](#)

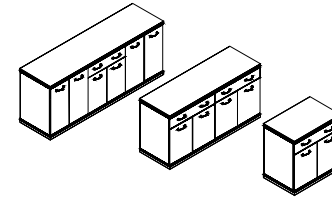

1 Select Model

w" x d" x h"

Weight	6 Door	4 Door	2 Door
350	94 x 24 x 36	71 x 24 x 36	36 x 24 x 36
300			
160			

Standard Veneer Top Standard Veneer Chassis	Premium Veneer Top Premium Veneer Chassis	High Pressure Laminate Top Veneer Chassis	Thermally Fused Laminate Top Thermally Fused Laminate Chassis
PRA9424CA126W 8499	"P" Option N/A	PRA9424CA126G 8499	"M" Option N/A
PRA7124CA126W 7466	"P" Option N/A	PRA7124CA126G 7466	"M" Option N/A
PRA3624CA126W 3971	"P" Option N/A	PRA3624CA126G 3971	"M" Option N/A

2 Select Finish

[Click to view finishes](#)

- WAC
- WIC
- WHC
- WOC
- WEW
- WGW
- WBW
- WSW
- WNW

- GAC
- GIC
- GHC
- GOC
- GEW
- GNW

3 Select Edge

[Click to view edges](#)



4 Select Hardware

[Click to view details](#)

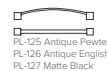
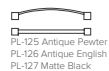

Product Features

- 1 Adjustable veneer shelf behind door set
- Adjustable glides
- Full extension drawers - locking
- Soft close suspension drawer(s)
- Utility drawer with felt liner

Notes

- Glides adjust 1"
- Unit has black back panel and is not designed for Open Plan use. Select OPB Option for Open Plan application

Options

Accessories

- REF-01: Modify storage section for refrigerator (Open back/water mat) - \$205

Door

- D2: Door lock - \$100 per door set
- D6: Delete Doors - n/c
- D9SC: Soft Close Door Hinges - \$20 per door

Flush Cut

- FC-B: Flush Unit Both Sides(Facing) for Ganging - \$100
- FC-R: Flush Unit Right(Facing) for Ganging - \$100
- FC-L: Flush Unit Left (Facing) for Ganging - \$100

Grommets (Standard Location)

- Specify Color and Location (Right/Left/Center) - \$50 ea.
- Black: TM30-R (Right), TM30-L (Left), TM30-C (Center)
- Silver: TM31-R (Right), TM31-L (Left), TM31-C (Center)
- Antique Brass: TM33-R (Right), TM33-L (Left), TM33-C (Center)

Grommets (Non-Standard Location)

- Provide drawing w/ Grommet Location and Specify Color - \$95 ea.
- Black: TM30-NS, Silver: TM31-NS, Antique Brass: TM33-NS

Grommets (Vertical Surface)

- Standard Location - \$50 ea. ea.
- Black Plastic Vertical Surface: TM50-C (Bottom Center)
- Non-Standard Location - \$95 ea.
- Black Plastic Vertical Surface: TM50-NS

Molding

- DSM1: Delete Dentil Molding Only - n/c

Open Plan _ Finished Back

- OPB: W "G" Style - Modify Unit for Open Plan Application - \$295

Prado

Workstation Credenzas
File / File

[Click here to view statement of line](#)

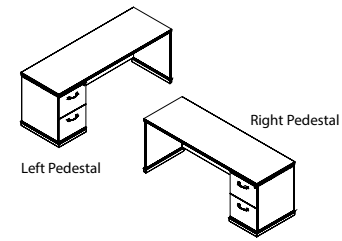

1 Select Model

w" x d" x h"	Weight
Left Pedestal	
88 x 24 x 29	240
71 x 24 x 29	220
65 x 24 x 29	190
Right Pedestal	
88 x 24 x 29	240
71 x 24 x 29	220
65 x 24 x 29	190

Standard Veneer Top Standard Veneer Chassis	Premium Veneer Top Premium Veneer Chassis	High Pressure Laminate Top Veneer Chassis	Thermally Fused Laminate Top Thermally Fused Laminate Chassis
PRA8824CA086W 5962	"P" Option N/A	PRA8824CA086G 5962	"M" Option N/A
PRA7124CA086W 4502	"P" Option N/A	PRA7124CA086G 4502	"M" Option N/A
PRA6524CA086W 4267	"P" Option N/A	PRA6524CA086G 4267	"M" Option N/A
PRA8824CA087W 5962	"P" Option N/A	PRA8824CA087G 5962	"M" Option N/A
PRA7124CA087W 4502	"P" Option N/A	PRA7124CA087G 4502	"M" Option N/A
PRA6524CA087W 4267	"P" Option N/A	PRA6524CA087G 4267	"M" Option N/A

2 Select Finish

[Click to view finishes](#)

- WAC
- WIC
- WHC
- WOC
- WEW
- WGW
- WBW
- WSW
- WNW

- GAC
- GIC
- GHC
- GOC
- GEW
- GNW

3 Select Edge

[Click to view edges](#)



Prado



Prado

4 Select Hardware

[Click to view details](#)



PL-115 Matte Black
PL-116 Matte Nickel

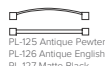

PL-125 Antique Pewter
PL-126 Antique English
PL-127 Matte Black



PL-115 Matte Black
PL-116 Matte Nickel



PL-125 Antique Pewter
PL-126 Antique English
PL-127 Matte Black

Product Features

- Full extension drawers - locking
- Full fixed modesty
- Soft close suspension drawer(s)
- Solid hardwood base/dentil molding
- Wire management channel

Notes

- Unit has black back panel and is not designed for Open Plan use. Select OPB Option for Open Plan application

Options

Accessories

- K28: Articulating keyboard w/ mouse pad (Installed) - \$390

Drawer

- P6: Modify File/File to Box/Box/File - \$55 per pedestal
- P40B: extra Box/Box/File or File/File to Kneespace - \$1025

Flush Cut

- FC-B: Flush Unit Both Sides(Facing) for Ganging - \$100
- FC-R: Flush Unit Right(Facing) for Ganging - \$100
- FC-L: Flush Unit Left (Facing) for Ganging - \$100

Grommets (Standard Location)

Specify Color - \$50 ea.

- Black: TM30-C (Center)
- Silver: TM31-C (Center)
- Antique Brass: TM33-C (Center)

Grommets (Non-Standard Location)

Provide drawing w/ Grommet Location and Specify Color - \$95 ea.

- Black: TM30-NS
- Silver: TM31-NS
- Antique Brass: TM33-NS

Modesty

- M34T: Drop Door Tech Modesty - \$130
- M51: Open Back Modesty with Wire Mgmt Rail - Deduct \$95

Molding

- DSM1: Delete Dentil Molding Only - n/c

Open Plan _ Finished Back

- OPB: "W" "G" Style - Modify Unit for Open Plan Application - \$295

Prado

Workstation Credenzas
Lateral File

[Click here to view statement of line](#)

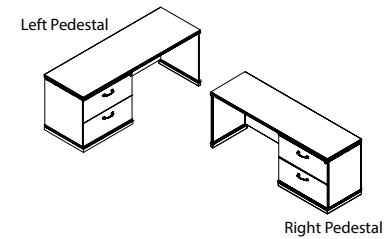

1 Select Model

w" x d" x h"	Weight
94 x 24 x 29	310
88 x 24 x 29	285
71 x 24 x 29	265
65 x 24 x 29	250
Right Pedestal	
94 x 24 x 29	310
88 x 24 x 29	285
71 x 24 x 29	265
65 x 24 x 29	250

Standard Veneer Top Standard Veneer Chassis		Premium Veneer Top Premium Veneer Chassis		High Pressure Laminate Top Veneer Chassis		Thermally Fused Laminate Top Thermally Fused Laminate Chassis	
PRA9424CA066W	6453	"P" Option N/A		PRA9424CA066G	6453	"M" Option N/A	
PRA8824CA066W	6288	"P" Option N/A		PRA8824CA066G	6288	"M" Option N/A	
PRA7124CA066W	5152	"P" Option N/A		PRA7124CA066G	5152	"M" Option N/A	
PRA6524CA066W	4991	"P" Option N/A		PRA6524CA066G	4991	"M" Option N/A	
PRA9424CA067W	6453	"P" Option N/A		PRA9424CA067G	6453	"M" Option N/A	
PRA8824CA067W	6288	"P" Option N/A		PRA8824CA067G	6288	"M" Option N/A	
PRA7124CA067W	5152	"P" Option N/A		PRA7124CA067G	5152	"M" Option N/A	
PRA6524CA067W	4991	"P" Option N/A		PRA6524CA067G	4991	"M" Option N/A	

2 Select Finish

[Click to view finishes](#)

- WAC
- WIC
- WHC
- WOC
- WEW
- WGW
- WBW
- WSW
- WNW

- GAC
- GIC
- GHC
- GOC
- GEW
- GNW

3 Select Edge

[Click to view edges](#)



Prado



Prado

4 Select Hardware

[Click to view details](#)



PL-115 Matte Black
PL-116 Matte Nickel

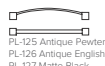

PL-125 Antique Pewter
PL-126 Antique English
PL-127 Matte Black



PL-115 Matte Black
PL-116 Matte Nickel



PL-125 Antique Pewter
PL-126 Antique English
PL-127 Matte Black

Product Features

- Full fixed modesty
- Features ball bearing suspensions, suspensions are full extension
- Solid hardwood base/dentil molding

Notes

- Unit has black back panel and is not designed for Open Plan use. Select OPB Option for Open Plan application
- 94" W & 88"W have 35"W Lateral
- 71" W & 65" W have 29"W Lateral

Options

Accessories

- K28: Articulating keyboard w/ mouse pad (Installed) - \$390

Drawer

- P13: Modify Lateral File To Storage Cabinet - \$100
- P40B: extra Box/Box/File or File/File to Kneespace - \$1025 (n/a on 65" w unit)

Flush Cut

- FC-B: Flush Unit Both Sides(Facing) for Ganging - \$100
- FC-R: Flush Unit Right(Facing) for Ganging - \$100
- FC-L: Flush Unit Left (Facing) for Ganging - \$100

Grommets (Standard Location)

- Specify Color - \$50 ea.
- Black: TM30-C (Center)
 - Silver: TM31-C (Center)
 - Antique Brass: TM33-C (Center)

Grommets (Non-Standard Location)

- Provide drawing w/ Grommet Location and Specify Color - \$95 ea.
- Black: TM30-NS
 - Silver: TM31-NS
 - Antique Brass: TM33-NS

Modesty

- M34T: Drop Door Tech Modesty - \$130
- M51: Open Back Modesty with Wire Mgmt Rail - Deduct \$95

Molding

- DSM1: Delete Dentil Molding Only - n/c

Open Plan _ Finished Back

- OPB: "W" "G" Style - Modify Unit for Open Plan Application - \$295

Prado

Workstation Credenzas
Multi-File

[Click here to view statement of line](#)

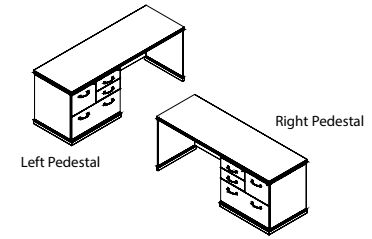

1 Select Model

w" x d" x h"
Left Pedestal
94 x 24 x 29
88 x 24 x 29
71 x 24 x 29
65 x 24 x 29
Right Pedestal
94 x 24 x 29
88 x 24 x 29
71 x 24 x 29
65 x 24 x 29

Weight	Standard Veneer Top Standard Veneer Chassis	Premium Veneer Top Premium Veneer Chassis	High Pressure Laminate Top Veneer Chassis	Thermally Fused Laminate Top Thermally Fused Laminate Chassis
310	PRA9424CA667W 6937	"P" Option N/A	PRA9424CA667G 6937	"M" Option N/A
285	PRA8824CA667W 6777	"P" Option N/A	PRA8824CA667G 6777	"M" Option N/A
265	PRA7124CA667W 5638	"P" Option N/A	PRA7124CA667G 5638	"M" Option N/A
250	PRA6524CA667W 5477	"P" Option N/A	PRA6524CA667G 5477	"M" Option N/A
310	PRA9424CA668W 6937	"P" Option N/A	PRA9424CA668G 6937	"M" Option N/A
285	PRA8824CA668W 6777	"P" Option N/A	PRA8824CA668G 6777	"M" Option N/A
265	PRA7124CA668W 5638	"P" Option N/A	PRA7124CA668G 5638	"M" Option N/A
250	PRA6524CA668W 5477	"P" Option N/A	PRA6524CA668G 5477	"M" Option N/A

2 Select Finish

[Click to view finishes](#)

WAC
WIC
WHC
WOC
WEW
WGW
WBW
WSW
WNW

GAC
GIC
GHC
GOC
GEW
GNW

3 Select Edge

[Click to view edges](#)



Prado



Prado

4 Select Hardware

[Click to view details](#)



PL-115 Matte Black
PL-116 Matte Nickel

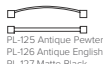

PL-125 Antique Pewter
PL-126 Antique English
PL-127 Matte Black



PL-115 Matte Black
PL-116 Matte Nickel



PL-125 Antique Pewter
PL-126 Antique English
PL-127 Matte Black

Product Features

- Full fixed modesty
- "W" & "G" Box and File Drawers feature soft close suspensions (Lateral Drawers Feature ball bearing suspensions)
- Solid hardwood base/dentil molding

Notes

- Unit has black back panel and is not designed for Open Plan use. Select OPB Option for Open Plan application

Options

Accessories

- K28: Articulating keyboard w/ mouse pad (Installed) - \$390 (n/a on 71" and 65")

Drawer

- P40B: extra Box/Box/File or File/File to Kneespace - \$1025 (n/a on 65" w unit)

Flush Cut

- FC-B: Flush Unit Both Sides(Facing) for Ganging - \$100
- FC-R: Flush Unit Right(Facing) for Ganging - \$100
- FC-L: Flush Unit Left (Facing) for Ganging - \$100

Grommets (Standard Location)

Specify Color - \$50 ea.

- Black: TM30-C (Center)
- Silver: TM31-C (Center)
- Antique Brass: TM33-C (Center)

Grommets (Non-Standard Location)

Provide drawing w/ Grommet Location and Specify Color - \$95 ea.

- Black: TM30-NS
- Silver: TM31-NS
- Antique Brass: TM33-NS

Modesty

- M34T: Drop Door Tech Modesty - \$130
- M51: Open Back Modesty with Wire Mgmt Rail - Deduct \$95

Molding

- DSM1: Delete Dentil Molding Only - n/c

Open Plan _ Finished Back

- OPB: "W" "G" Style - Modify Unit for Open Plan Application - \$295

Prado

Overhead Task
Freestanding Panel Door - 6/4/2 Door

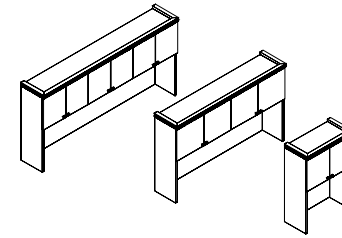

[Click here to view statement of line](#)

1 Select Model

w" x d" x h"	Weight
6 Door	
94 x 15 x 44	310
88 x 15 x 44	280
4 Door	
83 x 15 x 44	260
76 x 15 x 44	245
71 x 15 x 44	230
65 x 15 x 44	210
59 x 15 x 44	195
48 x 15 x 44	185
2 Door	
36 x 15 x 44	155
30 x 15 x 44	145

	Standard Veneer Top Standard Veneer Chassis	Premium Veneer Top Premium Veneer Chassis	High Pressure Laminate Top Veneer Chassis	Thermally Fused Laminate Top Thermally Fused Laminate Chassis
	PRA9444OH325W 7100	"P" Option N/A	"G" Option N/A	"M" Option N/A
	PRA8844OH325W 6453	"P" Option N/A	"G" Option N/A	"M" Option N/A
	PRA8344OH325W 5803	"P" Option N/A	"G" Option N/A	"M" Option N/A
	PRA7644OH325W 5638	"P" Option N/A	"G" Option N/A	"M" Option N/A
	PRA7144OH325W 5477	"P" Option N/A	"G" Option N/A	"M" Option N/A
	PRA6544OH325W 5314	"P" Option N/A	"G" Option N/A	"M" Option N/A
	PRA5944OH325W 5071	"P" Option N/A	"G" Option N/A	"M" Option N/A
	PRA4844OH325W 4871	"P" Option N/A	"G" Option N/A	"M" Option N/A
	PRA3644OH325W 3176	"P" Option N/A	"G" Option N/A	"M" Option N/A
	PRA3044OH325W 3087	"P" Option N/A	"G" Option N/A	"M" Option N/A

Product Features

- 2" Top cornice frame with dentil molding
- Finished top
- Interior cabinet depth 12.5"
- Interior clearance 15 -5/8"
- 5/8" grommet(s) included for task light wire management

Notes

- Ganged Units Must Be Clearly Noted As To Individual Unit Locations
- Shipped Assembled
- Unit has black back panel and is not designed for Open Plan use. Select OPB Option for Open Plan application

Options

- Door**
- D2: Door lock - \$100 per door set
 - D6: Delete Doors - n/c
 - D9SC: Soft Close Door Hinges - \$20 per door
- Flush Cut**
- FC-B: Flush Unit Both Sides(Facing) for Ganging - \$100
 - FC-R: Flush Unit Right(Facing) for Ganging - \$100
 - FC-L: Flush Unit Left (Facing) for Ganging - \$100

- Grommets (Vertical Surface)**
- Standard Location - \$50 ea. ea.
 - Black Plastic Vertical Surface: TM50-C (Bottom Center)
 - Non-Standard Location - \$95 ea.
 - Black Plastic Vertical Surface: TM50-NS

- Molding**
- DSM: Delete Dentil Molding Only - n/c
- Open Plan _ Finished Back**
- OPB: W "G" Style - Modify Unit for Open Plan Application - \$395

Task Lighting
Overhead task light cord is located on the right facing side. If the opposite location is required please contact customer service.

- LT-LED24: 24" LED Task light - \$215
- LT-LED48: 48" LED Task light - \$270
- LT-LED60: 60" LED Task light - \$335
- LT-LED72: 72" LED Task light - \$360

2 Select Finish

- [Click to view finishes](#)
- WAC
 - WIC
 - WHC
 - WOC
 - WEW
 - WGW
 - WBW
 - WSW
 - WNW

3 Select Edge

- [Click to view edges](#)
- Edge
 - N/A

4 Select Hardware

- [Click to view details](#)
- DK-125 Antique Pewter
 - DK-126 Antique English
 - DK-127 Matte Black

Prado

Overhead Task
Freestanding Wood Frame Leaded/Beveled Glass Doors

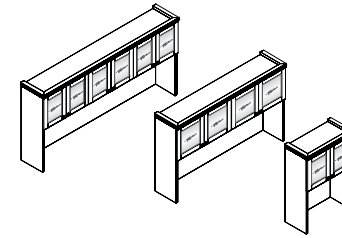

[Click here to view statement of line](#)

1 Select Model

w" x d" x h"	
6 Door	
94 x 15 x 44	310
88 x 15 x 44	280
4 Door	
83 x 15 x 44	260
76 x 15 x 44	245
71 x 15 x 44	230
65 x 15 x 44	210
59 x 15 x 44	195
2 Door	
36 x 15 x 44	155
30 x 15 x 44	145

Weight

Standard Veneer Top Standard Veneer Chassis		Premium Veneer Top Premium Veneer Chassis		High Pressure Laminate Top Veneer Chassis	Thermally Fused Laminate Top Thermally Fused Laminate Chassis
			"P" Option N/A	"G" Option N/A	"M" Option N/A
			"P" Option N/A	"G" Option N/A	"M" Option N/A
			"P" Option N/A	"G" Option N/A	"M" Option N/A
			"P" Option N/A	"G" Option N/A	"M" Option N/A
			"P" Option N/A	"G" Option N/A	"M" Option N/A
			"P" Option N/A	"G" Option N/A	"M" Option N/A
			"P" Option N/A	"G" Option N/A	"M" Option N/A
			"P" Option N/A	"G" Option N/A	"M" Option N/A
			"P" Option N/A	"G" Option N/A	"M" Option N/A
			"P" Option N/A	"G" Option N/A	"M" Option N/A
			"P" Option N/A	"G" Option N/A	"M" Option N/A
			"P" Option N/A	"G" Option N/A	"M" Option N/A
			"P" Option N/A	"G" Option N/A	"M" Option N/A
			"P" Option N/A	"G" Option N/A	"M" Option N/A
			"P" Option N/A	"G" Option N/A	"M" Option N/A

2 Select Finish

[Click to view finishes](#)

- WAC
- WIC
- WHC
- WOC
- WEW
- WGW
- WBW
- WSW
- WNW

3 Select Edge

[Click to view edges](#)

Edge
N/A

4 Select Hardware

[Click to view details](#)



DK-125 Antique Pewter
DK-126 Antique English
DK-127 Matte Black

Product Features

- 2" Top cornice frame with dentil molding
- Beveled glass w/ lead bead detailing
- Finished top
- Interior cabinet depth 12.5"
- Interior clearance 15 -5/8"
- Solid wood door frame
- 5/8" grommet(s) included for task light wire management

Notes

- Ganged Units Must Be Clearly Noted As To Individual Unit Locations
- Shipped Assembled
- Unit has black back panel and is not designed for Open Plan use. Select OPB Option for Open Plan application

Options

Door

- D2: Door lock - \$100 per door set
- D6: Delete Doors - n/c
- D9SC: Soft Close Door Hinges - \$20 per door
- D35: Replace glass panel insert with veneer panel insert - \$35 per door

Flush Cut

- FC-B: Flush Unit Both Sides(Facing) for Ganging - \$100
- FC-R: Flush Unit Right(Facing) for Ganging - \$100
- FC-L: Flush Unit Left (Facing) for Ganging - \$100

Grommets (Vertical Surface)

- Standard Location - \$50 ea. ea.
- Black Plastic Vertical Surface: TM50-C (Bottom Center)
- Non-Standard Location - \$95 ea.
- Black Plastic Vertical Surface: TM50-NS

Interior Cabinet Lighting

- LEDPK starter kit includes Infeed, 1 Puck Interior Light and the ability to daisy chain up to 6 total Puck Lights
- LEDPK: LED Puck Starter Kit - \$310
- PK: 1 LED Interior Light - \$130

Task Lighting

- Overhead task light cord is located on the right facing side. If the opposite location is required please contact customer service.
- LT-LED24: 24" LED Task light -\$215
- LT-LED48: 48" LED Task light - \$270
- LT-LED60: 60" LED Task light - \$335
- LT-LED72: 72" LED Task light - \$360

Molding

- DSM1: Delete Dentil Molding Only - n/c

Open Plan _ Finished Back

- OPB: W "G" Style - Modify Unit for Open Plan Application - \$395

Darran Tackboards.

Overhead tackboard
Full width tackboards

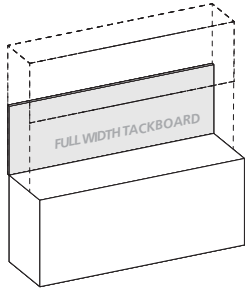

Product Width	Panel Dimension	SKU	COM	1	2	3	4	5	6	7	8	9	10	11/L1	12	13/L2
94	91 x .75 x 21	FTOC9121	379	480	531	582	633	684	735	786	837	888	939	990	1041	1143
88	85 x .75 x 21	FTOC8521	358	449	497	545	593	641	689	737	785	833	881	929	977	1073
84	81 x .75 x 21	FTOC8121	336	428	474	520	566	612	658	704	750	796	842	888	934	1026
77	74 x .75 x 21	FTOC7421	309	392	435	478	521	564	607	650	693	736	779	822	865	951
71	68 x .75 x 21	FTOC6821	282	361	401	441	481	521	561	601	641	681	721	761	801	881
65	62 x .75 x 21	FTOC6221	256	330	366	402	438	474	510	546	582	618	654	690	726	798
59	56 x .75 x 21	FTOC5621	234	299	331	363	395	427	459	491	523	555	587	619	651	715
48	45 x .75 x 21	FTOC4521	187	242	269	296	323	350	377	404	431	458	485	512	539	593
36	33 x .75 x 21	FTOC3321	141	180	200	220	240	260	280	300	320	340	360	380	400	440
30	27 x .75 x 21	FTOC2721	112	149	166	183	200	217	234	251	268	285	302	319	336	370

Standard Features

- Constructed of .5" thick fiberboard
- Fabric is precisely aligned and fitted to the tackboard
- Adhered to the rigid hardboard with staples
- Hung with Z-Strip mounting system

Notes

- Fabric Tack Panels are raised 3" from bottom edge when TM50 grommet is ordered

Overhead tackboard
Half width tackboards

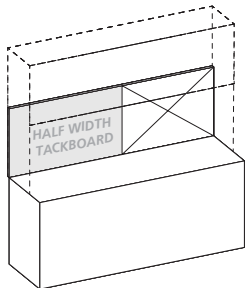

Product Width	Panel Dimension	SKU	COM	1	2	3	4	5	6	7	8	9	10	11/L1	12	13/L2
94 Half Width	45.5 x .75 x 21	FTOC4521	189	240	266	292	318	344	370	396	422	448	474	500	526	578
88 Half Width	42.5 x .75 x 21	FTOC4221	179	225	249	273	297	321	345	369	393	417	441	465	489	537
84 Half Width	40.5 x .75 x 21	FTOC4021	168	214	237	260	283	306	329	352	375	398	421	444	467	513
77 Half Width	37 x .75 x 21	FTOC3721	155	196	217	238	259	280	301	322	343	364	385	406	427	469
71 Half Width	34 x .75 x 21	FTOC3421	141	180	200	220	240	260	280	300	320	340	360	380	400	440
65 Half Width	31 x .75 x 21	FTOC3121	128	165	183	201	219	237	255	273	291	309	327	345	363	399

Standard Features

- Constructed of .5" thick fiberboard
- Fabric is precisely aligned and fitted to the tackboard
- Adhered to the rigid hardboard with staples
- Hung with Z-Strip mounting system

Notes

- Half width tackboards can be specified and combined with a Veneer Panel, Marker Board, Slat Wall or Glass Board. See "Half Width" items under product width.
- Specify right or left facing tackboard
- Fabric Tack Panels are raised 3" from bottom edge when TM50 grommet is ordered

DARRAN®

Overhead dry marker board
Full width dry marker board

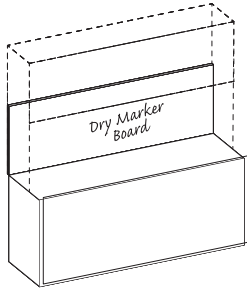

Product Width	Panel Dimension	SKU	List
94	91 x .5 x 21	DMOC9121	1136
88	85 x .5 x 21	DMOC8521	1061
84	81 x .5 x 21	DMOC8121	1011
77	74 x .5 x 21	DMOC7421	924
71	68 x .5 x 21	DMOC6821	849
65	62 x .5 x 21	DMOC6221	774
59	56 x .5 x 21	DMOC5621	699
48	45 x .5 x 21	DMOC4521	587
36	33 x .5 x 21	DMOC3321	437
30	27 x .5 x 21	DMOC2721	337

Standard Features

- Dry marker panel has edge trim molding
- Standard magnetic surface

- Hung with Z-Strip mounting system

Overhead dry marker board
Half width dry marker board

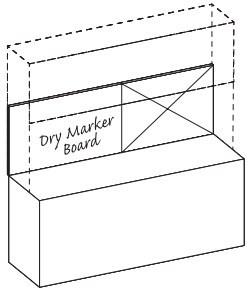

Product Width	Panel Dimension	SKU	List
94 Half Width	45.5 x .5 x 21	DMOC4521	555
88 Half Width	42.5 x .5 x 21	DMOC4221	518
84 Half Width	40.5 x .5 x 21	DMOC4021	493
77 Half Width	37 x .5 x 21	DMOC3721	449
71 Half Width	34 x .5 x 21	DMOC3421	437
65 Half Width	31 x .5 x 21	DMOC3121	374

Standard Features

- Dry marker panel has edge trim molding
- Standard magnetic surface
- Hung with Z-Strip mounting system

Notes

- Half width dry marker boards can be specified and combined with a Tackboard, Veneer Panel, Slat Wall or Glass Board. See "Half Width" items under product width.
- Specify right or left facing dry marker board

DARRAN®

Overhead glassboard
Full width glassboard

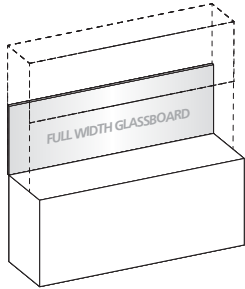

Product Width	Panel Dimension	SKU	List
94	91 x .5 x 21	GBOC9121	2382
88	85 x .5 x 21	GBOC8521	2236
84	81 x .5 x 21	GBOC8121	2138
77	74 x .5 x 21	GBOC7421	1969
71	68 x .5 x 21	GBOC6821	1822
65	62 x .5 x 21	GBOC6221	1676
59	56 x .5 x 21	GBOC5621	1531
48	45 x .5 x 21	GBOC4521	1264
36	33 x .5 x 21	GBOC3321	972
30	27 x .5 x 21	GBOC2721	826

Standard Features

- 4 mm tempered glass

Notes

- Earth magnets are required to hold items securely in place
- Hung with Z-Strip mounting system
- Use glass cleaner or alcohol to clean
- Standard dry erase markers may be used

Overhead glassboard
Half width glassboard

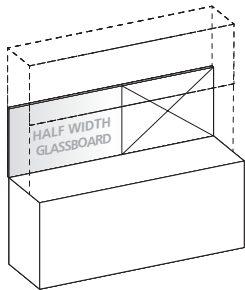

Product Width	Panel Dimension	SKU	List
94 Half Width	45.5 x .5 x 21	GBOC4521	1251
88 Half Width	42.5 x .5 x 21	GBOC4221	1178
84 Half Width	40.5 x .5 x 21	GBOC4021	1129
77 Half Width	37 x .5 x 21	GBOC3721	985
71 Half Width	34 x .5 x 21	GBOC3421	972
65 Half Width	31 x .5 x 21	GBOC3121	899

Standard Features

- 4 mm tempered glass
- Hung with Z-Strip mounting system

Notes

- Half width glassboards can be specified and combined with a Tackboard, Veneer panel, Marker Board or Slat Wall. See "Half Width" items under product width.
- Specify right or left facing glassboard
- Use glass cleaner or alcohol to clean
- Standard dry erase markers may be used
- Earth magnets are required to hold items securely in place

DARRAN®

Overhead slat wall
Half width slat wall

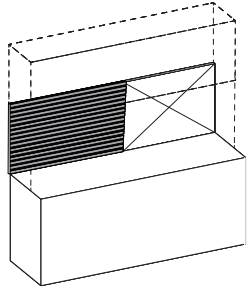

Product Width	Panel Dimension	SKU	List
94 Half Width	45.5 x .5 x 21	SWOC4521	463
88 Half Width	42.5 x .5 x 21	SWOC4221	432
84 Half Width	40.5 x .5 x 21	SWOC4021	411
77 Half Width	37 x .5 x 21	SWOC3721	374
71 Half Width	34 x .5 x 21	SWOC3421	343
65 Half Width	31 x .5 x 21	SWOC3121	312

Standard Features

- Available in silver or black
- Hung with Z-Strip mounting system

Notes

- Half width slat walls can be specified and combined with a Tackboard, Veneer panel, Marker Board or Glassboard. See "Half Width" items under product width.
- Specify right or left facing slat wall
- For use on 42"/43" height consoles

Prado

Wall Hung Cabinets
 Single Height Panel Doors - 6/4/2 Door

[Click here to view statement of line](#)

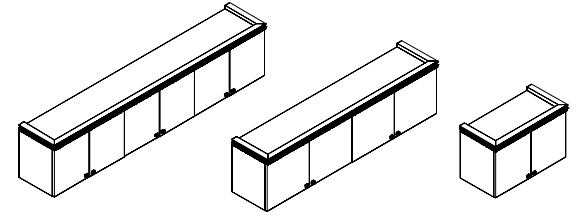

1 Select Model

w" x d" x h"	Weight
6 Door	
94 x 15 x 20	190
88 x 15 x 20	175
4 Door	
84 x 15 x 20	165
76 x 15 x 20	155
71 x 15 x 20	145
65 x 15 x 20	130
59 x 15 x 20	120
48 x 15 x 20	110
2 Door	
36 x 15 x 20	75
30 x 15 x 20	65

	Standard Veneer Top Standard Veneer Chassis	Premium Veneer Top Premium Veneer Chassis	High Pressure Laminate Top Veneer Chassis	Thermally Fused Laminate Top Thermally Fused Laminate Chassis
		"P" Option N/A	"G" Option N/A	"M" Option N/A
		"P" Option N/A	"G" Option N/A	"M" Option N/A
		"P" Option N/A	"G" Option N/A	"M" Option N/A
		"P" Option N/A	"G" Option N/A	"M" Option N/A
		"P" Option N/A	"G" Option N/A	"M" Option N/A
		"P" Option N/A	"G" Option N/A	"M" Option N/A
		"P" Option N/A	"G" Option N/A	"M" Option N/A
		"P" Option N/A	"G" Option N/A	"M" Option N/A
		"P" Option N/A	"G" Option N/A	"M" Option N/A
		"P" Option N/A	"G" Option N/A	"M" Option N/A
		"P" Option N/A	"G" Option N/A	"M" Option N/A
		"P" Option N/A	"G" Option N/A	"M" Option N/A
		"P" Option N/A	"G" Option N/A	"M" Option N/A
		"P" Option N/A	"G" Option N/A	"M" Option N/A
		"P" Option N/A	"G" Option N/A	"M" Option N/A
		"P" Option N/A	"G" Option N/A	"M" Option N/A
		"P" Option N/A	"G" Option N/A	"M" Option N/A
		"P" Option N/A	"G" Option N/A	"M" Option N/A

2 Select Finish

[Click to view finishes](#)

- WAC
- WIC
- WHC
- WOC
- WEW
- WGW
- WBW
- WSW
- WNW

3 Select Edge

[Click to view edges](#)

Edge
N/A

4 Select Hardware

[Click to view details](#)



Product Features

- 2" Top cornice frame with dentil moldings on 3 sides
- Interior cabinet depth 12"
- Prices include ganging mitre fit as specified
- Wall mount rail included

Notes

- The DARRAN wall mounted cabinet(or shelf) must be hung on a weight-bearing wall. The suitability of the wall supporting the wall mounted cabinet, and the installation and maintenance of the wall-mounted cabinet, is the sole responsibility of the customer. Failure to correctly install and/or exceed the loaded weight capacity of this product may cause it to fall, resulting in damage to the product, adjacent property and/or bodily injury.
- Can only gang with other wall cabinets. Cannot gang with overheads or towers.

Options

Door

- D2: Door lock - \$100 per door set
- D6: Delete door - n/c
- D9SC: Soft Close Door Hinges - \$20 per door

Flush Cut

- FC-B: Flush Unit Both Sides(Facing) for Ganging - \$100
- FC-R: Flush Unit Right(Facing) for Ganging - \$100
- FC-L: Flush Unit Left (Facing) for Ganging - \$100

Molding

- DSMt: Delete Dentil Molding Only - n/c

Task Lighting

- Overhead task light cord is located on the right facing side. If the opposite location is required please contact customer service.
- LT-LED24: 24" LED Task light - \$215
- LT-LED48: 48" LED Task light - \$270
- LT-LED60: 60" LED Task light - \$335
- LT-LED72: 72" LED Task light - \$360

Prado

Wall Hung Cabinets
Single Height Wood Frame Leaded/Beveled Glass Doors

[Click here to view statement of line](#)

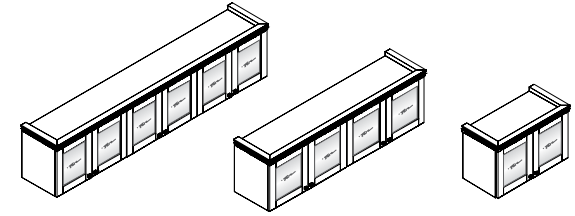

1 Select Model

w" x d" x h"	Weight
6 Door	
94 x 15 x 20	190
88 x 15 x 20	175
4 Door	
71 x 15 x 20	145
65 x 15 x 20	130
59 x 15 x 20	120
2 Door	
36 x 15 x 20	75
30 x 15 x 20	65

	Standard Veneer Top Standard Veneer Chassis	Premium Veneer Top Premium Veneer Chassis	High Pressure Laminate Top Veneer Chassis	Thermally Fused Laminate Top Thermally Fused Laminate Chassis
		"P" Option N/A	"G" Option N/A	"M" Option N/A
		"P" Option N/A	"G" Option N/A	"M" Option N/A
		"P" Option N/A	"G" Option N/A	"M" Option N/A
		"P" Option N/A	"G" Option N/A	"M" Option N/A
		"P" Option N/A	"G" Option N/A	"M" Option N/A
		"P" Option N/A	"G" Option N/A	"M" Option N/A
		"P" Option N/A	"G" Option N/A	"M" Option N/A
		"P" Option N/A	"G" Option N/A	"M" Option N/A

2 Select Finish

[Click to view finishes](#)

- WAC
- WIC
- WHC
- WOC
- WEW
- WGW
- WBW
- WSW
- WNW

3 Select Edge

[Click to view edges](#)

Edge
N/A

4 Select Hardware

[Click to view details](#)



Product Features

- 2" Top cornice frame with dentil moldings on 3 sides
- Interior cabinet depth 12"
- Prices include ganging mitre fit as specified
- Wall mount rail included

Notes

- The DARRAN wall mounted cabinet(or shelf) must be hung on a weight-bearing wall. The suitability of the wall supporting the wall mounted cabinet, and the installation and maintenance of the wall-mounted cabinet, is the sole responsibility of the customer. Failure to correctly install and/or exceed the loaded weight capacity of this product may cause it to fall, resulting in damage to the product, adjacent property and/or bodily injury.
- Can only gang with other wall cabinets. Cannot gang with overheads or towers.

Options

Door

- D2: Door Lock - \$100 per door set
- D6: Delete Doors - n/c
- D9SC: Soft Close Door Hinges - \$20 per door
- D35: Replace glass panel insert with veneer panel insert - \$35 per door

Flush Cut

- FC-B: Flush Unit Both Sides(Facing) for Ganging - \$100
- FC-R: Flush Unit Right(Facing) for Ganging - \$100
- FC-L: Flush Unit Left (Facing) for Ganging - \$100

Interior Cabinet Lighting

- LEDPK starter kit includes Infeed, 1 Puck Interior Light and the ability to daisy chain up to 6 total Puck Lights
- LEDPK: LED Puck Starter Kit - \$310
- PK: 1 LED Interior Light - \$130

Task Lighting

- Overhead task light cord is located on the right facing side. If the opposite location is required please contact customer service.
- LT-LED24: 24" LED Task light - \$215
- LT-LED48: 48" LED Task light - \$270
- LT-LED60: 60" LED Task light - \$335
- LT-LED72: 72" LED Task light - \$360

Molding

- DSM1: Delete Dentil Molding Only - n/c

DARRAN®

Wall hung tackboards Full width tackboards

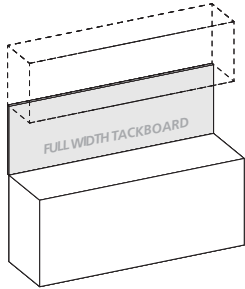

Product Width	Panel Dimension	SKU	COM	1	2	3	4	5	6	7	8	9	10	11/L1	12	13/L2
94	93 x .75 x 24	FTWH9324	465	576	627	678	729	780	831	882	933	984	1035	1086	1137	1239
88	87 x .75 x 24	FTWH8724	448	539	587	635	683	731	779	827	875	923	971	1019	1067	1163
84	83 x .75 x 24	FTWH8324	422	514	560	606	652	698	744	790	836	882	928	974	1020	1112
77	76 x .75 x 24	FTWH7624	388	471	514	557	600	643	686	729	772	815	858	901	944	1030
71	70 x .75 x 24	FTWH7024	355	434	474	514	554	594	634	674	714	754	794	834	874	954
65	64 x .75 x 24	FTWH6424	322	396	432	468	504	540	576	612	648	684	720	756	792	864
59	58 x .75 x 24	FTWH5824	294	359	391	423	455	487	519	551	583	615	647	679	711	775
48	47 x .75 x 24	FTWH4724	236	291	318	345	372	399	426	453	480	507	534	561	588	642
36	35 x .75 x 24	FTWH3524	176	217	237	257	277	297	317	337	357	377	397	417	437	477
30	29 x .75 x 24	FTWH2924	142	179	196	213	230	247	264	281	298	315	332	349	366	400

Standard Features

- Constructed of .5" thick fiberboard
- Fabric is precisely aligned and fitted to the tackboard
- Adhered to the rigid hardboard with staples

- Hung with Z-Strip mounting system

Wall hung tackboards Half width tackboards

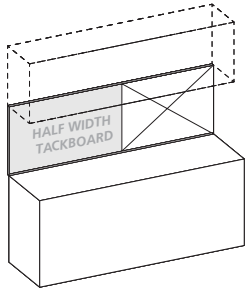

Product Width	Panel Dimension	SKU	COM	1	2	3	4	5	6	7	8	9	10	11/L1	12	13/L2
94 Half Width	46.5 x .75 x 24	FTWH4624	233	288	313	338	363	388	413	438	463	488	513	538	563	613
88 Half Width	43.5 x .75 x 24	FTWH4324	225	270	294	318	342	366	390	414	438	462	486	510	534	582
84 Half Width	41.5 x .75 x 24	FTWH4124	211	257	280	303	326	349	372	395	418	441	464	487	510	556
77 Half Width	38 x .75 x 24	FTWH3824	194	235	256	277	298	319	340	361	382	403	424	445	466	508
71 Half Width	35 x .75 x 24	FTWH3524	178	217	237	257	277	297	317	337	357	377	397	417	437	477
65 Half Width	32 x .75 x 24	FTWH3224	161	198	216	234	252	270	288	306	324	342	360	378	396	432

Standard Features

- Constructed of .5" thick fiberboard
- Fabric is precisely aligned and fitted to the tackboard
- Adhered to the rigid hardboard with staples
- Hung with Z-Strip mounting system

Notes

- Half width tackboards can be specified and combined with a Veneer Panel, Marker Board, Slat Wall or Glass Board. See "Half Width" items under product width.
- Specify right or left facing tackboard

DARRAN®

Wall hung dry marker board
Full width dry marker board

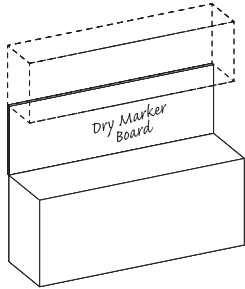

Product Width	Panel Dimension	SKU	List
94	93 x .75 x 24	DMWH9324	1161
88	87 x .75 x 24	DMWH8724	1086
84	83 x .75 x 24	DMWH8324	1023
77	76 x .75 x 24	DMWH7624	948
71	70 x .75 x 24	DMWH7024	874
65	64 x .75 x 24	DMWH6424	799
59	58 x .75 x 24	DMWH5824	724
48	47 x .75 x 24	DMWH4724	587
36	35 x .75 x 24	DMWH3524	437
30	29 x .75 x 24	DMWH2924	362

Standard Features

- Dry marker panel has edge trim molding
- Standard magnetic surface
- Hung with Z-Strip mounting system

Wall hung dry marker board
Half width dry marker board

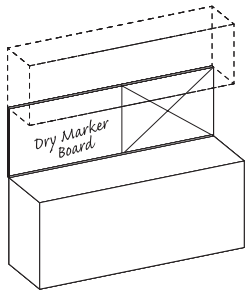

Product Width	Panel Dimension	SKU	List
94 Half Width	46.5 x .75 x 24	DMWH4624	580
88 Half Width	43.5 x .75 x 24	DMWH4324	543
84 Half Width	41.5 x .75 x 24	DMWH4124	518
77 Half Width	38 x .75 x 24	DMWH3824	474
71 Half Width	35 x .75 x 24	DMWH3524	437
65 Half Width	32 x .75 x 24	DMWH3224	399

Standard Features

- Dry marker panel has edge trim molding
- Standard magnetic surface
- Hung with Z-Strip mounting system

Notes

- Half width dry marker boards can be specified and combined with a Tackboard, Veneer Panel, Slat Wall or Glass Board. See "Half Width" items under product width.
- Specify right or left facing dry marker board

DARRAN®

Wall hung veneer panel
Full width veneer panel

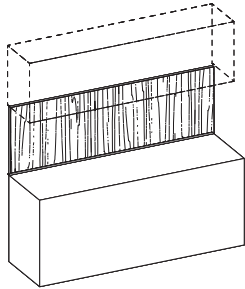

Product Width	Panel Dimension	SKU	List
94	93 x .75 x 24	VPWH9324	967
88	87 x .75 x 24	VPWH8724	905
84	83 x .75 x 24	VPWH8324	853
77	76 x .75 x 24	VPWH7624	790
71	70 x .75 x 24	VPWH7024	728
65	64 x .75 x 24	VPWH6424	666
59	58 x .75 x 24	VPWH5824	603
48	47 x .75 x 24	VPWH4724	489
36	35 x .75 x 24	VPWH3524	364
30	29 x .75 x 24	VPWH2924	302

Standard Features

- Veneer edges

Notes

- Vertical wire channels on back for task light cords
- Steel mounting wall channel is recessed for flush mounting
- Hung with Z-Strip mounting system
- Can be used with or without overhead cabinet
- Required for other accessory panels

Wall hung veneer panel
Half width veneer panel

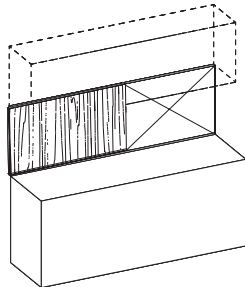

Product Width	Panel Dimension	SKU	List
94 Half Width	46.5 x .75 x 24	VPWH4624	484
88 Half Width	43.5 x .75 x 24	VPWH4324	452
84 Half Width	41.5 x .75 x 24	VPWH4124	432
77 Half Width	38 x .75 x 24	VPWH3824	395
71 Half Width	35 x .75 x 24	VPWH3524	364
65 Half Width	32 x .75 x 24	VPWH3224	333

Standard Features

- Veneer edges
- Vertical wire channels on back for task light cords
- Steel mounting wall channel is recessed for flush mounting
- Hung with Z-Strip mounting system

Notes

- Half width veneer panels can be specified and combined with a Tackboard, Marker Board, Slat Wall or Glass Board. See "Half Width" items under product width.
- Specify right or left facing veneer panel
- Can be used with or without overhead cabinet.
- Required for other accessory panels.

DARRAN®

Wall hung glassboard Full width glassboards

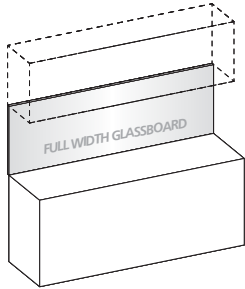

Product Width	Panel Dimension	SKU	List
94	93 x .75 x 24	GBWH9324	2753
88	87 x .75 x 24	GBWH8724	2586
84	83 x .75 x 24	GBWH8324	2475
77	76 x .75 x 24	GBWH7624	2281
71	70 x .75 x 24	GBWH7024	2114
65	64 x .75 x 24	GBWH6424	1948
59	58 x .75 x 24	GBWH5824	1780
48	47 x .75 x 24	GBWH4724	1476
36	35 x .75 x 24	GBWH3524	1142
30	29 x .75 x 24	GBWH2924	976

Standard Features

- 4 mm tempered glass

Notes

- Earth magnets are required to hold items securely in place
- Hung with Z-Strip mounting system
- Use glass cleaner or alcohol to clean
- Standard dry erase markers may be used

Wall hung glassboard Half width glassboards

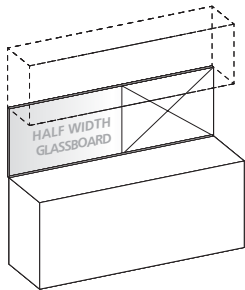

Product Width	Panel Dimension	SKU	List
94 Half Width	46.5 x .75 x 24	GBWH4624	1461
88 Half Width	43.5 x .75 x 24	GBWH4324	1378
84 Half Width	41.5 x .75 x 24	GBWH4124	1323
77 Half Width	38 x .75 x 24	GBWH3824	1232
71 Half Width	35 x .75 x 24	GBWH3524	1142
65 Half Width	32 x .75 x 24	GBWH3224	1059

Standard Features

- 4 mm tempered glass

Notes

- Half width glassboards can be specified and combined with a Tackboard, Veneer panel, Marker Board or Slat Wall. See "Half Width" items under product width.
- Specify right or left facing glassboard
- Use glass cleaner or alcohol to clean
- Standard dry erase markers may be used
- Earth magnets are required to hold items securely in place
- Hung with Z-Strip mounting system

DARRAN®

Wall hung slat wall
Half width slat wall

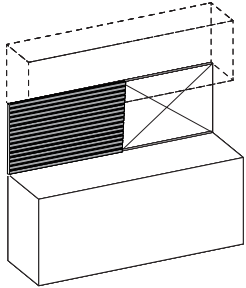

Product Width	Panel Dimension	SKU	List
94 Half Width	46.5 x .75 x 24	SWWH4624	484
88 Half Width	43.5 x .75 x 24	SWWH4324	452
84 Half Width	41.5 x .75 x 24	SWWH4124	432
77 Half Width	38 x .75 x 24	SWWH3824	395
71 Half Width	35 x .75 x 24	SWWH3524	364
65 Half Width	32 x .75 x 24	SWWH3224	333

Standard Features

- Available in silver or black
- Hung with Z-Strip mounting system

Notes

- Half width slat walls can be specified and combined with a Tackboard, Veneer panel, Marker Board or Glassboard. See "Half Width" items under product width.
- Specify right or left facing slat wall
- For use on 42"/43" height consoles

Prado

Ganging - Overhead Tower - Panel Doors
Wardrobe / Storage

[Click here to view statement of line](#)

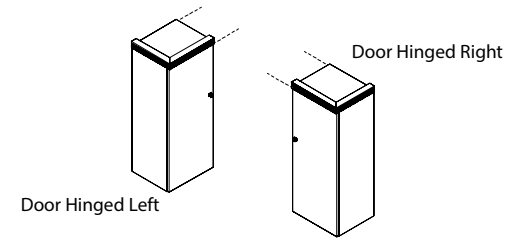

1 Select Model

w" x d" x h"	Weight
Hinged Left	
17.5 x 15 x 44	100
14.5 x 15 x 44	85
Hinged Right	
17.5 x 15 x 44	100
14.5 x 15 x 44	85

	Standard Veneer Top Standard Veneer Chassis	Premium Veneer Top Premium Veneer Chassis	High Pressure Laminate Top Veneer Chassis	Thermally Fused Laminate Top Thermally Fused Laminate Chassis
	PRA1744OH340W 2805	"P" Option N/A	"G" Option N/A	"M" Option N/A
	PRA1444OH340W 2724	"P" Option N/A	"G" Option N/A	"M" Option N/A
	PRA1744OH341W 2805	"P" Option N/A	"G" Option N/A	"M" Option N/A
	PRA1444OH341W 2724	"P" Option N/A	"G" Option N/A	"M" Option N/A

Product Features

- 3/4" Veneer adjustable shelves
- 2 Adjustable shelves
- Flush on one end so you can gang with overhead consoles/overhead bookcase hutches
- Interior shelf depth 12"
- Prices include ganging mitre fit as specified

Notes

- Ganged Units Must Be Clearly Noted As To Individual Unit Locations
- Unit has black back panel and is not designed for Open Plan use. Select OPB Option for Open Plan application

Options

Door

- D2: Door lock - \$100 per door
- D6: Delete Doors - n/c
- D9SC: Soft Close Door Hinges - \$20 per door

Molding

- DSM1: Delete Dentil Molding Only - n/c

Open Plan _ Finished Back

- OPB: "W" "G" Style - Modify Unit for Open Plan Application - \$395

2 Select Finish

[Click to view finishes](#)

- WAC
- WIC
- WHC
- WOC
- WEW
- WGW
- WBW
- WSW
- WNW

3 Select Edge

[Click to view edges](#)

- Edge
- N/A

4 Select Hardware

[Click to view details](#)



DK-125 Antique Pewter
DK-126 Antique English
DK-127 Matte Black

Prado

Overhead Tower
Ganging Wardrobe / Leaded/Beveled Glass Doors

[Click here to view statement of line](#)

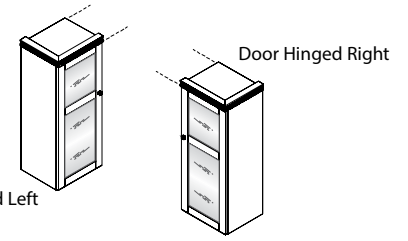

1 Select Model

w" x d" x h"
Hinged Left
17.5 x 15 x 44
14.5 x 15 x 44
Hinged Right
17.5 x 15 x 44
14.5 x 15 x 44

Weight	Standard Veneer Top Standard Veneer Chassis	Premium Veneer Top Premium Veneer Chassis	High Pressure Laminate Top Veneer Chassis	Thermally Fused Laminate Top Thermally Fused Laminate Chassis
100	PRA1744OH342W 3131	"P" Option N/A	"G" Option N/A	"M" Option N/A
85	PRA1444OH342W 3048	"P" Option N/A	"G" Option N/A	"M" Option N/A
100	PRA1744OH343W 3131	"P" Option N/A	"G" Option N/A	"M" Option N/A
85	PRA1444OH343W 3048	"P" Option N/A	"G" Option N/A	"M" Option N/A

2 Select Finish

[Click to view finishes](#)

WAC
WIC
WHC
WOC
WEW
WGW
WBW
WSW
WNW

3 Select Edge

[Click to view edges](#)

Edge
N/A

4 Select Hardware

[Click to view details](#)



Product Features

- 3/4" Veneer adjustable shelves
- 2 Adjustable shelves
- Flush on one end so you can gang with overhead consoles/overhead bookcase hutches
- Interior shelf depth 12"
- Prices include ganging mitre fit as specified
- Solid wood door frame

Notes

- Ganged Units Must Be Clearly Noted As To Individual Unit Locations
- Unit has black back panel and is not designed for Open Plan use. Select OPB Option for Open Plan application

Options

Door

- D2: Door lock - \$100 per door
- D9SC: Soft Close Door Hinges - \$20 per door
- D35: Replace glass panel insert with veneer panel insert - \$35 per door

Interior Cabinet Lighting

- LEDPK starter kit includes Infeed, 1 Puck Interior Light and the ability to daisy chain up to 6 total Puck Lights
- LEDPK: LED Puck Starter Kit - \$310
- PK: 1 LED Interior Light - \$130

Molding

- DSM1: Delete Dentil Molding Only - n/c

Open Plan _ Finished Back

- OPB: "W" "G" Style - Modify Unit for Open Plan Application - \$395

Shelf

- GS14H: Replace Standard Shelves with Glass Shelves - \$90 per shelf

Prado

Overhead Bookcase Hutches Bookcase/Hutch Overhead

[Click here to view statement of line](#)

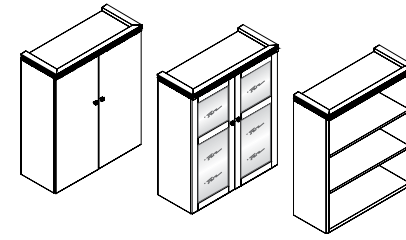

1 Select Model

w" x d" x h"	Weight
Panel Door	
36 x 15 x 44	130
30 x 15 x 44	125
Leaded/Beveled Glass Doors	
36 x 15 x 44	120
30 x 15 x 44	115
Open Bookcase	
36 x 15 x 44	100
30 x 15 x 44	90

	Standard Veneer Top Standard Veneer Chassis	Premium Veneer Top Premium Veneer Chassis	High Pressure Laminate Top Veneer Chassis	Thermally Fused Laminate Top Thermally Fused Laminate Chassis
		"P" Option N/A	"G" Option N/A	"M" Option N/A
		"P" Option N/A	"G" Option N/A	"M" Option N/A
		"P" Option N/A	"G" Option N/A	"M" Option N/A
		"P" Option N/A	"G" Option N/A	"M" Option N/A
		"P" Option N/A	"G" Option N/A	"M" Option N/A
		"P" Option N/A	"G" Option N/A	"M" Option N/A

Product Features

- 2" Top cornice frame with dentil molding
- 2 Adjustable shelves
- Interior shelf depth 12"
- Prices include ganging mitre fit as specified

Notes

- Unit has black back panel and is not designed for Open Plan use. Select OPB Option for Open Plan application

Options

- Door**
- D2: Door lock - \$100 per door
 - D6: Delete Doors - n/c
 - D9SC: Soft Close Door Hinges - \$20 per door
 - D35: Replace glass panel insert with veneer panel insert - \$35 per door
- Flush Cut**
- FC-B: Flush Unit Both Sides(Facing) for Ganging - \$100
 - FC-R: Flush Unit Right(Facing) for Ganging - \$100
 - FC-L: Flush Unit Left (Facing) for Ganging - \$100
- Interior Cabinet Lighting**
- LEDPK starter kit includes Infeed, 1 Puck Interior Light and the ability to daisy chain up to 6 total Puck Lights
- LEDPK: LED Puck Starter Kit - \$310
 - PK: 1 LED Interior Light - \$130
- Molding**
- DSM1: Delete Dentil Molding Only - n/c
- Open Plan _ Finished Back**
- OPB: "W" "G" Style - Modify Unit for Open Plan Application - \$395
- Shelf**
- GS14F: Replace Standard Shelves with Glass Shelves - \$90 per shelf
 - S714F: Replace Standard Shelf with Heavy Duty Lumber 1" Shelf - \$80 per shelf ("M" Styles - n/a)

2 Select Finish

- [Click to view finishes](#)
- WAC
 - WIC
 - WHC
 - WOC
 - WEW
 - WGW
 - WBW
 - WSW
 - WNW

3 Select Edge

- [Click to view edges](#)
- Edge
 - N/A

4 Select Hardware

- [Click to view details](#)
- DK-125 Antique Pewter
 - DK-126 Antique English
 - DK-127 Matte Black

Prado

Half Towers

Ganging Vertical Wardrobe Panel Door

[Click here to view statement of line](#)

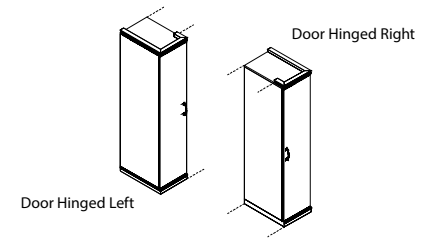

1 Select Model

w" x d" x h"
 Hinged Left
 16 x 24 x 73
 Hinged Right
 16 x 24 x 73

Weight	Standard Veneer Top Standard Veneer Chassis	Premium Veneer Top Premium Veneer Chassis	High Pressure Laminate Top Veneer Chassis	Thermally Fused Laminate Top Thermally Fused Laminate Chassis
--------	--	--	--	--

170
170

PRA1673TW283W 3855
 PRA1673TW284W 3855

"P" Option N/A
 "P" Option N/A

"G" Option N/A
 "G" Option N/A

"M" Option N/A
 "M" Option N/A

2 Select Finish

[Click to view finishes](#)

- WAC
- WIC
- WHC
- WOC
- WEW
- WGW
- WBW
- WSW
- WNW

3 Select Edge

[Click to view edges](#)

Edge
N/A

4 Select Hardware

[Click to view details](#)

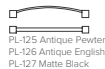

Product Features

- Hardwood base/cornice/dentil molding
- Prices include ganging mitre fit as specified
- Wardrobe w/ coat rod & hook

Notes

- Unit has black back panel and is not designed for Open Plan use. Select OPB Option for Open Plan application
- Flush on one end so you can gang with overhead consoles / overhead bookcase hutches

Options

Door

- D2: Door lock - \$100 per door
- D6: Delete Doors - n/c
- D9SC: Soft Close Door Hinges - \$20 per door

Freestanding

- FREE-ST: unit for freestanding use - \$105

Molding

- DSM1: Delete Dentil Molding Only - n/c

Open Plan _ Finished Back

- OPB: "W" "G" Style - Modify Unit for Open Plan Application - \$395

Prado

Vertical Full Tower

Freestanding Panel Door - Wardrobe / Storage

[Click here to view statement of line](#)

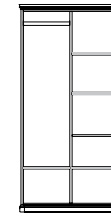
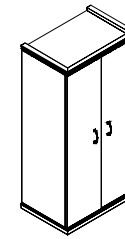

1 Select Model

w" x d" x h"	Weight
36 x 24 x 73	350
30 x 24 x 73	315

Standard Veneer Top Standard Veneer Chassis		Premium Veneer Top Premium Veneer Chassis	High Pressure Laminate Top Veneer Chassis	Thermally Fused Laminate Top Thermally Fused Laminate Chassis
--	--	--	--	--

PRA3673TW275W	6612	"P" Option N/A	"G" Option N/A	"M" Option N/A
PRA3073TW275W	6453	"P" Option N/A	"G" Option N/A	"M" Option N/A

Product Features

- 3 Adjustable shelves, 1 fixed
- Hardwood base/cornice/dentil molding
- Prices include ganging mitre fit as specified
- Wardrobe w/ coat rod & hook

Notes

- Unit has black back panel and is not designed for Open Plan use. Select OPB Option for Open Plan application
- Ganging: Factory modified cornice top & base to fit specified ganging locations

Options

Door

- D2: Door lock - \$100 per door
- D6: Delete Doors - n/c
- D9SC: Soft Close Door Hinges - \$20 per door

Delete Center Partition

- MOD31: Delete Center Partition / Add (3) Full Width Adj. Shelves & (1) Fixed - \$295

Flush Cut

- FC-B: Flush Unit Both Sides(Facing) for Ganging - \$100
- FC-R: Flush Unit Right(Facing) for Ganging - \$100
- FC-L: Flush Unit Left (Facing) for Ganging - \$100

Molding

- DSM1: Delete Dentil Molding Only - n/c

Open Plan _ Finished Back

- OPB: "W" "G" Style - Modify Unit for Open Plan Application - \$395

2 Select Finish

[Click to view finishes](#)

- WAC
- WIC
- WHC
- WOC
- WEW
- WGW
- WBW
- WSW
- WNW

3 Select Edge

[Click to view edges](#)

Edge
N/A

4 Select Hardware

[Click to view details](#)

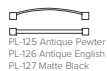

Prado

Vertical Full Tower
Freestanding File / Wardrobe - Panel Door

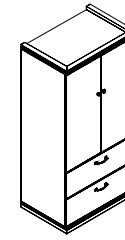

[Click here to view statement of line](#)

1 Select Model

w" x d" x h"	Weight
36 x 24 x 73	360
30 x 24 x 73	325

Standard Veneer Top Standard Veneer Chassis		Premium Veneer Top Premium Veneer Chassis	High Pressure Laminate Top Veneer Chassis	Thermally Fused Laminate Top Thermally Fused Laminate Chassis
--	--	--	--	--

PRA3673TW281W	7100	"P" Option N/A	"G" Option N/A	"M" Option N/A
PRA3073TW281W	6937	"P" Option N/A	"G" Option N/A	"M" Option N/A

Product Features

- 3 Adjustable shelves, 1 fixed
- Can be ganged to 15" or 24" deep towers
- Hardwood base/cornice/dentil molding
- Features ball bearing suspensions, suspensions are full extension
- Wardrobe w/ coat rod & hook

Notes

- Unit has black back panel and is not designed for Open Plan use. Select OPB Option for Open Plan application
- Ganging: Factory modified cornice top & base to fit specified ganging locations

Options

Door

- D2: Door lock - \$100 per door
- D6: Delete Doors - n/c
- D9SC: Soft Close Door Hinges - \$20 per door

Delete Center Partition

- MOD30: Delete Center Partition / Add (2) Full Width Adj. Shelves - \$295
- When deleting Center partition (1) D2 Door lock should be specified.

Flush Cut

- FC-B: Flush Unit Both Sides(Facing) for Ganging - \$100
- FC-R: Flush Unit Right(Facing) for Ganging - \$100
- FC-L: Flush Unit Left (Facing) for Ganging - \$100

Molding

- DSM1: Delete Dentil Molding Only - n/c

Open Plan _ Finished Back

- OPB: "W" "G" Style - Modify Unit for Open Plan Application - \$395

2 Select Finish

[Click to view finishes](#)

- WAC
- WIC
- WHC
- WOC
- WEW
- WGW
- WBW
- WSW
- WNW

3 Select Edge

[Click to view edges](#)

Edge
N/A

4 Select Hardware

[Click to view details](#)

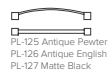

Prado

Vertical Full Tower Wardrobe / File / Storage
Freestanding Panel Door

[Click here to view statement of line](#)

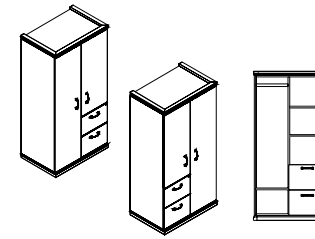

1 Select Model

w" x d" x h"
Wardrobe Left
36 x 24 x 73
Wardrobe Right
36 x 24 x 73

Weight	Standard Veneer Top Standard Veneer Chassis	Premium Veneer Top Premium Veneer Chassis	High Pressure Laminate Top Veneer Chassis	Thermally Fused Laminate Top Thermally Fused Laminate Chassis
--------	--	--	--	--

350
350

PRA3673TW273W 7100
PRA3673TW274W 7100

"P" Option N/A
"P" Option N/A

"G" Option N/A
"G" Option N/A

"M" Option N/A
"M" Option N/A

2 Select Finish

[Click to view finishes](#)

- WAC
- WIC
- WHC
- WOC
- WEW
- WGW
- WBW
- WSW
- WNW

3 Select Edge

[Click to view edges](#)

Edge
N/A

4 Select Hardware

[Click to view details](#)



Product Features

- 2 Adjustable shelves, 1 fixed
- Full extension drawers - locking
- Hardwood base/cornice/dentil molding
- Wardrobe w/ coat rod & hook

Notes

- Unit has black back panel and is not designed for Open Plan use. Select OPB Option for Open Plan application

Options

Door

- D2: Door lock - \$100 per door
- D6: Delete Doors - n/c
- D9SC: Soft Close Door Hinges - \$20 per door

Drawers

- P6: Modify File/File to Box/Box/File - \$55 per pedestal

Molding

- DSM1: Delete Dentil Molding Only - n/c

Open Plan _ Finished Back

- OPB: "W" "G" Style - Modify Unit for Open Plan Application - \$395

Flush Cut

- FC-B: Flush Unit Both Sides(Facing) for Ganging - \$100
- FC-R: Flush Unit Right(Facing) for Ganging - \$100
- FC-L: Flush Unit Left (Facing) for Ganging - \$100

Prado

Bookcases
Freestanding Open Bookcases

[Click here to view statement of line](#)

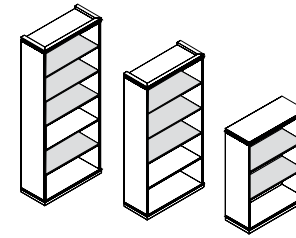

1 Select Model

w" x d" x h"	Weight
30" Width	
30 x 15 x 85	165
30 x 15 x 73	160
30 x 15 x 50	110
36" Width	
36 x 15 x 85	185
36 x 15 x 73	180
36 x 15 x 50	120

	Standard Veneer Top Standard Veneer Chassis	Premium Veneer Top Premium Veneer Chassis	High Pressure Laminate Top Veneer Chassis	Thermally Fused Laminate Top Thermally Fused Laminate Chassis
		"P" Option N/A	"G" Option N/A	"M" Option N/A
		"P" Option N/A	"G" Option N/A	"M" Option N/A
		"P" Option N/A	"G" Option N/A	"M" Option N/A
		"P" Option N/A	"G" Option N/A	"M" Option N/A
		"P" Option N/A	"G" Option N/A	"M" Option N/A
		"P" Option N/A	"G" Option N/A	"M" Option N/A

Product Features

- Hardwood base/cornice/dentil molding
- Interior shelf depth 12"
- "W" styles - 50" H units finished top, 73", 85" H units black painted top

Notes

- Adjustable shelves are shaded
- Unit has black back panel and is not designed for Open Plan use. Select OPB Option for Open Plan application

Options

Flush Cut

- FC-B: Flush Unit Both Sides(Facing) for Ganging - \$100
- FC-R: Flush Unit Right(Facing) for Ganging - \$100
- FC-L: Flush Unit Left (Facing) for Ganging - \$100

Interior Cabinet Lighting

- LEDPK starter kit includes Infeed, 1 Puck Interior Light and the ability to daisy chain up to 6 total Puck Lights
- LEDPK: LED Puck Starter Kit - \$310
- PK: 1 LED Interior Light - \$130

Molding

- DSM1: Delete Dentil Molding Only - n/c

Open Plan _ Finished Back

- OPB: "W" "G" Style - Modify Unit for Open Plan Application - \$395

Shelf

- GS14F: Bookcase glass shelf 29" -35" - \$90 Each
- S714F: Heavy Duty Lumber Core Shelves (Replaces Std. Shelves) - \$80 per shelf

2 Select Finish

Click to view finishes	WAC
	WIC
	WHC
	WOC
	WEW
	WGW
	WBW
	WSW
	WNW

3 Select Edge

Click to view edges	Edge
	N/A

4 Select Hardware

Click to view details	Hardware
	N/A



COMPUTER SUPPORT
single monitor arm

Style Number	List Price
MA1	280

Specifications

- Available in black or silver
- Desk clamp and mounting included
- Easy assembly and flexibility
- Elastic painting process for a durable and beautiful finish
- Gas spring tension adjustment for counter-balance height adjustment for monitors 1-8 KG
- Gas spring tested to 50,000 repetitions
- Hidden cable management



COMPUTER SUPPORT
double monitor arm

Style Number	List Price
MA2	450

Specifications

- Available in black or silver
- Desk clamp and mounting included
- Easy assembly and flexibility
- Elastic painting process for a durable and beautiful finish
- Gas spring tension adjustment for counter-balance height adjustment for monitors 1-8 KG
- Gas spring tested to 50,000 repetitions
- Hidden cable management



COMPUTER SUPPORT
triple monitor arm

Style Number	List Price
MA3	530

Specifications

- Available in black or silver
- Desk clamp and mounting included
- Easy assembly and flexibility
- Elastic painting process for a durable and beautiful finish
- Gas spring tension adjustment for counter-balance height adjustment for monitors 1-8 KG
- Gas spring tested to 50,000 repetitions
- Hidden cable management



COMPUTER SUPPORT
quadruple monitor arm

Style Number	List Price
MA4	705

Specifications

- Available in black
- Desk clamp and mounting included
- Easy assembly and flexibility
- Elastic painting process for a durable and beautiful finish
- Gas spring tension adjustment for counter-balance height adjustment for monitors 1-8 KG
- Gas spring tested to 50,000 repetitions
- Hidden cable management

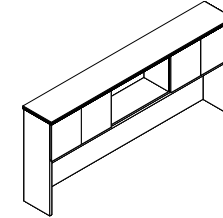
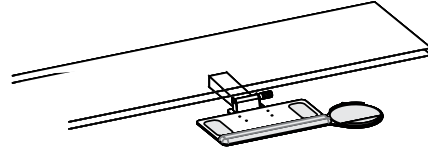
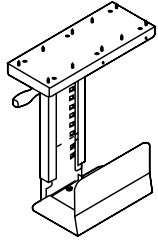

COMPUTER SUPPORT
cpu retractable cradle

COMPUTER SUPPORT
articulating keyboard tray

DOOR MODIFICATIONS
soft close door hinge

DOOR MODIFICATIONS
delete doors

Style Number	List Price
K18	205

Style Number	List Price
Factory Installed	
K28	395
Field Installed	
K28F	415

Style Number	List Price
D9SC	20 Per door

Style Number	List Price
D6	N/C

Specifications

- Black Metal CPU Carriage
- Full 360° swivel capability allows easy access to rear of CPU for cables / wires
- Track allows 8- 1/2" extension
- Width Adjustment 5-1/2" to 9-1/4"
- Height adjustment 14- 5/8" to 20- 1/2"
- Black epoxy finish

Notes
- Factory Installed

Specifications

- Adjusts effortlessly - A simple one-handed motion allows the keyboard to be repositioned instantly, without the use of locks or levers
- Encourages low-risk postures - Maximizes adjustability within a safe operating range.
- Will last a lifetime - Exceeds all applicable BIFMA Standards and comes with a lifetime guarantee.

Notes
- Available on: Freestanding Desk
- Factory Installed (standard)
- FIELD INSTALL - \$415

Specifications

- Snap onto standard door hinge
- Requires (2) per door
- Max door height 43"
- Factory installed where specified
- Individually shipped for field installation

Notes
- Specify Each Item To Have Slow Close Feature

Specifications

- Standard Door overheads and cabinets can have door deleted for open access. Modification of hinge rails and structural components are made face ready.

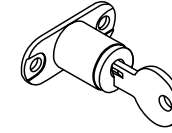
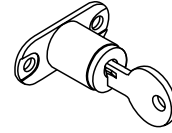
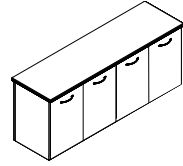
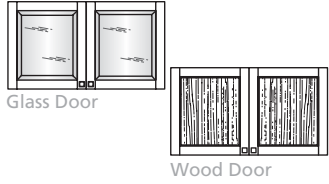

DOOR MODIFICATIONS
replace glass panel insert with veneer panel insert

DOOR MODIFICATIONS
delete doors/replace

DOOR MODIFICATIONS
panel door lock

DOOR MODIFICATIONS
glass door lock

Style Number	List Price
D35	35 Per door

Style Number	List Price
D6A	

Style Number	List Price
D2	100 Per door set

Style Number	List Price
D2-G	205 Per door set

Specifications

- Replace glass panel insert with veneer panel insert

Notes

- Not Available on "M" skus
- Glass door has beveled glass
- Wood door w/ veneer insert - only available on "W" style

Specifications

- Delete doors

Notes

- Available on: All Storage "W"/"G" Style Credenzas.

Specifications

- Door Locks - 1 Door w/ Lock, Other Door w/ Catch Latch
- Contact Customer Service regarding limited lock locations and keying.

Notes

- Available on: Panel Doors, Wood Frame Doors, and Silverluma doors

Specifications

- Door Locks - 1 Door w/ Lock, Other Door w/ Catch Latch
- Contact Customer Service regarding limited lock locations and keying.

Notes

- Available on: Glass Doors

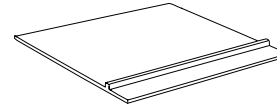
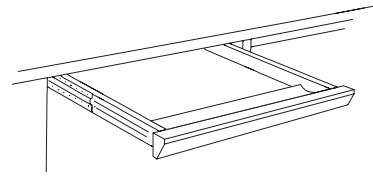
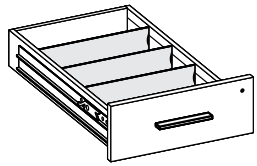

DRAWER OPTIONS
box drawer accessories

Style Number	List Price
Wood Drawer Dividers w/ Clips K-DIV	SET OF 3 - 30
Single Tray - Utility Tray K-Sut	35 ea.

DRAWER OPTIONS
prado center drawer - veneer bottom

Style Number	List Price
Factory Installed K1	290
Field Installed KIF	290

DRAWER OPTIONS - BOTTOM COVER
felt bottom center drawer insert liner

Style Number	List Price
K3	100

GLASSBOARD ACCESSORIES
glassboard accessory kit

Style Number	List Price
GBKIT	290

Specifications

- K-DIV Extra Wood Drawer Dividers with Clips, Top Box drawers standard with 1 divider
- K-SUT Single Tray - Utility Tray, Specify Legal or Letter drawer width

Specifications

- Ball bearing smooth operation
- Drawer has lifetime guarantee
- Solid hardwood front
- Standard with matching wood grain pencil tray

Specifications

- Inserts into center drawer and features divider for open pen and pencil storage. Removable for easy cleaning.
- Adds a luxurious touch to center drawers.
- Color: Dark Brown Coal

Specifications

- 8 Earth magnets, 1 magnetic marker cup holder and 1 magnetic dry eraser

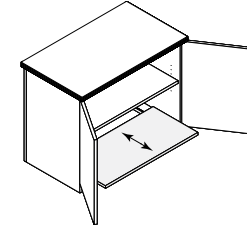
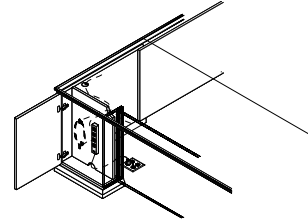
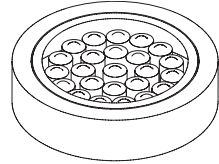

TASK LIGHTING
lt-led task light

Style Number	List Price
24" Task light LT-LED24	215
48" Task light LT-LED48	270
60" Task light LT-LED60	335
72" Task light LT-LED72	360

Specifications

- 6.5' Power cord. Switch with touch dimmer
- 36 LEDs per foot
- 4.6 Watts per foot
- 91 Lumens per watt
- Please note when ganging.
- Overhead tasklight cord is located on the right facing side. If the opposite location is required please contact customer service.

LIGHTING
led interior cabinet puck light

Style Number	List Price
Starter Kit LEDPK	310
1 LED Interior Puck Light PK	130

Specifications

- Starter kit includes Infeed, 1 Puck Interior Light and the ability to daisy chain up to 6 total Puck Lights
- (1) LED Puck Light with 30W power drive and switch
- Recessed fixture
- 12V linking cord 98"L
- Silver finish
- 50,000 hour life
- 2 watt per light

Notes

- Available on: Overhead/Tower Units with glass doors or no doors
- Power drive included, Light only

PEDESTAL MODIFICATIONS
breakfront pedestal with wire management cavity door

Style Number	List Price
PC10 Power Supply Cordset PD717	100
	100

Specifications

- Hinged pedestal front door offers easy access for wire management
- Wire hooks provide wire coil storage
- Wire access openings allow access to floor, cabinets interior and kneespace
- Cabinet interior is black finish
- Top grommet is positioned over cavity for access ease
- (Power Strip Optional)

Notes

- Breakfront Chassis Only

PEDESTAL MODIFICATIONS
black laminate printer pullout bottom shelf

Style Number	List Price
PPOS	225

Specifications

- Black Laminate pullout shelf on suspension
- Black grommet
- Adjustable Shelf

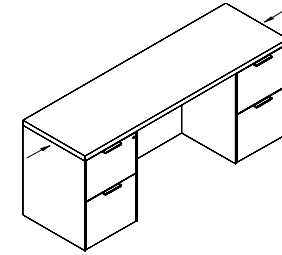
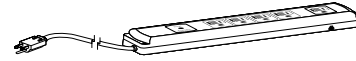
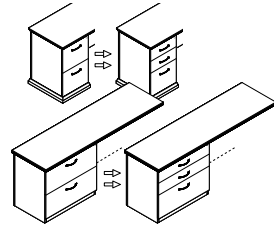
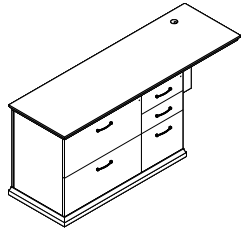

PEDESTAL MODIFICATIONS
add veneer kneespace cabinets - base

Style Number	List Price
Add Box/Box/File or File/File P40B	1025
Add Lateral File 29" W P41B	1255
Add Multi-File - 31"W P42B	1255
Add Storage With Doors 29"W P43B	1140
Add CPU /Printer Cabinet - Open P44B	1140

Specifications

- Multi-file specify Box/Box Left or Right

Notes

- Add additional Standard Cabinets To Kneespace Area.

PEDESTAL MODIFICATIONS
modify drawer configurations

Style Number	List Price
File/File to Box/Box/File P6	55 Per ped
Box/Box/File to File/File P6	55 Per ped
Lateral File to 2 Box Drawers P8	100 Per ped

Specifications

- Modify File/File To Box/Box/File - Any Unit

POWER / DATA
power supply cordset

Style Number	List Price
PD717	100

Specifications

- SIZE: 10.75"L x 2.0"W x 1.06"H
- (5) Outlets w/ 10' cord
- Surge suppression (720 Joules)
- 15 Amp breaker
- Available on: Vertical Panels, Cabinet Interiors, and under tops

PRODUCT MODIFICATIONS
modify width - open kneespace

Style Number	List Price
MOD-1	125

Specifications

- Modify width down on any unit with an open kneespace: desk, workstation credenza, bridge, return

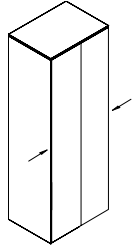

PRODUCT MODIFICATIONS
 modify width - open/closed storage

Style Number	List Price
MOD-2	250

Specifications

- Modify width down on any unit with open or closed storage section: overheads, wall hung units, storage credenzas, towers

PRODUCT MODIFICATIONS
 modify width - outside of mod-1, mod-2

Style Number	List Price
MOD-3	Contact for pricing

Specifications

- Width modification outside of MOD-1 & MOD-2

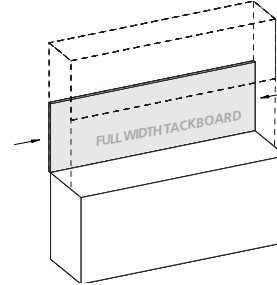

PRODUCT MODIFICATIONS
 modify width - tackboard, slat wall, veneer panel, or a glassboard

Style Number	List Price
MOD-4	50

Specifications

- Modify width down on tackboard, slat wall, veneer panel, or a overhead glassboard

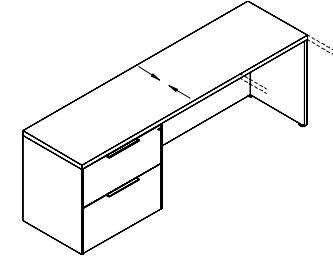

PRODUCT MODIFICATIONS
 modify depth - decrease depth

Style Number	List Price
MOD-5	125

Specifications

- Modify depth down (minimum depth for a unit with drawers is 21"D)

Notes
 - Ex. 24" to 21", 30" to 24", and 36" to 30"

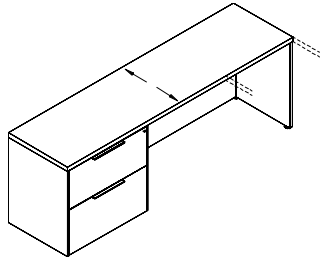

PRODUCT MODIFICATIONS
modify depth - increase depth

Style Number	List Price
MOD-6	Add 10%

Specifications

- Increase depth by no more than 6"

Notes

- Ex. 24" to 30", 30" to 36", and 36" to 42"
- Add 10% to the unit you want to increase the depth of by no more than 6"

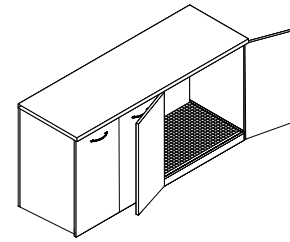

REFRIGERATOR MODIFICATION
refrigerator cabinet modification

Style Number	List Price
REF01	205

Specifications

- Open back cutout for venting
- Moisture sponge mat
- Contaminate ledge
- Contact customer service for maximum refrigerator size (Changes based on unit).

Notes

- Available on: 36" and 42" Storage Credenzas

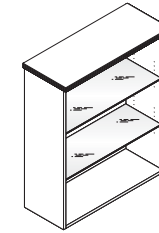

SHELF MODIFICATIONS
glass shelves - tempered full width
26" - 35"

Style Number	List Price
26"W - 35"W x 14"D Shelf GS14F	90

Specifications

- Glass Shelves Replace Wood Shelf In Open Or Glass Door Cabinet. Also Order Interior Cabinet Lighting.

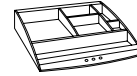
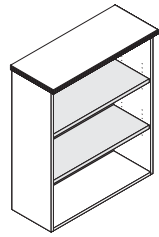
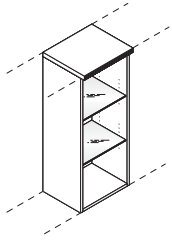

SHELF MODIFICATIONS
tempered glass shelves for half cabinet 17- 1/2" widths

Style Number	List Price
14-1/2"W - 17- 1/2"W x 14"D Shelf GS14H	70 ea.

SHELF MODIFICATIONS
heavy duty solid wood bookcase replacement shelves

Style Number	List Price
1" Wood Shelf 14" Deep S714F	80 ea.
1" Wood Shelf 24" Deep S714FX	160 ea.

SLAT WALL ACCESSORIES
slat wall accessory tray

Style Number	List Price
SWA9	50

SLAT WALL ACCESSORIES
slat wall folder tray

Style Number	List Price
SWA7	50

Specifications

- Glass Shelves Replace Wood Shelf In Open Or Glass Door Cabinet. Also Order Interior Cabinet Lighting.

Notes

- Replace only adjustable shelves between cabinet light and fixed lower wood shelf.

Specifications

- 1" Solid Lumber Core Shelves Replace Standard 3/4" Plywood Adjustable And Fixed Shelves

Specifications

- Specify Black Or Matte Silver

Specifications

- Specify Black Or Matte Silver

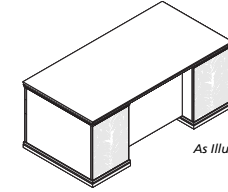
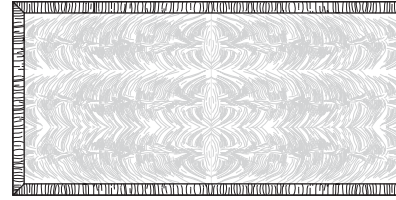
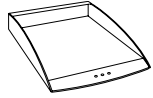

As Illustrated: (2) FCC1

Desk Approach
Pedestal Fronts

SLAT WALL ACCESSORIES
slat wall paper tray

Style Number	List Price
SWA2	40

SLAT WALL ACCESSORIES
slat wall pencil holder

Style Number	List Price
SWA4	30

SPECIALTY VENEER ACCENTS
crotch mahogany infield with mitered border

Style Number	List Price
TCB-1 - 84 x 36/42	Contact For Pricing
TCB-2 - 72 x 36/42	Contact For Pricing
TCB-3 - 72 x 30/36	Contact For Pricing

SPECIALTY VENEER ACCENTS
crotch mahogany desk pedestal fronts

Style Number	List Price
FCC1	Contact For Pricing

Specifications

- Specify Black Or Matte Silver

Specifications

- Specify Black Or Matte Silver

Specifications

- Center balanced butt and book matched crotch mahogany
- 35 sheen non-rubbed finish ensures maximum durability

Specifications

- Center balanced butt and book matched crotch mahogany
- 35 sheen non-rubbed finish ensures maximum durability

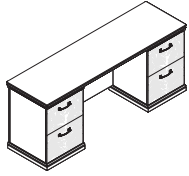

Box/Box/File or File/File
Drawer Fronts



All Three Illustrations Represent: (1) FCC2



Both Illustrations
Represent: FCC3



52" Center Balance Butt
& Bookmatch

SPECIALTY VENEER ACCENTS
crotch mahogany drawer fronts

Style Number	List Price
FCC1	Contact For Pricing

SPECIALTY VENEER ACCENTS
crotch mahogany double width panel
fronts

Style Number	List Price
FCC2	Contact For Pricing

SPECIALTY VENEER ACCENTS
crotch mahogany double width/
double height fronts

Style Number	Contact
FCC3	For Pricing

Specifications

- Center balanced butt and book matched crotch mahogany
- 35 sheen non-rubbed finish ensures maximum durability

Specifications

- Center balanced butt and book matched crotch mahogany
- 35 sheen non-rubbed finish ensures maximum durability

Specifications

- Center balanced butt and book matched crotch mahogany
- 35 sheen non-rubbed finish ensures maximum durability

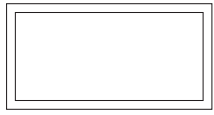

RECTANGLE INLAY

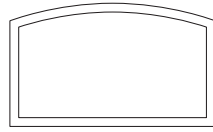

CURVED INLAY

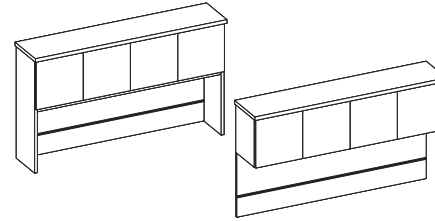

SPECIALTY VENEER ACCENTS

rectangle inlay - ebony hardwood inlay detail

Style Number	List Price
T10SA	Contact For Pricing

SPECIALTY VENEER ACCENTS

bowfront inlay - ebony hardwood inlay detail

Style Number	List Price
T11SA	Contact For Pricing

TOOL CHANNEL ACCESSORIES

recessed aluminum tool channel

Style Number	List Price
ATB02	5 per 1"W

Specifications

- 3/16" x 3/16" thick hardwood ebony inlay is handfitted and glued into routed top and sanded flush with surface
- Inlay is finished over with all finish steps

Notes
- Ebony inlay not recommended in: Koko Cherry

Specifications

- 3/16" x 3/16" thick hardwood ebony inlay is handfitted and glued into routed top and sanded flush with surface
- Inlay is finished over with all finish steps

Notes
- Ebony inlay not recommended in: Koko Cherry

Specifications

- Anodized aluminum finish
- Fully recessed
- Finish matches anodized aluminum accessories
- Can be specified with fabric tack surface mounted above channel

Notes
- If using tool channel with wallhung overhead, a veneer panel must be specified.



TOOL CHANNEL ACCESSORIES
iphone holder

Style Number	List Price
ATB31	125

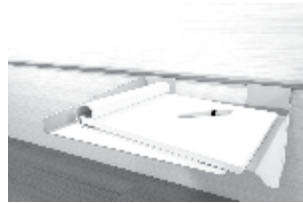

TOOL CHANNEL ACCESSORIES
large shelf

Style Number	List Price
ATB35	135

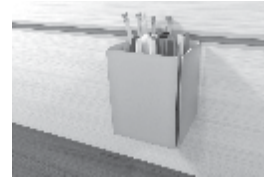

TOOL CHANNEL ACCESSORIES
pencil pen holder

Style Number	List Price
ATB38	120



TOOL CHANNEL ACCESSORIES
tablet holder

Style Number	List Price
ATB30	145

Specifications

- For Console/Wall Hung Back Panels With Optional Tool Bar
- 18 Gauge Steel - Stamp Formed
- Silver Powdercoat Finish
- 5" x 3 -3/4"W
- Non-slip Neoprene pad

Specifications

- 12"W x 10"D

Specifications

- For Console/Wall Hung Back Panels With Optional Tool Bar
- 18 Gauge Steel - Stamp Formed
- Silver Powdercoat Finish
- 5"H x 4"W x 4"D

Specifications

- For Console/Wall Hung Back Panels With Optional Tool Bar
- 18 Gauge Steel - Stamp Formed
- Silver Powdercoat Finish
- 10" x 8"W
- Non-slip Neoprene pad

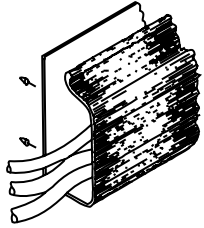

WIRE MANAGEMENT
horizontal j-channel wire
management raceway

Style Number	List Price
W1	80 Per 4' section

Specifications

- 4' section for field installation.
- The "J" shape black thermoplastic wire raceway may be added to specified worksurface tops to provide concealed channeling of wires to and from worksurface grommets. For use in open kneespace areas, raceway is attachable to top of back panel with pan head screws. Interior dimensions are 1" x 1- 1/2" providing ample storage for multiple wires and excess cable. Front of raceway flexes out for easy cord insertion.

Notes

- Units w/ Wire Channel Standard.
- Field Installation

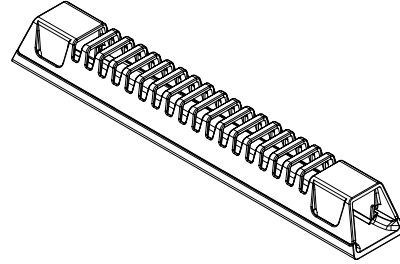

WIRE MANAGEMENT
horizontal wire management raceway

Style Number	List Price
W21	35

Specifications

- 10"W x 1.5"D x 1.25"H
- Gray Wire Manager (10.5")
- Power and data cables can be discretely housed and managed with the W21 Gray Wire Manager. This can be mounted in any location to metal frame or underside of conference tables and runs cables through a 1" channel from power module to hollow steel legs. This keeps cables organized under the table top. Release clips make it simple to snap on and off the Wire Manager for easy organization and access after attached to the table

Notes

- Field installed

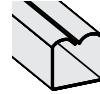

WIRE MANAGEMENT
horizontal u-channel wire
management raceway

Style Number	List Price
W2A	80 Per 4' section

Specifications

- 4' section for field installation.
- Units w/ Wire Channel Standard.
- Field Installation

Notes



WIRE MANAGEMENT
coil wire manager

Style Number	List Price
W18	160

Specifications

- Weighted Base, Table attachment plate
- 39- 1/2" Length
- Black

Notes

- Location

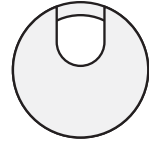
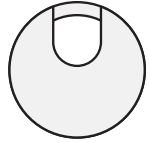

WIRE MANAGEMENT

standard location grommets - factory installed

Style Number	List Price
Standard Location Grommet	
Black	
TM30	50
Silver	
TM31	50
Antique Brass	
TM33	50
White	
TM34	50

Specifications

- 1-5/8" Metal Grommet

Notes

- *Units w/ Grommets Standard Are Noted Under Standard Features. Grommets Match Pull Finish - Standard (Unless Specified Otherwise)

WIRE MANAGEMENT

non-standard location grommets - factory installed

Style Number	List Price
Non-Standard Location Grommet	
Black	
TM30 -NS	95
Silver	
TM31 -NS	95
Antique Brass	
TM33 -NS	95
White	
TM34 -NS	95

Specifications

- 1-5/8" Metal Grommet

Notes

- *Units w/ Grommets Standard Are Noted Under Standard Features. Grommets Match Pull Finish - Standard (Unless Specified Otherwise)

WIRE MANAGEMENT

black plastic vertical surface grommets - factory installed

Style Number	List Price
Standard Location Grommet	
TM50-C	50
Non-Standard Location Grommet	
TM50-NS	95

Specifications

- 2 " Black Plastic Grommet

Notes

- Standard Location is Bottom Center

Aircharge wireless charging grommet

Style Number	List Price
 ACWG WIRELESS GROMMET	\$213

Specifications

- > When used with GROVE Tables an additional \$350 LIST will apply for the special cutout required.
- > AirCharge offers a convenient way to charge any Qi compatible smartphone or device without the need to carry charging cables or find an available power outlet.
- > The Aircharge is powered by the latest Qi compliant IC offering reliable and efficient wireless charging in a convenient 3" grommet hub. Simply place your phone on the Aircharge and an LED will confirm pairing and begin wireless charging.
- > Recess: Efficient space conservation and quick access
- > Input: DC 5V (with included AC power adapter), DC 9V, 1.67A (with optional QC 2.0 power adapter)
- > Output: 5 watts Max. with DC 5V, 2A power adapter, 10 watts Max. with QC 2.0 power adapter
- > Qi V1.2 compliant IC
- > Charging distance: 6mm Max.

Available: All DARRAN collections



Cove power unit - non-linking

Style Number	List Price
 PD-COVE PLUG	\$600
Non-linking version	

Specifications

- > Size 5.75"L x 2.5"W
- > (2) 15 Amp Receptacles and (2) USB charging ports
- > Surface Mount
- > 108" Cord
- > Standard Silver Finish, Available in White or Black Finish upon request
- > ETL Listed

Available: All DARRAN collections



Cove corded series

Style Number

List Price



PD-COVE-PKO

\$872

Specifications

- › Size 9.5"L x 2.5"W x 3.18"D
- › When used with GROVE Tables an additional \$350 LIST will apply for the special cutout required.
- › (2) Power Receptacles, (2) 2.1 Amp USB charging ports and (1) Telecom Plate Knockout
- › Surface Mount
- › 108" Cord
- › Standard Silver Finish, Available in White or Black Finish upon request
- › ETL Listed

Available: All DARRAN collections

Telecom Plates

RJ45 (1)	\$55
RJ45 (2)	\$110
RJ45 (3)	\$160
USB (1)	\$70
USB (2)	\$140
RJ11/RJ45	\$110
RJ45/USB	\$125
RJ45/HDMI	\$210
HDMI/DVI	\$325
HDMI/USB	\$205
HDMI/VGA	\$240
VGA/MINI-STEREO	\$155
VGA/USB	\$175

This pod can have up to 1 total plates.
 *All telecom connectors sold separately.



Soba wire manager

Style Number	List Price
STARTER UNITS	
SCDW	\$218
White wire manager	
SCDB	\$218
Black wire manager	

Specifications

- > Dimensions: 9ft x 9in x 3.15in
- > Zips up, bundles and routes loose, messy cables into a single tube
- > Routes and guides cables behind desks, TVs, and anywhere cables tend to get messy
- > Accommodates large or small cables, up to three cables at once
- > Support channels, used to route cables, include powerful adhesive backing which allows easy attachment to surfaces.

Available: All DARRAN collections



VILLA Power unit - non-linking

Style Number	List Price
VIL-C PLUG Non-Linking	\$562

Specifications

- > Size: Top Grommet 5.68"L X 3.39"W; Under Top 12"L x 3.13"W x 3.08"D
- > (2) Power receptacles; (2) USB charging ports and (1) Knockouts for RJ45 Data Ports
- > Surface Mount
- > 72" Cord (Longer cord available, contact Customer Service)
- > Standard Silver Finish, Black Finish available upon request
- > UL or ETL Certified

Available: All DARRAN collections, excludes Grove

RJ45 Knockout	
RJ45 (1)	\$55

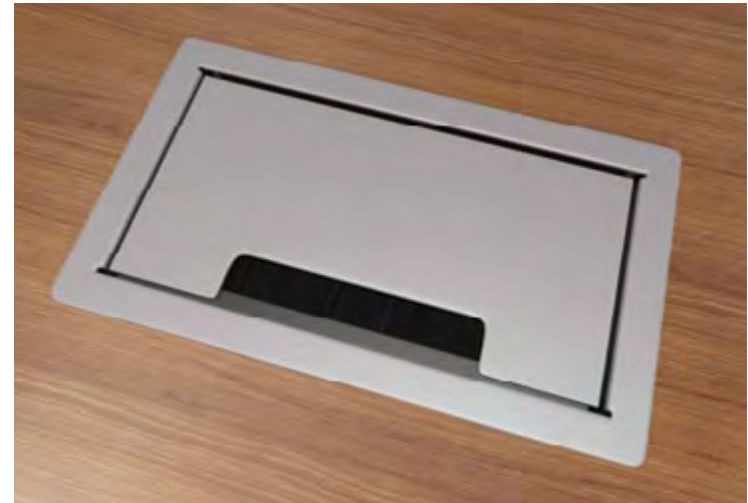



Jamestown Price List

Effective November 1, 2022

Date	Page	Modification	Description
11.11.22		Price Increase	9% price increase applied
01.18.23	7	Removed grommets from M34 and M51	
02.15.23	64-64	Remove leather inlays	

Statement of Line
Features & Advantages 1
Finishes | Specifications..... 3
Edges | Pulls | Knobs 4
Grommets | Grommet Reference 5
Ganging | Height Reference 6
Modesty Reference | Grain Direction 7
Drawer Dimensions | FILING Reference..... 8
Double Pedestal Desk..... 9
Table Desk 11
Single Pedestal Desk 12
Service Desk 14
Returns 15
Bridges 17
Freestanding Credenzas 18
Workstation Credenzas 24
Single Height Freestanding Overheads..... 26
Double Height Freestanding Overheads 28
Overhead Accessories 30
Single Height Wall Hung Overheads 34
Wall Hung Accessories..... 36
Overhead Bookcases 41
Vertical Full Towers..... 43
Bookcases..... 45
Options 47
Power & Data 62

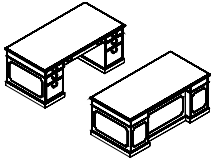

Page 9
Double Pedestal Desks
Executive / Breakfront

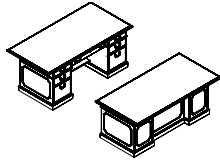

Page 10
Double Pedestal Desks
Overhang Top / Breakfront

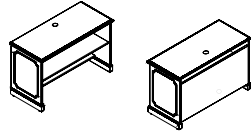

Page 11
Table Desks
Computer Table

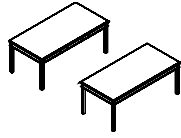

Page 12
Table Desks
Wood Top With Hardwood Legs

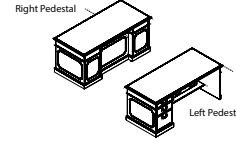

Page 13
Workstation Desk
Breakfront - Single Pedestal -
Flush Top

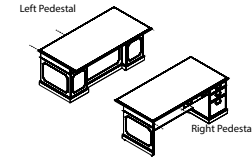

Page 14
Workstation Desk
Breakfront - Single Pedestal W/
Overhang Top

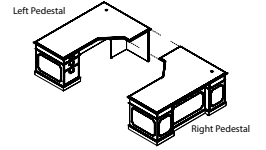

Page 15
Service Workstation Desk
Breakfront - Single Pedestal - Ser-
vice Desk

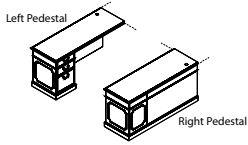

Page 16
"L" Workstation Returns
Box/Box/File - Full Modesty/Base

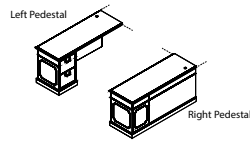

Page 17
"L" Workstation Returns
File/File - Full Modesty / Base

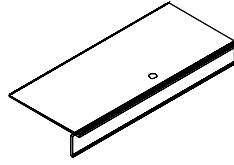

Page 18
"U" Workstation Bridges
Open Back Bridge

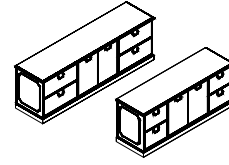

Page 19
Credenzas
File/File/Storage

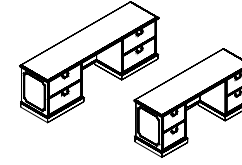

Page 20
Credenzas
Kneespace - File/File

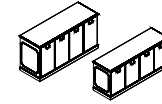

Page 21
Storage Credenza
Storage Credenza

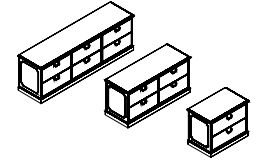

Page 22
Lateral File Credenzas
6/4/2 Drawer

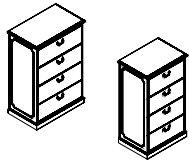

Page 23
Lateral File Credenzas
Lateral File

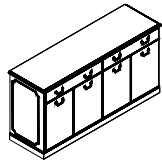

Page 24
Buffet Credenza
Buffet Credenza

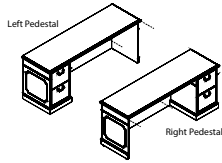

Page 25
Workstation Credenzas
File/File

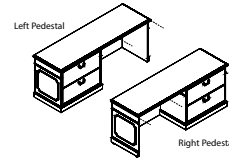

Page 26
Workstation Credenzas
Lateral File

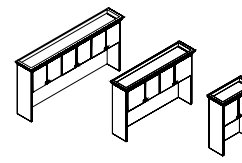

Page 27
Single Height Overheads
Panel Door With Cornice Top

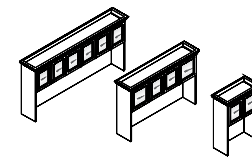

Page 28
Single Height Overheads
Frame Door With Beveled Glass
Cornice Top

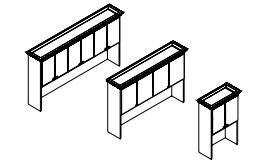

Page 29
Double Height Overheads
Overhead Panel Doors/Cornice
Top

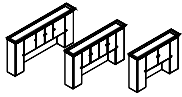

Page 30
Double Height Overheads
Overhead Wood Panel/Cornice
Top

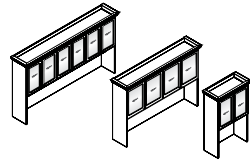

Page 31
Double Height Overheads
Wood Frame Door With Beveled
Glass/Cornice Top

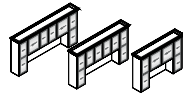

Page 32
Double Height Overheads
Beveled Glass Doors/Cornice Top

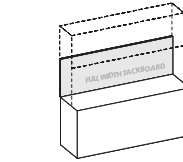

Page 33
Overhead Tackboards

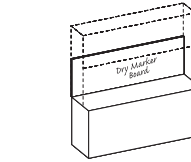

Page 34
Overhead Dry Marker Boards

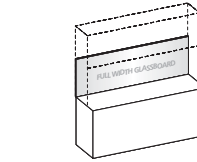

Page 35
Overhead Glassboards

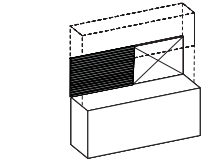

Page 36
Overhead Slat Wall

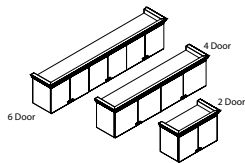

Page 37
Single Height Wall Hung Over-
heads
Panel Door

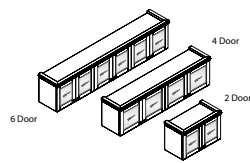

Page 38
Single Height Wall Hung Over-
heads
Wood Frame Beveled Glass

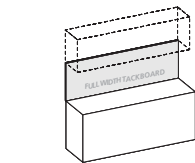

Page 39
Wall Hung Tackboards

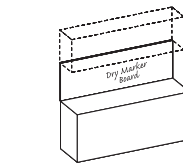

Page 40
Wall Hung Dry Marker Boards

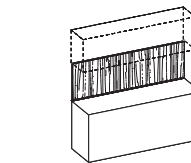

Page 41
Wall Hung Veneer Panels

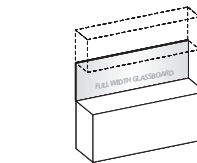

Page 42
Wall Hung Glassboards

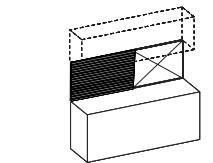

Page 43
Wall Hung Slat Wall

Statement of Line

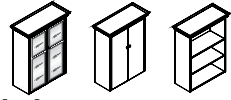

Frame Door W/ Beveled Glass Panel Door Open Bookcase

Page 44
Single Height Overhead
35"/29" Bookcase / Hutch Overhead With Cornice Top

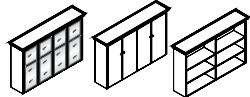

Frame Door W/ Beveled Glass Panel Door Open Bookcase

Page 45
Single Height Overhead
70" Bookcase/Hutch Overhead With Cornice Top

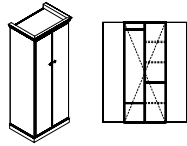

Page 46
Tower Cabinets
Wardrobe / Storage Tower



Hinged Left

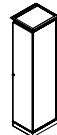

Hinged Right

Page 47
Single Door Tower Cabinets
Wardrobe / Storage Tower

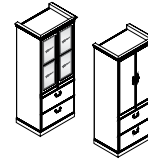

Page 48
Tower Cabinets
Lateral File / Storage Tower

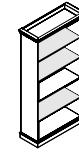

73" Height

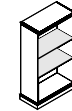

53" Height

Page 49
Bookcases
Open Bookcases

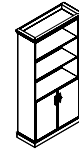

73" Height



53" Height

Page 50
Bookcases
Panel Door Bookcases

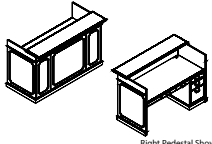

Right Pedestal Shown

Page 51
Reception Desk
Reception Desk With Counter

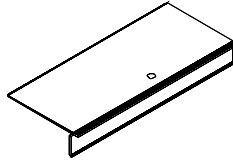

Page 52
Reception Bridge
Open Back Bridge

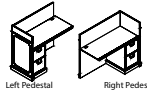

Left Pedestal Right Pedestal

Page 53
Reception Return
Return

DARRAN®

Veneer

DARRAN only uses HPVA AA Grade Flat Cut Cherry and Walnut Veneers. All veneers are selected and matched for balance and consistency.

Veneer Tops

Jamestown veneer tops feature a 45-pound density substrate with balanced 3-ply construction. Tops are 1-1/8" thick on MDF core comprised of 100% recycled and recovered wood fibers. All veneer tops are slipmatched and feature a 3mm external solid hardwood band or profile edge.

Laminate Tops

Jamestown high-pressure laminate tops feature a 45-pound density substrate with balanced 3-ply construction. Tops are 1-1/8" thick on MDF core comprised of 100% recycled and recovered wood fibers. All high pressure laminate tops are available with a profile edge, laminate self-edge or 2mm PVC edge band. Laminates in wood grain patterns feature a fine grain texture that features the polish and luxe of a real wood veneer with a subtle narrow grain structure.

Cleaning wood & laminate

In addition to regular dusting, give your furniture an occasional cleaning in accordance with our cleaning instructions. DARRAN wood and laminate products can be cleaned with a soft cloth and a mild soap and water mixture. Use approximately 32 oz of water mixed with one tablespoon of dish soap, always wiping with the grain. Dry with a soft cloth, going with the grain, to avoid spotting or streaking.

Wood products should be waxed periodically using a non-wax liquid; please do not use any waxy polish or cleaner. Interior of drawers may also be cleaned with mild soap and water mixture, or any household cleaner that is not petroleum or thinner-based.

Chassis & pedestal

Chassis components are 3/4" thick core of particle board or MDF rated EPP/SCS/CARB-II material with 3-ply balanced construction. Pedestal and Cabinets feature dowel construction reinforced with steel bracket plates, wood cleats, screws and glue. All units are standard with 1" adjustable glides that allow for leveling of units that are secured in solid wood glide blocks to prevent tear out.

Overhead cabinet construction

Freestanding & wall mount

Freestanding Overhead storage cabinets are constructed of 1" and 3/4" thick core of particle board or MDF rated EPP/SCS/CARB-II material with 3-ply balanced construction. Panels are attached with cam fasteners in conjunction with dowels securely adhered with glue. All surface mount cabinets connect to work surface with anti-slip tape. Wall mount cabinets

Jamestown Features & Advantages

are mounted to the wall with steel "z" bracket attachment method using 5mm euro screws to attach to the back of the cabinet. All units ship with a steel "z" bracket. This bracket is mounted to the wall by field installers. Installers are responsible for selecting and supplying appropriate fasteners for wall conditions.

Bookcase construction

All chassis (sides, back, top and bottom panels) are constructed with 3/4" thick core of particle board or MDF rated EPP/SCS/CARB-II material with 3-ply balanced construction. Panels are attached with cam-lock fasteners in conjunction with dowels securely adhered with glue. Shelves on all units are 3/4" thick balance 3 ply panels. Optional heavy duty shelves are 1" thick lumber core balanced 5 ply construction.

Tackboards

Wall mount tackboards are constructed of .75" thick fiberboard. The fabric is precisely aligned and fitted to the tackboard with a sock on cover. Overhead storage tackboards are constructed of .75" thick fiberboard. The fabric is precisely aligned and fitted to the tackboard and adhered to the rigid hardboard with staples. Wall mount cabinets are mounted to the wall with steel "z" bracket attachment method using 5mm euro screws to attach to the back of the cabinet. All units ship with a steel "z" bracket. This bracket is mounted to the wall by field installers. Installers are responsible for selecting and supplying appropriate fasteners for wall conditions.

Adjustable glides

Glides provide 1" of vertical leveling adjustment. Glide bottom is durable metal. Glides are secured in solid wood blocks that are screwed and glued for durability.

Drawers

All drawers are constructed of four sides and a bottom, which are attached to a drawer front with screws for easy removal. Drawer fronts are vertically matched in balanced sets. Pencil trays are standard in all box drawers. Drawers are constructed of maple veneer 1/2" thick material for drawer sides, fronts and backs with a UV finish for maximum durability. Drawer bottoms are 3/16" thick 3-ply maple veneer. Drawer boxes are assembled at each corner with dowel joinery for maximum drawer strength. Lifetime free replacement warranty.

Standard Wood Drawers

Optional hardwood veneer plywood drawers feature banded top and bottom edges for smoothness. Drawers are dowel joint construction with a UV cured finish over maple veneers, plus a lifetime free replacement guarantee.

Drawer Fronts

Drawer fronts are vertically matched in balanced sets. Doors feature vertical veneer bookmatched horizontally in sets of 2 / 4 and 6 doors. All drawers and doors have traditional scallop profile edge shape. All tower fronts matched in vertical sets.

Suspensions

All casegoods utilize cold rolled steel zinc plated high-grade drawer suspensions. Box and File drawers are full extension, featuring steel ball bearings for a smoother quieter range of motion with soft close operation and are rated 100lbs. Lateral file drawers are a progressive action full extension suspension with the soft close operation and is rated at 150lbs. Lateral files include anti tip mechanism that will allow only one drawer at a time to be opened. All suspensions are soft close and are warranted for the lifetime of the product.

Hinges

Units with doors include 95 degree swing hinges.

Filing

Jamestown features metal file frames around the perimeter of the drawers with cross bars secured to the drawer sides to support hanging files. A metal adjustable cross bar is standard with all file drawers to support letter/legal filing front to back or side to side. File drawers have one adjustable cross bar and lateral files have two adjustable cross bars. See filing reference for details.

Locks

Locks are Standard on all drawers below the worksurface. Random lock cores are installed at the factory. Some units may be shipped with the same key number. Locks are Silver, Black or Bronze and match pull finish unless otherwise specified.

DARRAN will also send lock cores separately to the dealer at your request. These units will be send with an empty lock core and the Dealer will receive a shipment of the requested lock core/keys.

Keying

Keying is available either factory or field installed. Factory installed keying is random.

Wire management

Wire management capabilities include standard and optional worksurface grommets. Specify W-1 under surface wire channels for organization and management of all communication wires and cords. Horizontal J-Channel wire management (Sku: W-1) is sold separately to conceal wire under worksurfaces.

Grommets

Metal grommets are provided to match the drawer pull selection. Grommet is available in black, silver, white or antique brass. Must specify standard or non-standard location. Black plastic grommets are available as an option for vertical applications.

Powerports

A large selection of power pods are available and handle power, data, docking stations and communication. See options section for selection..

LED Task Lights

LED task lighting provides high efficiency, low energy lighting with a long life. Surface mought light is encased in silver aluminum channel with milk lense and rounded end caps. Lights are field installed.

Product specifications listed below:

- Diffuser creates a softer light and eliminates hot spots
- Touch dimmer switch
- Can be “daisy chained” up to 90W
- 4.6 watts per foot
- 120 LEDs per meter
- Certification: UL Listed
- 50,000 hour life span.

Color Temp is 4000K

STANDARD VENEER	PREMIUM VENEER	HIGH PRESSURE LAMINATE	THERMALLY FUSED LAMINATE
WAC Amber Cherry	N/A	GAC Amber Cherry	N/A
WIC Crimson Cherry	N/A	GIC Crimson Cherry	N/A
WHC Honey Cherry	N/A	GHC Honey Cherry	N/A
WOC Koko Cherry	N/A	GOC Koko Cherry	N/A
WEW Executive Walnut	N/A	GEW Executive Walnut	N/A
WGW Gunstock Walnut	N/A	N/A	N/A
WBW Henna Walnut	N/A	N/A	N/A
WSW Smokey Walnut	N/A	N/A	N/A
WNW Natural Walnut	N/A	GNW Natural Walnut	N/A

Send 3x3 or larger finish chip for color match. Custom finish upcharge is 3% or \$250 Net (whichever is greater).



Finish

Welltech Finish delivers a superior furniture coating with exceptional performance that can withstand stringent cleaning agents and possesses unparalleled durability, allowing DARRAN to provide lasting, sustainable products to our customers.

Jamestown Edge

Hardwood Rim Band Species Same As Surface Veneer

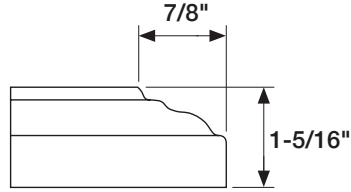

Hookup edge profile

Coped Edge

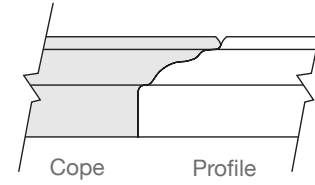

Hardwood beltline molding

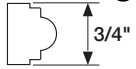

Scalloped molding

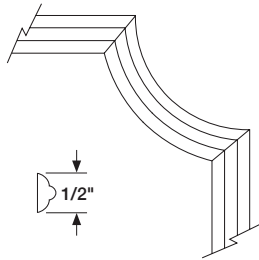

Pulls/knobs

Factory Installed



PL-5 Antique Brass
PL-50 Brushed Pewter

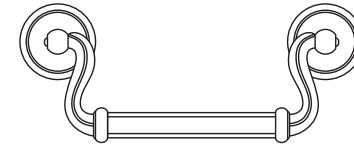

PL-4 Antique Brass

Cornice top profile

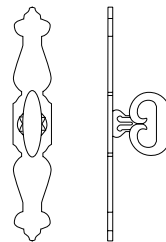
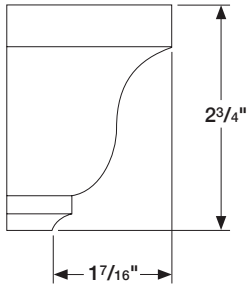

DK-5 Antique Brass
DK-50 Brushed Pewter

Base profile

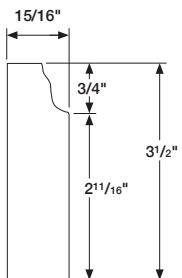

Drawer/door edge profile

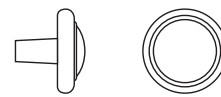

DK-4
Antique Brass



DK-114
Brush Pewter

TM30
Black
1-5/8" Dia.

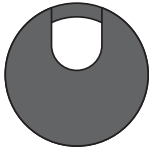

TM31
Silver
1-5/8" Dia.

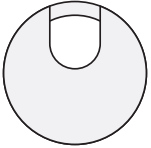

TM33
Antique Brass
1-5/8" Dia.

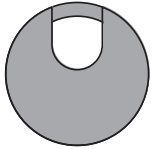

Optional grommets

Factory Installed

Grommets (Standard Location)

Specify Color and Left/Right/Center - \$50 ea.
- Black: TM30-R (Right), TM30-L (Left), TM30-C (Center)

- Silver: TM31-R (Right), TM31-L (Left), TM31-C (Center)

- Antique Brass: TM33-R (Right), TM33-L (Left), TM33-C (Center)

Grommets (Non-Standard Location)

Provide drawing w/ Grommet Location and Specify Color - \$95 ea.

- Black: TM30-NS

- Silver: TM31-NS

- Antique Brass: TM33-NS

TM50
Black
1-5/8" Dia.



Grommets (vertical surface)

Standard Location - \$50 ea.

- Black Plastic Vertical Surface: TM50-C (Bottom Center)

Non-Standard Location - \$95 ea.

- Black Plastic Vertical Surface: TM50-NS

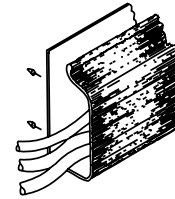

W1

Horizontal J-Channel

Horizontal J-Channel wire management (Sku: W-1) is sold separately to conceal wire under worksurfaces.

Standard grommet location reference



Desk
Specify Right or Left Grommet

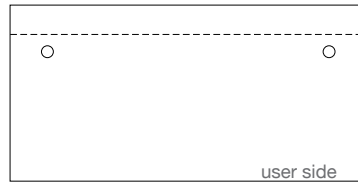

6" Overhang Desk
Specify Right or Left Grommet

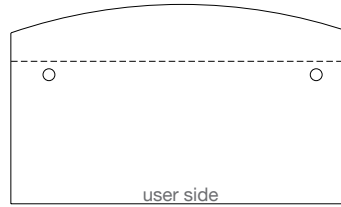

6"/12" Bow Front Desk
Specify Right or Left Grommet

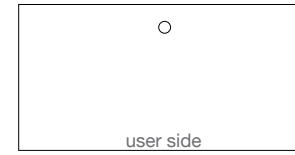

Bridge
Center Grommet



Return (Left Pedestal Shown)
Right Pedestal - Left Grommet
Left Pedestal - Right Grommet

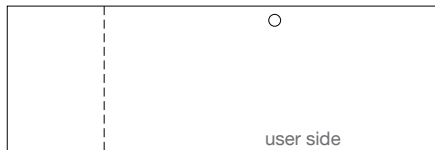

Workstation Credenza
Center Kneespace Grommet

Ganging – flush cut modification

30”H Casework Worksurface & Base Ganging Modifications

To gang two casework units, each unit end to be ganged must be flush cut modified for gapless surfaces and cabinet chassis.

Order Option:

- FC-B: Flush Unit Both Sides(Facing) for Ganging - \$100
- FC-L: Flush Unit Left (Facing) for Ganging - \$100
- FC-R: Flush Unit Right (Facing) for Ganging - \$100

Flush cut modification per unit includes all modifications to gang to one end or both ends when units are ganged. Modification includes tops, base and molding. Modification reduces width size approximately 1” per end.

Overhead consoles and towers are offered freestanding and ganging – inclusive of flush cut modifications.

Example:

JCM3124CA104W Two Drawer Lateral File (Left) Flush Cut Right – FC-R...\$100

JCM7224CA054W Kneespace Credenza (Right) Flush Cut Left – FC-L...\$100



Height reference

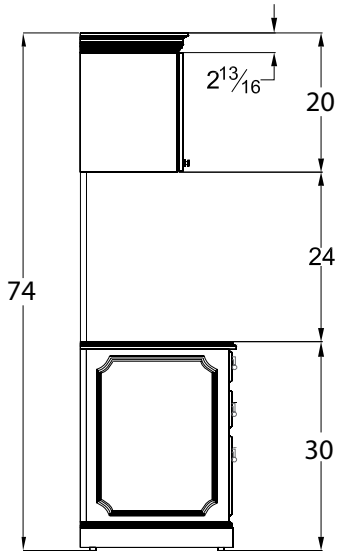

Typical Single Height Side Profile Wall Hung Overhead

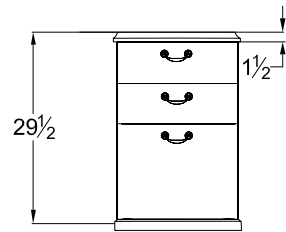

Pedestal Front Profile Box/Box/File

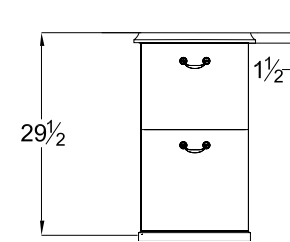

Pedestal Front Profile File/File

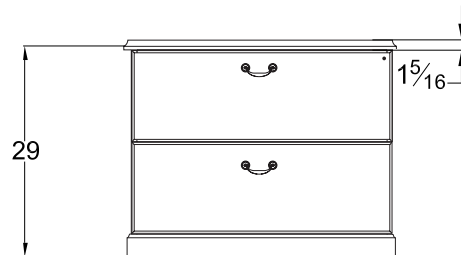

Pedestal Front Profile Lateral File

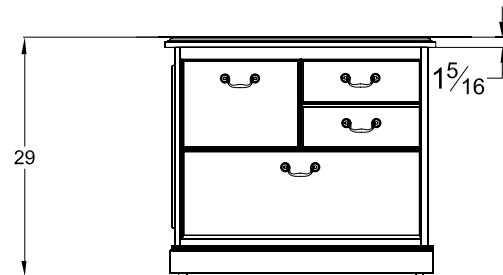

Pedestal Front Profile Multi-File

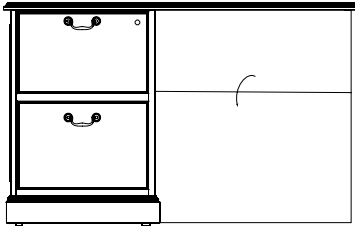

Top View



M34
Drop Door Tech Modesty

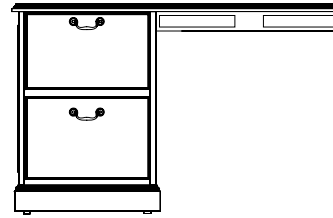

M51
Open Back Modesty with 4" Wire Management Rail

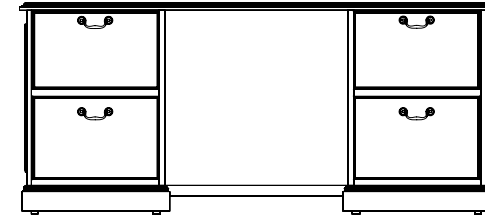

M37
Fixed Full Modesty

Grain direction

Veneer chassis parts are vertical grain. Doors feature vertical veneer bookmatched horizontally in sets of 2, 4, and 6 doors. Tower fronts are matched in vertical sets.

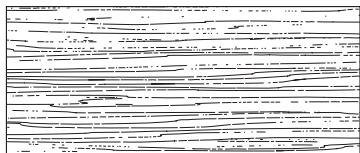

Desk

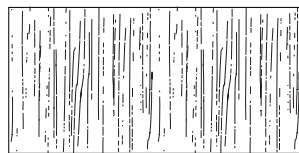

Bridge
Grain Direction on TFL
Units Above 66" runs end
to end

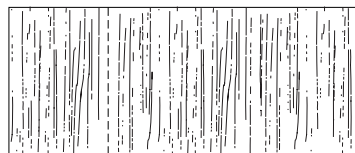

Return
Grain Direction on TFL Units
Above 66" runs end to end



Credenza

Interior drawer dimensions

UNIT DEPTH	DRAWER	OVERALL DIM			INTERIOR DIM			NOTES
		W	D	H	W	D	H	
15-5/8" Letter	36" Shallow Box	13-1/8	19-11/16	2-9/16	12-1/8	18-11/16	2	Units less than 72"
	36" Box	13-1/8	19-11/16	4	12-1/8	18-11/16	3-7/16	Units less than 72"
	36" File	13-1/8	19-11/16	9-13/16	12-1/8	18-11/16	9-5/16	Units less than 72"
	30" Shallow Box	13-1/8	19-11/16	2-9/16	12-1/8	18-11/16	2	Units less than 72"
	30" Box	13-1/8	19-11/16	4	12-1/8	18-11/16	3-7/16	Units less than 72"
	30" File	13-1/8	19-11/16	9-13/16	12-1/8	18-11/16	9-5/16	Units less than 72"
	24" Shallow Box	13-1/8	16-1/16	2-9/16	12-1/8	15-1/16	2	Units less than 72"
	24" Box	13-1/8	16-1/16	4	12-1/8	15-1/16	3-7/16	Units less than 72"
	24" File	13-1/8	16-1/16	9-13/16	12-1/8	15-1/16	9-5/16	Units less than 72"
18-9/16" Legal	36" Shallow Box	16-1/16	19-11/16	2-9/16	15-1/16	18-11/16	2	Units less than 72"
	36" Box	16-1/6	19-11/16	4	12-1/8	18-11/16	3-7/16	Units 72" & above
	36" File	16-1/6	19-11/16	9-13/16	12-1/8	18-11/16	9-5/16	Units 72" & above
	30" Shallow Box	16-1/16	19-11/16	2-9/16	15-1/16	18-11/16	2	Units less than 72"
	30" Box	16-1/6	19-11/16	4	12-1/8	18-11/16	3-7/16	Units 72" & above
	30" File	16-1/6	19-11/16	9-13/16	12-1/8	18-11/16	9-5/16	Units 72" & above
	24" Shallow Box	16-1/16	16-1/16	2-9/16	15-1/16	15-1/16	2	Units less than 72"
	24" Box	16-1/6	16-1/16	4	12-1/8	15-1/16	3-7/16	Units less than 72"
	24" File	16-1/6	16-1/16	9-13/16	12-1/8	15-1/16	9-5/16	Units less than 72"
29" Lateral	24" File	26-1/2	16-1/16	9-13/16	25-1/2	15-1/16	9-5/16	Workstation Credenzas less than 82"
35" Lateral	24" File	32-1/2	16-1/16	9-13/16	31-1/2	15-1/16	9-5/16	Workstation Credenzas over 83"

Filing reference

Filing for 24" depth units

13 1/8" Wide File Drawer - 16 1/16" Deep

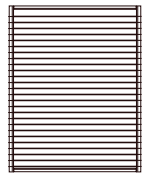

Letter Front to Back

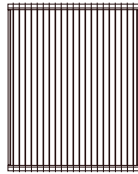

Legal Side to Side with File Rail

Filing for 30" & 36" depth units

13 1/8" Wide File Drawer - 19 11/16" Deep

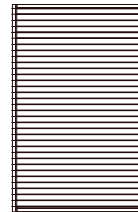

Letter Front to Back

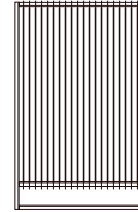

Legal Side to Side with File Rail

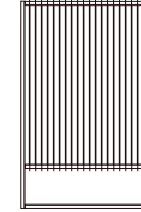

Letter Side to Side with File Rail

29" Lateral file drawer

26-1/2" Wide File Drawer - 16-1/16" Deep

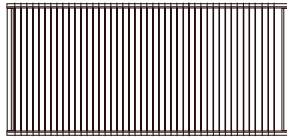

Legal Side to Side

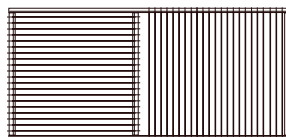

Legal Side to Side Letter Front to Back with File Rail

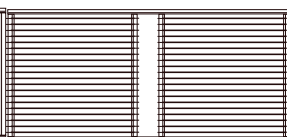

Letter Front to Back with File Rail

35" Lateral file drawer

32-1/2" Wide File Drawer - 16-1/16" Deep

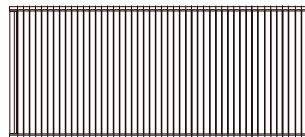

Legal Side to Side

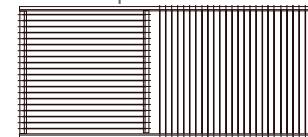

Legal Side to Side Letter Front to Back with File Rail

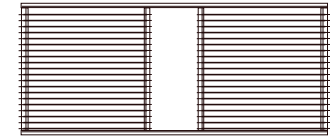

Letter Front to Back with File Rail

Jamestown

Double Pedestal Desks
Executive / Breakfront

[Click here to view statement of line](#)

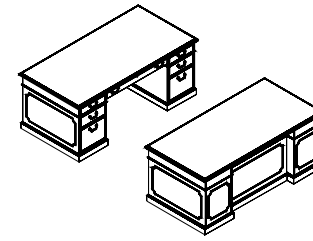

1 Select Model

w" x d" x h"	Weight
84 x 36 x 30	395
72 x 36 x 30	325
72 x 30 x 30	300
66 x 36 x 30	300
66 x 30 x 30	315
60 x 30 x 30	290

Standard Veneer Top Standard Veneer Chassis		Premium Veneer Top Premium Veneer Chassis		High Pressure Laminate Top Veneer Chassis		Thermally Fused Laminate Top Thermally Fused Laminate Chassis	
JCM8436DD000W	6340	"P" Option N/A		JCM8436DD000G	6340	"M" Option N/A	
JCM7236DD000W	5478	"P" Option N/A		JCM7236DD000G	5478	"M" Option N/A	
JCM7230DD000W	5346	"P" Option N/A		JCM7230DD000G	5346	"M" Option N/A	
JCM6636DD000W	5346	"P" Option N/A		JCM6636DD000G	5346	"M" Option N/A	
JCM6630DD000W	4764	"P" Option N/A		JCM6630DD000G	4764	"M" Option N/A	
JCM6030DD000W	4583	"P" Option N/A		JCM6030DD000G	4583	"M" Option N/A	

Product Features

- 6" Recessed modesty
- Box/Box/File
- Front profile shaped all edges
- Full extension wood drawers - locking
- Kneespace storage shelf
- Laminate pull out writing shelf
- Soft close suspension drawer(s)
- Traditional center drawer standard
- Beltline Molding

Options

Accessories

- K21: Traditional pull-out drawer w/ keyboard tray - \$470

Grommet (Standard Location)

Specify Color and Location Right/Left - \$50 ea.

- Black: TM30-R (Right), TM30-L (Left)
- Silver: TM31-R (Right), TM31-L (Left)
- Antique Brass: TM33-R (Right), TM33-L (Left)

Grommets (Non-Standard Location)

Provide drawing w/ Grommet Location and Specify Color - \$95 ea.

- TM30-NS: Black Specify Location
- TM31-NS: Silver Specify Location
- TM33-NS: Antique Brass Specify Location

Height Adjustable Worksurface

- LFT03: Adjustable height from 29" to 47.5" with a maximum weight capacity of 350 lbs - \$3790

Locking

- CL-01: Central locking - \$160

Molding

- DSM1: Delete Scalloped Only - Deduct \$95

Workstation

- CP-3: Client pull out on approach - \$445

2 Select Finish

[Click to view finishes](#)

- WAC
- WIC
- WHC
- WOC
- WEW
- WGW
- WBW
- WSW
- WNW

- GAC
- GIC
- GHC
- GOC
- GEW
- GNW

3 Select Edge

[Click to view edges](#)



4 Select Hardware

[Click to view details](#)



Jamestown

Double Pedestal Desks
Overhang Top / Breakfront

[Click here to view statement of line](#)

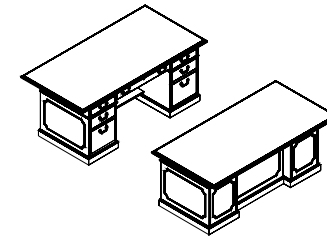

1 Select Model

w" x d" x h"	Weight
72 x 36 Chassis	410
84 x 42 x 30	
72 x 30 Chassis	375
84 x 36 x 30	
66 x 30 Chassis	325
72 x 36 x 30	
66 x 24 Chassis	280
72 x 30 x 30	

Standard Veneer Top Standard Veneer Chassis	Premium Veneer Top Premium Veneer Chassis	High Pressure Laminate Top Veneer Chassis	Thermally Fused Laminate Top Thermally Fused Laminate Chassis
JCM8442DD037W 6803	"P" Option N/A	JCM8442DD037G 6803	"M" Option N/A
JCM8436DD037W 6007	"P" Option N/A	JCM8436DD037G 6007	"M" Option N/A
JCM7236DD037W 5478	"P" Option N/A	JCM7236DD037G 5478	"M" Option N/A
JCM7230DD037W 5214	"P" Option N/A	JCM7230DD037G 5214	"M" Option N/A

2 Select Finish

[Click to view finishes](#)

- WAC
- WIC
- WHC
- WOC
- WEW
- WGW
- WBW
- WSW
- WNW

- GAC
- GIC
- GHC
- GOC
- GEW
- GNW

3 Select Edge

[Click to view edges](#)



4 Select Hardware

[Click to view details](#)



Product Features

- 6" Recessed modesty
- Beltline molding
- Box/Box/File
- Full extension wood drawers - locking
- Kneespace storage shelf
- Laminate pull out writing shelf
- Soft close suspension drawer(s)
- Traditional center drawer standard

Notes

- 6" overhang on approach

Options

Accessories

- K21: Traditional pull-out drawer w/ keyboard tray - \$470

Grommet (Standard Location)

Specify Color and Location Right/Left - \$50 ea.

- Black: TM30-R (Right), TM30-L (Left)
- Silver: TM31-R (Right), TM31-L (Left)
- Antique Brass: TM33-R (Right), TM33-L (Left)

Grommets (Non-Standard Location)

Provide drawing w/ Grommet Location and Specify Color - \$95 ea.

- TM30-NS: Black Specify Location
- TM31-NS: Silver Specify Location
- TM33-NS: Antique Brass Specify Location

Height Adjustable Worksurface

- LFT03: Adjustable height from 29" to 47.5" with a maximum weight capacity of 350 lbs - \$3790

Locking

- CL-01: Central locking - \$160

Molding

- DSM1: Delete Scalloped Only - Deduct \$95

Jamestown

Table Desks
Computer Table

[Click here to view statement of line](#)

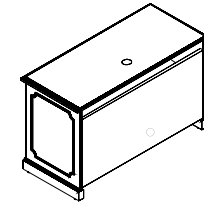
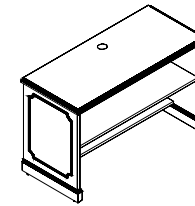

1 Select Model

w" x d" x h"	Weight
48 x 24 x 30	130
42 x 24 x 30	120
36 x 24 x 30	110

Standard Veneer Top Standard Veneer Chassis		Premium Veneer Top Premium Veneer Chassis		High Pressure Laminate Top Veneer Chassis		Thermally Fused Laminate Top Thermally Fused Laminate Chassis	
JCM4824AU225W	2632	"P" Option N/A		JCM4824AU225G	2632	"M" Option N/A	
JCM4224AU225W	2540	"P" Option N/A		JCM4224AU225G	2540	"M" Option N/A	
JCM3624AU225W	2477	"P" Option N/A		JCM3624AU225G	2477	"M" Option N/A	

2 Select Finish

[Click to view finishes](#)

- WAC
- WIC
- WHC
- WOC
- WEW
- WGW
- WBW
- WSW
- WNW

- GAC
- GIC
- GHC
- GOC
- GEW
- GNW

3 Select Edge

[Click to view edges](#)



4 Select Hardware

[Click to view details](#)

Hardware
N/A

Hardware
N/A

Product Features

- 1 Standard grommet - matches pull finish or specify black TM30, silver TM31 or antique brass TM33
- 6" D Foot rest/adjustable storage shelf
- Paper/wire access back
- Vertical surface grommet - TM50 Black

Options

Accessories

- K28: Articulating keyboard w/ mouse pad - \$390
- CST20: Add 4 locking 2" diameter casters to computer table - \$140

Grommet (Standard Location)

Specify Color and Location Right/Left - \$50 ea.

- Black: TM30-R (Right), TM30-L (Left), TM30-C (Center)
- Silver: TM31-R (Right), TM31-L (Left), TM31-C (Center)
- Antique Brass: TM33-R (Right), TM33-L (Left), TM33-C (Center)

Grommets (Non-Standard Location)

Provide drawing w/ Grommet Location and Specify Color - \$95 ea.

- TM30-NS: Black Specify Location
- TM31-NS: Silver Specify Location
- TM33-NS: Antique Brass Specify Location

Molding

- DSM2: Delete Scalloped Only - Deduct \$50

Jamestown

Table Desks
Wood Top With Hardwood Legs

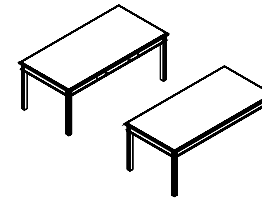

[Click here to view statement of line](#)

1 Select Model

w" x d" x h"
72 x 36 x 30
66 x 30 x 30

Weight
150
130

Standard Veneer Top Standard Veneer Chassis		Premium Veneer Top Premium Veneer Chassis	High Pressure Laminate Top Veneer Chassis	Thermally Fused Laminate Top Thermally Fused Laminate Chassis
--	--	--	--	--

JCM7236DT107W	2975	"P" Option N/A	JCM7236DT107G	2975	"M" Option N/A
JCM6630DT107W	2759	"P" Option N/A	JCM6630DT107G	2759	"M" Option N/A

Product Features

- 2" Square fluted hardwood legs
- 4" Apron rail w/ beltline molding

2 Select Finish

[Click to view finishes](#)

- WAC
- WIC
- WHC
- WOC
- WEW
- WGW
- WBW
- WSW
- WNW

- GAC
- GIC
- GHC
- GOC
- GEW
- GNW

3 Select Edge

[Click to view edges](#)



4 Select Hardware

[Click to view details](#)



Jamestown

Workstation Desk
Breakfront - Single Pedestal - Flush Top

[Click here to view statement of line](#)

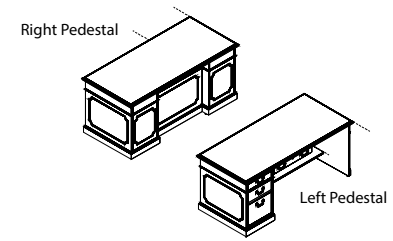

1 Select Model

w" x d" x h"	Weight
Left Pedestal	
72 x 36 x 30	275
72 x 30 x 30	265
66 x 36 x 30	265
66 x 30 x 30	225
Right Pedestal	
72 x 36 x 30	275
72 x 30 x 30	265
66 x 36 x 30	265
66 x 30 x 30	225

	Standard Veneer Top Standard Veneer Chassis	Premium Veneer Top Premium Veneer Chassis	High Pressure Laminate Top Veneer Chassis	Thermally Fused Laminate Top Thermally Fused Laminate Chassis
	JCM7236DS009W 5368	"P" Option N/A	JCM7236DS009G 5368	"M" Option N/A
	JCM7230DS009W 4367	"P" Option N/A	JCM7230DS009G 4367	"M" Option N/A
	JCM6636DS009W 5244	"P" Option N/A	JCM6636DS009G 5244	"M" Option N/A
	JCM6630DS009W 4327	"P" Option N/A	JCM6630DS009G 4327	"M" Option N/A
	JCM7236DS010W 5368	"P" Option N/A	JCM7236DS010G 5368	"M" Option N/A
	JCM7230DS010W 4367	"P" Option N/A	JCM7230DS010G 4367	"M" Option N/A
	JCM6636DS010W 5244	"P" Option N/A	JCM6636DS010G 5244	"M" Option N/A
	JCM6630DS010W 4327	"P" Option N/A	JCM6630DS010G 4327	"M" Option N/A

2 Select Finish

[Click to view finishes](#)

- WAC
- WIC
- WHC
- WOC
- WEW
- WGW
- WBW
- WSW
- WNW

- GAC
- GIC
- GHC
- GOC
- GEW
- GNW

3 Select Edge

[Click to view edges](#)



4 Select Hardware

[Click to view details](#)



Product Features

- Box/Box/File
- Center drawer standard
- Full extension drawers - locking
- Kneespace storage shelf
- Laminate pull out writing shelf
- Soft close suspension drawer(s)

Options

Accessories

- K28: Articulating keyboard w/ mouse pad - \$390

Drawers

- K21: Traditional Pull out drawer w/ keyboard tray - \$470

Grommet (Standard Location)

Specify Color and Location Right/Left - \$50 ea.

- Black: TM30-R (Right), TM30-L (Left)
- Silver: TM31-R (Right), TM31-L (Left)
- Antique Brass: TM33-R (Right), TM33-L (Left)

Grommets (Non-Standard Location)

Provide drawing w/ Grommet Location and Specify Color - \$95 ea.

- TM30-NS: Black Specify Location
- TM31-NS: Silver Specify Location
- TM33-NS: Antique Brass Specify Location

Height Adjustable Worksurface

- LFT03: Adjustable height from 29" to 47.5" with a maximum weight capacity of 350 lbs - \$3790

Locking

- CL-01: Central locking - \$160

Molding

- DSM1: Delete Scalloped Only - Deduct - \$95

Workstation

- CP-3: Client pull out on approach - \$445

Jamestown

Workstation Desk
Breakfront - Single Pedestal W/ Overhang Top

[Click here to view statement of line](#)

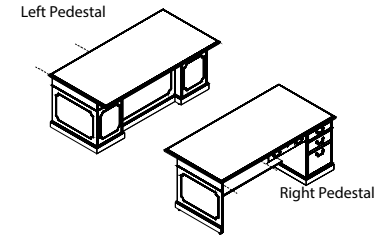

1 Select Model

w" x d" x h"	Weight
72 x 36 x 30	275
72 x 30 x 30	255
66 x 36 x 30	260
66 x 30 x 30	225
72 x 36 x 30	275
72 x 30 x 30	255
66 x 36 x 30	260
66 x 30 x 30	225

Standard Veneer Top Standard Veneer Chassis		Premium Veneer Top Premium Veneer Chassis		High Pressure Laminate Top Veneer Chassis		Thermally Fused Laminate Top Thermally Fused Laminate Chassis	
JCM7236DS634W	5125	"P" Option N/A		JCM7236DS634G	5125	"M" Option N/A	
JCM7230DS634W	4449	"P" Option N/A		JCM7230DS634G	4449	"M" Option N/A	
JCM6636DS634W	4902	"P" Option N/A		JCM6636DS634G	4902	"M" Option N/A	
JCM6630DS634W	4123	"P" Option N/A		JCM6630DS634G	4123	"M" Option N/A	
JCM7236DS633W	5125	"P" Option N/A		JCM7236DS633G	5125	"M" Option N/A	
JCM7230DS633W	4449	"P" Option N/A		JCM7230DS633G	4449	"M" Option N/A	
JCM6636DS633W	4902	"P" Option N/A		JCM6636DS633G	4902	"M" Option N/A	
JCM6630DS633W	4123	"P" Option N/A		JCM6630DS633G	4123	"M" Option N/A	

Product Features

- Box/Box/File
- Center drawer standard
- Full extension drawers - locking
- Kneespace storage shelf
- Laminate pull out writing shelf
- Soft close suspension drawer(s)

Notes

- 6" overhang on approach
- For 72 x 36 x 30 Chassis Size is 70 x 30
- For 66 x 36 x 30 Chassis Size is 64 x 30
- For 72 x 30 x 30 Chassis Size is 70 x 24
- For 66 x 30 x 30 Chassis Size is 64 x 24

Options

Accessories

- K28: Articulating keyboard w/ mouse pad - \$390

Drawers

- K21: Traditional Pull out drawer w/ keyboard tray - \$470

Grommet (Standard Location)

Specify Color and Location Right/Left - \$50 ea.

- Black: TM30-R (Right), TM30-L (Left)
- Silver: TM31-R (Right), TM31-L (Left)
- Antique Brass: TM33-R (Right), TM33-L (Left)

Grommets (Non-Standard Location)

Provide drawing w/ Grommet Location and Specify Color - \$95 ea.

- TM30-NS: Black Specify Location
- TM31-NS: Silver Specify Location
- TM33-NS: Antique Brass Specify Location

Height Adjustable Worksurface

- LFT03: Adjustable height from 29" to 47.5" with a maximum weight capacity of 350 lbs - \$3790

Locking

- CL-01: Central locking - \$160

Molding

- DSM1: Delete Scalloped Only - Deduct - \$95

2 Select Finish

[Click to view finishes](#)

- WAC
- WIC
- WHC
- WOC
- WEW
- WGW
- WBW
- WSW
- WNW

- GAC
- GIC
- GHC
- GOC
- GEW
- GNW

3 Select Edge

[Click to view edges](#)



4 Select Hardware

[Click to view details](#)



Jamestown

Service Workstation Desk
Breakfront - Single Pedestal - Service Desk

[Click here to view statement of line](#)

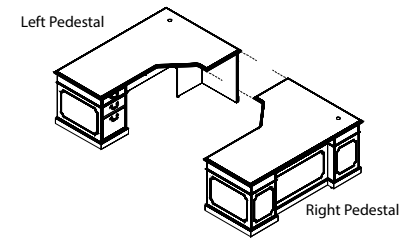

1 Select Model

w" x d" x h"
Left Pedestal
72 x 30/48 x 30
Right Pedestal
72 x 30/48 x 30

Weight	Standard Veneer Top Standard Veneer Chassis	Premium Veneer Top Premium Veneer Chassis	High Pressure Laminate Top Veneer Chassis	Thermally Fused Laminate Top Thermally Fused Laminate Chassis
325	JCM7248DS754W 5657	"P" Option N/A	JCM7248DS754G 5657	"M" Option N/A
325	JCM7248DS753W 5657	"P" Option N/A	JCM7248DS753G 5657	"M" Option N/A

Product Features

- 1 Standard grommet - matches pull finish or specify black TM30, silver TM31 or antique brass TM33
- Box/Box/File
- Full extension drawers - locking
- Kneespace storage Shelves
- Laminate pull out writing shelf

Options

Accessories

- K28: Articulating keyboard w/ mouse pad - \$390

Drawer

- K17: Traditional center drawer - \$235
- K21: Traditional Pull out drawer w/ keyboard tray - \$470

Grommets (Non-Standard Location)

Provide drawing w/ Grommet Location and Specify Color - \$95 ea.

- TM30-NS: Black Specify Location
- TM31-NS: Silver Specify Location
- TM33-NS: Antique Brass Specify Location

Molding

- DSM1: Delete Scalloped Only - Deduct \$95

Service Desk

- T90: Hardwood Edge Curve User Side - \$620
- T91: Hardwood Edge Approach Side Bowfront Edge - \$310

2 Select Finish

[Click to view finishes](#)

- WAC
- WIC
- WHC
- WOC
- WEW
- WGW
- WBW
- WSW
- WNW

- GAC
- GIC
- GHC
- GOC
- GEW
- GNW

3 Select Edge

[Click to view edges](#)



4 Select Hardware

[Click to view details](#)



Jamestown

"L" Workstation Returns
 Box/Box/File - Full Modesty/Base

[Click here to view statement of line](#)

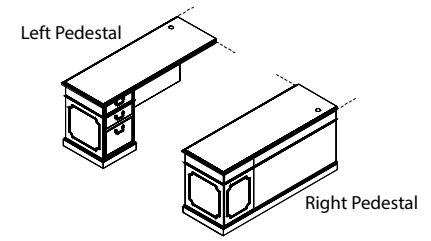

1 Select Model

w" x d" x h"	Weight
Left Pedestal	
60 x 24 x 30	165
48 x 24 x 30	150
42 x 24 x 30	140
Right Pedestal	
60 x 24 x 30	165
48 x 24 x 30	150
42 x 24 x 30	140

Standard Veneer Top Standard Veneer Chassis	Premium Veneer Top Premium Veneer Chassis	High Pressure Laminate Top Veneer Chassis	Thermally Fused Laminate Top Thermally Fused Laminate Chassis
JCM6024RE207W 3266	"P" Option N/A	JCM6024RE207G 3266	"M" Option N/A
JCM4824RE207W 3094	"P" Option N/A	JCM4824RE207G 3094	"M" Option N/A
JCM4224RE207W 2979	"P" Option N/A	JCM4224RE207G 2979	"M" Option N/A
JCM6024RE209W 3266	"P" Option N/A	JCM6024RE209G 3266	"M" Option N/A
JCM4824RE209W 3094	"P" Option N/A	JCM4824RE209G 3094	"M" Option N/A
JCM4224RE209W 2979	"P" Option N/A	JCM4224RE209G 2979	"M" Option N/A

2 Select Finish

[Click to view finishes](#)

- WAC
- WIC
- WHC
- WOC
- WEW
- WGW
- WBW
- WSW
- WNW

- GAC
- GIC
- GHC
- GOC
- GEW
- GNW

3 Select Edge

[Click to view edges](#)



4 Select Hardware

[Click to view details](#)



Product Features

- 1 Standard grommet - matches pull finish or specify black TM30, silver TM31 or antique brass TM33
- Coped ends for flush surface transition
- Fixed full modesty
- Full extension drawers - locking
- Soft close suspension drawer(s)

Options

Accessories

- K28: Articulating keyboard w/ mouse pad - \$390

Drawer

- K17: Traditional center drawer - \$235
- P40B: extra Box/Box/File or File/File to Kneespace - \$1025

Flush Cut

- FC-R: Flush Unit Right (Facing) for Ganging - \$100
- FC-L: Flush Unit Left (Facing) for Ganging - \$100

Grommets (Non-Standard Location)

Provide drawing w/ Grommet Location and Specify Color - \$95 ea.

- TM30-NS: Black Specify Location
- TM31-NS: Silver Specify Location
- TM33-NS: Antique Brass Specify Location

Modesty

- M34T: Drop Door Tech Modesty - \$130
- M51: Open Back Modesty with Wire Mgmt Rail - Deduct \$95

Molding

- DSM2: Beltline only/ Delete scalloped molding - Deduct \$50

Jamestown

"L" Workstation Returns
File/File - Full Modesty / Base

[Click here to view statement of line](#)

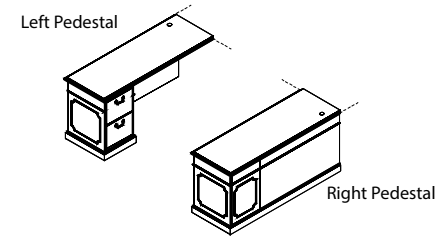

1 Select Model

w" x d" x h"	Weight
Left Pedestal	
60 x 24 x 30	180
48 x 24 x 30	160
42 x 24 x 30	150
Right Pedestal	
60 x 24 x 30	180
48 x 24 x 30	160
42 x 24 x 30	150

Standard Veneer Top Standard Veneer Chassis	Premium Veneer Top Premium Veneer Chassis	High Pressure Laminate Top Veneer Chassis	Thermally Fused Laminate Top Thermally Fused Laminate Chassis
JCM6024RE195W 3266	"P" Option N/A	JCM6024RE195G 3266	"M" Option N/A
JCM4824RE195W 3094	"P" Option N/A	JCM4824RE195G 3094	"M" Option N/A
JCM4224RE195W 2979	"P" Option N/A	JCM4224RE195G 2979	"M" Option N/A
JCM6024RE196W 3266	"P" Option N/A	JCM6024RE196G 3266	"M" Option N/A
JCM4824RE196W 3094	"P" Option N/A	JCM4824RE196G 3094	"M" Option N/A
JCM4224RE196W 2979	"P" Option N/A	JCM4224RE196G 2979	"M" Option N/A

Product Features

- 1 Standard grommet - matches pull finish or specify black TM30, silver TM31 or antique brass TM33
- Coped ends for flush surface transition
- Fixed full modesty
- Full extension drawers - locking
- Soft close suspension drawer(s)

Options

Accessories

- K28: Articulating keyboard w/ mouse pad - \$390

Drawer

- K17: Traditional center drawer - \$235
- P40B: extra Box/Box/File or File/File to Kneespace - \$1025

Flush Cut

- FC-R: Flush Unit Right (Facing) for Ganging - \$100
- FC-L: Flush Unit Left (Facing) for Ganging - \$100

Grommets (Non-Standard Location)

Provide drawing w/ Grommet Location and Specify Color - \$95 ea.

- TM30-NS: Black Specify Location
- TM31-NS: Silver Specify Location
- TM33-NS: Antique Brass Specify Location

Modesty

- M34T: Drop Door Tech Modesty - \$130
- M51: Open Back Modesty with Wire Mgmt Rail - Deduct \$95

Molding

- DSM2: Beltline only/ Delete scalloped molding - Deduct \$50

2 Select Finish

[Click to view finishes](#)

- WAC
- WIC
- WHC
- WOC
- WEW
- WGW
- WBW
- WSW
- WNW

- GAC
- GIC
- GHC
- GOC
- GEW
- GNW

3 Select Edge

[Click to view edges](#)



4 Select Hardware

[Click to view details](#)



Jamestown

"U" Workstation Bridges
Open Back Bridge

[Click here to view statement of line](#)

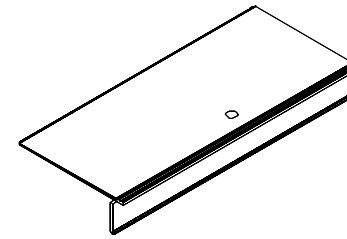

1 Select Model

w" x d" x h"	Weight
48 x 24 x 30	70
42 x 24 x 30	65
36 x 24 x 30	45

Standard Veneer Top Standard Veneer Chassis	Premium Veneer Top Premium Veneer Chassis	High Pressure Laminate Top Veneer Chassis	Thermally Fused Laminate Top Thermally Fused Laminate Chassis
JCM4824BR151W 1626	"P" Option N/A	JCM4824BR151G 1626	"M" Option N/A
JCM4224BR151W 1523	"P" Option N/A	JCM4224BR151G 1523	"M" Option N/A
JCM3624BR151W 1416	"P" Option N/A	JCM3624BR151G 1416	"M" Option N/A

Product Features

- 4"H back rail - open back
- Center grommet standard
- Coped ends for flush surface transition

Options

Accessories

- K28: Articulating keyboard w/ mouse pad - \$390

Drawer

- K17: Traditional center drawer - \$235

Grommets (Non-Standard Location)

Provide drawing w/ Grommet Location and Specify Color - \$95 ea.

- TM30-NS: Black Specify Location
- TM31-NS: Silver Specify Location
- TM33-NS: Antique Brass Specify Location

Modesty

- M37: "W" "G" Style Fixed Full Modesty w/ Molding - \$130
- M34T-O: "W" "G" Style Drop Door Tech Modesty - \$310

2 Select Finish

[Click to view finishes](#)

- WAC
- WIC
- WHC
- WOC
- WEW
- WGW
- WBW
- WSW
- WNW

- GAC
- GIC
- GHC
- GOC
- GEW
- GNW

3 Select Edge

[Click to view edges](#)



4 Select Hardware

[Click to view details](#)

Hardware
N/A

Hardware
N/A

Jamestown

Credenzas

File/File/Storage

[Click here to view statement of line](#)

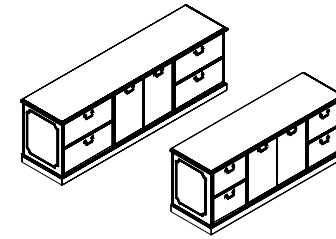

1 Select Model

w" x d" x h"

File/ File

72 x 24 x 30

66 x 24 x 30

Lateral File

89 x 24 x 30

Weight

280

250

425

		Standard Veneer Top Standard Veneer Chassis		Premium Veneer Top Premium Veneer Chassis		High Pressure Laminate Top Veneer Chassis		Thermally Fused Laminate Top Thermally Fused Laminate Chassis	
		JCM7224CA050W	4551	"P" Option N/A		JCM7224CA050G	4551	"M" Option N/A	
		JCM6624CA050W	4335	"P" Option N/A		JCM6624CA050G	4335	"M" Option N/A	
		JCM8924CA651W	8112	"P" Option N/A		JCM8924CA651G	8112	"M" Option N/A	

2 Select Finish

[Click to view finishes](#)

- WAC
- WIC
- WHC
- WOC
- WEW
- WGW
- WBW
- WSW
- WNW

- GAC
- GIC
- GHC
- GOC
- GEW
- GNW

3 Select Edge

[Click to view edges](#)



4 Select Hardware

[Click to view details](#)



Product Features

- 1 Adjustable veneer shelf behind door set
- File/File n/a w/ beltline molding
- Fronts profile shaped all edges
- Full pedestals feature File/File
- "W" & "G" Box and File Drawers feature soft close suspensions (Lateral Drawers Feature ball bearing suspensions)

Notes

- Unit has a black back panel and is not designed for open plan use.
- Select OPB Option for Open Plan application.

Options

Door

- D2: Door Lock - \$100 per door set
- D6: Delete Doors - n/c
- D9SC: Soft Close Door Hinges - \$20 per door

Drawer

- P6: Modify File/File to Box/Box/File - \$55 per pedestal
- PL-DBL: Add second pull to lateral file drawer - \$20 per Pull

Flush Cut

- FC-B: Flush Unit Both Sides(Facing) for Ganging - \$100
- FC-R: Flush Unit Right (Facing) for Ganging - \$100
- FC-L: Flush Unit Left (Facing) for Ganging - \$100

Grommet (Standard Location)

- Specify Color and Location (Right/Left/Center) - \$50 ea.
- Black: TM30-R (Right), TM30-L (Left), TM30-C (Center)
- Silver: TM31-R (Right), TM31-L (Left), TM31-C (Center)
- Antique Brass: TM33-R (Right), TM33-L (Left), TM33-C (Center)

Molding

- DSM2: Delete Scalloped Only - Deduct \$50
- SPM10: Add scallop panel molding to doors - \$70 per door

Open Plan _ Finished Back

- OPB: "W" "G" Style - Modify Unit for Open Plan Application - \$295

Jamestown

Credenzas
Kneespace - File/File

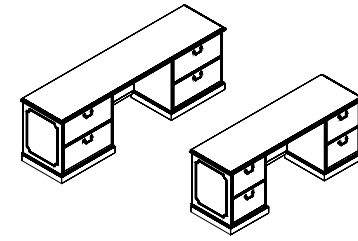

[Click here to view statement of line](#)

1 Select Model

w" x d" x h"
Lateral File
89 x 24 x 30
File/ File
72 x 24 x 30
66 x 24 x 30

Weight	Standard Veneer Top Standard Veneer Chassis	Premium Veneer Top Premium Veneer Chassis	High Pressure Laminate Top Veneer Chassis	Thermally Fused Laminate Top Thermally Fused Laminate Chassis
315	JCM8924CA052W 6501	"P" Option N/A	JCM8924CA052G 6501	"M" Option N/A
250	JCM7224CA054W 4370	"P" Option N/A	JCM7224CA054G 4370	"M" Option N/A
220	JCM6624CA054W 4193	"P" Option N/A	JCM6624CA054G 4193	"M" Option N/A

2 Select Finish

[Click to view finishes](#)

WAC
WIC
WHC
WOC
WEW
WGW
WBW
WSW
WNW

GAC
GIC
GHC
GOC
GEW
GNW

3 Select Edge

[Click to view edges](#)



4 Select Hardware

[Click to view details](#)



Product Features

- File/File
- Fronts profile shaped all edges
- Kneespace with full back panel
- "W" & "G" Box and File Drawers feature soft close suspensions (Lateral Drawers Feature ball bearing suspensions)

Notes

- Unit has a black back panel and is not designed for open plan use. Select OPB Option for Open Plan application.

Options

Accessories

- K28: Articulating keyboard w/ mouse pad - \$390

Drawer

- K17: Traditional center drawer - \$235
- K21: Traditional Pull out drawer w/ keyboard tray - \$470
- PL-DBL: Add second pull to lateral file drawer - \$20 per Pull

Flush Cut

- FC-B: Flush Unit Both Sides(Facing) for Ganging - \$100
- FC-R: Flush Unit Right (Facing) for Ganging - \$100
- FC-L: Flush Unit Left (Facing) for Ganging - \$100

Grommet (Standard Location)

- Specify Color - \$50 ea.
- Black: TM30-C (Center)
- Silver: TM31-C (Center)
- Antique Brass: TM33-C (Center)

Grommets (Non-Standard Location)

- Provide drawing w/ Grommet Location and Specify Color - \$95 ea.
- TM30-NS: Black Specify Location
- TM31-NS: Silver Specify Location
- TM33-NS: Antique Brass Specify Location

Locking

- CL-01: Central locking - \$160 (Only available when K17 is specified)

Modesty

- M34T: Drop Door Tech Modesty - \$130
- M51: Open Back Modesty with Wire Mgmt Rail - Deduct \$95

Molding

- DSM2: Delete Scalloped Only - Deduct \$50

Open Plan _ Finished Back

- OPB: "W" "G" Style - Modify Unit for Open Plan Application - \$295

Jamestown

Storage Credenza
Storage Credenza

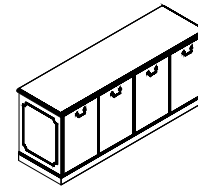

[Click here to view statement of line](#)

1 Select Model

w" x d" x h"	Weight
30" Height	
89 x 24 x 30	320
72 x 24 x 30	250
66 x 24 x 30	240
60 x 24 x 30	225
37 x 24 x 30	120

Standard Veneer Top Standard Veneer Chassis	Premium Veneer Top Premium Veneer Chassis	High Pressure Laminate Top Veneer Chassis	Thermally Fused Laminate Top Thermally Fused Laminate Chassis
JCM8924CA125W 6817	"P" Option N/A	JCM8924CA125G 6817	"M" Option N/A
JCM7224CA125W 5494	"P" Option N/A	JCM7224CA125G 5494	"M" Option N/A
JCM6624CA125W 5360	"P" Option N/A	JCM6624CA125G 5360	"M" Option N/A
JCM6024CA125W 5294	"P" Option N/A	JCM6024CA125G 5294	"M" Option N/A
JCM3724CA125W 2740	"P" Option N/A	JCM3724CA125G 2740	"M" Option N/A

2 Select Finish

[Click to view finishes](#)

- WAC
- WIC
- WHC
- WOC
- WEW
- WGW
- WBW
- WSW
- WNW

- GAC
- GIC
- GHC
- GOC
- GEW
- GNW

3 Select Edge

[Click to view edges](#)



4 Select Hardware

[Click to view details](#)



Product Features

- 1 Adjustable veneer shelf behind door set

Notes

- Unit has a black back panel and is not designed for open plan use. Select OPB Option for Open Plan application.

Options

Accessories

- REF-01: Modify storage section for refrigerator (Open back/water mat) - \$205

Door

- D2: Door Lock - \$100 per door set
- D6: Delete Doors - n/c
- D9SC: Soft Close Door Hinges - \$20 per door

Flush Cuts

- FC-B: Flush Unit Both Sides(Facing) for Ganging - \$100
- FC-R: Flush Unit Right (Facing) for Ganging - \$100
- FC-L: Flush Unit Right(Facing) for Ganging - \$100

Grommet (Standard Location)

- Specify Color and Location (Right/Left/Center) - \$50 ea.
- Black: TM30-R (Right), TM30-L (Left), TM30-C (Center)
- Silver: TM31-R (Right), TM31-L (Left), TM31-C (Center)
- Antique Brass: TM33-R (Right), TM33-L (Left), TM33-C (Center)

Grommets (Non-Standard Location)

- Provide drawing w/ Grommet Location and Specify Color - \$95 ea.
- TM30-NS: Black Specify Location
- TM31-NS: Silver Specify Location
- TM33-NS: Antique Brass Specify Location

Molding

- DSM2: Delete Scalloped Only - Deduct \$50

Open Plan _ Finished Back

- OPB: "W" "G" Style - Modify Unit for Open Plan Application - \$295

Jamestown

Lateral File Credenzas
6/4/2 Drawer

[Click here to view statement of line](#)

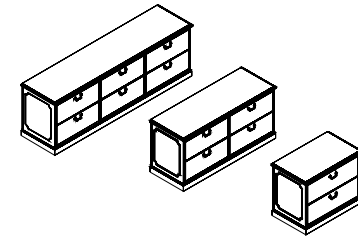

1 Select Model

w" x d" x h"	Weight
6 Drawer 89 x 24 x 30	440
4 Drawer 72 x 24 x 30	290
2 Drawer 60 x 24 x 30	250
2 Drawer 37 x 24 x 30	165
31 x 24 x 30	150

	Standard Veneer Top Standard Veneer Chassis	Premium Veneer Top Premium Veneer Chassis	High Pressure Laminate Top Veneer Chassis	Thermally Fused Laminate Top Thermally Fused Laminate Chassis
	JCM8924CA104W 8283	"P" Option N/A	JCM8924CA104G 8283	"M" Option N/A
	JCM7224CA104W 5442	"P" Option N/A	JCM7224CA104G 5442	"M" Option N/A
	JCM6024CA104W 5266	"P" Option N/A	JCM6024CA104G 5266	"M" Option N/A
	JCM3724CA104W 2777	"P" Option N/A	JCM3724CA104G 2777	"M" Option N/A
	JCM3124CA104W 2656	"P" Option N/A	JCM3124CA104G 2656	"M" Option N/A

2 Select Finish

[Click to view finishes](#)

- WAC
- WIC
- WHC
- WOC
- WEW
- WGW
- WBW
- WSW
- WNW

- GAC
- GIC
- GHC
- GOC
- GEW
- GNW

3 Select Edge

[Click to view edges](#)



4 Select Hardware

[Click to view details](#)



Product Features

- Legal/Letter Filing
- Features ball bearing suspensions, suspensions are full extension
- Top profile shaped 3 sides

Notes

- Unit has a black back panel and is not designed for open plan use.
- Select OPB Option for Open Plan application.

Options

Drawer

- PL-DBL: Add second pull to lateral file drawer - \$20 per Pull

Flush Cut

- FC-B: Flush Unit Both Sides(Facing) for Ganging - \$100
- FC-R: Flush Unit Right (Facing) for Ganging - \$100
- FC-L: Flush Unit Right(Facing) for Ganging - \$100

Molding

- DSM2: Delete Scalloped Only - Deduct - \$50

Open Plan _ Finished Back

- OPB: "W" "G" Style - Modify Unit for Open Plan Application - \$295

Jamestown

Lateral File Credenzas
Lateral File

[Click here to view statement of line](#)

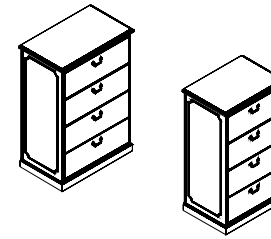

1 Select Model

w" x d" x h"
Four Drawer
37 x 24 x 54
31 x 24 x 54

Weight

Standard Veneer Top Standard Veneer Chassis	Premium Veneer Top Premium Veneer Chassis	High Pressure Laminate Top Veneer Chassis	Thermally Fused Laminate Top Thermally Fused Laminate Chassis
--	--	--	--

250
230

JCM3724FI111W 4644
JCM3124FI111W 4461

"P" Option N/A
"P" Option N/A

JCM3724FI111G 4644
JCM3124FI111G 4461

"M" Option N/A
"M" Option N/A

2 Select Finish

[Click to view finishes](#)

WAC
WIC
WHC
WOC
WEW
WGW
WBW
WSW
WNW

GAC
GIC
GHC
GOC
GEW
GNW

3 Select Edge

[Click to view edges](#)



4 Select Hardware

[Click to view details](#)



Product Features

- Legal/Letter Filing
- Features ball bearing suspensions, suspensions are full extension
- Top profile shaped 3 sides

Notes

- Unit has a black back panel and is not designed for open plan use. Select OPB Option for Open Plan application.

Options

Drawer

- PL-DBL: Add second pull to lateral file drawer - \$20 per Pull

Flush Cut

- FC-B: Flush Unit Both Sides(Facing) for Ganging - \$100
- FC-R: Flush Unit Right (Facing) for Ganging - \$100
- FC-L: Flush Unit Right(Facing) for Ganging - \$100

Molding

- DSM2: Delete Scalloped Only - Deduct - \$50

Open Plan _ Finished Back

- OPB: "W" "G" Style - Modify Unit for Open Plan Application - \$295

Jamestown

Buffet Credenza
Buffet Credenza

[Click here to view statement of line](#)

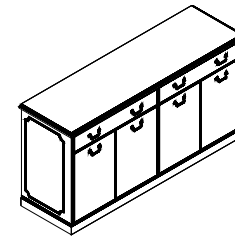

1 Select Model

w" x d" x h"
72 x 24 x 36
37 x 24 x 36

Weight
300
150

Standard Veneer Top Standard Veneer Chassis		Premium Veneer Top Premium Veneer Chassis		High Pressure Laminate Top Veneer Chassis		Thermally Fused Laminate Top Thermally Fused Laminate Chassis	
--	--	--	--	--	--	--	--

JCM7224CA126W	7080	"P" Option N/A		JCM7224CA126G	7080	"M" Option N/A	
JCM3724CA126W	3695	"P" Option N/A		JCM3724CA126G	3695	"M" Option N/A	

Product Features

- 1 Adjustable veneer shelf behind door set
- Full extension drawers - locking
- Soft close suspension drawer(s)
- Utility drawer w/ felt liner

Notes

- Unit has a black back panel and is not designed for open plan use. Select OPB Option for Open Plan application.

Options

Door

- D2: Door Lock - \$100 per door set
- D6: Delete Doors - n/c
- D9SC: Soft Close Door Hinges - \$20 per door

Flush Cut

- FC-B: Flush Unit Both Sides(Facing) for Ganging - \$100
- FC-R: Flush Unit Right (Facing) for Ganging - \$100
- FC-L: Flush Unit Left(Facing) for Ganging - \$100

Molding

- DSM2: Delete Scalloped Only - Deduct - \$50

Open Plan _ Finished Back

- OPB: "W" "G" Style - Modify Unit for Open Plan Application - \$295

2 Select Finish

[Click to view finishes](#)

- WAC
- WIC
- WHC
- WOC
- WEW
- WGW
- WBW
- WSW
- WNW

- GAC
- GIC
- GHC
- GOC
- GEW
- GNW

3 Select Edge

[Click to view edges](#)



4 Select Hardware

[Click to view details](#)



Jamestown

Workstation Credenzas
File/File

[Click here to view statement of line](#)

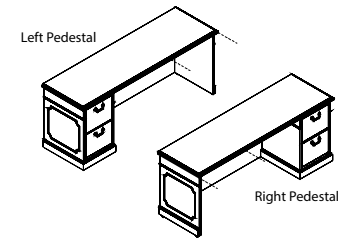

1 Select Model

w" x d" x h"	Weight
Left Pedestal	
72 x 24 x 30	175
66 x 24 x 30	160
Right Pedestal	
72 x 24 x 30	175
66 x 24 x 30	160

	Standard Veneer Top Standard Veneer Chassis	Premium Veneer Top Premium Veneer Chassis	High Pressure Laminate Top Veneer Chassis	Thermally Fused Laminate Top Thermally Fused Laminate Chassis
	JCM7224CA086W 4018	"P" Option N/A	JCM7224CA086G 4018	"M" Option N/A
	JCM6624CA086W 3838	"P" Option N/A	JCM6624CA086G 3838	"M" Option N/A
	JCM7224CA087W 4018	"P" Option N/A	JCM7224CA087G 4018	"M" Option N/A
	JCM6624CA087W 3838	"P" Option N/A	JCM6624CA087G 3838	"M" Option N/A

2 Select Finish

[Click to view finishes](#)

- WAC
- WIC
- WHC
- WOC
- WEW
- WGW
- WBW
- WSW
- WNW

- GAC
- GIC
- GHC
- GOC
- GEW
- GNW

3 Select Edge

[Click to view edges](#)



4 Select Hardware

[Click to view details](#)



Product Features

- File drawer reinforced for extra storage capacity
- Full extension drawers - locking
- Full panel modesty
- Legal/Letter filing
- Soft close suspension drawer(s)

Notes

- Unit has a black back panel and is not designed for open plan use. Select OPB Option for Open Plan application.

Options

Accessories

- K28: Articulating keyboard w/ mouse pad - \$390

Drawer

- P6: Modify File/File to Box/Box/File - \$55 per pedestal
- P40B: extra Box/Box/File or File/File to Kneespace - \$1025

Flush Cut

- FC-B: Flush Unit Both Sides(Facing) for Ganging - \$100
- FC-R: Flush Unit Right (Facing) for Ganging - \$100
- FC-L: Flush Unit Left (Facing) for Ganging - \$100

Grommet (Standard Location)

Specify Color - \$50 ea.

- Black: TM30-C (Center)
- Silver: TM31-C (Center)
- Antique Brass: TM33-C (Center)

Grommets (Non-Standard Location)

Provide drawing w/ Grommet Location and Specify Color - \$95 ea.

- TM30-NS: Black Specify Location
- TM31-NS: Silver Specify Location
- TM33-NS: Antique Brass Specify Location

Modesty

- M34T: Drop Door Tech Modesty - \$130
- M51: Open Back Modesty with Wire Mgmt Rail - Deduct \$95

Molding

- DSM2: Beltline only/ Delete scalloped molding - Deduct \$50

Open Plan _ Finished Back

- OPB: Modify Unit for Open Plan Application - \$295

Jamestown
Workstation Credenzas
Lateral File

[Click here to view statement of line](#)

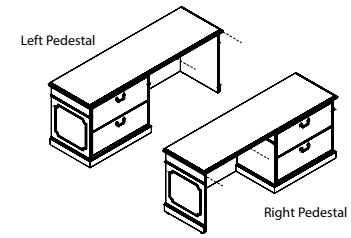

1 Select Model

w" x d" x h"	Weight
89 x 24 x 30	240
72 x 24 x 30	200
66 x 24 x 30	185
Right Pedestal	
89 x 24 x 30	240
72 x 24 x 30	200
66 x 24 x 30	185

	Standard Veneer Top Standard Veneer Chassis	Premium Veneer Top Premium Veneer Chassis	High Pressure Laminate Top Veneer Chassis	Thermally Fused Laminate Top Thermally Fused Laminate Chassis
	JCM8924CA066W 4997	"P" Option N/A	JCM8924CA066G 4997	"M" Option N/A
	JCM7224CA066W 4644	"P" Option N/A	JCM7224CA066G 4644	"M" Option N/A
	JCM6624CA066W 4461	"P" Option N/A	JCM6624CA066G 4461	"M" Option N/A
	JCM8924CA067W 4997	"P" Option N/A	JCM8924CA067G 4997	"M" Option N/A
	JCM7224CA067W 4644	"P" Option N/A	JCM7224CA067G 4644	"M" Option N/A
	JCM6624CA067W 4461	"P" Option N/A	JCM6624CA067G 4461	"M" Option N/A

2 Select Finish

[Click to view finishes](#)

- WAC
- WIC
- WHC
- WOC
- WEW
- WGW
- WBW
- WSW
- WNW

- GAC
- GIC
- GHC
- GOC
- GEW
- GNW

3 Select Edge

[Click to view edges](#)



4 Select Hardware

[Click to view details](#)



Product Features

- Full back panel
- Lateral file drawer reinforced for extra storage capacity
- Legal/Letter filing
- Features ball bearing suspensions, suspensions are full extension

Notes

- Center drawers/keyboards n/a on 72" / 66" - 2 drawer lateral file credenzas
- Unit has a black back panel and is not designed for open plan use. Select OPB Option for Open Plan application.

Options

Accessories

- K28: Articulating keyboard w/ mouse pad - \$390

Drawer

- P40B: extra Box/Box/File or File/File to Kneespace - \$1025
- PL-DBL: Add second pull to lateral file drawer - \$20 per Pull

Flush Cut

- FC-B: Flush Unit Both Sides(Facing) for Ganging - \$100
- FC-R: Flush Unit Right (Facing) for Ganging - \$100
- FC-L: Flush Unit Left (Facing) for Ganging - \$100

Grommet (Standard Location)

- Specify Color - \$50 ea.
- Black: TM30-C (Center)
 - Silver: TM31-C (Center)
 - Antique Brass: TM33-C (Center)

Grommets (Non-Standard Location)

- Provide drawing w/ Grommet Location and Specify Color - \$95 ea.
- TM30-NS: Black Specify Location
 - TM31-NS: Silver Specify Location
 - TM33-NS: Antique Brass Specify Location

Modesty

- M34T: Drop Door Tech Modesty - \$130
- M51: Open Back Modesty with Wire Mgmt Rail - Deduct \$95

Molding

- DSM2: Beltline only/ Delete scalloped molding - Deduct \$50

Open Plan _ Finished Back

- OPB: Modify Unit for Open Plan Application - \$295

Jamestown

Single Height Overheads
Panel Door With Cornice Top

[Click here to view statement of line](#)

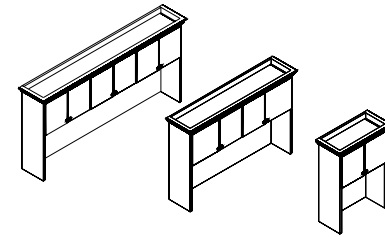

1 Select Model

w" x d" x h"	Weight
6 Door	
93 x 15 x 44	375
87 x 15 x 44	325
4 Door	
70 x 15 x 44	250
64 x 15 x 44	220
58 x 15 x 44	190
2 Door	
35 x 15 x 44	150
29 x 15 x 44	140

	Standard Veneer Top Standard Veneer Chassis	Premium Veneer Top Premium Veneer Chassis	High Pressure Laminate Top Veneer Chassis	Thermally Fused Laminate Top Thermally Fused Laminate Chassis
JCM9344OH325W 6729		"P" Option N/A	"G" Option N/A	"M" Option N/A
JCM8744OH325W 6235		"P" Option N/A	"G" Option N/A	"M" Option N/A
JCM7044OH325W 5554		"P" Option N/A	"G" Option N/A	"M" Option N/A
JCM6444OH325W 5217		"P" Option N/A	"G" Option N/A	"M" Option N/A
JCM5844OH325W 5045		"P" Option N/A	"G" Option N/A	"M" Option N/A
JCM3544OH325W 3524		"P" Option N/A	"G" Option N/A	"M" Option N/A
JCM2944OH325W 3189		"P" Option N/A	"G" Option N/A	"M" Option N/A

2 Select Finish

[Click to view finishes](#)

- WAC
- WIC
- WHC
- WOC
- WEW
- WGW
- WBW
- WSW
- WNW

3 Select Edge

[Click to view edges](#)

Edge
N/A

4 Select Hardware

[Click to view details](#)

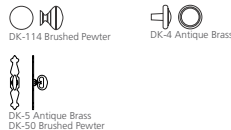

Product Features

- 23 -3/4" Under cabinet clearance
- Cornice top
- 5/8" grommet(s) included for task light wire management
- Interior cabinet depth 12.5"

Notes

- Unit has black back panel and is not designed for Open Plan use. Select OPB Option for Open Plan application

Options

Door

- D2: Door Lock - \$100 per door set
- D6: Delete Doors - n/c
- D9SC: Soft Close Door Hinges - \$20 per door

Flush Cut

- FC-B: Flush Unit Both Sides(Facing) for Ganging - \$100
- FC-R: Flush Unit Right (Facing) for Ganging - \$100
- FC-L: Flush Unit Left (Facing) for Ganging - \$100

Grommets (Vertical Surface)

- Standard Location - \$50 ea.
- Black Plastic Vertical Surface: TM50-C (Bottom Center)
- Non-Standard Location - \$95 ea.
- Black Plastic Vertical Surface: TM50-NS

Task Lighting

- Overhead task light cord is located on the right facing side. If the opposite location is required please contact customer service.
- LT-LED24: 24" LED Task light - \$215
- LT-LED48: 48" LED Task light - \$270
- LT-LED60: 60" LED Task light - \$335
- LT-LED72: 72" LED Task light - \$360

Open Plan _ Finished Back

- OPB: "W" "G" Style - Modify Unit for Open Plan Application - \$395

Jamestown

Single Height Overheads
 Frame Door With Beveled Glass Cornice Top

[Click here to view statement of line](#)

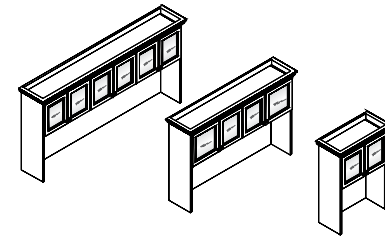

1 Select Model

w" x d" x h"	Weight
6 Door	
93 x 15 x 44	375
87 x 15 x 44	325
4 Door	
70 x 15 x 44	250
64 x 15 x 44	220
58 x 15 x 44	190
2 Door	
35 x 15 x 44	150
29 x 15 x 44	140

	Standard Veneer Top Standard Veneer Chassis	Premium Veneer Top Premium Veneer Chassis	High Pressure Laminate Top Veneer Chassis	Thermally Fused Laminate Top Thermally Fused Laminate Chassis
	JCM9344OH447W 7065	"P" Option N/A	"G" Option N/A	"M" Option N/A
	JCM8744OH447W 6570	"P" Option N/A	"G" Option N/A	"M" Option N/A
	JCM7044OH447W 5727	"P" Option N/A	"G" Option N/A	"M" Option N/A
	JCM6444OH447W 5388	"P" Option N/A	"G" Option N/A	"M" Option N/A
	JCM5844OH447W 5045	"P" Option N/A	"G" Option N/A	"M" Option N/A
	JCM3544OH447W 3698	"P" Option N/A	"G" Option N/A	"M" Option N/A
	JCM2944OH447W 3356	"P" Option N/A	"G" Option N/A	"M" Option N/A

Product Features

- 23 -3/4" Under cabinet clearance
- Beveled clear glass
- Cornice top
- 5/8" grommet(s) included for task light wire management
- Interior cabinet depth 12.5"
- Solid wood door frame

Notes

- Unit has black back panel and is not designed for Open Plan use. Select OPB Option for Open Plan application

Options

Door

- D2: Door Lock - \$100 per door set
- D6: Delete Doors - n/c
- D9SC: Soft Close Door Hinges - \$20 per door
- D35: Optional Wood Panel Insert - \$35 per individual panel insert

Flush Cut

- FC-B: Flush Unit Both Sides(Facing) for Ganging - \$100
- FC-R: Flush Unit Right (Facing) for Ganging - \$100
- FC-L: Flush Unit Left (Facing) for Ganging - \$100

Grommets (Vertical Surface)

- Standard Location - \$50 ea.
- Black Plastic Vertical Surface: TM50-C (Bottom Center)
- Non-Standard Location - \$95 ea.
- Black Plastic Vertical Surface: TM50-NS

Interior Cabinet Lighting

- LEDPK starter kit includes Infeed, 1 Puck Interior Light and the ability to daisy chain up to 6 total Puck Lights
- LEDPK: LED Puck Starter Kit - \$310
- PK: 1 LED Interior Light - \$130

Task Lighting

- Overhead task light cord is located on the right facing side. If the opposite location is required please contact customer service.
- LT-LED24: 24" LED Task light - \$215
- LT-LED48: 48" LED Task light - \$270
- LT-LED60: 60" LED Task light - \$335
- LT-LED72: 72" LED Task light - \$360

Open Plan _ Finished Back

- OPB: "W" "G" Style - Modify Unit for Open Plan Application - \$395

2 Select Finish

[Click to view finishes](#)

- WAC
- WIC
- WHC
- WOC
- WEW
- WGW
- WBW
- WSW
- WNW

3 Select Edge

[Click to view edges](#)

- Edge
- N/A

4 Select Hardware

[Click to view details](#)

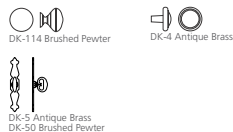

Jamestown

Double Height Overheads
Overhead Panel Doors/Cornice Top

[Click here to view statement of line](#)

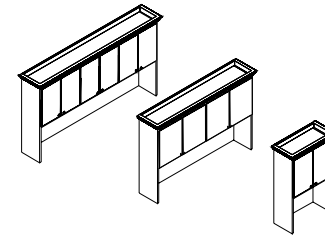

1 Select Model

Weight	w" x d" x h"
	6 Door (3 Section)
335	93 x 15 x 51
325	87 x 15 x 51
	4 Door (2 Section)
300	83 x 15 x 51
275	76 x 15 x 51
250	70 x 15 x 51
250	64 x 15 x 51
215	58 x 15 x 51
185	47 x 15 x 51
	2 Door (1 Section)
160	35 x 15 x 51
140	29 x 15 x 51

	Standard Veneer Top Standard Veneer Chassis	Premium Veneer Top Premium Veneer Chassis	High Pressure Laminate Top Veneer Chassis	Thermally Fused Laminate Top Thermally Fused Laminate Chassis
JCM9351OH325W 7738		"P" Option N/A	"G" Option N/A	"M" Option N/A
JCM8751OH325W 7171		"P" Option N/A	"G" Option N/A	"M" Option N/A
JCM8351OH325W 6917		"P" Option N/A	"G" Option N/A	"M" Option N/A
JCM7651OH325W 6718		"P" Option N/A	"G" Option N/A	"M" Option N/A
JCM7051OH325W 6387		"P" Option N/A	"G" Option N/A	"M" Option N/A
JCM6451OH325W 6001		"P" Option N/A	"G" Option N/A	"M" Option N/A
JCM5851OH325W 5801		"P" Option N/A	"G" Option N/A	"M" Option N/A
JCM4751OH325W 4452		"P" Option N/A	"G" Option N/A	"M" Option N/A
JCM3551OH325W 4054		"P" Option N/A	"G" Option N/A	"M" Option N/A
JCM2951OH325W 3667		"P" Option N/A	"G" Option N/A	"M" Option N/A

2 Select Finish

[Click to view finishes](#)

- WAC
- WIC
- WHC
- WOC
- WEW
- WGW
- WBW
- WSW
- WNW

3 Select Edge

[Click to view edges](#)

- Edge
- N/A

4 Select Hardware

[Click to view details](#)

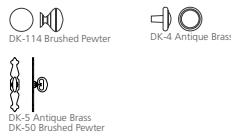

Product Features

- 21 -1/2" Under cabinet clearance
- Cornice top
- Finished wood shelves
- Interior shelf depth 12.5"
- 5/8" grommet(s) included for task light wire management

Notes

- Unit has black back panel and is not designed for Open Plan use. Select OPB Option for Open Plan application

Options

Door

- D2: Door Lock - \$100 per door set
- D6: Delete Doors - n/c
- D9SC: Soft Close Door Hinges - \$20 per door

Flush Cut

- FC-B: Flush Unit Both Sides(Facing) for Ganging - \$100
- FC-R: Flush Unit Right (Facing) for Ganging - \$100
- FC-L: Flush Unit Left (Facing) for Ganging - \$100

Grommets (Vertical Surface)

- Standard Location - \$50 ea.
- Black Plastic Vertical Surface: TM50-C (Bottom Center)
- Non-Standard Location - \$95 ea.
- Black Plastic Vertical Surface: TM50-NS

Task Lighting

- Overhead task light cord is located on the right facing side. If the opposite location is required please contact customer service.
- LT-LED24: 24" LED Task light - \$215
- LT-LED48: 48" LED Task light - \$270
- LT-LED60: 60" LED Task light - \$335
- LT-LED72: 72" LED Task light - \$360

Open Plan _ Finished Back

- OPB: "W" "G" Style - Modify Unit for Open Plan Application - \$395

Shelves

- S714F: Replace standard shelves with heavy duty 1" thick wood shelf - \$80 per shelf

Jamestown

Double Height Overheads
Overhead Wood Panel/Cornice Top

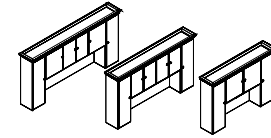

[Click here to view statement of line](#)

1 Select Model

w" x d" x h"	Weight
6 Door (3 Section)	
70 x 15 x 51	290
64 x 15 x 51	270

Standard Veneer Top Standard Veneer Chassis		Premium Veneer Top Premium Veneer Chassis	High Pressure Laminate Top Veneer Chassis	Thermally Fused Laminate Top Thermally Fused Laminate Chassis
--	--	--	--	--

JCM7051OH420W	7541	"P" Option N/A	"G" Option N/A	"M" Option N/A
JCM6451OH420W	7198	"P" Option N/A	"G" Option N/A	"M" Option N/A

Product Features

- 21 -1/2" Under cabinet clearance
- Cornice top
- Wood shelves
- Interior shelf depth 12"
- 5/8" grommet(s) included for task light wire management

Notes

- Unit has black back panel and is not designed for Open Plan use. Select OPB Option for Open Plan application
- 116" - 99" units - shipped in 4 sections
- 87" - 70" units assembled
- Towers are 14 1/2" or 17 1/2" depending on unit size

Options

Door

- D2: Door Lock - \$100 per door set
- D6: Delete Doors - n/c
- D35: Optional wood panel insert - \$30 per individual panel insert

Flush Cut

- FC-B: Flush Unit Both Sides(Facing) for Ganging - \$100
- FC-R: Flush Unit Right (Facing) for Ganging - \$100
- FC-L: Flush Unit Left (Facing) for Ganging - \$100

Grommets (Vertical Surface)

- Standard Location - \$50 ea.
- Black Plastic Vertical Surface: TM50-C (Bottom Center)
- Non-Standard Location - \$95 ea.
- Black Plastic Vertical Surface: TM50-NS

Interior Cabinet Lighting

- LEDPK starter kit includes Infeed, 1 Puck Interior Light and the ability to daisy chain up to 6 total Puck Lights
- LEDPK: LED Puck Starter Kit - \$310
- PK: 1 LED Interior Light - \$130

Task Lighting

- LT-LED24: 24" LED Task light - \$215
- LT-LED48: 48" LED Task light - \$270
- LT-LED60: 60" LED Task light - \$335

Open Plan _ Finished Back

- OPB: "W" "G" Style - Modify Unit for Open Plan Application - \$395

Shelves

- GS14F: Replace Standard Shelves with Glass Shelves - \$90 per shelf

2 Select Finish

[Click to view finishes](#)

- WAC
- WIC
- WHC
- WOC
- WEW
- WGW
- WBW
- WSW
- WNW

3 Select Edge

[Click to view edges](#)

- Edge
- N/A

4 Select Hardware

[Click to view details](#)

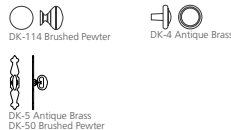

Jamestown

Double Height Overheads
Wood Frame Door With Beveled Glass/Cornice Top

[Click here to view statement of line](#)

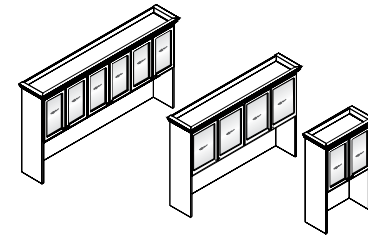

1 Select Model

w" x d" x h"	Weight
6 Door (3 Section)	
93 x 15 x 51	335
87 x 15 x 51	325
4 Door (2 Section)	
70 x 15 x 51	250
64 x 15 x 51	250
58 x 15 x 51	215
2 Door (1 Section)	
35 x 15 x 51	160
29 x 15 x 51	140

	Standard Veneer Top Standard Veneer Chassis	Premium Veneer Top Premium Veneer Chassis	High Pressure Laminate Top Veneer Chassis	Thermally Fused Laminate Top Thermally Fused Laminate Chassis
JCM9351OH447W 8124		"P" Option N/A	"G" Option N/A	"M" Option N/A
JCM8751OH447W 7555		"P" Option N/A	"G" Option N/A	"M" Option N/A
JCM7051OH447W 6584		"P" Option N/A	"G" Option N/A	"M" Option N/A
JCM6451OH447W 6196		"P" Option N/A	"G" Option N/A	"M" Option N/A
JCM5851OH447W 5801		"P" Option N/A	"G" Option N/A	"M" Option N/A
JCM3551OH447W 4254		"P" Option N/A	"G" Option N/A	"M" Option N/A
JCM2951OH447W 3858		"P" Option N/A	"G" Option N/A	"M" Option N/A

2 Select Finish

[Click to view finishes](#)

- WAC
- WIC
- WHC
- WOC
- WEW
- WGW
- WBW
- WSW
- WNW

3 Select Edge

[Click to view edges](#)

Edge
N/A

4 Select Hardware

[Click to view details](#)

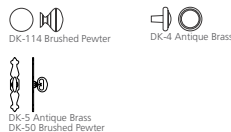

Product Features

- 21 -1/2" Under cabinet clearance
- Beveled clear glass
- Cornice top
- Finished wood shelves
- 5/8" grommet(s) included for task light wire management
- Interior shelf depth 12.5"
- Solid wood door frame

Notes

- Unit has black back panel and is not designed for Open Plan use. Select OPB Option for Open Plan application

Options

- Door**
- D2: Door Lock - \$100 per door set
 - D6: Delete Doors - n/c
 - D9SC: Soft Close Door Hinges - \$20 per door
 - D35: Optional Wood Panel Insert - \$35 per individual panel insert

Flush Cut

- FC-B: Flush Unit Both Sides(Facing) for Ganging - \$100
- FC-R: Flush Unit Right (Facing) for Ganging - \$100
- FC-L: Flush Unit Left (Facing) for Ganging - \$100

Grommets (Vertical Surface)

- Standard Location - \$50 ea.
- Black Plastic Vertical Surface: TM50-C (Bottom Center)
- Non-Standard Location - \$95 ea.
- Black Plastic Vertical Surface: TM50-NS

Interior Cabinet Lighting

- LEDPK starter kit includes Infeed, 1 Puck Interior Light and the ability to daisy chain up to 6 total Puck Lights
- LEDPK: LED Puck Starter Kit - \$310
- PK: 1 LED Interior Light - \$130

Task Lighting

- Overhead task light cord is located on the right facing side. If the opposite location is required please contact customer service.
- LT-LED24: 24" LED Task light - \$215
- LT-LED48: 48" LED Task light - \$270
- LT-LED60: 60" LED Task light - \$335
- LT-LED72: 72" LED Task light - \$360

Open Plan _ Finished Back

- OPB: "W" "G" Style - Modify Unit for Open Plan Application - \$395

Shelves

- GS14F: Replace Standard Shelves with Glass Shelves - \$90 per shelf
- S714F: Replace standard shelves with heavy duty 1" thick wood shelf - \$80 per shelf

Jamestown

Double Height Overheads
Beveled Glass Doors/Cornice Top

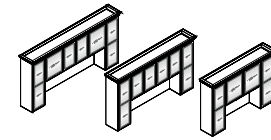

[Click here to view statement of line](#)

1 Select Model

w" x d" x h"	Weight
3 Section	
70 x 15 x 51	290
64 x 15 x 51	270

	Standard Veneer Top Standard Veneer Chassis	Premium Veneer Top Premium Veneer Chassis	High Pressure Laminate Top Veneer Chassis	Thermally Fused Laminate Top Thermally Fused Laminate Chassis
	JCM7051OH430W 7689 JCM6451OH430W 7345	"P" Option N/A "P" Option N/A	"G" Option N/A "G" Option N/A	"M" Option N/A "M" Option N/A

Product Features

- 21 -1/2" Under cabinet clearance
- Beveled clear glass
- Cornice top
- Wood shelves (1 shelf in each bridge section)
- 5/8" grommet(s) included for task light wire management
- Interior shelf depth 12"
- Solid wood door frame
- Interior cabinet depth 12.5"

Notes

- Unit has black back panel and is not designed for Open Plan use. Select OPB Option for Open Plan application
- 116" - 99" units - shipped in 4 sections
- 87" - 70" units assembled
- Towers are 14 1/2" or 17 1/2" depending on unit size

Options

Door

- D2: Door Lock - \$100 per door set
- D6: Delete Doors - n/c
- D9SC: Soft Close Door Hinges - \$20 per door
- D35: Optional Wood Panel Insert - \$35 per individual panel insert
- DGR-01: Wire grill door insert - \$160 per door panel

Flush Cut

- FC-B: Flush Unit Both Sides(Facing) for Ganging - \$100
- FC-R: Flush Unit Right (Facing) for Ganging - \$100
- FC-L: Flush Unit Left (Facing) for Ganging - \$100

Grommets (Vertical Surface)

- Standard Location - \$50 ea.
- Black Plastic Vertical Surface: TM50-C (Bottom Center)
- Non-Standard Location - \$95 ea.
- Black Plastic Vertical Surface: TM50-NS

Interior Cabinet Lighting

- LEDPK starter kit includes Infeed, 1 Puck Interior Light and the ability to daisy chain up to 6 total Puck Lights
- LEDPK: LED Puck Starter Kit - \$310
- PK: 1 LED Interior Light - \$130

Task Lighting

- LT-LED24: 24" LED Task light - \$215
- LT-LED48: 48" LED Task light - \$270
- LT-LED60: 60" LED Task light - \$335

Open Plan

- OPB: "W" "G" Style - Modify Unit for Open Plan Application - \$395

Shelves

- GS14F: Replace Standard Shelves with Glass Shelves - \$90 per shelf

2 Select Finish

[Click to view finishes](#)

- WAC
- WIC
- WHC
- WOC
- WEW
- WGW
- WBW
- WSW
- WNW

3 Select Edge

[Click to view edges](#)

Edge
N/A

4 Select Hardware

[Click to view details](#)

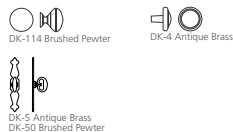

Overhead tackboard
Full width tackboards

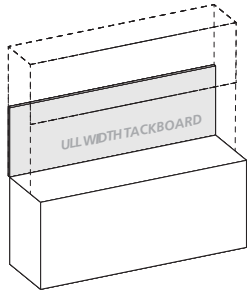

Product Width	Panel Dimension	SKU	COM	1	2	3	4	5	6	7	8	9	10	11/L1	12	13/L2
93"	91 x .75 x 21	FTOC9121	379	480	531	582	633	684	735	786	837	888	939	990	1041	1143
87"	85 x .75 x 21	FTOC8521	358	449	497	545	593	641	689	737	785	833	881	929	977	1073
83"	81 x .75 x 21	FTOC8121	336	428	474	520	566	612	658	704	750	796	842	888	934	1026
76"	74 x .75 x 21	FTOC7421	309	392	435	478	521	564	607	650	693	736	779	822	865	951
70"	68 x .75 x 21	FTOC6821	282	361	401	441	481	521	561	601	641	681	721	761	801	881
64"	62 x .75 x 21	FTOC6221	256	330	366	402	438	474	510	546	582	618	654	690	726	798
58"	56 x .75 x 21	FTOC5621	234	299	331	363	395	427	459	491	523	555	587	619	651	715
47"	45 x .75 x 21	FTOC4521	187	242	269	296	323	350	377	404	431	458	485	512	539	593
35"	33 x .75 x 21	FTOC3321	141	180	200	220	240	260	280	300	320	340	360	380	400	440
29"	27 x .75 x 21	FTOC2721	112	149	166	183	200	217	234	251	268	285	302	319	336	370

Standard Features

- Constructed of .5" thick fiberboard
- Fabric is precisely aligned and fitted to the tackboard
- Adhered to the rigid hardboard with staples
- Hung with Z-Strip mounting system

Notes

- Fabric Tack Panels are raised 3" from bottom edge when TM50 grommet is ordered

Overhead tackboard
Half width tackboards

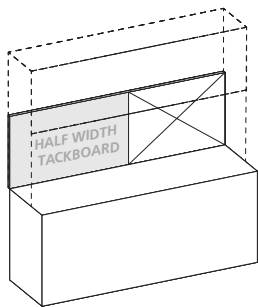

Product Width	Panel Dimension	SKU	COM	1	2	3	4	5	6	7	8	9	10	11/L1	12	13/L2
93 Half Width	45.5 x .75 x 21	FTOC4521	189	240	266	292	318	344	370	396	422	448	474	500	526	578
87 Half Width	42.5 x .75 x 21	FTOC4221	179	225	249	273	297	321	345	369	393	417	441	465	489	537
83 Half Width	40.5 x .75 x 21	FTOC4021	168	214	237	260	283	306	329	352	375	398	421	444	467	513
76 Half Width	37 x .75 x 21	FTOC3721	155	196	217	238	259	280	301	322	343	364	385	406	427	469
70 Half Width	34 x .75 x 21	FTOC3421	141	180	200	220	240	260	280	300	320	340	360	380	400	440
64 Half Width	31 x .75 x 21	FTOC3121	128	165	183	201	219	237	255	273	291	309	327	345	363	399

Standard Features

- Constructed of .5" thick fiberboard
- Fabric is precisely aligned and fitted to the tackboard
- Adhered to the rigid hardboard with staples
- Hung with Z-Strip mounting system

Notes

- Half width tackboards can be specified and combined with a Veneer Panel, Marker Board, Slat Wall or Glass Board. See "Half Width" items under product width.
- Specify right or left facing tackboard
- Fabric Tack Panels are raised 3" from bottom edge when TM50 grommet is ordered

Overhead dry marker board
Full width dry marker board

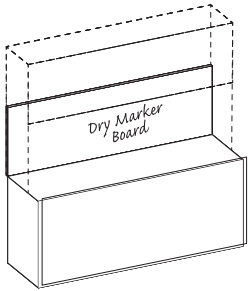

Product Width	Panel Dimension	SKU	List
93	91 x .5 x 21	DMOC9121	1136
87	85 x .5 x 21	DMOC8521	1061
83	81 x .5 x 21	DMOC8121	1011
76	74 x .5 x 21	DMOC7421	924
70	68 x .5 x 21	DMOC6821	849
64	62 x .5 x 21	DMOC6221	774
58	56 x .5 x 21	DMOC5621	699
47	45 x .5 x 21	DMOC4521	587
35	33 x .5 x 21	DMOC3321	437
29	27 x .5 x 21	DMOC2721	337

Standard Features

- Dry marker panel has edge trim molding
- Standard magnetic surface
- Hung with Z-Strip mounting system

Overhead dry marker board
Half width dry marker board

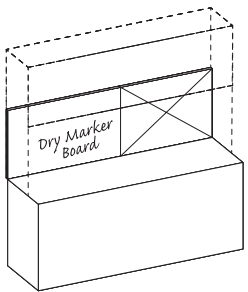

Product Width	Panel Dimension	SKU	List
93 Half Width	45.5 x .5 x 21	DMOC4521	555
87 Half Width	42.5 x .5 x 21	DMOC4221	518
83 Half Width	40.5 x .5 x 21	DMOC4021	493
76 Half Width	37 x .5 x 21	DMOC3721	449
70 Half Width	34 x .5 x 21	DMOC3421	437
64 Half Width	31 x .5 x 21	DMOC3121	374

Standard Features

- Dry marker panel has edge trim molding
- Standard magnetic surface
- Hung with Z-Strip mounting system

Notes

- Half width dry marker boards can be specified and combined with a Tackboard, Veneer Panel, Slat Wall or Glass Board. See "Half Width" items under product width.
- Specify right or left facing dry marker board

Overhead glassboard
Full width glassboard

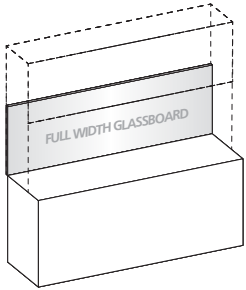

Product Width	Panel Dimension	SKU	List
93	91 x .5 x 21	GBOC9121	2382
87	85 x .5 x 21	GBOC8521	2236
83	81 x .5 x 21	GBOC8121	2138
76	74 x .5 x 21	GBOC7421	1969
70	68 x .5 x 21	GBOC6821	1822
64	62 x .5 x 21	GBOC6221	1676
58	56 x .5 x 21	GBOC5621	1531
47	45 x .5 x 21	GBOC4521	1264
35	33 x .5 x 21	GBOC3321	972
29	27 x .5 x 21	GBOC2721	826

Standard Features

- 4 mm tempered glass

Notes

- Earth magnets are required to hold items securely in place
- Hung with Z-Strip mounting system
- Use glass cleaner or alcohol to clean
- Standard dry erase markers may be used

Overhead glassboard
Half width glassboard

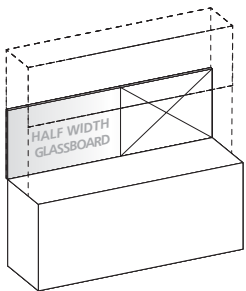

Product Width	Panel Dimension	SKU	List
93 Half Width	45.5 x .5 x 21	GBOC4521	1251
87 Half Width	42.5 x .5 x 21	GBOC4221	1178
83 Half Width	40.5 x .5 x 21	GBOC4021	1129
76 Half Width	37 x .5 x 21	GBOC3721	985
70 Half Width	34 x .5 x 21	GBOC3421	972
64 Half Width	31 x .5 x 21	GBOC3121	899

Standard Features

- 4 mm tempered glass

Notes

- Half width glassboards can be specified and combined with a Tackboard, Veneer panel, Marker Board or Slat Wall. See "Half Width" items under product width.
- Specify right or left facing glassboard
- Use glass cleaner or alcohol to clean
- Standard dry erase markers may be used
- Earth magnets are required to hold items securely in place
- Hung with Z-Strip mounting system

Overhead slat wall
Half width slat wall

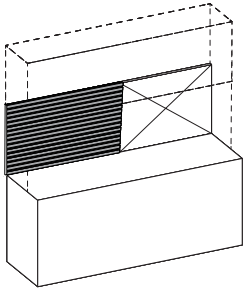

Product Width	Panel Dimension	SKU	List
93 Half Width	45.5 x .5 x 21	SWOC4521	463
87 Half Width	42.5 x .5 x 21	SWOC4221	432
83 Half Width	40.5 x .5 x 21	SWOC4021	411
76 Half Width	37 x .5 x 21	SWOC3721	374
70 Half Width	34 x .5 x 21	SWOC3421	343
64 Half Width	31 x .5 x 21	SWOC3121	312

Standard Features

- Available in silver or black
- For use on 42"/43" height consoles
- Hung with Z-Strip mounting system

Notes

- Half width slat walls can be specified and combined with a Tackboard, Veneer panel, Marker Board or Glassboard. See "Half Width" items under product width.
- Specify right or left facing slat wall

Jamestown

Single Height Wall Hung Overheads
Panel Door

[Click here to view statement of line](#)

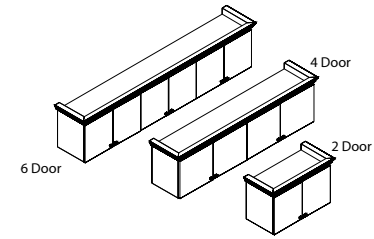

1 Select Model

w" x d" x h"	Weight
6 Door	
93 x 15 x 20	190
87 x 15 x 20	175
4 Door	
70 x 15 x 20	145
64 x 15 x 20	130
58 x 15 x 20	120
2 Door	
35 x 15 x 20	75
29 x 15 x 20	65

	Standard Veneer Top Standard Veneer Chassis	Premium Veneer Top Premium Veneer Chassis	High Pressure Laminate Top Veneer Chassis	Thermally Fused Laminate Top Thermally Fused Laminate Chassis
	JCM9320WH330W 5749	"P" Option N/A	"G" Option N/A	"M" Option N/A
	JCM8720WH330W 5435	"P" Option N/A	"G" Option N/A	"M" Option N/A
	JCM7020WH330W 4289	"P" Option N/A	"G" Option N/A	"M" Option N/A
	JCM6420WH330W 4131	"P" Option N/A	"G" Option N/A	"M" Option N/A
	JCM5820WH330W 3944	"P" Option N/A	"G" Option N/A	"M" Option N/A
	JCM3520WH330W 2412	"P" Option N/A	"G" Option N/A	"M" Option N/A
	JCM2920WH330W 2296	"P" Option N/A	"G" Option N/A	"M" Option N/A

2 Select Finish

[Click to view finishes](#)

- WAC
- WIC
- WHC
- WOC
- WEW
- WGW
- WBW
- WSW
- WNW

3 Select Edge

[Click to view edges](#)

Edge
N/A

4 Select Hardware

[Click to view details](#)

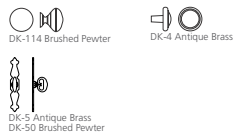

Product Features

- Cornice top
- Interior cabinet depth 12"
- Wall mount rail included
- Wall mount rail included

Notes

- The DARRAN wall mounted cabinet(or shelf) must be hung on a weight-bearing wall. The suitability of the wall supporting the wall mounted cabinet, and the installation and maintenance of the wall-mounted cabinet, is the sole responsibility of the customer. Failure to correctly install and/or exceed the loaded weight capacity of this product may cause it to fall, resulting in damage to the product, adjacent property and/or bodily injury.

Options

Door

- D2: Door Lock - \$100 per door set
- D6: Delete Doors - n/c
- D9SC: Soft Close Door Hinges - \$20 per door

Flush Cut

- FC-B: Flush Unit Both Sides(Facing) for Ganging - \$100
- FC-R: Flush Unit Right (Facing) for Ganging - \$100
- FC-L Flush Unit Left (Facing) for Ganging - \$100

Task Lighting

Overhead task light cord is located on the right facing side. If the opposite location is required please contact customer service.

- LT-LED24: 24" LED Task light - \$215
- LT-LED48: 48" LED Task light - \$270
- LT-LED60: 60" LED Task light - \$335
- LT-LED72: 72" LED Task light - \$360

Jamestown

Single Height Wall Hung Overheads
Wood Frame Beveled Glass

[Click here to view statement of line](#)

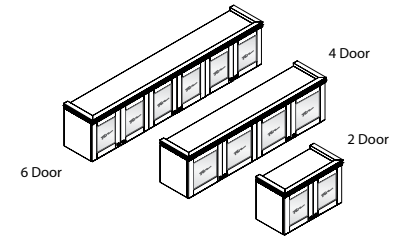

1 Select Model

w" x d" x h"	Weight
6 Door	
93 x 15 x 20	190
87 x 15 x 20	175
4 Door	
70 x 15 x 20	145
64 x 15 x 20	130
58 x 15 x 20	120
2 Door	
35 x 15 x 20	75
29 x 15 x 20	65

	Standard Veneer Top Standard Veneer Chassis	Premium Veneer Top Premium Veneer Chassis	High Pressure Laminate Top Veneer Chassis	Thermally Fused Laminate Top Thermally Fused Laminate Chassis
WAC	JCM9320WH329W 6695	"P" Option N/A	"G" Option N/A	"M" Option N/A
WIC	JCM8720WH329W 6380	"P" Option N/A	"G" Option N/A	"M" Option N/A
WHC	JCM7020WH329W 4967	"P" Option N/A	"G" Option N/A	"M" Option N/A
WOC	JCM6420WH329W 4762	"P" Option N/A	"G" Option N/A	"M" Option N/A
WEW	JCM5820WH329W 4574	"P" Option N/A	"G" Option N/A	"M" Option N/A
WGW	JCM3520WH329W 2727	"P" Option N/A	"G" Option N/A	"M" Option N/A
WBW	JCM2920WH329W 2611	"P" Option N/A	"G" Option N/A	"M" Option N/A
WSW				
WNW				

2 Select Finish

[Click to view finishes](#)

- WAC
- WIC
- WHC
- WOC
- WEW
- WGW
- WBW
- WSW
- WNW

3 Select Edge

[Click to view edges](#)

Edge
N/A

4 Select Hardware

[Click to view details](#)

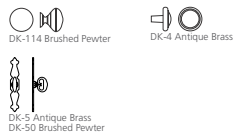

Product Features

- Beveled clear glass
- Cornice top
- Interior cabinet depth 12"
- Mounting wall rail included
- Solid wood door frame

Notes

- The DARRAN wall mounted cabinet(or shelf) must be hung on a weight-bearing wall. The suitability of the wall supporting the wall mounted cabinet, and the installation and maintenance of the wall-mounted cabinet, is the sole responsibility of the customer. Failure to correctly install and/or exceed the loaded weight capacity of this product may cause it to fall, resulting in damage to the product, adjacent property and/or bodily injury.

Options

Door

- D2: Door Lock - \$100 per door set
- D6: Delete Doors - n/c
- D9SC: Soft Close Door Hinges - \$20 per door
- D35: Replace glass panel insert with veneer panel insert - \$35 per door

Flush Cut

- FC-B: Flush Unit Both Sides(Facing) for Ganging - \$100
- FC-R: Flush Unit Right (Facing) for Ganging - \$100
- FC-L Flush Unit Left (Facing) for Ganging - \$100

Interior Cabinet Lighting

- LEDPK starter kit includes Infeed, 1 Puck Interior Light and the ability to daisy chain up to 6 total Puck Lights
- LEDPK: LED Puck Starter Kit - \$310
- PK: 1 LED Interior Light - \$130

Task Lighting

- Overhead task light cord is located on the right facing side. If the opposite location is required please contact customer service.
- LT-LED24: 24" LED Task light - \$215
- LT-LED48: 48" LED Task light - \$270
- LT-LED60: 60" LED Task light - \$335
- LT-LED72: 72" LED Task light - \$360

Wall hung tackboards
Full width tackboards

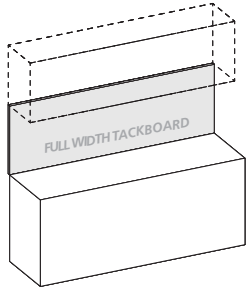

Product Width	Panel Dimension	SKU	COM	1	2	3	4	5	6	7	8	9	10	11/L1	12	13/L2
93	93 x .75 x 24	FTWH9324	465	576	627	678	729	780	831	882	933	984	1035	1086	1137	1239
87	87 x .75 x 24	FTWH8724	448	539	587	635	683	731	779	827	875	923	971	1019	1067	1163
83	83 x .75 x 24	FTWH8324	422	514	560	606	652	698	744	790	836	882	928	974	1020	1112
76	76 x .75 x 24	FTWH7624	388	471	514	557	600	643	686	729	772	815	858	901	944	1030
70	70 x .75 x 24	FTWH7024	355	434	474	514	554	594	634	674	714	754	794	834	874	954
64	64 x .75 x 24	FTWH6424	322	396	432	468	504	540	576	612	648	684	720	756	792	864
58	58 x .75 x 24	FTWH5824	294	359	391	423	455	487	519	551	583	615	647	679	711	775
47	47 x .75 x 24	FTWH4724	236	291	318	345	372	399	426	453	480	507	534	561	588	642
35	35 x .75 x 24	FTWH3524	176	217	237	257	277	297	317	337	357	377	397	417	437	477
29	29 x .75 x 24	FTWH2924	142	179	196	213	230	247	264	281	298	315	332	349	366	400

Standard Features

- Constructed of .5" thick fiberboard
- Fabric is precisely aligned and fitted to the tackboard
- Adhered to the rigid hardboard with staples

- Hung with Z-Strip mounting system

Wall hung tackboards
Half width tackboards

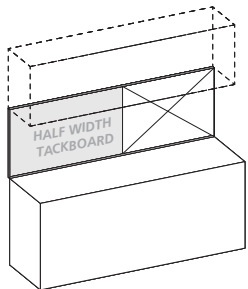

Product Width	Panel Dimension	SKU	COM	1	2	3	4	5	6	7	8	9	10	11/L1	12	13/L2
93 Half Width	46.5 x .75 x 24	FTWH4624	233	288	313	338	363	388	413	438	463	488	513	538	563	613
87 Half Width	43.5 x .75 x 24	FTWH4324	225	270	294	318	342	366	390	414	438	462	486	510	534	582
83 Half Width	41.5 x .75 x 24	FTWH4124	211	257	280	303	326	349	372	395	418	441	464	487	510	556
76 Half Width	38 x .75 x 24	FTWH3824	194	235	256	277	298	319	340	361	382	403	424	445	466	508
70 Half Width	35 x .75 x 24	FTWH3524	178	217	237	257	277	297	317	337	357	377	397	417	437	477
64 Half Width	32 x .75 x 24	FTWH3224	161	198	216	234	252	270	288	306	324	342	360	378	396	432

Standard Features

- Constructed of .5" thick fiberboard
- Fabric is precisely aligned and fitted to the tackboard
- Adhered to the rigid hardboard with staples
- Hung with Z-Strip mounting system

Notes

- Half width tackboards can be specified and combined with a Veneer Panel, Marker Board, Slat Wall or Glass Board. See "Half Width" items under product width.
- Specify right or left facing tackboard

Wall hung dry marker board
Full width dry marker board

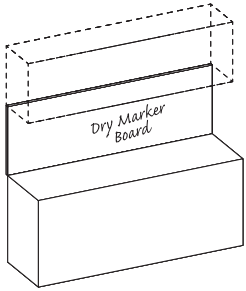

PRODUCT WIDTH	PANEL DIMENSION	SKU	LIST
Product Width	Panel Dimension	SKU	List
93	93 x .75 x 24	DMWH9324	1161
87	87 x .75 x 24	DMWH8724	1086
83	83 x .75 x 24	DMWH8324	1023
76	76 x .75 x 24	DMWH7624	948
70	70 x .75 x 24	DMWH7024	874
64	64 x .75 x 24	DMWH6424	799
58	58 x .75 x 24	DMWH5824	724
47	47 x .75 x 24	DMWH4724	587
35	35 x .75 x 24	DMWH3524	437
29	29 x .75 x 24	DMWH2924	362

Standard Features

- Dry marker panel has edge trim molding

- Standard magnetic surface
- Hung with Z-Strip mounting system

Wall hung dry marker board
Half width dry marker board

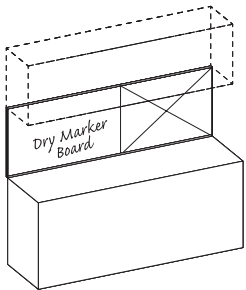

Product Width	Panel Dimension	SKU	List
93 Half Width	46.5 x .75 x 24	DMWH4624	580
87 Half Width	43.5 x .75 x 24	DMWH4324	543
83 Half Width	41.5 x .75 x 24	DMWH4124	518
76 Half Width	38 x .75 x 24	DMWH3824	474
70 Half Width	35 x .75 x 24	DMWH3524	437
64 Half Width	32 x .75 x 24	DMWH3224	399

Standard Features

- Dry marker panel has edge trim molding
- Standard magnetic surface
- Hung with Z-Strip mounting system

Notes

- Half width dry marker boards can be specified and combined with a Tackboard, Veneer Panel, Slat Wall or Glass Board. See "Half Width" items under product width.
- Specify right or left facing dry marker board

Wall hung veneer panel
Full width veneer panel

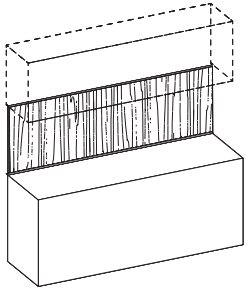

Product Width	Panel Dimension	SKU	List
93	93 x .75 x 24	VPWH9324	967
87	87 x .75 x 24	VPWH8724	905
83	83 x .75 x 24	VPWH8324	853
76	76 x .75 x 24	VPWH7624	790
70	70 x .75 x 24	VPWH7024	728
64	64 x .75 x 24	VPWH6424	666
58	58 x .75 x 24	VPWH5824	603
47	47 x .75 x 24	VPWH4724	489
35	35 x .75 x 24	VPWH3524	364
29	29 x .75 x 24	VPWH2924	302

Standard Features

- Hung with Z-Strip mounting system

Notes

- Veneer edges.
- Vertical wire channels on back for task light cords
- Steel mounting wall channel is recessed for flush mounting
- Can be used with or without overhead cabinet
- Required for other accessory panels

Wall hung veneer panel
Half width veneer panel

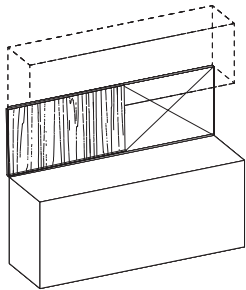

Product Width	Panel Dimension	SKU	List
93 Half Width	46.5 x .75 x 24	VPWH4624	484
87 Half Width	43.5 x .75 x 24	VPWH4324	452
83 Half Width	41.5 x .75 x 24	VPWH4124	432
76 Half Width	38 x .75 x 24	VPWH3824	395
70 Half Width	35 x .75 x 24	VPWH3524	364
64 Half Width	32 x .75 x 24	VPWH3224	333

Standard Features

- Veneer edges
- Vertical wire channels on back for task light cords
- Steel mounting wall channel is recessed for flush mounting
- Hung with Z-Strip mounting system

Notes

- Half width veneer panels can be specified and combined with a Tackboard, Marker Board, Slat Wall or Glass Board. See "Half Width" items under product width.
- Specify right or left facing veneer panel
- Can be used with or without overhead cabinet
- Required for other accessory panels

Wall hung glassboard
Full width glassboards

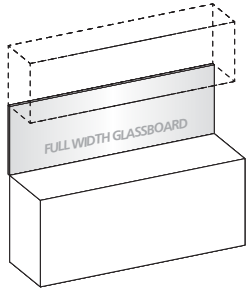

Product Width	Panel Dimension	SKU	List
93	93 x .75 x 24	GBWH9324	2753
87	87 x .75 x 24	GBWH8724	2586
83	83 x .75 x 24	GBWH8324	2475
76	76 x .75 x 24	GBWH7624	2281
70	70 x .75 x 24	GBWH7024	2114
64	64 x .75 x 24	GBWH6424	1948
58	58 x .75 x 24	GBWH5824	1780
47	47 x .75 x 24	GBWH4724	1476
35	35 x .75 x 24	GBWH3524	1142
29	29 x .75 x 24	GBWH3924	976

Standard Features

- 4 mm tempered glass

Notes-

- Standard dry erase markers may be used
- Earth magnets are required to hold items securely in place
- Hung with Z-Strip mounting system
- Use glass cleaner or alcohol to clean

Wall hung glassboard
Half width glassboards

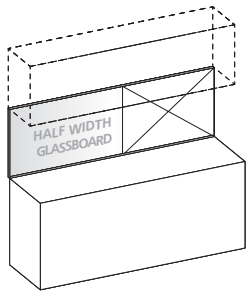

Product Width	Panel Dimension	SKU	List
93 Half Width	46.5 x .75 x 24	GBWH4624	1461
87 Half Width	43.5 x .75 x 24	GBWH4324	1378
83 Half Width	41.5 x .75 x 24	GBWH4124	1323
76 Half Width	38 x .75 x 24	GBWH3824	1232
70 Half Width	35 x .75 x 24	GBWH3524	1142
64 Half Width	32 x .75 x 24	GBWH3224	1059

Standard Features

- 4 mm tempered glass

Notes

- Half width glassboards can be specified and combined with a Tackboard, Veneer panel, Marker Board or Slat Wall. See "Half Width" items under product width.
- Specify right or left facing glassboard-Use glass cleaner or alcohol to clean
- Standard dry erase markers may be used
- Earth magnets are required to hold items securely in place
- Hung with Z-Strip mounting system

Wall hung slat wall
Half width slat wall

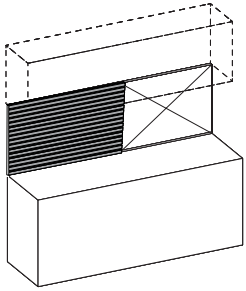

Product Width	Panel Dimension	SKU	List
93 Half Width	46.5 x .75 x 24	SWWH4624	484
87 Half Width	43.5 x .75 x 24	SWWH4324	452
83 Half Width	41.5 x .75 x 24	SWWH4124	432
76 Half Width	38 x .75 x 24	SWWH3824	395
70 Half Width	35 x .75 x 24	SWWH3524	364
64 Half Width	32 x .75 x 24	SWWH3224	333

Standard Features

- Available in silver or black
- Hung with Z-Strip mounting system

Notes

- Half width slat walls can be specified and combined with a Tackboard, Veneer panel
- Marker Board or Glassboard. See "Half Width" items under product width.
- Specify right or left facing slat wall
- For use on 42"/43" height consoles

Jamestown

Single Height Overhead
35"/29" Bookcase / Hutch Overhead With Cornice Top

[Click here to view statement of line](#)

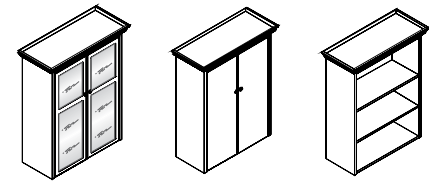

Frame Door W/ Beveled Glass Panel Door Open Bookcase

1 Select Model

w" x d" x h"	Weight	Standard Veneer Top Standard Veneer Chassis	Premium Veneer Top Premium Veneer Chassis	High Pressure Laminate Top Veneer Chassis	Thermally Fused Laminate Top Thermally Fused Laminate Chassis
35 x 15 x 44	120	JCM3544OH552W 3370	"P" Option N/A	"G" Option N/A	"M" Option N/A
29 x 15 x 44	115	JCM2944OH552W 3196	"P" Option N/A	"G" Option N/A	"M" Option N/A
35 x 15 x 51	150	JCM3551OH552W 3516	"P" Option N/A	"G" Option N/A	"M" Option N/A
29 x 15 x 51	145	JCM2951OH552W 3341	"P" Option N/A	"G" Option N/A	"M" Option N/A
Panel Door					
35 x 15 x 44	130	JCM3544OH570W 3196	"P" Option N/A	"G" Option N/A	"M" Option N/A
29 x 15 x 44	125	JCM2944OH570W 3026	"P" Option N/A	"G" Option N/A	"M" Option N/A
35 x 15 x 51	160	JCM3551OH570W 3337	"P" Option N/A	"G" Option N/A	"M" Option N/A
29 x 15 x 51	155	JCM2951OH570W 3171	"P" Option N/A	"G" Option N/A	"M" Option N/A
Open Bookcase					
35 x 15 x 44	100	JCM3544OH551W 2352	"P" Option N/A	"G" Option N/A	"M" Option N/A
29 x 15 x 44	90	JCM2944OH551W 2180	"P" Option N/A	"G" Option N/A	"M" Option N/A
35 x 15 x 51	130	JCM3551OH551W 2462	"P" Option N/A	"G" Option N/A	"M" Option N/A
29 x 15 x 51	120	JCM2951OH551W 2332	"P" Option N/A	"G" Option N/A	"M" Option N/A

2 Select Finish

- [Click to view finishes](#)
- WAC
 - WIC
 - WHC
 - WOC
 - WEW
 - WGW
 - WBW
 - WSW
 - WNW

3 Select Edge

- [Click to view edges](#)
- Edge
 - N/A

4 Select Hardware

- [Click to view details](#)
- DK-114 Brushed Pewter
 - DK-4 Antique Brass
 - DK-5 Antique Brass
 - DK-50 Brushed Pewter

Product Features

- 2 Adjustable finished shelves
- Cornice top
- Interior shelf depth 12"

Notes

- Unit has black back panel and is not designed for Open Plan use. Select OPB Option for Open Plan application

Options

- Door**
- D2: Door Lock - \$100 per door set
 - D9SC: Soft Close Door Hinges - \$20 per door
 - D35: Optional Wood Panel Insert - \$35 per individual panel insert (OH552 product only)

Flush Cut

- FC-B: Flush Unit Both Sides(Facing) for Ganging - \$100
- FC-R: Flush Unit Right (Facing) for Ganging - \$100
- FC-L: Flush Unit Left (Facing) for Ganging - \$100

Interior Cabinet Lighting

- LEDPK starter kit includes Infeed, 1 Puck Interior Light and the ability to daisy chain up to 6 total Puck Lights
- LEDPK: LED Puck Starter Kit - \$310
 - PK: 1 LED Interior Light - \$130

Open Plan _ Finished Back

- OPB: "W" "G" Style - Modify Unit for Open Plan Application - \$395

Shelves

- GS14F: Replace Standard Shelves with Glass Shelf - \$90 per shelf
- S714F: Replace standard shelves with heavy duty 1" thick wood shelf - \$80 per shelf

Jamestown

Single Height Overhead
70" Bookcase/Hutch Overhead With Cornice Top

[Click here to view statement of line](#)

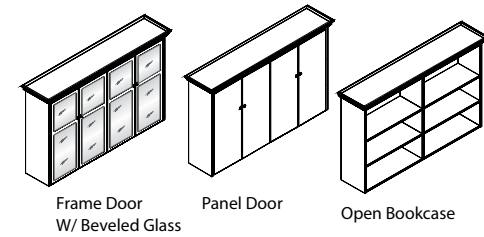

1 Select Model

w" x d" x h"	Weight
Frame Door w/ Beveled Glass	
70 x 15 x 44	250
70 x 15 x 51	300
Panel Door	
70 x 15 x 44	260
70 x 15 x 51	310
Open Bookcase	
70 x 15 x 44	200
70 x 15 x 51	250

	Standard Veneer Top Standard Veneer Chassis	Premium Veneer Top Premium Veneer Chassis	High Pressure Laminate Top Veneer Chassis	Thermally Fused Laminate Top Thermally Fused Laminate Chassis
	JCM7044OH552W 6062	"P" Option N/A	"G" Option N/A	"M" Option N/A
	JCM7051OH552W 7031	"P" Option N/A	"G" Option N/A	"M" Option N/A
	JCM7044OH570W 5554	"P" Option N/A	"G" Option N/A	"M" Option N/A
	JCM7051OH570W 6439	"P" Option N/A	"G" Option N/A	"M" Option N/A
	JCM7044OH551W 4029	"P" Option N/A	"G" Option N/A	"M" Option N/A
	JCM7051OH551W 4671	"P" Option N/A	"G" Option N/A	"M" Option N/A

2 Select Finish

[Click to view finishes](#)

- WAC
- WIC
- WHC
- WOC
- WEW
- WGW
- WBW
- WSW
- WNW

3 Select Edge

[Click to view edges](#)

Edge
N/A

4 Select Hardware

[Click to view details](#)

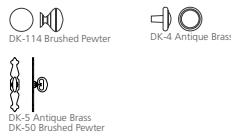

Product Features

- 4 Adjustable finished shelves
- Shipped assembled
- Cornice top
- Interior shelf depth 12"

Notes

- Unit has black back panel and is not designed for Open Plan use. Select OPB Option for Open Plan application

Options

Door

- D2: Door Lock - \$100 per door set
- D9SC: Soft Close Door Hinges - \$20 per door
- D35: Optional Wood Panel Insert - \$35 per individual panel insert (OH552 product only)

Flush Cut

- FC-B: Flush Unit Both Sides(Facing) for Ganging - \$100
- FC-R: Flush Unit Right (Facing) for Ganging - \$100
- FC-L: Flush Unit Left (Facing) for Ganging - \$100

Interior Cabinet Lighting

- LEDPK starter kit includes Infeed, 1 Puck Interior Light and the ability to daisy chain up to 6 total Puck Lights
- LEDPK: LED Puck Starter Kit - \$310
- PK: 1 LED Interior Light - \$130

Open Plan _ Finished Back

- OPB: "W" "G" Style - Modify Unit for Open Plan Application - \$395

Shelves

- GS14F: Replace Standard Shelves with Glass Shelf - \$90 per shelf
- S714F: Replace standard shelves with heavy duty 1" thick wood shelf - \$80 per shelf

Jamestown

Tower Cabinets

Wardrobe / Storage Tower

[Click here to view statement of line](#)

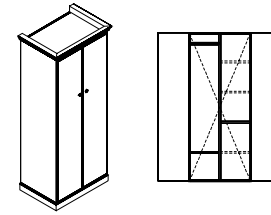

1 Select Model

w" x d" x h"	Weight
29 x 24 x 77	310
29 x 24 x 84	350
35 x 24 x 77	325
35 x 24 x 84	365

Standard Veneer Top Standard Veneer Chassis		Premium Veneer Top Premium Veneer Chassis	High Pressure Laminate Top Veneer Chassis	Thermally Fused Laminate Top Thermally Fused Laminate Chassis
--	--	--	--	--

JCM2977TW275W	6639	"P" Option N/A	"G" Option N/A	"M" Option N/A
JCM2984TW275W	7446	"P" Option N/A	"G" Option N/A	"M" Option N/A
JCM3577TW275W	7057	"P" Option N/A	"G" Option N/A	"M" Option N/A
JCM3584TW275W	7698	"P" Option N/A	"G" Option N/A	"M" Option N/A

Product Features

- 2 fixed shelves
- 3 Adjustable shelves
- Cornice top
- Standard non-locking
- Wardrobe w/ coat rod & hook
- Panel doors w/ knobs

Notes

- Unit has black back panel and is not designed for Open Plan use. Select OPB Option for Open Plan application

Options

Door

- D2: Lock door - \$100 per door
- D9SC: Soft Close Door Hinges - \$20 per door

Flush Cut

- FC-B: Flush Unit Both Sides(Facing) for Ganging - \$100
- FC-R: Flush Unit Right (Facing) for Ganging - \$100
- FC-L: Flush Unit Left(Facing) for Ganging - \$100

Open Plan _ Finished Back

- OPB: Finished Back - \$395

Shelves

- MOD-31: Delete center partition & half shelves and add 2 full shelves - \$295

2 Select Finish

[Click to view finishes](#)

- WAC
- WIC
- WHC
- WOC
- WEW
- WGW
- WBW
- WSW
- WNW

3 Select Edge

[Click to view edges](#)

- Edge
- N/A

4 Select Hardware

[Click to view details](#)

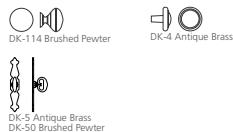

Jamestown

Single Door Tower Cabinets
Wardrobe / Storage Tower

[Click here to view statement of line](#)

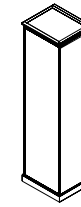

Hinged Left

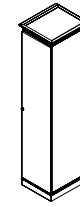

Hinged Right

1 Select Model

Weight
w" x d" x h"
Hinged Right
17 x 24 x 77

Hinged Left
160

Standard Veneer Top Standard Veneer Chassis	Premium Veneer Top Premium Veneer Chassis	High Pressure Laminate Top Veneer Chassis	Thermally Fused Laminate Top Thermally Fused Laminate Chassis
--	--	--	--

JCM1777TW284W 4767	"P" Option N/A	"G" Option N/A	"M" Option N/A
JCM1777TW283W 4767	"P" Option N/A	"G" Option N/A	"M" Option N/A

2 Select Finish

[Click to view finishes](#)

- WAC
- WIC
- WHC
- WOC
- WEW
- WGW
- WBW
- WSW
- WNW

3 Select Edge

[Click to view edges](#)

Edge
N/A

4 Select Hardware

[Click to view details](#)

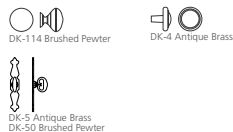

Product Features

- 1 fixed shelf
- Standard locking
- Wardrobe w/ coat rod & hook

Notes

- Unit has black back panel and is not designed for Open Plan use. Select OPB Option for Open Plan application

Options

Door

- D2: Lock door - \$100 per door
- D9SC: Soft Close Door Hinges - \$20 per door
- D6: Delete Doors - n/c

Flush Cut

- FC-B: Flush Unit Both Sides(Facing) for Ganging - \$100
- FC-R: Flush Unit Right (Facing) for Ganging - \$100
- FC-L: Flush Unit Left(Facing) for Ganging - \$100

Open Plan _ Finished Back

- OPB: Finished Back - \$395

Jamestown

Tower Cabinets
Lateral File / Storage Tower

[Click here to view statement of line](#)

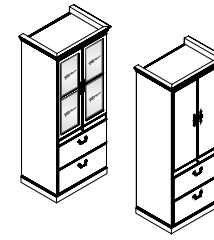

1 Select Model

w" x d" x h"	Weight
Panel Wood Door	
29 x 24 x 77	325
29 x 24 x 84	365
35 x 24 x 77	340
35 x 24 x 84	380
Beveled Glass Door	
29 x 24 x 77	325
29 x 24 x 84	365

	Standard Veneer Top Standard Veneer Chassis	Premium Veneer Top Premium Veneer Chassis	High Pressure Laminate Top Veneer Chassis	Thermally Fused Laminate Top Thermally Fused Laminate Chassis
JCM2977TW281W 7036		"P" Option N/A	"G" Option N/A	"M" Option N/A
JCM2984TW281W 7844		"P" Option N/A	"G" Option N/A	"M" Option N/A
JCM3577TW281W 7453		"P" Option N/A	"G" Option N/A	"M" Option N/A
JCM3584TW281W 8096		"P" Option N/A	"G" Option N/A	"M" Option N/A
JCM2977TW312W 7817		"P" Option N/A	"G" Option N/A	"M" Option N/A
JCM2984TW312W 8811		"P" Option N/A	"G" Option N/A	"M" Option N/A

Product Features

- 2 Lateral files
- Central Lock
- Cornice top
- Doors/Drawers feature shaped edges
- Features ball bearing suspensions, suspensions are full extension.

Notes

- Unit has black back panel and is not designed for Open Plan use. Select OPB Option for Open Plan application

Options

- Door**
- D2: Lock door - \$100 per door
 - D35: Optional Wood Panel Insert - \$35 per insert (TW312 Only)

- Drawer**
- PL-DBL: Add second pull to lateral file drawer - \$20 per Pull

- Flush Cut**
- FC-B: Flush Unit Both Sides(Facing) for Ganging - \$100
 - FC-R: Flush Unit Right (Facing) for Ganging - \$100
 - FC-L Flush Unit Left(Facing) for Ganging - \$100

- Interior Cabinet Lighting**
- LEDPK starter kit includes Infeed, 1 Puck Interior Light and the ability to daisy chain up to 6 total Puck Lights
- LEDPK: LED Puck Starter Kit - \$310
 - PK: 1 LED Interior Light - \$130

- Open Plan _ Finished Back**
- OPB: Finished Back - \$395

- Storage**
- S20: Add vertical center partitions to storage area for half wardrobe/half storage - \$205

- Shelves**
- GS14F: Replace Standard Shelves with Glass Shelf - \$90 per shelf

2 Select Finish

- [Click to view finishes](#)
- WAC
 - WIC
 - WHC
 - WOC
 - WEW
 - WGW
 - WBW
 - WSW
 - WNW

3 Select Edge

- [Click to view edges](#)
- Edge
 - N/A

4 Select Hardware

- [Click to view details](#)
- DK-114 Brushed Pewter
 - DK-4 Antique Brass
 - DK-5 Antique Brass
 - DK-50 Brushed Pewter

Jamestown

Bookcases
Open Bookcases

[Click here to view statement of line](#)

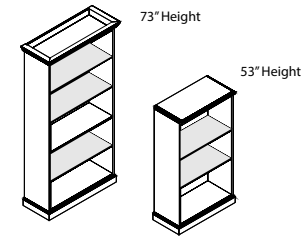

1 Select Model

w" x d" x h"	Weight
35 x 14 x 73	160
35 x 14 x 53	115
29 x 14 x 73	150
29 x 14 x 53	105

Standard Veneer Top Standard Veneer Chassis		Premium Veneer Top Premium Veneer Chassis	High Pressure Laminate Top Veneer Chassis	Thermally Fused Laminate Top Thermally Fused Laminate Chassis
JCM3573BK250W	3449	"P" Option N/A	"G" Option N/A	"M" Option N/A
JCM3553BK250W	2101	"P" Option N/A	"G" Option N/A	"M" Option N/A
JCM2973BK250W	3276	"P" Option N/A	"G" Option N/A	"M" Option N/A
JCM2953BK250W	1929	"P" Option N/A	"G" Option N/A	"M" Option N/A

Product Features

- 53" w/ 2 adjustable shelves
- 73" w/ 1 fixed and 3 adjustable shelves
- Interior shelf depth 12"
- "W" styles - 53" H units finished top, 73" H units black painted top

Notes

- Unit has black back panel and is not designed for Open Plan use. Select OPB Option for Open Plan application

Options

Flush Cut

- FC-B: Flush Unit Both Sides(Facing) for Ganging - \$100
- FC-R: Flush Unit Right (Facing) for Ganging - \$100
- FC-L: Flush Unit Left (Facing) for Ganging - \$100

Interior Cabinet Lighting

- LEDPK starter kit includes Infeed, 1 Puck Interior Light and the ability to daisy chain up to 6 total Puck Lights
- LEDPK: LED Puck Starter Kit - \$310
- PK: 1 LED Interior Light - \$130

Open Plan _ Finished Back

- OPB: "W" "G" Style - Modify Unit for Open Plan Application - \$395

Shelves

- ADS14F: Add standard wood shelf - \$110
- GS14F: Replace Standard Shelves with Glass Shelves - \$90 per shelf
- S714F: Replace standard shelves with heavy duty 1" thick wood shelf - \$80 per shelf

2 Select Finish

[Click to view finishes](#)

- WAC
- WIC
- WHC
- WOC
- WEW
- WGW
- WBW
- WSW
- WNW

3 Select Edge

[Click to view edges](#)



4 Select Hardware

[Click to view details](#)

Hardware
N/A

Jamestown

Bookcases
Panel Door Bookcases

[Click here to view statement of line](#)

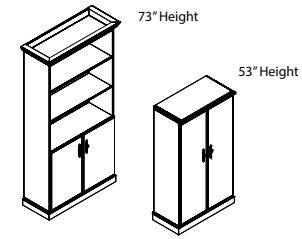

1 Select Model

w" x d" x h"

Weight	Model	Weight
205	JCM3581BK251W	4115
175	JCM3573BK251W	3784
135	JCM3553BK251W	2438
195	JCM2981BK251W	3943
165	JCM2973BK251W	3613
125	JCM2953BK251W	2266

Standard Veneer Top Standard Veneer Chassis	Premium Veneer Top Premium Veneer Chassis	High Pressure Laminate Top Veneer Chassis	Thermally Fused Laminate Top Thermally Fused Laminate Chassis
	"P" Option N/A	"P" Option N/A	"M" Option N/A
	"P" Option N/A	"G" Option N/A	"M" Option N/A
	"P" Option N/A	"G" Option N/A	"M" Option N/A
	"P" Option N/A	"G" Option N/A	"M" Option N/A
	"P" Option N/A	"G" Option N/A	"M" Option N/A
	"P" Option N/A	"G" Option N/A	"M" Option N/A

Product Features

- 53" w/ 2 adjustable shelves
- 73" w/ 1 fixed and 3 adjustable shelves
- 81" w/ 1 fixed and 3 adjustable shelves
- Doors with profile edge shape
- Interior shelf depth 12"
- "W" styles - 53" H units finished top, 73" H units black painted top

Notes

- Unit has black back panel and is not designed for Open Plan use. Select OPB Option for Open Plan application

Options

Door

- D2: Lock door - \$100 per door
- D9SC: Soft Close Door Hinges - \$20 per door
- DGL-01: Wood frame door with glass panel insert for a 53" high bookcase - \$160 per door

Flush Cut

- FC-B: Flush Unit Both Sides(Facing) for Ganging - \$100
- FC-R: Flush Unit Right (Facing) for Ganging - \$100
- FC-L: Flush Unit Left (Facing) for Ganging - \$100

Interior Cabinet Lighting

- LEDPK starter kit includes Infeed, 1 Puck Interior Light and the ability to daisy chain up to 6 total Puck Lights
- LEDPK: LED Puck Starter Kit - \$310
- PK: 1 LED Interior Light - \$130

Open Plan _ Finished Back

- OPB: "W" "G" Style - Modify Unit for Open Plan Application - \$395

Shelves

- ADS14F: Add standard wood shelf - \$110
- GS14F: Replace Standard Shelves with Glass Shelf - \$90 per shelf
- S714F: Replace standard shelves with heavy duty 1" thick wood shelf - \$80 per shelf

2 Select Finish

[Click to view finishes](#)

- WAC
- WIC
- WHC
- WOC
- WEW
- WGW
- WBW
- WSW
- WNW

3 Select Edge

[Click to view edges](#)



4 Select Hardware

[Click to view details](#)

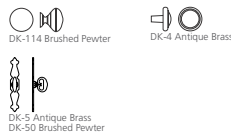

Jamestown

Reception Desk
Reception Desk With Counter

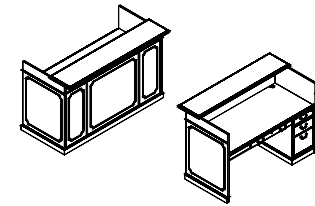

Right Pedestal Shown

[Click here to view statement of line](#)

1 Select Model

w" x d" x h"
Left Pedestal Desk
72 x 30 x 44
Left Pedestal Desk
66 x 30 x 44
Right Pedestal Desk
72 x 30 x 44
Right Pedestal Desk
66 x 30 x 44

Weight	Standard Veneer Top Standard Veneer Chassis	Premium Veneer Top Premium Veneer Chassis	High Pressure Laminate Top Veneer Chassis	Thermally Fused Laminate Top Thermally Fused Laminate Chassis
350	JCM7244RP925W 7601	"P" Option N/A	JCM7244RP925G 7601	"M" Option N/A
340	JCM6644RP925W 7427	"P" Option N/A	JCM6644RP925G 7427	"M" Option N/A
350	JCM7244RP924W 7601	"P" Option N/A	JCM7244RP924G 7601	"M" Option N/A
340	JCM6644RP924W 7427	"P" Option N/A	JCM6644RP924G 7427	"M" Option N/A

Product Features

- 2 standard grommet - matches pull finish or specify black TM30, silver TM31 or antique brass TM33
- Finished back - open plan
- Full extension drawers - locking
- Suspensions are full extension and soft close

Options

Accessories

- K28: Articulating keyboard w/ mouse pad - \$390

Grommets (Non-Standard Location)

Provide drawing w/ Grommet Location and Specify Color - \$95 ea.

- Black: TM30-NS
- Silver: TM31-NS
- Antique Brass: TM33-NS

Molding

- DSM1: Delete Scalloped Only - Deduct \$95

Task Lighting

- LT-LED24: 24" LED Task light - \$215

2 Select Finish

[Click to view finishes](#)

WAC
WIC
WHC
WOC
WEW
WGW
WBW
WSW
WNW

GAC
GIC
GHC
GOC
GEW
GNW

3 Select Edge

[Click to view edges](#)



4 Select Hardware

[Click to view details](#)



Jamestown

Reception Bridge
Open Back Bridge

[Click here to view statement of line](#)

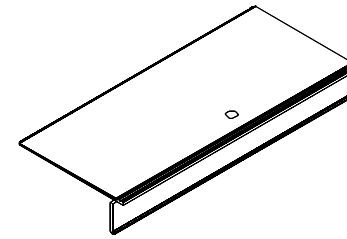

1 Select Model

w" x d" x h"
48 x 22 x 42

Weight
120

Standard Veneer Top Standard Veneer Chassis		Premium Veneer Top Premium Veneer Chassis		High Pressure Laminate Top Veneer Chassis		Thermally Fused Laminate Top Thermally Fused Laminate Chassis	
--	--	--	--	--	--	--	--

JCM4842RP164W	2522	"P" Option N/A		JCM4842RP164G	2522	"M" Option N/A	
---------------	------	----------------	--	---------------	------	----------------	--

Product Features

- 4"H back rail - open back
- Center grommet standard
- Coped ends for flush surface transition
- Metal grommet matches pull finish, unless specified otherwise

Options

Accessories

- K28: Articulating keyboard w/ mouse pad - \$390

Drawer

- K17: Traditional center drawer - \$235

Grommets (Non-Standard Location)

Provide drawing w/ Grommet Location and Specify Color - \$95 ea.

- TM30-NS: Black Specify Location
- TM31-NS: Silver Specify Location
- TM33-NS: Antique Brass Specify Location

Modesty

- M37: "W" "G" Style Fixed Full Modesty w/ Molding - \$130
- M34T-O: "W" "G" Style Drop Door Tech Modesty - \$310

2 Select Finish

[Click to view finishes](#)

WAC
WIC
WHC
WOC
WEW
WGW
WBW
WSW
WNW

GAC
GIC
GHC
GOC
GEW
GNW

3 Select Edge

[Click to view edges](#)



4 Select Hardware

[Click to view details](#)

Hardware
N/A

Hardware
N/A

Jamestown

Reception Return
Return

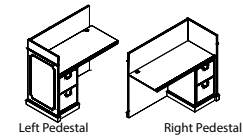

[Click here to view statement of line](#)

1 Select Model

w" x d" x h"
Left Pedestal
48 x 22 x 42
Right Pedestal
48 x 22 x 42

Weight	Standard Veneer Top Standard Veneer Chassis	Premium Veneer Top Premium Veneer Chassis	High Pressure Laminate Top Veneer Chassis	Thermally Fused Laminate Top Thermally Fused Laminate Chassis
195	JCM4842RP931W 4754	"P" Option N/A	JCM4842RP931G 4754	"M" Option N/A
195	JCM4842RP930W 4754	"P" Option N/A	JCM4842RP930G 4754	"M" Option N/A

Product Features

- 1 Standard grommet - matches pull finish or specify black TM30, silver TM31 or antique brass TM33
- Coped ends for flush surface transition
- Fixed full modesty
- Full extension drawers - locking
- Soft close suspension drawer(s)

Options

Accessories

- K28: Articulating keyboard w/ mouse pad - \$390

Flush Cut

- FC-R: Flush Unit Right (Facing) for Ganging - \$100
- FC-L: Flush Unit Left (Facing) for Ganging - \$100

Grommets (non-Standard Location)

Provide drawing w/ Grommet Location and Specify Color - \$95 ea.

- Black: TM30-NS
- Silver: TM31-NS
- Antique Brass: TM33-NS

Molding

- DSM2: Delete Scalloped Only - Deduct \$50

Modesty

- M34T: Drop Door Tech Modesty - \$130
- M51: Open Back Modesty with Wire Mgmt Rail - Deduct \$95

Drawer

- K17: Traditional center drawer - \$235

2 Select Finish

[Click to view finishes](#)

WAC
WIC
WHC
WOC
WEW
WGW
WBW
WSW
WNW

GAC
GIC
GHC
GOC
GEW
GNW

3 Select Edge

[Click to view edges](#)



4 Select Hardware

[Click to view details](#)





COMPUTER SUPPORT
single monitor arm

COMPUTER SUPPORT
double monitor arm

COMPUTER SUPPORT
triple monitor arm

COMPUTER SUPPORT
quadruple monitor arm

Style Number	List Price
MA1	280

Style Number	List Price
MA2	450

Style Number	List Price
MA3	530

Style Number	List Price
MA4	705

Specifications

- Available in black or silver
- Desk clamp and mounting included
- Easy assembly and flexibility
- Elastic painting process for a durable and beautiful finish
- Gas spring tension adjustment for counter-balance height adjustment for monitors 1-8 KG
- Gas spring tested to 50,000 repetitions
- Hidden cable management

Specifications

- Available in black or silver
- Desk clamp and mounting included
- Easy assembly and flexibility
- Elastic painting process for a durable and beautiful finish
- Gas spring tension adjustment for counter-balance height adjustment for monitors 1-8 KG
- Gas spring tested to 50,000 repetitions
- Hidden cable management

Specifications

- Available in black or silver
- Desk clamp and mounting included
- Easy assembly and flexibility
- Elastic painting process for a durable and beautiful finish
- Gas spring tension adjustment for counter-balance height adjustment for monitors 1-8 KG
- Gas spring tested to 50,000 repetitions
- Hidden cable management

Specifications

- Available in black
- Desk clamp and mounting included
- Easy assembly and flexibility
- Elastic painting process for a durable and beautiful finish
- Gas spring tension adjustment for counter-balance height adjustment for monitors 1-8 KG
- Gas spring tested to 50,000 repetitions
- Hidden cable management

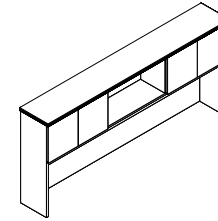
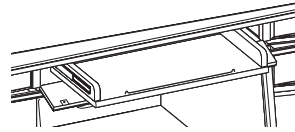
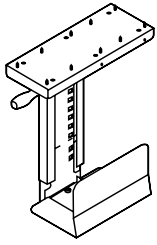

COMPUTER SUPPORT
cpu retractable cradle

COMPUTER SUPPORT
traditional pull-out drawer with
keyboard tray

DOOR MODIFICATIONS
soft close door hinge

DOOR MODIFICATIONS
delete doors

Style Number	List Price
K18	205

Style Number	List Price
K21	470

Style Number	List Price
D9SC	20 Per door

Style Number	List Price
D6	N/C

Specifications

- Black Metal CPU Carriage
- Full 360° swivel capability allows easy access to rear of CPU for cables / wires
- Track allows 8- 1/2" extension
- Width Adjustment 5-1/2" to 9-1/4"
- Height adjustment 14- 5/8" to 20- 1/2"
- Black epoxy finish

Notes
- Factory Installed

Specifications

- Available on:
Desk 72"-66"
Kneespace Credenza 72"-66"
Workstation Credenza 72" single pedestal only
- Traditional Pull-out Drawer w/Keyboard Tray

Specifications

- Snap onto standard door hinge
- Requires (2) per door
- Max door height 43"
- Factory installed where specified
- Individually shipped for field installation

Notes
- Specify Each Item To Have Slow Close Feature

Specifications

- Standard Door overheads and cabinets can have door deleted for open access. Modification of hinge rails and structural components are made face ready.

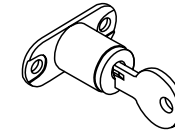
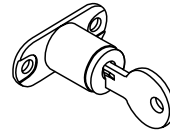
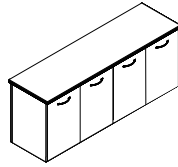
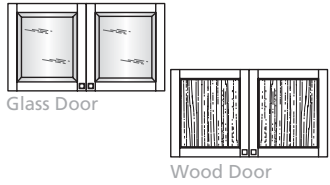

DOOR MODIFICATIONS
replace glass panel insert with veneer panel insert

Style Number	List Price
D35	35 Per door

DOOR MODIFICATIONS
delete doors

Style Number	List Price
D6A	N/C

DOOR MODIFICATIONS
panel door lock

Style Number	List Price
D2	100 Per door set

DOOR MODIFICATIONS
glass door lock

Style Number	List Price
D2-G	205 Per door set

Specifications

- Replace glass panel insert with veneer panel insert

Notes
 - Not Available on "M" skus
 - Glass door has beveled glass
 - Wood door w/ veneer insert - only available on "W" style

Specifications

- Delete doors
- Notes
 - Available on: All Storage "W"/"G" Style Credenzas.

Specifications

- Door Locks - 1 Door w/ Lock, Other Door w/ Catch Latch
- Contact Customer Service regarding limited lock locations and keying.

Notes
 - Available on: Panel Doors, Wood Frame Doors, and Silverluma doors

Specifications

- Door Locks - 1 Door w/ Lock, Other Door w/ Catch Latch
- Contact Customer Service regarding limited lock locations and keying.

Notes
 - Available on: Glass Doors

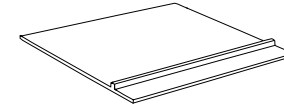
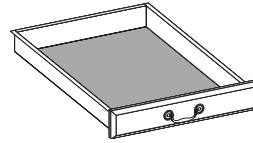
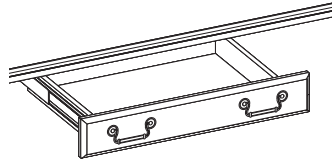
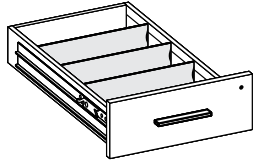

DRAWER OPTIONS
box drawer accessories

Style Number	List Price
Wood Drawer Dividers w/ Clips K-DIV	SET OF 3
Single Tray - Utility Tray	- 30
K-Sut	35 ea.

DRAWER OPTIONS
traditional center drawer

Style Number	List Price
K17	235
Add Skirt Option K17-SK	340

DRAWER OPTIONS - BOTTOM COVER
black dura-leather drawer bottom covers

Style Number	List Price
P2	80

DRAWER OPTIONS - BOTTOM COVER
felt bottom center drawer insert liner

Style Number	List Price
K3	100

Specifications

- K-DIV Extra Wood Drawer Dividers with Clips, Top Box drawers standard with 1 divider
- K-SUT Single Tray - Utility Tray, Specify Legal or Letter drawer width

Specifications

- Standard on desks in Jamestown Collection. Optional center drawers available for bullet conference desk, kneespace credenzas and corner units. 3 ply hardwood drawer / dowel construction profile shaped drawer front. Specify pull choice.

Specifications

- Center drawer and Box/Tray drawers are covered in Black Dura-leather that adds a prestigious touch.

Specifications

- Inserts into center drawer and features divider for open pen and pencil storage. Removable for easy cleaning.
- Adds a luxurious touch to center drawers.
- Color: Dark Brown Coal

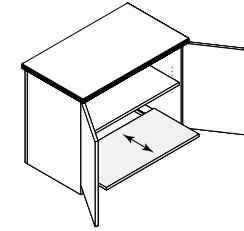
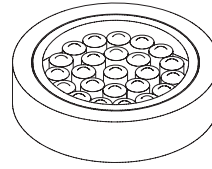

GLASSBOARD ACCESSORIES
glassboard accessory kit

Style Number	List Price
GBKIT	290

TASK LIGHTING
lt-led task light

Style Number	List Price
LT-LED24	215
LT-LED48	270
LT-LED60	335
LT-LED72	360

LIGHTING
led interior cabinet puck light

Style Number	List Price
Starter Kit	
LEDPK	310
1 LED Interior Puck Light	
PK	130

PEDESTAL MODIFICATIONS
black laminate printer pullout
bottom shelf

Style Number	List Price
PPOS	225

Specifications

- 8 Earth magnets, 1 magnetic marker cup holder and 1 magnetic dry eraser

Specifications

- 6.5' Power cord. Switch with touch dimmer
- 36 LEDs per foot
- 4.6 Watts per foot
- 91 Lumens per watt
- Please note when ganging.
- Overhead tasklight cord is located on the right facing side. If the opposite location is required please contact customer service.

Specifications

- Starter kit includes Infeed, 1 Puck Interior Light and the ability to daisy chain up to 6 total Puck Lights
- (1) LED Puck Light with 30W power drive and switch
- Recessed fixture
- 12V linking cord 98"L
- Silver finish
- 50,000 hour life
- 2 watt per light

Notes

- Available on: Overhead/Tower Units with glass doors or no doors
- Power drive included, Light only

Specifications

- Black Laminate pullout shelf on suspension
- Black grommet
- Adjustable Shelf

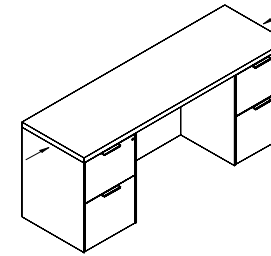
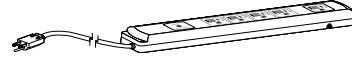
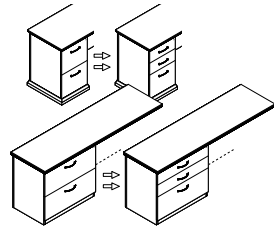
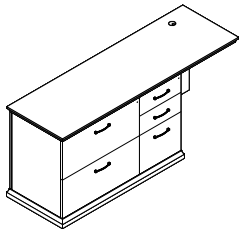

PEDESTAL MODIFICATIONS

add veneer kneespace cabinets - base

Style Number	List Price
Add Box/Box/File or File/File P40B	1025
Add Lateral File 29" W P41B	1255
Add Multi-File - 31"W P42B	1255
Add Storage With Doors 29"W P43B	1140
Add CPU /Printer Cabinet - Open P44B	1140

PEDESTAL MODIFICATIONS

modify drawer configurations

Style Number	List Price
File/File to Box/Box/File P6	55 Per ped
Box/Box/File to File/File P6	55 Per ped
Lateral File to 2 Box Drawers P8	100 Per ped

POWER / DATA

power supply cordset

Style Number	List Price
PD717	100

PRODUCT MODIFICATIONS

modify width - open kneespace

Style Number	List Price
MOD-1	125

Specifications

- Multi-file specify Box/Box Left or Right

Notes
- Add additional Standard Cabinets To Kneespace Area.

Specifications

- Modify File/File To Box/Box/File - Any Unit

Specifications

- SIZE: 10.75"L x 2.0"W x 1.06"H
 - (5) Outlets w/ 10' cord
 - Surge suppression (720 Joules)
 - 15 Amp breaker
 - Available on: Vertical Panels, Cabinet Interiors, and under tops

Specifications

- Modify width down on any unit with an open kneespace: desk, workstation credenza, bridge, return

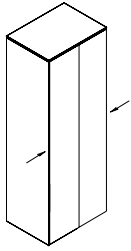

PRODUCT MODIFICATIONS
 modify width - open/closed storage

Style Number	List Price
MOD-2	250

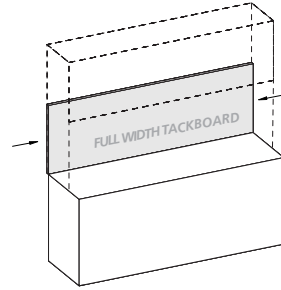

PRODUCT MODIFICATIONS
 modify width - tackboard, slat wall, veneer panel, or a glassboard

Style Number	List Price
MOD-4	50

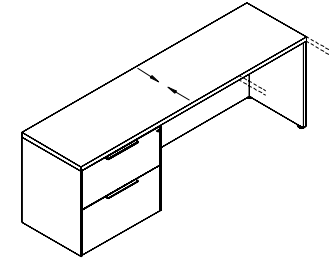

PRODUCT MODIFICATIONS
 modify depth - decrease depth

Style Number	List Price
MOD-5	125

Specifications

- Modify width down on any unit with open or closed storage section: overheads, wall hung units, storage credenzas, towers

Specifications

- Width modification outside of MOD-1 & MOD-2

Specifications

- Modify width down on tackboard, slat wall, veneer panel, or a overhead glassboard

Specifications

- Modify depth down (minimum depth for a unit with drawers is 21"D)

Notes

- Ex. 24" to 21", 30" to 24", and 36" to 30"

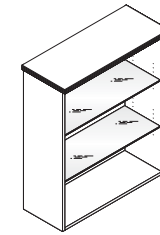
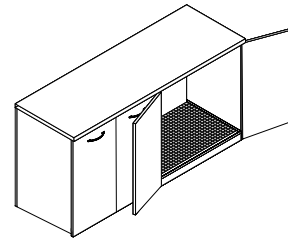
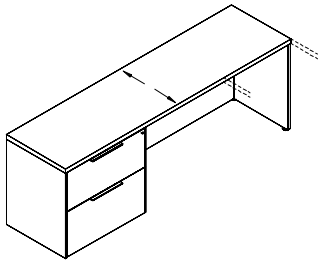

PRODUCT MODIFICATIONS
modify depth - increase depth

PRODUCT MODIFICATIONS
modify height

REFRIGERATOR MODIFICATION
refrigerator cabinet modification

SHELF MODIFICATIONS
glass shelves - tempered full width
26" - 35"

Style Number	List Price
MOD-6	Add 10%

Style Number	List Price
MOD-7	Contact for pricing

Style Number	List Price
REF01	205

Style Number	List Price
26"W - 35"W x 14"D Shelf GS14F	90

Specifications

- Increase depth by no more than 6"

Notes
 - Ex. 24" to 30", 30" to 36", and 36" to 42"
 - Add 10% to the unit you want to increase the depth of by no more than 6"

Specifications

- Modify height of a unit

Specifications

- Open back cutout for venting
- Moisture sponge mat
- Contaminate ledge
- Contact customer service for maximum refrigerator size (Changes based on unit).

Notes
 - Available on: 36" and 42" Storage Credenzas

Specifications

- Glass Shelves Replace Wood Shelf In Open Or Glass Door Cabinet. Also Order Interior Cabinet Lighting.

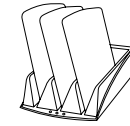
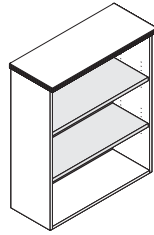
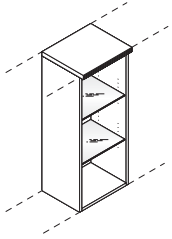

SHELF MODIFICATIONS
tempered glass shelves for half cabinet 17- 1/2" widths

SHELF MODIFICATIONS
heavy duty solid wood bookcase replacement shelves

SLAT WALL ACCESSORIES
slat wall accessory tray

SLAT WALL ACCESSORIES
slat wall folder tray

Style Number	List Price
14-1/2"W - 17- 1/2"W x 14"D Shelf GS14H	70 ea.

Style Number	List Price
1" Wood Shelf 14" Deep S714F	80 ea.
1" Wood Shelf 24" Deep S714FX	160 ea.

Style Number	List Price
SWA9	50

Style Number	List Price
SWA7	50

Specifications

- Glass Shelves Replace Wood Shelf In Open Or Glass Door Cabinet. Also Order Interior Cabinet Lighting.

Specifications

- 1" Solid Lumber Core Shelves Replace Standard 3/4" Plywood Adjustable And Fixed Shelves

Specifications

- Specify Black Or Matte Silver

Specifications

- Specify Black Or Matte Silver

Notes

- Replace only adjustable shelves between cabinet light and fixed lower wood shelf.

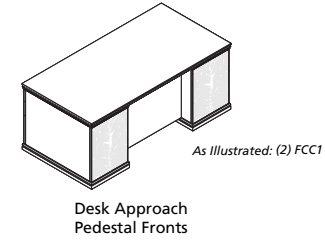
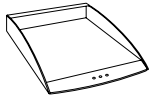

SLAT WALL ACCESSORIES
slat wall paper tray

Style Number	List Price
SWA2	40

SLAT WALL ACCESSORIES
slat wall pencil holder

Style Number	List Price
SWA4	30

SPECIALTY VENEER ACCENTS
croch mahogany infield with
mitered border

Style Number	List Price
TCB-1 - 84 x 36/42	Contact for Pricing
TCB-2 - 72 x 36/42	
TCB-3 - 72 x 30/36	

SPECIALTY VENEER ACCENTS
croch mahogany desk pedestal
fronts

Style Number	List Price
FCC1	Contact for Pricing

Specifications

- Specify Black Or Matte Silver

Specifications

- Specify Black Or Matte Silver

Specifications

- Center balanced butt and book matched croch mahogany
- 35 sheen non-rubbed finish ensures maximum durability

Specifications

- Center balanced butt and book matched croch mahogany
- 35 sheen non-rubbed finish ensures maximum durability

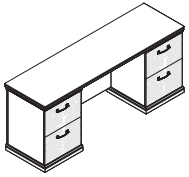

Box/Box/File or File/File
Drawer Fronts



All Three Illustrations Represent: (1) FCC2



Both Illustrations
Represent: FCC3



52" Center Balance Butt
& Bookmatch

SPECIALTY VENEER ACCENTS
crotch mahogany drawer fronts

SPECIALTY VENEER ACCENTS
crotch mahogany double width
panel fronts

SPECIALTY VENEER ACCENTS
crotch mahogany double width/
double height fronts

Style Number	List Price
FCC1	Contact for Pricing

Style Number	List Price
FCC2	Contact for Pricing

Style Number	List Price
FCC3	Contact for Pricing

Specifications

- Center balanced butt and book matched crotch mahogany
- 35 sheen non-rubbed finish ensures maximum durability

Specifications

- Center balanced butt and book matched crotch mahogany
- 35 sheen non-rubbed finish ensures maximum durability

Specifications

- Center balanced butt and book matched crotch mahogany
- 35 sheen non-rubbed finish ensures maximum durability

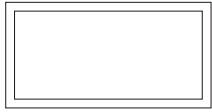

RECTANGLE INLAY

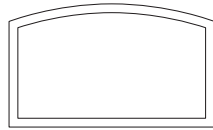

CURVED INLAY

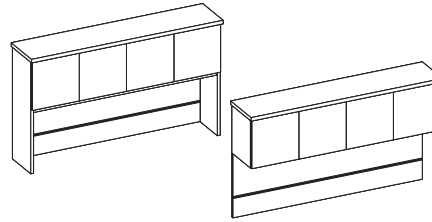

SPECIALTY VENEER ACCENTS
rectangle inlay - ebony hardwood
inlay detail

Style Number	List Price
T10SA	Contact for Pricing

SPECIALTY VENEER ACCENTS
bowfront inlay - ebony hardwood
inlay detail

Style Number	List Price
T11SA	Contact for Pricing

TOOL CHANNEL ACCESSORIES
recessed aluminum tool channel

Style Number	List Price
ATB02	5 per 1"W

Specifications

- 3/16" x 3/16" thick hardwood ebony inlay is handfitted and glued into routed top and sanded flush with surface
- Inlay is finished over with all finish steps

Notes
- Ebony inlay not recommended in: Koko Cherry

Specifications

- 3/16" x 3/16" thick hardwood ebony inlay is handfitted and glued into routed top and sanded flush with surface
- Inlay is finished over with all finish steps

Notes
- Ebony inlay not recommended in: Koko Cherry

Specifications

- Anodized aluminum finish
- Fully recessed
- Finish matches anodized aluminum accessories
- Can be specified with fabric tack surface mounted above channel

Notes
- If using tool channel with wallhung overhead, a veneer panel must be specified.

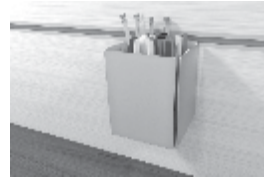
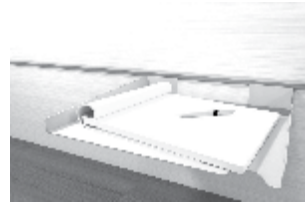

TOOL CHANNEL ACCESSORIES
iphone holder

TOOL CHANNEL ACCESSORIES
large shelf

TOOL CHANNEL ACCESSORIES
pencil pen holder

TOOL CHANNEL ACCESSORIES
tablet holder

Style Number	List Price
ATB31	125

Style Number	List Price
ATB35	130

Style Number	List Price
ATB38	120

Style Number	List Price
ATB30	145

Specifications

- For Console/Wall Hung Back Panels With Optional Tool Bar
- 18 Gauge Steel - Stamp Formed
- Silver Powdercoat Finish
- 5" x 3 -3/4"W
- Non-slip Neoprene pad

Specifications

- 12"W x 10"D

Specifications

- For Console/Wall Hung Back Panels With Optional Tool Bar
- 18 Gauge Steel - Stamp Formed
- Silver Powdercoat Finish
- 5"H x 4"W x 4"D

Specifications

- For Console/Wall Hung Back Panels With Optional Tool Bar
- 18 Gauge Steel - Stamp Formed
- Silver Powdercoat Finish
- 10" x 8"W
- Non-slip Neoprene pad

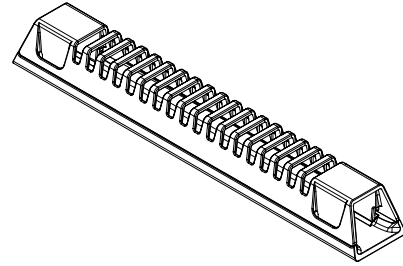
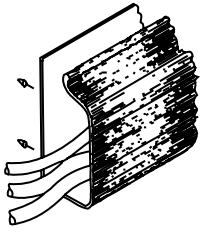

WIRE MANAGEMENT
horizontal j-channel wire
management raceway

WIRE MANAGEMENT
horizontal wire management
raceway

WIRE MANAGEMENT
horizontal u-channel wire
management raceway

WIRE MANAGEMENT
coil wire manager

Style Number	List Price
W1	80 Per 4' section

Style Number	List Price
W21	35

Style Number	List Price
W2A	80 Per 4' section

Style Number	List Price
W18	160

Specifications

- 4' section for field installation.
- The "J" shape black thermoplastic wire raceway may be added to specified worksurface tops to provide concealed channeling of wires to and from worksurface grommets. For use in open kneespace areas, raceway is attachable to top of back panel with pan head screws. Interior dimensions are 1" x 1- 1/2" providing ample storage for multiple wires and excess cable. Front of raceway flexes out for easy cord insertion.

- Notes
- Units w/ Wire Channel Standard.
 - Field Installation

Specifications

- 10"W x 1.5"D x 1.25"H
- Grey Wire Manager (10.5")
- Power and data cables can be discretely housed and managed with the W21 Gray Wire Manager. This can be mounted in any location to metal frame or underside of conference tables and runs cables through a 1" channel from power module to hollow steel legs. This keeps cables organized under the table top. Release clips make it simple to snap on and off the Wire Manager for easy organization and access after attached to the table

- Notes
- Field installed

Specifications

- 4' section for field installation.
- Notes
- Units w/ Wire Channel Standard.
 - Field Installation

Specifications

- Weighted Base, Table attachment plate
 - 39- 1/2" Length
 - Black
- Notes
- Location

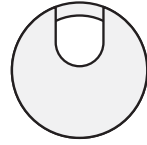
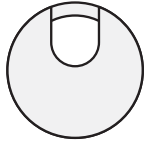

WIRE MANAGEMENT
standard location grommets -
factory installed

Style Number	List Price
Standard Location Grommet	
Black	
TM30	50
Silver	
TM31	50
Antique Brass	
TM33	50

WIRE MANAGEMENT
non-standard location grommets -
factory installed

Style Number	List Price
Non-Standard Location Grommet	
Black	
TM30 -NS	95
Silver	
TM31 -NS	95
Antique Brass	
TM33 -NS	95

WIRE MANAGEMENT
black plastic vertical surface
grommets - factory installed

Style Number	List Price
Standard Location Grommet	
TM50-C	50
Non-Standard Location Grommet	
TM50-NS	95

Specifications

- 1 -5/8" Metal Grommet

Notes
- *Units w/ Grommets Standard Are Noted Under Standard Features. Grommets Match Pull Finish - Standard (Unless Specified Otherwise)

Specifications

- 1 -5/8" Metal Grommet

Notes
- *Units w/ Grommets Standard Are Noted Under Standard Features. Grommets Match Pull Finish - Standard (Unless Specified Otherwise)

Specifications

- 2 " Black Plastic Grommet

Notes
- Standard Location is Bottom Center

Aircharge wireless charging grommet

Style Number	List Price
ACWG WIRELESS GROMMET	\$195

Specifications

- › When used with GROVE Tables an additional \$350 LIST will apply for the special cutout required.
- › AirCharge offers a convenient way to charge any Qi compatible smartphone or device without the need to carry charging cables or find an available power outlet.
- › The Aircharge is powered by the latest Qi compliant IC offering reliable and efficient wireless charging in a convenient 3" grommet hub. Simply place your phone on the Aircharge and an LED will confirm pairing and begin wireless charging.
- › Recess: Efficient space conservation and quick access
- › Input: DC 5V (with included AC power adapter), DC 9V, 1.67A (with optional QC 2.0 power adapter)
- › Output: 5 watts Max. with DC 5V, 2A power adapter, 10 watts Max. with QC 2.0 power adapter
- › Qi V1.2 compliant IC
- › Charging distance: 6mm Max.

Available: All DARRAN collections



Cove power unit - non-linking

Style Number		List Price
PD-COVE PLUG		\$550
Non-linking version		

Specifications

- › Size 5.75"L x 2.5"W
- › (2) 15 Amp Receptacles and (2) USB charging ports
- › Surface Mount
- › 108" Cord
- › Standard Silver Finish, Available in White or Black Finish upon request
- › ETL Listed

Available: All DARRAN collections



Cove corded series

Style Number	List Price
 PD-COVE-PKO	\$800

Specifications

- › Size 9.5”L x 2.5”W x 3.18”D
- › When used with GROVE Tables an additional \$350 LIST will apply for the special cutout required.
- › (2) Power Receptacles, (2) 2.1 Amp USB charging ports and (1) Telecom Plate Knockout
- › Surface Mount
- › 108” Cord
- › Standard Silver Finish, Available in White or Black Finish upon request
- › ETL Listed

Available: All DARRAN collections

Telecom Plates

RJ45 (1)	\$35
RJ45 (2)	\$70
RJ45 (3)	\$105
USB (1)	\$70
USB (2)	\$140
RJ11/RJ45	\$70
RJ45/USB	\$105
RJ45/HDMI	\$190
HDMI/DVI	\$325
HDMI/USB	\$205
HDMI/VGA	\$240
VGA/MINI-STEREO	\$155
VGA/USB	\$175

This pod can have up to 1 total plates.
 *All telecom connectors sold separately.



DARRAN®

Soba wire manager

Style Number	List Price
STARTER UNITS	
SCDW	\$200
White wire manager	
SCDB	\$200
Black wire manager	

Specifications

- › Dimensions: 9ft x 9in x 3.15in
- › Zips up, bundles and routes loose, messy cables into a single tube
- › Routes and guides cables behind desks, TVs, and anywhere cables tend to get messy
- › Accommodates large or small cables, up to three cables at once
- › Support channels, used to route cables, include powerful adhesive backing which allows easy attachment to surfaces.

Available: All DARRAN collections

Power & Data Options



DARRAN®

VILLA Power unit - non-linking

Style Number	List Price
 VIL-C PLUG	\$515
Non-Linking	

Specifications

- › Size: Top Grommet 5.68”L X 3.39”W; Under Top 12”L x 3.13”W x 3.08”D
- › (2) Power receptacles; (2) USB charging ports and (1) Knockouts for RJ45 Data Ports
- › Surface Mount
- › 72” Cord (Longer cord available, contact Customer Service)
- › Standard Silver Finish, Black Finish available upon request
- › UL or ETL Certified

Available: All DARRAN collections, excludes Grove

RJ45 Knockout	
RJ45 (1)	\$35

Power & Data Options

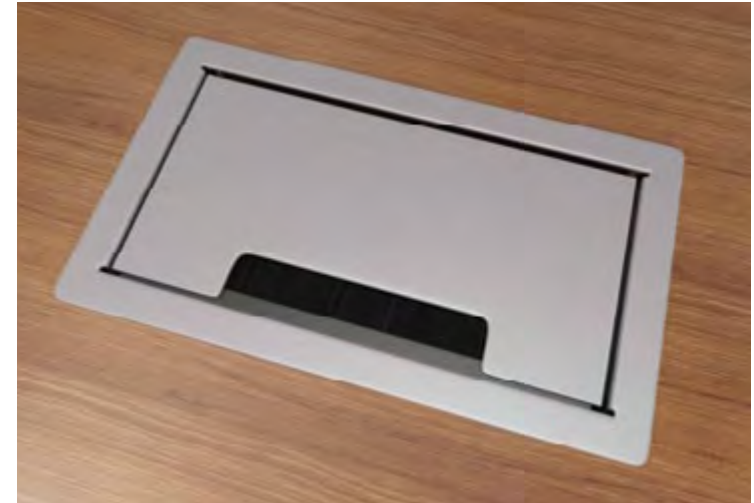

DARRAN



Richmond Park Price List

Effective November 1, 2022

Date	Page	Modification	Description
11.11.22		Price Increase	9% price increase applied to all itmes excluding options
01.19.23	7	Grommets removed	M35 and M51
02.15.23		Remove leather inlays	

Statement of Line
Features & Advantages1
Finishes | Specifications3
Edges | Pulls | Knobs.....4
Grommets | Grommet Reference.....5
Ganging | Height Reference6
Modesty Reference | Grain Direction.....7
Drawer Dimensions | Filing Reference8
Double Pedestal Desk.....9
Single Pedestal Desk.....12
Workstation Desk14
Returns.....15
Bridges17
Freestanding Credenzas18
Workstation Credenzas23
Single Height Freestanding Overheads.....25
Overhead Accessories.....26
Single Height Wall Hung Overheads.....30
Wall Hung Accessories31
Overhead Bookcases36
Vertical Half Towers.....38
Vertical Full Towers.....40
Bookcases42
Options43
Power & Data.....57

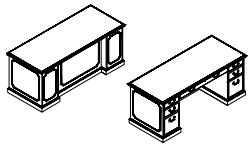

Page 9
Double Pedestal Desks
Executive Chassis Breakfront

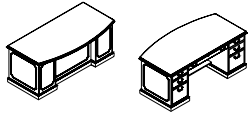

Page 10
Double Pedestal Desks
Bowfront / Breakfront Executive
Chassis

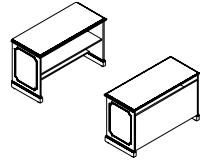

Page 11
Desks
Crt Desk / Printer

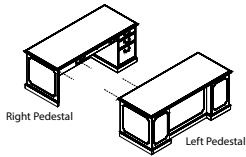

Page 12
Workstation Desks
Executive Breakfront Chassis
Single Pedestal Desk

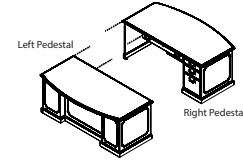

Page 13
Workstation Desks
Bowfront / Breakfront Executive
Chassis Single Pedestal Desk

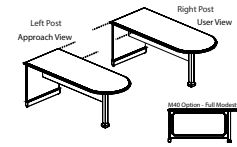

Page 14
Workstation Desks
Bullet Conference Desk

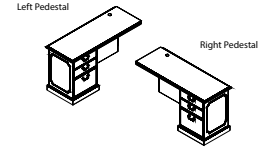

Page 15
Workstation Returns
Box / Box / File

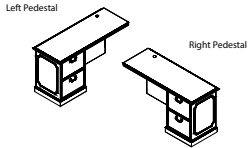

Page 16
Workstation Returns
File / File

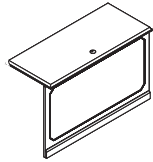

Page 17
Workstation Units
Bridge W/ Fixed Full Modesty

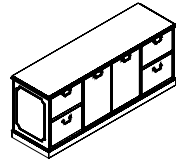

Page 18
Credenzas / Files
Storage Credenza

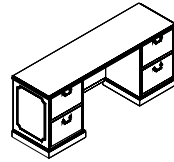

Page 19
Credenzas / Files
Kneespace Credenza

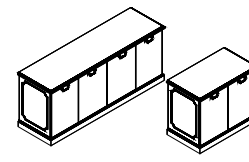

Page 20
Credenzas
Storage Credenza

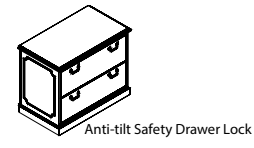

Page 21
Lateral File Credenzas
Horizontal Lateral File



Page 22
Credenzas / Files
Vertical Lateral File

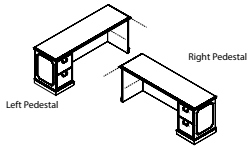

Page 23
Workstation Credenza
File / File

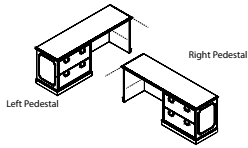

Page 24
Workstation Credenza
Lateral File

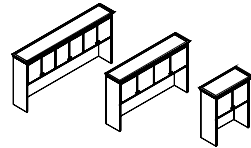

Page 25
Overhead Consoles
Freestanding - Panel Door

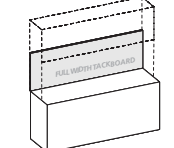

Page 26
Overhead Tackboards

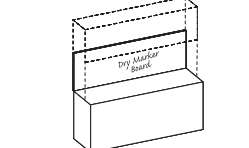

Page 27
Overhead Dry Marker Boards

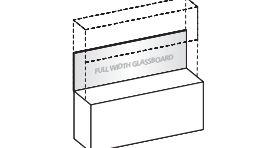

Page 28
Overhead Glassboards

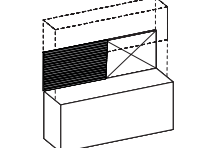

Page 29
Overhead Slat Wall

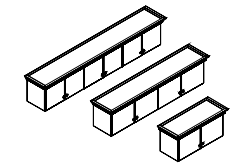

Page 30
Wall Hung Overheads
Panel Doors

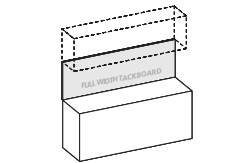

Page 31
Wall Hung Tackboards

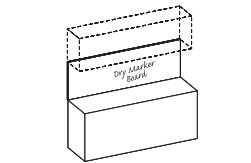

Page 32
Wall Hung Dry Marker Boards

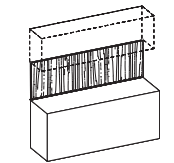

Page 33
Wall Hung Veneer Panels

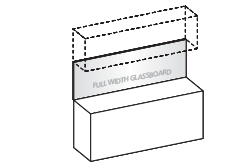

Page 34
Wall Hung Glassboards

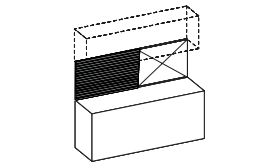

Page 35
Wall Hung Slat Wall

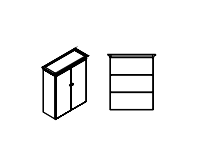

Page 36
Assembled Overhead Bookcase
/ Hutch
Panel Door

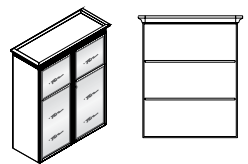

Page 37
Assembled Overhead Bookcase
/ Hutch
Wood Frame Door W/ beveled
glass Insert

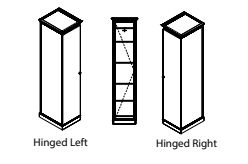

Page 38
Vertical Half Towers
Wardrobe / Storage

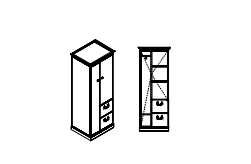

Page 39
Vertical Half Towers
Storage / File/File With Mini-Ward-
robe

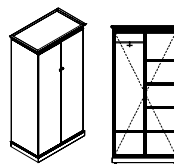

Page 40
Vertical Full Towers
Freestanding Wardrobe / Storage

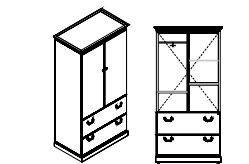

Page 41
Vertical Full Towers
Freestanding Lateral File /
Storage

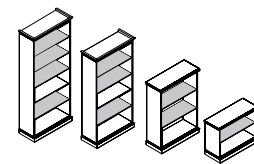

Page 42
Assembled Bookcases
Open Bookcase

Veneer

DARRAN only uses HPVA AA Grade Flat Cut Cherry and Walnut Veneers. All veneers are selected and matched for balance and consistency.

Veneer tops

Richmond park veneer tops feature a 45-pound density substrate with balanced 3-ply construction. Tops are 1-1/8" thick on MDF core comprised of 100% recycled and recovered wood fibers. All veneer tops are slipmatched and feature a 3mm external solid hardwood band or profile edge.

Laminate tops

Richmond park high-pressure laminate tops feature a 45-pound density substrate with balanced 3-ply construction. Tops are 1-1/8" thick on MDF core comprised of 100% recycled and recovered wood fibers. All high pressure laminate tops are available with a profile edge, laminate self-edge or 2mm PVC edge band. Laminates in wood grain patterns feature a fine grain texture that features the polish and luxe of a real wood veneer with a subtle narrow grain structure.

Cleaning wood & laminate

In addition to regular dusting, give your furniture an occasional cleaning in accordance with our cleaning instructions. DARRAN wood and laminate products can be cleaned with a soft cloth and a mild soap and water mixture. Use approximately 32 oz of water mixed with one tablespoon of dish soap, always wiping with the grain. Dry with a soft cloth, going with the grain, to avoid spotting or streaking.

Wood products should be waxed periodically using a non-wax liquid; please do not use any waxy polish or cleaner. Interior of drawers may also be cleaned with mild soap and water mixture, or any household cleaner that is not petroleum or thinner-based.

Chassis & pedestal

Chassis components are 3/4" thick core of particle board or MDF rated EPP/SCS/CARB-II material with 3-ply balanced construction. Pedestal and Cabinets feature dowel construction reinforced with steel bracket plates, wood cleats, screws and glue. All units are standard with 1" adjustable glides that allow for leveling of units that are secured in solid wood glide blocks to prevent tearout.

Overhead cabinet construction Freestanding & wall mount

Freestanding Overhead storage cabinets are constructed of 1" and 3/4" thick core of particle board or MDF rated EPP/SCS/CARB-II material with 3-ply balanced construction. Panels are attached with cam fasteners in conjunction with dowels securely adhered with glue. All surface mount cabinets connect to work surface with anti-slip tape. Wall mount cabinets are mounted to the wall with steel "z" bracket attachment method using 5mm euro screws to attach to the back of the cabinet. All units ship with a steel "z" bracket. This bracket is mounted to the wall by field

Richmond Park Features & Advantages

installers. Installers are responsible for selecting and supplying appropriate fasteners for wall conditions.

Bookcase Construction

All chassis (sides, back, top and bottom panels) are constructed with 3/4" thick core of particle board or MDF rated EPP/SCS/CARB-II material with 3-ply balanced construction. Panels are attached with cam-lock fasteners in conjunction with dowels securely adhered with glue. Shelves on all units are 3/4" thick balance 3 ply panels. Optional heavy duty shelves are 1" thick lumber core balanced 5 ply construction.

Tackboards

Wall mount tackboards are constructed of .75" thick fiberboard. The fabric is precisely aligned and fitted to the tackboard with a sock on cover. Overhead storage tackboards are constructed of .75" thick fiberboard. The fabric is precisely aligned and fitted to the tackboard and adhered to the rigid hardboard with staples. Wall mount cabinets are mounted to the wall with steel "z" bracket attachment method using 5mm euro screws to attach to the back of the cabinet. All units ship with a steel "z" bracket. This bracket is mounted to the wall by field installers. Installers are responsible for selecting and supplying appropriate fasteners for wall conditions.

Adjustable glides

Glides provide 1" of vertical leveling adjustment. Glide bottom is durable metal. Glides are secured in solid wood blocks that are screwed and glued for durability.

Drawers

All drawers are constructed with mitre joint/dowel construction in a natural maple finish with four sides and a bottom, which are attached to a drawer front with screws for easy removal. Drawer fronts are vertically matched in balanced sets. Pencil trays are standard in all box drawers. Drawers are constructed of 1/2" thick wood grained wrapped 5 sided miter-folded construction with 1/4" thick hardboard bottoms reinforced for heavy weight capacity. Drawers have been tested and pass BIFMA 50,000 cycle test. All drawers are guaranteed lifetime with free replacement warranty.

Drawer fronts

Drawer fronts are vertically matched in balanced sets. Doors feature vertical veneer bookmatched horizontally in sets of 2 / 4 and 6 doors. All tower fronts matched in vertical sets.

Optional wood drawers

Optional hardwood veneer plywood drawers feature banded top and bottom edges for smoothness. Drawers are dowel joint construction with a UV cured finish over maple veneers, plus a lifetime free replacement guarantee.

Optional Wood Drawer (Any Size) – Option Code P33...\$45 List Price Per Drawer

Suspensions

All caseloads utilize cold rolled steel zinc plated high-grade drawer suspensions. Box and File drawers are full extension, featuring steel ball bearings for a smoother quieter range of motion with soft close operation and are rated 100lbs. Lateral file drawers are a progressive action full extension suspension with the soft close operation and is rated at 150lbs. Lateral files include anti tip mechanism that will allow only one drawer at a time to be opened. All suspensions are soft close and are warranted for the lifetime of the product.

Hinges

Units with doors include 95 degree swing hinges.

Filing

Capitol park features a highly durable black plastic extrusion that is securely fastened into a route on top of the drawer to support hanging files. An adjustable crossbar is provided for all file drawers that enables legal/letter filing front to back or side-to-side based on the drawer size.

Locks

Locks are Standard on all drawers below the worksurface. Random lock cores are installed at the factory. Some units may be shipped with the same key number. Locks are Silver, Black or Bronze and match pull finish unless otherwise specified.

DARRAN will also send lock cores separately to the dealer at your request. These units will be send with an empty lock core and the Dealer will receive a shipment of the requested lock core/keys.

Keying

Keying is available either factory or field installed. Factory installed keying is random.

Wire management

Wire management capabilities include standard and optional worksurface grommets. Specify W-1 under surface wire channels for organization and management of all communication wires and cords. Horizontal J-Channel wire management (Sku: W-1) is sold separately to conceal wire under worksurfaces.

Grommets

Metal grommets are provided to match the drawer pull selection. Grommet is available in black, silver, white or antique brass. Must specify standard or non-standard location. Black plastic grommets are available as an option for vertical applications.

Powerports

A large selection of power pods are available and handle power, data, docking stations and communication. See options section for selection.

LED tasklights

LED task lighting provides high efficiency, low energy lighting with a long life. Surface mounted light is encased in silver aluminum channel with milk lense and rounded end caps. Lights are field installed. Product specifications listed below:

- Diffuser creates a softer light and eliminates hot spots
- Touch dimmer switch
- Can be “daisy chained” up to 90W
- 4.6 watts per foot
- 120 LEDs per meter
- Certification: UL Listed
- 50,000 hour life span.

Color Temp is 4000K

STANDARD VENEER	PREMIUM VENEER	HIGH PRESSURE LAMINATE	THERMALLY FUSED LAMINATE
WAC Amber Cherry.....	N/A.....	GAC Amber Cherry.....	N/A
WIC Crimson Cherry.....	N/A.....	GIC Crimson Cherry.....	N/A
WHC Honey Cherry.....	N/A.....	GHC Honey Cherry.....	N/A
WOC Koko Cherry.....	N/A.....	GOC Koko Cherry.....	N/A
WEW Executive Walnut.....	N/A.....	GEW Executive Walnut.....	N/A
WGW Gunstock Walnut.....	N/A.....	N/A.....	N/A
WBW Henna Walnut.....	N/A.....	N/A.....	N/A
WSW Smokey Walnut.....	N/A.....	N/A.....	N/A
WNW Natural Walnut.....	N/A.....	GNW Natural Walnut.....	N/A

Send 3x3 or larger finish chip for color match. Custom finish upcharge is 3% or \$250 Net (whichever is greater).



Finish
 Welltech Finish delivers a superior furniture coating with exceptional performance that can withstand stringent cleaning agents and possesses unparalleled durability, allowing DARRAN to provide lasting, sustainable products to our customers.

DARRAN®

Standard profile

Richmond Park Edge
Hardwood Rim Band Species Same As
Surface Veneer

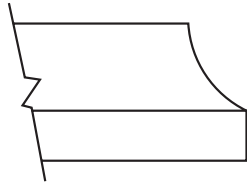

Hookup edge profile

Coped Edge

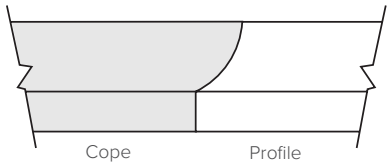

Base profile



Drawer/door edge profile



Optional profile

Classic Edge - No additional
upcharge
Hardwood Rim Band Species Same
As Surface Veneer

Richmond Park Edges | Pulls | Knobs

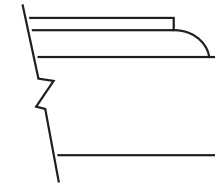

3mm solid
hardwood band

Cornice top profile

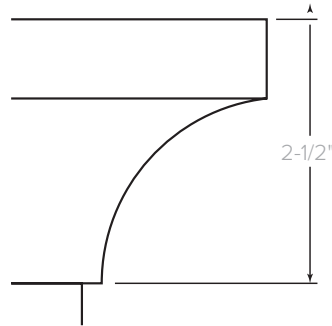

Pulls/knobs

Factory Installed



PL-5 Antique Brass
PL-50 Brushed Pewter

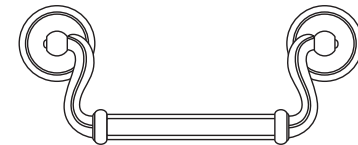

PL-4 Antique Brass



DK-114
Brushed Pewter



DK-4
Antique Brass

DARRAN®



TM30
Black
1-5/8" Dia.

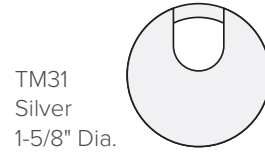

TM31
Silver
1-5/8" Dia.

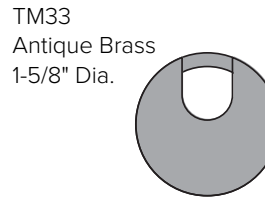

TM33
Antique Brass
1-5/8" Dia.

Optional grommets

Factory Installed

Grommets (Standard Location)

Specify Color and Left/Right/Center - \$50 ea.

- Black: TM30-R (Right), TM30-L (Left), TM30-C (Center)
- Silver: TM31-R (Right), TM31-L (Left), TM31-C (Center)
- Antique Brass: TM33-R (Right), TM33-L (Left), TM33-C (Center)

Grommets (Non-Standard Location)

Provide drawing w/ Grommet Location and Specify Color - \$95 ea.

- Black: TM30-NS
- Silver: TM31-NS
- Antique Brass: TM33-NS

Richmond Park Grommets | Grommet Reference

TM50
Black
1-5/8" Dia.

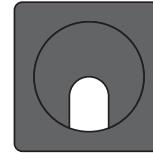

Grommets (vertical surface)

Standard Location - \$50 ea.

- Black Plastic Vertical Surface: TM50-C (Bottom Center)

Non-Standard Location - \$95 ea.

- Black Plastic Vertical Surface: TM50-NS

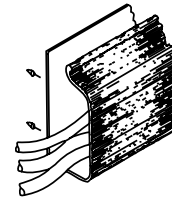

W1

Horizontal J-channel

Horizontal J-Channel wire management (Sku: W-1) is sold separately to conceal wire under worksurfaces.

Standard grommet location reference

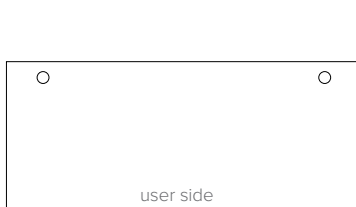

Desk
Specify Right or Left Grommet



6" Overhang Desk
Specify Right or Left Grommet

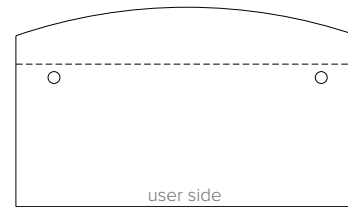

6"/12" Bow Front Desk
Specify Right or Left Grommet



Bullet Conference Desk (Right Post)
Center Grommet

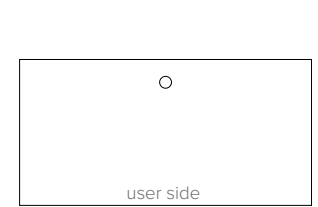

Bridge
Center Grommet

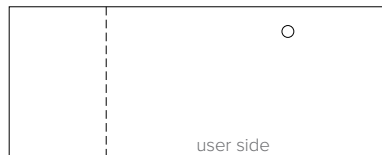

Return (Left Pedestal Shown)
Right Pedestal - Left Grommet
Left Pedestal - Right Grommet



Workstation Credenza
Center Kneespace Grommet

Ganging – Flush Cut Modification

30”H Casework Worksurface & Base Ganging Modifications

To gang two casework units, each unit end to be ganged must be flush cut modified for gapless surfaces and cabinet chassis.

Order Option:

- FC-B: Flush Unit Both Sides(Facing) for Ganging - \$100
- FC-L: Flush Unit Left (Facing) for Ganging - \$100
- FC-R: Flush Unit Right (Facing) for Ganging - \$100

Flush cut modification per unit includes all modifications to gang to one end or both ends when units are ganged. Modification includes tops, base and molding. Modification reduces width size approximately 1” per end.

Overhead consoles and towers are offered freestanding and ganging – inclusive of flush cut modifications.

Example:

RPC3121100W Two Drawer Lateral File (Left) Flush Cut Right – FC-R...\$100

RPC7221054 Kneespace Credenza (Right) Flush Cut Left – FC-L...\$100



Height reference

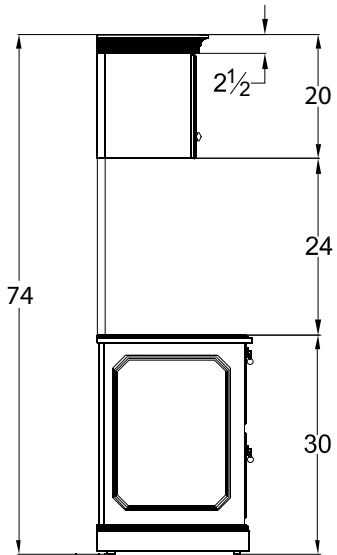

Typical Single Height Side Profile Wall Hung Overhead

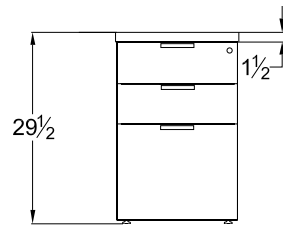

Pedestal Front Profile Box/Box/File

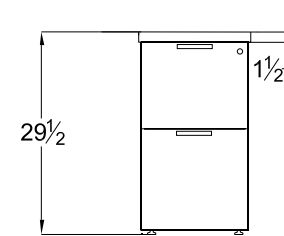

Pedestal Front Profile File/File

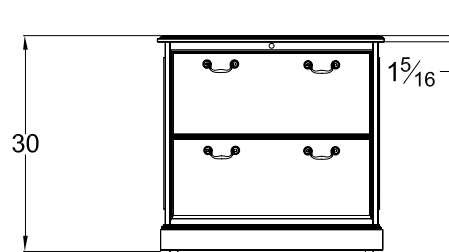

Pedestal Front Profile Lateral File

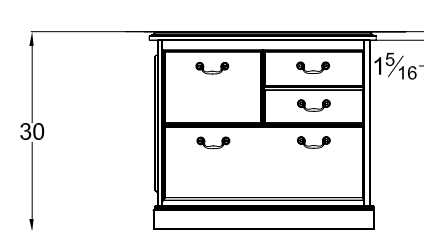

Pedestal Front Profile Multi-File

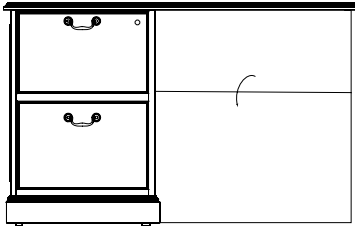

M34
Drop Door Tech Modesty

Top View

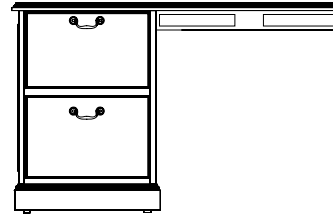

M51
Open Back Modesty with 4" Wire Management Rail

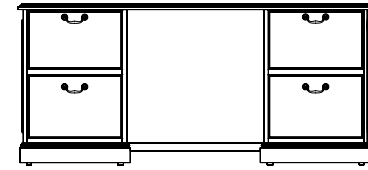

M37
Fixed Full Modesty

Grain direction

Veneer chassis parts are vertical grain. Doors feature vertical veneer bookmatched horizontally in sets of 2, 4, and 6 doors. Tower fronts are matched in vertical sets.



Desk

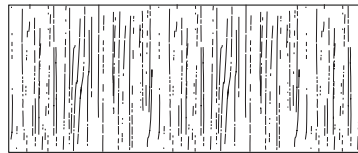

Runoff Desk
Grain Direction on TFL
Units Above 66" runs end to end

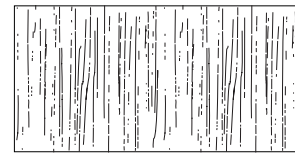

Bridge
Grain Direction on TFL
Units Above 66" runs end to end

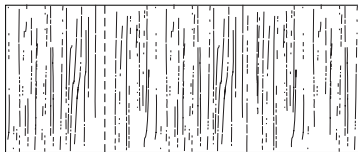

Return
Grain Direction on TFL Units
Above 66" runs end to end

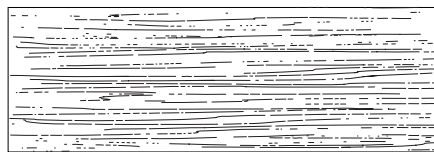

Credenza

Interior drawer dimensions

UNIT DEPTH	DRAWER TYPE	OVERALL DIMENSIONS			INTERIOR DRAWER DIMENSIONS			NOTES
		W	D	H	W	D	H	
15-5/8" Letter	36" Box	13-1/8	19-11/16	4	12-1/8	18-11/16	3-7/16	Units less than 72"
	36" File	13-1/8	19-11/16	9-13/16	12-1/8	18-11/16	9-5/16	Units less than 72"
	30" Box	13-1/8	19-11/16	4	12-1/8	18-11/16	3-7/16	Units less than 72"
	30" File	13-1/8	19-11/16	9-13/16	12-1/8	18-11/16	9-5/16	Units less than 72"
	24" Box	13-1/8	16-1/16	4	12-1/8	15-1/16	3-7/16	Units less than 72"
	24" File	13-1/8	16-1/16	9-13/16	12-1/8	15-1/16	9-5/16	Units less than 72"
29" Lateral	24" Box	26-1/2	16-1/16	4	25-1/2	15-1/16	3-7/16	Workstation Credenzas less than 82"
	24" File	26-1/2	16-1/16	9-13/16	25-1/2	15-1/16	9-5/16	Workstation Credenzas less than 82"
35" Lateral	24" Box	32-1/2	16-1/16	4	31-1/2	15-1/16	3-7/16	Workstation Credenzas over 83"
	24" File	32-1/2	16-1/16	9-13/16	31-1/2	15-1/16	9-5/16	Workstation Credenzas over 83"
41" Lateral	24" File	38-1/2	16-1/16	9-13/16	37-1/2	15-1/16	9-5/16	Wood Drawer Only

Filing reference

Filing for 24" depth units

13 1/8" Wide File Drawer - 16 1/16" Deep

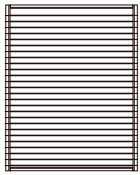

Letter Front to Back

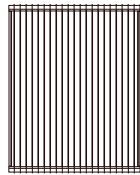

Legal Side to Side with File Rail

29" Lateral file drawer

26-1/2" Wide File Drawer - 16-1/16" Deep

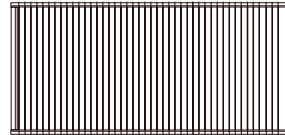

Legal Side to Side

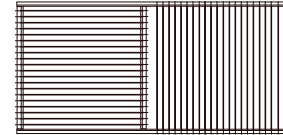

Legal Side to Side Letter Front to Back with File Rail

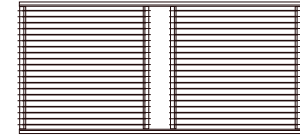

Letter Front to Back with File Rail

Filing for 30" & 36" depth units

13 1/8" Wide File Drawer - 19 11/16" Deep

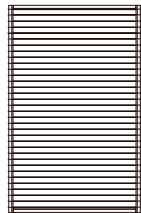

Letter Front to Back

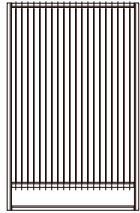

Legal Side to Side with File Rail

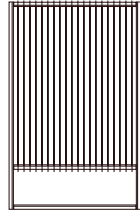

Letter Side to Side with File Rail

35" Lateral File Drawer

32-1/2" Wide File Drawer - 16-1/16" Deep

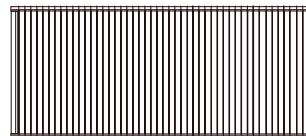

Legal Side to Side

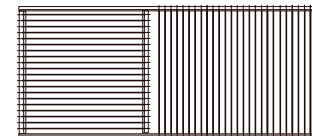

Legal Side to Side Letter Front to Back with File Rail

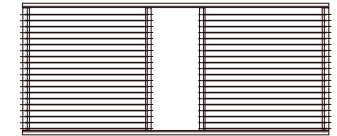

Letter Front to Back with File Rail

Richmond Park

Double Pedestal Desks
Executive Chassis Breakfront

[Click here to view statement of line](#)

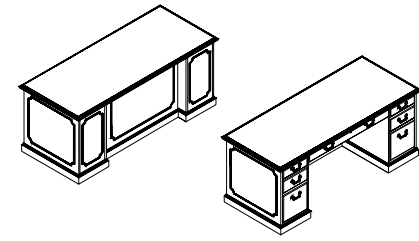

1 Select Model

w" x d" x h"	Weight
84 x 36 x 30	350
72 x 36 x 30	335
72 x 30 x 30	320
66 x 36 x 30	315
66 x 30 x 30	275
60 x 30 x 30	230

Standard Veneer Top Standard Veneer Chassis		Premium Veneer Top Premium Veneer Chassis		High Pressure Laminate Top Veneer Chassis		Thermally Fused Laminate Top Thermally Fused Laminate Chassis	
RPC8436DD000W	5381	"P" Option N/A		RPC8436DD000G	5381	"M" Option N/A	
RPC7236DD000W	4848	"P" Option N/A		RPC7236DD000G	4848	"M" Option N/A	
RPC7230DD000W	4753	"P" Option N/A		RPC7230DD000G	4753	"M" Option N/A	
RPC6636DD000W	4753	"P" Option N/A		RPC6636DD000G	4753	"M" Option N/A	
RPC6630DD000W	4637	"P" Option N/A		RPC6630DD000G	4637	"M" Option N/A	
RPC6030DD000W	4297	"P" Option N/A		RPC6030DD000G	4297	"M" Option N/A	
<p>2 Select Finish</p> <p>Click to view finishes</p> <ul style="list-style-type: none"> WAC WIC WHC WOC WEW WGW WBW WSW WNW 				<p>GAC</p> <p>GIC</p> <p>GHC</p> <p>GOC</p> <p>GEW</p> <p>GNW</p>			
<p>3 Select Edge</p> <p>Click to view edges</p> <div style="display: flex; justify-content: space-around;"> <div style="text-align: center;">  <p>Richmond</p> </div> <div style="text-align: center;">  <p>Classic</p> </div> </div>				<p>Richmond Classic</p> <div style="display: flex; justify-content: space-around;">   </div>			
<p>4 Select Hardware</p> <p>Click to view details</p> <div style="display: flex; justify-content: space-around;"> <div style="text-align: center;">  <p>PL-4 Antique Brass</p> </div> <div style="text-align: center;">  <p>PL-5 Antique Brass PL-50 Brushed Pewter</p> </div> </div>				<div style="display: flex; justify-content: space-around;"> <div style="text-align: center;">  <p>PL-4 Antique Brass</p> </div> <div style="text-align: center;">  <p>PL-5 Antique Brass PL-50 Brushed Pewter</p> </div> </div>			

Product Features

- Box/Box/File
- Full extension drawers - locking
- Drawer fronts w/ profile edges
- Full modesty w/ base
- Laminate pull out writing shelf
- Soft close suspension drawer(s)
- Center Drawer Standard

Options

Accessories

- K28: Articulating Keyboard w/ Mouse pad (removes center drawer) - \$390

Drawer

- P6: Modify Box/Box/File to File/File - \$55 per pedestal
- P33: Wood Drawer Upgrade - \$45 per drawer

Grommets (Standard Location)

Specify Color and Location Right/Left - \$50 ea.

- Black: TM30-R (Right), TM30-L (Left)
- Silver: TM31-R (Right), TM31-L (Left)
- Antique Brass: TM33-R (Right), TM33-L (Left)

Grommets (Non-Standard Location)

Provide drawing w/ Grommet Location and Specify Color - \$95 ea.

- Black: TM30-NS
- Silver: TM31-NS
- Antique Brass: TM33-NS

Molding

- DSM1: Delete molding - Deduct \$95

Richmond Park

Double Pedestal Desks
Bowfront / Breakfront Executive Chassis

[Click here to view statement of line](#)

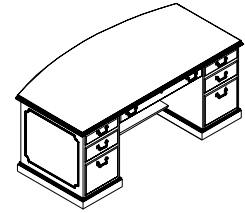
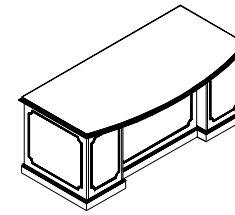

1 Select Model

w" x d" x h"	Weight
84 x 36/42 x 30	370
72 x 36/42 x 30	350
72 x 30/36 x 30	340
66 x 30/36 x 30	325

Standard Veneer Top Standard Veneer Chassis		Premium Veneer Top Premium Veneer Chassis		High Pressure Laminate Top Veneer Chassis		Thermally Fused Laminate Top Thermally Fused Laminate Chassis	
--	--	--	--	--	--	--	--

RPC8442DD006W	5906	"P" Option N/A	RPC8442DD006G	5906	"M" Option N/A
RPC7242DD006W	5373	"P" Option N/A	RPC7242DD006G	5373	"M" Option N/A
RPC7236DD006W	5169	"P" Option N/A	RPC7236DD006G	5169	"M" Option N/A
RPC6636DD006W	5077	"P" Option N/A	RPC6636DD006G	5077	"M" Option N/A

Product Features

- Box/Box/File
- Center Drawer standard
- Drawer fronts w/ profile edges
- Full extension drawers - locking
- Full fixed modesty w/ base
- Laminate pull out writing shelf
- Soft close suspension drawer(s)

Notes

- 6" overhang on approach

Options

Accessories

- K28: Articulating Keyboard w/ Mouse pad (removes center drawer)
- \$390

Drawer

- P6: Modify Box/Box/File to File/File - \$55 per pedestal
- P33: Wood Drawer Upgrade - \$45 per drawer

Grommets (Standard Location)

- Specify Color and Location Right/Left - \$50 ea.
- Black: TM30-R (Right), TM30-L (Left)
 - Silver: TM31-R (Right), TM31-L (Left)
 - Antique Brass: TM33-R (Right), TM33-L (Left)

Grommets (Non-Standard Location)

- Provide drawing w/ Grommet Location and Specify Color - \$95 ea.
- Black: TM30-NS
 - Silver: TM31-NS
 - Antique Brass: TM33-NS

Molding

- DSM1: Delete molding - Deduct \$95

2 Select Finish

[Click to view finishes](#)

- WAC
- WIC
- WHC
- WOC
- WEW
- WGW
- WBW
- WSW
- WNW

- GAC
- GIC
- GHC
- GOC
- GEW
- GNW

3 Select Edge

[Click to view edges](#)



4 Select Hardware

[Click to view details](#)



Richmond Park

Desks
Crt Desk / Printer

[Click here to view statement of line](#)

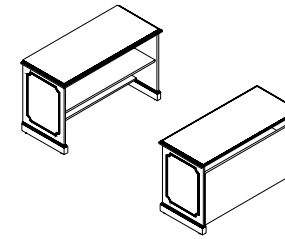

1 Select Model

w" x d" x h"	Weight
48 x 24 x 30	130
42 x 24 x 30	120
36 x 24 x 30	110

Standard Veneer Top Standard Veneer Chassis	Premium Veneer Top Premium Veneer Chassis	High Pressure Laminate Top Veneer Chassis	Thermally Fused Laminate Top Thermally Fused Laminate Chassis												
<table border="1"> <tr> <td>RPC4824AU225W</td> <td>2467</td> </tr> <tr> <td>RPC4224AU225W</td> <td>2382</td> </tr> <tr> <td>RPC3624AU225W</td> <td>2323</td> </tr> </table>	RPC4824AU225W	2467	RPC4224AU225W	2382	RPC3624AU225W	2323	<p>"P" Option N/A "P" Option N/A "P" Option N/A</p>	<table border="1"> <tr> <td>RPC4824AU225G</td> <td>2467</td> </tr> <tr> <td>RPC4224AU225G</td> <td>2382</td> </tr> <tr> <td>RPC3624AU225G</td> <td>2323</td> </tr> </table>	RPC4824AU225G	2467	RPC4224AU225G	2382	RPC3624AU225G	2323	<p>"M" Option N/A "M" Option N/A "M" Option N/A</p>
RPC4824AU225W	2467														
RPC4224AU225W	2382														
RPC3624AU225W	2323														
RPC4824AU225G	2467														
RPC4224AU225G	2382														
RPC3624AU225G	2323														

2 Select Finish

[Click to view finishes](#)

- WAC
- WIC
- WHC
- WOC
- WEW
- WGW
- WBW
- WSW
- WNW

- GAC
- GIC
- GHC
- GOC
- GEW
- GNW

3 Select Edge

[Click to view edges](#)



4 Select Hardware

[Click to view details](#)

Hardware
N/A

Hardware
N/A

Product Features

- 6" Storage foot shelf
- Adjustable shelf
- Wire/Paper access back

Options

Grommets (Standard Location)

Specify Color - \$50 ea.

- Black: TM30-C (Center)
- Silver: TM31-C (Center)
- Antique Brass: TM33-C (Center)

Grommets (Non-Standard Location)

Provide drawing w/ Grommet Location and Specify Color - \$95 ea.

- Black: TM30-NS
- Silver: TM31-NS
- Antique Brass: TM33-NS

Grommets (Vertical Surface)

Standard Location - \$50 ea.

- Black Plastic Vertical Surface: TM50-C (Bottom Center)
- Non-Standard Location - \$95 ea.
- Black Plastic Vertical Surface: TM50-NS

Molding

- DSM2: Delete molding - Deduct \$50

Richmond Park

Workstation Desks

Executive Breakfront Chassis Single Pedestal Desk

[Click here to view statement of line](#)

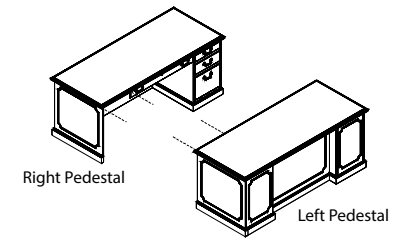

1 Select Model

w" x d" x h"

	Weight						
Left Pedestal							
72 x 36 x 30	290	RPC7236DS009W	4178	"P" Option N/A	RPC7236DS009G	4178	"M" Option N/A
72 x 30 x 30	255	RPC7230DS009W	4136	"P" Option N/A	RPC7230DS009G	4136	"M" Option N/A
66 x 36 x 30	275	RPC6636DS009W	4076	"P" Option N/A	RPC6636DS009G	4076	"M" Option N/A
66 x 30 x 30	250	RPC6630DS009W	3967	"P" Option N/A	RPC6630DS009G	3967	"M" Option N/A
Right Pedestal							
72 x 36 x 30	290	RPC7236DS010W	4178	"P" Option N/A	RPC7236DS010G	4178	"M" Option N/A
72 x 30 x 30	255	RPC7230DS010W	4136	"P" Option N/A	RPC7230DS010G	4136	"M" Option N/A
66 x 36 x 30	275	RPC6636DS010W	4076	"P" Option N/A	RPC6636DS010G	4076	"M" Option N/A
66 x 30 x 30	250	RPC6630DS010W	3967	"P" Option N/A	RPC6630DS010G	3967	"M" Option N/A

Standard Veneer Top Standard Veneer Chassis	Premium Veneer Top Premium Veneer Chassis	High Pressure Laminate Top Veneer Chassis	Thermally Fused Laminate Top Thermally Fused Laminate Chassis
--	--	--	--

2 Select Finish

[Click to view finishes](#)

- WAC
- WIC
- WHC
- WOC
- WEW
- WGW
- WBW
- WSW
- WNW

- GAC
- GIC
- GHC
- GOC
- GEW
- GNW

3 Select Edge

[Click to view edges](#)



4 Select Hardware

[Click to view details](#)



Product Features

- Box/Box/File
- Drawer fronts w/ profile edges
- Full extension drawers - locking
- Full fixed modesty w/ base
- Hookup hardware
- Laminate pull out writing shelf
- Soft close suspension drawer(s)
- Center Drawer Standard

Options

Drawer

- P33: Wood Drawer Upgrade - \$45 per drawer
- P6: Modify Box/Box/File to File/File - \$55 per pedestal
- K28: Articulating Keyboard w/ Mouse pad (removes center drawer) - \$390

Grommets (Standard Location)

- Specify Color and Location Right/Left - \$50 ea.
- Black: TM30-R (Right), TM30-L (Left)
- Silver: TM31-R (Right), TM31-L (Left)
- Antique Brass: TM33-R (Right), TM33-L (Left)

Grommets (Non-Standard Location)

- Provide drawing w/ Grommet Location and Specify Color - \$95 ea.
- Black: TM30-NS
- Silver: TM31-NS
- Antique Brass: TM33-NS

Molding

- DSM1: Delete molding - Deduct \$95

Richmond Park

Workstation Desks

Bowfront / Breakfront Executive Chassis Single Pedestal Desk

[Click here to view statement of line](#)

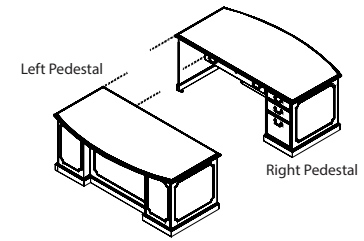

1 Select Model

w" x d" x h"

	Weight	Standard Veneer Top Standard Veneer Chassis	Premium Veneer Top Premium Veneer Chassis	High Pressure Laminate Top Veneer Chassis	Thermally Fused Laminate Top Thermally Fused Laminate Chassis
Left Pedestal					
84 x 36/42 x 30	350	RPC8442DS017W 4923	"P" Option N/A	RPC8442DS017G 4923	"M" Option N/A
72 x 36/42 x 30	315	RPC7242DS017W 4628	"P" Option N/A	RPC7242DS017G 4628	"M" Option N/A
72 x 30/36 x 30	295	RPC7236DS017W 4568	"P" Option N/A	RPC7236DS017G 4568	"M" Option N/A
66 x 36/42 x 30	285	RPC6642DS017W 4525	"P" Option N/A	RPC6642DS017G 4525	"M" Option N/A
66 x 30/36 x 30	275	RPC6636DS017W 4400	"P" Option N/A	RPC6636DS017G 4400	"M" Option N/A
Right Pedestal					
84 x 36/42 x 30	350	RPC8442DS018W 4923	"P" Option N/A	RPC8442DS018G 4923	"M" Option N/A
72 x 36/42 x 30	315	RPC7242DS018W 4628	"P" Option N/A	RPC7242DS018G 4628	"M" Option N/A
72 x 30/36 x 30	295	RPC7236DS018W 4568	"P" Option N/A	RPC7236DS018G 4568	"M" Option N/A
66 x 36/42 x 30	285	RPC6642DS018W 4525	"P" Option N/A	RPC6642DS018G 4525	"M" Option N/A
66 x 30/36 x 30	275	RPC6636DS018W 4400	"P" Option N/A	RPC6636DS018G 4400	"M" Option N/A

2 Select Finish

[Click to view finishes](#)

- WAC
- WIC
- WHC
- WOC
- WEW
- WGW
- WBW
- WSW
- WNW

- GAC
- GIC
- GHC
- GOC
- GEW
- GNW

3 Select Edge

[Click to view edges](#)



4 Select Hardware

[Click to view details](#)



Product Features

- 6" Overhang on approach
- Box/Box/File
- Drawer fronts w/ profile edges
- Full extension drawers - locking
- Full fixed modesty w/ base
- Hookup hardware
- Laminate pull out writing shelf
- Soft close suspension drawer(s)
- Center Drawer Standard

Options

Drawer

- K28: Articulating Keyboard w/ Mouse pad (removes center drawer) - \$390
- P6: Modify Box/Box/File to File/File - \$55 per pedestal
- P33: Wood Drawer Upgrade - \$45 per drawer

Grommets (Standard Location)

- Specify Color and Location Right/Left - \$50 ea.
- Black: TM30-R (Right), TM30-L (Left)
 - Silver: TM31-R (Right), TM31-L (Left)
 - Antique Brass: TM33-R (Right), TM33-L (Left)

Grommets (Non-Standard Location)

- Provide drawing w/ Grommet Location and Specify Color - \$95 ea.
- Black: TM30-NS
 - Silver: TM31-NS
 - Antique Brass: TM33-NS

Molding

- DSM1: Delete molding - Deduct \$95

Richmond Park

Workstation Desks
Bullet Conference Desk

[Click here to view statement of line](#)

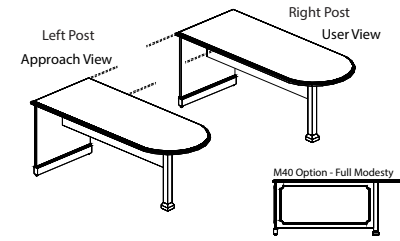

1 Select Model

w" x d" x h"	Weight
72 x 36 x 30	160
72 x 30 x 30	150
66 x 30 x 30	140
60 x 30 x 30	125
Right Post	
72 x 36 x 30	160
72 x 30 x 30	150
66 x 30 x 30	140
60 x 30 x 30	125

Standard Veneer Top Standard Veneer Chassis	Premium Veneer Top Premium Veneer Chassis	High Pressure Laminate Top Veneer Chassis	Thermally Fused Laminate Top Thermally Fused Laminate Chassis
RPC7236DC716W 3289	"P" Option N/A	RPC7236DC716G 3289	"M" Option N/A
RPC7230DC716W 3187	"P" Option N/A	RPC7230DC716G 3187	"M" Option N/A
RPC6630DC716W 3069	"P" Option N/A	RPC6630DC716G 3069	"M" Option N/A
RPC6030DC716W 2976	"P" Option N/A	RPC6030DC716G 2976	"M" Option N/A
RPC7236DC715W 3289	"P" Option N/A	RPC7236DC715G 3289	"M" Option N/A
RPC7230DC715W 3187	"P" Option N/A	RPC7230DC715G 3187	"M" Option N/A
RPC6630DC715W 3069	"P" Option N/A	RPC6630DC715G 3069	"M" Option N/A
RPC6030DC715W 2976	"P" Option N/A	RPC6030DC715G 2976	"M" Option N/A

2 Select Finish

[Click to view finishes](#)

- WAC
- WIC
- WHC
- WOC
- WEW
- WGW
- WBW
- WSW
- WNW

- GAC
- GIC
- GHC
- GOC
- GEW
- GNW

3 Select Edge

[Click to view edges](#)



4 Select Hardware

[Click to view details](#)

Hardware
N/A

Hardware
N/A

Product Features

- 12" Modesty panel standard
- End panel w/ solid hardwood base
- Solid hardwood square post

Notes

- "P" Tops and Bullets are not intended to be freestanding

Options

Accessories

- K28: Articulating Keyboard w/ Mouse pad - \$390
- K30: Traditional Center Drawer - \$205

Grommets (Standard Location)

Specify Color - \$50 ea.

- Black: TM30-C (Center)
- Silver: TM31-C (Center)
- Antique Brass: TM33-C (Center)

Grommets (Non-Standard Location)

Provide drawing w/ Grommet Location and Specify Color - \$95 ea.

- Black: TM30-NS
- Silver: TM31-NS
- Antique Brass: TM33-NS

Modesty

- M40: Fixed Full Modesty - \$205

Richmond Park





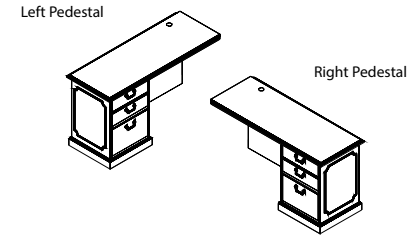

Workstation Returns
Box / Box / File

[Click here to view statement of line](#)



1 Select Model

w" x d" x h"	Weight
60 x 24 x 30	165
54 x 24 x 30	155
48 x 24 x 30	145
42 x 24 x 30	135
Right Pedestal	
60 x 24 x 30	165
54 x 24 x 30	155
48 x 24 x 30	145
42 x 24 x 30	135

Standard Veneer Top Standard Veneer Chassis	Premium Veneer Top Premium Veneer Chassis	High Pressure Laminate Top Veneer Chassis	Thermally Fused Laminate Top Thermally Fused Laminate Chassis
RPC6024RE207W 3161	"P" Option N/A	RPC6024RE207G 3161	"M" Option N/A
RPC5424RE207W 3034	"P" Option N/A	RPC5424RE207G 3034	"M" Option N/A
RPC4824RE207W 2914	"P" Option N/A	RPC4824RE207G 2914	"M" Option N/A
RPC4224RE207W 2849	"P" Option N/A	RPC4224RE207G 2849	"M" Option N/A
RPC6024RE209W 3161	"P" Option N/A	RPC6024RE209G 3161	"M" Option N/A
RPC5424RE209W 3034	"P" Option N/A	RPC5424RE209G 3034	"M" Option N/A
RPC4824RE209W 2914	"P" Option N/A	RPC4824RE209G 2914	"M" Option N/A
RPC4224RE209W 2849	"P" Option N/A	RPC4224RE209G 2849	"M" Option N/A
<p>2 Select Finish</p> <p>Click to view finishes</p> <ul style="list-style-type: none"> WAC WIC WHC WOC WEW WGW WBW WSW WNW 		<p>GAC</p> <p>GIC</p> <p>GHC</p> <p>GOC</p> <p>GEW</p> <p>GNW</p>	
<p>3 Select Edge</p> <p>Click to view edges</p>  <p>Richmond Classic</p>		 <p>Richmond Classic</p>	
<p>4 Select Hardware</p> <p>Click to view details</p>  <p>PL-4 Antique Brass</p>  <p>PL-5 Antique Brass PL-50 Brushed Pewter</p>		 <p>PL-4 Antique Brass</p>  <p>PL-5 Antique Brass PL-50 Brushed Pewter</p>	

Product Features

- 1 Standard grommet - matches pull finish or specify black TM30, silver TM31 or antique brass TM33
- Drawer fronts w/ profile edges
- Full extension drawers - locking
- Full fixed modesty
- Soft close suspension drawer(s)

Options

Accessories

- K28: Articulating Keyboard w/ Mouse pad - \$390

Drawer

- P33: Wood Drawer Upgrade - \$45 per drawer
- P40B: extra Box/Box/File or File/File to Kneespace - \$1,025

Flush Cut

- FC-L: Flush Unit Left (Facing) for Ganging - \$100
- FC-R: Flush Unit Right(Facing) for Ganging - \$100

Grommets (Non-Standard Location)

- Provide drawing w/ Grommet Location and Specify Color - \$95 ea.
- Black: TM30-NS
 - Silver: TM31-NS
 - Antique Brass: TM33-NS

Modesty

- M34T: Drop Door Tech Modesty - \$130
- M51: Open Back Modesty with Wire Mgmt Rail - Deduct \$95

Molding

- DSM2: Delete molding - Deduct \$50

Richmond Park

Workstation Returns
File / File

[Click here to view statement of line](#)

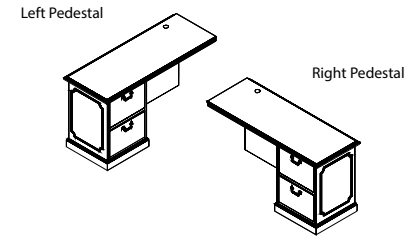

1 Select Model

w" x d" x h"	Weight
60 x 24 x 30	165
54 x 24 x 30	155
48 x 24 x 30	145
42 x 24 x 30	135
Right Pedestal	
60 x 24 x 30	165
54 x 24 x 30	155
48 x 24 x 30	145
42 x 24 x 30	135

Standard Veneer Top Standard Veneer Chassis	Premium Veneer Top Premium Veneer Chassis	High Pressure Laminate Top Veneer Chassis	Thermally Fused Laminate Top Thermally Fused Laminate Chassis
RPC6024RE195W 3161	"P" Option N/A	RPC6024RE195G 3161	"M" Option N/A
RPC5424RE195W 3034	"P" Option N/A	RPC5424RE195G 3034	"M" Option N/A
RPC4824RE195W 2914	"P" Option N/A	RPC4824RE195G 2914	"M" Option N/A
RPC4224RE195W 2849	"P" Option N/A	RPC4224RE195G 2849	"M" Option N/A
RPC6024RE196W 3161	"P" Option N/A	RPC6024RE196G 3161	"M" Option N/A
RPC5424RE196W 3034	"P" Option N/A	RPC5424RE196G 3034	"M" Option N/A
RPC4824RE196W 2914	"P" Option N/A	RPC4824RE196G 2914	"M" Option N/A
RPC4224RE196W 2849	"P" Option N/A	RPC4224RE196G 2849	"M" Option N/A

2 Select Finish

[Click to view finishes](#)

- WAC
- WIC
- WHC
- WOC
- WEW
- WGW
- WBW
- WSW
- WNW

- GAC
- GIC
- GHC
- GOC
- GEW
- GNW

3 Select Edge

[Click to view edges](#)



4 Select Hardware

[Click to view details](#)



Product Features

- 1 Standard grommet - matches pull finish or specify black TM30, silver TM31 or antique brass TM33
- Drawer fronts w/ profile edges
- Full extension drawers - locking
- Full fixed modesty
- Soft close suspension drawer(s)

Options

Accessories

- K28: Articulating Keyboard w/ Mouse pad - \$390

Drawer

- P33: Wood Drawer Upgrade - \$45 per drawer
- P40B: extra Box/Box/File or File/File to Kneespace - \$1,025

Flush Cut

- FC-L: Flush Unit Left (Facing) for Ganging - \$100
- FC-R: Flush Unit Right(Facing) for Ganging - \$100

Grommets (Non-Standard Location)

Provide drawing w/ Grommet Location and Specify Color - \$95 ea.

- Black: TM30-NS
- Silver: TM31-NS
- Antique Brass: TM33-NS

Modesty

- M34T: Drop Door Tech Modesty - \$130
- M51: Open Back Modesty with Wire Mgmt Rail - Deduct \$95

Molding

- DSM2: Delete molding - Deduct \$50

Richmond Park

Workstation Units

Bridge W/ Fixed Full Modesty

[Click here to view statement of line](#)

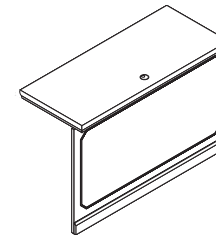

1 Select Model

w" x d" x h"
24" Deep Bridge
54 x 24 x 30
48 x 24 x 30
42 x 24 x 30

Weight

Standard Veneer Top Standard Veneer Chassis		Premium Veneer Top Premium Veneer Chassis		High Pressure Laminate Top Veneer Chassis		Thermally Fused Laminate Top Thermally Fused Laminate Chassis	
--	--	--	--	--	--	--	--

95
90
85

RPC5424BR150W 1485
RPC4824BR150W 1383
RPC4224BR150W 1350

"P" Option N/A
"P" Option N/A
"P" Option N/A

RPC5424BR150G 1485
RPC4824BR150G 1383
RPC4224BR150G 1350

"M" Option N/A
"M" Option N/A
"M" Option N/A

2 Select Finish

[Click to view finishes](#)

WAC
WIC
WHC
WOC
WEW
WGW
WBW
WSW
WNW

GAC
GIC
GHC
GOC
GEW
GNW

3 Select Edge

[Click to view edges](#)



4 Select Hardware

[Click to view details](#)

Hardware
N/A

Hardware
N/A

Product Features

- Full modesty panel with base
- Top cope shaped for flush surface
- Top grommet

Options

Accessories

- K28: Articulating Keyboard w/ Mouse pad - \$390

Grommets (Non-Standard Location)

Provide drawing w/ Grommet Location and Specify Color - \$95 ea.

- Black: TM30-NS
- Silver: TM31-NS
- Antique Brass: TM33-NS

Molding

- DSM2: Delete molding - Deduct \$50

Richmond Park

Credenzas / Files
Storage Credenza

[Click here to view statement of line](#)

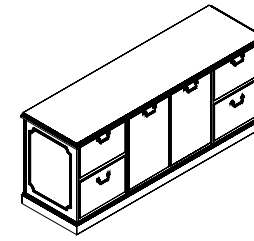

1 Select Model

w" x d" x h"
File/ File
72 x 24 x 30
66 x 24 x 30
Lateral File
95 x 24 x 30
89 x 24 x 30

Weight	Standard Veneer Top Standard Veneer Chassis	Premium Veneer Top Premium Veneer Chassis	High Pressure Laminate Top Veneer Chassis	Thermally Fused Laminate Top Thermally Fused Laminate Chassis
280	RPC7224CA050W 4136	"P" Option N/A	RPC7224CA050G 4136	"M" Option N/A
265	RPC6624CA050W 3967	"P" Option N/A	RPC6624CA050G 3967	"M" Option N/A
350	RPC9524CA651W 7380	"P" Option N/A	RPC9524CA651G 7380	"M" Option N/A
325	RPC8924CA651W 7023	"P" Option N/A	RPC8924CA651G 7023	"M" Option N/A

Product Features

- Black adjustable shelf behind door set
- Drawer fronts w/ profile edges
- File/File
- Full continuous base under cabinets
- "W" & "G" SKUs feature soft close suspensions, "M" SKUs feature ball bearing suspensions. Both suspensions are full extension.

Notes

- Unit has black back panel and is not designed for Open Plan use. Select OPB Option for Open Plan application

Options

Door

- D2: Door Lock - \$100 per door set
- D6A: "W" "G" Styles - Delete Doors and replace black laminate shelf with finished shelf - n/c
- D9SC: Soft Close Door Hinges - \$20 per door

Drawer

- P6: Modify File/File to Box/Box/File - \$55 per pedestal
- P33: Wood Drawer Upgrade - \$45 per drawer

Flush Cut

- FC-B: Flush Unit Both Sides(Facing) for Ganging - \$100
- FC-L: Flush Unit Left (Facing) for Ganging - \$100
- FC-R: Flush Unit Right(Facing) for Ganging - \$100

Grommets (Standard Location)

- Specify Color and Location (Right/Left/Center) - \$50 ea.
- Black: TM30-R (Right), TM30-L (Left), TM30-C (Center)
- Silver: TM31-R (Right), TM31-L (Left), TM31-C (Center)
- Antique Brass: TM33-R (Right), TM33-L (Left), TM33-C (Center)

Grommets (Non-Standard Location)

- Provide drawing w/ Grommet Location and Specify Color - \$95 ea.
- Black: TM30-NS
- Silver: TM31-NS
- Antique Brass: TM33-NS

Molding

- DSM2: Delete molding - Deduct \$50

Open Plan _ Finished Back

- OPB: "W" "G" Style - Modify Unit for Open Plan Application - \$295

Shelves

- S25: Replace Black Laminate Shelf with Finished Shelf - \$80 per shelf

2 Select Finish

[Click to view finishes](#)

WAC
WIC
WHC
WOC
WEW
WGW
WBW
WSW
WNW

GAC
GIC
GHC
GOC
GEW
GNW

3 Select Edge

[Click to view edges](#)



4 Select Hardware

[Click to view details](#)



Richmond Park

Credenzas / Files
Kneespace Credenza

[Click here to view statement of line](#)

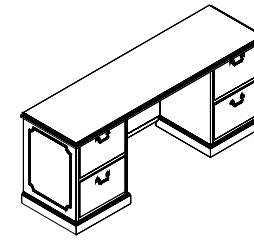

1 Select Model

w" x d" x h"	Weight
72 x 24 x 30	250
66 x 24 x 30	235
60 x 24 x 30	225

Standard Veneer Top Standard Veneer Chassis		Premium Veneer Top Premium Veneer Chassis		High Pressure Laminate Top Veneer Chassis		Thermally Fused Laminate Top Thermally Fused Laminate Chassis	
--	--	--	--	--	--	--	--

RPC7224CA054W	3645	"P" Option N/A		RPC7224CA054G	3645	"M" Option N/A	
RPC6624CA054W	3425	"P" Option N/A		RPC6624CA054G	3425	"M" Option N/A	
RPC6024CA054W	3187	"P" Option N/A		RPC6024CA054G	3187	"M" Option N/A	

Product Features

- Drawer fronts w/ profile edges
- File/File
- Full fixed modesty
- "W" & "G" SKUs feature soft close suspensions, "M" SKUs feature ball bearing suspensions. Both suspensions are full extension.

Notes

- Unit has black back panel and is not designed for Open Plan use. Select OPB Option for Open Plan application

Options

Accessories

- K28: Articulating Keyboard w/ Mouse pad - \$390

Drawer

- P6: Modify File/File to Box/Box/File - \$55 per pedestal
- P33: Wood Drawer Upgrade - \$45 per drawer

Flush Cut

- FC-B: Flush Unit Both Sides(Facing) for Ganging - \$100
- FC-L: Flush Unit Left (Facing) for Ganging - \$100
- FC-R: Flush Unit Right(Facing) for Ganging - \$100

Grommets (Standard Location)

Specify Color - \$50 ea.

- Black: TM30-C (Center)
- Silver: TM31-C (Center)
- Antique Brass: TM33-C (Center)

Grommets (Non-Standard Location)

Provide drawing w/ Grommet Location and Specify Color - \$95 ea.

- Black: TM30-NS
- Silver: TM31-NS
- Antique Brass: TM33-NS

Modesty

- M34T: Drop Door Tech Modesty - \$130
- M51: Open Back Modesty with Wire Mgmt Rail - Deduct \$95

Open Plan _ Finished Back

- OPB: "W" "G" Style - Modify Unit for Open Plan Application - \$295

Molding

- DSM2: Delete molding - Deduct \$50

2 Select Finish

[Click to view finishes](#)

- WAC
- WIC
- WHC
- WOC
- WEW
- WGW
- WBW
- WSW
- WNW

- GAC
- GIC
- GHC
- GOC
- GEW
- GNW

3 Select Edge

[Click to view edges](#)



4 Select Hardware

[Click to view details](#)



Richmond Park

Credenzas
Storage Credenza

[Click here to view statement of line](#)

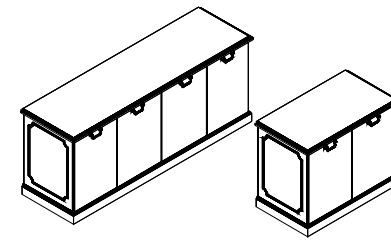

1 Select Model

w" x d" x h"	Weight
72 x 24 x 30	260
60 x 24 x 30	230
37 x 24 x 30	160
31 x 24 x 30	150

Standard Veneer Top Standard Veneer Chassis		Premium Veneer Top Premium Veneer Chassis		High Pressure Laminate Top Veneer Chassis		Thermally Fused Laminate Top Thermally Fused Laminate Chassis	
RPC7224CA125W	4051	"P" Option N/A		RPC7224CA125G	4051	"M" Option N/A	
RPC6024CA125W	3865	"P" Option N/A		RPC6024CA125G	3865	"M" Option N/A	
RPC3724CA125W	2313	"P" Option N/A		RPC3724CA125G	2313	"M" Option N/A	
RPC3124CA125W	2238	"P" Option N/A		RPC3124CA125G	2238	"M" Option N/A	

Product Features

- Black adjustable shelf behind door set
- Door fronts w/ profile edges
- Full continuous base under cabinets

Notes

- Unit has black back panel and is not designed for Open Plan use. Select OPB Option for Open Plan application

Options

Door

- D2: Door Lock - \$100 per door set
- D6A: "W" "G" Styles - Delete Doors and replace black laminate shelf with finished shelf - n/c
- D9SC: Soft Close Door Hinges - \$20 per door

Flush Cut

- FC-B: Flush Unit Both Sides(Facing) for Ganging - \$100
- FC-L: Flush Unit Left (Facing) for Ganging - \$100
- FC-R: Flush Unit Right(Facing) for Ganging - \$100

Grommets (Standard Location)

- Specify Color and Location (Right/Left/Center) - \$50 ea.
- Black: TM30-R (Right), TM30-L (Left), TM30-C (Center)
 - Silver: TM31-R (Right), TM31-L (Left), TM31-C (Center)
 - Antique Brass: TM33-R (Right), TM33-L (Left), TM33-C (Center)

Grommets (Non-Standard Location)

- Provide drawing w/ Grommet Location and Specify Color - \$95 ea.
- Black: TM30-NS
 - Silver: TM31-NS
 - Antique Brass: TM33-NS

Open Plan _ Finished Back

- OPB: "W" "G" Style - Modify Unit for Open Plan Application - \$295

Molding

- DSM2: Delete molding - Deduct \$50

Shelves

- S25: Replace Black Laminate Shelf with Finished Shelf - \$80 per shelf

2 Select Finish

[Click to view finishes](#)

- WAC
- WIC
- WHC
- WOC
- WEW
- WGW
- WBW
- WSW
- WNW

- GAC
- GIC
- GHC
- GOC
- GEW
- GNW

3 Select Edge

[Click to view edges](#)



4 Select Hardware

[Click to view details](#)



Richmond Park

Lateral File Credenzas
Horizontal Lateral File

[Click here to view statement of line](#)

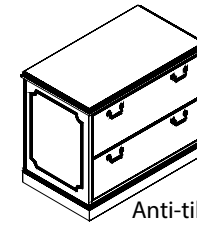

Anti-tilt Safety Drawer Lock

1 Select Model

w" x d" x h"	Weight
4 Drawer	
72 x 24 x 30	300
60 x 24 x 30	275
2 Drawer	
43 x 24 x 30	175
37 x 24 x 30	165
31 x 24 x 30	155

Standard Veneer Top Standard Veneer Chassis	Premium Veneer Top Premium Veneer Chassis	High Pressure Laminate Top Veneer Chassis	Thermally Fused Laminate Top Thermally Fused Laminate Chassis																																								
<table border="1"> <tr> <td>RPC7224CA104W</td> <td>4474</td> </tr> <tr> <td>RPC6024CA104W</td> <td>4188</td> </tr> <tr> <td>RPC4324CA104W</td> <td>2716</td> </tr> <tr> <td>RPC3724CA104W</td> <td>2441</td> </tr> <tr> <td>RPC3124CA104W</td> <td>2358</td> </tr> </table>	RPC7224CA104W	4474	RPC6024CA104W	4188	RPC4324CA104W	2716	RPC3724CA104W	2441	RPC3124CA104W	2358	<table border="1"> <tr> <td>"P" Option N/A</td> <td></td> </tr> <tr> <td>"P" Option N/A</td> <td></td> </tr> <tr> <td>"P" Option N/A</td> <td></td> </tr> <tr> <td>"P" Option N/A</td> <td></td> </tr> <tr> <td>"P" Option N/A</td> <td></td> </tr> </table>	"P" Option N/A		"P" Option N/A		"P" Option N/A		"P" Option N/A		"P" Option N/A		<table border="1"> <tr> <td>RPC7224CA104G</td> <td>4474</td> </tr> <tr> <td>RPC6024CA104G</td> <td>4188</td> </tr> <tr> <td>RPC4324CA104G</td> <td>2716</td> </tr> <tr> <td>RPC3724CA104G</td> <td>2441</td> </tr> <tr> <td>RPC3124CA104G</td> <td>2358</td> </tr> </table>	RPC7224CA104G	4474	RPC6024CA104G	4188	RPC4324CA104G	2716	RPC3724CA104G	2441	RPC3124CA104G	2358	<table border="1"> <tr> <td>"M" Option N/A</td> <td></td> </tr> <tr> <td>"M" Option N/A</td> <td></td> </tr> <tr> <td>"M" Option N/A</td> <td></td> </tr> <tr> <td>"M" Option N/A</td> <td></td> </tr> <tr> <td>"M" Option N/A</td> <td></td> </tr> </table>	"M" Option N/A		"M" Option N/A		"M" Option N/A		"M" Option N/A		"M" Option N/A	
RPC7224CA104W	4474																																										
RPC6024CA104W	4188																																										
RPC4324CA104W	2716																																										
RPC3724CA104W	2441																																										
RPC3124CA104W	2358																																										
"P" Option N/A																																											
"P" Option N/A																																											
"P" Option N/A																																											
"P" Option N/A																																											
"P" Option N/A																																											
RPC7224CA104G	4474																																										
RPC6024CA104G	4188																																										
RPC4324CA104G	2716																																										
RPC3724CA104G	2441																																										
RPC3124CA104G	2358																																										
"M" Option N/A																																											
"M" Option N/A																																											
"M" Option N/A																																											
"M" Option N/A																																											
"M" Option N/A																																											

2 Select Finish

[Click to view finishes](#)

- WAC
- WIC
- WHC
- WOC
- WEW
- WGW
- WBW
- WSW
- WNW

- GAC
- GIC
- GHC
- GOC
- GEW
- GNW

3 Select Edge

[Click to view edges](#)



4 Select Hardware

[Click to view details](#)



Product Features

- Anti-tilt safety drawer lock
- Drawer fronts w/ profile edges
- Legal/Double letter filing
- Features ball bearing suspensions, suspensions are full extension

Notes

- Unit has black back panel and is not designed for Open Plan use. Select OPB Option for Open Plan application

Options

Drawer

- P33: Wood Drawer Upgrade - \$45 per drawer

Flush Cut

- FC-B: Flush Unit Both Sides(Facing) for Ganging - \$100
- FC-L: Flush Unit Left (Facing) for Ganging - \$100
- FC-R: Flush Unit Right(Facing) for Ganging - \$100

Grommets (Standard Location)

Specify Color and Location (Right/Left/Center) - \$50 ea.

- Black: TM30-R (Right), TM30-L (Left), TM30-C (Center)
- Silver: TM31-R (Right), TM31-L (Left), TM31-C (Center)
- Antique Brass: TM33-R (Right), TM33-L (Left), TM33-C (Center)

Grommets (Non-Standard Location)

Provide drawing w/ Grommet Location and Specify Color - \$95 ea.

- Black: TM30-NS
- Silver: TM31-NS
- Antique Brass: TM33-NS

Open Plan _ Finished Back

- OPB: "W" "G" Style - Modify Unit for Open Plan Application - \$295

Molding

- DSM2: Delete molding - Deduct \$50

Richmond Park

Credenzas / Files
Vertical Lateral File

[Click here to view statement of line](#)

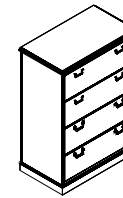

Anti-tilt Safety Drawer Lock

1 Select Model

w" x d" x h"	Weight
43 x 24 x 52	300
37 x 24 x 52	275
31 x 24 x 52	245

Standard Veneer Top Standard Veneer Chassis		Premium Veneer Top Premium Veneer Chassis		High Pressure Laminate Top Veneer Chassis		Thermally Fused Laminate Top Thermally Fused Laminate Chassis	
--	--	--	--	--	--	--	--

RPC4324FI111W	5368	"P" Option N/A		RPC4324FI111G	5368	"M" Option N/A	
RPC3724FI111W	4575	"P" Option N/A		RPC3724FI111G	4575	"M" Option N/A	
RPC3124FI111W	4467	"P" Option N/A		RPC3124FI111G	4467	"M" Option N/A	

Product Features

- Anti-tilt safety drawer lock
- Legal/Double letter filing
- Features ball bearing suspensions, suspensions are full extension

Notes

- Unit has black back panel and is not designed for Open Plan use. Select OPB Option for Open Plan application

Options

Drawer

- P33: Wood Drawer Upgrade - \$45 per drawer

Flush Cut

- FC-B: Flush Unit Both Sides(Facing) for Ganging - \$100
- FC-L: Flush Unit Left (Facing) for Ganging - \$100
- FC-R: Flush Unit Right(Facing) for Ganging - \$100

Open Plan _ Finished Back

- OPB: "W" "G" Style - Modify Unit for Open Plan Application - \$295

2 Select Finish

[Click to view finishes](#)

- WAC
- WIC
- WHC
- WOC
- WEW
- WGW
- WBW
- WSW
- WNW

- GAC
- GIC
- GHC
- GOC
- GEW
- GNW

3 Select Edge

[Click to view edges](#)



Richmond Classic



Richmond Classic

4 Select Hardware

[Click to view details](#)



PL-4 Antique Brass



PL-5 Antique Brass
PL-50 Brushed Pewter



PL-4 Antique Brass



PL-5 Antique Brass
PL-50 Brushed Pewter

Richmond Park

Workstation Credenza
File / File

[Click here to view statement of line](#)

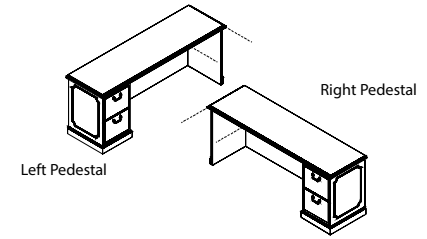

1 Select Model

w" x d" x h"	Weight
89 x 24 x 30	200
72 x 24 x 30	180
66 x 24 x 30	170
89 x 24 x 30	200
72 x 24 x 30	180
66 x 24 x 30	170

Standard Veneer Top Standard Veneer Chassis		Premium Veneer Top Premium Veneer Chassis		High Pressure Laminate Top Veneer Chassis		Thermally Fused Laminate Top Thermally Fused Laminate Chassis	
RPC8924CA086W	3612	"P" Option N/A		RPC8924CA086G	3612	"M" Option N/A	
RPC7224CA086W	3253	"P" Option N/A		RPC7224CA086G	3253	"M" Option N/A	
RPC6624CA086W	3154	"P" Option N/A		RPC6624CA086G	3154	"M" Option N/A	
RPC8924CA087W	3612	"P" Option N/A		RPC8924CA087G	3612	"M" Option N/A	
RPC7224CA087W	3253	"P" Option N/A		RPC7224CA087G	3253	"M" Option N/A	
RPC6624CA087W	3154	"P" Option N/A		RPC6624CA087G	3154	"M" Option N/A	

Product Features

- Drawer fronts w/ profile edges
- File/File
- Full fixed modesty
- Full extension drawers - locking
- Soft close suspension drawer(s)

Notes

- Unit has black back panel and is not designed for Open Plan use. Select OPB Option for Open Plan application

Options

Accessories

- K28: Articulating Keyboard w/ Mouse pad - \$390

Drawer

- P6: Modify File/File to Box/Box/File - \$55 per pedestal
- P33: Wood Drawer Upgrade - \$45 per drawer
- P40B: extra Box/Box/File or File/File to Kneespace - \$1,025

Flush Cut

- FC-B: Flush Unit Both Sides(Facing) for Ganging - \$100
- FC-L: Flush Unit Left (Facing) for Ganging - \$100
- FC-R: Flush Unit Right(Facing) for Ganging - \$100

Grommets (Standard Location)

- Specify Color - \$50 ea.
- Black: TM30-C (Center)
- Silver: TM31-C (Center)
- Antique Brass: TM33-C (Center)

Grommets (Non-Standard Location)

- Provide drawing w/ Grommet Location and Specify Color - \$95 ea.
- Black: TM30-NS
- Silver: TM31-NS
- Antique Brass: TM33-NS

Modesty

- M34T: Drop Door Tech Modesty - \$130
- M51: Open Back Modesty with Wire Mgmt Rail - Deduct \$95

Open Plan _ Finished Back

- OPB: "W" "G" Style - Modify Unit for Open Plan Application - \$295

Molding

- DSM2: Delete molding - Deduct \$50

2 Select Finish

[Click to view finishes](#)

- WAC
- WIC
- WHC
- WOC
- WEW
- WGW
- WBW
- WSW
- WNW

- GAC
- GIC
- GHC
- GOC
- GEW
- GNW

3 Select Edge

[Click to view edges](#)



4 Select Hardware

[Click to view details](#)



Richmond Park

Workstation Credenza
Lateral File

[Click here to view statement of line](#)

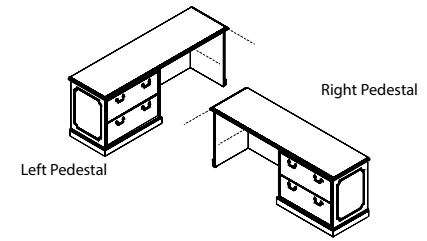

1 Select Model

w" x d" x h"	Weight
95 x 24 x 30	250
89 x 24 x 30	240
72 x 24 x 30	220
66 x 24 x 30	210
95 x 24 x 30	250
89 x 24 x 30	240
72 x 24 x 30	220
66 x 24 x 30	210

Standard Veneer Top Standard Veneer Chassis		Premium Veneer Top Premium Veneer Chassis		High Pressure Laminate Top Veneer Chassis		Thermally Fused Laminate Top Thermally Fused Laminate Chassis	
RPC9524CA066W	4109	"P" Option N/A		RPC9524CA066G	4109	"M" Option N/A	
RPC8924CA066W	3756	"P" Option N/A		RPC8924CA066G	3756	"M" Option N/A	
RPC7224CA066W	3398	"P" Option N/A		RPC7224CA066G	3398	"M" Option N/A	
RPC6624CA066W	3296	"P" Option N/A		RPC6624CA066G	3296	"M" Option N/A	
RPC9524CA067W	4109	"P" Option N/A		RPC9524CA067G	4109	"M" Option N/A	
RPC8924CA067W	3756	"P" Option N/A		RPC8924CA067G	3756	"M" Option N/A	
RPC7224CA067W	3398	"P" Option N/A		RPC7224CA067G	3398	"M" Option N/A	
RPC6624CA067W	3296	"P" Option N/A		RPC6624CA067G	3296	"M" Option N/A	

2 Select Finish

[Click to view finishes](#)

- WAC
- WIC
- WHC
- WOC
- WEW
- WGW
- WBW
- WSW
- WNW

- GAC
- GIC
- GHC
- GOC
- GEW
- GNW

3 Select Edge

[Click to view edges](#)



4 Select Hardware

[Click to view details](#)



Product Features

- Drawer fronts w/ profile edges
- Full fixed modesty
- Features ball bearing suspensions, suspensions are full extension.

Notes

- Keyboard not available on 66" and 72"
- Unit has black back panel and is not designed for Open Plan use. Select OPB Option for Open Plan application

Options

Accessories

- K28: Articulating Keyboard w/ Mouse pad - \$390

Drawer

- P33: Wood Drawer Upgrade - \$45 per drawer
- P40B: extra Box/Box/File or File/File to Kneespace - \$1,025

Flush Cut

- FC-B: Flush Unit Both Sides(Facing) for Ganging - \$100
- FC-L: Flush Unit Left (Facing) for Ganging - \$100
- FC-R: Flush Unit Right(Facing) for Ganging - \$100

Grommets (Standard Location)

Specify Color - \$50 ea.

- Black: TM30-C (Center)
- Silver: TM31-C (Center)
- Antique Brass: TM33-C (Center)

Grommets (Non-Standard Location)

Provide drawing w/ Grommet Location and Specify Color - \$95 ea.

- Black: TM30-NS
- Silver: TM31-NS
- Antique Brass: TM33-NS

Modesty

- M34T: Drop Door Tech Modesty - \$130
- M51: Open Back Modesty with Wire Mgmt Rail - Deduct \$95

Open Plan _ Finished Back

- OPB: "W" "G" Style - Modify Unit for Open Plan Application - \$295

Molding

- DSM2: Delete molding - Deduct \$50

Richmond Park

Overhead Consoles
Freestanding - Panel Door

[Click here to view statement of line](#)

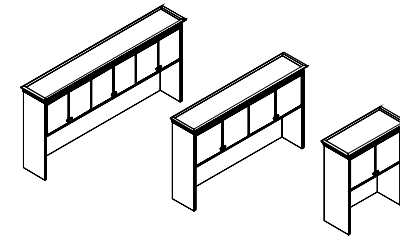

1 Select Model

w" x d" x h"

6 Door / 3 Section

95 x 15 x 44

315

RPC9544OH325W 4985

"P" Option N/A

"G" Option N/A

"M" Option N/A

89 x 15 x 44

285

RPC8944OH325W 4475

"P" Option N/A

"G" Option N/A

"M" Option N/A

4 Door / 2 Section

85 x 15 x 44

275

RPC8544OH325W 4304

"P" Option N/A

"G" Option N/A

"M" Option N/A

78 x 15 x 44

255

RPC7844OH325W 4135

"P" Option N/A

"G" Option N/A

"M" Option N/A

72 x 15 x 44

240

RPC7244OH325W 3795

"P" Option N/A

"G" Option N/A

"M" Option N/A

66 x 15 x 44

225

RPC6644OH325W 3356

"P" Option N/A

"G" Option N/A

"M" Option N/A

60 x 15 x 44

210

RPC6044OH325W 3608

"P" Option N/A

"G" Option N/A

"M" Option N/A

2 Door / 1 Section

37 x 15 x 44

120

RPC3744OH325W 2433

"P" Option N/A

"G" Option N/A

"M" Option N/A

31 x 15 x 44

105

RPC3144OH325W 2402

"P" Option N/A

"G" Option N/A

"M" Option N/A

2 Select Finish

[Click to view finishes](#)

- WAC
- WIC
- WHC
- WOC
- WEW
- WGW
- WBW
- WSW
- WNW

3 Select Edge

[Click to view edges](#)

Edge
N/A

4 Select Hardware

[Click to view details](#)



DK-114 Brushed Pewter

DK-4 Antique Brass

Product Features

- 2.5" Cornice top
- Door fronts w/ profile edges
- Interior cabinet depth 12.5"
- Top profile shaped 3 sides
- 5/8" grommet(s) included for task light wire management

Notes

- Unit has black back panel and is not designed for Open Plan use. Select OPB Option for Open Plan application

Options

Door

- D2: Door Lock - \$100 per door
- D6: Delete Doors - n/c
- D9SC: Soft Close Door Hinges - \$20 per door

Flush Cut

- FC-B: Flush Unit Both Sides(Facing) for Ganging - \$100
- FC-L: Flush Unit Left (Facing) for Ganging - \$100
- FC-R: Flush Unit Right(Facing) for Ganging - \$100

Grommets (Vertical Surface)

- Standard Location - \$50 ea.
- Black Plastic Vertical Surface: TM50-C (Bottom Center)
- Non-Standard Location - \$95 ea.
- Black Plastic Vertical Surface: TM50-NS

Open Plan _ Finished Back

- OPB: "W" "G" Style - Modify Unit for Open Plan Application - \$395

Task Lighting

Overhead task light cord is located on the right facing side. If the opposite location is required please contact customer service.

- LT-LED24: 24" LED Task light - \$215
- LT-LED48: 48" LED Task light - \$270
- LT-LED60: 60" LED Task light - \$335
- LT-LED72: 72" LED Task light - \$360

Overhead tackboard
Full width tackboards

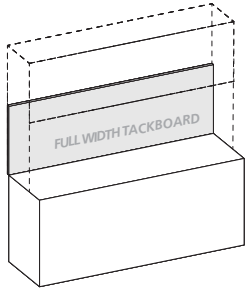

Product Width	Panel Dimension	SKU	COM	1	2	3	4	5	6	7	8	9	10	11/L1	12	13/L2
95	91 x .75 x 21	FTOC9121	379	480	531	582	633	684	735	786	837	888	939	990	1041	1143
89	85 x .75 x 21	FTOC8521	358	449	497	545	593	641	689	737	785	833	881	929	977	1073
85	81 x .75 x 21	FTOC8121	336	428	474	520	566	612	658	704	750	796	842	888	934	1026
78	74 x .75 x 21	FTOC7421	309	392	435	478	521	564	607	650	693	736	779	822	865	951
72	68 x .75 x 21	FTOC6821	282	361	401	441	481	521	561	601	641	681	721	761	801	881
66	62 x .75 x 21	FTOC6221	256	330	366	402	438	474	510	546	582	618	654	690	726	798
60	56 x .75 x 21	FTOC5621	234	299	331	363	395	427	459	491	523	555	587	619	651	715
49	45 x .75 x 21	FTOC4521	187	242	269	296	323	350	377	404	431	458	485	512	539	593
37	33 x .75 x 21	FTOC3321	141	180	200	220	240	260	280	300	320	340	360	380	400	440
31	27 x .75 x 21	FTOC2721	112	149	166	183	200	217	234	251	268	285	302	319	336	370

Standard Features

- Constructed of .5" thick fiberboard
- Fabric is precisely aligned and fitted to the tackboard
- Adhered to the rigid hardboard with staples
- Hung with Z-Strip mounting system

Notes

- Fabric Tack Panels are raised 3" from bottom edge when TM50 grommet is ordered

Overhead tackboard
Half width tackboards

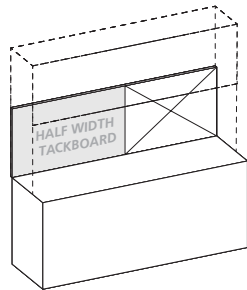

95 Half Width	45.5 x .75 x 21	FTOC4521	189	240	266	292	318	344	370	396	422	448	474	500	526	578
89 Half Width	42.5 x .75 x 21	FTOC4221	179	225	249	273	297	321	345	369	393	417	441	465	489	537
85 Half Width	40.5 x .75 x 21	FTOC4021	168	214	237	260	283	306	329	352	375	398	421	444	467	513
78 Half Width	37 x .75 x 21	FTOC3721	155	196	217	238	259	280	301	322	343	364	385	406	427	469
72 Half Width	34 x .75 x 21	FTOC3421	141	180	200	220	240	260	280	300	320	340	360	380	400	440
66 Half Width	31 x .75 x 21	FTOC3121	128	165	183	201	219	237	255	273	291	309	327	345	363	399

Standard Features

- Constructed of .5" thick fiberboard
- Fabric is precisely aligned and fitted to the tackboard
- Adhered to the rigid hardboard with staples
- Hung with Z-Strip mounting system

Notes

- Half width tackboards can be specified and combined with a Veneer Panel, Marker Board, Slat Wall or Glass Board. See "Half Width" items under product width.
- Specify right or left facing tackboard
- Fabric Tack Panels are raised 3" from bottom edge when TM50 grommet is ordered.

Overhead dry marker board
Full width dry marker board

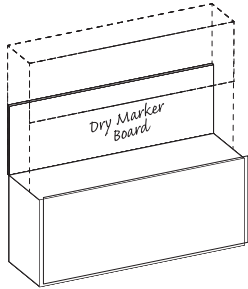

Product Width	Panel Dimension	SKU	List
95	91 x .5 x 21	DMOC9121	1136
89	85 x .5 x 21	DMOC8521	1061
85	81 x .5 x 21	DMOC8121	1011
78	74 x .5 x 21	DMOC7421	924
72	68 x .5 x 21	DMOC6821	849
66	62 x .5 x 21	DMOC6221	774
60	56 x .5 x 21	DMOC5621	699
49	45 x .5 x 21	DMOC4521	587
37	33 x .5 x 21	DMOC3321	437
31	27 x .5 x 21	DMOC2721	337

Standard Features

- Dry marker panel has edge trim molding
- Standard magnetic surface
- Hung with Z-Strip mounting system

Overhead dry marker board
Half width dry marker board

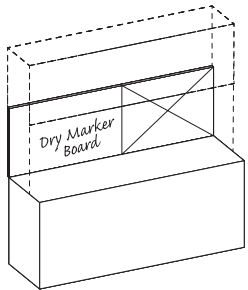

Product Width	Panel Dimension	SKU	List
95 Half Width	45.5 x .5 x 21	DMOC4521	555
89 Half Width	42.5 x .5 x 21	DMOC4221	518
85 Half Width	40.5 x .5 x 21	DMOC4021	493
78 Half Width	37 x .5 x 21	DMOC3721	449
72 Half Width	34 x .5 x 21	DMOC3421	437
66 Half Width	31 x .5 x 21	DMOC3121	374

Standard Features

- Dry marker panel has edge trim molding
- Standard magnetic surface
- Hung with Z-Strip mounting system

Notes

- Half width dry marker boards can be specified and combined with a Tackboard, Veneer Panel, Slat Wall or Glass Board. See "Half Width" items under product width.
- Specify right or left facing dry marker board

Overhead glassboard
Full width glassboards

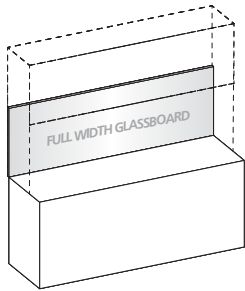

Product Width	Panel Dimension	SKU	List
95	91 x .5 x 21	GBOC9121	2382
89	85 x .5 x 21	GBOC8521	2236
85	81 x .5 x 21	GBOC8121	2138
78	74 x .5 x 21	GBOC7421	1969
72	68 x .5 x 21	GBOC6821	1822
66	62 x .5 x 21	GBOC6221	1676
60	56 x .5 x 21	GBOC5621	1531
49	45 x .5 x 21	GBOC4521	1264
37	33 x .5 x 21	GBOC3321	972
31	27 x .5 x 21	GBOC2721	826

Standard Features

- 4 mm tempered glass

Notes

- Earth magnets are required to hold items securely in place
- Hung with Z-Strip mounting system
- Use glass cleaner or alcohol to clean
- Standard dry erase markers may be used

Overhead glassboard
Half width glassboards

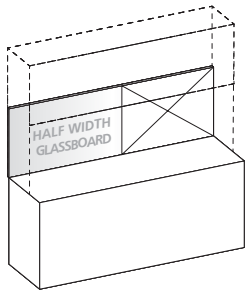

Product Width	Panel Dimension	SKU	List
95 Half Width	45.5 x .5 x 21	GBOC4521	1251
89 Half Width	42.5 x .5 x 21	GBOC4221	1178
85 Half Width	40.5 x .5 x 21	GBOC4021	1129
78 Half Width	37 x .5 x 21	GBOC3721	985
72 Half Width	34 x .5 x 21	GBOC3421	972
66 Half Width	31 x .5 x 21	GBOC3121	899

Standard Features

- 4 mm tempered glass
- Hung with Z-Strip mounting system

Notes

- Half width glassboards can be specified and combined with a Tackboard, Veneer panel, Marker Board or Slat Wall. See "Half Width" items under product width.
- Must specify Right or left facing glassboard
- Use glass cleaner or alcohol to clean
- Standard dry erase markers may be used
- Earth magnets are required to hold items securely in place

Overhead slat wall
Half width slat wall

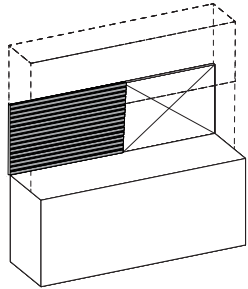

Product Width	Panel Dimension	SKU	List
95 Half Width	45.5 x .5 x 21	SWOC4521	463
89 Half Width	42.5 x .5 x 21	SWOC4221	432
85 Half Width	40.5 x .5 x 21	SWOC4021	411
78 Half Width	37 x .5 x 21	SWOC3721	374
72 Half Width	34 x .5 x 21	SWOC3421	343
66 Half Width	31 x .5 x 21	SWOC3121	312

Standard Features

- Available in silver or black
- Hung with Z-Strip mounting system

Notes

- Half width slat walls can be specified and combined with a Tackboard, Veneer panel, Marker Board or Glassboard. See "Half Width" items under product width.
- Specify right or left facing slat wall
- For use on 42"/43" height consoles
- Specify right or left facing slat wall

Richmond Park

Wall Hung Overheads
Panel Doors

[Click here to view statement of line](#)

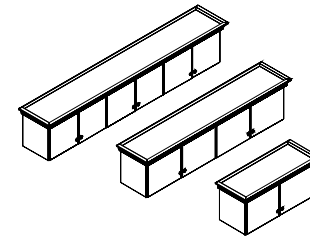

1 Select Model

w" x d" x h"	Weight
6 Door / 3 Section	
95 x 15 x 20	200
89 x 15 x 20	185
4 Door / 2 Section	
85 x 15 x 20	175
78 x 15 x 20	165
72 x 15 x 20	155
66 x 15 x 20	140
60 x 15 x 20	130
49 x 15 x 20	115
2 Door	
37 x 15 x 20	75
31 x 15 x 20	65

	Standard Veneer Top Standard Veneer Chassis	Premium Veneer Top Premium Veneer Chassis	High Pressure Laminate Top Veneer Chassis	Thermally Fused Laminate Top Thermally Fused Laminate Chassis
RPC9520WH330W 4901		"P" Option N/A	"G" Option N/A	"M" Option N/A
RPC8920WH330W 4730		"P" Option N/A	"G" Option N/A	"M" Option N/A
RPC8520WH330W 4180		"P" Option N/A	"G" Option N/A	"M" Option N/A
RPC7820WH330W 4006		"P" Option N/A	"G" Option N/A	"M" Option N/A
RPC7220WH330W 3837		"P" Option N/A	"G" Option N/A	"M" Option N/A
RPC6620WH330W 3595		"P" Option N/A	"G" Option N/A	"M" Option N/A
RPC6020WH330W 3279		"P" Option N/A	"G" Option N/A	"M" Option N/A
RPC4920WH330W 2906		"P" Option N/A	"G" Option N/A	"M" Option N/A
RPC3720WH330W 2243		"P" Option N/A	"G" Option N/A	"M" Option N/A
RPC3120WH330W 2201		"P" Option N/A	"G" Option N/A	"M" Option N/A

2 Select Finish

[Click to view finishes](#)

- WAC
- WIC
- WHC
- WOC
- WEW
- WGW
- WBW
- WSW
- WNW

3 Select Edge

[Click to view edges](#)

Edge
N/A

4 Select Hardware

[Click to view details](#)



Product Features

- 2.5" Cornice top
- Door fronts w/ profile edges
- Interior cabinet depth 12"
- Mounting wall rail included
- Top profile shaped 3 sides

Notes

- The DARRAN wall mounted cabinet(or shelf) must be hung on a weight-bearing wall. The suitability of the wall supporting the wall mounted cabinet, and the installation and maintenance of the wall-mounted cabinet, is the sole responsibility of the customer. Failure to correctly install and/or exceed the loaded weight capacity of this product may cause it to fall, resulting in damage to the product, adjacent property and/or bodily injury.

Options

Door

- D2: Door Lock - \$100 per door
- D6: Delete Doors - n/c
- D9SC: Soft Close Door Hinges - \$20 per door

Flush Cut

- FC-B: Flush Unit Both Sides(Facing) for Ganging - \$100
- FC-L: Flush Unit Left (Facing) for Ganging - \$100
- FC-R: Flush Unit Right(Facing) for Ganging - \$100

Task Lighting

Overhead task light cord is located on the right facing side. If the opposite location is required please contact customer service.

- LT-LED24: 24" LED Task light - \$215
- LT-LED48: 48" LED Task light - \$270
- LT-LED60: 60" LED Task light - \$335
- LT-LED72: 72" LED Task light - \$360

Wall hung tackboards
Full width tackboards

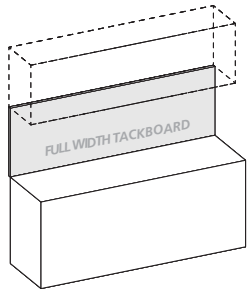

Product Width	Panel Dimension	SKU	COM	1	2	3	4	5	6	7	8	9	10	11/L1	12	13/L2
95	93 x .75 x 24	FTWH9324	465	576	627	678	729	780	831	882	933	984	1035	1086	1137	1239
89	87 x .75 x 24	FTWH8724	448	539	587	635	683	731	779	827	875	923	971	1019	1067	1163
85	83 x .75 x 24	FTWH8324	422	514	560	606	652	698	744	790	836	882	928	974	1020	1112
78	76 x .75 x 24	FTWH7624	388	471	514	557	600	643	686	729	772	815	858	901	944	1030
72	70 x .75 x 24	FTWH7024	355	434	474	514	554	594	634	674	714	754	794	834	874	954
66	64 x .75 x 24	FTWH6424	322	396	432	468	504	540	576	612	648	684	720	756	792	864
60	58 x .75 x 24	FTWH5824	294	359	391	423	455	487	519	551	583	615	647	679	711	775
49	47 x .75 x 24	FTWH4724	236	291	318	345	372	399	426	453	480	507	534	561	588	642
37	35 x .75 x 24	FTWH3524	176	217	237	257	277	297	317	337	357	377	397	417	437	477
31	29 x .75 x 24	FTWH2924	142	179	196	213	230	247	264	281	298	315	332	349	366	400

Standard Features

- Constructed of .5" thick fiberboard
- Fabric is precisely aligned and fitted to the tackboard
- Adhered to the rigid hardboard with staples

- Hung with Z-Strip mounting system

Wall hung tackboards
Half width tackboards

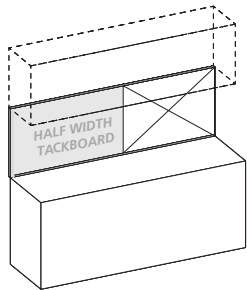

Product Width	Panel Dimension	SKU	COM	1	2	3	4	5	6	7	8	9	10	11/L1	12	13/L2
95 Half Width	46.5 x .75 x 24	FTWH4624	233	288	313	338	363	388	413	438	463	488	513	538	563	613
89 Half Width	43.5 x .75 x 24	FTWH4324	225	270	294	318	342	366	390	414	438	462	486	510	534	582
85 Half Width	41.5 x .75 x 24	FTWH4124	211	257	280	303	326	349	372	395	418	441	464	487	510	556
78 Half Width	38 x .75 x 24	FTWH3824	194	235	256	277	298	319	340	361	382	403	424	445	466	508
72 Half Width	35 x .75 x 24	FTWH3524	178	217	237	257	277	297	317	337	357	377	397	417	437	477
66 Half Width	32 x .75 x 24	FTWH3224	161	198	216	234	252	270	288	306	324	342	360	378	396	432

Standard Features

- Constructed of .5" thick fiberboard
- Fabric is precisely aligned and fitted to the tackboard
- Adhered to the rigid hardboard with staples
- Hung with Z-Strip mounting system

Notes

- Half width tackboards can be specified and combined with a Veneer Panel, Marker Board, Slat Wall or Glass Board. See "Half Width" items under product width.
- Specify right or left facing tackboard

Wall hung dry marker board
Full width dry marker board

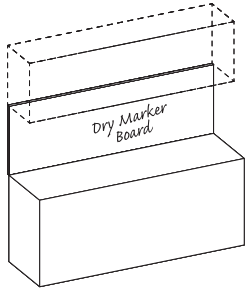

Product Width	Panel Dimension	SKU	List
95	93 x .75 x 24	DMWH9324	1161
89	87 x .75 x 24	DMWH8724	1086
85	83 x .75 x 24	DMWH8324	1023
78	76 x .5 x 24	DMWH7624	948
72	70 x .75 x 24	DMWH7024	874
66	64 x .75 x 24	DMWH6424	799
60	58 x .75 x 24	DMWH5824	724
49	47 x .75 x 24	DMWH4724	587
37	35 x .75 x 24	DMWH3524	437
31	29 x .75 x 24	DMWH2924	362

Standard Features

- Dry marker panel has edge trim molding
- Standard magnetic surface
- Hung with Z-Strip mounting system

Wall hung dry marker board
Half width dry marker board

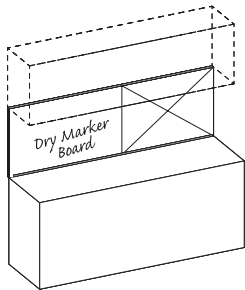

Product Width	Panel Dimension	SKU	List
95 Half Width	46.5 x .75 x 24	DMWH4624	580
89 Half Width	43.5 x .75 x 24	DMWH4324	543
85 Half Width	41.5 x .75 x 24	DMWH4124	518
78 Half Width	38 x .75 x 24	DMWH3824	474
72 Half Width	35 x .75 x 24	DMWH3524	437
66 Half Width	32 x .75 x 24	DMWH3224	399

Standard Features

- Dry marker panel has edge trim molding
- Standard magnetic surface
- Hung with Z-Strip mounting system

Notes

- Half width dry marker boards can be specified and combined with a Tackboard, Veneer Panel, Slat Wall or Glass Board. See "Half Width" items under product width.
- Specify right or left facing dry marker board

Wall hung veneer panel
Full width veneer panel

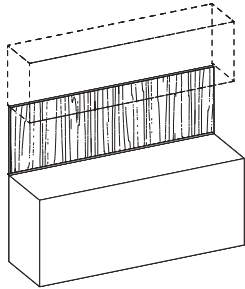

Product Width	Panel Dimension	SKU	List
95	93 x .75 x 24	VPWH9324	967
89	87 x .75 x 24	VPWH8724	905
85	83 x .75 x 24	VPWH8324	853
78	76 x .75 x 24	VPWH7624	790
72	70 x .75 x 24	VPWH7024	728
66	64 x .75 x 24	VPWH6424	666
60	58 x .75 x 24	VPWH5824	603
49	47 x .75 x 24	VPWH4724	489
37	35 x .75 x 24	VPWH3524	364
31	29 x .75 x 24	VPWH2924	302

Standard Features

- Veneer edges

Notes

- Vertical wire channels on back for task light cords
- Steel mounting wall channel is recessed for flush mounting
- Hung with Z-Strip mounting system
- Can be used with or without overhead cabinet
- Required for other accessory panels

Wall hung veneer panel
Half width veneer panel

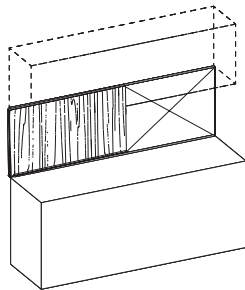

Product Width	Panel Dimension	SKU	List
95 Half Width	46.5 x .75 x 24	VPWH4624	484
89 Half Width	43.5 x .75 x 24	VPWH4324	452
85 Half Width	41.5 x .75 x 24	VPWH4124	432
78 Half Width	38 x .75 x 24	VPWH3824	395
72 Half Width	35 x .75 x 24	VPWH3524	364
66 Half Width	32 x .75 x 24	VPWH3224	333

Standard Features

- Veneer edges
- Vertical wire channels on back for task light cords
- Steel mounting wall channel is recessed for flush mounting
- Hung with Z-Strip mounting system

Notes

- Half width veneer panels can be specified and combined with a Tackboard, Marker Board, Slat Wall or Glass Board. See "Half Width" items under product width.
- Specify right or left facing veneer panel
- Can be used with or without overhead cabinet
- Required for other accessory panels

Wall hung glassboard
Full width glassboards

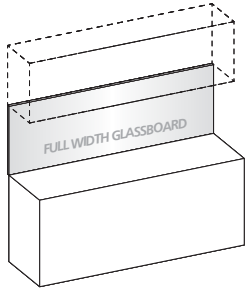

Product Width	Panel Dimension	SKU	List
95	93 x .75 x 24	GBWH9324	2753
89	87 x .75 x 24	GBWH8724	2586
85	83 x .75 x 24	GBWH8324	2475
78	76 x .75 x 24	GBWH7624	2281
72	70 x .75 x 24	GBWH7024	2114
66	64 x .75 x 24	GBWH6424	1948
60	58 x .75 x 24	GBWH5824	1780
49	47 x .75 x 24	GBWH4724	1476
37	35 x .75 x 24	GBWH3524	1142
31	29 x .75 x 24	GBWH2924	976

Standard Features

- 4 mm tempered glass

Notes

- Use glass cleaner or alcohol to clean
- Standard dry erase markers may be used
- Earth magnets are required to hold items securely in place
- Hung with Z-Strip mounting system

Wall hung glassboard
Half width glassboards

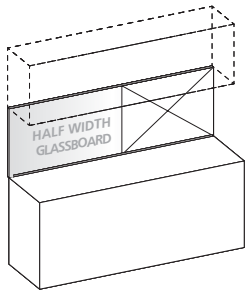

Product Width	Panel Dimension	SKU	List
95 Half Width	46.5 x .75 x 24	GBWH4624	1461
89 Half Width	43.5 x .75 x 24	GBWH4324	1378
85 Half Width	41.5 x .75 x 24	GBWH4124	1323
78 Half Width	38 x .75 x 24	GBWH3824	1232
72 Half Width	35 x .75 x 24	GBWH3524	1142
66 Half Width	32 x .75 x 24	GBWH3224	1059

Standard Features

- 4 mm tempered glass
- Hung with Z-Strip mounting system

Notes

- Half width glassboards can be specified and combined with a Tackboard, Veneer panel, Marker Board or Slat Wall. See "Half Width" items under product width.
- Specify right or left facing glassboard
- Use glass cleaner or alcohol to clean
- Standard dry erase markers may be used
- Earth magnets are required to hold items securely in place

Wall hung slat wall
Half width slat wall

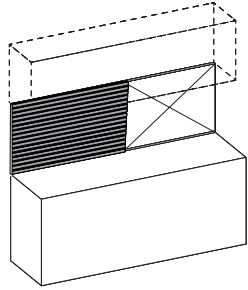

Product Width	Panel Dimension	SKU	List
95 Half Width	46.5 x .75 x 24	SWWH4624	484
89 Half Width	43.5 x .75 x 24	SWWH4324	452
85 Half Width	41.5 x .75 x 24	SWWH4124	432
78 Half Width	38 x .75 x 24	SWWH3824	395
72 Half Width	35 x .75 x 24	SWWH3524	364
66 Half Width	32 x .75 x 24	SWWH3224	333

Standard Features

- Available in silver or black
- Hung with Z-Strip mounting system

Notes

- Half width slat walls can be specified and combined with a Tackboard, Veneer panel, Marker Board or Glassboard. See "Half Width" items under product width.
- Specify right or left facing slat wall
- For use on 42"/43" height consoles

Richmond Park

Assembled Overhead Bookcase / Hutch
Panel Door

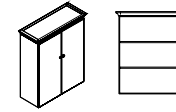

[Click here to view statement of line](#)

1 Select Model

w" x d" x h"	Weight
37 x 15 x 44.5	140
31 x 15 x 44.5	130

Standard Veneer Top Standard Veneer Chassis		Premium Veneer Top Premium Veneer Chassis	High Pressure Laminate Top Veneer Chassis	Thermally Fused Laminate Top Thermally Fused Laminate Chassis
RPC3744OH383W	2732	"P" Option N/A	"G" Option N/A	"M" Option N/A
RPC3144OH383W	2610	"P" Option N/A	"G" Option N/A	"M" Option N/A

Product Features

- 2 Adjustable shelves
- 2.5" Cornice top
- Doors w/ profile edges
- Interior shelf depth 12"
- Top profile shaped 3 sides

Notes

- Unit has black back panel and is not designed for Open Plan use. Select OPB Option for Open Plan application

Options

Door

- D2: Door Lock - \$100 per door
- D6: Delete Doors - n/c
- D9SC: Soft Close Door Hinges - \$20 per door

Flush Cut

- FC-B: Flush Unit Both Sides(Facing) for Ganging - \$100
- FC-L: Flush Unit Left (Facing) for Ganging - \$100
- FC-R: Flush Unit Right(Facing) for Ganging - \$100

Open Plan _ Finished Back

- OPB: "W" "G" Style - Modify Unit for Open Plan Application - \$395

Shelf

- GS14F: Replace Standard Shelves with Glass Shelves - \$90 per shelf
- S714F: Heavy Duty Lumber 1" Shelves - \$80 per shelf

2 Select Finish

[Click to view finishes](#)

- WAC
- WIC
- WHC
- WOC
- WEW
- WGW
- WBW
- WSW
- WNW

3 Select Edge

[Click to view edges](#)

Edge
N/A

4 Select Hardware

[Click to view details](#)



Richmond Park

Assembled Overhead Bookcase / Hutch
Wood Frame Door W/ beveled glass Insert

[Click here to view statement of line](#)

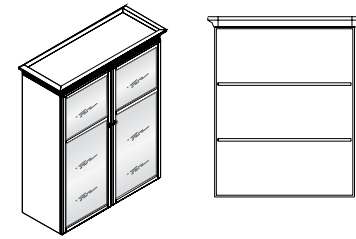

1 Select Model

w" x d" x h"	Weight
37 x 15 x 44.5	140
31 x 15 x 44.5	130

Standard Veneer Top Standard Veneer Chassis		Premium Veneer Top Premium Veneer Chassis	High Pressure Laminate Top Veneer Chassis	Thermally Fused Laminate Top Thermally Fused Laminate Chassis
RPC3744OH381W	3252	"P" Option N/A	"G" Option N/A	"M" Option N/A
RPC3144OH381W	3129	"P" Option N/A	"G" Option N/A	"M" Option N/A

Product Features

- 2 Adjustable shelves
- 2.5" Cornice top
- Doors w/ profile edges
- Interior shelf depth 12"
- Top profile shaped 3 sides
- Wood frame doors w/ beveled glass inserts

Notes

- Unit has black back panel and is not designed for Open Plan use. Select OPB Option for Open Plan application

Options

Door

- D2-G: Door Lock for Glass doors - \$205 per door
- D9SC: Soft Close Door Hinges - \$20 per door

Flush Cut

- FC-B: Flush Unit Both Sides(Facing) for Ganging - \$100
- FC-L: Flush Unit Left (Facing) for Ganging - \$100
- FC-R: Flush Unit Right(Facing) for Ganging - \$100

Interior Cabinet Lighting

- LEDPK starter kit includes Infeed, 1 Puck Interior Light and the ability to daisy chain up to 6 total Puck Lights
- LEDPK: LED Puck Starter Kit - \$310
- PK: 1 LED Interior Light - \$130

Open Plan _ Finished Back

- OPB: "W" "G" Style - Modify Unit for Open Plan Application - \$395

Shelf

- GS14F: Replace Standard Shelves with Glass Shelves - \$90 per shelf
- S714F: Heavy Duty Lumber 1" Shelves - \$80 per shelf

2 Select Finish

[Click to view finishes](#)

- WAC
- WIC
- WHC
- WOC
- WEW
- WGW
- WBW
- WSW
- WNW

3 Select Edge

[Click to view edges](#)

Edge
N/A

4 Select Hardware

[Click to view details](#)



Richmond Park

Vertical Half Towers
Wardrobe / Storage

[Click here to view statement of line](#)

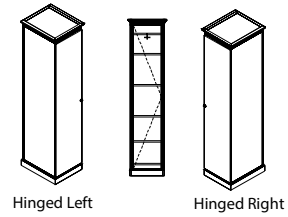

1 Select Model

w" x d" x h"
Hinged Left
17.75 x 24 x 77
Hinged Right
17.75 x 24 x 77

Weight	Standard Veneer Top Standard Veneer Chassis	Premium Veneer Top Premium Veneer Chassis	High Pressure Laminate Top Veneer Chassis	Thermally Fused Laminate Top Thermally Fused Laminate Chassis
--------	--	--	--	--

160
160

RPC1777TW283W 3697
RPC1777TW284W 3697

"P" Option N/A
"P" Option N/A

"G" Option N/A
"G" Option N/A

"M" Option N/A
"M" Option N/A

2 Select Finish

[Click to view finishes](#)

- WAC
- WIC
- WHC
- WOC
- WEW
- WGW
- WBW
- WSW
- WNW

3 Select Edge

[Click to view edges](#)

Edge
N/A

4 Select Hardware

[Click to view details](#)



Product Features

- 2.5" Cornice top
- 3 Adjustable shelves / 1 Fixed
- 3.5" Traditional base
- Door fronts w/ profile edges
- Top profile shaped 3 sides
- Wardrobe w/ coat rod & hook

Notes

- Unit has black back panel and is not designed for Open Plan use. Select OPB Option for Open Plan application

Options

Door

- D2: Door Lock - \$100 per door
- D9SC: Soft Close Door Hinges - \$20 per door

Flush Cut

- FC-B: Flush Unit Both Sides(Facing) for Ganging - \$100
- FC-L: Flush Unit Left (Facing) for Ganging - \$100
- FC-R: Flush Unit Right(Facing) for Ganging - \$100

Open Plan _ Finished Back

- OPB: "W" "G" Style - Modify Unit for Open Plan Application - \$395

Richmond Park

Vertical Half Towers
Storage / File/File With Mini-Wardrobe

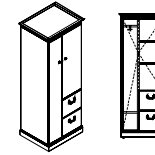

[Click here to view statement of line](#)

1 Select Model

w" x d" x h"
Left Wardrobe
28 x 24 x 77
Right Wardrobe
28 x 24 x 77

Weight	Standard Veneer Top Standard Veneer Chassis	Premium Veneer Top Premium Veneer Chassis	High Pressure Laminate Top Veneer Chassis	Thermally Fused Laminate Top Thermally Fused Laminate Chassis
--------	--	--	--	--

220	RPC2877TW293W 5739	"P" Option N/A	"G" Option N/A	"M" Option N/A
220	RPC2877TW294W 5739	"P" Option N/A	"G" Option N/A	"M" Option N/A

2 Select Finish

[Click to view finishes](#)

- WAC
- WIC
- WHC
- WOC
- WEW
- WGW
- WBW
- WSW
- WNW

3 Select Edge

[Click to view edges](#)

Edge
N/A

4 Select Hardware

[Click to view details](#)



Product Features

- 2 Adjustable shelves
- 2.5" Cornice top
- 3.5" Traditional base
- Door/Drawer fronts w/ profile edges
- Full extension drawers - locking
- Soft close suspension drawer(s)
- Top profile shaped 3 sides

Notes

- Unit has black back panel and is not designed for Open Plan use. Select OPB Option for Open Plan application

Options

Door

- D2: Door Lock - \$100 per door
- D9SC: Soft Close Door Hinges - \$20 per door

Drawer

- P6: Modify File/File to Box/Box/File - \$55 per pedestal
- P33: Wood Drawer Upgrade - \$45 per drawer

Flush Cut

- FC-B: Flush Unit Both Sides(Facing) for Ganging - \$100
- FC-L: Flush Unit Left (Facing) for Ganging - \$100
- FC-R: Flush Unit Right(Facing) for Ganging - \$100

Open Plan _ Finished Back

- OPB: "W" "G" Style - Modify Unit for Open Plan Application - \$395

Richmond Park

Vertical Full Towers
Freestanding Wardrobe / Storage

[Click here to view statement of line](#)

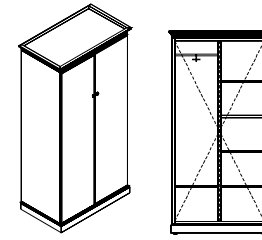

1 Select Model

w" x d" x h"	Weight
38.5 x 24 x 77	260
32.5 x 24 x 77	210

Standard Veneer Top Standard Veneer Chassis		Premium Veneer Top Premium Veneer Chassis	High Pressure Laminate Top Veneer Chassis	Thermally Fused Laminate Top Thermally Fused Laminate Chassis
RPC3877TW275W	5488	"P" Option N/A	"G" Option N/A	"M" Option N/A
RPC3277TW275W	5146	"P" Option N/A	"G" Option N/A	"M" Option N/A

Product Features

- 2.5" Cornice top
- 3 Adjustable shelves
- 3.5" Traditional base
- Doors w/ profile edges
- Top profile shaped 3 sides
- Wardrobe w/ coat rod & hook

Notes

- Pulls are located 26" from the top of the door and 1-5/8" from the edge.
- Unit has black back panel and is not designed for Open Plan use. Select OPB Option for Open Plan application

Options

Delete Center Partition

- MOD31OP: Delete Center Partition / Add (3) Full Width Adj. Shelves & (1) Fixed - \$295

Door

- D2: Door Lock - \$100 per door
- D9SC: Soft Close Door Hinges - \$20 per door

Flush Cut

- FC-B: Flush Unit Both Sides(Facing) for Ganging - \$100
- FC-L: Flush Unit Left (Facing) for Ganging - \$100
- FC-R: Flush Unit Right(Facing) for Ganging - \$100

Open Plan _ Finished Back

- OPB: "W" "G" Style - Modify Unit for Open Plan Application - \$395

2 Select Finish

[Click to view finishes](#)

- WAC
- WIC
- WHC
- WOC
- WEW
- WGW
- WBW
- WSW
- WNW

3 Select Edge

[Click to view edges](#)

- Edge
- N/A

4 Select Hardware

[Click to view details](#)



Richmond Park

Vertical Full Towers
Freestanding Lateral File / Storage

[Click here to view statement of line](#)

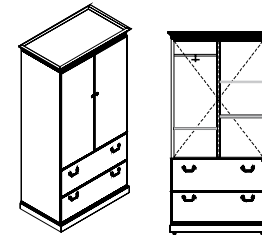

1 Select Model

w" x d" x h"	Weight
38.5 x 24 x 77	280
32.5 x 24 x 77	220

Standard Veneer Top Standard Veneer Chassis	Premium Veneer Top Premium Veneer Chassis	High Pressure Laminate Top Veneer Chassis	Thermally Fused Laminate Top Thermally Fused Laminate Chassis
RPC3877TW281W 5829 RPC3277TW281W 5488	"P" Option N/A "P" Option N/A	"G" Option N/A "G" Option N/A	"M" Option N/A "M" Option N/A

Product Features

- 2.5" Cornice top
- 3 Adjustable shelves
- 3.5" Traditional base
- Door/Drawer fronts w/ profile edges
- Legal/Double letter filing
- Features ball bearing suspensions, suspensions are full extension
- Top profile shaped 3 sides
- Wardrobe w/ coat rod & hook

Notes

- Unit has black back panel and is not designed for Open Plan use. Select OPB Option for Open Plan application

Options

Delete Center Partition

- MOD30OP: Delete Center Partition / Add 3 Full Width Adj. Shelves & Fixed - \$295

Door

- D2: Door Lock - \$100 per door
- D9SC: Soft Close Door Hinges - \$20 per door

Drawer

- P33: Wood Drawer Upgrade - \$45 per drawer

Flush Cut

- FC-B: Flush Unit Both Sides(Facing) for Ganging - \$100
- FC-L: Flush Unit Left (Facing) for Ganging - \$100
- FC-R: Flush Unit Right(Facing) for Ganging - \$100

Open Plan _ Finished Back

- OPB: "W" "G" Style - Modify Unit for Open Plan Application - \$395

2 Select Finish

[Click to view finishes](#)

- WAC
- WIC
- WHC
- WOC
- WEW
- WGW
- WBW
- WSW
- WNW

3 Select Edge

[Click to view edges](#)

Edge
N/A

4 Select Hardware

[Click to view details](#)



Richmond Park

Assembled Bookcases
Open Bookcase

[Click here to view statement of line](#)

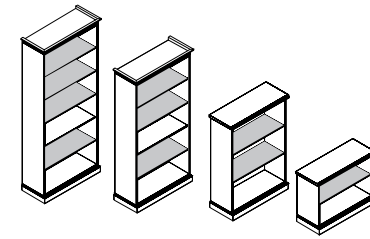

1 Select Model

w" x d" x h"	Weight
Cornice Top and Base	
37 x 16 x 86	205
37 x 16 x 74	185
31 x 16 x 86	200
31 x 16 x 74	180
Veneer Top and Base	
37 x 15 x 53	205
37 x 15 x 31.75	185
31 x 15 x 53	200
31 x 15 x 31.75	180

	Standard Veneer Top Standard Veneer Chassis	Premium Veneer Top Premium Veneer Chassis	High Pressure Laminate Top Veneer Chassis	Thermally Fused Laminate Top Thermally Fused Laminate Chassis
		"P" Option N/A	"G" Option N/A	"M" Option N/A
		"P" Option N/A	"G" Option N/A	"M" Option N/A
		"P" Option N/A	"G" Option N/A	"M" Option N/A
		"P" Option N/A	"G" Option N/A	"M" Option N/A
		"P" Option N/A	RPC3753BK250G 2966	"M" Option N/A
		"P" Option N/A	RPC3731BK250G 2679	"M" Option N/A
		"P" Option N/A	RPC3153BK250G 2723	"M" Option N/A
		"P" Option N/A	RPC3131BK250G 2543	"M" Option N/A
			GAC	
			GIC	
			GHC	
			GOC	
			GEW	
			GNW	
			Richmond	Classic
			Richmond	Classic
			Hardware	
			N/A	

Product Features

- .75" Thick veneer back w/ dowel joint
- 2.5" Cornice top
- Adjustable glides
- Interior shelf depth 12"
- Veneer Top for 53" and 30" height
- Top profile shaped 3 sides
- "W" styles - 30", 53" H units finished top, 74", 86" H units black painted top

Notes

- Base Height 3.5"
- Glides adjust 1"
- Unit has black back panel and is not designed for Open Plan use. Select OPB Option for Open Plan application
- 31.75"H Open Bookcases are NOT meant to gang with desks, returns and credenzas. Unit is higher than regular worksurfaces to allow double binder storage. If matching height is desired, choose RPC-3724CA125W or RPC3124CA125W with D6A option

Options

Flush Cut

- FC-B: Flush Unit Both Sides(Facing) for Ganging - \$100
- FC-R: Flush Unit Right(Facing) for Ganging - \$100
- FC-L: Flush Unit Left (Facing) for Ganging - \$100

Interior Cabinet Lighting

- LEDPK starter kit includes Infeed, 1 Puck Interior Light and the ability to daisy chain up to 6 total Puck Lights
- LEDPK: LED Puck Starter Kit - \$310
- PK: 1 LED Interior Light - \$130

Open Plan _ Finished Back

- OPB: "W" "G" Style - Modify Unit for Open Plan Application - \$395

Shelf

- GS14F: Replace Standard Shelves with Glass Shelves - \$90 per shelf
- S714F: Heavy Duty Lumber 1" Shelves - \$80 per shelf

2 Select Finish

[Click to view finishes](#)

- WAC
- WIC
- WHC
- WOC
- WEW
- WGW
- WBW
- WSW
- WNW

3 Select Edge

[Click to view edges](#)



4 Select Hardware

[Click to view details](#)

- Hardware
- N/A

- Hardware
- N/A

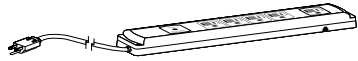

POWER / DATA
power supply cordset

Style Number	List Price
PD717	95

Specifications

- SIZE: 10.75"L x 2.0"W x 1.06"H
- (5) Outlets w/ 10' cord
- Surge suppression (720 Joules)
- 15 Amp breaker
- Available on: Vertical Panels, Cabinet Interiors, and under tops

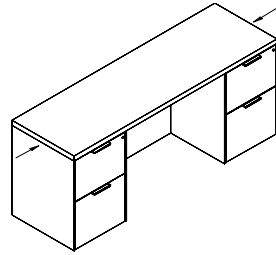

PRODUCT MODIFICATIONS
modify width - open kneespace

Style Number	List Price
MOD-1	125

Specifications

- Modify width down on any unit with an open kneespace: desk, workstation credenza, bridge, return

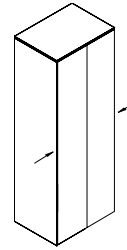

PRODUCT MODIFICATIONS
modify width - open/closed storage

Style Number	List Price
MOD-2	250

Specifications

- Modify width down on any unit with open or closed storage section: overheads, wall hung units, storage credenzas, towers

PRODUCT MODIFICATIONS
modify width - outside of mod-1, mod-2

Style Number	List Price
MOD-3	Contact for pricing

Specifications

- Width modification outside of MOD-1 & MOD-2

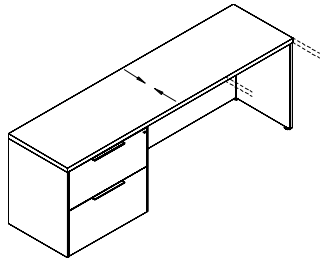

PRODUCT MODIFICATIONS
modify depth - decrease depth

Style Number	List Price
MOD-5	125

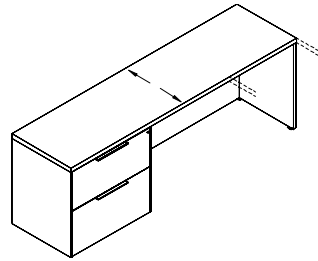

PRODUCT MODIFICATIONS
modify depth - increase depth

Style Number	List Price
MOD-6	Add 10%

PRODUCT MODIFICATIONS
modify height

Style Number	List Price
MOD-7	Contact for pricing

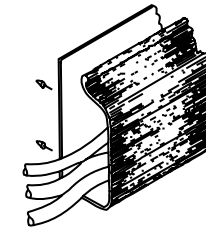

WIRE MANAGEMENT
horizontal j-channel wire
management raceway

Style Number	List Price
W1	75 Per 4' section

Specifications

- Modify depth down (minimum depth for a unit with drawers is 21"D)

Notes

- Ex. 24" to 21", 30" to 24", and 36" to 30"

Specifications

- Increase depth by no more than 6"

Notes

- Ex. 24" to 30", 30" to 36", and 36" to 42"
- Add 10% to the unit you want to increase the depth of by no more than 6"

Specifications

- Modify height of a unit

Specifications

- 4' section for field installation.
- The "J" shape black thermoplastic wire raceway may be added to specified worksurface tops to provide concealed channeling of wires to and from worksurface grommets. For use in open kneespace areas, raceway is attachable to top of back panel with pan head screws. Interior dimensions are 1" x 1- 1/2" providing ample storage for multiple wires and excess cable. Front of raceway flexes out for easy cord insertion.

Notes

- Units w/ Wire Channel Standard.
- Field Installation

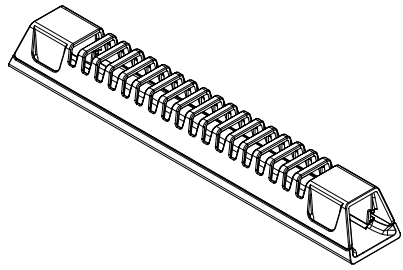

WIRE MANAGEMENT
horizontal wire management raceway

Style Number	List Price
W21	30

Specifications

- 10"W x 1.5"D x 1.25"H
- Grey Wire Manager (10.5")
- Power and data cables can be discretely housed and managed with the W21 Gray Wire Manager. This can be mounted in any location to metal frame or underside of conference tables and runs cables through a 1" channel from power module to hollow steel legs. This keeps cables organized under the table top. Release clips make it simple to snap on and off the Wire Manager for easy organization and access after attached to the table

Notes
- Field installed



WIRE MANAGEMENT
horizontal u-channel wire management raceway

Style Number	List Price
W2A	75 Per 4' section

Specifications

- 4' section for field installation.
- Notes
- Units w/ Wire Channel Standard.
 - Field Installation



WIRE MANAGEMENT
coil wire manager

Style Number	List Price
W18	150

Specifications

- Weighted Base, Table attachment plate
 - 39- 1/2" Length
 - Black
- Notes
- Location

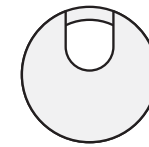

WIRE MANAGEMENT
standard location grommets - factory installed

Style Number	List Price
Standard Location Grommet	
Black	
TM30	45
Silver	
TM31	45
Antique Brass	
TM33	45

Specifications

- 1 -5/8" Metal Grommet
- Notes
- *Units w/ Grommets Standard Are Noted Under Standard Features. Grommets Match Pull Finish - Standard (Unless Specified Otherwise)

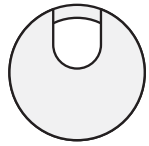

WIRE MANAGEMENT

non-standard location grommets - factory installed

Style Number	List Price
Non-Standard Location Grommet	
Black	
TM30 -NS	90
Silver	
TM31 -NS	90
Antique Brass	
TM33 -NS	90

Specifications

- 1 -5/8" Metal Grommet

Notes

- *Units w/ Grommets Standard Are Noted Under Standard Features. Grommets Match Pull Finish - Standard (Unless Specified Otherwise)



WIRE MANAGEMENT

black plastic vertical surface grommets - factory installed

Style Number	List Price
Standard Location Grommet	
TM50-C	45
Non-Standard Location Grommet	
TM50-NS	90

Specifications

- 2 " Black Plastic Grommet

Notes

- Standard Location is Bottom Center



COMPUTER SUPPORT

single monitor arm

Style Number	List Price
MA1	265

Specifications

- Available in black or silver
- Desk clamp and mounting included
- Easy assembly and flexibility
- Elastic painting process for a durable and beautiful finish
- Gas spring tension adjustment for counter-balance height adjustment for monitors 1-8 KG
- Gas spring tested to 50,000 repetitions
- Hidden cable management

Richmond Park Options



COMPUTER SUPPORT

double monitor arm

Style Number	List Price
MA2	430

Specifications

- Available in black or silver
- Desk clamp and mounting included
- Easy assembly and flexibility
- Elastic painting process for a durable and beautiful finish
- Gas spring tension adjustment for counter-balance height adjustment for monitors 1-8 KG
- Gas spring tested to 50,000 repetitions
- Hidden cable management

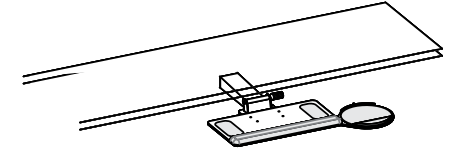
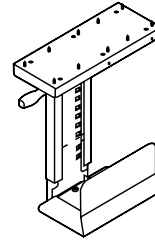

COMPUTER SUPPORT
triple monitor arm

COMPUTER SUPPORT
quadruple monitor arm

COMPUTER SUPPORT
cpu retractable cradle

COMPUTER SUPPORT
articulating keyboard tray

Style Number	List Price
MA3	505

Style Number	List Price
MA4	675

Style Number	List Price
K18	195

Style Number	List Price
Factory Installed K28	390
Field Installed K28F	415

Specifications

- Available in black or silver
- Desk clamp and mounting included
- Easy assembly and flexibility
- Elastic painting process for a durable and beautiful finish
- Gas spring tension adjustment for counter-balance height adjustment for monitors 1-8 KG
- Gas spring tested to 50,000 repetitions
- Hidden cable management

Specifications

- Available in black
- Desk clamp and mounting included
- Easy assembly and flexibility
- Elastic painting process for a durable and beautiful finish
- Gas spring tension adjustment for counter-balance height adjustment for monitors 1-8 KG
- Gas spring tested to 50,000 repetitions
- Hidden cable management

Specifications

- Black Metal CPU Carriage
- Full 360° swivel capability allows easy access to rear of CPU for cables / wires
- Track allows 8- 1/2" extension
- Width Adjustment 5-1/2" to 9-1/4"
- Height adjustment 14- 5/8" to 20- 1/2"
- Black epoxy finish

- Notes
- Factory Installed

Specifications

- Adjusts effortlessly - A simple one-handed motion allows the keyboard to be repositioned instantly, without the use of locks or levers
- Encourages low-risk postures - Maximizes adjustability within a safe operating range.
- Will last a lifetime - Exceeds all applicable BIFMA Standards and comes with a lifetime guarantee.

- Notes
- Available on: Freestanding Desk
 - Factory Installed (standard)
 - FIELD INSTALL - \$395



DOOR MODIFICATIONS
soft close door hinge

Style Number	List Price
D9SC	15 Per door

Specifications

- Snap onto standard door hinge
- Requires (2) per door
- Max door height 43"
- Factory installed where specified
- Individually shipped for field installation

Notes
- Specify Each Item To Have Slow Close Feature

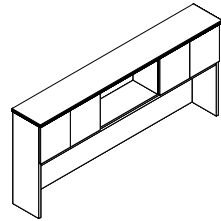

DOOR MODIFICATIONS
delete doors

Style Number	List Price
D6	N/C

Specifications

- Standard Door overheads and cabinets can have door deleted for open access. Modification of hinge rails and structural components are made face ready.



DOOR MODIFICATIONS
replace glass panel insert with veneer panel insert

Style Number	List Price
D35	30 per door

Specifications

- Replace glass panel insert with veneer panel insert
- Notes
- Not Available on "M" skus
 - Glass door has beveled glass
 - Wood door w/ veneer insert - only available on "W" style

Richmond Park Options

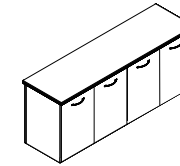

DOOR MODIFICATIONS
delete doors/replace black laminate shelf w/ finished shelf

Style Number	List Price
D6A	N/C

Specifications

- Delete doors and replace black laminate shelf with finished shelf
- Notes
- Available on: All Storage "W"/"G" Style Credenzas.

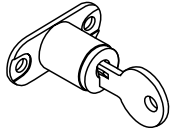

DOOR MODIFICATIONS
panel door lock

Style Number	List Price
D2	95 Per door set

Specifications

- Door Locks - 1 Door w/ Lock, Other Door w/ Catch Latch
- Contact Customer Service regarding limited lock locations and keying.

Notes
- Available on: Panel Doors, Wood Frame Doors, and Silverluma doors

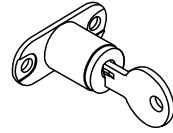

DOOR MODIFICATIONS
glass door lock

Style Number	List Price
D2-G	195 Per door set

Specifications

- Door Locks - 1 Door w/ Lock, Other Door w/ Catch Latch
- Contact Customer Service regarding limited lock locations and keying.

Notes
- Available on: Glass Doors

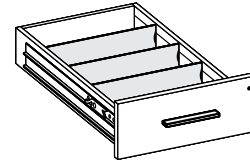

DRAWER OPTIONS
box drawer accessories

Style Number	List Price
Wood Drawer Dividers w/ Clips	
K-DIV	SET OF 3 - 30
Single Tray - Utility Tray	
K-Sut	30 each

Specifications

- K-DIV Extra Wood Drawer Dividers with Clips, Top Box drawers standard with 1 divider
- K-SUT Single Tray - Utility Tray, Specify Legal or Letter drawer width

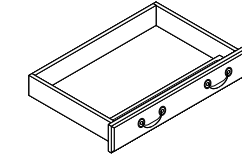

Richmond Park Options

DRAWER OPTIONS
finished traditional center drawer

Style Number	List Price
K30	195
Add Skirt Option	
K30-SK	295

Specifications

- Veneer drawer front finished to match unit veneer. Edges are scalloped to match standard drawers.
- Standard with matching wood grain pencil tray
- Pulls selected to match unit installed

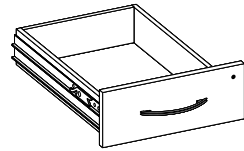
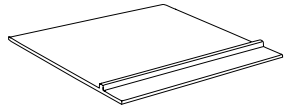

DRAWER OPTIONS - BOTTOM COVER
felt bottom center drawer insert liner

Style Number	List Price
K3	95

DRAWER OPTIONS - UPGRADE
wood drawer upgrade

Style Number	List Price
P33	40 Per Drawer

GLASSBOARD ACCESSORIES
glassboard accessory kit

Style Number	List Price
GBKIT	275

TASK LIGHTING
It-led task light

Style Number	List Price
24" Task light LT-LED24	215
48" Task light LT-LED48	270
60" Task light LT-LED60	335
72" Task light LT-LED72	360

Specifications

- Inserts into center drawer and features divider for open pen and pencil storage. Removable for easy cleaning.
- Adds a luxurious touch to center drawers.
- Color: Dark Brown Coal

Specifications

- Dowel joint construction
- Hardwood veneer multi-ply drawer
- UV finish
- 1/4" Wood veneer bottoms
- File drawer bottoms are five block reinforced for heavy weight capacity
- Lifetime guaranteed

Specifications

- 8 Earth magnets, 1 magnetic marker cup holder and 1 magnetic dry eraser

Specifications

- 6.5' Power cord. Switch with touch dimmer
- 36 LEDs per foot
- 4.6 Watts per foot
- 91 Lumens per watt
- Please note when ganging.
- Overhead tasklight cord is located on the right facing side. If the opposite location is required please contact customer service.

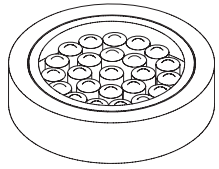

LIGHTING

led interior cabinet puck light

Style Number	List Price
Starter Kit LEDPK	310
1 LED Interior Puck Light PK	130

Specifications

- Starter kit includes Infeed, 1 Puck Interior Light and the ability to daisy chain up to 6 total Puck Lights
- (1) LED Puck Light with 30W power drive and switch
- Recessed fixture
- 12V linking cord 98"L
- Silver finish
- 50,000 hour life
- 2 watt per light

Notes

- Available on: Overhead/Tower Units with glass doors or no doors
- Power drive included, Light only

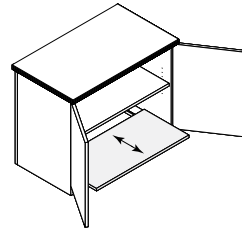

PEDESTAL MODIFICATIONS

black laminate printer pullout bottom shelf

Style Number	List Price
PPOS	214

Specifications

- Black Laminate pullout shelf on suspension
- Black grommet
- Adjustable Shelf

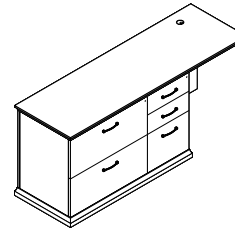

PEDESTAL MODIFICATIONS

add veneer kneespace cabinets - base

Style Number	List Price
Add Box/Box/File or File/File P40B	985
Add Lateral File 29" W P41B	1205
Add Multi-File - 31"W P42B	1205
Add Storage With Doors 29"W P43B	1095
Add CPU /Printer Cabinet - Open P44B	1095

Specifications

- Multi-file specify Box/Box Left or Right

Notes

- Add additional Standard Cabinets To Kneespace Area.

Richmond Park Options

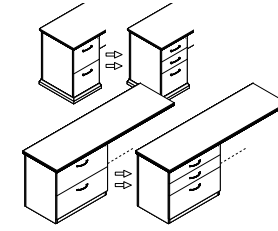

PEDESTAL MODIFICATIONS

modify drawer configurations

Style Number	List Price
P6	55 Per ped
P6	55 Per ped
P8	95 Per ped

Specifications

- Modify File/File To Box/Box/File - Any Unit

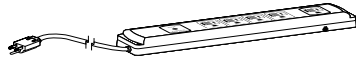

POWER / DATA
power supply cordset

Style Number	List Price
PD717	100

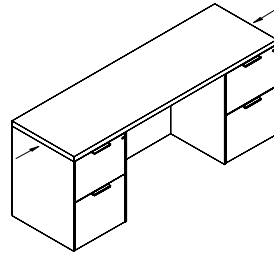

PRODUCT MODIFICATIONS
modify width - open kneespace

Style Number	List Price
MOD-1	125

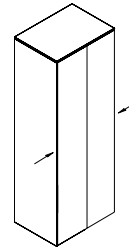

PRODUCT MODIFICATIONS
modify width - open/closed storage

Style Number	List Price
MOD-2	250

PRODUCT MODIFICATIONS
modify width - outside of mod-1, mod-2

Style Number	List Price
MOD-3	Contact for pricing

Specifications

- SIZE: 10.75"L x 2.0"W x 1.06"H
- (5) Outlets w/ 10' cord
- Surge suppression (720 Joules)
- 15 Amp breaker
- Available on: Vertical Panels, Cabinet Interiors, and under tops

Specifications

- Modify width down on any unit with an open kneespace: desk, workstation credenza, bridge, return

Specifications

- Modify width down on any unit with open or closed storage section: overheads, wall hung units, storage credenzas, towers

Specifications

- Width modification outside of MOD-1 & MOD-2

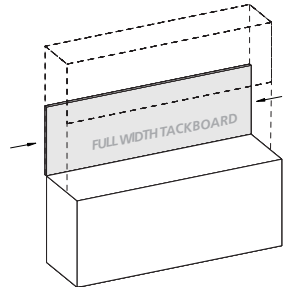

PRODUCT MODIFICATIONS
 modify width - tackboard, slat wall,
 veneer panel, or a glassboard

Style Number	List Price
MOD-4	50

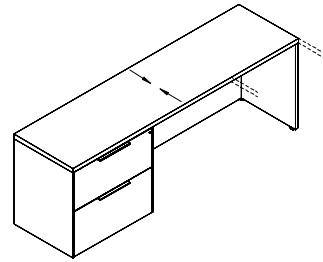

PRODUCT MODIFICATIONS
 modify depth - decrease depth

Style Number	List Price
MOD-5	125

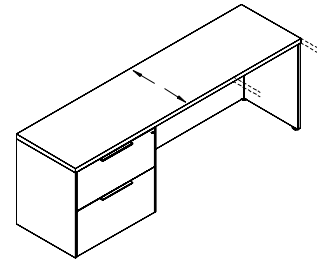

PRODUCT MODIFICATIONS
 modify depth - increase depth

Style Number	List Price
MOD-6	Add 10%

PRODUCT MODIFICATIONS
 modify height

Style Number	List Price
MOD-7	Contact for pricing

Specifications

- Modify width down on tackboard, slat wall, veneer panel, or a overhead glassboard

Specifications

- Modify depth down (minimum depth for a unit with drawers is 21"D)

Notes
 - Ex. 24" to 21", 30" to 24", and 36" to 30"

Specifications

- Increase depth by no more than 6"

Notes
 - Ex. 24" to 30", 30" to 36", and 36" to 42"
 - Add 10% to the unit you want to increase the depth of by no more than 6"

Specifications

- Modify height of a unit

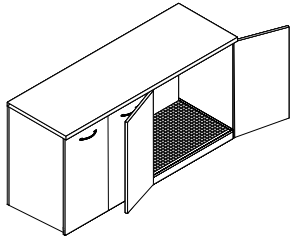

REFRIGERATOR MODIFICATION
refrigerator cabinet modification

Style Number	List Price
REF01	195

Specifications

- Open back cutout for venting
- Moisture sponge mat
- Contaminate ledge
- Contact customer service for maximum refrigerator size (Changes based on unit).
- Available on: 36" and 42" Storage Credenzas

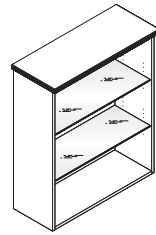

SHELF MODIFICATIONS
glass shelves - tempered full width
26" - 35"

Style Number	List Price
26"W - 35"W x 14"D Shelf GS14F	90 each

Specifications

- Glass Shelves Replace Wood Shelf In Open Or Glass Door Cabinet. Also Order Interior Cabinet Lighting.

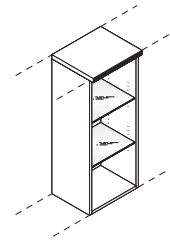

SHELF MODIFICATIONS
tempered glass shelves for half
cabinet 17- 1/2" widths

Style Number	List Price
14-1/2"W - 17- 1/2"W x 14"D Shelf GS14H	90 ea

Specifications

- Glass Shelves Replace Wood Shelf In Open Or Glass Door Cabinet. Also Order Interior Cabinet Lighting.

Notes

- Replace only adjustable shelves between cabinet light and fixed lower wood shelf.

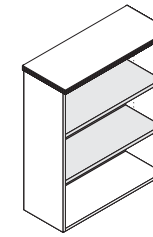

SHELF MODIFICATIONS
heavy duty solid wood bookcase
replacement shelves

Style Number	List Price
1" Wood Shelf 14" Deep S714F	80 each
1" Wood Shelf 24" Deep S714FX	150 each

Specifications

- 1" Solid Lumber Core Shelves Replace Standard 3/4" Plywood Adjustable And Fixed Shelves

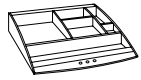

SLAT WALL ACCESSORIES
slat wall accessory tray

Style Number	List Price
SWA9	45

Specifications
- Specify Black Or Matte Silver

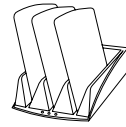

SLAT WALL ACCESSORIES
slat wall folder tray

Style Number	List Price
SWA7	45

Specifications
- Specify Black Or Matte Silver

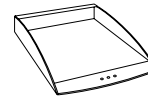

SLAT WALL ACCESSORIES
slat wall paper tray

Style Number	List Price
SWA2	35

Specifications
- Specify Black Or Matte Silver



SLAT WALL ACCESSORIES
slat wall pencil holder

Style Number	List Price
SWA4	25

Specifications
- Specify Black Or Matte Silver

Aircharge wireless charging grommet

Style Number	List Price
 ACWG WIRELESS GROMMET	\$213

Specifications

- > When used with GROVE Tables an additional \$350 LIST will apply for the special cutout required.
- > AirCharge offers a convenient way to charge any Qi compatible smartphone or device without the need to carry charging cables or find an available power outlet.
- > The Aircharge is powered by the latest Qi compliant IC offering reliable and efficient wireless charging in a convenient 3" grommet hub. Simply place your phone on the Aircharge and an LED will confirm pairing and begin wireless charging.
- > Recess: Efficient space conservation and quick access
- > Input: DC 5V (with included AC power adapter), DC 9V, 1.67A (with optional QC 2.0 power adapter)
- > Output: 5 watts Max. with DC 5V, 2A power adapter, 10 watts Max. with QC 2.0 power adapter
- > Qi V1.2 compliant IC
- > Charging distance: 6mm Max.

Available: All DARRAN collections



Cove power unit - non-linking

Style Number	List Price
 PD-COVE PLUG	\$600
Non-linking version	

Specifications

- > Size 5.75"L x 2.5"W
- > (2) 15 Amp Receptacles and (2) USB charging ports
- > Surface Mount
- > 108" Cord
- > Standard Silver Finish, Available in White or Black Finish upon request
- > ETL Listed

Available: All DARRAN collections



Cove corded series

Style Number	List Price
 PD-COVE-PKO	\$872

Specifications

- > Size 9.5"L x 2.5"W x 3.18"D
- > When used with GROVE Tables an additional \$350 LIST will apply for the special cutout required.
- > (2) Power Receptacles, (2) 2.1 Amp USB charging ports and (1) Telecom Plate Knockout
- > Surface Mount
- > 108" Cord
- > Standard Silver Finish, Available in White or Black Finish upon request
- > ETL Listed

Available: All DARRAN collections

Telecom Plates

RJ45 (1)	\$55
RJ45 (2)	\$110
RJ45 (3)	\$165
USB (1)	\$70
USB (2)	\$140
RJ11/RJ45	\$110
RJ45/USB	\$125
RJ45/HDMI	\$210
HDMI/DVI	\$325
HDMI/USB	\$205
HDMI/VGA	\$240
VGA/MINI-STEREO	\$155
VGA/USB	\$175

This pod can have up to 1 total plates.
 *All telecom connectors sold separately.



Soba wire manager

Style Number	List Price
STARTER UNITS	
SCDW	\$218
White wire manager	
SCDB	\$218
Black wire manager	

Specifications

- › Dimensions: 9ft x 9in x 3.15in
- › Zips up, bundles and routes loose, messy cables into a single tube
- › Routes and guides cables behind desks, TVs, and anywhere cables tend to get messy
- › Accommodates large or small cables, up to three cables at once
- › Support channels, used to route cables, include powerful adhesive backing which allows easy attachment to surfaces.

Available: All DARRAN collections



VILLA Power unit - non-linking

Style Number	List Price
 VIL-C PLUG	\$562
Non-Linking	

Specifications

- › Size: Top Grommet 5.68"L X 3.39"W; Under Top 12"L x 3.13"W x 3.08"D
- › (2) Power receptacles; (2) USB charging ports and (1) Knockouts for RJ45 Data Ports
- › Surface Mount
- › 72" Cord (Longer cord available, contact Customer Service)
- › Standard Silver Finish, Black Finish available upon request
- › UL or ETL Certified

Available: All DARRAN collections, excludes Grove

RJ45 Knockout	
RJ45 (1)	\$55

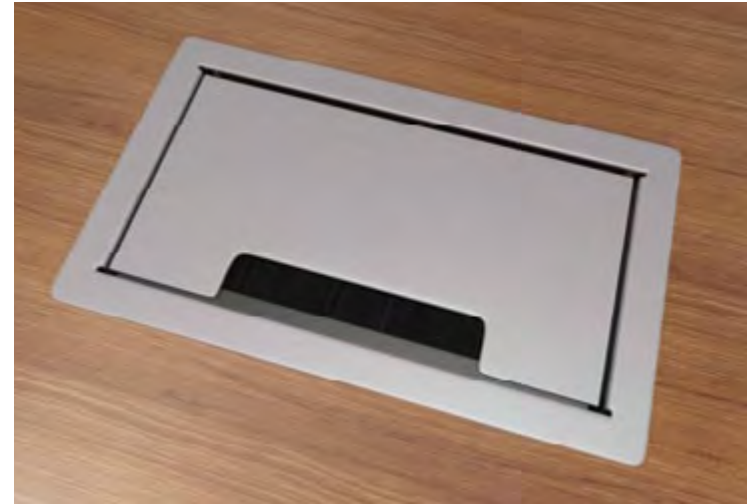

DARRAN®



Capitol Park Price List

Effective November 1, 2022

Date	Page	Modification	Description
11.11.22	Price Increase	9% price increase applied to all items excluding options	
01.18.2	7	Grommets removed from M34 and M51	
02.15.23	56	Removed leather inlays	

Statement of Line
Features & Advantages1
Finishes | Specifications3
Edges | Pulls | Knobs.....4
Grommets | Grommet Reference.....5
Ganging | Height Reference6
Modesty Reference | Doors | Grain Direction7
Drawer Dimensions | Filing Reference8
Double Pedestal Desk.....9
Single Pedestal Desk.....11
Conference Desk13
Returns.....14
Bridges17
Freestanding Credenzas18
Lateral File22
Workstation Credenzas23
Single Height Freestanding Overheads26
Overhead Accessories.....28
Single Height Wall Hung Overheads.....32
Wall Hung Accessories33
Overhead Half Towers.....38
Overhead Bookcases40
Vertical Half Towers.....42
Vertical Full Towers.....43
Bookcases45
Options47
Power & Data.....61

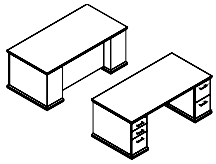

Page 9
Double Pedestal Desks
Executive / Breakfront

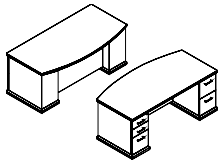

Page 10
Double Pedestal Desks
Bowfront / Breakfront

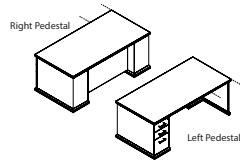

Page 11
Workstation Desks
Breakfront - Single Pedestal

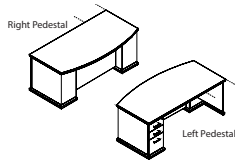

Page 12
Workstation Desks
Bowfront Breakfront - Single Pedestal

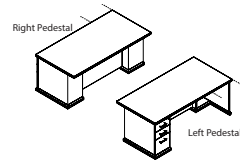

Page 13
Workstation Desks
Conference Overhang Breakfront - Single Pedestal

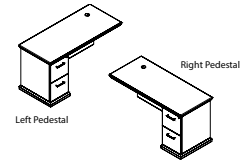

Page 14
"L" Workstation Returns
File/File

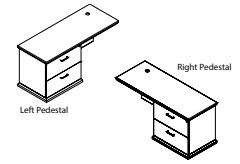

Page 15
"L" Workstation Returns
Lateral File

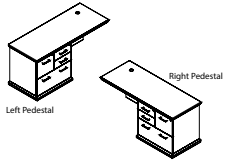

Page 16
"L" Workstation Returns
Box/Box/File/Lateral

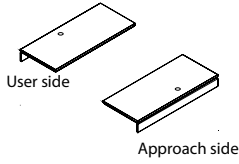

Page 17
Workstation Bridges
Open Back

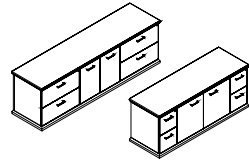

Page 18
Credenzas
File / Storage

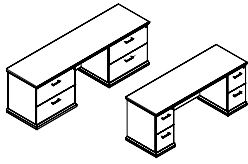

Page 19
Credenzas
Kneespace

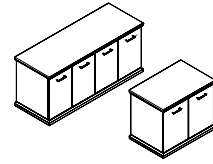

Page 20
Credenzas
Storage

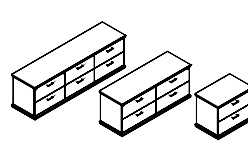

Page 21
Lateral File Credenzas
6/4/2 Drawers

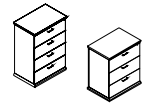

Page 22
Lateral File
Vertical Lateral File

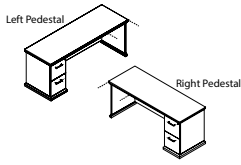

Page 23
Workstation Credenzas
File/File

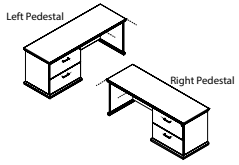

Page 24
Workstation Credenzas
Lateral File

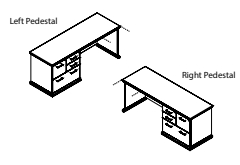

Page 25
Workstation Credenzas
Box/Box/File/Lateral

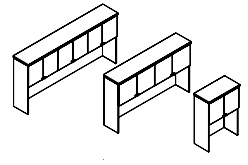

Page 26
Single Storage Overhead
Console
Panel Door - 6/4/2 Door

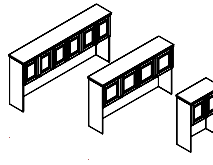

Page 27
Single Storage Overhead
Console
Wood Frame Door With Clear
Glass Inserts

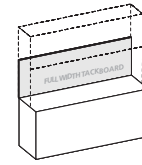

Page 28
Overhead Tackboards

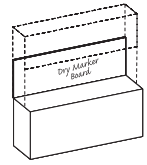

Page 29
Overhead Dry Marker Boards

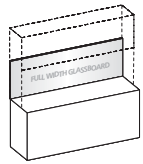

Page 30
Overhead Glassboards

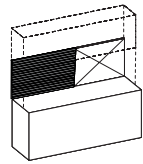

Page 31
Overhead Slat Wall

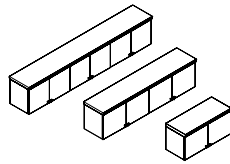

Page 32
Single Height Wall Hung Over-
heads
Panel Doors - 6/4/2 Door

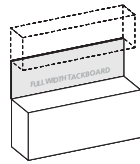

Page 33
Wall Hung Tackboards

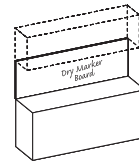

Page 34
Wall Hung Dry Marker Boards

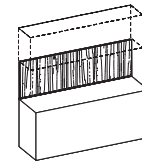

Page 35
Wall Hung Veneer Panels

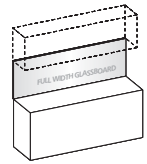

Page 36
Wall Hung Glassboards

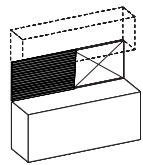

Page 37
Wall Hung Slat Wall

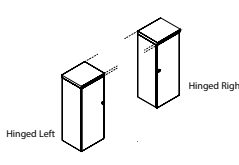

Page 38
Sit-On Tower Extension
Panel Door - Full Storage

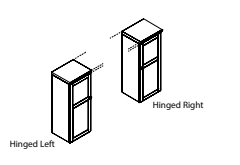

Page 39
Sit-On Tower Extension
Wood Frame Door/Clear Glass
Insert - Full Storage

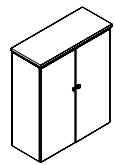

Page 40
Sit-On Bookcase Console
Panel Door

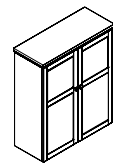

Page 41
Sit-On Bookcase Console
Frame Door With Clear Glass

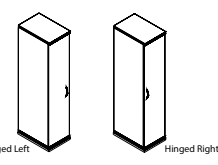

Page 42
Half Towers
Half Wardrobe - Left/Right Hinge

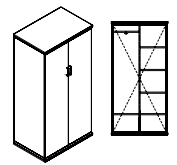

Page 43
Full Towers
Full Wardrobe

Statement of Line

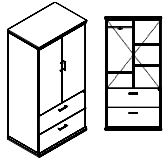

Page 44
Full Towers
2 Lateral File / Wardrobe

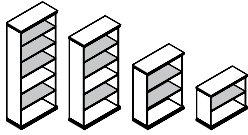

Page 45
Freestanding Bookcases
Open Bookcases

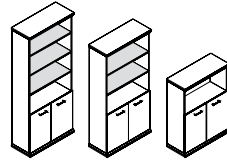

Page 46
Freestanding Bookcases
Bookcases W/ Doors

Veneer

DARRAN only uses HPVA AA Grade Flat Cut Cherry and Walnut Veneers. All veneers are selected and matched for balance and consistency.

Veneer tops

Capitol park veneer tops feature a 45-pound density substrate with balanced 3-ply construction. Tops are 1-1/8" thick on MDF core comprised of 100% recycled and recovered wood fibers. All veneer tops are slipmatched and feature a 3mm external solid hardwood band or profile edge.

Laminate tops

Capitol park high-pressure laminate tops feature a 45-pound density substrate with balanced 3-ply construction. Tops are 1-1/8" thick on MDF core comprised of 100% recycled and recovered wood fibers. All high pressure laminate tops are available with a profile edge, laminate self-edge or 2mm PVC edge band. Laminates in wood grain patterns feature a fine grain texture that features the polish and luxe of a real wood veneer with a subtle narrow grain structure.

Cleaning wood & laminate

In addition to regular dusting, give your furniture an occasional cleaning in accordance with our cleaning instructions. DARRAN wood and laminate products can be cleaned with a soft cloth and a mild soap and water mixture. Use approximately 32 oz of water mixed with one tablespoon of dish soap, always wiping with the grain. Dry with a soft cloth, going with the grain, to avoid spotting or streaking.

Wood products should be waxed periodically using a non-wax liquid; please do not use any waxy polish or cleaner. Interior of drawers may also be cleaned with mild soap and water mixture, or any household cleaner that is not petroleum or thinner-based.

Chassis & pedestal

Chassis components are 3/4" thick core of particle board or MDF rated EPP/SCS/CARB-II material with 3-ply balanced construction. Pedestal and Cabinets feature dowel construction reinforced with steel bracket plates, wood cleats, screws and glue. All units are standard with 1" adjustable glides that allow for leveling of units that are secured in solid wood glide blocks to prevent tearout.

Overhead cabinet construction Freestanding & wall mount

Freestanding Overhead storage cabinets are constructed of 1" and 3/4" thick core of particle board or MDF rated EPP/SCS/CARB-II material with 3-ply balanced construction. Panels are attached with cam fasteners in conjunction with dowels securely adhered with glue. All surface mount cabinets connect to work surface with anti-slip tape. Wall mount cabinets are mounted to the wall with steel "z" bracket attachment method using 5mm euro screws

to attach to the back of the cabinet. All units ship with a steel "z" bracket. This bracket is mounted to the wall by field installers. Installers are responsible for selecting and supplying appropriate fasteners for wall conditions.

Bookcase Construction

All chassis (sides, back, top and bottom panels) are constructed with 3/4" thick core of particle board or MDF rated EPP/SCS/CARB-II material with 3-ply balanced construction. Panels are attached with cam-lock fasteners in conjunction with dowels securely adhered with glue. Shelves on all units are 3/4" thick balance 3 ply panels. Optional heavy duty shelves are 1" thick lumber core balanced 5 ply construction.

Tackboards

Wall mount tackboards are constructed of .75" thick fiberboard. The fabric is precisely aligned and fitted to the tackboard with a sock on cover. Overhead storage tackboards are constructed of .75" thick fiberboard. The fabric is precisely aligned and fitted to the tackboard and adhered to the rigid hardboard with staples. Wall mount cabinets are mounted to the wall with steel "z" bracket attachment method using 5mm euro screws to attach to the back of the cabinet. All units ship with a steel "z" bracket. This bracket is mounted to the wall by field installers. Installers are responsible for selecting and supplying appropriate fasteners for wall conditions.

Adjustable glides

Glides provide 1" of vertical leveling adjustment. Glide bottom is durable metal. Glides are secured in solid wood blocks that are screwed and glued for durability.

Drawers

All drawers are constructed with mitre joint/dowel construction in a natural maple finish with four sides and a bottom, which are attached to a drawer front with screws for easy removal. Drawer fronts are vertically matched in balanced sets. Pencil trays are standard in all box drawers. Drawers are constructed of 1/2" thick wood grained wrapped 5 sided miter-folded construction with 1/4" thick hardboard bottoms reinforced for heavy weight capacity. Drawers have been tested and pass BIFMA 50,000 cycle test. All drawers are guaranteed lifetime with free replacement warranty.

Drawer fronts

Drawer fronts are vertically matched in balanced sets. Doors feature vertical veneer bookmatched horizontally in sets of 2 / 4 and 6 doors. All tower fronts matched in vertical sets.

Optional wood drawers

Optional hardwood veneer plywood drawers feature banded top and bottom edges for smoothness. Drawers are dowel joint construction with a UV cured finish over maple veneers, plus a lifetime free replacement guarantee.

Optional Wood Drawer (Any Size) – Option Code P33...\$40 List Price Per Drawer

Suspensions

All casegoods utilize cold rolled steel zinc plated high-grade drawer suspensions. Box and File drawers are full extension, featuring steel ball bearings for a smoother quieter range of motion with soft close operation and are rated 100lbs. Lateral file drawers are a progressive action full extension suspension with the soft close operation and is rated at 150lbs. Lateral files include anti tip mechanism that will allow only one drawer at a time to be opened. All suspensions are soft close and are warranted for the lifetime of the product.

Hinges

Units with doors include 95 degree swing hinges.

Filing

Capitol park features a highly durable black plastic extrusion that is securely fastened into a route on top of the drawer to support hanging files. An adjustable crossbar is provided for all file drawers that enables legal/letter filing front to back or side-to-side based on the drawer size.

Locks

Locks are Standard on all drawers below the worksurface. Random lock cores are installed at the factory. Some units may be shipped with the same key number. Locks are Silver, Black or Bronze and match pull finish unless otherwise specified.

DARRAN will also send lock cores separately to the dealer at your request. These units will be send with an empty lock core and the Dealer will receive a shipment of the requested lock core/keys.

Keying

Keying is available either factory or field installed. Factory installed keying is random.

Wire management

Wire management capabilities include standard and optional worksurface grommets. Specify W-1 under surface wire channels for organization and management of all communication wires and cords. Horizontal J-Channel wire management (Sku: W-1) is sold separately to conceal wire under worksurfaces.

Grommets

Metal grommets are provided to match the drawer pull selection. Grommet is available in black, silver, white or antique brass. Must specify standard or non-standard location. Black plastic grommets are available as an option for vertical applications.

Powerports

A large selection of power pods are available and handle power, data, docking stations and communication. See options section for selection.

LED Task Lights

LED task lighting provides high efficiency, low energy lighting with a long life.Surface mounted light is encased in silver aluminum channel with milk lense and rounded end caps. Lights are field installed. Product specifications listed below:

- Diffuser creates a softer light and eliminates hot spots
- Touch dimmer switch
- Can be “daisy chained” up to 90W
- 4.6 watts per foot
- 120 LEDs per meter
- Certification: UL Listed
- 50,000 hour life span.

Color Temp is 4000K

STANDARD VENEER	PREMIUM VENEER	HIGH PRESSURE LAMINATE	THERMALLY FUSED LAMINATE
WAC Amber Cherry.....	N/A.....	GAC Amber Cherry.....	N/A
WIC Crimson Cherry.....	N/A.....	GIC Crimson Cherry.....	N/A
WHC Honey Cherry.....	N/A.....	GHC Honey Cherry.....	N/A
WOC Koko Cherry.....	N/A.....	GOC Koko Cherry.....	N/A
WEW Executive Walnut.....	N/A.....	GEW Executive Walnut.....	N/A
WGW Gunstock Walnut.....	N/A.....	N/A.....	N/A
WBW Henna Walnut.....	N/A.....	N/A.....	N/A
WSW Smokey Walnut.....	N/A.....	N/A.....	N/A
WNW Natural Walnut.....	N/A.....	GNW Natural Walnut.....	N/A

HPL TOPS ON TFL PRODUCTS Add 10% - Available with flat edge only

Send 3x3 or larger finish chip for color match. Custom finish upcharge is 3% or \$250 Net (whichever is greater).



Finish

Welltech Finish delivers a superior furniture coating with exceptional performance that can withstand stringent cleaning agents and possesses unparalleled durability, allowing DARRAN to provide lasting, sustainable products to our customers.

DARRAN®

"W" & "G" Standard profile

Capitol Park Edge for "W" & "G" Styles
Hardwood Rim Band Species Same As
Surface Veneer

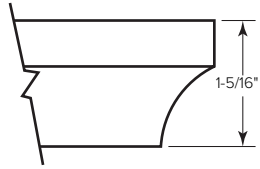

Hookup edge profile

Coped Edge

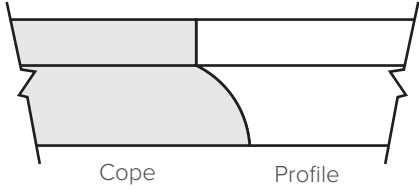

"W" & "G" Base profile

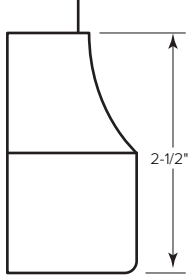

Solid Hardwood Base:
Bases are constructed of solid
hardwood lumber 2-1/2" x 1-5/8".
Corners are precisely mitred
and joined with solid hardwood
corner blocks screwed and
glued for durability. Non-mitred
single end bases are flushed
to kneespcae side to allow
modular cabinet use.

Pulls/knobs

Factory Installed

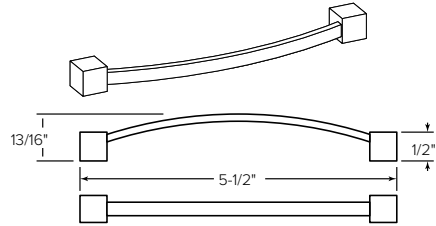

PL-125 Antique Pewter
PL-126 Antique English
PL-127 Matte Black

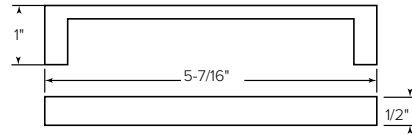
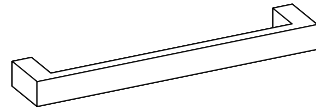

PL-115 Matte Black
PL-116 Matte Nickel

Capitol Park Edges | Pulls | Knobs

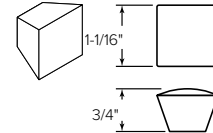

DK-125 Antique Pewter
DK-126 Antique English
DK-127 Matte Black

TM30
Black
1-5/8" Dia.

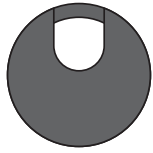

TM31
Silver
1-5/8" Dia.

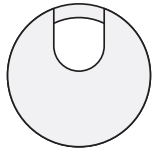

TM33
Antique Brass
1-5/8" Dia.

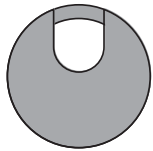

Optional grommets

Factory Installed

Grommets (Standard Location)

Specify Color and Left/Right/Center - \$50 ea.
 - Black: TM30-R (Right), TM30-L (Left), TM30-C (Center)
 - Silver: TM31-R (Right), TM31-L (Left), TM31-C (Center)
 - Antique Brass: TM33-R (Right), TM33-L (Left), TM33-C (Center)

Grommets (Non-Standard Location)

Provide drawing w/ Grommet Location and Specify Color - \$95 ea.
 - Black: TM30-NS
 - Silver: TM31-NS
 - Antique Brass: TM33-NS

TM50
Black
1-5/8" Dia.



Grommets (vertical surface)

Standard Location - \$50 ea.
 - Black Plastic Vertical Surface: TM50-C (Bottom Center)

Non-Standard Location - \$95 ea.
 - Black Plastic Vertical Surface: TM50-NS



W1

Horizontal J-channel

Horizontal J-Channel wire management (Sku: W-1) is sold separately to conceal wire under worksurfaces.

Standard Grommet Location Reference

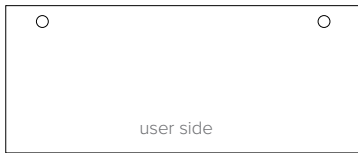

Desk
Specify Right or Left Grommet



6" Overhang Desk
Specify Right or Left Grommet

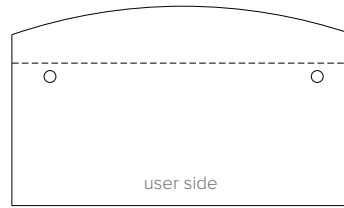

6"/12" Bow Front Desk
Specify Right or Left Grommet

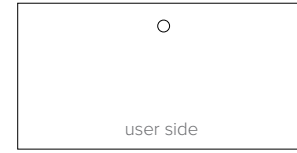

Bridge
Center Grommet

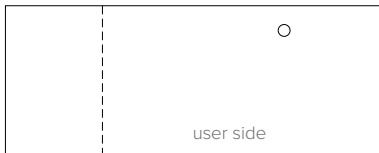

Return (Left Pedestal Shown)
Right Pedestal - Left Grommet
Left Pedestal - Right Grommet



Workstation Credenza
Center Kneespace Grommet

Ganging – Flush Cut Modification

30”H Casegood Worksurface & Base Ganging Modifications

To gang two casegood units, each unit end to be ganged must be flush cut modified for gapless surfaces and cabinet chassis.

Order Option:

- FC-B: Flush Unit Both Sides(Facing) for Ganging - \$100
- FC-L: Flush Unit Left (Facing) for Ganging - \$100
- FC-R: Flush Unit Right (Facing) for Ganging - \$100

Flush cut modification per unit includes all modifications to gang to one end or both ends when units are ganged. Modification includes tops, base and molding.

Modification reduces width size approximately 1” per end.

Example:

CAP3024CA104W Two Drawer Lateral File (Left) Flush Cut Right – FC-R...\$100

CAP7124CA054W Kneespace Credenza (Right) Flush Cut Left – FC-L...\$100

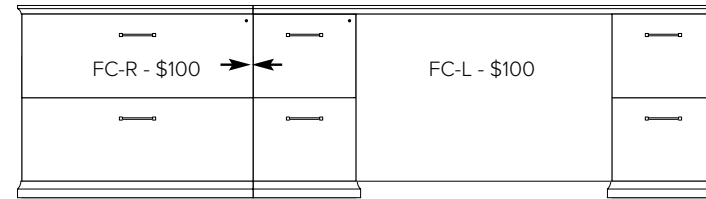

Height reference

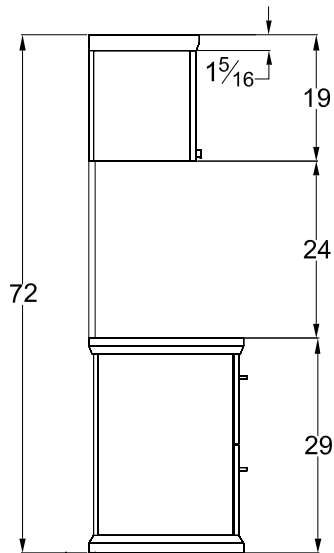

Typical Single Height Side Profile Wall Hung Overhead

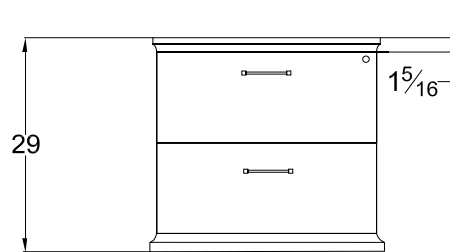

Pedestal Front Profile Lateral File

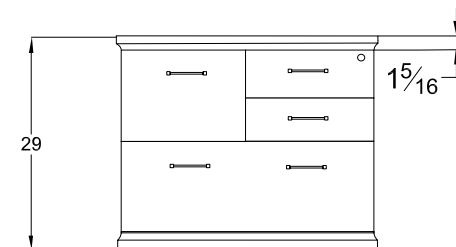

Pedestal Front Profile Multi-File

Modesty Reference

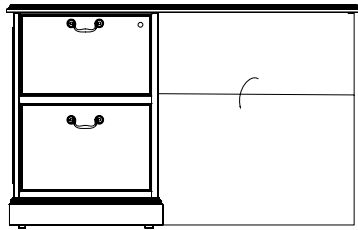

M34
Drop Door Tech Modesty

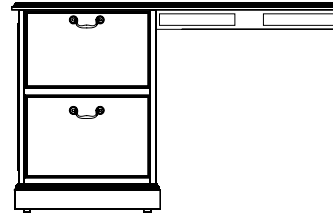
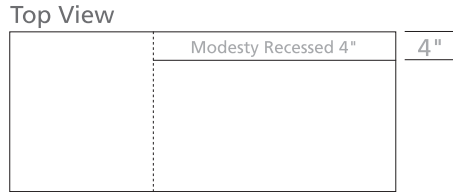

M51
Open Back Modesty with 4" Wire Management Rail

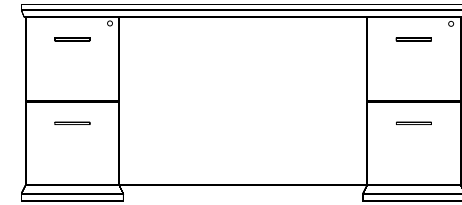

M37
Fixed Full Modesty

Overhead Door Detail



Panel Door

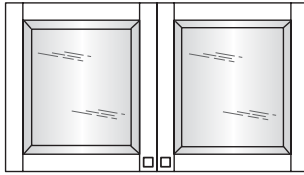

Beveled Glass Door

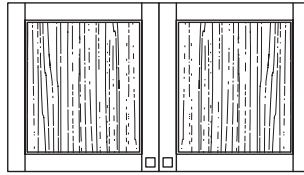

Solid Hardwood Frame Door w/ Veneer Insert - Only Available on "W" Styles

Grain Direction

Veneer chassis parts are vertical grain. Doors feature vertical veneer bookmatched horizontally in sets of 2,4, and 6 doors. Tower fronts are matched in vertical sets.

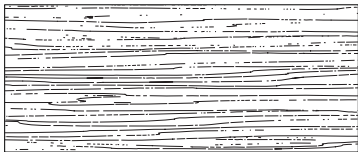

Desk

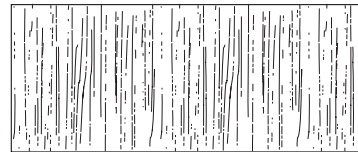

Runoff Desk

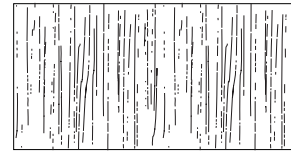

Bridge

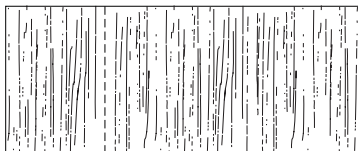

Return



Credenza

Interior Drawer Dimensions

UNIT DEPTH	DRAWER TYPE	OVERALL DIMENSIONS			INTERIOR DRAWER DIMENSIONS			NOTES
		W	D	H	W	D	H	
15-5/8" Letter	36" Box	13-1/8	19-11/16	4	12-1/8	18-11/16	3-7/16	Units less than 72"
	36" File	13-1/8	19-11/16	9-13/16	12-1/8	18-11/16	9-5/16	Units less than 72"
	30" Box	13-1/8	19-11/16	4	12-1/8	18-11/16	3-7/16	Units less than 72"
	30" File	13-1/8	19-11/16	9-13/16	12-1/8	18-11/16	9-5/16	Units less than 72"
	24" Box	13-1/8	16-1/16	4	12-1/8	15-1/16	3-7/16	Units less than 72"
29" Lateral	24" File	13-1/8	16-1/16	9-13/16	12-1/8	15-1/16	9-5/16	Units less than 72"
	24" File	26-1/2	16-1/16	9-13/16	25-1/2	15-1/16	9-5/16	Workstation Credenzas less than 82"
31" Lateral	24" File	28-9/16	16-1/16	9-13/16	27-9/16	15-1/16	9-5/16	Multi-File Lateral File
35" Lateral	24" File	32-1/2	16-1/16	9-13/16	31-1/2	15-1/16	9-5/16	Workstation Credenzas over 83"

Filing Reference

Filing for 24" depth units

13 1/8" Wide File Drawer - 16 1/16" Deep

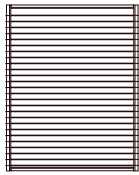

Letter Front to Back

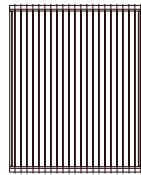

Legal Side to Side with File Rail

29" and 31" Lateral file drawer

26-1/2" Wide File Drawer - 16-1/16" Deep

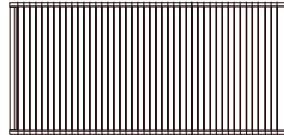

Legal Side to Side

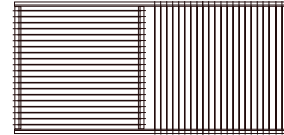

Legal Side to Side Letter Front to Back with File Rail

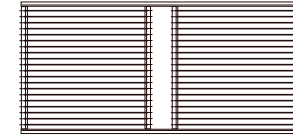

Letter Front to Back with File Rail

Filing for 30" & 36" depth units

13 1/8" Wide File Drawer - 19 11/16" Deep

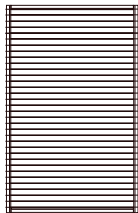

Letter Front to Back



Legal Side to Side with File Rail

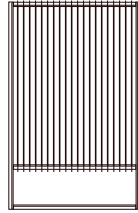

Letter Side to Side with File Rail

35" Lateral file drawer

32-1/2" Wide File Drawer - 16-1/16" Deep

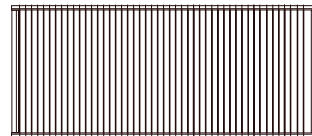

Legal Side to Side

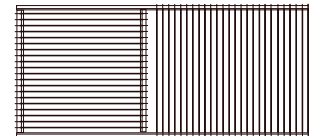

Legal Side to Side Letter Front to Back with File Rail

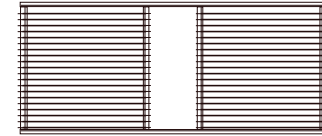

Letter Front to Back with File Rail

Capitol Park

Double Pedestal Desks
Executive / Breakfront

[Click here to view statement of line](#)

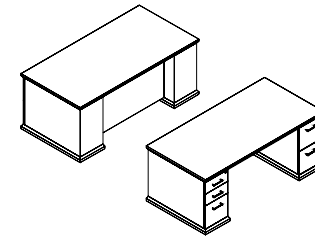

1 Select Model

w" x d" x h"	Weight
84 x 36 x 29	350
78 x 36 x 29	335
72 x 36 x 29	315
72 x 30 x 29	295
66 x 30 x 29	270
60 x 30 x 29	260

Standard Veneer Top Standard Veneer Chassis		Premium Veneer Top Premium Veneer Chassis		High Pressure Laminate Top Veneer Chassis		Thermally Fused Laminate Top Thermally Fused Laminate Chassis	
CAP8436DD000W	5247	"P" Option N/A		CAP8436DD000G	5247	"M" Option N/A	
CAP7836DD000W	5073	"P" Option N/A		CAP7836DD000G	5073	"M" Option N/A	
CAP7236DD000W	4898	"P" Option N/A		CAP7236DD000G	4898	"M" Option N/A	
CAP7230DD000W	4725	"P" Option N/A		CAP7230DD000G	4725	"M" Option N/A	
CAP6630DD000W	4578	"P" Option N/A		CAP6630DD000G	4578	"M" Option N/A	
CAP6030DD000W	4298	"P" Option N/A		CAP6030DD000G	4298	"M" Option N/A	

Product Features

- Box/Box/File- Left
- File/File - Right
- Full extension drawers - locking
- Hardwood base w/ mitred corners
- Legal/Letter Filing
- Soft close suspension drawer(s)

Notes

- 6" Recessed Modesty

Options

Accessories

- K28: Articulating keyboard w/ mouse pad - \$390
- K31: Center drawer - \$205
- PC10: Desk pedestal w/ wire cavity and access door - \$100

Drawer

- P6: Modify File/File to Box/Box/File - \$55
- P33: Wood Drawer Upgrade - \$45 per drawer

Grommets (Standard Location)

- Specify Color and Left/Right - \$50 ea.
- Black: TM30-R (Right), TM30-L (Left)
 - Silver: TM31-R (Right), TM31-L (Left)
 - Antique Brass: TM33-R (Right), TM33-L (Left)

Grommets (Non-Standard Location)

- Provide drawing w/ Grommet Location and Specify Color - \$95 ea.
- Black: TM30-NS
 - Silver: TM31-NS
 - Antique Brass: TM33-NS

Modesty

- M11: Breakfront Arch Modesty - \$205

2 Select Finish

[Click to view finishes](#)

- WAC
- WIC
- WHC
- WOC
- WEW
- WGW
- WBW
- WSW
- WNW

- GAC
- GIC
- GHC
- GOC
- GEW
- GNW

3 Select Edge

[Click to view edges](#)



4 Select Hardware

[Click to view details](#)

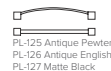
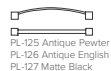

Capitol Park

Double Pedestal Desks
Bowfront / Breakfront

[Click here to view statement of line](#)

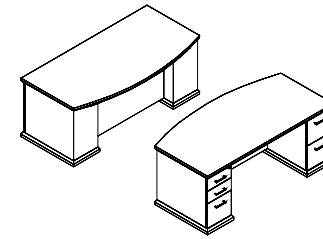

1 Select Model

w" x d" x h"	Weight
84 x 42 x 29	375
78 x 36/42 x 29	360
72 x 36/42 x 29	335
72 x 30/36 x 29	315
66 x 30/36 x 29	300

Standard Veneer Top Standard Veneer Chassis		Premium Veneer Top Premium Veneer Chassis		High Pressure Laminate Top Veneer Chassis		Thermally Fused Laminate Top Thermally Fused Laminate Chassis	
CAP8442DD006W	6086	"P" Option N/A		CAP8442DD006G	6086	"M" Option N/A	
CAP7842DD006W	5702	"P" Option N/A		CAP7842DD006G	5702	"M" Option N/A	
CAP7242DD006W	5301	"P" Option N/A		CAP7242DD006G	5301	"M" Option N/A	
CAP7236DD006W	5094	"P" Option N/A		CAP7236DD006G	5094	"M" Option N/A	
CAP6636DD006W	5001	"P" Option N/A		CAP6636DD006G	5001	"M" Option N/A	

2 Select Finish

[Click to view finishes](#)

- WAC
- WIC
- WHC
- WOC
- WEW
- WGW
- WBW
- WSW
- WNW

- GAC
- GIC
- GHC
- GOC
- GEW
- GNW

3 Select Edge

[Click to view edges](#)



4 Select Hardware

[Click to view details](#)

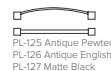
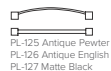

Product Features

- Box/Box/File (left)
- File/File - Right
- Full extension drawers - locking
- Hardwood base w/ mitred corners
- Legal/Letter Filing
- Soft close suspension drawer(s)

Notes

- 12" Recessed Modesty

Options

Accessories

- K28: Articulating keyboard w/ mouse pad - \$390
- K31: Center drawer - \$205
- PC10: Desk pedestal w/ wire cavity and access door - \$100

Drawer

- P6: Modify File/File to Box/Box/File - \$55
- P33: Wood Drawer Upgrade - \$45 per drawer

Grommets (Standard Location)

Specify Color and Left/Right - \$50 ea.

- Black: TM30-R (Right), TM30-L (Left)
- Silver: TM31-R (Right), TM31-L (Left)
- Antique Brass: TM33-R (Right), TM33-L (Left)

Grommets (Non-Standard Location)

Provide drawing w/ Grommet Location and Specify Color - \$95 ea.

- Black: TM30-NS
- Silver: TM31-NS
- Antique Brass: TM33-NS

Modesty

- M11: Breakfront Arch Modesty - \$205

Capitol Park

Workstation Desks
Breakfront - Single Pedestal

[Click here to view statement of line](#)

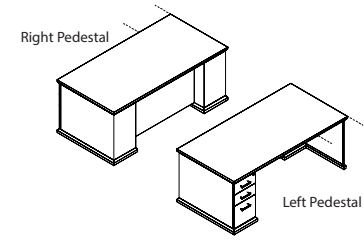

1 Select Model

w" x d" x h"

Weight	Standard Veneer Top Standard Veneer Chassis	Premium Veneer Top Premium Veneer Chassis	High Pressure Laminate Top Veneer Chassis	Thermally Fused Laminate Top Thermally Fused Laminate Chassis
Left Pedestal				
72 x 36 x 29	275	CAP7236DS009W 4386	"P" Option N/A	CAP7236DS009G 4386
72 x 30 x 29	255	CAP7230DS009W 4243	"P" Option N/A	CAP7230DS009G 4243
66 x 30 x 29	225	CAP6630DS009W 4149	"P" Option N/A	CAP6630DS009G 4149
Right Pedestal				
72 x 36 x 29	275	CAP7236DS010W 4386	"P" Option N/A	CAP7236DS010G 4386
72 x 30 x 29	255	CAP7230DS010W 4243	"P" Option N/A	CAP7230DS010G 4243
66 x 30 x 29	225	CAP6630DS010W 4149	"P" Option N/A	CAP6630DS010G 4149

2 Select Finish

[Click to view finishes](#)

- WAC
- WIC
- WHC
- WOC
- WEW
- WGW
- WBW
- WSW
- WNW

- GAC
- GIC
- GHC
- GOC
- GEW
- GNW

3 Select Edge

[Click to view edges](#)



4 Select Hardware

[Click to view details](#)



Product Features

- Box/Box/File
- Full extension drawers - locking
- Hardwood base w/ mitred corners
- Hookup hardware
- Legal/Letter Filing
- Soft close suspension drawer(s)

Notes

- 6" Recessed Modesty

Options

Accessories

- K28: Articulating keyboard w/ mouse pad - \$390
- K31: Center drawer - \$205
- PC10: Desk pedestal w/ wire cavity and access door - \$100

Drawer

- P33: Wood Drawer Upgrade - \$45 per drawer

Grommets (Standard Location)

Specify Color and Left/Right - \$50 ea.

- Black: TM30-R (Right), TM30-L (Left)
- Silver: TM31-R (Right), TM31-L (Left)
- Antique Brass: TM33-R (Right), TM33-L (Left)

Grommets (Non-Standard Location)

Provide drawing w/ Grommet Location and Specify Color - \$95 ea.

- Black: TM30-NS
- Silver: TM31-NS
- Antique Brass: TM33-NS

Modesty

- M11: Breakfront Arch Modesty - \$205

Capitol Park

Workstation Desks
Bowfront Breakfront - Single Pedestal

[Click here to view statement of line](#)

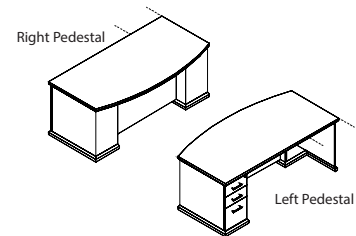

1 Select Model

w" x d" x h"

Weight		Standard Veneer Top Standard Veneer Chassis	Premium Veneer Top Premium Veneer Chassis	High Pressure Laminate Top Veneer Chassis	Thermally Fused Laminate Top Thermally Fused Laminate Chassis
Left Pedestal					
72 x 36/42 x 29	280	CAP7242DS017W 5128	"P" Option N/A	CAP7242DS017G 5128	"M" Option N/A
72 x 30/36 x 29	260	CAP7236DS017W 4850	"P" Option N/A	CAP7236DS017G 4850	"M" Option N/A
66 x 30/36 x 29	230	CAP6636DS017W 4768	"P" Option N/A	CAP6636DS017G 4768	"M" Option N/A
Right Pedestal					
72 x 36/42 x 29	280	CAP7242DS018W 5128	"P" Option N/A	CAP7242DS018G 5128	"M" Option N/A
72 x 30/36 x 29	260	CAP7236DS018W 4850	"P" Option N/A	CAP7236DS018G 4850	"M" Option N/A
66 x 30/36 x 29	230	CAP6636DS018W 4768	"P" Option N/A	CAP6636DS018G 4768	"M" Option N/A

Product Features

- Box/Box/File
- Full extension drawers - locking
- Hardwood base w/ mitred corners
- Hookup hardware
- Legal/Letter Filing
- Soft close suspension drawer(s)

Notes

- 12" Recessed Modesty

Options

Accessories

- K28: Articulating keyboard w/ mouse pad - \$390
- K31: Center drawer - \$205
- PC10: Desk pedestal w/ wire cavity and access door - \$100

Drawer

- P33: Wood Drawer Upgrade - \$45 per drawer

Grommets (Standard Location)

- Specify Color and Left/Right - \$50 ea.
- Black: TM30-R (Right), TM30-L (Left)
 - Silver: TM31-R (Right), TM31-L (Left)
 - Antique Brass: TM33-R (Right), TM33-L (Left)

Grommets (Non-Standard Location)

Provide drawing w/ Grommet Location and Specify Color - \$95 ea.

- Black: TM30-NS
- Silver: TM31-NS
- Antique Brass: TM33-NS

Modesty

- M11: Breakfront Arch Modesty - \$205

2 Select Finish

[Click to view finishes](#)

- WAC
- WIC
- WHC
- WOC
- WEW
- WGW
- WBW
- WSW
- WNW

- GAC
- GIC
- GHC
- GOC
- GEW
- GNW

3 Select Edge

[Click to view edges](#)



4 Select Hardware

[Click to view details](#)

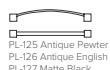
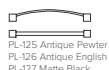

Capitol Park

Workstation Desks

Conference Overhang Breakfront - Single Pedestal

[Click here to view statement of line](#)

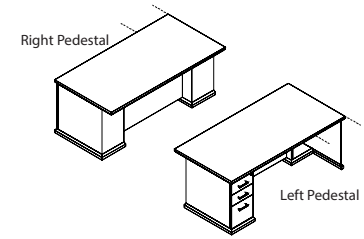

1 Select Model

w" x d" x h"

Weight	Model	Weight	Model
Left Pedestal			
72 x 36 x 29	255	CAP7236DS634W	4208
66 x 36 x 29	245	CAP6636DS634W	4033
Right Pedestal			
72 x 36 x 29	255	CAP7236DS633W	4208
66 x 36 x 29	245	CAP6636DS633W	4033

	Standard Veneer Top Standard Veneer Chassis	Premium Veneer Top Premium Veneer Chassis	High Pressure Laminate Top Veneer Chassis	Thermally Fused Laminate Top Thermally Fused Laminate Chassis
		"P" Option N/A	CAP7236DS634G 4208 CAP6636DS634G 4033	"M" Option N/A "M" Option N/A
		"P" Option N/A	CAP7236DS633G 4208 CAP6636DS633G 4033	"M" Option N/A "M" Option N/A

Product Features

- Box/Box/File
- Full extension drawers - locking
- Hardwood base w/ mitred corners
- Hookup hardware
- Legal/Letter Filing
- Soft close suspension drawer(s)

Notes

- 12" Recessed Modesty
- 66" wide unit - 66 x 30 Chassis
- 72" wide unit - 72 x 30 Chassis

Options

Accessories

- K28: Articulating keyboard w/ mouse pad - \$390
- K31: Center drawer - \$205
- PC10: Desk pedestal w/ wire cavity and access door - \$100

Drawer

- P33: Wood Drawer Upgrade - \$45 per drawer

Grommets (Standard Location)

Specify Color and Left/Right - \$50 ea.

- Black: TM30-R (Right), TM30-L (Left)
- Silver: TM31-R (Right), TM31-L (Left)
- Antique Brass: TM33-R (Right), TM33-L (Left)

Grommets (Non-Standard Location)

Provide drawing w/ Grommet Location and Specify Color - \$95 ea.

- Black: TM30-NS
- Silver: TM31-NS
- Antique Brass: TM33-NS

Modesty

- M11: Breakfront Arch Modesty - \$205

2 Select Finish

[Click to view finishes](#)

- WAC
- WIC
- WHC
- WOC
- WEW
- WGW
- WBW
- WSW
- WNW

- GAC
- GIC
- GHC
- GOC
- GEW
- GNW

3 Select Edge

[Click to view edges](#)



4 Select Hardware

[Click to view details](#)

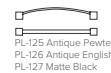
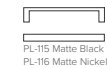
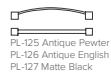

Capitol Park

"L" Workstation Returns
File/File

[Click here to view statement of line](#)

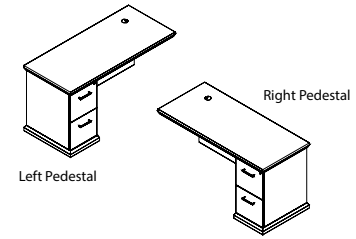

1 Select Model

w" x d" x h"
Left Pedestal
66 x 24 x 29
60 x 24 x 29
54 x 24 x 29
48 x 24 x 29
42 x 24 x 29
Right Pedestal
66 x 24 x 29
60 x 24 x 29
54 x 24 x 29
48 x 24 x 29
42 x 24 x 29

Weight	Standard Veneer Top Standard Veneer Chassis	Premium Veneer Top Premium Veneer Chassis	High Pressure Laminate Top Veneer Chassis	Thermally Fused Laminate Top Thermally Fused Laminate Chassis
175	CAP6624RE195W 3375	"P" Option N/A	CAP6624RE195G 3375	"M" Option N/A
165	CAP6024RE195W 3282	"P" Option N/A	CAP6024RE195G 3282	"M" Option N/A
155	CAP5424RE195W 3199	"P" Option N/A	CAP5424RE195G 3199	"M" Option N/A
145	CAP4824RE195W 3108	"P" Option N/A	CAP4824RE195G 3108	"M" Option N/A
135	CAP4224RE195W 3025	"P" Option N/A	CAP4224RE195G 3025	"M" Option N/A
175	CAP6624RE196W 3375	"P" Option N/A	CAP6624RE196G 3375	"M" Option N/A
165	CAP6024RE196W 3282	"P" Option N/A	CAP6024RE196G 3282	"M" Option N/A
155	CAP5424RE196W 3199	"P" Option N/A	CAP5424RE196G 3199	"M" Option N/A
145	CAP4824RE196W 3108	"P" Option N/A	CAP4824RE196G 3108	"M" Option N/A
135	CAP4224RE196W 3025	"P" Option N/A	CAP4224RE196G 3025	"M" Option N/A

2 Select Finish

[Click to view finishes](#)

WAC
WIC
WHC
WOC
WEW
WGW
WBW
WSW
WNW

GAC
GIC
GHC
GOC
GEW
GNW

3 Select Edge

[Click to view edges](#)



4 Select Hardware

[Click to view details](#)



Product Features

- 1 Standard grommet - matches pull finish or specify black TM30, silver TM31 or antique brass TM33
- Fixed full modesty
- Full extension drawers - locking
- Hardwood base w/ mitred corners
- Hookup hardware
- Soft close suspension drawer(s)

Options

Accessories

- K28: Articulating keyboard w/ mouse pad - \$390

Drawer

- P6: Modify File/File to Box/Box/File - \$55
- P33: Wood Drawer Upgrade - \$45 per drawer

Flush Cut

- FC-L: Flush Unit Left (Facing) for Ganging - \$100
- FC-R: Flush Unit Right(Facing) for Ganging - \$100

Grommets (Non-Standard Location)

- Provide drawing w/ Grommet Location and Specify Color - \$95 ea.
- Black: TM30-NS
- Silver: TM31-NS
- Antique Brass: TM33-NS

Modesty

- M34T: Drop Door Tech Modesty - \$130
- M51: Open Back Modesty with Wire Mgmt Rail - Deduct \$95

Capitol Park
 "L" Workstation Returns
 Lateral File

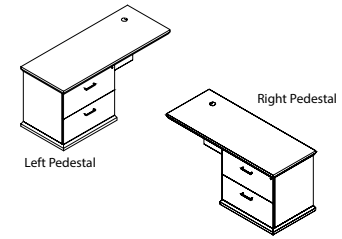

[Click here to view statement of line](#)

1 Select Model

w" x d" x h"

Left Pedestal

72 x 24 x 29	200
66 x 24 x 29	190
60 x 24 x 29	185
54 x 24 x 29	180
48 x 24 x 29	175

Right Pedestal

72 x 24 x 29	200
66 x 24 x 29	190
60 x 24 x 29	185
54 x 24 x 29	180
48 x 24 x 29	175

Weight

Standard Veneer Top Standard Veneer Chassis	Premium Veneer Top Premium Veneer Chassis	High Pressure Laminate Top Veneer Chassis	Thermally Fused Laminate Top Thermally Fused Laminate Chassis
CAP7224RE187W 3902	"P" Option N/A	CAP7224RE187G 3902	"M" Option N/A
CAP6624RE187W 3725	"P" Option N/A	CAP6624RE187G 3725	"M" Option N/A
CAP6024RE187W 3635	"P" Option N/A	CAP6024RE187G 3635	"M" Option N/A
CAP5424RE187W 3550	"P" Option N/A	CAP5424RE187G 3550	"M" Option N/A
CAP4824RE187W 3458	"P" Option N/A	CAP4824RE187G 3458	"M" Option N/A
CAP7224RE188W 3902	"P" Option N/A	CAP7224RE188G 3902	"M" Option N/A
CAP6624RE188W 3725	"P" Option N/A	CAP6624RE188G 3725	"M" Option N/A
CAP6024RE188W 3635	"P" Option N/A	CAP6024RE188G 3635	"M" Option N/A
CAP5424RE188W 3550	"P" Option N/A	CAP5424RE188G 3550	"M" Option N/A
CAP4824RE188W 3458	"P" Option N/A	CAP4824RE188G 3458	"M" Option N/A

Product Features

- 1 Standard grommet - matches pull finish or specify black TM30, silver TM31 or antique brass TM33
- Fixed full modesty
- Hardwood base w/ mitred corners
- Hookup hardware
- Features ball bearing suspensions, suspensions are full extension.

Notes

- K28 Keyboards not available on 48" units

Options

Accessories

- K28: Articulating keyboard w/ mouse pad - \$390

Drawer

- P33: Wood Drawer Upgrade - \$45 per drawer

Flush Cut

- FC-L: Flush Unit Left (Facing) for Ganging - \$100
- FC-R: Flush Unit Right(Facing) for Ganging - \$100

Grommets (Non-Standard Location)

Provide drawing w/ Grommet Location and Specify Color - \$95 ea.

- Black: TM30-NS
- Silver: TM31-NS
- Antique Brass: TM33-NS

Modesty

- M34T: Drop Door Tech Modesty - \$130
- M51: Open Back Modesty with Wire Mgmt Rail - Deduct \$95

2 Select Finish

[Click to view finishes](#)

- WAC
- WIC
- WHC
- WOC
- WEW
- WGW
- WBW
- WSW
- WNW

- GAC
- GIC
- GHC
- GOC
- GEW
- GNW

3 Select Edge

[Click to view edges](#)



4 Select Hardware

[Click to view details](#)

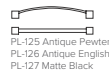
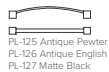

Capitol Park

"L" Workstation Returns
Box/Box/File/Lateral

[Click here to view statement of line](#)

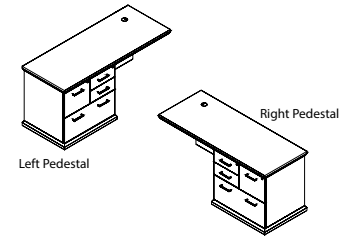

1 Select Model

w" x d" x h"	Weight
Left Pedestal	
72 x 24 x 29	225
66 x 24 x 29	190
60 x 24 x 29	185
54 x 24 x 29	180
48 x 24 x 29	175
Right Pedestal	
72 x 24 x 29	225
66 x 24 x 29	190
60 x 24 x 29	185
54 x 24 x 29	180
48 x 24 x 29	175

Standard Veneer Top Standard Veneer Chassis		Premium Veneer Top Premium Veneer Chassis		High Pressure Laminate Top Veneer Chassis		Thermally Fused Laminate Top Thermally Fused Laminate Chassis	
CAP7224RE218W	4250	"P" Option N/A		CAP7224RE218G	4250	"M" Option N/A	
CAP6624RE218W	4075	"P" Option N/A		CAP6624RE218G	4075	"M" Option N/A	
CAP6024RE218W	3982	"P" Option N/A		CAP6024RE218G	3982	"M" Option N/A	
CAP5424RE218W	3902	"P" Option N/A		CAP5424RE218G	3902	"M" Option N/A	
CAP4824RE218W	3809	"P" Option N/A		CAP4824RE218G	3809	"M" Option N/A	
CAP7224RE219W	4250	"P" Option N/A		CAP7224RE219G	4250	"M" Option N/A	
CAP6624RE219W	4075	"P" Option N/A		CAP6624RE219G	4075	"M" Option N/A	
CAP6024RE219W	3982	"P" Option N/A		CAP6024RE219G	3982	"M" Option N/A	
CAP5424RE219W	3902	"P" Option N/A		CAP5424RE219G	3902	"M" Option N/A	
CAP4824RE219W	3809	"P" Option N/A		CAP4824RE219G	3809	"M" Option N/A	

2 Select Finish

[Click to view finishes](#)

- WAC
- WIC
- WHC
- WOC
- WEW
- WGW
- WBW
- WSW
- WNW

- GAC
- GIC
- GHC
- GOC
- GEW
- GNW

3 Select Edge

[Click to view edges](#)



4 Select Hardware

[Click to view details](#)



Product Features

- 1 Standard grommet - matches pull finish or specify black TM30, silver TM31 or antique brass TM33
- Fixed full modesty
- "W" & "G" Box and File Drawers feature soft close suspensions (Lateral Drawers Feature ball bearing suspensions), suspensions are full extension.
- Hardwood base w/ mitred corners
- Hookup hardware
- Soft close suspension drawer(s)

Notes

- K28 Keyboards not available on 48" units

Options

Accessories

- K28: Articulating keyboard w/ mouse pad - \$390

Drawer

- P33: Wood Drawer Upgrade - \$45 per drawer

Flush Cut

- FC-L: Flush Unit Left (Facing) for Ganging - \$100
- FC-R: Flush Unit Right(Facing) for Ganging - \$100

Grommets (Non-Standard Location)

Provide drawing w/ Grommet Location and Specify Color - \$95 ea.

- Black: TM30-NS
- Silver: TM31-NS
- Antique Brass: TM33-NS

Modesty

- M34T: Drop Door Tech Modesty - \$130
- M5t: Open Back Modesty with Wire Mgmt Rail - Deduct \$95

Capitol Park

Workstation Bridges
Open Back

[Click here to view statement of line](#)

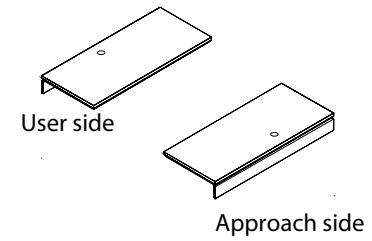

1 Select Model

w" x d" x h"	Weight
48 x 24 x 29	55
42 x 24 x 29	50
36 x 24 x 29	45

Standard Veneer Top Standard Veneer Chassis	Premium Veneer Top Premium Veneer Chassis	High Pressure Laminate Top Veneer Chassis	Thermally Fused Laminate Top Thermally Fused Laminate Chassis												
<table border="1"> <tr> <td>CAP4824BR151W</td> <td>977</td> </tr> <tr> <td>CAP4224BR151W</td> <td>928</td> </tr> <tr> <td>CAP3624BR151W</td> <td>880</td> </tr> </table>	CAP4824BR151W	977	CAP4224BR151W	928	CAP3624BR151W	880	<p>"P" Option N/A "P" Option N/A "P" Option N/A</p>	<table border="1"> <tr> <td>CAP4824BR151G</td> <td>977</td> </tr> <tr> <td>CAP4224BR151G</td> <td>928</td> </tr> <tr> <td>CAP3624BR151G</td> <td>880</td> </tr> </table>	CAP4824BR151G	977	CAP4224BR151G	928	CAP3624BR151G	880	<p>"M" Option N/A "M" Option N/A "M" Option N/A</p>
CAP4824BR151W	977														
CAP4224BR151W	928														
CAP3624BR151W	880														
CAP4824BR151G	977														
CAP4224BR151G	928														
CAP3624BR151G	880														

Product Features

- 1 Standard grommet - matches pull finish or specify black TM30, silver TM31 or antique brass TM33

Options

Accessories

- K28: Articulating keyboard w/ mouse pad - \$390

Grommets (Non-Standard Location)

Provide drawing w/ Grommet Location and Specify Color - \$95 ea.

- Black: TM30-NS

- Silver: TM31-NS

- Antique Brass: TM33-NS

Modesty

- M34T-O: Drop Door Tech Modesty - \$295

- M37: Fixed Full Modesty - \$130

2 Select Finish

[Click to view finishes](#)

- WAC
- WIC
- WHC
- WOC
- WEW
- WGW
- WBW
- WSW
- WNW

- GAC
- GIC
- GHC
- GOC
- GEW
- GNW

3 Select Edge

[Click to view edges](#)



4 Select Hardware

[Click to view details](#)

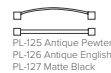
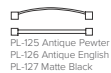

Capitol Park

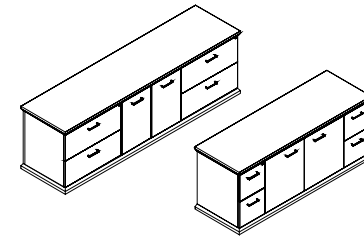

Credenzas
File / Storage

[Click here to view statement of line](#)



1 Select Model

w" x d" x h"	Weight
Lateral File / Storage	
94 x 24 x 29	350
88 x 24 x 29	320
File / Storage	
71 x 24 x 29	270
65 x 24 x 29	255
59 x 24 x 29	240

	Standard Veneer Top Standard Veneer Chassis	Premium Veneer Top Premium Veneer Chassis	High Pressure Laminate Top Veneer Chassis	Thermally Fused Laminate Top Thermally Fused Laminate Chassis
	CAP9424CA651W 8149	"P" Option N/A	CAP9424CA651G 8149	"M" Option N/A
	CAP8824CA651W 7798	"P" Option N/A	CAP8824CA651G 7798	"M" Option N/A
	CAP7124CA050W 4817	"P" Option N/A	CAP7124CA050G 4817	"M" Option N/A
	CAP6524CA050W 4501	"P" Option N/A	CAP6524CA050G 4501	"M" Option N/A
	CAP5924CA050W 4328	"P" Option N/A	CAP5924CA050G 4328	"M" Option N/A
			GAC GIC GHC GOC GEW GNW	
			 Capitol	
				
				

2 Select Finish

[Click to view finishes](#)

- WAC
- WIC
- WHC
- WOC
- WEW
- WGW
- WBW
- WSW
- WNW

3 Select Edge

[Click to view edges](#)



4 Select Hardware

[Click to view details](#)



Product Features

- Black laminate adjustable shelf behind doors
- Hardwood base w/ mitred corners
- Top shaped on 3 sides
- "W" & "G" Box and File Drawers feature soft close suspensions (Lateral Drawers Feature ball bearing suspensions). Both suspensions are full extension.

Notes

- Unit has black back panel and is not designed for Open Plan use. Select OPB Option for Open Plan application

Options

Door

- D2: Door Lock - \$100 per door set
- D6A: "W"/"G" Styles - Delete Doors and replace black laminate shelf with finished shelf - n/c
- D9SC: Soft Close Door Hinges - \$20 per door

Drawer

- P6: Modify File/File to Box/Box/File - \$55 ea.
- P33: Wood Drawer Upgrade - \$45 per drawer

Flush Cut

- FC-B: Flush Unit Both Sides(Facing) for Ganging - \$100
- FC-L: Flush Unit Left (Facing) for Ganging - \$100
- FC-R: Flush Unit Right(Facing) for Ganging - \$100

Grommets (Standard Location)

- Specify Color and Left/Right/Center - \$50 ea.
- Black: TM30-R (Right), TM30-L (Left), TM30-C (Center)
- Silver: TM31-R (Right), TM31-L (Left), TM31-C (Center)
- Antique Brass: TM33-R (Right), TM33-L (Left), TM33-C (Center)

Grommets (Non-Standard Location)

- Provide drawing w/ Grommet Location and Specify Color - \$95 ea.
- Black: TM30-NS
- Silver: TM31-NS
- Antique Brass: TM33-NS

Open Plan _ Finished Back

- OPB:Modify Unit for Open Plan Application - \$295

Shelves

- S25: Replace Black Laminate Shelves with Finished Shelves - \$80 per shelf

Capitol Park

Credenzas
Kneespace

[Click here to view statement of line](#)

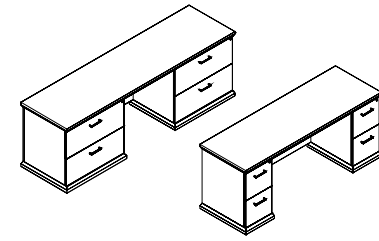

1 Select Model

w" x d" x h"	Weight
Lateral File / Lateral File	
94 x 24 x 29	325
88 x 24 x 29	300
File / File	
78 x 24 x 29	250
71 x 24 x 29	225
65 x 24 x 29	210
59 x 24 x 29	200

Standard Veneer Top Standard Veneer Chassis	Premium Veneer Top Premium Veneer Chassis	High Pressure Laminate Top Veneer Chassis	Thermally Fused Laminate Top Thermally Fused Laminate Chassis
CAP9424CA052W 6046	"P" Option N/A	CAP9424CA052G 6046	"M" Option N/A
CAP8824CA052W 5695	"P" Option N/A	CAP8824CA052G 5695	"M" Option N/A
CAP7824CA054W 4644	"P" Option N/A	CAP7824CA054G 4644	"M" Option N/A
CAP7124CA054W 4467	"P" Option N/A	CAP7124CA054G 4467	"M" Option N/A
CAP6524CA054W 4208	"P" Option N/A	CAP6524CA054G 4208	"M" Option N/A
CAP5924CA054W 4116	"P" Option N/A	CAP5924CA054G 4116	"M" Option N/A

2 Select Finish

[Click to view finishes](#)

- WAC
- WIC
- WHC
- WOC
- WEW
- WGW
- WBW
- WSW
- WNW

- GAC
- GIC
- GHC
- GOC
- GEW
- GNW

3 Select Edge

[Click to view edges](#)



4 Select Hardware

[Click to view details](#)



Product Features

- Fixed full modesty
- Hardwood base w/ mitred corners
- "W" & "G" Box and File Drawers feature soft close suspensions (Lateral Drawers Feature ball bearing suspensions). Both suspensions are full extension.
- Top shaped on 3 sides

Notes

- Unit has black back panel and is not designed for Open Plan use. Select OPB Option for Open Plan application

Options

Accessories

- K28: Articulating keyboard w/ mouse pad - \$390

Drawer

- P6: Modify File/File to Box/Box/File - \$55 ea.
- P33: Wood Drawer Upgrade - \$45 per drawer

Flush Cut

- FC-B: Flush Unit Both Sides(Facing) for Ganging - \$100
- FC-L: Flush Unit Left (Facing) for Ganging - \$100
- FC-R: Flush Unit Right(Facing) for Ganging - \$100

Grommets (Standard Location)

- Specify Color - \$50 ea.
- Black: TM30-C (Center)
- Silver: TM31-C (Center)
- Antique Brass: TM33-C (Center)

Grommets (Non-Standard Location)

- Provide drawing w/ Grommet Location and Specify Color - \$95 ea.
- Black: TM30-NS
- Silver: TM31-NS
- Antique Brass: TM33-NS

Modesty

- M34T: Drop Door Tech Modesty - \$130
- M51: Open Back Modesty with Wire Mgmt Rail - Deduct \$95

Open Plan _ Finished Back

- OPB: Modify Unit for Open Plan Application - \$295

Capitol Park

Credenzas
Storage

[Click here to view statement of line](#)

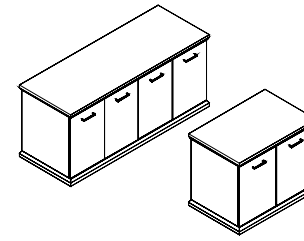

1 Select Model

w" x d" x h"

	Weight	Standard Veneer Top Standard Veneer Chassis	Premium Veneer Top Premium Veneer Chassis	High Pressure Laminate Top Veneer Chassis	Thermally Fused Laminate Top Thermally Fused Laminate Chassis
4 Door					
71 x 24 x 29	250	CAP7124CA125W 4644	"P" Option N/A	CAP7124CA125G 4644	"M" Option N/A
65 x 24 x 29	235	CAP6524CA125W 4328	"P" Option N/A	CAP6524CA125G 4328	"M" Option N/A
59 x 24 x 29	220	CAP5924CA125W 4149	"P" Option N/A	CAP5924CA125G 4149	"M" Option N/A
2 Door					
36 x 24 x 29	140	CAP3624CA125W 2540	"P" Option N/A	CAP3624CA125G 2540	"M" Option N/A
30 x 24 x 29	125	CAP3024CA125W 2365	"P" Option N/A	CAP3024CA125G 2365	"M" Option N/A

2 Select Finish

[Click to view finishes](#)

- WAC
- WIC
- WHC
- WOC
- WEW
- WGW
- WBW
- WSW
- WNW

- GAC
- GIC
- GHC
- GOC
- GEW
- GNW

3 Select Edge

[Click to view edges](#)



4 Select Hardware

[Click to view details](#)

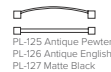
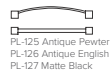

Product Features

- Adjustable shelf per door section (black laminate)
- Anti-tilt safety feature
- Hardwood base w/ mitred corners
- Top shaped on 3 sides

Notes

- Unit has black back panel and is not designed for Open Plan use. Select OPB Option for Open Plan application

Options

Door

- D2: Door Lock - \$100 per door set
- D6A: "W"/"G" Styles - Delete Doors and replace black laminate shelf with finished shelf - n/c
- D9SC: Soft Close Door Hinges - \$20 per door

Flush Cut

- FC-B: Flush Unit Both Sides(Facing) for Ganging - \$100
- FC-L: Flush Unit Left (Facing) for Ganging - \$100
- FC-R: Flush Unit Right(Facing) for Ganging - \$100

Grommets (Standard Location)

- Specify Color and Left/Right/Center - \$50 ea.
- Black: TM30-R (Right), TM30-L (Left), TM30-C (Center)
- Silver: TM31-R (Right), TM31-L (Left), TM31-C (Center)
- Antique Brass: TM33-R (Right), TM33-L (Left), TM33-C (Center)

Open Plan _ Finished Back

- OPB:Modify Unit for Open Plan Application - \$295

Shelves

- S25: Replace Black Laminate Shelves with Finished Shelves - \$80 per shelf

Capitol Park

Lateral File Credenzas
6/4/2 Drawers

[Click here to view statement of line](#)

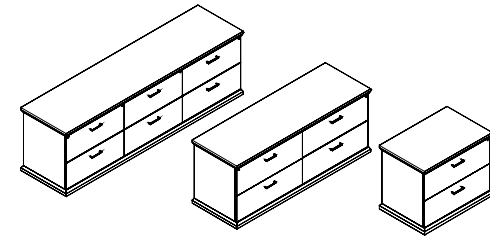

1 Select Model

w" x d" x h"

Weight

		Standard Veneer Top Standard Veneer Chassis		Premium Veneer Top Premium Veneer Chassis		High Pressure Laminate Top Veneer Chassis		Thermally Fused Laminate Top Thermally Fused Laminate Chassis	
6 Drawer									
94 x 24 x 29	415	CAP9424CA104W	8323	"P" Option N/A		CAP9424CA104G	8323	"M" Option N/A	
88 x 24 x 29	390	CAP8824CA104W	7971	"P" Option N/A		CAP8824CA104G	7971	"M" Option N/A	
4 Drawer									
71 x 24 x 29	315	CAP7124CA104W	5203	"P" Option N/A		CAP7124CA104G	5203	"M" Option N/A	
59 x 24 x 29	285	CAP5924CA104W	5029	"P" Option N/A		CAP5924CA104G	5029	"M" Option N/A	
2 Drawer									
36 x 24 x 29	165	CAP3624CA104W	2723	"P" Option N/A		CAP3624CA104G	2723	"M" Option N/A	
30 x 24 x 29	150	CAP3024CA104W	2582	"P" Option N/A		CAP3024CA104G	2582	"M" Option N/A	

Product Features

- Full extension drawers - locking
- Hardwood base w/ mitred corners
- Features ball bearing suspensions, suspensions are full extension
- Top shaped on 3 sides

Notes

- Unit has black back panel and is not designed for Open Plan use. Select OPB Option for Open Plan application

Options

Drawer

- P33: Wood Drawer Upgrade - \$45 per drawer

Flush Cut

- FC-B: Flush Unit Both Sides(Facing) for Ganging - \$100
- FC-L: Flush Unit Left (Facing) for Ganging - \$100
- FC-R: Flush Unit Right(Facing) for Ganging - \$100

Open Plan _ Finished Back

- OPB:Modify Unit for Open Plan Application - \$295

2 Select Finish

[Click to view finishes](#)

- WAC
- WIC
- WHC
- WOC
- WEW
- WGW
- WBW
- WSW
- WNW

- GAC
- GIC
- GHC
- GOC
- GEW
- GNW

3 Select Edge

[Click to view edges](#)



4 Select Hardware

[Click to view details](#)

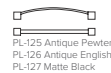
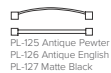

Capitol Park

Lateral File

Vertical Lateral File

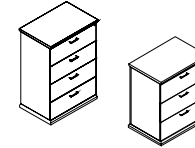

[Click here to view statement of line](#)

1 Select Model

w" x d" x h"

Weight	Model	Weight	Model	Option	Model	Weight	Option
4 Drawer							
36 x 24 x 52	270	CAP3624FI111W	4501	"P" Option N/A	CAP3624FI111G	4501	"M" Option N/A
30 x 24 x 52	245	CAP3024FI111W	4386	"P" Option N/A	CAP3024FI111G	4386	"M" Option N/A
3 Drawer							
36 x 24 x 42	205	CAP3624FI112W	3926	"P" Option N/A	CAP3624FI112G	3926	"M" Option N/A
30 x 24 x 42	185	CAP3024FI112W	3822	"P" Option N/A	CAP3024FI112G	3822	"M" Option N/A

Standard Veneer Top Standard Veneer Chassis	Premium Veneer Top Premium Veneer Chassis	High Pressure Laminate Top Veneer Chassis	Thermally Fused Laminate Top Thermally Fused Laminate Chassis
--	--	--	--

Product Features

- Anti-tilt safety feature
- Hardwood base w/ mitred corners
- Features ball bearing suspensions, suspensions are full extension
- Top shaped on 3 sides

Notes

- Unit has black back panel and is not designed for Open Plan use. Select OPB Option for Open Plan application

Options

Drawer

- P33: Wood Drawer Upgrade - \$45 per drawer

Flush Cut

- FC-B: Flush Unit Both Sides(Facing) for Ganging - \$100
- FC-L: Flush Unit Left (Facing) for Ganging - \$100
- FC-R: Flush Unit Right(Facing) for Ganging - \$100

Open Plan _ Finished Back

- OPB:Modify Unit for Open Plan Application - \$295

2 Select Finish

[Click to view finishes](#)

- WAC
- WIC
- WHC
- WOC
- WEW
- WGW
- WBW
- WSW
- WNW

- GAC
- GIC
- GHC
- GOC
- GEW
- GNW

3 Select Edge

[Click to view edges](#)



4 Select Hardware

[Click to view details](#)

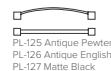
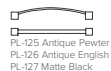

Capitol Park
Workstation Credenzas
File/File

[Click here to view statement of line](#)

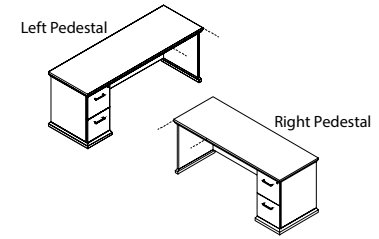

1 Select Model

w" x d" x h"	Weight
Left Pedestal	
88 x 24 x 29	200
71 x 24 x 29	175
65 x 24 x 29	165
59 x 24 x 29	155
Right Pedestal	
88 x 24 x 29	200
71 x 24 x 29	175
65 x 24 x 29	165
59 x 24 x 29	155

Standard Veneer Top Standard Veneer Chassis		Premium Veneer Top Premium Veneer Chassis		High Pressure Laminate Top Veneer Chassis		Thermally Fused Laminate Top Thermally Fused Laminate Chassis	
CAP8824CA086W	3982	"P" Option N/A		CAP8824CA086G	3982	"M" Option N/A	
CAP7124CA086W	3601	"P" Option N/A		CAP7124CA086G	3601	"M" Option N/A	
CAP6524CA086W	3517	"P" Option N/A		CAP6524CA086G	3517	"M" Option N/A	
CAP5924CA086W	3425	"P" Option N/A		CAP5924CA086G	3425	"M" Option N/A	
CAP8824CA087W	3982	"P" Option N/A		CAP8824CA087G	3982	"M" Option N/A	
CAP7124CA087W	3601	"P" Option N/A		CAP7124CA087G	3601	"M" Option N/A	
CAP6524CA087W	3517	"P" Option N/A		CAP6524CA087G	3517	"M" Option N/A	
CAP5924CA087W	3425	"P" Option N/A		CAP5924CA087G	3425	"M" Option N/A	

Product Features

- Fixed full modesty
- Full extension drawers - locking
- Hookup hardware
- Soft close suspension drawer(s)

Notes

- Unit has black back panel and is not designed for Open Plan use. Select OPB Option for Open Plan application

Options

Accessories

- K28: Articulating keyboard w/ mouse pad - \$390

Drawer

- P6: Modify File/File to Box/Box/File - \$55
- P33: Wood Drawer Upgrade - \$45 per drawer

Flush Cut

- FC-L: Flush Unit Left (Facing) for Ganging - \$100
- FC-R: Flush Unit Right(Facing) for Ganging - \$100

Grommets (Standard Location)

- Specify Color - \$50 ea.
- Black: TM30-C (Center)
- Silver: TM31-C (Center)
- Antique Brass: TM33-C (Center)

Grommets (Non-Standard Location)

- Provide drawing w/ Grommet Location and Specify Color - \$95 ea.
- Black: TM30-NS
- Silver: TM31-NS
- Antique Brass: TM33-NS

Modesty

- M34T: Drop Door Tech Modesty - \$130
- M51: Open Back Modesty with Wire Mgmt Rail - Deduct \$95

Open Plan _ Finished Back

- OPB: Modify Unit for Open Plan Application - \$295

2 Select Finish

[Click to view finishes](#)

- WAC
- WIC
- WHC
- WOC
- WEW
- WGW
- WBW
- WSW
- WNW

- GAC
- GIC
- GHC
- GOC
- GEW
- GNW

3 Select Edge

[Click to view edges](#)



4 Select Hardware

[Click to view details](#)

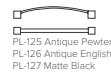
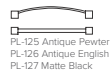

Capitol Park
Workstation Credenzas
Lateral File

[Click here to view statement of line](#)

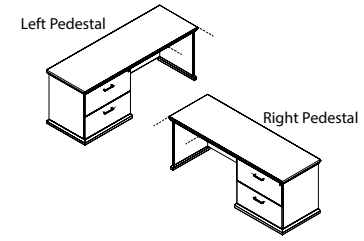

1 Select Model

w" x d" x h"

Left Pedestal

Weight	Standard Veneer Top Standard Veneer Chassis	Premium Veneer Top Premium Veneer Chassis	High Pressure Laminate Top Veneer Chassis	Thermally Fused Laminate Top Thermally Fused Laminate Chassis
94 x 24 x 29	240 CAP9424CA066W 4644	"P" Option N/A	CAP9424CA066G 4644	"M" Option N/A
88 x 24 x 29	220 CAP8824CA066W 4294	"P" Option N/A	CAP8824CA066G 4294	"M" Option N/A
71 x 24 x 29	215 CAP7124CA066W 3941	"P" Option N/A	CAP7124CA066G 3941	"M" Option N/A
65 x 24 x 29	200 CAP6524CA066W 3859	"P" Option N/A	CAP6524CA066G 3859	"M" Option N/A
59 x 24 x 29	190 CAP5924CA066W 3768	"P" Option N/A	CAP5924CA066G 3768	"M" Option N/A

Right Pedestal

94 x 24 x 29	240 CAP9424CA067W 4644	"P" Option N/A	CAP9424CA067G 4644	"M" Option N/A
88 x 24 x 29	220 CAP8824CA067W 4294	"P" Option N/A	CAP8824CA067G 4294	"M" Option N/A
71 x 24 x 29	215 CAP7124CA067W 3941	"P" Option N/A	CAP7124CA067G 3941	"M" Option N/A
65 x 24 x 29	200 CAP6524CA067W 3859	"P" Option N/A	CAP6524CA067G 3859	"M" Option N/A
59 x 24 x 29	190 CAP5924CA067W 3768	"P" Option N/A	CAP5924CA067G 3768	"M" Option N/A

2 Select Finish

[Click to view finishes](#)

- WAC
- WIC
- WHC
- WOC
- WEW
- WGW
- WBW
- WSW
- WNW

- GAC
- GIC
- GHC
- GOC
- GEW
- GNW

3 Select Edge

[Click to view edges](#)



4 Select Hardware

[Click to view details](#)



Product Features

- Fixed full modesty
- Hookup hardware
- Features ball bearing suspensions, suspensions are full extension

Notes

- K28 Keyboard not available on 71", 65", and 59" units
- Unit has black back panel and is not designed for Open Plan use. Select OPB Option for Open Plan application

Options

Accessories

- K28: Articulating keyboard w/ mouse pad - \$390

Drawer

- P33: Wood Drawer Upgrade - \$45 per drawer

Flush Cut

- FC-L: Flush Unit Left (Facing) for Ganging - \$100
- FC-R: Flush Unit Right(Facing) for Ganging - \$100

Grommets (Standard Location)

Specify Color - \$50 ea.

- Black: TM30-C (Center)
- Silver: TM31-C (Center)
- Antique Brass: TM33-C (Center)

Grommets (Non-Standard Location)

Provide drawing w/ Grommet Location and Specify Color - \$95 ea.

- Black: TM30-NS
- Silver: TM31-NS
- Antique Brass: TM33-NS

Modesty

- M34T:Drop Door Tech Modesty - \$130
- M51: Open Back Modesty with Wire Mgmt Rail - Deduct \$95

Open Plan _ Finished Back

- OPB:Modify Unit for Open Plan Application - \$295

Capitol Park

Workstation Credenzas
Box/Box/File/Lateral

[Click here to view statement of line](#)

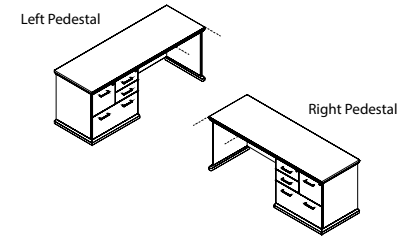

1 Select Model

w" x d" x h"

Weight	Standard Veneer Top Standard Veneer Chassis	Premium Veneer Top Premium Veneer Chassis	High Pressure Laminate Top Veneer Chassis	Thermally Fused Laminate Top Thermally Fused Laminate Chassis
Left Pedestal				
94 x 24 x 29	240 CAP9424CA667W 4994	"P" Option N/A	CAP9424CA667G 4994	"M" Option N/A
88 x 24 x 29	220 CAP8824CA667W 4644	"P" Option N/A	CAP8824CA667G 4644	"M" Option N/A
71 x 24 x 29	215 CAP7124CA667W 4294	"P" Option N/A	CAP7124CA667G 4294	"M" Option N/A
65 x 24 x 29	200 CAP6524CA667W 4208	"P" Option N/A	CAP6524CA667G 4208	"M" Option N/A
59 x 24 x 29	190 CAP5924CA667W 4116	"P" Option N/A	CAP5924CA667G 4116	"M" Option N/A
Right Pedestal				
94 x 24 x 29	240 CAP9424CA668W 4994	"P" Option N/A	CAP9424CA668G 4994	"M" Option N/A
88 x 24 x 29	220 CAP8824CA668W 4644	"P" Option N/A	CAP8824CA668G 4644	"M" Option N/A
71 x 24 x 29	215 CAP7124CA668W 4294	"P" Option N/A	CAP7124CA668G 4294	"M" Option N/A
65 x 24 x 29	200 CAP6524CA668W 4208	"P" Option N/A	CAP6524CA668G 4208	"M" Option N/A
59 x 24 x 29	190 CAP5924CA668W 4116	"P" Option N/A	CAP5924CA668G 4116	"M" Option N/A

2 Select Finish

[Click to view finishes](#)

- WAC
- WIC
- WHC
- WOC
- WEW
- WGW
- WBW
- WSW
- WNW

- GAC
- GIC
- GHC
- GOC
- GEW
- GNW

3 Select Edge

[Click to view edges](#)



4 Select Hardware

[Click to view details](#)



Product Features

- Fixed full modesty
- Full extension drawers - locking
- Hookup hardware
- "W" & "G" Box and File Drawers feature soft close suspensions (Lateral Drawers Feature ball bearing suspensions)

Notes

- K28 Keyboard not available on 71", 65", and 59" units
- Unit has black back panel and is not designed for Open Plan use. Select OPB Option for Open Plan application

Options

Accessories

- K28: Articulating keyboard w/ mouse pad - \$390

Drawer

- P33: Wood Drawer Upgrade - \$45 per drawer

Flush Cut

- FC-L: Flush Unit Left (Facing) for Ganging - \$100
- FC-R: Flush Unit Right(Facing) for Ganging - \$100

Grommets (Standard Location)

Specify Color - \$50 ea.

- Black: TM30-C (Center)
- Silver: TM31-C (Center)
- Antique Brass: TM33-C (Center)

Grommets (Non-Standard Location)

Provide drawing w/ Grommet Location and Specify Color - \$95 ea.

- Black: TM30-NS
- Silver: TM31-NS
- Antique Brass: TM33-NS

Modesty

- M34T: Drop Door Tech Modesty - \$130
- M51: Open Back Modesty with Wire Mgmt Rail - Deduct \$95

Open Plan _ Finished Back

- OPB: Modify Unit for Open Plan Application - \$295

Capitol Park

Single Storage Overhead Console
Panel Door - 6/4/2 Door

[Click here to view statement of line](#)

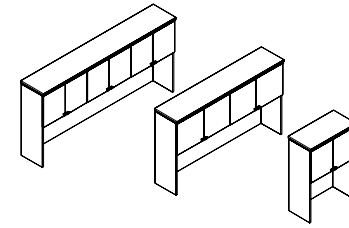

1 Select Model

w" x d" x h"	Weight
6 Door	
94 x 15 x 43	315
88 x 15 x 43	285
4 Door	
84 x 15 x 43	275
77 x 15 x 43	255
71 x 15 x 43	240
65 x 15 x 43	225
59 x 15 x 43	210
48 x 15 x 43	105
2 Door	
36 x 15 x 43	120
30 x 15 x 43	105

	Standard Veneer Top Standard Veneer Chassis	Premium Veneer Top Premium Veneer Chassis	High Pressure Laminate Top Veneer Chassis	Thermally Fused Laminate Top Thermally Fused Laminate Chassis
CAP9443OH325W 4973		"P" Option N/A	"G" Option N/A	"M" Option N/A
CAP8843OH325W 4474		"P" Option N/A	"G" Option N/A	"M" Option N/A
CAP8443OH325W 4304		"P" Option N/A	"G" Option N/A	"M" Option N/A
CAP7743OH325W 4138		"P" Option N/A	"G" Option N/A	"M" Option N/A
CAP7143OH325W 3801		"P" Option N/A	"G" Option N/A	"M" Option N/A
CAP6543OH325W 3716		"P" Option N/A	"G" Option N/A	"M" Option N/A
CAP5943OH325W 3636		"P" Option N/A	"G" Option N/A	"M" Option N/A
CAP4843OH325W 3557		"P" Option N/A	"G" Option N/A	"M" Option N/A
CAP3643OH325W 2305		"P" Option N/A	"G" Option N/A	"M" Option N/A
CAP3043OH325W 2271		"P" Option N/A	"G" Option N/A	"M" Option N/A

2 Select Finish

[Click to view finishes](#)

- WAC
- WIC
- WHC
- WOC
- WEW
- WGW
- WBW
- WSW
- WNW

3 Select Edge

[Click to view edges](#)



Capitol

4 Select Hardware

[Click to view details](#)



- DK-125 Antique Pewter
- DK-126 Antique English
- DK-127 Matte Black

Product Features

- Finished top
- Interior cabinet depth 12.5"
- 5/8" grommet(s) included for task light wire management
- Top shaped on front and sides

Notes

- Unit has black back panel and is not designed for Open Plan use. Select OPB Option for Open Plan application

Options

Door

- D2: Door Lock - \$100 per door set
- D6: Delete Doors - n/c
- D9SC: Soft Close Door Hinges - \$20 per door

Flush Cut

- FC-B: Flush Unit Both Sides(Facing) for Ganging - \$100
- FC-L: Flush Unit Left (Facing) for Ganging - \$100
- FC-R: Flush Unit Right(Facing) for Ganging - \$100

Grommets (Vertical Surface)

- Standard Location - \$50 ea.
- Black Plastic Vertical Surface: TM50-C (Bottom Center)
- Non-Standard Location - \$95 ea.
- Black Plastic Vertical Surface: TM50-NS

Task Lighting (Recessed)

- Overhead task light cord is located on the right facing side. If the opposite location is required please contact customer service.
- LT-LED24: 24" LED Task light - \$215
- LT-LED48: 48" LED Task light - \$270
- LT-LED60: 60" LED Task light - \$335
- LT-LED72: 72" LED Task light - \$360

Open Plan _ Finished Back

- OPB:Modify Unit for Open Plan Application - \$395

Capitol Park

Single Storage Overhead Console
Wood Frame Door With Clear Glass Inserts

[Click here to view statement of line](#)

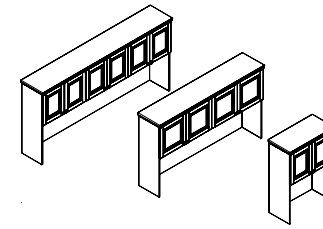

1 Select Model

w" x d" x h"	Weight
6 Door	
94 x 15 x 43	315
88 x 15 x 43	285
4 Door	
71 x 15 x 43	240
65 x 15 x 43	225
59 x 15 x 43	210
2 Door	
36 x 15 x 43	120
30 x 15 x 43	105

Standard Veneer Top Standard Veneer Chassis		Premium Veneer Top Premium Veneer Chassis		High Pressure Laminate Top Veneer Chassis		Thermally Fused Laminate Top Thermally Fused Laminate Chassis	
		"P" Option N/A		"G" Option N/A		"M" Option N/A	
		"P" Option N/A		"G" Option N/A		"M" Option N/A	
		"P" Option N/A		"G" Option N/A		"M" Option N/A	
		"P" Option N/A		"G" Option N/A		"M" Option N/A	
		"P" Option N/A		"G" Option N/A		"M" Option N/A	
		"P" Option N/A		"G" Option N/A		"M" Option N/A	
		"P" Option N/A		"G" Option N/A		"M" Option N/A	

Product Features

- Finished top
- Interior cabinet depth 12.5"
- 5/8" grommet(s) included for task light wire management
- Top shaped on front and sides

Notes

- Unit has black back panel and is not designed for Open Plan use. Select OPB Option for Open Plan application

Options

- Door**
- D2-G: Door Lock for Glass Doors - \$205 per door set
 - D9SC: Soft Close Door Hinges - \$20 per door

Flush Cut

- FC-B: Flush Unit Both Sides(Facing) for Ganging - \$100
- FC-L: Flush Unit Left (Facing) for Ganging - \$100
- FC-R: Flush Unit Right(Facing) for Ganging - \$100

Grommets (Vertical Surface)

- Standard Location - \$50 ea.
- Black Plastic Vertical Surface: TM50-C (Bottom Center)
- Non-Standard Location - \$95 ea.
- Black Plastic Vertical Surface: TM50-NS

Interior Cabinet Lighting

- LEDPK starter kit includes Infeed, 1 Puck Interior Light and the ability to daisy chain up to 6 total Puck Lights
- LEDPK: LED Puck Starter Kit - \$310
- PK: 1 LED Interior Light - \$130

Task Lighting

- Overhead task light cord is located on the right facing side. If the opposite location is required please contact customer service.
- LT-LED24: 24" LED Task light - \$215
- LT-LED48: 48" LED Task light - \$270
- LT-LED60: 60" LED Task light - \$335
- LT-LED72: 72" LED Task light - \$360

Open Plan _ Finished Back

- OPB:Modify Unit for Open Plan Application - \$395

2 Select Finish

[Click to view finishes](#)

- WAC
- WIC
- WHC
- WOC
- WEW
- WGW
- WBW
- WSW
- WNW

3 Select Edge

[Click to view edges](#)



Capitol

4 Select Hardware

[Click to view details](#)



- DK-125 Antique Pewter
- DK-126 Antique English
- DK-127 Matte Black

Wall hung tackboard Full width tackboards

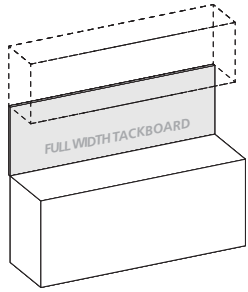

Product Width	Panel Dimension	SKU	COM	1	2	3	4	5	6	7	8	9	10	11/L1	12	13/L2
93	93 x .75 x 24	FTWH9324	465	576	627	678	729	780	831	882	933	984	1035	1086	1137	1239
87	87 x .75 x 24	FTWH8724	448	539	587	635	683	731	779	827	875	923	971	1019	1067	1163
83	83 x .75 x 24	FTWH8324	422	514	560	606	652	698	744	790	836	882	928	974	1020	1112
76	76 x .75 x 24	FTWH7624	388	471	514	557	600	643	686	729	772	815	858	901	944	1030
70	70 x .75 x 24	FTWH7024	355	434	474	514	554	594	634	674	714	754	794	834	874	954
64	64 x .75 x 24	FTWH6424	322	396	432	468	504	540	576	612	648	684	720	756	792	864
58	58 x .75 x 24	FTWH5824	294	359	391	423	455	487	519	551	583	615	647	679	711	775
47	47 x .75 x 24	FTWH4724	236	291	318	345	372	399	426	453	480	507	534	561	588	642
35	35 x .75 x 24	FTWH3524	176	217	237	257	277	297	317	337	357	377	397	417	437	477
29	29 x .75 x 24	FTWH2924	142	179	196	213	230	247	264	281	298	315	332	349	366	400

Standard Features

- Constructed of .875" thick fiberboard
- Fabric is precisely aligned and fitted to the tackboard
- Adhered to the rigid hardboard with staples
- Hung with Z-Strip mounting system

Wall hung tackboard Half width tackboards

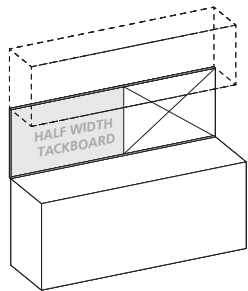

Product Width	Panel Dimension	SKU	COM	1	2	3	4	5	6	7	8	9	10	11/L1	12	13/L2
93 Half Width	46.5 x .75 x 24	FTWH4624	233	288	313	338	363	388	413	438	463	488	513	538	563	613
87 Half Width	43.5 x .75 x 24	FTWH4324	225	270	294	318	342	366	390	414	438	462	486	510	534	582
83 Half Width	41.5 x .75 x 24	FTWH4124	211	257	280	303	326	349	372	395	418	441	464	487	510	556
76 Half Width	38 x .75 x 24	FTWH3824	194	235	256	277	298	319	340	361	382	403	424	445	466	508
70 Half Width	35 x .75 x 24	FTWH3524	178	217	237	257	277	297	317	337	357	377	397	417	437	477
64 Half Width	32 x .75 x 24	FTWH3224	161	198	216	234	252	270	288	306	324	342	360	378	396	432

Standard Features

- Constructed of .875" thick fiberboard
- Fabric is precisely aligned and fitted to the tackboard
- Adhered to the rigid hardboard with staples
- Hung with Z-Strip mounting system

Notes

- Half width tackboards can be specified and combined with a Veneer Panel, Marker Board, Slat Wall or Glass Board. See "Half Width" items under product width.
- Specify right or left facing tackboard

Wall hung dry marker board
Full width dry marker board

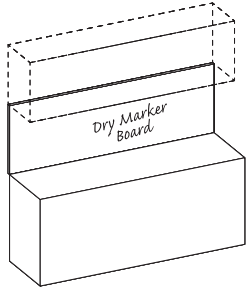

Product Width	Panel Dimension	SKU	List
93	93 x .75 x 24	DMWH9324	1161
87	87 x .75 x 24	DMWH8724	1086
83	83 x .75 x 24	DMWH8324	1023
76	76 x .75 x 24	DMWH7624	948
70	70 x .75 x 24	DMWH7024	874
64	64 x .75 x 24	DMWH6424	799
58	58 x .75 x 24	DMWH5824	724
47	47 x .75 x 24	DMWH4724	587
35	35 x .75 x 24	DMWH3524	437
29	29 x .75 x 24	DMWH2924	362

Standard Features

- Dry marker panel has edge trim molding
- Standard magnetic surface
- Hung with Z-Strip mounting system

Wall hung dry marker board
Half width dry marker board

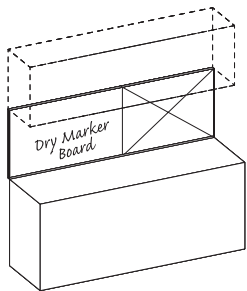

Product Width	Panel Dimension	SKU	List
93 Half Width	46.5 x .75 x 24	DMWH4624	580
87 Half Width	43.5 x .75 x 24	DMWH4324	543
83 Half Width	41.5 x .75 x 24	DMWH4124	518
76 Half Width	38 x .75 x 24	DMWH3824	474
70 Half Width	35 x .75 x 24	DMWH3524	437
64 Half Width	32 x .75 x 24	DMWH3224	399

Standard Features

- Dry marker panel has edge trim molding
- Standard magnetic surface
- Hung with Z-Strip mounting system

- Specify right or left facing dry marker board

Notes

- Half width dry marker boards can be specified and combined with a Tackboard, Veneer Panel, Slat Wall or Glass Board. See "Half Width" items under product width.

DARRAN®

Wall hung glassboard Full width glassboards

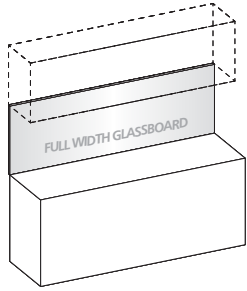

Product Width	Panel Dimension	SKU	List
93	93 x .75 x 24	GBWH9324	2753
87	87 x .75 x 24	GBWH8724	2586
83	83 x .75 x 24	GBWH8324	2475
76	76 x .75 x 24	GBWH7624	2281
70	70 x .75 x 24	GBWH7024	2114
64	64 x .75 x 24	GBWH6424	1948
58	58 x .75 x 24	GBWH5824	1780
47	47 x .75 x 24	GBWH4724	1476
35	35 x .75 x 24	GBWH3524	1142
29	29 x .75 x 24	GBWH2924	976

Standard Features

- 4 mm tempered glass
- Hung with Z-Strip mounting system

Notes

- Use glass cleaner or alcohol to clean
- Standard dry erase markers may be used
- Earth magnets are required to hold items securely in place

Wall hung glassboard Half width glassboards

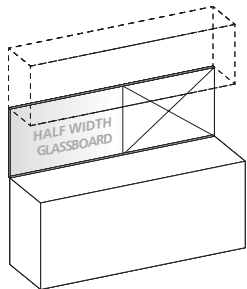

93 Half Width	46.5 x .75 x 24	GBWH4624	1461
87 Half Width	43.5 x .75 x 24	GBWH4324	1378
83 Half Width	41.5 x .75 x 24	GBWH4124	1323
76 Half Width	38 x .75 x 24	GBWH3824	1232
70 Half Width	35 x .75 x 24	GBWH3524	1142
64 Half Width	32 x .75 x 24	GBWH3224	1059

Standard Features

- 4 mm tempered glass
- Hung with Z-Strip mounting system

Notes

- Half width glassboards can be specified and combined with a Tackboard, Veneer panel, Marker Board or Slat Wall. See "Half Width" items under product width.
- Specify right or left facing glassboard
- Use glass cleaner or alcohol to clean
- Standard dry erase markers may be used
- Earth magnets are required to hold items securely in place

DARRAN®

Wall hung slat wall
half width slat wall

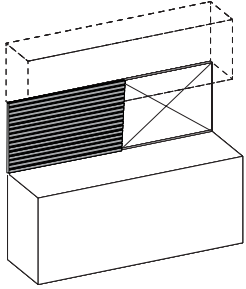

Product Width	Panel Dimension	SKU	List
93 Half Width	46.5 x .75 x 24	SWWH4624	484
87 Half Width	43.5 x .75 x 24	SWWH4324	452
83 Half Width	41.5 x .75 x 24	SWWH4124	432
76 Half Width	38 x .75 x 24	SWWH3824	395
70 Half Width	35 x .75 x 24	SWWH3524	364
64 Half Width	32 x .75 x 24	SWWH3224	333

Standard Features

- Available in silver or black
- Hung with Z-Strip mounting system

Notes

- Half width slat walls can be specified and combined with a Tackboard, Veneer panel, Marker Board or Glassboard. See "Half Width" items under product width.
- Specify right or left facing slat wall
- For use on 42"/43" height consoles

Capitol Park

Single Height Wall Hung Overheads
 Panel Doors - 6/4/2 Door

[Click here to view statement of line](#)

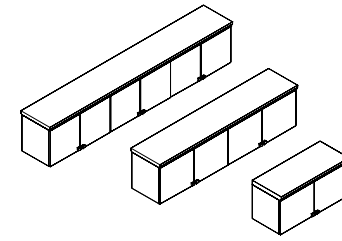

1 Select Model

w" x d" x h"	Weight
6 Door	
93 x 15 x 19	240
87 x 15 x 19	225
4 Door	
83 x 15 x 19	210
76 x 15 x 19	195
70 x 15 x 19	180
64 x 15 x 19	160
58 x 15 x 19	135
47 x 15 x 19	125
2 Door	
35 x 15 x 19	75
29 x 15 x 19	65
23 x 15 x 19	55

2 Select Finish

[Click to view finishes](#)

- WAC
- WIC
- WHC
- WOC
- WEW
- WGW
- WBW
- WSW
- WNW

3 Select Edge

[Click to view edges](#)



4 Select Hardware

[Click to view details](#)



- DK-125 Antique Pewter
- DK-126 Antique English
- DK-127 Matte Black

		Standard Veneer Top Standard Veneer Chassis	Premium Veneer Top Premium Veneer Chassis	High Pressure Laminate Top Veneer Chassis	Thermally Fused Laminate Top Thermally Fused Laminate Chassis
			"P" Option N/A	"G" Option N/A	"M" Option N/A
			"P" Option N/A	"G" Option N/A	"M" Option N/A
			"P" Option N/A	"G" Option N/A	"M" Option N/A
			"P" Option N/A	"G" Option N/A	"M" Option N/A
			"P" Option N/A	"G" Option N/A	"M" Option N/A
			"P" Option N/A	"G" Option N/A	"M" Option N/A
			"P" Option N/A	"G" Option N/A	"M" Option N/A
			"P" Option N/A	"G" Option N/A	"M" Option N/A
			"P" Option N/A	"G" Option N/A	"M" Option N/A
			"P" Option N/A	"G" Option N/A	"M" Option N/A

Product Features

- Doors are a matched set
- Finished top
- Interior cabinet depth 12"
- Mounting rail included
- Top shaped on front only

Notes

- The DARRAN wall mounted cabinet(or shelf) must be hung on a weight-bearing wall. The suitability of the wall supporting the wall mounted cabinet, and the installation and maintenance of the wall-mounted cabinet, is the sole responsibility of the customer. Failure to correctly install and/or exceed the loaded weight capacity of this product may cause it to fall, resulting in damage to the product, adjacent property and/or bodily injury.

Options

Door

- D2: Door Lock - \$100 per door set
- D6: Delete Doors - n/c
- D9SC: Soft Close Door Hinges - \$20 per door

Task Lighting (Recessed)

Overhead task light cord is located on the right facing side. If the opposite location is required please contact customer service.

- LT-LED24: 24" LED Task light - \$215
- LT-LED48: 48" LED Task light - \$270
- LT-LED60: 60" LED Task light - \$335
- LT-LED72: 72" LED Task light - \$360

DARRAN®

Overhead tackboard Full width tackboards

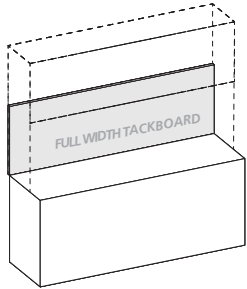

Product Width	Panel Dimension	SKU	COM	1	2	3	4	5	6	7	8	9	10	11/L1	12	13/L2
94	91 x .75 x 21	FTOC9121	379	480	531	582	633	684	735	786	837	888	939	990	1041	1143
88	85 x .75 x 21	FTOC8521	358	449	497	545	593	641	689	737	785	833	881	929	977	1073
84	81 x .75 x 21	FTOC8121	336	428	474	520	566	612	658	704	750	796	842	888	934	1026
77	74 x .75 x 21	FTOC7421	309	392	435	478	521	564	607	650	693	736	779	822	865	951
71	68 x .75 x 21	FTOC6821	282	361	401	441	481	521	561	601	641	681	721	761	801	881
65	62 x .75 x 21	FTOC6221	256	330	366	402	438	474	510	546	582	618	654	690	726	798
59	56 x .75 x 21	FTOC5621	234	299	331	363	395	427	459	491	523	555	587	619	651	715
48	45 x .75 x 21	FTOC4521	187	242	269	296	323	350	377	404	431	458	485	512	539	593
36	33 x .75 x 21	FTOC3321	141	180	200	220	240	260	280	300	320	340	360	380	400	440
30	27 x .75 x 21	FTOC2721	112	149	166	183	200	217	234	251	268	285	302	319	336	370

Standard Features

- Constructed of .5" thick fiberboard
- Fabric is precisely aligned and fitted to the tackboard
- Adhered to the rigid hardboard with staples
- Hung with Z-Strip mounting system

Notes

- Fabric Tack Panels are raised 3" from bottom edge when TM50 grommet is ordered

Overhead tackboard Half width tackboards

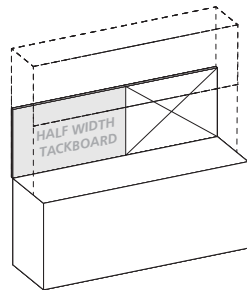

Product Width	Panel Dimension	SKU	COM	1	2	3	4	5	6	7	8	9	10	11/L1	12	13/L2
94 Half Width	45.5 x .75 x 21	FTOC4521	189	240	266	292	318	344	370	396	422	448	474	500	526	578
88 Half Width	42.5 x .75 x 21	FTOC4221	179	225	249	273	297	321	345	369	393	417	441	465	489	537
84 Half Width	40.5 x .75 x 21	FTOC4021	168	214	237	260	283	306	329	352	375	398	421	444	467	513
77 Half Width	37 x .75 x 21	FTOC3721	155	196	217	238	259	280	301	322	343	364	385	406	427	469
71 Half Width	34 x .75 x 21	FTOC3421	141	180	200	220	240	260	280	300	320	340	360	380	400	440
65 Half Width	31 x .75 x 21	FTOC3121	128	165	183	201	219	237	255	273	291	309	327	345	363	399

Standard Features

- Constructed of .5" thick fiberboard
- Fabric is precisely aligned and fitted to the tackboard
- Adhered to the rigid hardboard with staples
- Hung with Z-Strip mounting system

Notes

- Half width tackboards can be specified and combined with Marker Board, Slat Wall and Glass Board options. See "Half Width" items under product width.
- Specify right or left facing tackboard
- Fabric Tack Panels are raised 3" from bottom edge when TM50 grommet is ordered

DARRAN®

Overhead dry marker board Full width dry marker board

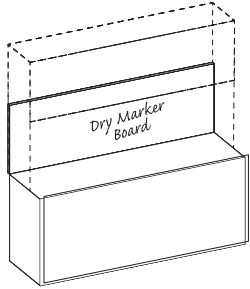

Product Width	Panel Dimension	SKU	List
94	91 x .5 x 21	DMOC9121	1136
88	85 x .5 x 21	DMOC8521	1061
84	81 x .5 x 21	DMOC8121	1011
77	74 x .5 x 21	DMOC7421	924
71	68 x .5 x 21	DMOC6821	849
65	62 x .5 x 21	DMOC6221	774
59	56 x .5 x 21	DMOC5621	699
48	45 x .5 x 21	DMOC4521	587
36	33 x .5 x 21	DMOC3321	437
30	27 x .5 x 21	DMOC2721	337

Standard Features

- Dry marker panel has edge trim molding
- Standard magnetic surface
- Hung with Z-Strip mounting system

Overhead dry marker board Half width dry marker board

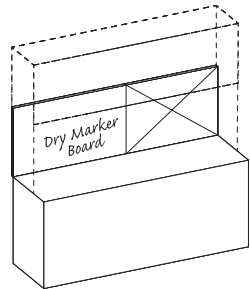

Product Width	Panel Dimension	SKU	List
94 Half Width	45.5 x .5 x 21	DMOC4521	555
88 Half Width	42.5 x .5 x 21	DMOC4221	518
84 Half Width	40.5 x .5 x 21	DMOC4021	493
77 Half Width	37 x .5 x 21	DMOC3721	449
71 Half Width	34 x .5 x 21	DMOC3421	437
65 Half Width	31 x .5 x 21	DMOC3121	374

Standard Features

- Dry marker panel has edge trim molding
- Standard magnetic surface
- Hung with Z-Strip mounting system

Notes

- Half width dry marker boards can be specified and combined with a Tackboard, Veneer Panel, Slat Wall or Glass Board. See "Half Width" items under product width.
- Specify right or left facing dry marker board

DARRAN®

Wall hung veneer panel
Full width veneer panel

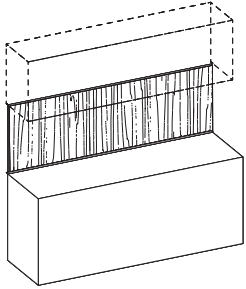

Product Width	Panel Dimension	SKU	List
93	93 x .75 x 24	VPWH9324	967
87	87 x .75 x 24	VPWH8724	905
83	83 x .75 x 24	VPWH8324	853
76	76 x .75 x 24	VPWH7624	790
70	70 x .75 x 24	VPWH7024	728
64	64 x .75 x 24	VPWH6424	666
58	58 x .75 x 24	VPWH5824	603
47	47 x .75 x 24	VPWH4724	489
35	35 x .75 x 24	VPWH3524	364
29	29 x .75 x 24	VPWH2924	302

Standard Features

- Veneer edges
- Vertical wire channels on back for task light cords
- Hung with Z-Strip mounting system

Notes

- Steel mounting wall channel is recessed for flush mounting
- Can be used with or without overhead cabinet
- Required for other accessory panels

Wall hung veneer panel
Half width veneer panel

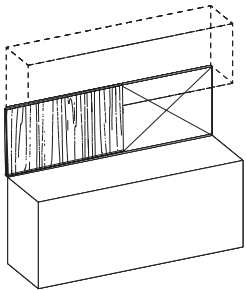

Product Width	Panel Dimension	SKU	List
93 Half Width	46.5 x .75 x 24	VPWH4624	484
87 Half Width	43.5 x .75 x 24	VPWH4324	452
83 Half Width	41.5 x .75 x 24	VPWH4124	432
76 Half Width	38 x .75 x 24	VPWH3824	395
70 Half Width	35 x .75 x 24	VPWH3524	364
64 Half Width	32 x .75 x 24	VPWH3224	333

Standard Features

- Veneer edges.
- Vertical wire channels on back for task light cords
- Steel mounting wall channel is recessed for flush mounting
- Hung with Z-Strip mounting system

Notes

- Half width veneer panels can be specified and combined with a Tackboard, Marker Board, Slat Wall or Glass Board. See "Half Width" items under product width.
- Specify right or left facing veneer panel
- Can be used with or without overhead cabinet
- Required for other accessory panels

DARRAN®

Overhead glassboard Full width glassboard

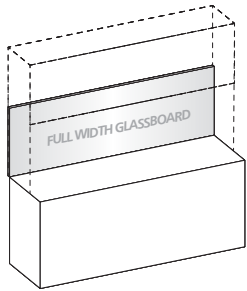

Product Width	Panel Dimension	SKU	List
94	91 x .5 x 21	GBOC9121	2382
88	85 x .5 x 21	GBOC8521	2236
84	81 x .5 x 21	GBOC8121	2138
77	74 x .5 x 21	GBOC7421	1969
71	68 x .5 x 21	GBOC6821	1822
65	62 x .5 x 21	GBOC6221	1676
59	56 x .5 x 21	GBOC5621	1531
48	45 x .5 x 21	GBOC4521	1264
36	33 x .5 x 21	GBOC3321	972
30	27 x .5 x 21	GBOC2721	826

Standard Features

- 4 mm tempered glass
- Hung with Z-Strip mounting system

Notes

- Use glass cleaner or alcohol to clean
- Standard dry erase markers may be used
- Earth magnets are required to hold items securely in place

Overhead glassboard Half width glassboard

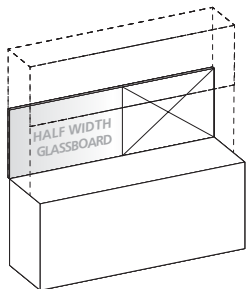

Product Width	Panel Dimension	SKU	List
94 Half Width	45.5 x .5 x 21	GBOC4521	1251
88 Half Width	42.5 x .5 x 21	GBOC4221	1178
84 Half Width	40.5 x .5 x 21	GBOC4021	1129
77 Half Width	37 x .5 x 21	GBOC3721	985
71 Half Width	34 x .5 x 21	GBOC3421	972
65 Half Width	31 x .5 x 21	GBOC3121	899

Standard Features

- 4 mm tempered glass
- Hung with Z-Strip mounting system

Notes

- Half width glassboards can be specified and combined with a Tackboard, Veneer panel, Marker Board or Slat Wall. See "Half Width" items under product width.
- Specify right or left facing glassboard
- Use glass cleaner or alcohol to clean
- Standard dry erase markers may be used
- Earth magnets are required to hold items securely in place

DARRAN®

Overhead slat wall
Half width slat wall

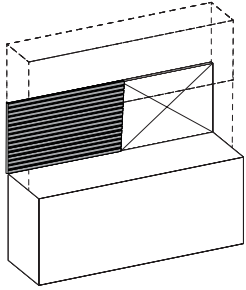

Product Width	Panel Dimension	SKU	List
94 Half Width	45.5 x .5 x 21	SWOC4521	463
88 Half Width	42.5 x .5 x 21	SWOC4221	432
84 Half Width	40.5 x .5 x 21	SWOC4021	411
77 Half Width	37 x .5 x 21	SWOC3721	374
71 Half Width	34 x .5 x 21	SWOC3421	343
65 Half Width	31 x .5 x 21	SWOC3121	312

Standard Features

- Available in silver or black
- For use on 42"/43" height consoles
- Specify right or left facing slat wall
- Hung with Z-Strip mounting system

Notes

- Half width slat walls can be specified and combined with a Tackboard, Veneer panel, Marker Board or Glassboard. See "Half Width" items under product width.
- Specify right or left facing slat wall
- For use on 42"/43" height consoles
- Specify right or left facing slat wall

Capitol Park

Sit-On Tower Extension
Panel Door - Full Storage

[Click here to view statement of line](#)

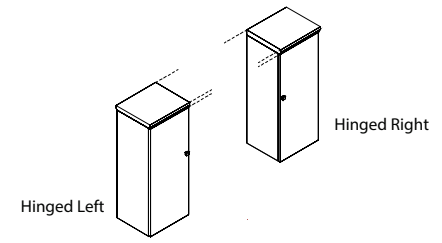

1 Select Model

w" x d" x h"
Hinged Left
17.5 x 15 x 43
14.5 x 15 x 43
Hinged Right
17.5 x 15 x 43
14.5 x 15 x 43

Weight	Standard Veneer Top Standard Veneer Chassis	Premium Veneer Top Premium Veneer Chassis	High Pressure Laminate Top Veneer Chassis	Thermally Fused Laminate Top Thermally Fused Laminate Chassis
80	CAP1743OH340W 2137	"P" Option N/A	"G" Option N/A	"M" Option N/A
75	CAP1443OH340W 2060	"P" Option N/A	"G" Option N/A	"M" Option N/A
80	CAP1743OH341W 2137	"P" Option N/A	"G" Option N/A	"M" Option N/A
75	CAP1443OH341W 2060	"P" Option N/A	"G" Option N/A	"M" Option N/A

Product Features

- 2 adjustable wood shelves
- Finished top
- Interior shelf depth 12"
- Top shaped on front only

Notes

- Unit has black back panel and is not designed for Open Plan use. Select OPB Option for Open Plan application

Options

Door

- D2: Door Lock - \$100 per door
- D6: Delete Doors - n/c
- D9SC: Soft Close Door Hinges - \$20 per door

Open Plan _ Finished Back

- OPB:Modify Unit for Open Plan Application - \$395

2 Select Finish

[Click to view finishes](#)

- WAC
- WIC
- WHC
- WOC
- WEW
- WGW
- WBW
- WSW
- WNW

3 Select Edge

[Click to view edges](#)



4 Select Hardware

[Click to view details](#)



- DK-125 Antique Pewter
- DK-126 Antique English
- DK-127 Matte Black

Capitol Park

Sit-On Tower Extension

Wood Frame Door/Clear Glass Insert - Full Storage

[Click here to view statement of line](#)

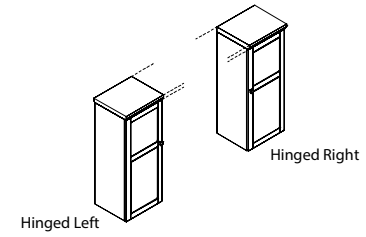

1 Select Model

w" x d" x h"	Weight
Hinged Left 17.5 x 15 x 43	80
14.5 x 15 x 43	75
Hinged Right 17.5 x 15 x 43	80
14.5 x 15 x 43	75

	Standard Veneer Top Standard Veneer Chassis	Premium Veneer Top Premium Veneer Chassis	High Pressure Laminate Top Veneer Chassis	Thermally Fused Laminate Top Thermally Fused Laminate Chassis
	CAP1743OH342W 2305	"P" Option N/A	"G" Option N/A	"M" Option N/A
	CAP1443OH342W 2225	"P" Option N/A	"G" Option N/A	"M" Option N/A
	CAP1743OH343W 2305	"P" Option N/A	"G" Option N/A	"M" Option N/A
	CAP1443OH343W 2225	"P" Option N/A	"G" Option N/A	"M" Option N/A

Product Features

- 2 adjustable wood shelves
- Finished top
- Interior shelf depth 12"
- Top shaped on front only

Notes

- Unit has black back panel and is not designed for Open Plan use. Select OPB Option for Open Plan application

Options

Door

- D2-G: Door Lock for Glass Doors - \$205 per door set
- D9SC: Soft Close Door Hinges - \$20 per door

Interior Cabinet Lighting

- LEDPK starter kit includes Infeed, 1 Puck Interior Light and the ability to daisy chain up to 6 total Puck Lights
- LEDPK: LED Puck Starter Kit - \$310
- PK: 1 LED Interior Light - \$130

Open Plan _ Finished Back

- OPB:Modify Unit for Open Plan Application - \$395

Shelves

- GS14H: Replace Standard Shelves with Glass Shelf - \$70 per shelf

2 Select Finish

[Click to view finishes](#)

- WAC
- WIC
- WHC
- WOC
- WEW
- WGW
- WBW
- WSW
- WNW

3 Select Edge

[Click to view edges](#)



4 Select Hardware

[Click to view details](#)



- DK-125 Antique Pewter
- DK-126 Antique English
- DK-127 Matte Black

Capitol Park

Sit-On Bookcase Console
Panel Door

[Click here to view statement of line](#)

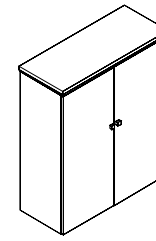

1 Select Model

w" x d" x h"	Weight
36 x 15 x 43	150
30 x 15 x 43	130

Standard Veneer Top Standard Veneer Chassis		Premium Veneer Top Premium Veneer Chassis	High Pressure Laminate Top Veneer Chassis	Thermally Fused Laminate Top Thermally Fused Laminate Chassis
CAP3643OH383W	2799	"P" Option N/A	"G" Option N/A	"M" Option N/A
CAP3043OH383W	2679	"P" Option N/A	"G" Option N/A	"M" Option N/A

Product Features

- 2 adjustable wood shelves
- Finished top
- Interior shelf depth 12"
- Top shaped on 3 sides

Notes

- Unit has black back panel and is not designed for Open Plan use. Select OPB Option for Open Plan application

Options

Door

- D2: Door Lock - \$100 per door set
- D6: Delete Doors - n/c
- D9SC: Soft Close Door Hinges - \$20 per door

Flush Cut

- FC-B: Flush Unit Both Sides(Facing) for Ganging - \$100
- FC-L: Flush Unit Left (Facing) for Ganging - \$100
- FC-R: Flush Unit Right(Facing) for Ganging - \$100

Open Plan _ Finished Back

- OPB:Modify Unit for Open Plan Application - \$395

2 Select Finish

[Click to view finishes](#)

- WAC
- WIC
- WHC
- WOC
- WEW
- WGW
- WBW
- WSW
- WNW

3 Select Edge

[Click to view edges](#)



Capitol

4 Select Hardware

[Click to view details](#)



- DK-125 Antique Pewter
- DK-126 Antique English
- DK-127 Matte Black

Capitol Park

Sit-On Bookcase Console
 Frame Door With Clear Glass

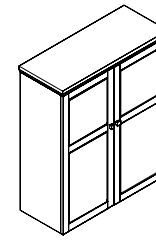

[Click here to view statement of line](#)

1 Select Model

w" x d" x h"	Weight
36 x 15 x 43	150
30 x 15 x 43	130

Standard Veneer Top Standard Veneer Chassis		Premium Veneer Top Premium Veneer Chassis	High Pressure Laminate Top Veneer Chassis	Thermally Fused Laminate Top Thermally Fused Laminate Chassis
CAP3643OH381W	3636	"P" Option N/A	"G" Option N/A	"M" Option N/A
CAP3043OH381W	3515	"P" Option N/A	"G" Option N/A	"M" Option N/A

Product Features

- 2 adjustable wood shelves
- Finished top
- Interior shelf depth 12"
- Top shaped on 3 sides

Notes

- Unit has black back panel and is not designed for Open Plan use. Select OPB Option for Open Plan application

Options

Door

- D2-G: Door Lock for Glass Doors - \$205 per door set
- D9SC: Soft Close Door Hinges - \$20 per door

Flush Cut

- FC-B: Flush Unit Both Sides(Facing) for Ganging - \$100
- FC-L: Flush Unit Left (Facing) for Ganging - \$100
- FC-R: Flush Unit Right(Facing) for Ganging - \$100

Interior Cabinet Lighting

- LEDPK starter kit includes Infeed, 1 Puck Interior Light and the ability to daisy chain up to 6 total Puck Lights
- LEDPK: LED Puck Starter Kit - \$310
- PK: 1 LED Interior Light - \$130

Open Plan _ Finished Back

- OPB:Modify Unit for Open Plan Application - \$395

Shelves

- GS14F: Replace Standard Shelves with Glass Shelves - \$90 per shelf
- S714F: Heavy Duty Lumber 1" Shelves - \$80 per shelf

2 Select Finish

[Click to view finishes](#)

- WAC
- WIC
- WHC
- WOC
- WEW
- WGW
- WBW
- WSW
- WNW

3 Select Edge

[Click to view edges](#)



Capitol

4 Select Hardware

[Click to view details](#)



- DK-125 Antique Pewter
- DK-126 Antique English
- DK-127 Matte Black

Capitol Park

Half Towers
Half Wardrobe - Left/Right Hinge

[Click here to view statement of line](#)

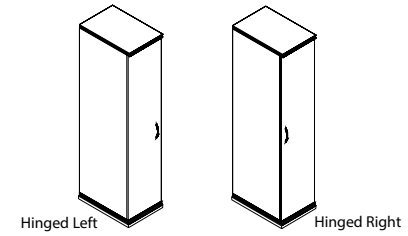

1 Select Model

w" x d" x h"
Hinged Left
16 x 24 x 72
Hinged Right
16 x 24 x 72

Weight	Standard Veneer Top Standard Veneer Chassis	Premium Veneer Top Premium Veneer Chassis	High Pressure Laminate Top Veneer Chassis	Thermally Fused Laminate Top Thermally Fused Laminate Chassis
155	CAP1672TW283W 3762	"P" Option N/A	"G" Option N/A	"M" Option N/A
155	CAP1672TW284W 3762	"P" Option N/A	"G" Option N/A	"M" Option N/A

Product Features

- 1 Fixed shelf
- 3 Adjustable shelves
- Finished top
- Top shaped on 3 sides
- Wardrobe w/ coat rod & hook
- Panel door w/ pull
- Hardwood base w/ mitred corners

Notes

- Unit has black back panel and is not designed for Open Plan use. Select OPB Option for Open Plan application

Options

- Door**
- D2: Door Lock - \$100 per door
 - D6: Delete Doors - n/c
 - D9SC: Soft Close Door Hinges - \$20 per door
- Flush Cut**
- FC-B: Flush Unit Both Sides(Facing) for Ganging - \$100
 - FC-L: Flush Unit Left (Facing) for Ganging - \$100
 - FC-R: Flush Unit Right(Facing) for Ganging - \$100
- Open Plan _ Finished Back**
- OPB:Modify Unit for Open Plan Application - \$395

2 Select Finish

[Click to view finishes](#)

- WAC
- WIC
- WHC
- WOC
- WEW
- WGW
- WBW
- WSW
- WNW

3 Select Edge

[Click to view edges](#)



4 Select Hardware

[Click to view details](#)



Capitol Park

Full Towers
Full Wardrobe

[Click here to view statement of line](#)

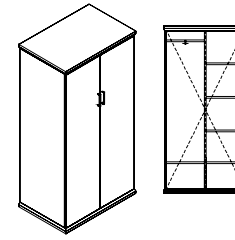

1 Select Model

w" x d" x h"	Weight
36 x 24 x 72	285
30 x 24 x 72	240

Standard Veneer Top Standard Veneer Chassis		Premium Veneer Top Premium Veneer Chassis	High Pressure Laminate Top Veneer Chassis	Thermally Fused Laminate Top Thermally Fused Laminate Chassis
CAP3672TW275W	5810	"P" Option N/A	"G" Option N/A	"M" Option N/A
CAP3072TW275W	5565	"P" Option N/A	"G" Option N/A	"M" Option N/A

Product Features

- 2 Fixed shelves
- 3 Adjustable shelves
- Finished top
- Hardwood base w/ mitred corners
- Top shaped on 3 sides
- Wardrobe w/ coat rod & hook
- Panel doors w/ pulls

Notes

- Unit has black back panel and is not designed for Open Plan use. Select OPB Option for Open Plan application

Options

Delete Center Partition

- MOD31: Delete center partition & Add 3 full width shelves, 1 fixed - \$295
- When deleting center partition (1) D2 Door lock should be specified

Door

- D2: Door Lock - \$100 per door
- D6: Delete Doors - n/c
- D9SC: Soft Close Door Hinges - \$20 per door

Flush Cut

- FC-B: Flush Unit Both Sides(Facing) for Ganging - \$100
- FC-L: Flush Unit Left (Facing) for Ganging - \$100
- FC-R: Flush Unit Right(Facing) for Ganging - \$100

Open Plan _ Finished Back

- OPB:Modify Unit for Open Plan Application - \$395

2 Select Finish

[Click to view finishes](#)

- WAC
- WIC
- WHC
- WOC
- WEW
- WGW
- WBW
- WSW
- WNW

3 Select Edge

[Click to view edges](#)



4 Select Hardware

[Click to view details](#)

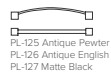

Capitol Park

Full Towers
2 Lateral File / Wardrobe

[Click here to view statement of line](#)

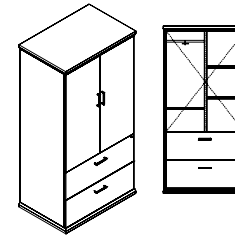

1 Select Model

w" x d" x h"	Weight
36 x 24 x 72	310
30 x 24 x 72	280

Standard Veneer Top Standard Veneer Chassis		Premium Veneer Top Premium Veneer Chassis	High Pressure Laminate Top Veneer Chassis	Thermally Fused Laminate Top Thermally Fused Laminate Chassis
CAP3672TW281W	6144	"P" Option N/A	"G" Option N/A	"M" Option N/A
CAP3072TW281W	5898	"P" Option N/A	"G" Option N/A	"M" Option N/A

Product Features

- 3 Adjustable shelves
- Finished top
- Hardwood base w/ mitred corners
- Top shaped on 3 sides
- Wardrobe w/ coat rod & hook
- Panel doors w/ pulls
- Features ball bearing suspensions, suspensions are full extension.

Notes

- Unit has black back panel and is not designed for Open Plan use. Select OPB Option for Open Plan application

Options

Door

- D2: Door Lock - \$100 per door
- D6: Delete Doors - n/c
- D9SC: Soft Close Door Hinges - \$20 per door

Drawer

- P33: Wood Drawer Upgrade - \$45 per drawer

Flush Cut

- FC-B: Flush Unit Both Sides(Facing) for Ganging - \$100
- FC-L: Flush Unit Left (Facing) for Ganging - \$100
- FC-R: Flush Unit Right(Facing) for Ganging - \$100

Open Plan _ Finished Back

- OPB:Modify Unit for Open Plan Application - \$395

Shelves

- MOD30: Delete center partition & Add 2 full width shelves (When specifying MOD30, 1 lock needed)- \$195

2 Select Finish

[Click to view finishes](#)

- WAC
- WIC
- WHC
- WOC
- WEW
- WGW
- WBW
- WSW
- WNW

3 Select Edge

[Click to view edges](#)



Capitol

4 Select Hardware

[Click to view details](#)



PL-115 Matte Black
PL-116 Matte Nickel



PL-125 Antique Pewter
PL-126 Antique English
PL-127 Matte Black

Capitol Park

Freestanding Bookcases
Open Bookcases

[Click here to view statement of line](#)

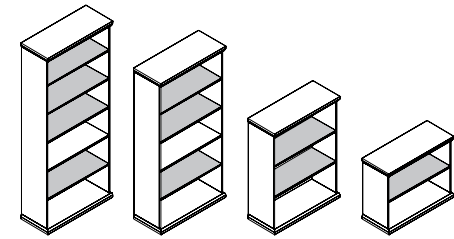

1 Select Model

w" x d" x h"

Weight	Standard Veneer Top Standard Veneer Chassis	Premium Veneer Top Premium Veneer Chassis	High Pressure Laminate Top Veneer Chassis	Thermally Fused Laminate Top Thermally Fused Laminate Chassis
36" Width				
36 x 15 x 84	CAP3684BK250W 3054	"P" Option N/A	"G" Option N/A	"M" Option N/A
36 x 15 x 72	CAP3672BK250W 2799	"P" Option N/A	"G" Option N/A	"M" Option N/A
36 x 15 x 48	CAP3648BK250W 2632	"P" Option N/A	"G" Option N/A	"M" Option N/A
36 x 15 x 30.75	CAP3630BK250W 2384	"P" Option N/A	"G" Option N/A	"M" Option N/A
30" Width				
30 x 15 x 84	CAP3084BK250W 2887	"P" Option N/A	"G" Option N/A	"M" Option N/A
30 x 15 x 72	CAP3072BK250W 2632	"P" Option N/A	"G" Option N/A	"M" Option N/A
30 x 15 x 48	CAP3048BK250W 2513	"P" Option N/A	"G" Option N/A	"M" Option N/A
30 x 15 x 30.75	CAP3030BK250W 2296	"P" Option N/A	"G" Option N/A	"M" Option N/A

2 Select Finish

[Click to view finishes](#)

- WAC
- WIC
- WHC
- WOC
- WEW
- WGW
- WBW
- WSW
- WNW

3 Select Edge

[Click to view edges](#)



4 Select Hardware

[Click to view details](#)

Hardware
N/A

Product Features

- 1 Fixed shelf on 84" & 72"
- Interior shelf depth 12"
- Hardwood base w/ mitred corners
- Top shaped 3 sides
- 30", 48", and 72" H units finished top, 84" H units black painted top

Notes

- 30.75"H Open Bookcases are NOT meant to gang with desks, returns and credenzas. Unit is higher than regular worksurfaces to allow double binder storage. If matching height is desired, choose CAP-3624CA125W or CAP3024CA125W with D6A option
- 12" Deep Shelves
- Unit has black back panel and is not designed for Open Plan use. Select OPB Option for Open Plan application

Options

Flush Cut

- FC-B: Flush Unit Both Sides(Facing) for Ganging - \$100
- FC-L: Flush Unit Left (Facing) for Ganging - \$100
- FC-R: Flush Unit Right(Facing) for Ganging - \$100

Interior Cabinet Lighting

- LEDPK starter kit includes Infeed, 1 Puck Interior Light and the ability to daisy chain up to 6 total Puck Lights
- LEDPK: LED Puck Starter Kit - \$310
- PK: 1 LED Interior Light - \$130

Open Plan _ Finished Back

- OPB:Modify Unit for Open Plan Application - \$395

Shelves

- GS14F: Replace Standard Shelves with Glass Shelves - \$90 per shelf
- S714F: Heavy Duty Lumber 1" Shelves - \$80 per shelf

Capitol Park
Freestanding Bookcases
Bookcases W/ Doors

[Click here to view statement of line](#)

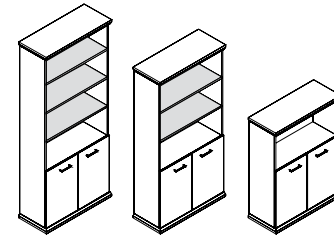

1 Select Model

w" x d" x h"

Weight	Standard Veneer Top Standard Veneer Chassis	Premium Veneer Top Premium Veneer Chassis	High Pressure Laminate Top Veneer Chassis	Thermally Fused Laminate Top Thermally Fused Laminate Chassis
36" Width				
36 x 15 x 84	CAP3684BK251W 3388	"P" Option N/A	"G" Option N/A	"M" Option N/A
36 x 15 x 72	CAP3672BK251W 3132	"P" Option N/A	"G" Option N/A	"M" Option N/A
36 x 15 x 48	CAP3648BK251W 2966	"P" Option N/A	"G" Option N/A	"M" Option N/A
30" Width				
30 x 15 x 84	CAP3084BK251W 3219	"P" Option N/A	"G" Option N/A	"M" Option N/A
30 x 15 x 72	CAP3072BK251W 2966	"P" Option N/A	"G" Option N/A	"M" Option N/A
30 x 15 x 48	CAP3048BK251W 2845	"P" Option N/A	"G" Option N/A	"M" Option N/A

2 Select Finish

[Click to view finishes](#)

- WAC
- WIC
- WHC
- WOC
- WEW
- WGW
- WBW
- WSW
- WNW

3 Select Edge

[Click to view edges](#)



4 Select Hardware

[Click to view details](#)



- DK-125 Antique Pewter
- DK-126 Antique English
- DK-127 Matte Black



- PL-115 Matte Black
- PL-116 Matte Nickel
- PL-125 Antique Pewter
- PL-126 Antique English
- PL-127 Matte Black

Product Features

- 72" w/ 3 adj. shelves
- 84" w/ 4 adjustable shelves
- Hardwood base w/ mitred corners.
- Interior shelf depth 12"
- Top shaped on 3 sides
- Panel doors w/ pulls
- 48", 72" H units finished top, 84" H units black painted top

Notes

- Unit has black back panel and is not designed for Open Plan use. Select OPB Option for Open Plan application

Options

Door

- D2: Door Lock - \$100 per door set
- D9SC: Soft Close Door Hinges - \$20 per door

Flush Cut

- FC-B: Flush Unit Both Sides(Facing) for Ganging - \$100
- FC-L: Flush Unit Left (Facing) for Ganging - \$100
- FC-R: Flush Unit Right(Facing) for Ganging - \$100

Interior Cabinet Lighting

- LEDPK starter kit includes Infeed, 1 Puck Interior Light and the ability to daisy chain up to 6 total Puck Lights
- LEDPK: LED Puck Starter Kit - \$310
- PK: 1 LED Interior Light - \$130

Open Plan _ Finished Back

- OPB:Modify Unit for Open Plan Application - \$395

Shelves

- GS14F: Replace Standard Shelves with Glass Shelves - \$90 per shelf
- S714F: Heavy Duty Lumber 1" Shelves - \$80 per shelf



COMPUTER SUPPORT
single monitor arm

COMPUTER SUPPORT
double monitor arm

COMPUTER SUPPORT
triple monitor arm

COMPUTER SUPPORT
quadruple monitor arm

Style Number	List Price
MA1	280

Style Number	List Price
MA2	450

Style Number	List Price
MA3	530

Style Number	List Price
MA4	705

Specifications

- Available in black or silver
- Desk clamp and mounting included
- Easy assembly and flexibility
- Elastic painting process for a durable and beautiful finish
- Gas spring tension adjustment for counter-balance height adjustment for monitors 1-8 KG
- Gas spring tested to 50,000 repetitions
- Hidden cable management

Specifications

- Available in black or silver
- Desk clamp and mounting included
- Easy assembly and flexibility
- Elastic painting process for a durable and beautiful finish
- Gas spring tension adjustment for counter-balance height adjustment for monitors 1-8 KG
- Gas spring tested to 50,000 repetitions
- Hidden cable management

Specifications

- Available in black or silver
- Desk clamp and mounting included
- Easy assembly and flexibility
- Elastic painting process for a durable and beautiful finish
- Gas spring tension adjustment for counter-balance height adjustment for monitors 1-8 KG
- Gas spring tested to 50,000 repetitions
- Hidden cable management

Specifications

- Available in black
- Desk clamp and mounting included
- Easy assembly and flexibility
- Elastic painting process for a durable and beautiful finish
- Gas spring tension adjustment for counter-balance height adjustment for monitors 1-8 KG
- Gas spring tested to 50,000 repetitions
- Hidden cable management

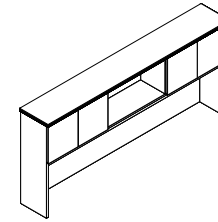
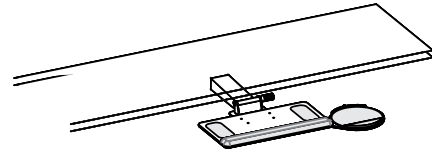
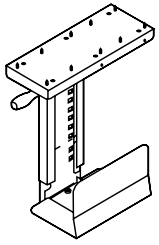

COMPUTER SUPPORT
cpu retractable cradle

COMPUTER SUPPORT
articulating keyboard tray

DOOR MODIFICATIONS
soft close door hinge

DOOR MODIFICATIONS
delete doors

Style Number	List Price
K18	205

Style Number	List Price
Factory Installed	
K28	395
Field Installed	
K28F	415

Style Number	List Price
D9SC	20 Per door

Style Number	List Price
D6	N/C

Specifications

- Black Metal CPU Carriage
- Full 360° swivel capability allows easy access to rear of CPU for cables / wires
- Track allows 8- 1/2" extension
- Width Adjustment 5-1/2" to 9-1/4"
- Height adjustment 14- 5/8" to 20- 1/2"
- Black epoxy finish

Notes
- Factory Installed

Specifications

- Adjusts effortlessly - A simple one-handed motion allows the keyboard to be repositioned instantly, without the use of locks or levers
- Encourages low-risk postures - Maximizes adjustability within a safe operating range.
- Will last a lifetime - Exceeds all applicable BIFMA Standards and comes with a lifetime guarantee.

Notes
- Available on: Freestanding Desk
- Factory Installed (standard)
- FIELD INSTALL - \$415

Specifications

- Snap onto standard door hinge
- Requires (2) per door
- Max door height 43"
- Factory installed where specified
- Individually shipped for field installation

Notes
- Specify Each Item To Have Slow Close Feature

Specifications

- Standard Door overheads and cabinets can have door deleted for open access. Modification of hinge rails and structural components are made face ready.

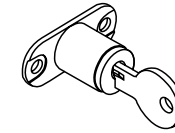
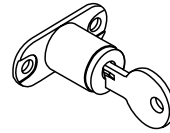
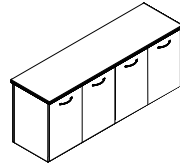
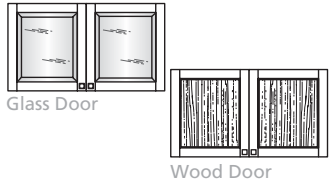

DOOR MODIFICATIONS

replace glass panel insert with veneer panel insert

Style Number	List Price
D35	35 per door

DOOR MODIFICATIONS

delete doors/replace black laminate shelf w/ finished shelf

Style Number	List Price
D6A	N/C

DOOR MODIFICATIONS

panel door lock

Style Number	List Price
D2	100 Per door set

DOOR MODIFICATIONS

glass door lock

Style Number	List Price
D2-G	205 Per door set

Specifications

- Replace glass panel insert with veneer panel insert

- Notes
- Not Available on "M" skus
 - Glass door has beveled glass
 - Wood door w/ veneer insert - only available on "W" style

Specifications

- Delete doors and replace black laminate shelf with finished shelf

- Notes
- Available on: All Storage "W"/"G" Style Credenzas.

Specifications

- Door Locks - 1 Door w/ Lock, Other Door w/ Catch Latch

- Contact Customer Service regarding limited lock locations and keying.

- Notes
- Available on: Panel Doors, Wood Frame Doors, and Silverluma doors

Specifications

- Door Locks - 1 Door w/ Lock, Other Door w/ Catch Latch

- Contact Customer Service regarding limited lock locations and keying.

- Notes
- Available on: Glass Doors

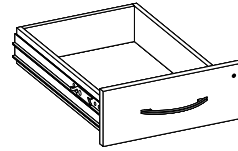
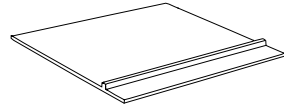
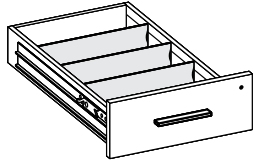

DRAWER OPTIONS
box drawer accessories

Style Number	List Price
Wood Drawer Dividers w/ Clips K-DIV	SET OF 3 - 30
Single Tray - Utility Tray K-Sut	35 ea.

DRAWER OPTIONS - BOTTOM COVER
felt bottom center drawer insert liner

Style Number	List Price
K3	100

DRAWER OPTIONS - UPGRADE
wood drawer upgrade

Style Number	List Price
P33	45 Per drawer

GLASSBOARD ACCESSORIES
glassboard accessory kit

Style Number	List Price
GBKIT	290

Specifications

- K-DIV Extra Wood Drawer Dividers with Clips, Top Box drawers standard with 1 divider
- K-SUT Single Tray - Utility Tray, Specify Legal or Letter drawer width

Specifications

- Inserts into center drawer and features divider for open pen and pencil storage. Removable for easy cleaning.
- Adds a luxurious touch to center drawers.
- Color: Dark Brown Coal

Specifications

- Dowel joint construction
- Hardwood veneer multi-ply drawer
- UV finish
- 1/4" Wood veneer bottoms
- File drawer bottoms are five block reinforced for heavy weight capacity
- Lifetime guaranteed

Specifications

- 8 Earth magnets, 1 magnetic marker cup holder and 1 magnetic dry eraser

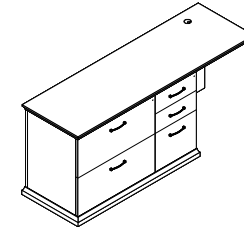
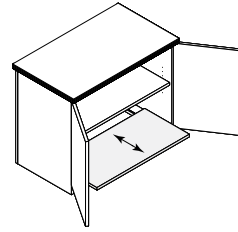
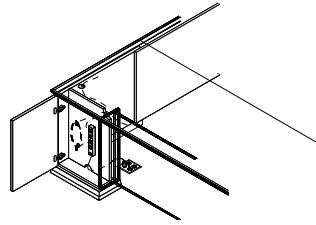
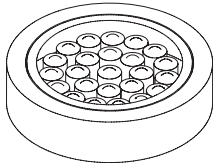

LIGHTING
led interior cabinet puck light

PEDESTAL MODIFICATIONS
breakfront pedestal with wire management cavity door

PEDESTAL MODIFICATIONS
black laminate printer pullout bottom shelf

PEDESTAL MODIFICATIONS
add veneer kneespace cabinets - base

Style Number	List Price
Starter Kit	
LEDPK	310
1 LED Interior Puck Light	
PK	130

Style Number	List Price
PC10	100
Power Supply Cordset	
PD717	100

Style Number	List Price
PPOS	225

Style Number	List Price
Add Box/Box/File or File/File	
P40B	1025
Add Lateral File 29" W	
P41B	1255
Add Multi-File - 31"W	
P42B	1255
Add Storage With Doors 29"W	
P43B	1140
Add CPU /Printer Cabinet - Open	
P44B	1140

Specifications

- Starter kit includes Infeed, 1 Puck Interior Light and the ability to daisy chain up to 6 total Puck Lights
- (1) LED Puck Light with 30W power drive and switch
- Recessed fixture
- 12V linking cord 98"L
- Silver finish
- 50,000 hour life
- 2 watt per light

Notes

- Available on: Overhead/Tower Units with glass doors or no doors
- Power drive included, Light only

Specifications

- Hinged pedestal front door offers easy access for wire management
- Wire hooks provide wire coil storage
- Wire access openings allow access to floor, cabinets interior and kneespace
- Cabinet interior is black finish
- Top grommet is positioned over cavity for access ease
- (Power Strip Optional)

Notes

- Breakfront Chassis Only

Specifications

- Black Laminate pullout shelf on suspension
- Black grommet in back
- Adjustable Shelf

Specifications

- Multi-file specify Box/Box Left or Right

Notes

- Add additional Standard Cabinets To Kneespace Area.

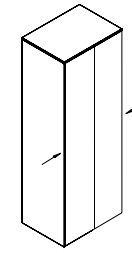
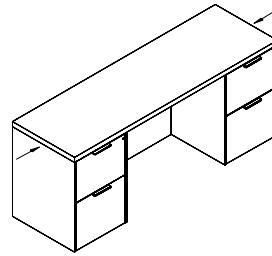
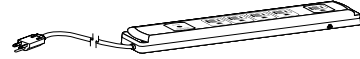
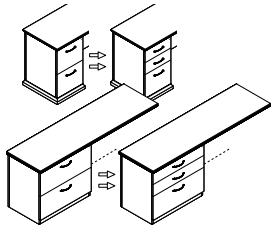

PEDESTAL MODIFICATIONS
modify drawer configurations

POWER / DATA
power supply cordset

PRODUCT MODIFICATIONS
modify width - open kneespace

PRODUCT MODIFICATIONS
modify width - open/closed storage

Style Number	List Price
File/File to Box/Box/File P6	55 Per ped
Box/Box/File to File/File P6	55 Per ped
Lateral File to 2 Box Drawers P8	100 Per ped

Style Number	List Price
PD717	100

Style Number	List Price
MOD-1	125

Style Number	List Price
MOD-2	250

Specifications

- Modify File/File To Box/Box/File - Any Unit

Specifications

- SIZE: 10.75"L x 2.0"W x 1.06"H
- (5) Outlets w/ 10' cord
- Surge suppression (720 Joules)
- 15 Amp breaker
- Available on: Vertical Panels, Cabinet Interiors, and under tops

Specifications

- Modify width down on any unit with an open kneespace: desk, workstation credenza, bridge, return

Specifications

- Modify width down on any unit with open or closed storage section: overheads, wall hung units, storage credenzas, towers

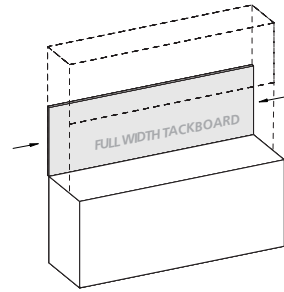

PRODUCT MODIFICATIONS
 modify width - tackboard, slat wall,
 veneer panel, or a glassboard

Style Number	List Price
MOD-3	Contact for pricing
Style Number	List Price
MOD-4	50

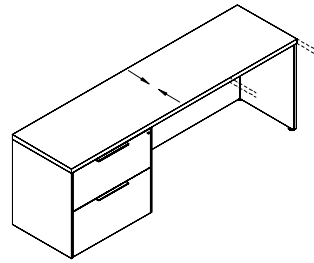

PRODUCT MODIFICATIONS
 modify depth - decrease depth

Style Number	List Price
MOD-5	125

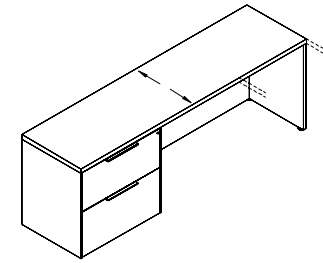

PRODUCT MODIFICATIONS
 modify depth - increase depth

Style Number	List Price
MOD-6	Add 10%

Specifications

- Width modification outside of MOD-1 & MOD-2

Specifications

- Modify width down on tackboard, slat wall, veneer panel, or a overhead glassboard

Specifications

- Modify depth down (minimum depth for a unit with drawers is 21"D)

Notes
 - Ex. 24" to 21", 30" to 24", and 36" to 30"

Specifications

- Increase depth by no more than 6"

Notes
 - Ex. 24" to 30", 30" to 36", and 36" to 42"

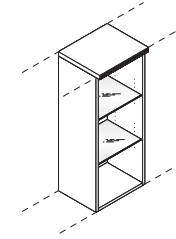
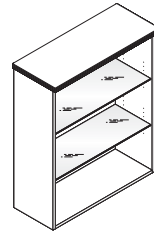
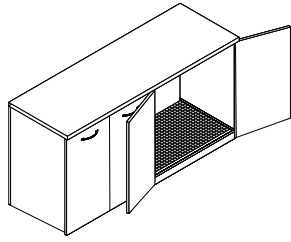

PRODUCT MODIFICATIONS
modify height

Style Number	List Price
MOD-7	Contact for pricing

REFRIGERATOR MODIFICATION
refrigerator cabinet modification

Style Number	List Price
REF01	205

SHELF MODIFICATIONS
glass shelves - tempered full width
26" - 35"

Style Number	List Price
26"W - 35"W x 14"D Shelf GS14F	90

SHELF MODIFICATIONS
tempered glass shelves for half
cabinet 17- 1/2" widths

Style Number	List Price
14-1/2"W - 17- 1/2"W x 14"D Shelf GS14H	70 ea.

Specifications

- Modify height of a unit

Specifications

- Open back cutout for venting
- Moisture sponge mat
- Contaminate ledge
- Contact customer service for maximum refrigerator size (Changes based on unit).

Notes

- Available on: 36" and 42" Storage Credenzas

Specifications

- Glass Shelves Replace Wood Shelf In Open Or Glass Door Cabinet. Also Order Interior Cabinet Lighting.

Specifications

- Glass Shelves Replace Wood Shelf In Open Or Glass Door Cabinet. Also Order Interior Cabinet Lighting.

Notes

- Replace only adjustable shelves between cabinet light and fixed lower wood shelf.

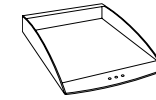
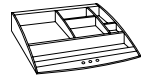
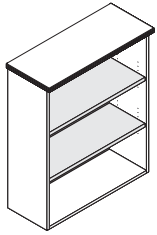

SHELF MODIFICATIONS
heavy duty solid wood bookcase
replacement shelves

Style Number	List Price
1" Wood Shelf 14" Deep S714F	80 ea.
1" Wood Shelf 24" Deep S714FX	160 ea.

SLAT WALL ACCESSORIES
slat wall accessory tray

Style Number	List Price
SWA9	50

SLAT WALL ACCESSORIES
slat wall folder tray

Style Number	List Price
SWA7	50

SLAT WALL ACCESSORIES
slat wall paper tray

Style Number	List Price
SWA2	40

Specifications

- 1" Solid Lumber Core Shelves Replace Standard 3/4" Plywood Adjustable And Fixed Shelves

Specifications

- Specify Black Or Matte Silver

Specifications

- Specify Black Or Matte Silver

Specifications

- Specify Black Or Matte Silver

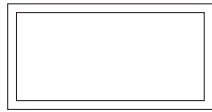

RECTANGLE INLAY

SLAT WALL ACCESSORIES

slat wall pencil holder

Style Number	List Price
SWA4	30

SPECIALTY VENEER ACCENTS

rectangle inlay - ebony hardwood
inlay detail

Style Number	List Price
T10SA	935

Specifications

- Specify Black Or Matte Silver

Specifications

- 3/16" x 3/16" thick hardwood ebony inlay is handfitted and glued into routed top and sanded flush with surface
- Inlay is finished over with all finish steps

Notes

- Ebony inlay not recommended in: Koko Cherry

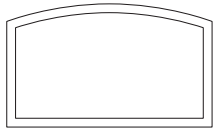

CURVED INLAY

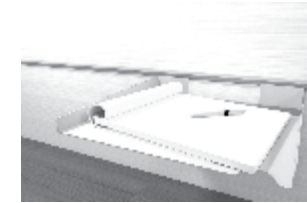
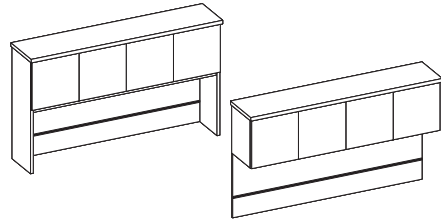

SPECIALTY VENEER ACCENTS
 bowfront inlay - ebony hardwood
 inlay detail

TOOL CHANNEL ACCESSORIES
 recessed aluminum tool channel

TOOL CHANNEL ACCESSORIES
 iphone holder

TOOL CHANNEL ACCESSORIES
 large shelf

Style Number	List Price
T11SA	1035

Style Number	List Price
ATB02	5 per 1"W

Style Number	List Price
ATB31	125

Style Number	List Price
ATB35	135

Specifications

- 3/16" x 3/16" thick hardwood ebony inlay is handfitted and glued into routed top and sanded flush with surface
- Inlay is finished over with all finish steps

Notes
 - Ebony inlay not recommended in: Koko Cherry

Specifications

- Anodized aluminum finish
- Fully recessed
- Finish matches anodized aluminum accessories
- Can be specified with fabric tack surface mounted above channel

Notes
 - If using tool channel with wallhung overhead, a veneer panel must be specified.

Specifications

- For Console/Wall Hung Back Panels With Optional Tool Bar
- 18 Gauge Steel - Stamp Formed
- Silver Powderdercoat Finish
- 5" x 3 -3/4"W
- Non-slip Neoprene pad

Specifications

- 12"W x 10"D

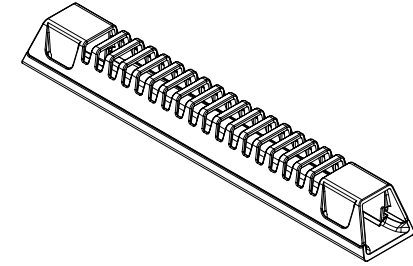
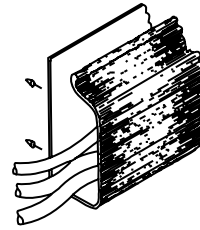
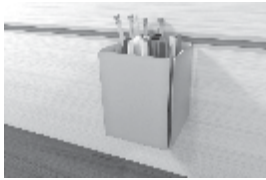

TOOL CHANNEL ACCESSORIES
pencil pen holder

TOOL CHANNEL ACCESSORIES
tablet holder

WIRE MANAGEMENT
horizontal j-channel wire
management raceway

WIRE MANAGEMENT
horizontal wire management raceway

Style Number	List Price
ATB38	120

Style Number	List Price
ATB30	145

Style Number	List Price
W1	80 Per 4' section

Style Number	List Price
W21	35

Specifications

- For Console/Wall Hung Back Panels With Optional Tool Bar
- 18 Gauge Steel - Stamp Formed
- Silver Powdercoat Finish
- 5"H x 4"W x 4"D

Specifications

- For Console/Wall Hung Back Panels With Optional Tool Bar
- 18 Gauge Steel - Stamp Formed
- Silver Powdercoat Finish
- 10" x 8"W
- Non-slip Neoprene pad

Specifications

- 4' section for field installation.
- The "J" shape black thermoplastic wire raceway may be added to specified worksurface tops to provide concealed channeling of wires to and from worksurface grommets. For use in open kneespace areas, raceway is attachable to top of back panel with pan head screws. Interior dimensions are 1" x 1- 1/2" providing ample storage for multiple wires and excess cable. Front of raceway flexes out for easy cord insertion.

- Notes
- Units w/ Wire Channel Standard.
 - Field Installation

Specifications

- 10"W x 1.5"D x 1.25"H
- Grey Wire Manager (10.5")
- Power and data cables can be discretely housed and managed with the W21 Gray Wire Manager. This can be mounted in any location to metal frame or underside of conference tables and runs cables through a 1" channel from power module to hollow steel legs. This keeps cables organized under the table top. Release clips make it simple to snap on and off the Wire Manager for easy organization and access after attached to the table

- Notes
- Field installed

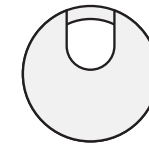
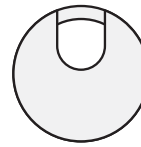

WIRE MANAGEMENT
horizontal u-channel wire
management raceway

WIRE MANAGEMENT
coil wire manager

WIRE MANAGEMENT
standard location grommets - factory
installed

WIRE MANAGEMENT
non-standard location grommets -
factory installed

Style Number	List Price
W2A	80 Per 4' section

Style Number	List Price
W18	160

Style Number	List Price
Standard Location Grommet	
Black	
TM30	50
Silver	
TM31	50
Antique Brass	
TM33	50
White	
TM34	50

Style Number	List Price
Non-Standard Location Grommet	
Black	
TM30 -NS	95
Silver	
TM31 -NS	95
Antique Brass	
TM33 -NS	95
White	
TM34 -NS	95

Specifications

- 4' section for field installation.

Notes

- Units w/ Wire Channel Standard.
- Field Installation

Specifications

- Weighted Base, Table attachment plate
- 39- 1/2" Length
- Black

Notes

- Location

Specifications

- 1 -5/8" Metal Grommet

Notes

- *Units w/ Grommets Standard Are Noted Under Standard Features. Grommets Match Pull Finish - Standard (Unless Specified Otherwise)

Specifications

- 1 -5/8" Metal Grommet

Notes

- *Units w/ Grommets Standard Are Noted Under Standard Features. Grommets Match Pull Finish - Standard (Unless Specified Otherwise)



WIRE MANAGEMENT

black plastic vertical surface
grommets - factory installed

Style Number	List Price
Standard Location Grommet TM50-C	50
Non-Standard Location Grommet TM50-NS	95

Specifications

- 2 " Black Plastic Grommet

Notes

- Standard Location is Bottom Center

Aircharge wireless charging grommet

Style Number	List Price
ACWG WIRELESS GROMMET	\$195



Specifications

- > When used with GROVE Tables an additional \$350 LIST will apply for the special cutout required.
- > AirCharge offers a convenient way to charge any Qi compatible smartphone or device without the need to carry charging cables or find an available power outlet.
- > The Aircharge is powered by the latest Qi compliant IC offering reliable and efficient wireless charging in a convenient 3" grommet hub. Simply place your phone on the Aircharge and an LED will confirm pairing and begin wireless charging.
- > Recess: Efficient space conservation and quick access
- > Input: DC 5V (with included AC power adapter), DC 9V, 1.67A (with optional QC 2.0 power adapter)
- > Output: 5 watts Max. with DC 5V, 2A power adapter, 10 watts Max. with QC 2.0 power adapter
- > Qi V1.2 compliant IC
- > Charging distance: 6mm Max.

Available: All DARRAN collections



DARRAN®

Cove power unit - non-linking

Style Number		List Price
PD-COVE PLUG		\$550
Non-linking version		

Specifications

- › Size 5.75"L x 2.5"W
- › (2) 15 Amp Receptacles and (2) USB charging ports
- › Surface Mount
- › 108" Cord
- › Standard Silver Finish, Available in White or Black Finish upon request
- › ETL Listed

Available: All DARRAN collections

Power & Data Options



Cove corded series

Style Number	List Price
 PD-COVE-PKO	\$800

Specifications

- > Size 9.5"L x 2.5"W x 3.18"D
- > When used with GROVE Tables an additional \$350 LIST will apply for the special cutout required.
- > (2) Power Receptacles, (2) 2.1 Amp USB charging ports and (1) Telecom Plate Knockout
- > Surface Mount
- > 108" Cord
- > Standard Silver Finish, Available in White or Black Finish upon request
- > ETL Listed

Available: All DARRAN collections

Telecom Plates

RJ45 (1)	\$55
RJ45 (2)	\$110
RJ45 (3)	\$165
USB (1)	\$70
USB (2)	\$140
RJ11/RJ45	\$110
RJ45/USB	\$125
RJ45/HDMI	\$210
HDMI/DVI	\$325
HDMI/USB	\$205
HDMI/VGA	\$240
VGA/MINI-STEREO	\$155
VGA/USB	\$175

This pod can have up to 1 total plates.
 *All telecom connectors sold separately.



DARRAN®

Soba wire manager

Style Number	List Price
STARTER UNITS	
SCDW	\$200
White wire manager	
SCDB	\$200
Black wire manager	

Specifications

- › Dimensions: 9ft x 9in x 3.15in
- › Zips up, bundles and routes loose, messy cables into a single tube
- › Routes and guides cables behind desks, TVs, and anywhere cables tend to get messy
- › Accommodates large or small cables, up to three cables at once
- › Support channels, used to route cables, include powerful adhesive backing which allows easy attachment to surfaces.

Available: All DARRAN collections

Power & Data Options



VILLA Power unit - non-linking

Style Number	List Price
 VIL-C PLUG	\$515
Non-Linking	

Specifications

- > Size: Top Grommet 5.68"L X 3.39"W; Under Top 12"L x 3.13"W x 3.08"D
- > (2) Power receptacles; (2) USB charging ports and (1) Knockouts for RJ45 Data Ports
- > Surface Mount
- > 72" Cord (Longer cord available, contact Customer Service)
- > Standard Silver Finish, Black Finish available upon request
- > UL or ETL Certified

Available: All DARRAN collections, excludes Grove

RJ45 Knockout	
RJ45 (1)	\$55

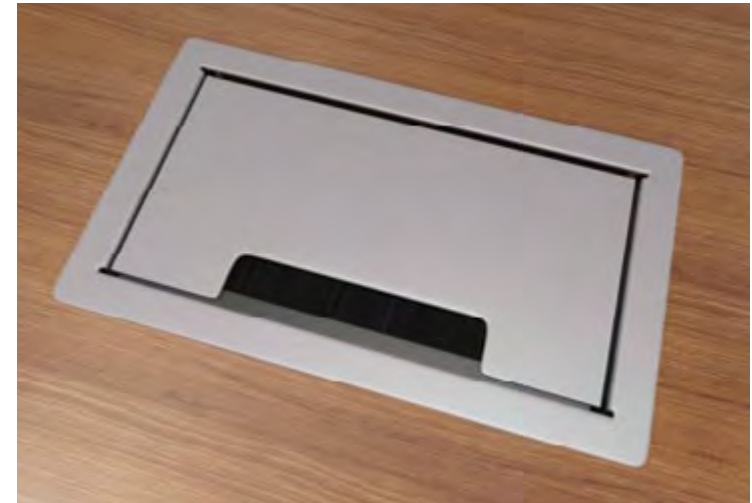



Boss Price List

Effective November 1, 2022

Date
11.11.22

Page

Modification
Price Increase

Description
9% price increase applied to all items excluding options

Statement of Line
Features & Advantages1
Finishes4
Edges | Pulls | Knobs.....5
Grommets | Grommet Reference.....6
Modesty Reference | Grain Direction.....7
Drawer Dimensions | Filing Reference8
Conferencing Credenzas9
Boat Conference Tables.....12
Table Frames15
Wall Hung Overheads16
Options18
Power & Data.....23

Statement of Line

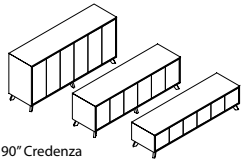

90° Credenza
Page 9
Conferencing Credenzas
Storage With Doors

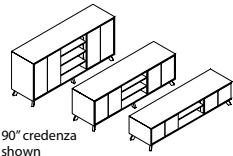

90° credenza
shown
Page 10
Conferencing Credenzas
Storage With Doors/ Open Center

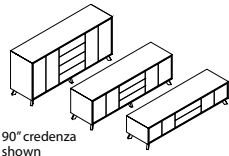

90° credenza
shown
Page 11
Conferencing Credenzas
Box Drawers/Storage With Doors

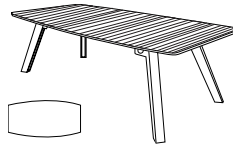

Page 12
Boat Conference Tables
Quartered Walnut Top

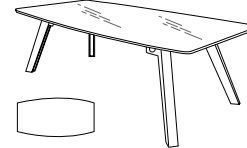

Page 13
Boat Conference Tables
10mm Ice White Glass Top

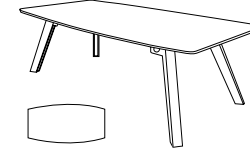

Page 14
Boat Conference Tables
2cm White Carrara Top Table

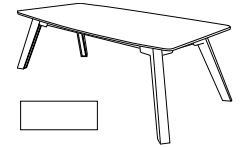

Page 15
Table Frame W/ Wood Aprons,
Legs & Subtop

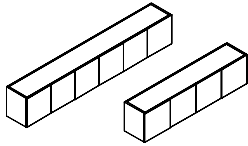

Page 16
Single Height Wall Hung Over-
heads
14" D Panel Doors - 2/3 Section

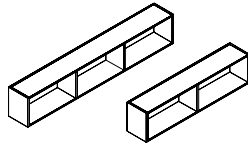

Page 17
Single Height Wall Hung Over-
heads
14" D Open Storage Cabinet - 2/3
Section

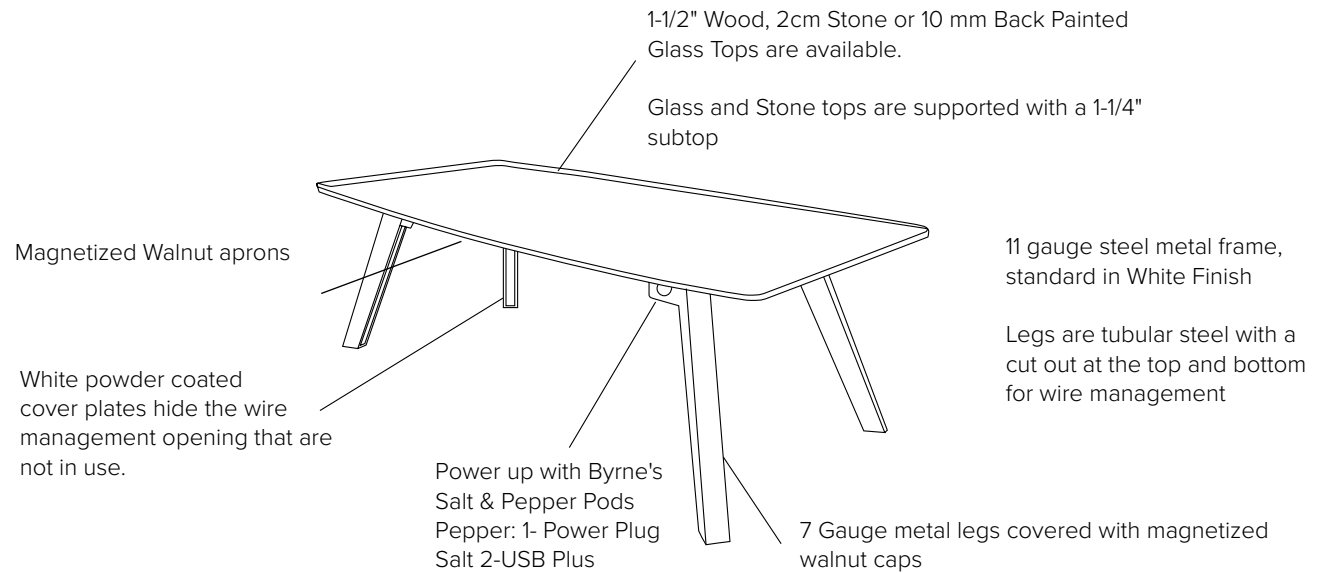
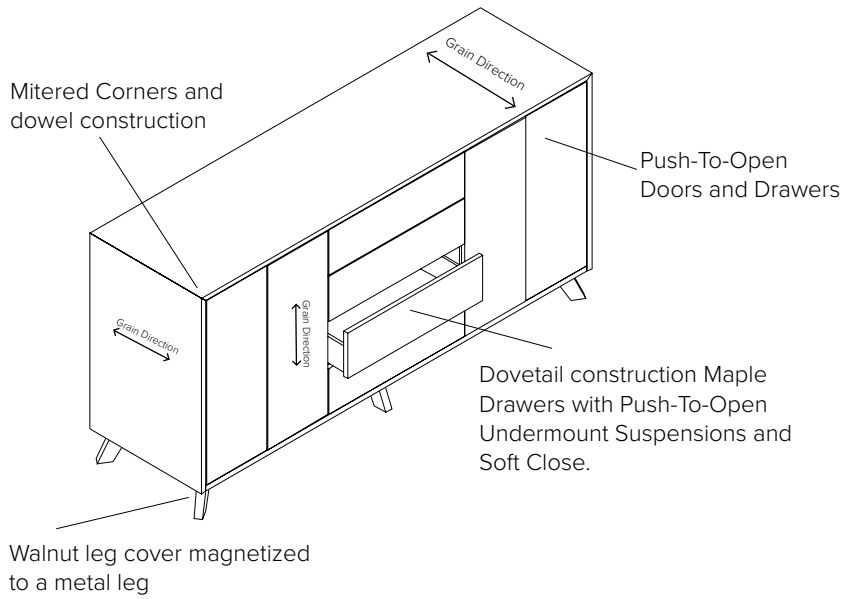

Veneer

Boss is standard with Quartered Walnut veneer that is slip-matched. They are cut perpendicular to a log's growth rings with quartered veneers and generally produce a very straight grain. Veneer leaves are cut consecutively and are easy to match. In many species, this method will reveal a decorative element in the wood. Quarter slicing produces smaller veneer leaves and has a higher-end veneer appearance. Boss veneers are slipmatched, meaning adjoining veneer leaves are fed out in sequence without being turned so that the same side of the veneer leaves is exposed. This allows the leaves' grain pattern to repeat across the face of the panel, improving color uniformity.

Veneer tops

Veneer table desk and Veneer conferencing tops are 1-1/8" thick on 45lb density MDF core comprised of 100% recycled and recovered wood fibers with a balanced 3-ply construction. All veneer tops are Quartered Walnut that is slipmatched and features a 3mm external solid hardwood band with profile edge. Tops are finished in a 5-sheen matte finish.

Cleaning wood & laminate

In addition to regular dusting, give your furniture an occasional cleaning in accordance with our cleaning instructions. DARRAN wood and laminate products can be cleaned with a soft cloth and a mild soap and water mixture. Use approximately 32 oz of water mixed with one tablespoon of dish soap, always wiping with the grain. Dry with a soft cloth, going with the grain, to avoid spotting or streaking.

Wood products should be waxed periodically using a non-wax liquid; please do not use any waxy polish or cleaner. Interior of drawers may also be cleaned with mild soap and water mixture, or any household cleaner that is not petroleum or thinner-based.

Chassis & pedestal

Chassis components are 1" thick core of particle board or MDF rated EPP/SCS/CARBII material with 3-ply balanced construction. Case construction features 90 degree mitered joints. All units are standard with 1" adjustable glides that allow for leveling.

Conference tops

1 1/2" thick core, Particleboard rated EPP/SCS/CARB-II material with 3 ply balanced construction. Quartered walnut veneers. Standard with hardwood rim bands.

Overhead cabinet construction Freestanding & wall mount

Freestanding Overhead storage cabinets are constructed of 1" and 3/4" thick core of particle board or MDF rated EPP/SCS/CARB-II material with 3-ply balanced construction. Panels are attached with cam fasteners in conjunction with dowels securely

adhered with glue. All surface mount cabinets connect to work surface with anti-slip tape. Wall mount cabinets are mounted to the wall with steel "z" bracket attachment method using 5mm euro screws to attach to the back of the cabinet. Units ship with a steel "z" bracket. This bracket is mounted to the wall by field installers. Installers are responsible for selecting and supplying appropriate fasteners for wall conditions.

Tackboards

Wall mount tackboards are constructed of .75" thick fiberboard. The fabric is precisely aligned and fitted to the tackboard with a sock on cover. Wall mount cabinets are mounted to the wall with steel "z" bracket attachment method using 5mm euro screws to attach to the back of the cabinet. All units ship with a steel "z" bracket. This bracket is mounted to the wall by field installers. Installers are responsible for selecting and supplying appropriate fasteners for wall conditions.

Adjustable glides

Glides provide 1" of vertical leveling adjustment. Glide bottom is durable metal. Glides are secured in solid wood blocks that are screwed and glued for durability.

Standard wood drawers

Maple drawers are dovetailed at corners. Sides are 1/2" thick with a 3/4" thick bottom. UV cured finish.

Doors & drawer fronts

Door and drawer fronts are vertically matched in balanced sets in Quartered walnut.

Suspensions

All caseloads utilize cold rolled steel zinc plated high-grade drawer suspensions. Box and File drawers are full extension, featuring steel ball bearings for a smoother quieter range of motion with soft close operation and are rated 100lbs. Lateral file drawers are a progressive action full extension suspension with the soft close operation and is rated at 150lbs. Lateral files include anti tip mechanism that will allow only one drawer at a time to be opened. All suspensions are soft close and are warranted for the lifetime of the product.

Hinges

Units with doors include 95 degree swing hinges

Locks

Locks are optional on all drawers/doors below the worksurface. Random lock cores are installed at the factory. Some units may be shipped with the same key number. Locks are Silver unless otherwise specified. DARRAN will also send lock cores separately to the dealer at your request. These units will be sent with an empty lock core and the Dealer will receive a shipment of the requested lock core/keys.

Keying

Keying is available either factory or field installed. Factory installed keying is random.

Wire management

Wire management capabilities include standard and optional worksurface grommets. Specify W-1 under surface wire channels for organization and management of all communication wires and cords. Horizontal J-Channel wire management (Sku: W-1) is sold separately to conceal wire under worksurfaces.

Grommets

Metal grommets are provided to match the drawer pull selection. Grommet is available in silver or white. Must specify standard or non-standard location. Black plastic grommets are available as an option for vertical applications..

Powerports

A large selection of power pods are available and handle power, data, docking stations and communication. See options section for selection.

LED Task Lights

LED task lighting provides high efficiency, low energy lighting with a long life. Surface mounted light is encased in silver aluminum channel with milk lense and rounded end caps. Lights are field installed. Product specifications listed below:

- Diffuser creates a softer light and eliminates hot spots
- Touch dimmer switch
- Can be “daisy chained” up to 90W
- 4.6 watts per foot
- 120 LEDs per meter
- Certification: UL Listed
- 50,000 hour life span.

Color Temp is 4000K

STANDARD VENEER	PREMIUM VENEER	HIGH PRESSURE LAMINATE	THERMALLY FUSED LAMINATE
WOW Clear Walnut	N/A	N/A	N/A
WEW Executive Walnut	N/A	N/A	N/A
WGW Gunstock Walnut	N/A	N/A	N/A
WBW Henna Walnut	N/A	N/A	N/A
WSW Smokey Walnut	N/A	N/A	N/A
WNW Natural Walnut	N/A	N/A	N/A

Boss Collection features Quartered Walnut Veneers

Send 3x3 or larger finish chip for color match. Custom finish upcharge is 3% or \$250 Net (whichever is greater).



Finish

Welltech Finish delivers a superior furniture coating with exceptional performance that can withstand stringent cleaning agents and possesses unparalleled durability, allowing DARRAN to provide lasting, sustainable products to our customers.

Boss Table Profile

Boss Profile - Only Available on Quartered Walnut Table

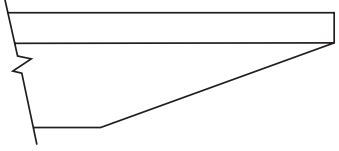

Push-To-Open
Doors and Drawers

Optional Wire Management Grommets

Factory Installed

When grommets are specified or standard in a unit, DARRAN provides wire channels under the surface for organization and management of all communication wires and cords.

Grommets (Standard Location)

Specify Color and Left/Right/Center - \$50 ea.

- Silver: TM31-R (Right), TM31-L (Left), TM31-C (Center)

- White: TM34-R (Right), TM34-L (Left), TM34-C (Center)

Grommets (Non-Standard Location)

Provide drawing w/ Grommet Location and Specify Color - \$95 ea.

- Silver: TM31-NS

- White: TM34-NS

TM31

Silver

1-5/8" Dia.

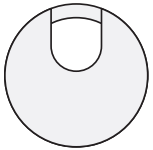

TM34

White

1-5/8" Dia.

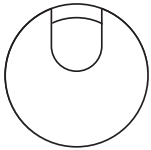

Grommets (vertical surface)

Standard Location - \$50 ea.

- Black Plastic Vertical Surface: TM50-C (Bottom Center)

Non-Standard Location - \$95 ea.

- Black Plastic Vertical Surface: TM50-NS

TM50

Black

1-5/8" Dia.

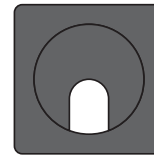

Veneer chassis parts are vertical grain. Doors feature vertical veneer matched vertically.

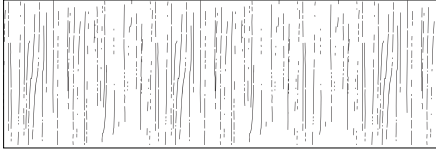

Credenza

INTERIOR DRAWER DIMENSIONS

UNIT DEPTH	DRAWER TYPE	OVERALL DIMENSIONS			INTERIOR DRAWER DIMENSIONS			NOTES
		W	D	H	W	D	H	
29" Wde	24" Box	27-7/8	18	5	26-7/8	17	3-3/4	Conference Box Drawers

Filing Reference

29" : 26-1/2" Wide File Drawer - 16-1/16" Deep

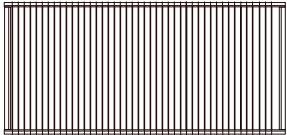

Legal Side to Side

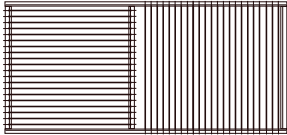

Legal Side to Side
Letter Front to Back
with File Rail

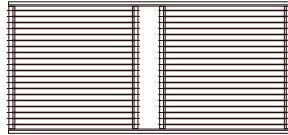

Letter Front to Back
with File Rail

Boss
 Conferencing Credenzas
 Storage With Doors

[Click here to view statement of line](#)

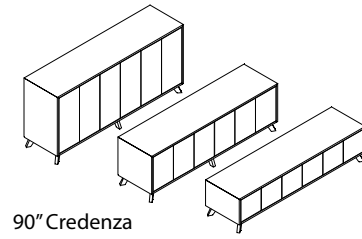

90" Credenza

1 Select Model

w" x d" x h"	Weight
90" 6 Door Storage Credenza	
90 x 24 x 42	490
90 x 24 x 30	330
90 x 24 x 22	220
84" 6 Door Storage Credenza	
84 x 24 x 42	460
84 x 24 x 30	310
84 x 24 x 22	205
72" 4 Door Storage Credenza	
72 x 24 x 42	395
72 x 24 x 30	265
72 x 24 x 22	180

2 Select Finish

- [Click to view finishes](#)
- WOW
 - WEW
 - WGW
 - WBW
 - WSW
 - WNW

3 Select Edge

- [Click to view edges](#)
- Edge
 - N/A

4 Select Hardware

- [Click to view details](#)
- Hardware
 - N/A

Standard Veneer Top Standard Veneer Chassis	Premium Veneer Top Premium Veneer Chassis	High Pressure Laminate Top Veneer Chassis	Thermally Fused Laminate Top Thermally Fused Laminate Chassis
BOS9042CA125W 8186	"P" Option N/A	"G" Option N/A	"M" Option N/A
BOS9030CA125W 7152	"P" Option N/A	"G" Option N/A	"M" Option N/A
BOS9022CA125W 6484	"P" Option N/A	"G" Option N/A	"M" Option N/A
BOS8442CA125W 7673	"P" Option N/A	"G" Option N/A	"M" Option N/A
BOS8430CA125W 6704	"P" Option N/A	"G" Option N/A	"M" Option N/A
BOS8422CA125W 6075	"P" Option N/A	"G" Option N/A	"M" Option N/A
BOS7242CA125W 6630	"P" Option N/A	"G" Option N/A	"M" Option N/A
BOS7230CA125W 5821	"P" Option N/A	"G" Option N/A	"M" Option N/A
BOS7222CA125W 5253	"P" Option N/A	"G" Option N/A	"M" Option N/A

Product Features

- 30" Height has 1 adjustable shelves per door section
- 42" Height has 2 adjustable shelves per door section
- Floor levelers (adjustable 1/2")
- Open Plan
- Quartered Walnut runs horizontally on case and vertically on doors. Top is short grain.

Notes

- Boss features push-to-open drawers and doors. Hardware is not available.
- Center vertical section will be removed when REF-01 option is specified. For interior cabinet dimensions contact factory

Options

- Door**
- D2: Wood Door Lock - \$100 per door set
 - D6: Delete Doors - n/c
 - WPD3061: Designer White Fronts - \$130 per 2 door section
- Refrigerator**

- REF-01: Specify Right or Left Refrigerator option (Water mat, heat vent and grommet hole) - \$205
- Option is available on BOS9042CA125, BOS8442CA125, BOS-7242CA125

Trash Can

- Specify Location
- TRC50: EZ Cargo 50 dual trash can - (f) 8 gallon and (f) 5 gallon - \$680
 - Option is available on BOS9042CA125, BOS8442CA125, BOS-7242CA125

Boss

Conferencing Credenzas
Storage With Doors/ Open Center

[Click here to view statement of line](#)

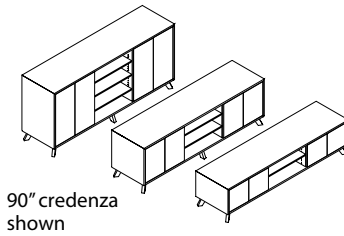

90" credenza shown

1 Select Model

w" x d" x h"

Weight

	Standard Veneer Top Standard Veneer Chassis	Premium Veneer Top Premium Veneer Chassis	High Pressure Laminate Top Veneer Chassis	Thermally Fused Laminate Top Thermally Fused Laminate Chassis
90" 4 Door Open/Storage Credenza				
90 x 24 x 42	470 BOS9042CA128W 7919	"P" Option N/A	"G" Option N/A	"M" Option N/A
90 x 24 x 30	310 BOS9030CA128W 6950	"P" Option N/A	"G" Option N/A	"M" Option N/A
90 x 24 x 22	200 BOS9022CA128W 6350	"P" Option N/A	"G" Option N/A	"M" Option N/A
84" 4 Door Open/Storage Credenza				
84 x 24 x 42	440 BOS8442CA128W 7424	"P" Option N/A	"G" Option N/A	"M" Option N/A
84 x 24 x 30	290 BOS8430CA128W 6517	"P" Option N/A	"G" Option N/A	"M" Option N/A
84 x 24 x 22	185 BOS8422CA128W 5949	"P" Option N/A	"G" Option N/A	"M" Option N/A
72" 2 Door Open/Storage Credenza				
72 x 24 x 42	375 BOS7242CA128W 6416	"P" Option N/A	"G" Option N/A	"M" Option N/A
72 x 24 x 30	245 BOS7230CA128W 5635	"P" Option N/A	"G" Option N/A	"M" Option N/A
72 x 24 x 22	160 BOS7222CA128W 5147	"P" Option N/A	"G" Option N/A	"M" Option N/A

2 Select Finish

[Click to view finishes](#)

- WOW
- WEW
- WGW
- WBW
- WSW
- WNW

3 Select Edge

[Click to view edges](#)

Edge
N/A

4 Select Hardware

[Click to view details](#)

Hardware
N/A

Product Features

- 30" Height has 1 adjustable shelves per door section
- 42" Height has 2 adjustable shelves per door section
- Floor levelers (adjustable 1/2")
- Open Plan
- Quartered Walnut runs horizontally on case and vertically on doors. Top is short grain.

Notes

- Boss features push-to-open drawers and doors. Hardware is not available.
- Center vertical section will be removed when REF-01 option is specified. For interior cabinet dimensions contact factory

Options

Door

- D2: Wood Door Lock - \$100 per door set
- D6: Delete Doors - n/c
- WPD3061: Designer White Fronts - \$130 per 2 door section

Refrigerator

- REF-01: Specify Right or Left Refrigerator option (Water mat, heat vent and grommet hole) - \$205
- Option is available on BOS9042CA128, BOS8442CA128, BOS-7242CA128

Trash Can

Specify Location

- TRC50: EZ Cargo 50 dual trash can - (f) 8 gallon and (f) 5 gallon - \$680
- Option is available on BOS9042CA128, BOS8442CA128, BOS-7242CA128

Boss

Conferencing Credenzas Box Drawers/Storage With Doors

[Click here to view statement of line](#)

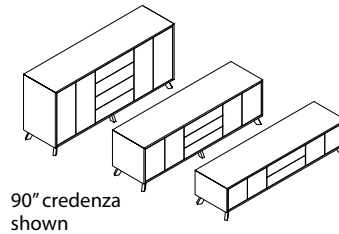

90" credenza shown

1 Select Model

w" x d" x h"

Weight

		Standard Veneer Top Standard Veneer Chassis	Premium Veneer Top Premium Veneer Chassis	High Pressure Laminate Top Veneer Chassis	Thermally Fused Laminate Top Thermally Fused Laminate Chassis
90" 4 Door/Drawer Storage Credenza					
90 x 24 x 42	490	BOS9042CA139W 9924	"P" Option N/A	"G" Option N/A	"M" Option N/A
90 x 24 x 30	330	BOS9030CA139W 8328	"P" Option N/A	"G" Option N/A	"M" Option N/A
90 x 24 x 22	220	BOS9022CA139W 7358	"P" Option N/A	"G" Option N/A	"M" Option N/A
84" 4 Door/4 Drawer Storage Credenza					
84 x 24 x 42	460	BOS8442CA139W 9396	"P" Option N/A	"G" Option N/A	"M" Option N/A
84 x 24 x 30	310	BOS8430CA139W 7872	"P" Option N/A	"G" Option N/A	"M" Option N/A
84 x 24 x 22	205	BOS8422CA139W 6944	"P" Option N/A	"G" Option N/A	"M" Option N/A
72" 2 Door/ Drawer Storage Credenza					
72 x 24 x 42	395	BOS7242CA139W 8319	"P" Option N/A	"G" Option N/A	"M" Option N/A
72 x 24 x 30	265	BOS7230CA139W 6957	"P" Option N/A	"G" Option N/A	"M" Option N/A
72 x 24 x 22	180	BOS7222CA139W 6102	"P" Option N/A	"G" Option N/A	"M" Option N/A

2 Select Finish

[Click to view finishes](#)

- WOW
- WEW
- WGW
- WBW
- WSW
- WNW

3 Select Edge

[Click to view edges](#)

- Edge
- N/A

4 Select Hardware

[Click to view details](#)

- Hardware
- N/A

Product Features

- 30" Height has 1 adjustable shelves per door section
- 42" Height has 2 adjustable shelves per door section
- Drawers feature soft close suspension
- Floor levelers (adjustable 1/2")
- Open Plan
- Quartered Walnut runs horizontally on case and vertically on doors. Top is short grain.

Notes

- Boss features push-to-open drawers and doors. Hardware is not available.
- For interior cabinet dimensions contact factory

Options

Door

- D2: Wood Door Lock - \$100 per door set
- D6: Delete Doors - n/c
- WPD3061: Designer White Fronts - \$130 per 2 door section
- WPD3062: Designer White Fronts - \$65 per drawer

Drawer

- P21U: Modify upper box/box to lateral - n/c
- P21L: Modify lower box/box to lateral - n/c

Refrigerator

- REF-01: Specify Right or Left Refrigerator option (Water mat, heat vent and grommet hole) - \$205
- Option is available on BOS9042CA139, BOS8442CA139, BOS-7242CA139

Trash Can

Specify Location

- TRC50: EZ Cargo 50 dual trash can - (f) 8 gallon and (f) 5 gallon - \$680
- Option is available on BOS9042CA139, BOS8442CA139, BOS-7242CA139

Boss

Boat Conference Tables
 Quartered Walnut Top

[Click here to view statement of line](#)

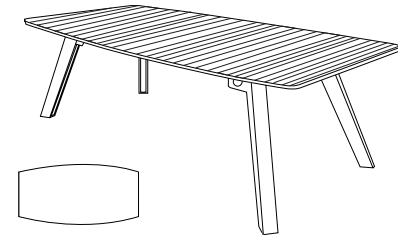

1 Select Model

w" x d" x h"	Weight
72 x 42 x 30	240
84 x 42 x 30	280
96 x 48 x 30	315

Standard Veneer Top Standard Veneer Chassis		Premium Veneer Top Premium Veneer Chassis	High Pressure Laminate Top Veneer Chassis	Thermally Fused Laminate Top Thermally Fused Laminate Chassis
BOS7242WT200W	6416	"P" Option N/A	"G" Option N/A	"M" Option N/A
BOS8442WT200W	6998	"P" Option N/A	"G" Option N/A	"M" Option N/A
BOS9648WT200W	7392	"P" Option N/A	"G" Option N/A	"M" Option N/A

Product Features

- 1.5" thick Quartered Walnut Top
- Adjustable Glides
- Hidden Wire Management down each leg, specify legs to be powered
- Quartered Walnut Runs Short Grain
- White steel Frame with magnetized solid wood aprons and leg caps
- Tops and bases are pre-located to ensure proper installation location

Notes

- Table Ships KD

Options

Power

- PDP01: Pepper (Power) - \$95 ea.
- PDS01: Salt (Powered USB) - \$225 ea.
- PD717: Power Supply Cordset - \$100 ea.
- Can specify up to 8 total power units (Specify location on drawing)
- W1: Horizontal J-Channel Wire Management Raceway - \$80 per 4'

2 Select Finish

[Click to view finishes](#)

- WOW
- WEW
- WGW
- WBW
- WSW
- WNW

3 Select Edge

[Click to view edges](#)



4 Select Hardware

[Click to view details](#)

Hardware
N/A

Boss

Boat Conference Tables
10mm Ice White Glass Top

[Click here to view statement of line](#)

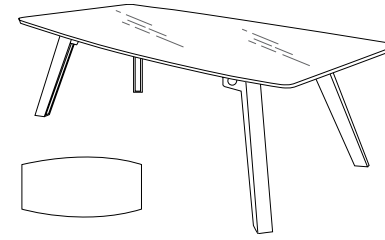

1 Select Model

w" x d" x h"	Weight
72 x 42 x 30	300
84 x 42 x 30	350
96 x 48 x 30	560

Glass Top Veneer Base		High Pressure Laminate Top Veneer Chassis	Thermally Fused Laminate Top Thermally Fused Laminate Chassis
BOS7242GT200W	11521	"P" Option N/A	"M" Option N/A
BOS8442GT200W	12864	"P" Option N/A	"M" Option N/A
BOS9648GT200W	14261	"P" Option N/A	"M" Option N/A

Product Features

- 10mm Ice White Glass Top
- 1-1/4" Subtop
- Adjustable glides
- Hidden Wire Management down each leg, specify legs to be powered
- White steel Frame with magnetized solid wood aprons and leg caps

Notes

- Table Ships KD

Options

Power

- PDP01: Pepper (Power) - \$95 ea.
- PDS01: Salt (Powered USB) - \$225 ea.
- PD717: Power Supply Cordset - \$100 ea.
- Can specify up to 8 total power units (Specify location on drawing)
- W1: Horizontal J-Channel Wire Management Raceway - \$80 per 4'

2 Select Finish

[Click to view finishes](#)

- WOW
- WEW
- WGW
- WBW
- WSW
- WNV

3 Select Edge

[Click to view edges](#)



4 Select Hardware

[Click to view details](#)

- Hardware
- N/A

Boss

Boat Conference Tables
2cm White Carrara Top Table

[Click here to view statement of line](#)

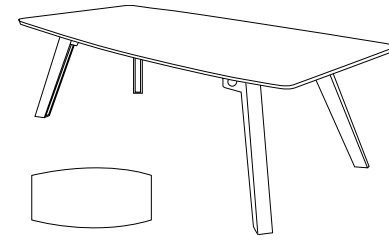

1 Select Model

w" x d" x h"	Weight
72 x 42 x 30	555
84 x 42 x 30	632
96 x 48 x 30	800

Stone Top Veneer Base		High Pressure Laminate Top Veneer Chassis	Thermally Fused Laminate Top Thermally Fused Laminate Chassis
BOS7242ST200W	13331	"P" Option N/A	"M" Option N/A
BOS8442ST200W	15429	"P" Option N/A	"M" Option N/A
BOS9648ST200W	17843	"P" Option N/A	"M" Option N/A

Product Features

- 1-1/4" Subtop
- 2cm White Carrara Top Table
- Adjustable glides
- Hidden Wire Management down each leg, specify legs to be powered
- White steel Frame with magnetized solid wood aprons and leg caps

Notes

- Table Ships KD

Options

Power

- PDP01: Pepper (Power) - \$95 ea.
- PDS01: Salt (Powered USB) - \$225 ea.
- PD717: Power Supply Cordset - \$100 ea.
- Can specify up to 8 total power units (Specify location on drawing)
- W1: Horizontal J-Channel Wire Management Raceway - \$80 per 4'

2 Select Finish

[Click to view finishes](#)

- WOW
- WEW
- WGW
- WBW
- WSW
- WNW

3 Select Edge

[Click to view edges](#)



4 Select Hardware

[Click to view details](#)

- Hardware
- N/A

Boss

Table Frame

Table Frame W/ Wood Aprons, Legs & Subtop

[Click here to view statement of line](#)

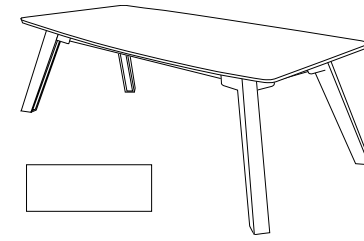

1 Select Model

w" x d" x h"	Weight
66 x 36 x 29	140
78 x 36 x 29	165
90 x 42 x 29	220

Standard Veneer Top Standard Veneer Chassis		Premium Veneer Top Premium Veneer Chassis	High Pressure Laminate Top Veneer Chassis	Thermally Fused Laminate Top
BOS7242FO199W	6102	"P" Option N/A	"G" Option N/A	"M" Option N/A
BOS8442FO199W	6469	"P" Option N/A	"G" Option N/A	"M" Option N/A
BOS9648FO199W	6858	"P" Option N/A	"G" Option N/A	"M" Option N/A

Product Features

- Adjustable glides
- Edge of subtop matches leg finish
- Hidden Wire Management down each leg, specify legs to be powered
- Steel Frame with magnetized solid wood aprons and leg caps
- Top & Bottom of Subtop is Finished Black (Template is available upon request for customers own top material)
- Does not include finished top

Notes

- Frame Ships KD

Options

Power

- PDP01: Pepper (Power) - \$95 ea.
- PDS01: Salt (Powered USB) - \$225 ea.
- PD717: Power Supply Cordset - \$100 ea.
- Can specify up to 8 total power units (Specify location on drawing)
- W1: Horizontal J-Channel Wire Management Raceway - \$80 per 4'

2 Select Finish

[Click to view finishes](#)

- WOW
- WEW
- WGW
- WBW
- WSW
- WNW

3 Select Edge

[Click to view edges](#)



4 Select Hardware

[Click to view details](#)

- Hardware
- N/A

Boss

Single Height Wall Hung Overheads
14" D Panel Doors - 2/3 Section

[Click here to view statement of line](#)

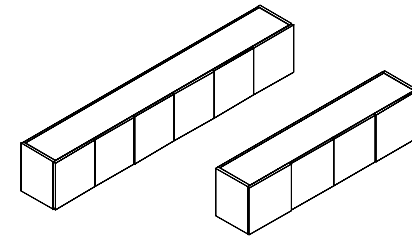

1 Select Model

w" x d" x h"	Weight
6 Door / 3 Section 90 x 14 x 18	240
4 Door / 2 Section 84 x 14 x 18	210
72 x 14 x 18	180

	Standard Veneer Top Standard Veneer Chassis	Premium Veneer Top Premium Veneer Chassis	High Pressure Laminate Top Veneer Chassis	Thermally Fused Laminate Top
	BOS9018WH330W 4442	"P" Option N/A	"G" Option N/A	"M" Option N/A
	BOS8418WH330W 4307	"P" Option N/A	"G" Option N/A	"M" Option N/A
	BOS7218WH330W 3550	"P" Option N/A	"G" Option N/A	"M" Option N/A

2 Select Finish

Click to view finishes	WOW
	WEW
	WGW
	WBW
	WSW
	WNW

3 Select Edge

Click to view edges	Edge
	N/A

4 Select Hardware

Click to view details	Hardware
	N/A

Product Features

- Doors fully matched set, quarter grain runs vertical
- Finished top
- Interior cabinet depth 12"
- Mounting wall rail included
- Touch latch doors standard

Notes

- The DARRAN wall mounted cabinet(or shelf) must be hung on a weight-bearing wall. The suitability of the wall supporting the wall mounted cabinet, and the installation and maintenance of the wall-mounted cabinet, is the sole responsibility of the customer. Failure to correctly install and/or exceed the loaded weight capacity of this product may cause it to fall, resulting in damage to the product, adjacent property and/or bodily injury.

Options

Door

- D2: Door Lock - \$100 per door set
- D6: Delete doors - n/c
- PD717: Power Supply Cordset - \$109 ea.
- RF375AW: Aluminum/White Glass - \$395 per door
- WPD3061: Designer White - \$35 per door

Legal Depth

- MLD1: Modify to legal depth 18" - 10% upcharge

Task Light

- LT-LED24: 24" LED Task light - \$215
- LT-LED48: 48" LED Task light - \$270
- LT-LED60: 60" LED Task light - \$335
- LT-LED72: 72" LED Task light - \$360

Boss

Single Height Wall Hung Overheads
14" D Open Storage Cabinet - 2/3 Section

[Click here to view statement of line](#)

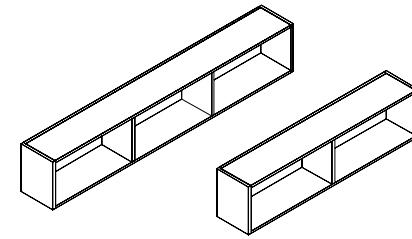

1 Select Model

w" x d" x h"	Weight
3 Section	
90 x 14 x 18	225
84 x 14 x 18	200
2 Section	
72 x 14 x 18	170

	Standard Veneer Top Standard Veneer Chassis	Premium Veneer Top Premium Veneer Chassis	High Pressure Laminate Top Veneer Chassis	Thermally Fused Laminate Top
	BOS9018WH332W 4223	"P" Option N/A	"G" Option N/A	"M" Option N/A
	BOS8418WH332W 4148	"P" Option N/A	"G" Option N/A	"M" Option N/A
	BOS7218WH332W 3370	"P" Option N/A	"G" Option N/A	"M" Option N/A

2 Select Finish

[Click to view finishes](#)

- WOW
- WEW
- WGW
- WBW
- WSW
- WNW

3 Select Edge

[Click to view edges](#)

- Edge
- N/A

4 Select Hardware

[Click to view details](#)

- Hardware
- N/A

Product Features

- Finished top
- Interior cabinet depth 12"
- Mounting wall rail included

Notes

- 3 Section Overhead Available w/ 1 or 2 Sliding Doors
- 2 Section available w/ 1 sliding door
- The DARRAN wall mounted cabinet(or shelf) must be hung on a weight-bearing wall. The suitability of the wall supporting the wall mounted cabinet, and the installation and maintenance of the wall-mounted cabinet, is the sole responsibility of the customer. Failure to correctly install and/or exceed the loaded weight capacity of this product may cause it to fall, resulting in damage to the product, adjacent property and/or bodily injury.

Options

Sliding Doors

- RF550AW: Aluminum/White Glass - \$575 per door
- SLD17WD: Panel Door - \$260 per door
- SLD17WP: White Painted Door - \$340 per door

Interior Cabinet Light

- LEDPK starter kit includes Infeed, 1 Puck Interior Light and the ability to daisy chain up to 6 total Puck Lights
- LEDPK: LED Puck Starter Kit - \$310
- PK: 1 LED Interior Light - \$130 ea.

Legal Depth

- MLD1: Modify to legal depth 18" - 10% upcharge

Task Light

- LT-LED24: 24" LED Task light - \$215
- LT-LED48: 48" LED Task light - \$270
- LT-LED60: 60" LED Task light - \$335
- LT-LED72: 72" LED Task light - \$360



COMPUTER SUPPORT
single monitor arm

COMPUTER SUPPORT
double monitor arm

COMPUTER SUPPORT
triple monitor arm

COMPUTER SUPPORT
quadruple monitor arm

Style Number	List Price
MA1	280

Style Number	List Price
MA2	450

Style Number	List Price
MA3	530

Style Number	List Price
MA4	705

Specifications

- Available in black or silver
- Desk clamp and mounting included
- Easy assembly and flexibility
- Elastic painting process for a durable and beautiful finish
- Gas spring tension adjustment for counter-balance height adjustment for monitors 1-8 KG
- Gas spring tested to 50,000 repetitions
- Hidden cable management

Specifications

- Available in black or silver
- Desk clamp and mounting included
- Easy assembly and flexibility
- Elastic painting process for a durable and beautiful finish
- Gas spring tension adjustment for counter-balance height adjustment for monitors 1-8 KG
- Gas spring tested to 50,000 repetitions
- Hidden cable management

Specifications

- Available in black or silver
- Desk clamp and mounting included
- Easy assembly and flexibility
- Elastic painting process for a durable and beautiful finish
- Gas spring tension adjustment for counter-balance height adjustment for monitors 1-8 KG
- Gas spring tested to 50,000 repetitions
- Hidden cable management

Specifications

- Available in black
- Desk clamp and mounting included
- Easy assembly and flexibility
- Elastic painting process for a durable and beautiful finish
- Gas spring tension adjustment for counter-balance height adjustment for monitors 1-8 KG
- Gas spring tested to 50,000 repetitions
- Hidden cable management

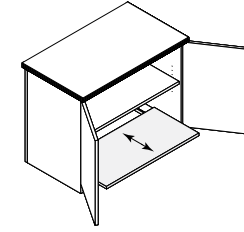
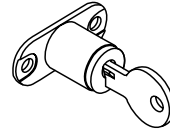
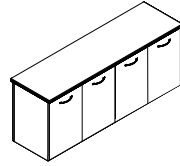

DOOR MODIFICATIONS
soft close door hinge

DOOR MODIFICATIONS
delete doors

DOOR MODIFICATIONS
panel door lock

PEDESTAL MODIFICATIONS
black laminate printer pullout bottom shelf

Style Number	List Price
D9SC	20 Per door

Style Number	List Price
D6	N/C

Style Number	List Price
D2	100 Per door set

Style Number	List Price
PPOS	225

Specifications

- Snap onto standard darran hinge
- Requires (2) per door
- Max door height 43"
- Factory installed where specified
- Individually shipped for field installation

Notes
- Specify Each Item To Have Slow Close Feature

Specifications

- Standard Door cabinets can have door deleted for open access. Modification of hinge rails and structural components are made face ready.

Specifications

- Door Locks - 1 Door w/ Lock, Other Door w/ Catch Latch
- Contact Customer Service regarding limited lock locations and keying.

Notes
- Available on: Panel Doors, Wood Frame Doors, and Silverluma doors

Specifications

- Black Laminate pullout shelf on suspension
- Black grommet in back
- Adjustable Shelf

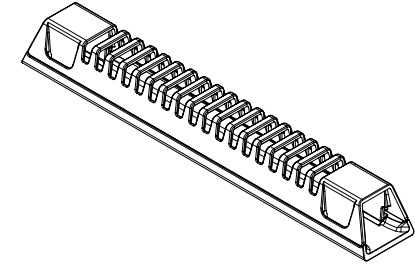
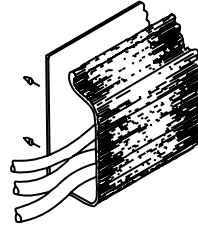
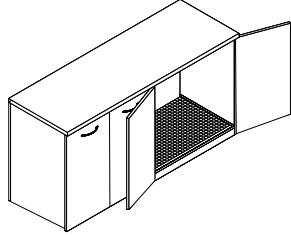
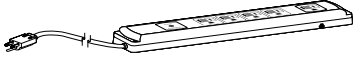

POWER / DATA
power supply cordset

REFRIGERATOR MODIFICATION
refrigerator cabinet modification

WIRE MANAGEMENT
horizontal j-channel wire
management raceway

WIRE MANAGEMENT
horizontal wire management raceway

Style Number	List Price
PD717	100

Style Number	List Price
REF01	205

Style Number	List Price
W1	80 Per 4' section

Style Number	List Price
W21	35

Specifications

- SIZE: 10.75"L x 2.0"W x 1.06"H
- (5) Outlets w/ 10' cord
- Surge suppression (720 Joules)
- 15 Amp breaker
- Available on: Vertical Panels, Cabinet Interiors, and under tops

Specifications

- Open back cutout for venting
- Moisture sponge mat
- Contaminate ledge
- Contact customer service for maximum refrigerator size (Changes based on unit).

Notes
- Available on: 36" and 42" Storage Credenzas

Specifications

- 4' section for field installation.
- The "J" shape black thermoplastic wire raceway may be added to specified worksurface tops to provide concealed channeling of wires to and from worksurface grommets. For use in open kneespace areas, raceway is attachable to top of back panel with pan head screws. Interior dimensions are 1" x 1- 1/2" providing ample storage for multiple wires and excess cable. Front of raceway flexes out for easy cord insertion.

Notes
- Units w/ Wire Channel Standard.
- Field Installation

Specifications

- 10"W x 1.5"D x 1.25"H
- Grey Wire Manager (10.5")
- Power and data cables can be discretely housed and managed with the W21 Gray Wire Manager. This can be mounted in any location to metal frame or underside of conference tables and runs cables through a 1" channel from power module to hollow steel legs. This keeps cables organized under the table top. Release clips make it simple to snap on and off the Wire Manager for easy organization and access after attached to the table

Notes
- Field installed

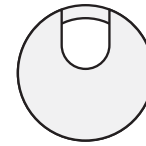
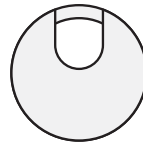

WIRE MANAGEMENT
horizontal u-channel wire management raceway

WIRE MANAGEMENT
coil wire manager

WIRE MANAGEMENT
standard location grommets - factory installed

WIRE MANAGEMENT
non-standard location grommets - factory installed

Style Number	List Price
W2A	80 Per 4' section

Style Number	List Price
W18	160

Style Number	List Price
Standard Location Grommet	
Black	
TM30	50
Silver	
TM31	50
Antique Brass	
TM33	50
White	
TM34	50

Style Number	List Price
Non-Standard Location Grommet	
Black	
TM30 -NS	95
Silver	
TM31 -NS	95
Antique Brass	
TM33 -NS	95
White	
TM34 -NS	95

Specifications

- 4' section for field installation.

Notes
- Units w/ Wire Channel Standard.
- Field Installation

Specifications

- Weighted Base, Table attachment plate
- 39- 1/2" Length
- Black

Notes
- Location

Specifications

- 1 -5/8" Metal Grommet

Notes
- *Units w/ Grommets Standard Are Noted Under Standard Features. Grommets Match Pull Finish - Standard (Unless Specified Otherwise)

Specifications

- 1 -5/8" Metal Grommet

Notes
- *Units w/ Grommets Standard Are Noted Under Standard Features. Grommets Match Pull Finish - Standard (Unless Specified Otherwise)



WIRE MANAGEMENT

black plastic vertical surface
grommets - factory installed

Style Number	List Price
Standard Location Grommet TM50-C	50
Non-Standard Location Grommet TM50-NS	95

Specifications

- 2 " Black Plastic Grommet

Notes

- Standard Location is Bottom Center

DARRAN®

Aircharge wireless charging grommet

Style Number	List Price
 ACWG WIRELESS GROMMET	\$213

Specifications

- > When used with GROVE Tables an additional \$350 LIST will apply for the special cutout required.
- > AirCharge offers a convenient way to charge any Qi compatible smartphone or device without the need to carry charging cables or find an available power outlet.
- > The Aircharge is powered by the latest Qi compliant IC offering reliable and efficient wireless charging in a convenient 3" grommet hub. Simply place your phone on the Aircharge and an LED will confirm pairing and begin wireless charging.
- > Recess: Efficient space conservation and quick access
- > Input: DC 5V (with included AC power adapter), DC 9V, 1.67A (with optional QC 2.0 power adapter)
- > Output: 5 watts Max. with DC 5V, 2A power adapter, 10 watts Max. with QC 2.0 power adapter
- > Qi V1.2 compliant IC
- > Charging distance: 6mm Max.

Available: All DARRAN collections

Power & Data Options



DARRAN®

Cove power unit - non-linking

Style Number	List Price
 PD-COVE PLUG	\$600
Non-linking version	

Specifications

- › Size 5.75"L x 2.5"W
- › (2) 15 Amp Receptacles and (2) USB charging ports
- › Surface Mount
- › 108" Cord
- › Standard Silver Finish, Available in White or Black Finish upon request
- › ETL Listed

Available: All DARRAN collections

Power & Data Options



Cove corded series

Style Number	List Price
 PD-COVE-PKO	\$872

Specifications

- > Size 9.5"L x 2.5"W x 3.18"D
- > When used with GROVE Tables an additional \$350 LIST will apply for the special cutout required.
- > (2) Power Receptacles, (2) 2.1 Amp USB charging ports and (1) Telecom Plate Knockout
- > Surface Mount
- > 108" Cord
- > Standard Silver Finish, Available in White or Black Finish upon request
- > ETL Listed

Available: All DARRAN collections

Telecom Plates

RJ45 (1)	\$55
RJ45 (2)	\$110
RJ45 (3)	\$165
USB (1)	\$70
USB (2)	\$140
RJ11/RJ45	\$90
RJ45/USB	\$125
RJ45/HDMI	\$210
HDMI/DVI	\$325
HDMI/USB	\$205
HDMI/VGA	\$240
VGA/MINI-STEREO	\$155
VGA/USB	\$175

This pod can have up to 1 total plates.
 *All telecom connectors sold separately.



Reef power unit with daisylink

Style Number	List Price
 REF310 PLUG	\$1199

Specifications

- > Size 16.1"L x 6.25"W x 4.89"D
- > When used with GROVE Tables an additional \$350 LIST will apply for the special cutout required.
- > (3) 120V Receptacles, (2) USB charging ports, 1 Data Plate Knockout, (2) Knockouts for RJ45 Data Ports
- > Surface Mount
- > 108" Cord
- > Features Convenience Plug on bottom of unit that allows for max (3) Daisy Chain
- > Standard Black Finish, Available in White or Silver Finish upon request
- > Additional Telecom Plate Knockout
- > RJ45 for Knockouts not required. If not ordered a small hole will be present in the pod in this this location
- > ETL Listed

Available: Conferencing

Telecom Plates	
RJ45 (1)	\$55
RJ45 (2)	\$110
RJ45 (3)	\$165
USB (1)	\$70
USB (2)	\$140
RJ11/RJ45	\$90
RJ45/USB	\$125
RJ45/HDMI	\$210
HDMI/DVI	\$325
HDMI/USB	\$205
HDMI/VGA	\$240
VGA/MINI-STEREO	\$155
VGA/USB	\$175

This pod can have up to 1 total plates.
*All telecom connectors sold separately.

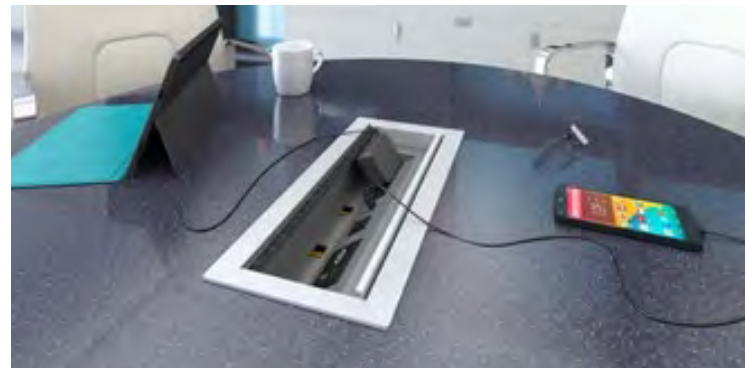

DARRAN®

Salt & pepper power ports

Style Number	List Price
 PDP01 Pepper (power)	\$95
PDS01 Salt (powered USB)	\$225

Specifications

- › Pepper port includes 1 power plug
- › Salt port includes 2 power USB
- › Cord is 72" long
- › Spill-proof technology

Available: Boss, Spire

Power & Data Options



Pepper power pod



Salt powered USB



DARRAN®

VILLA Power unit - non-linking

Style Number	List Price
 VIL-C PLUG	\$562
Non-Linking	

Specifications

- > Size: Top Grommet 5.68"L X 3.39"W; Under Top 12"L x 3.13"W x 3.08"D
- > (2) Power receptacles; (2) USB charging ports and (1) Knockouts for RJ45 Data Ports
- > Surface Mount
- > 72" Cord (Longer cord available, contact Customer Service)
- > Standard Silver Finish, Black Finish available upon request
- > UL or ETL Certified

Available: All DARRAN collections, excludes Grove

RJ45 Knockout	
RJ45 (1)	\$55

Power & Data Options

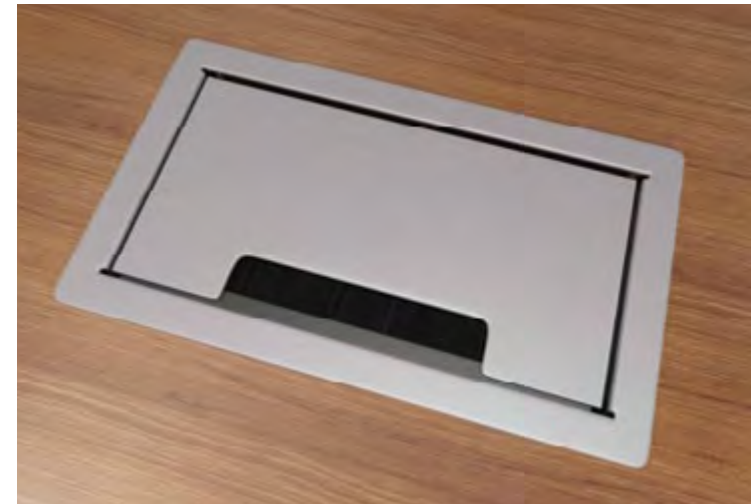



Honey Price List

Effective November 1, 2022

Designed By Mark Müller and Chris Wright

Date	Page	Modification	Description
9.14.22		Removed power block options	
11.07.22	146	Height of workstation chaged from 1" to 55"	
11.11.22		9% price increase applied to all items and accessories excluding options	
11.15.22		Hardwired Power Feed 120" HPF20 changed to 192" HPF192	
11.17.22		PET Screens added to 90°	
1.03.23	91	Updated pricing	
2.16.23	73	In-Line Panel Connector width changed to 16"	
2.20.23		Added 9% increase to DFT, DFP, DHA	

Statement of Line

Features & Advantages1

Fabric & Leather Program3

Finishes | Specifications6

Metal Finishes | Specifications.....7

PET | Specifications.....8

Edges | Specifications9

Pulls10

Grommets11

Grain Direction12

Honey Wire Management.....13

Honey Workstation Dimensions.....14

Honey New York Power16

Honey West Coast Power17

Chicago Power.....18

Drawer Dimenisons.....19

Honey 120 degree Typical.....20

Honey Lounge.....68

120 degree Honey Panels.....69

Power Entry Box.....78

Tops.....79

Fixed Tables.....81

Privacy Screens.....83

Storage Credenzas.....86

Wardrobe Storage.....88

Mobile Pedestal.....91

Honey 120 Mobile Workstation.....92

120 Degree Return Top94

90 Degree Honey.....97

90 Degree Typical.....98

90 Degree Panels.....134

90 Degree Worksurfaces143

90 Degree Mobile Workstations.....145

90 Degree Privacy Screens147

Options149

Power I Specifications.....158

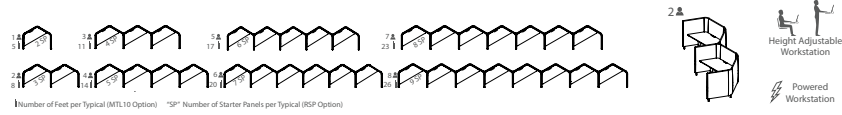

Page 20
Inline Diagonal Workstation Typical
Position 1 with Height Adjustable Worksurface

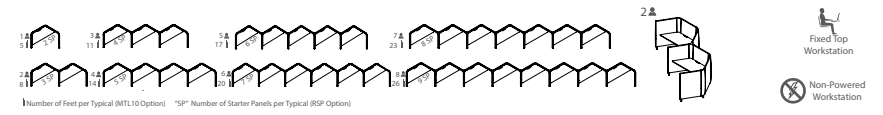

Page 21
Inline Diagonal Workstation Typical
Position 1 with Fixed Worksurface

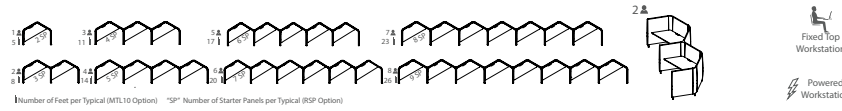

Page 22
Inline Diagonal Workstation Typical
Position 1 with Power Fixed Worksurface

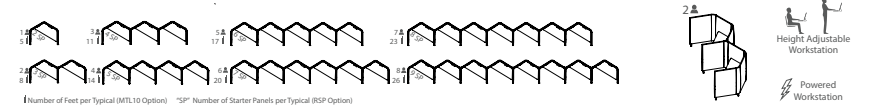

Page 23
Inline Diagonal Workstation Typical
Position 2 with Height Adjustable Worksurface

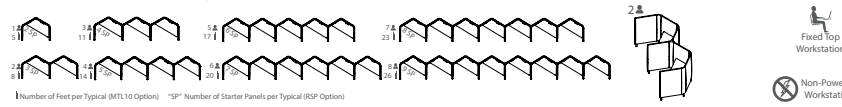

Page 24
Inline Diagonal Workstation Typical
Position 2 with Fixed Worksurface

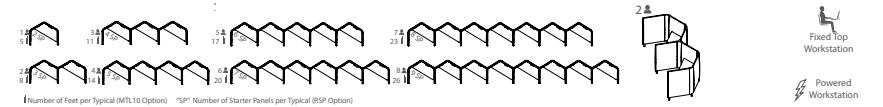

Page 25
Inline Diagonal Workstation Typical
Position 2 with Power Fixed Worksurface



Page 26
Facing Diagonal Workstation Typical
Position 1 with Height Adjustable Worksurface

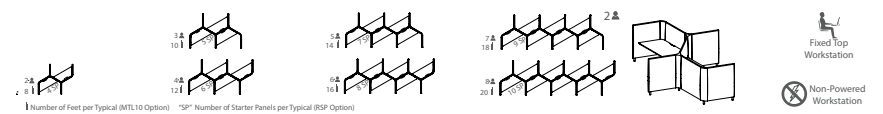

Page 27
Facing Diagonal Workstation Typical
Position 1 Desk with Fixed Worksurface

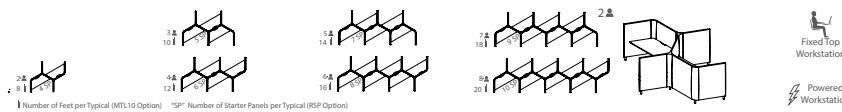

Page 28
Facing Diagonal Workstation Typical
Position 1 Desk with Power Fixed Worksurface

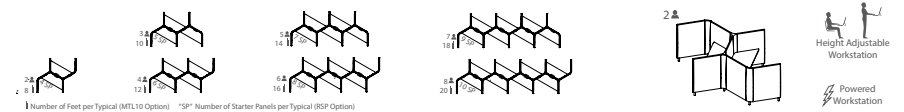

Page 29
Facing Diagonal Workstation Typical
Position 2 Desk with Height Adjustable Worksurface

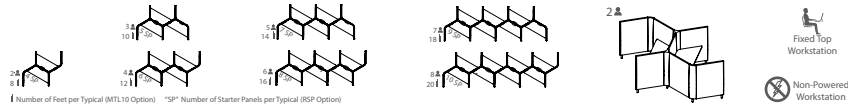

Page 30
Facing Diagonal Workstation Typical
Position 2 Desk with Fixed Worksurface

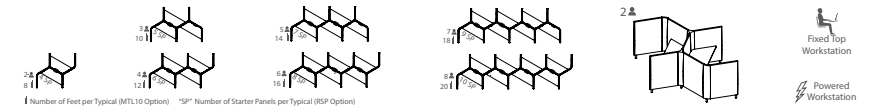

Page 31
Facing Diagonal Workstation Typical
Position 2 Desk with Power Fixed Worksurface

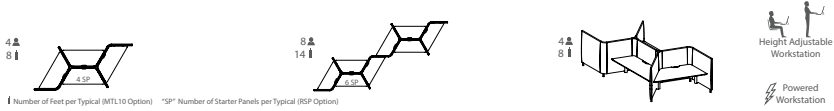

Page 32
Diamond Workstation Typical
Diamond Workstation with Height Adjustable Worksurface

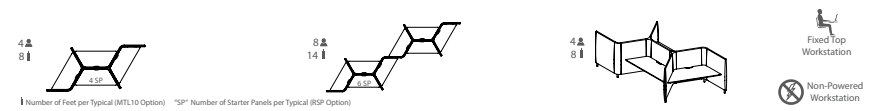

Page 33
Diamond Workstation Typical
Diamond Workstation with Fixed Worksurface

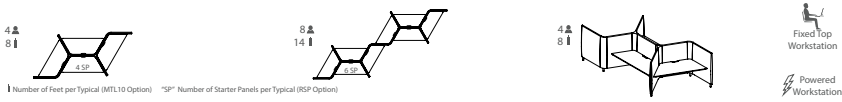

Page 34
Diamond Workstation Typical
Diamond Workstation with Power Fixed Worksurface

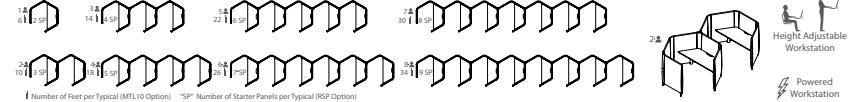

Page 35
Inline Hexagon Workstation Typical
Position 1 Desk with Height Adjustable Worksurface

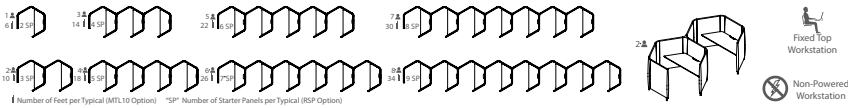

Page 36
Inline Hexagon Workstation Typical
Position 1 Desk with Fixed Worksurface

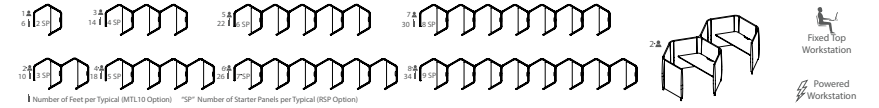

Page 37
Inline Hexagon Workstation Typical
Position 1 Desk with Power Fixed Worksurface

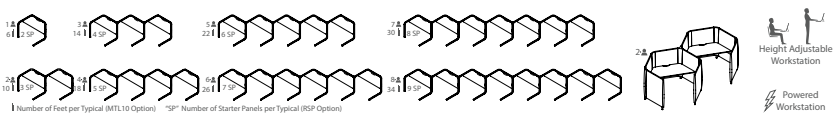

Page 38
Inline Hexagon Workstation Typical
Position 2 Desk with Height Adjustable Worksurface

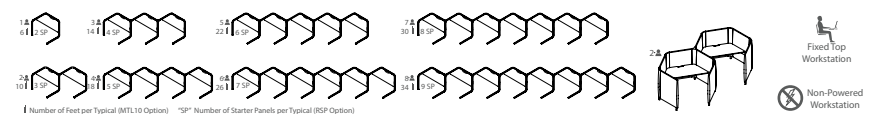

Page 39
Inline Hexagon Workstation Typical
Position 2 Desk with Fixed Worksurface

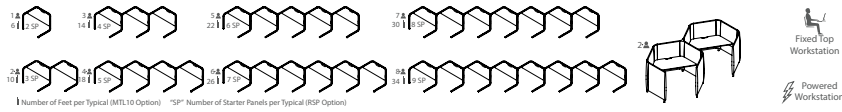

Page 40
Inline Hexagon Workstation Typical
Position 2 Desk with Power Fixed Worksurface

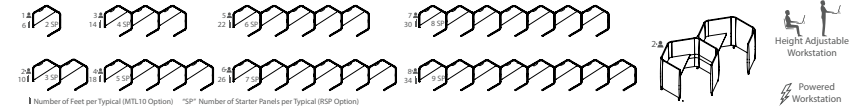

Page 41
Inline Hexagon Workstation Typical
Position 3 with Height Adjustable Worksurface

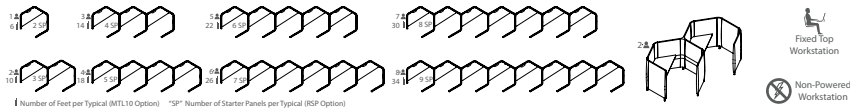

Page 42
Inline Hexagon Workstation Typical
Position 3 Desk with Fixed Worksurface

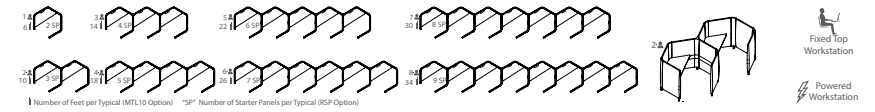

Page 43
Inline Hexagon Workstation Typical
Position 3 Desk with Power Fixed Worksurface

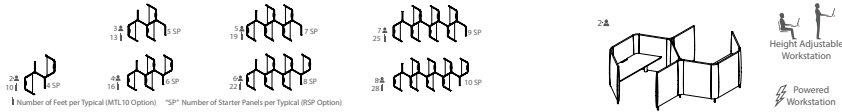

Page 44
Double Hexagon Workstation Typical
Position 1 Desk with Height Adjustable Worksurface

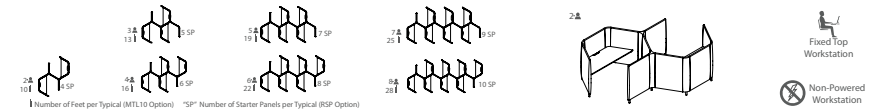

Page 45
Double Hexagon Workstation Typical
Position 1 Desk with Fixed Worksurface

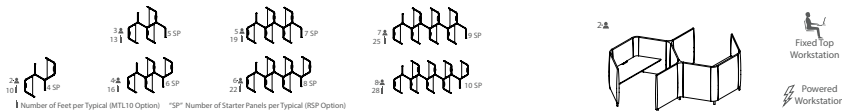

Page 46
Double Hexagon Workstation Typical
Position 1 Desk with Power Fixed Worksurface

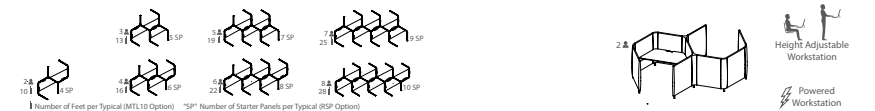

Page 47
Double Hexagon Workstation Typical
Position 2 Desk with Height Adjustable Worksurface

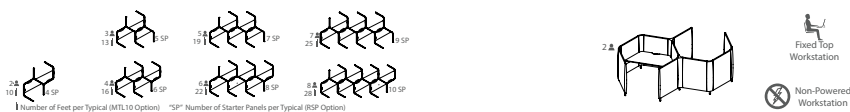

Page 48
Double Hexagon Workstation Typical
Position 2 Desk with Fixed Worksurface



Page 49
Double Hexagon Workstation Typical
Position 2 Desk with Power Fixed Worksurface

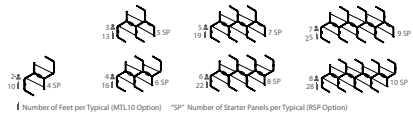

Page 50
Double Hexagon Workstation Typical
Position 3 Desk with Height Adjustable Worksurface

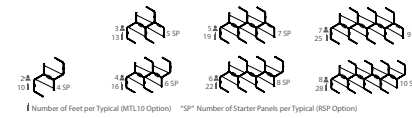
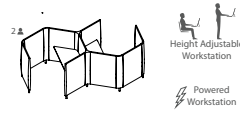

Page 51
Double Hexagon Workstation Typical
Position 3 Desk with Fixed Worksurface

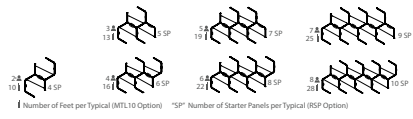
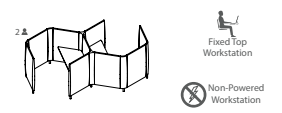

Page 52
Double Hexagon Workstation Typical
Position 3 Desk with Power Fixed Worksurface

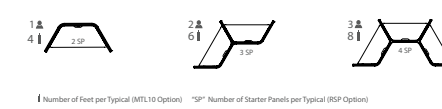
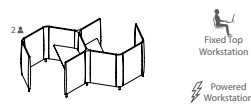

Page 53
Hexagon Workstation Typical
Desk with Height Adjustable Worksurface

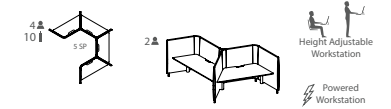

Page 54
Hexagon Workstation Typical
Desk with Fixed Worksurface

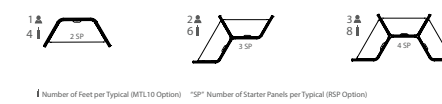

Page 55
Hexagon Workstation Typical
Desk with Power Fixed Worksurface



Page 56
Hexagon Workstation Typical
Five Person Workstation with Height Adjustable Worksurface



Page 57
Hexagon Workstation Typical
Five Person Workstation with Fixed Worksurface



Page 58
Hexagon Workstation Typical
Five Person Workstation with Power Fixed Worksurface

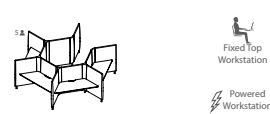

Page 59
Hexagon Workstation Typical
Six Person Workstation with Height Adjustable Worksurface





Page 60
Hexagon Workstation Typical
Six Person Workstation with Fixed Worksurface

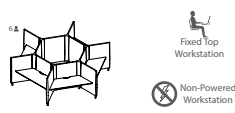

Page 61
Hexagon Workstation Typical
Six Person Workstation with Power Fixed Worksurface



Page 62
Linear Workstation Typical
Desk with Height Adjustable Worksurface



Page 63
Linear Workstation Typical
Desk with Fixed Worksurface



Page 64
Linear Workstation Typical
Desk with Power Fixed Worksurface

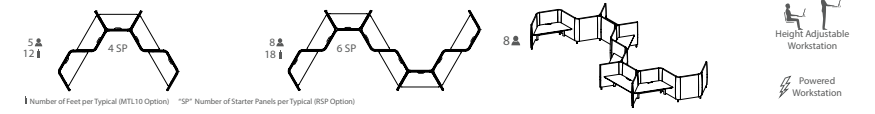

Page 65
S-Shaped Workstation Typical
Desk with Height Adjustable Worksurface

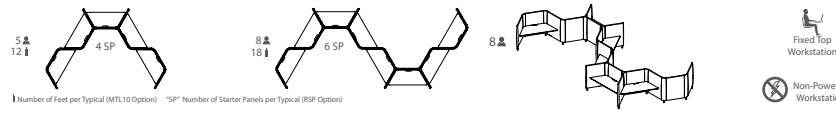

Page 66
S-Shaped Workstation Typical
Desk with Fixed Worksurface

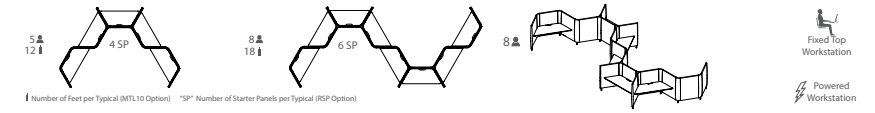

Page 67
S-Shaped Workstation Typical
Desk with Power Fixed Worksurface

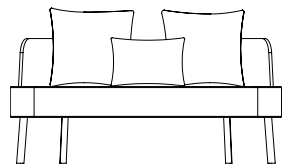

Page 68
120° Lounge
Lounge with Seat and Back Cushions



Page 69
120° Starter Panel
Round End

Statement of Line



Page 70
120° Starter Panel
Flat End

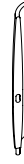

Page 71
120° Corner Panel Connector
Two Corner Panel



Page 72
120° Corner Panel Connector
Three Corner Panel



Page 73
In-Line Panel Connector
Straight Run Connector



Page 74
120° Adder Panel
No Power Access

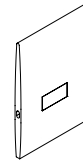

Page 75
120° Adder Access Panel
Single Sided Access

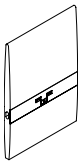

Page 76
120° Single Sided Power Panel
Power Panel

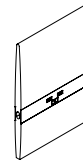

Page 77
120° Double Sided Power Panel
Power Panel

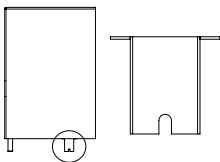

Page 78
Concealed Floor Power Infeed Cover
Power Cable Entry Box

Shown on
HNY3555SP889
Panel not included



Panels
not included
Page 79
120° Worksurface Top
Worksurface with Fixed Top



Fixed Top
Worksurface



Panels
not included
Page 80
120° Worksurface Top
Worksurface with Height Adjustable Top

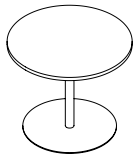

Page 82
Fixed Circular Table
Fixed Circular Table - Sitting Height



Top
not included

Page 84
120° Worksurface Privacy Screen
Worksurface Veneer Privacy Screen

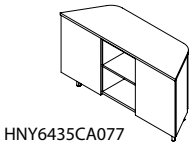

HNY6435CA077

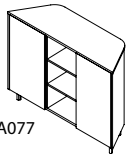

HNY6448CA077

Page 86
64" Wide Push-In Storage Credenza
Storage Credenza with Sliding Doors

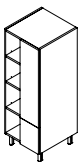

Page 88
Single Sided Open Storage Tower
Open Storage Tower with Left File / Wardrobe Access



Page 81
Fixed Triangular Table
Fixed Triangular Table - Sitting Height

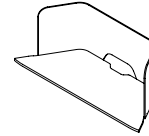

Top
not included

Page 83
120° Worksurface Privacy Screen
Worksurface PET Privacy Screen

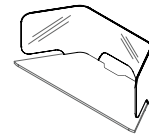

Top
not included

Page 85
120° Worksurface Privacy Screen
Worksurface Acrylic Privacy Screen

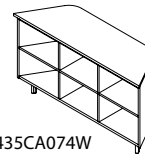

HNY6435CA074W



HNY6448CA074W

Page 87
120° Open Storage Credenza
Open Storage Credenza

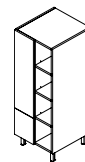

Page 89
Single Sided Open Storage Tower
Open Storage Tower with Right File / Wardrobe Access

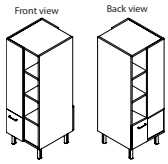

Page 90
Two Person Double Sided - Freestanding Shared Storage
All-in-One Cabinet-Double Sided



Page 92
Mobile Workstation Typical
Desk with Height Adjustable Worksurface

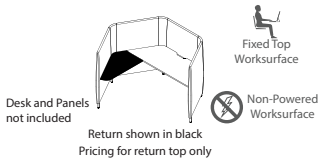

Page 94
120° Return Worksurface Top
Left Fixed Worksurface

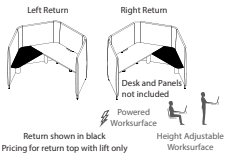

Page 96
120° Return Worksurface Top
Height Adjustable Top

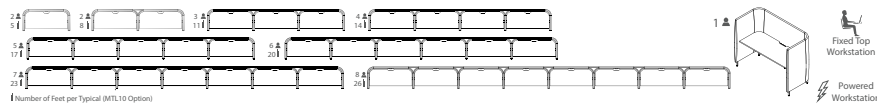

Page 98
Inline 90° Workstation Typical
Position 1 Desk with Power Fixed Worksurface

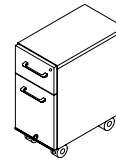

Page 91
Open Plan Mobile Pedestal
Mobile B/F Desk Pedestal With Casters



Page 93
Mobile Workstation Typical
Desk with Fixed Worksurface



Page 95
120° Return Worksurface Top
Right Fixed Worksurface

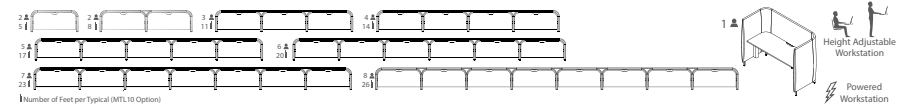

Page 97
Inline 90° Workstation Typical
Position 1 Desk with Height Adjustable Worksurface

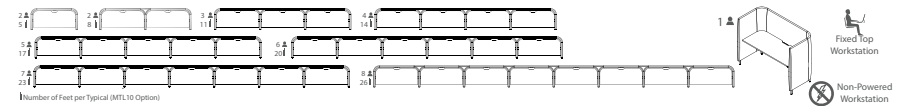

Page 99
Inline 90° Workstation Typical
Position 1 Desk with Fixed Worksurface

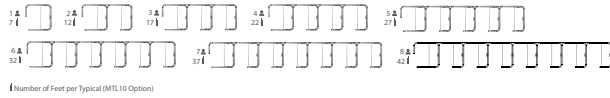

Number of Feet per Typical (MTL10 Option)

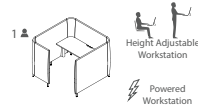

Page 100
Inline 90° Workstation Typical
Position 2 Desk with Height Adjustable Worksurface

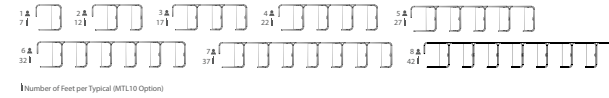

Number of Feet per Typical (MTL10 Option)

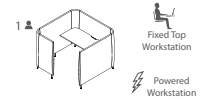

Page 101
Inline 90° Workstation Typical
Position 2 Desk with Power Fixed Worksurface

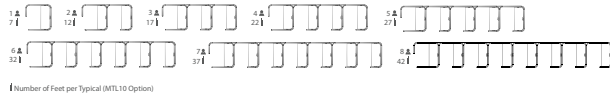

Number of Feet per Typical (MTL10 Option)



Page 102
Inline 90° Workstation Typical
Position 2 Desk with Fixed Worksurface

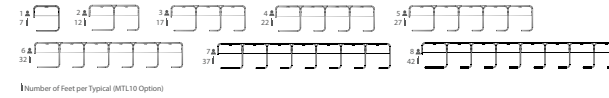

Number of Feet per Typical (MTL10 Option)

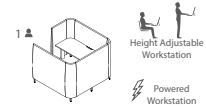

Page 103
Inline 90° Workstation Typical
Position 3 Desk with Height Adjustable Worksurface



Number of Feet per Typical (MTL10 Option)

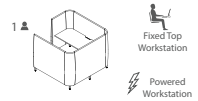

Page 104
Inline 90° Workstation Typical
Position 3 Desk with Power Fixed Worksurface

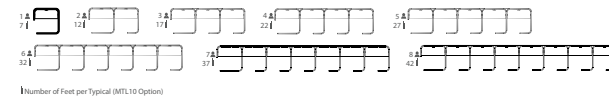

Number of Feet per Typical (MTL10 Option)

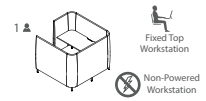

Page 105
Inline 90° Workstation Typical
Position 3 Desk with Fixed Worksurface

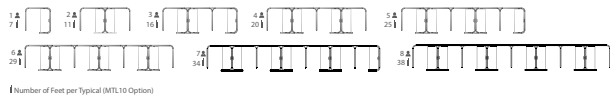

Number of Feet per Typical (MTL10 Option)

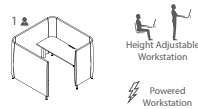

Page 106
Inline 90° Workstation Typical
Position 4 Desk with Height Adjustable Worksurface

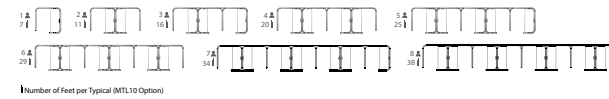

Number of Feet per Typical (MTL10 Option)



Page 107
Inline 90° Workstation Typical
Position 4 Desk with Power Fixed Worksurface

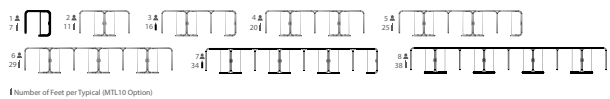

Number of Feet per Typical (MTL10 Option)



Page 108
Inline 90° Workstation Typical
Position 4 Desk with Fixed Worksurface

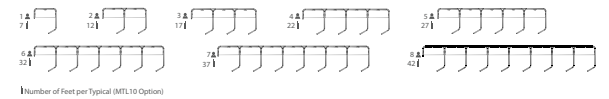

Number of Feet per Typical (MTL10 Option)

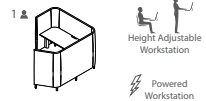

Page 109
Inline 90° Workstation Typical
Position 5 Desk with Height Adjustable Worksurface

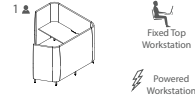
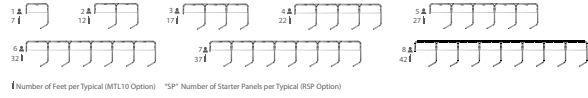

Page 110
Inline 90° Workstation Typical
Position 5 Desk with Power Fixed Worksurface

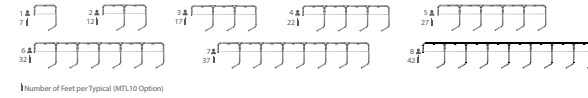

Page 111
Inline 90° Workstation Typical
Position 5 Desk with Fixed Worksurface

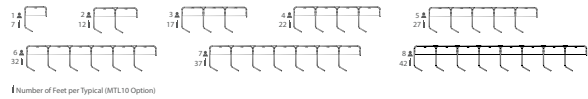

Page 112
Inline 90° Workstation Typical
Position 6 Desk with Height Adjustable Worksurface

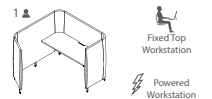
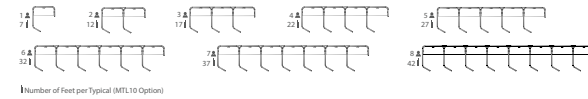

Page 113
Inline 90° Workstation Typical
Position 6 Desk with Power Fixed Worksurface

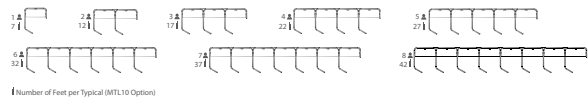

Page 114
Inline 90° Workstation Typical
Position 6 Desk with Fixed Worksurface

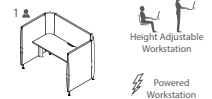
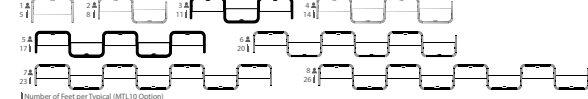

Page 115
Linear 90° Workstation Typical
Height Adjustable Worksurface

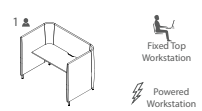
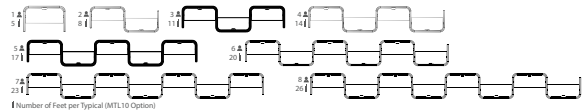

Page 116
Linear 90° Workstation Typical
Fixed Power Worksurface

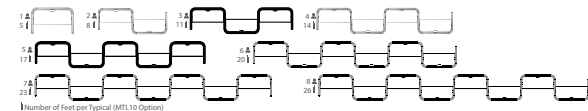

Page 117
Linear 90° Workstation Typical
Fixed Worksurface

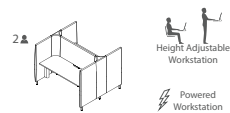

Page 118
Facing 90° Workstation Typical
Position 1 Desk with Height Adjustable Worksurface

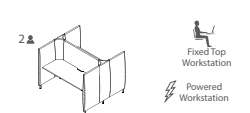
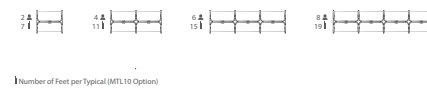

Page 119
Facing 90° Workstation Typical
Position 1 Desk with Fixed Power Worksurface



Number of Feet per Typical (MTL10 Option)

Page 120
Facing 90° Workstation Typical
Position 1 Desk with Fixed Worksurface

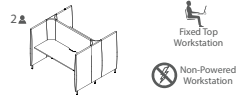

Number of Feet per Typical (MTL10 Option)

Page 121
Facing 90° Workstation Typical
Position 2 Desk with Height Adjustable Worksurface

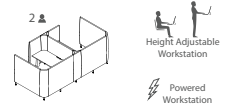

Number of Feet per Typical (MTL10 Option)

Page 122
Facing 90° Workstation Typical
Position 2 Desk with Fixed Power Worksurface

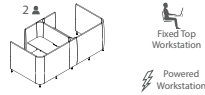

Number of Feet per Typical (MTL10 Option)

Page 123
Facing 90° Workstation Typical
Position 2 Desk with Fixed Worksurface



Number of Feet per Typical (MTL10 Option)

Page 124
Facing 90° Workstation Typical
Position 3 Desk with Height Adjustable Worksurface

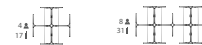
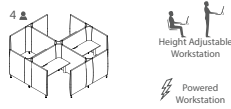

Number of Feet per Typical (MTL10 Option)

Page 125
Facing 90° Workstation Typical
Position 3 Desk with Fixed Power Worksurface

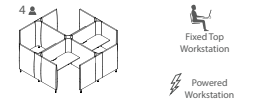

Number of Feet per Typical (MTL10 Option)

Page 126
Facing 90° Workstation Typical
Position 3 Desk with Fixed Worksurface

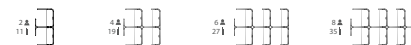
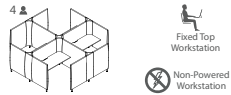

Number of Feet per Typical (MTL10 Option)

Page 127
Double 90° Workstation Typical
Position 1 Height Adjustable Desk



Number of Feet per Typical (MTL10 Option)

Page 128
Double 90° Workstation Typical
Position 1 Fixed Power Worksurface

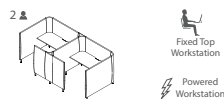

Number of Feet per Typical (MTL10 Option)

Page 129
Double 90° Workstation Typical
Position 1 Fixed Worksurface

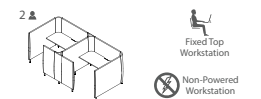

Statement of Line



Number of Feet per Typical (MTL10 Option)

Page 130
Double 90° Workstation Typical
Position 2 Height Adjustable Desk

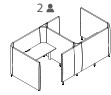

Height Adjustable Workstation



Powered Workstation



Number of Feet per Typical (MTL10 Option)

Page 131
Double 90° Workstation Typical
Position 2 Fixed Power Worksurface

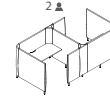

Fixed Top Workstation



Powered Workstation

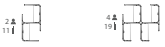

Number of Feet per Typical (MTL10 Option)

Page 132
Double 90° Workstation Typical
Position 2 Fixed Worksurface

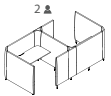

Fixed Top Workstation



Non-Powered Workstation



Page 133
90° Starter Panel
Flat End

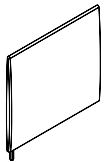

Page 134
90° Starter Panel
Flat End



Page 135
90° Corner Panel Connector
Two Way Corner Connector



Page 136
90° Corner Panel Connector
Three Way Corner Connector

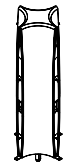

Page 137
90° Corner Panel Connector
Four Way Corner Connector

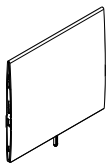

Page 138
90° Adder Panel
No Power Access

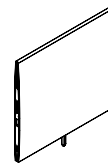

Page 139
90° Adder Panel
Single Sided Access

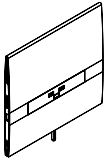

Page 140
90° Single Sided Power Panel
Power Panel

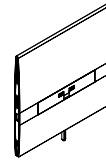

Page 141
90° Double Sided Power Panel
Power Panel

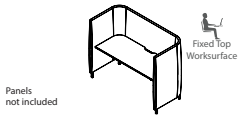

Page 142
90° Worksurface Top
Worksurface with Fixed Top

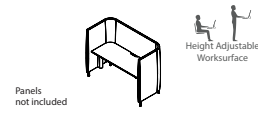

Page 143
90° Worksurface Top
Worksurface with Height Adjustable Top



Page 144
Mobile 90° Workstation Typical
Desk with Fixed Worksurface



Page 145
Mobile 90° Workstation Typical
Desk with Height Adjustable Worksurface

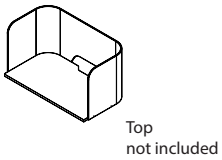

Page 146
90° Worksurface Privacy Screen
Worksurface PET Privacy Screen

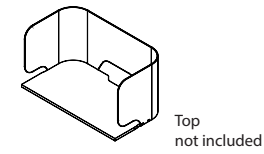

Page 147
90° Worksurface Privacy Screen
Worksurface Acrylic Privacy Screen

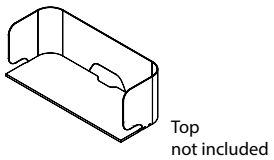

Page 148
90° Worksurface Privacy Screen
Worksurface Acrylic Privacy Screen

DARRAN®

Veneer tops

Veneer tops are 1" thick and comprised of 45-pound density MDF core with a balanced 3-ply construction. Veneer tops, screens, and lounge backs are standard in Quartered Walnut and Rift Cut White Oak Veneers that are slip-matched. Veneer tops are available in Flat or Cliff edge profile, with multiple banding options. Tops are finished in either 5-sheen matte finish or 40-sheen depending on finish selection.

HPL laminate tops

Honey high-pressure laminate tops are 1" thick and comprised of 45-pound density MDF core with a balanced 3-ply construction. Tops are available in Flat or Cliff edge profile, with multiple banding option.

TFL tops

Thermally Fused Laminate tops are 1-1/8" thick and fused to a 45-pound density substrate of the top for a durable surface. Tops are available in a Flat edge profile with multiple banding options.

Panel construction

Panels are composed of 3/4" and 1" birch plywood with tenon and groove construction that is secured with screws and glued. MDF trim pieces create soft rounded edges and beautiful contours. The frame is covered with 4.5mm PET acoustic panels for sound absorption. PET panels are composed of recycled content, are flame retardant, mold resistant and have zero emissions. Panels are standard elevated on 5" solid wood legs that feature 2" Glide for adjustment on uneven surfaces.

Case construction

Case pieces including pedestals, towers and credenzas are constructed of 3/4" thick particle board with 3-ply balanced construction. Pedestal and Cabinets feature dowel construction reinforced with steel bracket plates, wood cleats, screws and glue. Credenzas and Towers are elevated on 6" solid wood legs featuring 1" glide for adjustment on uneven surfaces.

Lounge construction

Lounge units are constructed from plywood with 2" thick bottom platform, 3/4" seat pan and 4" of high resiliency foam for comfort and durability. The honey Lounge back is a curved plywood core with veneer or laminate. Honey lounge consists of high resilient foam with a minimum of 2.5 density in seats and blown fiber cushions, further advances support and durability.

Lounge unit is elevated on 10.5" solid wood leg with oval shape to match panel stations.

Screens

Honey screens are available in Acrylic or Veneer over plywood. Acrylic is 1/4" thick and available in frosted, white, and black. Plywood screens are 1/2" thick and are available in Quartered Walnut and Rift Cut White Oak Veneer that runs horizontally on the screen. Screens secure to the

Honey Features & Advantages

underside of the worksurfaces with an L bracket. Screens feature a center cutout to allow clip-on power pods and easy wire management to the MGT: Wire Tray below the worksurface. The screen is 24" tall for added privacy; the screen's unique curved wings mimic the worksurface top creating a barrier between users and work area to focus.

Cleaning wood & laminate

In addition to regular dusting, give your furniture an occasional cleaning in accordance with our cleaning instructions. DARRAN wood and laminate products can be cleaned with a soft cloth and a mild soap and water mixture. Use approximately 32 oz of water mixed with one tablespoon of dish soap, always wiping with the grain. Dry with a soft cloth, going with the grain, to avoid spotting or streaking.

Wood products should be waxed periodically using a non-wax liquid; please do not use any waxy polish or cleaner. Interior of drawers may also be cleaned with mild soap and water mixture, or any household cleaner that is not petroleum or thinner-based.

Suspensions

All cabinets and mobile pedestals utilize cold rolled steel zinc plated high-grade drawer suspensions. All suspensions are warranted for the lifetime of the product. Box and File drawers are full extension, featuring steel ball bearings for a smoother quieter range of motion with soft close operation and are rated 100lbs.

Filing

Honey features a highly durable black plastic extrusion that is securely fastened into a route on top of the drawer to support hanging files. An adjustable crossbar is provided for all file drawers that enables legal/letter filing front to back or side-to-side based on the drawer size.

Locks

Locks are optional on pedestals and doors. Each drawer pedestal is independently locked. Lock plugs are factory or field installed.

Keying

Keying is available either factory or field installed. Factory installed keying offers two options: random or designated. When the random keying option is selected an arbitrary key number will be assigned to the unit. When the designated keying option is selected a key number must be specified between 101 and 110. Higher numbers may be specified if noted on the purchase order and may be factory or field installed. Black and silver face lock have silver keys.

Wire management

Wire management capabilities include standard and optional worksurface grommets. Specify W21 under surface wire channels for organization and management of all communication wires and cords. Sold separately to conceal wire under worksurfaces. Top feature a cutout in the back and unique curved wings allowing for clip on modules or easy wire management to the power tray below the worksurface.

Grommets

Metal grommets are provided to match the drawer pull selection. Metal grommets are available in black, silver or white. Must specify standard or non-standard location. TM50 Black plastic grommets are available as an option for vertical applications.

Seating & fabric leather program

DARRAN has partnered with some of the most prestigious fabric suppliers of the office furniture industry to bring you quality fabrics that are engaging designs, environmentally friendly and durable for years to come. The majority of fabrics we have graded-in are in heavy supply making it most likely available on our Quickship however, we cannot guarantee stock. If you do not see the fabric you wish to include in a project, please contact our Factory to see if this pattern can be graded in at 800.334.7891.

Panel fabric program

ALL COM fabric must be preapproved by DARRAN. Leather fabric program is not approved on panels. Due to stretching and sagging textile content for panels shouldnt exceed a combined 50% cotton, linen, nylon and/or rayon is not recommended. Panel fabrics are required to have flame certificates that meet ASTM E84 Adhered (for power panels) and Unadhered (for panels). DARRAN does not accept responsibility of collecting flame certificates for COM.

Fabrics & leathers

Please visit our Seating Fabrics page at darran.com/textilesleather

Camira
www.camirafabrics.com
800.334.789

Wollsdorf
www.wollsdorf.com
336.884.5005

CFStinson
www.cfstinson.com
800.841.6279

Green Hides
www.greenhides.com
336.315.9720

DesignTex
www.designtex.com
800.797.4949

Maharam
www.maharam.com
800.645.3943

Momentum Textiles
www.momentumtextiles.com
800.366.6839

Ultrafabrics
www.ultrafabricsinc.com
800.334.7891

Application instructions must be specified on the purchase order or COM / COL submission form. In the absence of application instructions, DARRAN will apply materials accordingly.

CAL117

All DARRAN seating products conform to California Technical Bulletin 117 as a minimum standard.

CAL133

To meet the California Technical Bulletin 133 flammability regulation, a combination of proper materials must be used to pass, as it tests the fire resistance of a finished product. Flame resistant fabric, a fire blocker material and special foam must be used to pass CAL133 fire codes.

Testing is available for all seating products with the following fees and considerations:

- If laboratory certification is not required, any style can be manufactured to comply with California Technical Bulletin 133 for \$75 list per yard required. (Customer's Own Materials must factor in additional yardage requirements based on repeat.)
- The purchase order must clearly indicate the requirement of California Technical Bulletin 133
- If laboratory California Technical Bulletin 133 certification is required, the cost of testing a chair is \$820 NET, plus the cost of the chair and covering material.
- An additional lead time of 4 to 6 weeks is required for testing for CAL133.
- Once testing is completed, we will provide a certification letter specific to the sample tested for CAL133.
- DARRAN's manufacturing procedures for California TB 133 compliance are based on the testing of representative style with specific fabrics. Please contact Customer Service for an updated list of tested models.
- A copy of test certification is available upon request.

Combination fabrics

DARRAN is pleased to offer customers the design freedom of combination fabrics. When using fabric, vinyl or leather combinations, pricing will be as follows:

- When combining two materials of the same grade, pricing will be specified grade + 5%.
- If combining two materials of different grades or leather/ fabric combination, use the highest grade/price + 5%.
- If using COM or COL, pricing will be COM or COL + 5%. If both COM + COL are used in combination, use COL + 5%

COM/COL ordering instructions

Please complete the COM Submission Form prior to ordering the fabric from the supplier. All COM fabrics must be approved prior to order submission. Please refer to our website or contact DARRAN Seating Customer Service for an updated list of preapproved COM fabrics. Application instructions must be specified on the purchase order or COM/COL submission form. In the absence of application instructions, DARRAN will apply materials in the best manner and cannot be held responsible for tailoring or application objections after upholstering. COM orders will be scheduled for production after receipt of the material. Packages must be clearly marked and the fabric must be first quality, continuous yardage.

COM/COL yardage requirements

The yardage requirements stated in this price list for each style are calculated using 54" wide, non-directional fabrics. For fabrics with a different width or for patterns with repeats, please refer to the below chart to calculate the additional percent of fabric required:

Fabric Width	Plain Fabric	2" - 14" Repeat	15" - 19" Repeat	20" - 27" Repeat	28" - 36" Repeat
54"	0	15%	20%	25%	30%
53"	6%	19%	24%	28%	36%
52"	13%	23%	28%	33%	38%
51"	19%	26%	31%	36%	41%
50"	25%	30%	35%	40%	45%
49"	30%	35%	40%	45%	50%
48"	35%	40%	45%	50%	55%
47"	45%	50%	55%	58%	65%

DARRAN®

NOTE: Prior To Completion Of This Form, Please Refer To Our Graded In Materials Program For Preapproved Fabrics/Leathers.

COM/COL Approval

DARRAN Furniture Industries
2402 Shore Street, High Point, NC 27263
ATTN: Seating Division / COM/COL Approval
TAG: DARRAN Purchase Order Number

Shipping approved COM/COL materials

DARRAN Furniture Industries
2402 Shore Street, High Point, NC 27263
ATTN: Seating Division / COM/COL Approval
TAG: DARRAN Purchase Order Number

Please complete this form, attach a 6"x 6" sample and mail to the COM/COL APPROVAL address shown above.
This form can also be downloaded from our website at www.darran.com/leathers OR www.darran.com/fabrics

Purchase Order # _____

Dealer's Name _____

Contact _____

Address _____

Telephone _____

Email _____

Chair Style _____

Manufacturer _____

Pattern Name _____

Pattern Color _____

Content _____

Repeat _____

Please specify any special requirements and check the application above.

Honey Fabric & Leather Program

ATTACH 6" X 6" FABRIC/LEATHER SAMPLE HERE

NOTE
Actual Fabric/Leather samples needed instead of digital images. If digital images are sent in lieu of samples, DARRAN will only verify the pattern and will not take responsibility for color variances that cannot be verified due to printing restrictions

In the absence of application instructions, DARRAN will apply the material in the best manner and cannot be held responsible for tailoring or application objections after upholstering.

Unless otherwise instructed on the purchase order, excess COM materials will be recycled at the discretion of DARRAN after six months of the original product ship date.

The COM approval solely pertains to the application of the fabric onto the specified DARRAN seating product. DARRAN's approval or acceptance does not constitute any responsibility or warranty to the overall appearance, durability, flammability, defects, dye lot variations or colorfastness of the COM. It is the customer's responsibility to ensure the COM meets CAL 117 compliance and are first quality continuous goods.

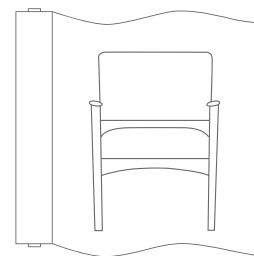

RAILROAD

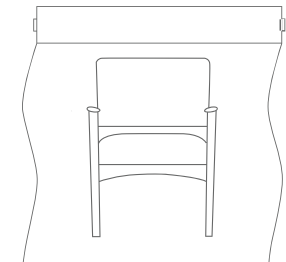

SETUP

MATTE 5% SHEEN VENEER

Specify LST-40 to change matte 5% sheen to gloss 40% sheen - N/C.

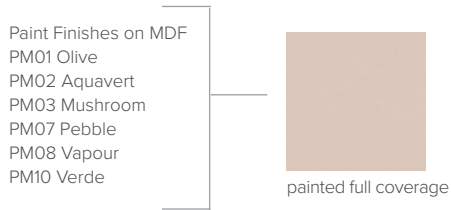

HIGH PRESSURE LAMINATE

- GEC Ebony
- GWL Designer White
- LP01 Surfin USA
- LF02 Just Rose
- LF03 Folkstone
- LN01 Cafe Sienna
- LA02 Verde Chair (20% upcharge)
- LW01 Neo Walnut
- LW02 Fawn Cypress
- LW04 Phantom Pearl
- LW05 Phantom Ecrú
- LW06 Phantom Cocoa

THERMALLY FUSED LAMINATE

- MEC Ebony
- MOC Koko Cherry
- MSW Skyline Walnut
- MTW Studio Teak
- MWL Designer White
- MNA Narvik Ash

- WEC Ebony
- WOW Clear Walnut
- WNO Natural Oak
- WSO Salted Oak
- WNF Natural Oak on Flat Cut
- WMF Mocha Oak on Flat Cut
- WSF Salted Oak on Flat Cut
- WBW Henna Walnut
- WSW Smokey Walnut
- WWP Designer White



Welltech Finish delivers a superior furniture coating with exceptional performance that can withstand stringent cleaning agents and possesses unparalleled durability, allowing DARRAN to provide lasting, sustainable products to our customers.

Height adjustable columns are standard in MFW White. MFB Black is optional when specified.

Height Adjustable Mechanism Metal Finishes

STANDARD

OPTIONAL



MFW White
Satin Finish
(Standard)



MFB Black
Satin Finish
(Optional - N/C)

Feet, Table Base, Wire Tray and Bracket Metal Finishes

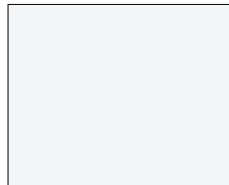

MFW White
Satin Finish
(Standard)

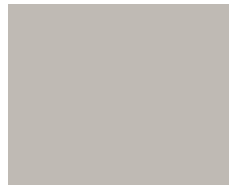

MFG Gray
Satin Finish
(Premium)



MFGG Graphite Gray
Matte Finish
(Premium)



MFS Silver
Satin Finish
(Premium)



MFMB Matte Black
Matte Finish
(Premium)



MFNA Navy
Matte Finish
(Premium)

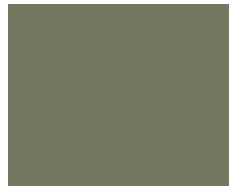

MFOL Olive
Matte Finish
(Premium)



MFGB Grey Beige
Matte Finish
(Premium)



MFSA Surfin Aquavert
Matte Finish
(Premium)

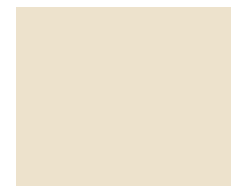

MFOS Oyster
Matte Finish
(Premium)



MFPS Pistachio
Matte Finish
(Premium)

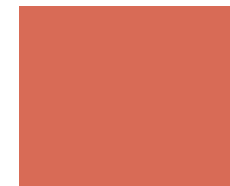

MFSS Salmon Sienna
Matte Finish
(Premium)

PET felt screens are available in the colors below.



Big Red
45

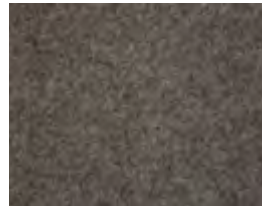

City Brown
06

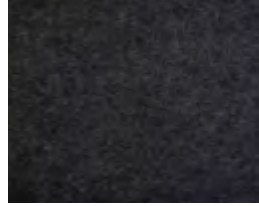

Dark Gray
17



Indigo Blue
21



Green Apple
39



Dark Green
05



Medium Gray
63



Heathered Granite
71



Heathered Oatmeal
75



Heathered Teal
76

Standard profile

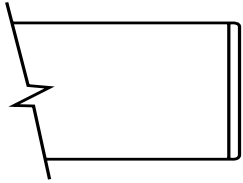

Flat-1

"W" "G"
 "W" 3mm Hardwood Band
 "G" Matching PVC Band

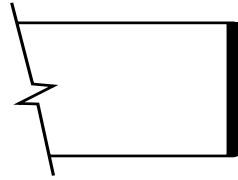

Flat-2

"W" "G" "M"
 2mm Black
 PVC Band

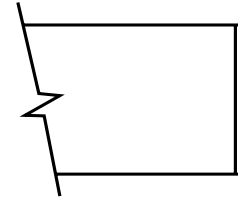

Flat-3

"W" "G" "M"
 2mm White
 PVC Band

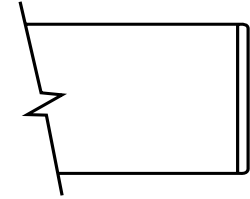

Flat-4

"M"
 2mm Matching PVC Band

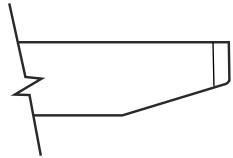

Cliff-1

"W" "G"
 "W" 3mm Hardwood Band
 "G" Matching PVC Band
 Cutback is finished to match top



Cliff-2

"W" "G"
 2mm Black PVC Band
 Cutback is finished to match top

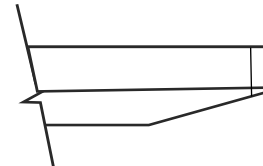

Cliff-3

"W" "G"
 2mm White PVC Band
 Cutback is finished to match top

Honey pulls come standard in PL-506 gloss white. Optional pulls available when specified.



PL - 506 Gloss White (Standard)
PL - 507 Matte Chrome



PL - 406 Gloss White
PL - 407 Matte Chrome



PL-115 Matte Black
PL-116 Matte Nickel

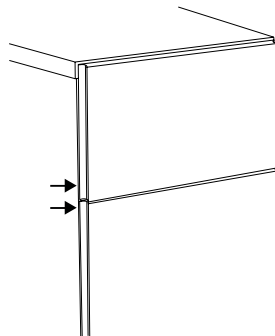

finger pull side view
(Not available on TFL products)

TM60
Black
1-5/8" Dia.



Grommets (vertical surface)

Standard Location - \$50 ea.
- Black Plastic Vertical Surface: TM60-C (Bottom Center)

Non-Standard Location - \$95 ea.
- Black Plastic Vertical Surface: TM60-NS

Grain direction

All top parts, storage credenzas, pedestals and towers come with horizontal grain.

Worksurfaces

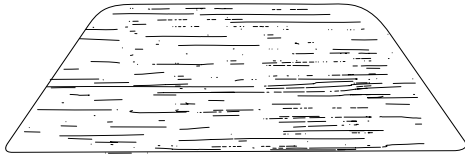

Desk/Credenza

Honey panels feature an integrated power system that daisy chains through panels to power workstations. The system features 8 wires, 4 circuits, (1 dedicated circuit), 20 amps each. Hardwired systems feature (13) duplex receptacles per circuit, (52) 15 amp duplex receptacles per power infeed maximum. The Honey power system is UL Listed as a manufactured wiring system.

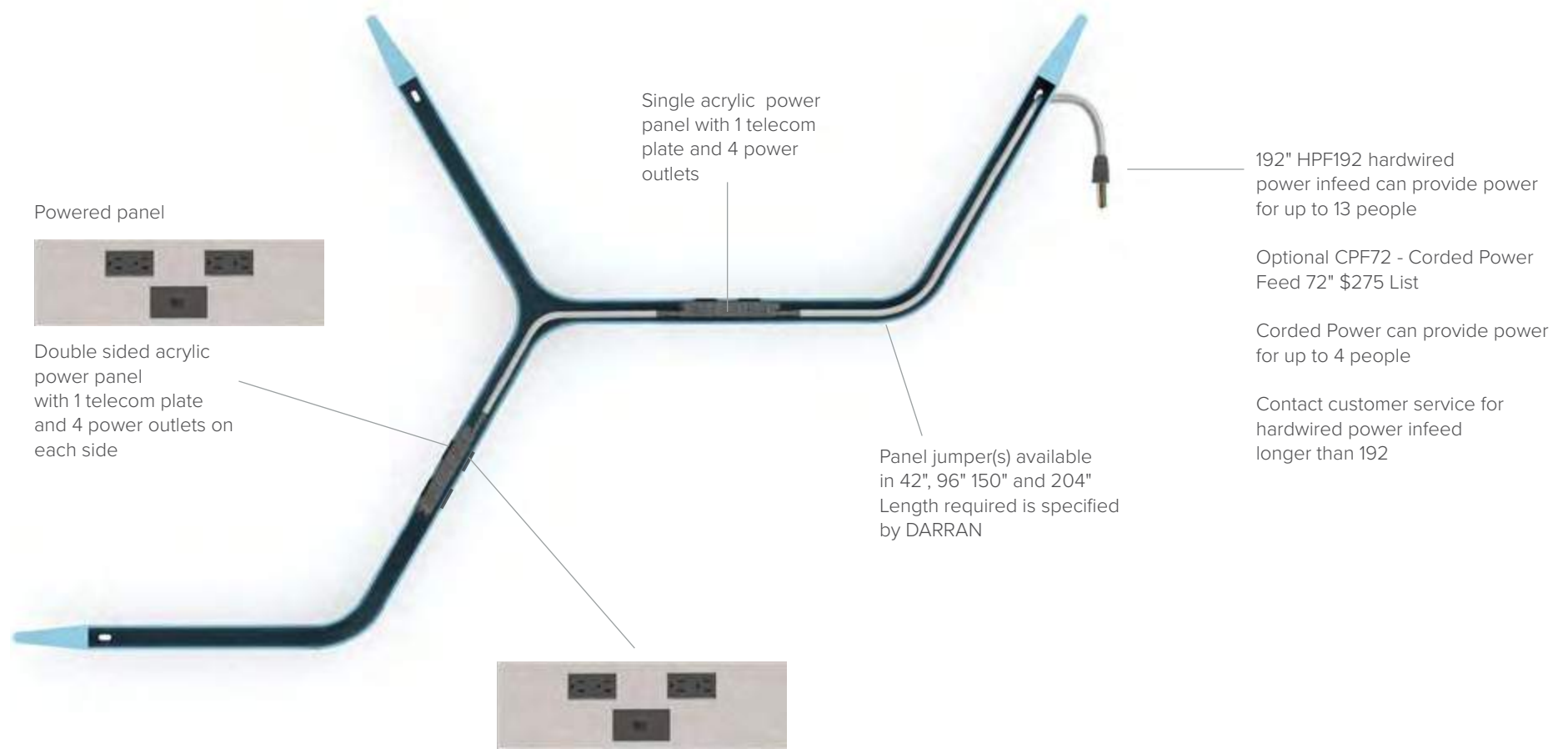

Honey cutout

Honey worksurfaces feature a standard T75 wire management cutout to drop wires below the worksurface.

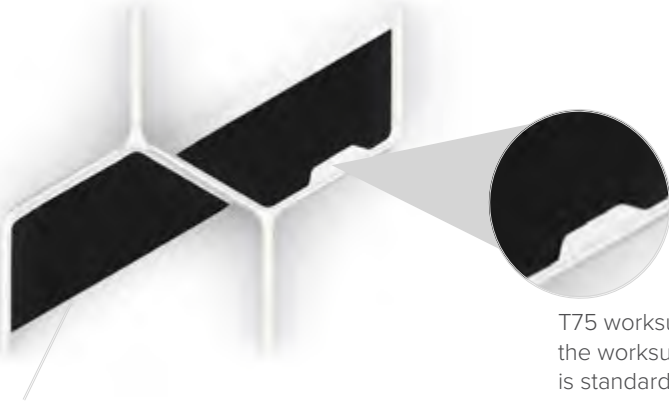

T75 worksurface cutout to drop wires below the worksurface to power access. Wire cutout is standard on all typicals.

T75D option is available to delete cutout on worksurfaces at no charge. Please specify when ordering.

Honey T75 dimensions

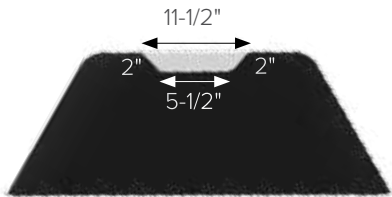

Panel workstation dimensions

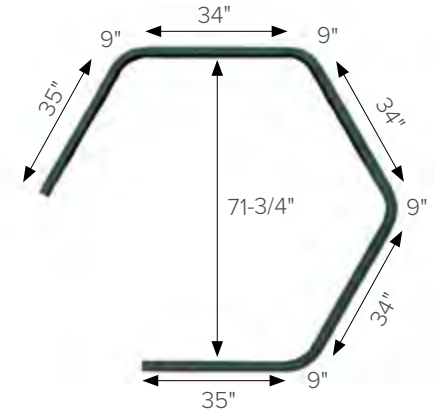
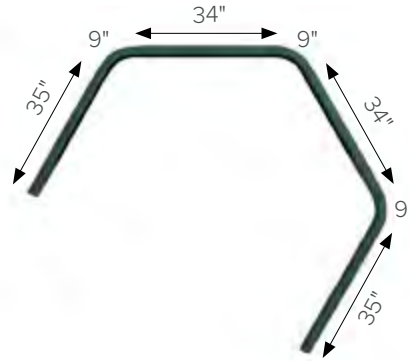
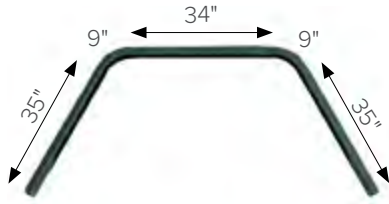

Height adjustable worksurface dimensions

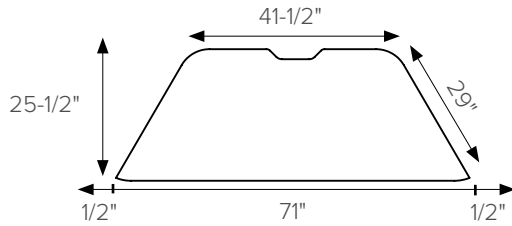

72" Height Adjustable Worksurface

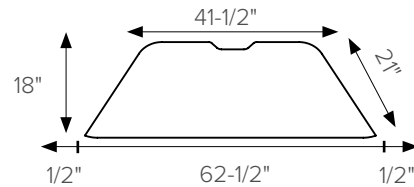

63-1/2" Height Adjustable Worksurface

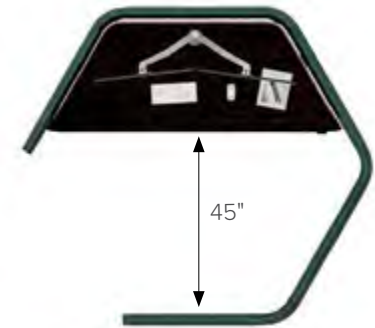

Fixed worksurface dimensions

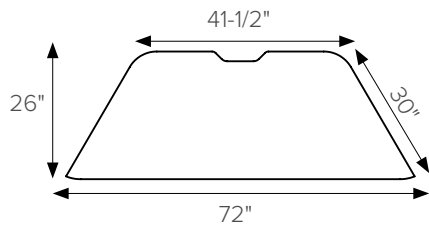

72" Fixed Worksurface

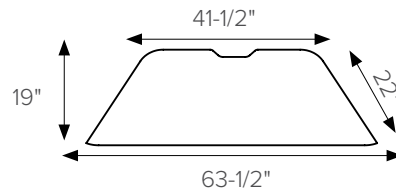

63-1/2" Fixed Height Worksurface

Honey workstations can be specified to meet New York electrical requirements. A flexible infeed, junction box and removable cover is included when specifying New York Power. The infeed and junction box are required to be on the Starter Panel at the first workstation next to a Single or Double Sided Power Panel. The customer will need to specify if the removable cover will need to be on the inside or outside of the workstation Starter Panel. NYPE: New York Power - \$425 list.

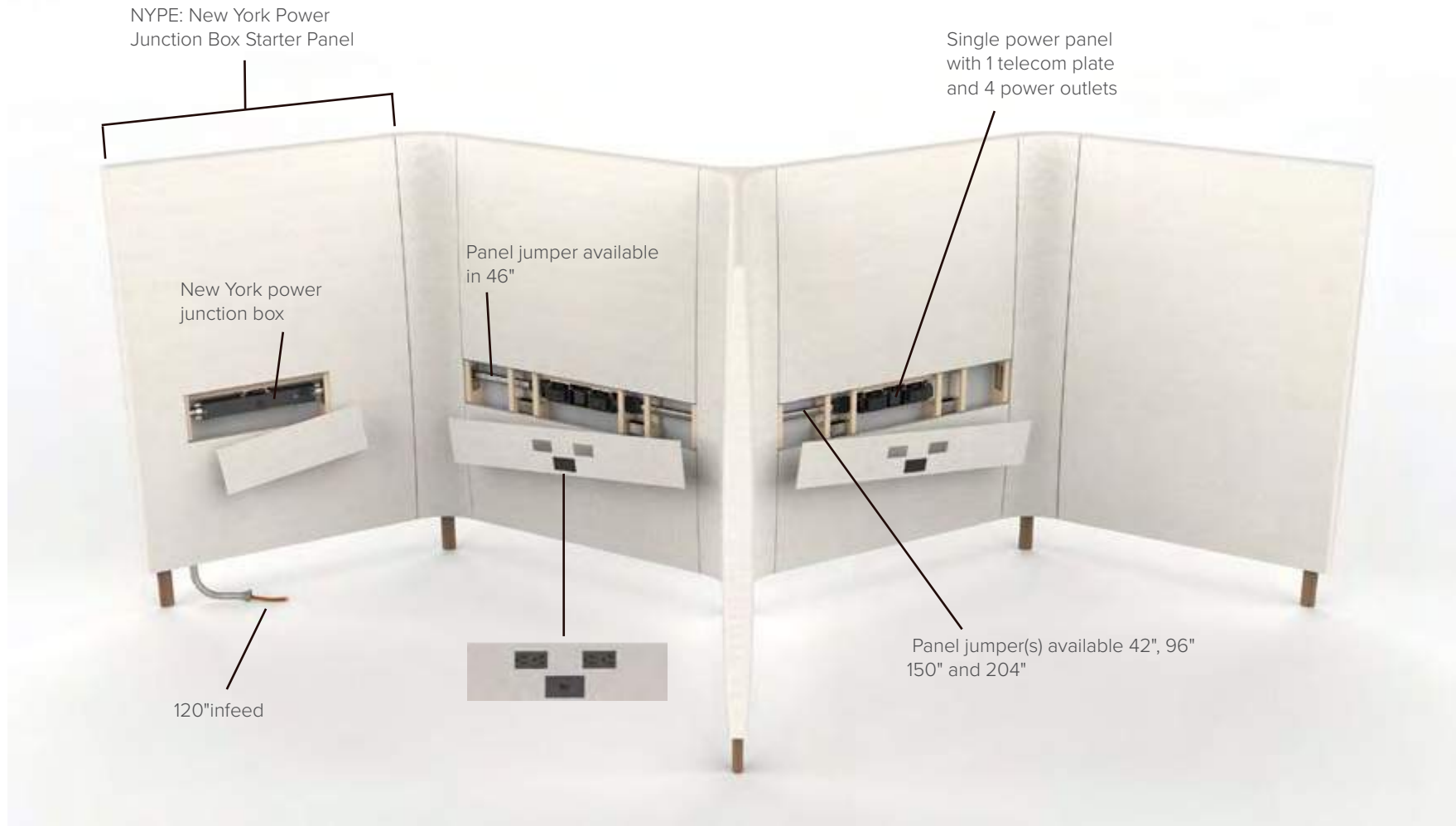

Rounded Starter Panels are not available with NYPE: New York Power Entry option.

*Please check with general contractor to see if NYPE: New York Power option is required.

Honey workstations can be specified to meet West Coast electrical requirements. A Circuitrac energy management system and flexible infeed is included and must be specifying on a Starter Panel at the first workstation next to a Single or Double Sided Power Panel. The customer will need to specify if the removable cover will need to be on the inside or outside of the workstation Starter Panel. WCPE: West Coast Power - \$2,695.

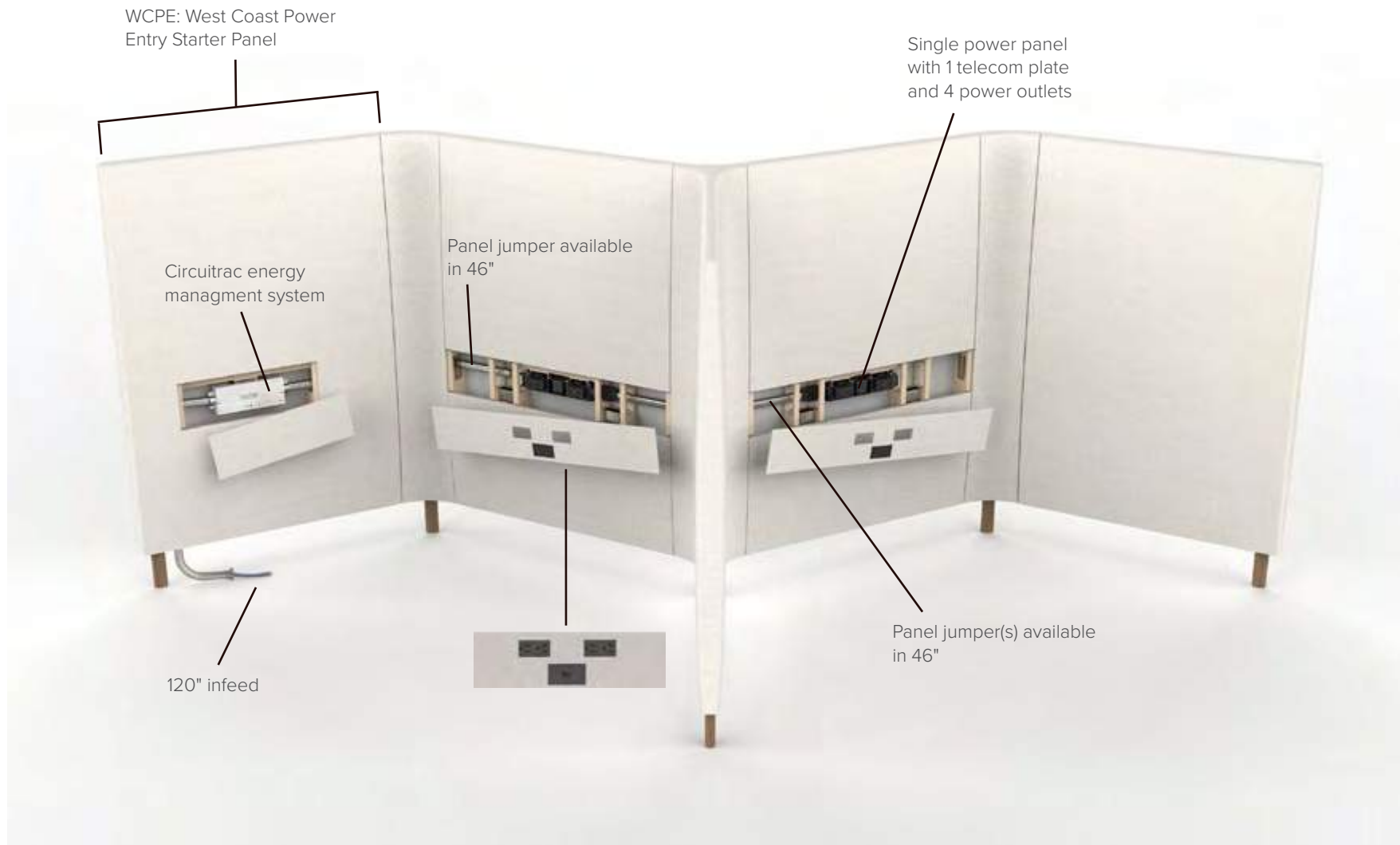

Rounded Starter Panels are not available with WCPE: West Coast Power option.

*Please check with general contractor to see if WCPE: West Coast Power option is required.

Honey workstations can be specified with a Single or Double Sided Power Panel to meet Chicago electrical requirements. Chicago Power Panels include an electrical box inside Power Panels for a local electrician to wire receptacles and connectors. CSSPP: Single Sided Power Panel - \$25. CDSPP: Double Sided Power Panel - \$50.

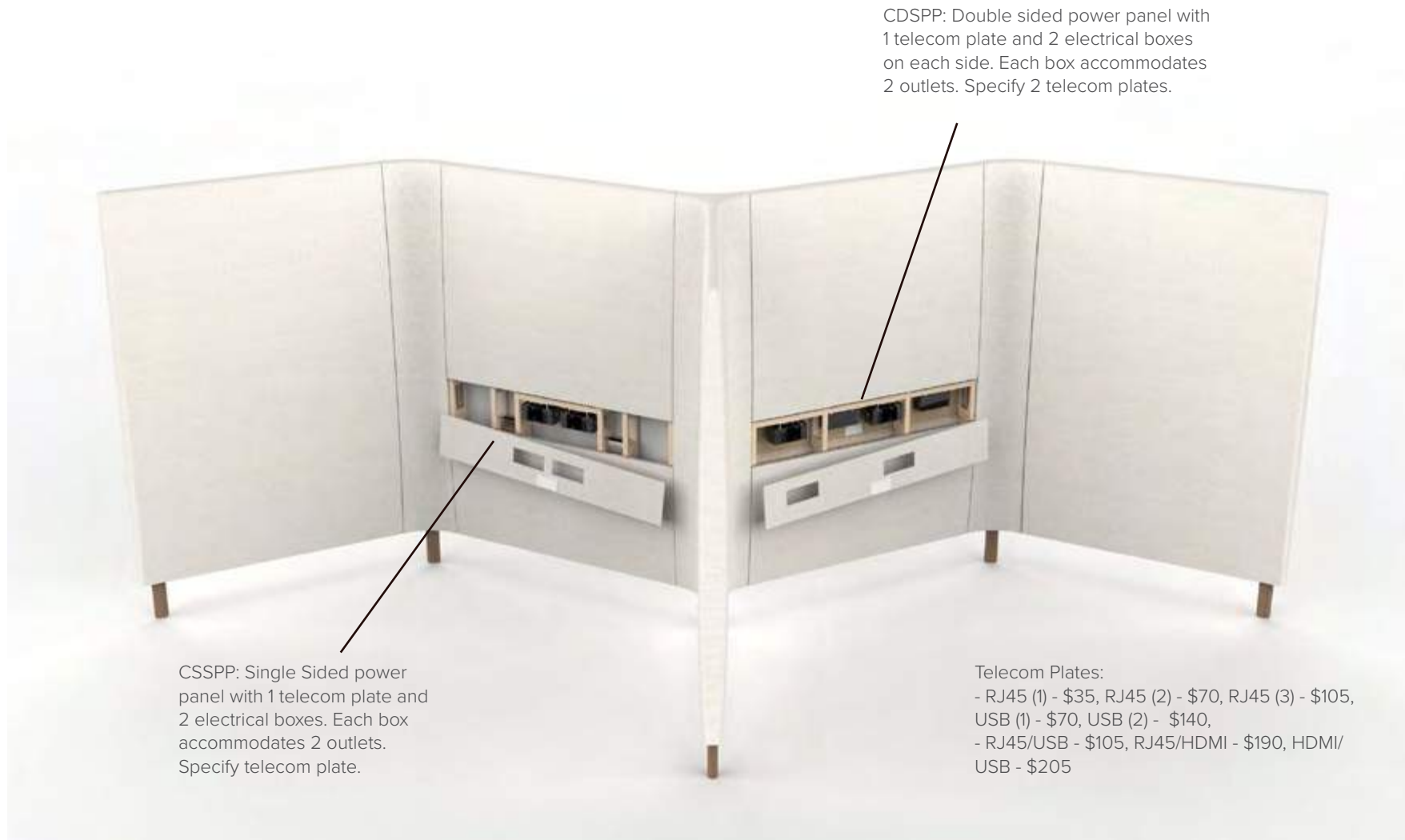

*Please check with general contractor to see if Chicago Power is required.

Interior drawer dimensions

UNIT DEPTH	DRAWER TYPE	OVERALL DIMENSIONS			INTERIOR DRAWER DIMENSIONS			NOTES
		W	D	H	W	D	H	
15-5/8" Letter	18" Box	13-1/8	16-1/16	4	12-1/8	15-1/16	3-7/16	Units less than 72"
	18" File	13-1/8	16-1/16	9-13/16	12-1/8	15-1/16	9-5/16	Units less than 72"
	10" Box	7-1/2	16-1/16	4	6-1/2	15-1/16	3-7/16	
	10" File	7-1/2	16-1/16	9-13/16	6-1/2	15-1/16	9-5/16	

Filing reference

Filing for 10" depth units

7-1/2" Wide File Drawer - 16 1/16" Deep



Letter Side to Side

Mobile Pedestal and Tower

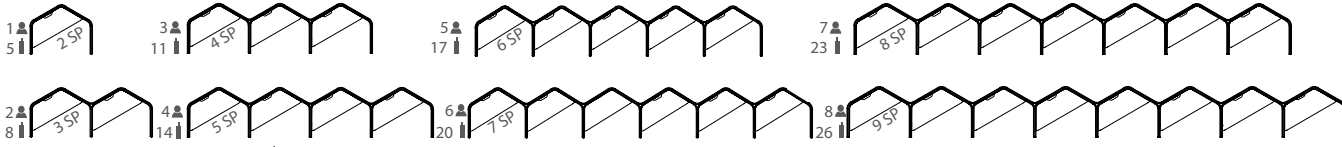

Number of Feet per Typical (MTL10 Option) "SP" Number of Starter Panels per Typical (RSP Option)

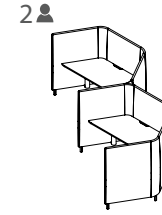

Height Adjustable Workstation



Powered Workstation

1 Select Model

w" x d" x h"	Weight	Standard Veneer Top Upholstered Panels - COM\$	Premium Veneer Top Upholstered Panels - COM\$
602 x 62 x 55	96	8 HNY60262HA571W 70057	"P" Option N/A
528 x 62 x 55	84	7 HNY52862HA571W 61493	"P" Option N/A
453 x 62 x 55	73	6 HNY45362HA571W 52929	"P" Option N/A
378 x 62 x 55	61	5 HNY37862HA571W 44365	"P" Option N/A
303 x 62 x 55	50	4 HNY30362HA571W 35801	"P" Option N/A
228 x 62 x 55	38	3 HNY22862HA571W 27237	"P" Option N/A
153 x 62 x 55	27	2 HNY15362HA571W 18673	"P" Option N/A
78 x 62 x 55	15	1 HNY7862HA571W 10109	"P" Option N/A

[Click Here for Graded in Pricing](#)

2 Select Finish

Click to view finishes

WWP	WOW
PO01	WNO
PO02	WSO
PO03	WNF(Natural Oak on Flat Cut)
PO07	WSF(Salted Oak on Flat Cut)
PO08	WSF(Salted Oak on Flat Cut)
PO09	WSF(Salted Oak on Flat Cut)
WBW	
WSW	
WEC	

3 Select Feet Finish

Click to view edges

WWP	WOW
PO01	WNO
PO02	WSO
PO03	
PO07	
PO08	
PO09	
WBW	
WSW	
WEC	

4 Select Edge

Click to view details



High Pressure Laminate Top Upholstered Panels - COM\$

HNY60262HA571G	68449
HNY52862HA571G	60086
HNY45362HA571G	51723
HNY37862HA571G	43360
HNY30362HA571G	34997
HNY22862HA571G	26634
HNY15362HA571G	18271
HNY7862HA571G	9908

GEC	LW04
GNA +5%	LW05
GWL	LW06
LP01	
LF02	
LF03	
LN01	
LA02	
LW01	
LW02	

WWP	WOW
PO01	WNO
PO02	WSO
PO03	
PO07	
PO08	
PO09	
WBW	
WSW	
WEC	



Thermally Fused Laminate Top Upholstered Panels - COM\$

HNY60262HA571M	65393
HNY52862HA571M	57412
HNY45362HA571M	49431
HNY37862HA571M	41450
HNY30362HA571M	33469
HNY22862HA571M	25488
HNY15362HA571M	17507
HNY7862HA571M	9526

MOC
MEC
MSW
MTW
MWL
MNA

WWP	WOW
PO01	WNO
PO02	WSO
PO03	
PO07	
PO08	
PO09	
WBW	
WSW	



[Click here to view statement of line](#)

Product Features

- 5" Solid wood feet - oval shape, ships KD
- 4 Power outlets with 1 telecom plate, see options below for telecom plate
- Adjustable height from 27" to 47.5" with a maximum weight capacity of 275 lbs.
- Lift standard in MFW White, optional MFB Black
- HNY7125WT163 Height Adjustable worksurfaces are included
- Wire management tray attaches to worksurface top, standard in MFW White, see premium Metal Finish for options
- T75 worksurface wire cutout is standard on all worksurfaces.(T75D: Delete cutout is optional)

Notes

- 1" Gap between worksurface and panels to drop wires below worksurface
- Metal parts include 5 year warranty
- Programmable height adjustable mechanism, motor includes 2 year warranty

Options

Accessories

- K28: Articulating Keyboard w/ Mouse - \$390
- K31-SK: Center drawer w/ skirt - \$310
- K31: Center drawer w/o skirt - \$205

Concealed Floor Power Infeed Cover

- PCEB: White Metal Finish concealed floor power infeed cover - \$150

Delete Top and Wire Tray

- DHAT: Delete height adjustable top. Deduct \$3845 Veneer(W), \$3644 High Pressure Laminate(G), \$3262 Thermally Fused Laminate(M) per top

Metal Feet

- MTL10: Replace solid wood feet with metal feet, standard MFW White - \$55 ea

Premium Metal Finish

- Specify premium Metal Finish. MFMB: Matte Black, MFS: Silver, MFSS: Salmon Sienna, MFSA: Surfin Aquavert, MFPS: Pistachio, MFOS: Oyster, MFNA: Navy, MFOL: Olive, MFGB: Grey Beige MFGG: Graphite Gray, MFG: Gray, MFGM:Matte Gold
- Premium Metal Finish for WMT Wire Management Tray - \$75 ea
- Premium Metal Finish for MTL10 Metal Feet - \$20 ea
- Premium Metal Finish for PCEB Concealed Floor Power Infeed Cover - \$35

Starter Panel

- RSP: Substitute round starter panel in place of flat starter panel. Must substitute all starters, priced per starter panel - \$83 each. See HNY3555SP888

Telecom Plates

- Each power unit has 1 plate. All telecom connectors sold separately.
- RJ45 (1) - \$55, RJ45 (2) - \$110, RJ45 (3) - \$165, USB (1) - \$70, USB (2) - \$140, RJ45/USB - \$125, RJ45/HDMI - \$210, HDMI/USB - \$205

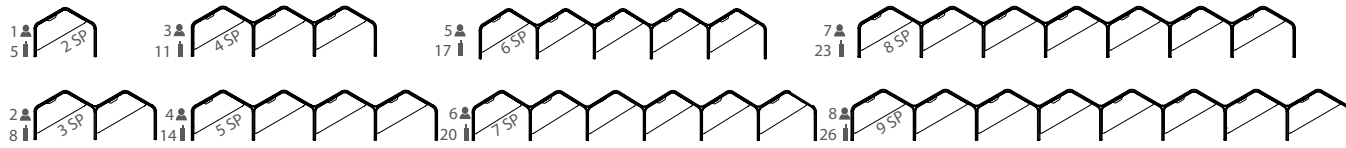

Number of Feet per Typical (MTL10 Option) "SP" Number of Starter Panels per Typical (RSP Option)

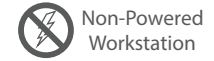
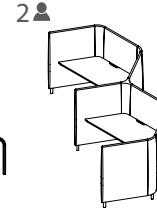

1 Select Model

w" x d" x h"	Weight	Standard Veneer Top Upholstered Panels - COM\$	Premium Veneer Top Upholstered Panels - COM\$
602 x 62 x 55	96	8 HNY60262FT571W 47826	"P" Option N/A
528 x 62 x 55	84	7 HNY52862FT571W 42024	"P" Option N/A
453 x 62 x 55	73	6 HNY45362FT571W 36222	"P" Option N/A
378 x 62 x 55	61	5 HNY37862FT571W 30420	"P" Option N/A
303 x 62 x 55	50	4 HNY30362FT571W 24618	"P" Option N/A
228 x 62 x 55	38	3 HNY22862FT571W 18816	"P" Option N/A
153 x 62 x 55	27	2 HNY15362FT571W 13014	"P" Option N/A
78 x 62 x 55	15	1 HNY7862FT571W 7212	"P" Option N/A

[Click Here for Graded in Pricing](#)

2 Select Finish

Click to view finishes

WWP	WOW
PO01	WNO
PO02	WSO
PO03	WNF(Natural Oak on Flat Cut)
PO07	WSF(Salted Oak on Flat Cut)
PO08	WSF(Salted Oak on Flat Cut)
PO09	WSF(Salted Oak on Flat Cut)
WBW	
WSW	
WEC	

3 Select Feet Finish

Click to view edges

WWP	WOW
PO01	WNO
PO02	WSO
PO03	
PO07	
PO08	
PO09	
WBW	
WSW	
WEC	

4 Select Edge

Click to view details

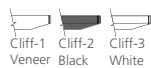

High Pressure Laminate Top Upholstered Panels - COM\$

HNY60262FT571G 46226	"P" Option N/A
HNY52862FT571G 40624	"P" Option N/A
HNY45362FT571G 35022	"P" Option N/A
HNY37862FT571G 29420	"P" Option N/A
HNY30362FT571G 23818	"P" Option N/A
HNY22862FT571G 18216	"P" Option N/A
HNY15362FT571G 12614	"P" Option N/A
HNY7862FT571G 7012	"P" Option N/A

GEC	LW04
GNA +5%	LW05
GWL	LW06
LP01	
LF02	
LF03	
LN01	
LA02	
LW01	
LW02	

WWP	WOW
PO01	WNO
PO02	WSO
PO03	
PO07	
PO08	
PO09	
WBW	
WSW	
WEC	



Thermally Fused Laminate Top Upholstered Panels - COM\$

HNY60262FT571M 43170	"P" Option N/A
HNY52862FT571M 37950	"P" Option N/A
HNY45362FT571M 32730	"P" Option N/A
HNY37862FT571M 27510	"P" Option N/A
HNY30362FT571M 22290	"P" Option N/A
HNY22862FT571M 17070	"P" Option N/A
HNY15362FT571M 11850	"P" Option N/A
HNY7862FT571M 6630	"P" Option N/A

MOC
MEC
MSW
MTW
MWL
MNA

WWP	WOW
PO01	WNO
PO02	WSO
PO03	
PO07	
PO08	
PO09	
WBW	
WSW	



[Click here to view statement of line](#)

Product Features

- 5" Solid wood feet - oval shape
- HNY7226WT162 Fixed Desk Height worksurfaces, 29" worksurface height
- Ships KD
- T75 worksurface wire cutout is standard on all worksurfaces.(T75D: Delete cutout is optional)

Options

Accessories

- K28: Articulating Keyboard w/ Mouse - \$390
- K31-SK: Center drawer w/ skirt - \$310
- K31: Center drawer w/o skirt - \$205

Concealed Floor Power Infeed Cover

- PCEB: White Metal Finish concealed floor power infeed cover - \$150

Delete Top

- DFT: Delete fixed top. Deduct \$1325 Veneer(W), \$1125 High Pressure Laminate (G), \$743 Thermally Fused Laminate (M) per top

Metal Feet

- MTL10: Replace solid wood feet with metal feet, standard MFW White - \$55 ea

Premium Metal Finish

- Specify premium Metal Finish. MFMB: Matte Black, MFS: Silver, MFSS: Salmon Sienna, MFSA: Surfing Aquavert, MFPS: Pistachio, MFOS: Oyster, MFNA: Navy, MFOL: Olive, MFGB: Grey Beige MFGG: Graphite Gray, MFG: Gray, MFGM:Matte Gold
- Premium Metal Finish for WMT Wire Management Tray - \$75 ea
- Premium Metal Finish for MTL10 Metal Feet - \$20 ea
- Premium Metal Finish for PCEB Concealed Floor Power Infeed Cover - \$35

Starter Panel

- RSP: Substitute round starter panel in place of flat starter panel. Must substitute all starters, priced per starter panel - \$83 each. See HNY3555SP888

Worksurface Height

- Modify worksurface height to bar height.
- THL-42: Position worksurface at bar height - N/C

Wire Tray

- WMT: Wire metal tray. Mounts under top and comes standard in MFW White - \$210

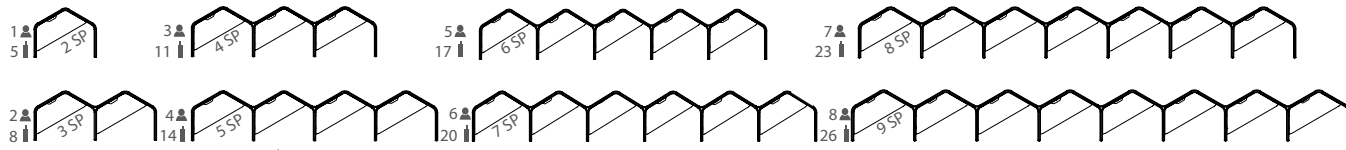

Number of Feet per Typical (MTL10 Option) "SP" Number of Starter Panels per Typical (RSP Option)

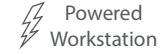
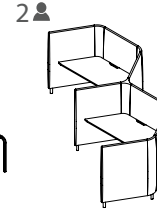

1 Select Model

w" x d" x h"	Weight	Standard Veneer Top Upholstered Panels - COM\$	Premium Veneer Top Upholstered Panels - COM\$
602 x 62 x 55	96	8 HNY60262FP571W 51729	"P" Option N/A
528 x 62 x 55	84	7 HNY52862FP571W 45456	"P" Option N/A
453 x 62 x 55	73	6 HNY45362FP571W 39183	"P" Option N/A
378 x 62 x 55	61	5 HNY37862FP571W 32910	"P" Option N/A
303 x 62 x 55	50	4 HNY30362FP571W 26637	"P" Option N/A
228 x 62 x 55	38	3 HNY22862FP571W 20364	"P" Option N/A
153 x 62 x 55	27	2 HNY15362FP571W 14091	"P" Option N/A
78 x 62 x 55	15	1 HNY7862FP571W 7818	"P" Option N/A

[Click Here for Graded in Pricing](#)

2 Select Finish

Click to view finishes

WWP	WOW
PO01	WNO
PO02	WSO
PO03	WNF(Natural Oak on Flat Cut)
PO07	WSF(Salted Oak on Flat Cut)
PO08	WSF(Salted Oak on Flat Cut)
PO09	WSF(Salted Oak on Flat Cut)
WBW	
WSW	
WEC	

3 Select Feet Finish

Click to view edges

WWP	WOW
PO01	WNO
PO02	WSO
PO03	
PO07	
PO08	
PO09	
WBW	
WSW	
WEC	

4 Select Edge

Click to view details

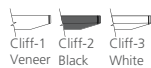

High Pressure Laminate Top Upholstered Panels - COM\$

HNY60262FP571G	50129
HNY52862FP571G	44056
HNY45362FP571G	37983
HNY37862FP571G	31910
HNY30362FP571G	25837
HNY22862FP571G	19764
HNY15362FP571G	13691
HNY7862FP571G	7618

GEC	LW04
GNA +5%	LW05
GWL	LW06
LP01	
LF02	
LF03	
LN01	
LA02	
LW01	
LW02	

WWP	WOW
PO01	WNO
PO02	WSO
PO03	
PO07	
PO08	
PO09	
WBW	
WSW	
WEC	



Thermally Fused Laminate Top Upholstered Panels - COM\$

HNY60262FP571M	47073
HNY52862FP571M	41382
HNY45362FP571M	35691
HNY37862FP571M	30000
HNY30362FP571M	24309
HNY22862FP571M	18618
HNY15362FP571M	12927
HNY7862FP571M	7236

MOC
MEC
MSW
MTW
MWL
MNA

WWP	WOW
PO01	WNO
PO02	WSO
PO03	
PO07	
PO08	
PO09	
WBW	
WSW	



[Click here to view statement of line](#)

Product Features

- HNY7226WT162 Fixed Desk Height worksurfaces, 29" worksurface height
- 5" Solid wood feet - oval shape
- 4 Power outlets with 1 telecom plate, see options below for telecom plate
- Ships KD
- Wire management tray attaches to worksurface top, standard in MFW White, see premium Metal Finish for options
- Hardwire infeed and jumpers are included in workstations
- T75 worksurface wire cutout is standard on all worksurfaces.(T75D: Delete cutout is optional)

Options

Accessories

- K28: Articulating Keyboard w/ Mouse - \$390
- K31-SK: Center drawer w/ skirt - \$310
- K31: Center drawer w/o skirt - \$205

Concealed Floor Power Infeed Cover

- PCEB: White Metal Finish concealed floor power infeed cover - \$150

Delete Top and Wire Tray

- DFP: Delete fixed top. Deduct \$1535 Veneer (W), \$1335 High Pressure Laminate (G), \$953 Thermally Fused Laminate (M) per top

Metal Feet

- MTL10: Replace solid wood feet with metal feet, standard MFW White - \$55 ea

Premium Metal Finish

- Specify premium Metal Finish. MFMB: Matte Black, MFS: Silver, MFSS: Salmon Sienna, MFSA: SurfIn Aquavert, MFPS: Pistachio, MFOS: Oyster, MFNA: Navy, MFOL: Olive, MFGB: Grey Beige MFGG: Graphite Gray, MFG: Gray, MFGM:Matte Gold
- Premium Metal Finish for WMT Wire Management Tray - \$75 ea
- Premium Metal Finish for MTL10 Metal Feet - \$20 ea
- Premium Metal Finish for PCEB Concealed Floor Power Infeed Cover - \$35

Starter Panel

- RSP: Substitute round starter panel in place of flat starter panel. Must substitute all starters, priced per starter panel - \$83 each. See HNY3555SP888

Telecom Plates

- Each power unit has 1 plate. All telecom connectors sold separately.
- RJ45 (1) - \$55, RJ45 (2) - \$110, RJ45 (3) - \$165, USB (1) - \$70, USB (2) - \$140, RJ45/USB - \$125, RJ45/HDMI - \$210, HDMI/USB - \$205

Worksurface Height

- THL-42: Modify worksurface height to bar height - N/C

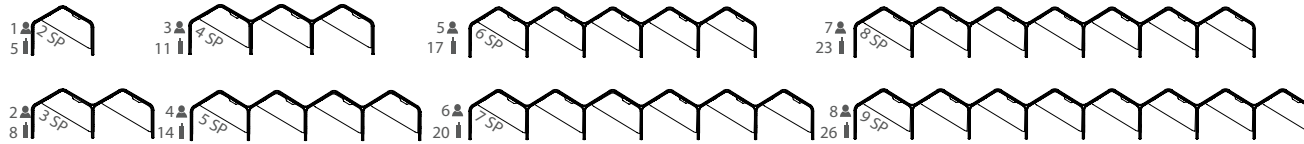

Number of Feet per Typical (MTL10 Option) "SP" Number of Starter Panels per Typical (RSP Option)

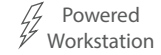
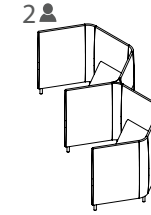

1 Select Model

w" x d" x h"	Weight	Standard Veneer Top Upholstered Panels - COM\$	Premium Veneer Top Upholstered Panels - COM\$	High Pressure Laminate Top Upholstered Panels - COM\$	Thermally Fused Laminate Top Upholstered Panels - COM\$
602 x 62 x 55	96	8 HNY60262HA572W 70057	"P" Option N/A	HNY60262HA572G 68449	HNY60262HA572M 65393
528 x 62 x 55	84	7 HNY52862HA572W 61493	"P" Option N/A	HNY52862HA572G 60086	HNY52862HA572M 57412
453 x 62 x 55	73	6 HNY45362HA572W 52929	"P" Option N/A	HNY45362HA572G 51723	HNY45362HA572M 49431
378 x 62 x 55	61	5 HNY37862HA572W 44365	"P" Option N/A	HNY37862HA572G 43360	HNY37862HA572M 41450
303 x 62 x 55	50	4 HNY30362HA572W 35801	"P" Option N/A	HNY30362HA572G 34997	HNY30362HA572M 33469
228 x 62 x 55	38	3 HNY22862HA572W 27237	"P" Option N/A	HNY22862HA572G 26634	HNY22862HA572M 25488
153 x 62 x 55	27	2 HNY15362HA572W 18673	"P" Option N/A	HNY15362HA572G 18271	HNY15362HA572M 17507
78 x 62 x 55	15	1 HNY7862HA572W 10109	"P" Option N/A	HNY7862HA572G 9908	HNY7862HA572M 9526

[Click Here for Graded in Pricing](#)

2 Select Finish

Click to view finishes

WWP	WOW
PO01	WNO
PO02	WSO
PO03	WNF(Natural Oak on Flat Cut)
PO07	WSF(Salted Oak on Flat Cut)
PO08	WSF(Salted Oak on Flat Cut)
PO09	WSF(Salted Oak on Flat Cut)
WBW	
WSW	
WEC	

3 Select Feet Finish

Click to view edges

WWP	WOW
PO01	WNO
PO02	WSO
PO03	
PO07	
PO08	
PO09	
WBW	
WSW	
WEC	

4 Select Edge

Click to view details

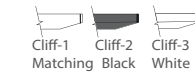
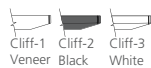

[Click here to view statement of line](#)

Product Features

- 5" Solid wood feet - oval shape, ships KD
- 4 Power outlets with 1 telecom plate, see options below for telecom plate
- Adjustable height from 27" to 47.5" with a maximum weight capacity of 275 lbs. Lift standard in MFW White, optional MFB Black
- HNY7125WT163 Height Adjustable worksurfaces are included
- Wire management tray attaches to worksurface top, standard in MFW White, see premium Metal Finish for options
- T75 worksurface wire cutout is standard on all worksurfaces.(T75D: Delete cutout is optional)

Notes

- 1" Gap between worksurface and panels to drop wires below worksurface
- Metal parts include 5 year warranty
- Programmable height adjustable mechanism, motor includes 2 year warranty

Options

Accessories

- K28: Articulating Keyboard w/ Mouse - \$390
- K31-SK: Center drawer w/ skirt - \$310
- K31: Center drawer w/o skirt - \$205

Concealed Floor Power Infeed Cover

- PCEB: White Metal Finish concealed floor power infeed cover - \$150

Delete Top and Wire Tray

- DHAT: Delete height adjustable top. Deduct \$3845 Veneer(W), \$3644 High Pressure Laminate(G), \$3262 Thermally Fused Laminate(M) per top

Metal Feet

- MTL10: Replace solid wood feet with metal feet, standard MFW White - \$55 ea

Premium Metal Finish

- Specify premium Metal Finish. MFMB: Matte Black, MFS: Silver, MFSS: Salmon Sienna, MFSA: Surfin Aquavert, MFPS: Pistachio, MFOS: Oyster, MFNA: Navy, MFOL: Olive, MFGB: Grey Beige MFGG: Graphite Gray, MFG: Gray, MFGM:Matte Gold
- Premium Metal Finish for WMT Wire Management Tray - \$75 ea
- Premium Metal Finish for MTL10 Metal Feet - \$20 ea
- Premium Metal Finish for PCEB Concealed Floor Power Infeed Cover - \$35

Starter Panel

- RSP: Substitute round starter panel in place of flat starter panel. Must substitute all starters, priced per starter panel - \$83 each. See HNY3555SP888

Telecom Plates

- Each power unit has 1 plate. All telecom connectors sold separately.
- RJ45 (1) - \$55, RJ45 (2) - \$110, RJ45 (3) - \$165, USB (1) - \$70, USB (2) - \$140, RJ45/USB - \$125, RJ45/HDMI - \$210, HDMI/USB - \$205

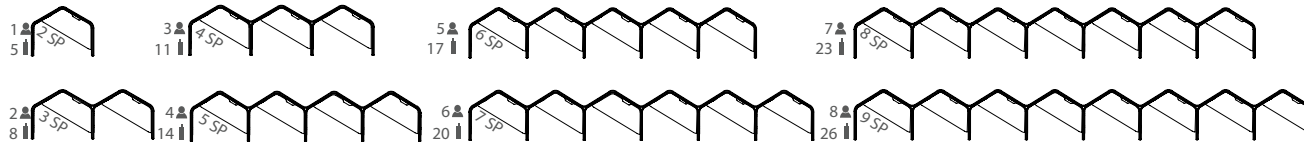

Number of Feet per Typical (MTL10 Option) "SP" Number of Starter Panels per Typical (RSP Option)

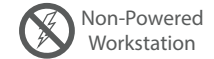
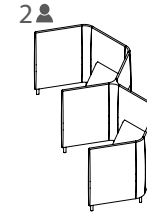

1 Select Model

w" x d" x h"	Weight	Standard Veneer Top Upholstered Panels - COM\$	Premium Veneer Top Upholstered Panels - COM\$	High Pressure Laminate Top Upholstered Panels - COM\$	Thermally Fused Laminate Top Upholstered Panels - COM\$
602 x 62 x 55	96	8 HNY60262FT572W 47826	"P" Option N/A	HNY60262FT572G 46226	HNY60262FT572M 43170
528 x 62 x 55	84	7 HNY52862FT572W 42024	"P" Option N/A	HNY52862FT572G 40624	HNY52862FT572M 37950
453 x 62 x 55	73	6 HNY45362FT572W 36222	"P" Option N/A	HNY45362FT572G 35022	HNY45362FT572M 32730
378 x 62 x 55	61	5 HNY37862FT572W 30420	"P" Option N/A	HNY37862FT572G 29420	HNY37862FT572M 27510
303 x 62 x 55	50	4 HNY30362FT572W 24618	"P" Option N/A	HNY30362FT572G 23818	HNY30362FT572M 22290
228 x 62 x 55	38	3 HNY22862FT572W 18816	"P" Option N/A	HNY22862FT572G 18216	HNY22862FT572M 17070
153 x 62 x 55	27	2 HNY15362FT572W 13014	"P" Option N/A	HNY15362FT572G 12614	HNY15362FT572M 11850
78 x 62 x 55	15	1 HNY7862FT572W 7212	"P" Option N/A	HNY7862FT572G 7012	HNY7862FT572M 6630

[Click Here for Graded in Pricing](#)

2 Select Finish

Click to view finishes

WWP	WOW
PO01	WNO
PO02	WSO
PO03	WNF(Natural Oak on Flat Cut)
PO07	WSF(Salted Oak on Flat Cut)
PO08	WSF(Salted Oak on Flat Cut)
PO09	WSF(Salted Oak on Flat Cut)
WBW	
WSW	
WEC	

3 Select Feet Finish

Click to view edges

WWP	WOW
PO01	WNO
PO02	WSO
PO03	
PO07	
PO08	
PO09	
WBW	
WSW	
WEC	

4 Select Edge

Click to view details

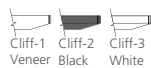

GEC	LW04
GNA +5%	LW05
GWL	LW06
LP01	
LF02	
LF03	
LN01	
LA02	
LW01	
LW02	

WWP	WOW
PO01	WNO
PO02	WSO
PO03	
PO07	
PO08	
PO09	
WBW	
WSW	
WEC	



MOC
MEC
MSW
MTW
MWL
MNA

WWP	WOW
PO01	WNO
PO02	WSO
PO03	
PO07	
PO08	
PO09	
WBW	
WSW	



[Click here to view statement of line](#)

Product Features

- 5" Solid wood feet - oval shape
- HNY7226WT162 Fixed Desk Height worksurfaces, 29" worksurface height
- Ships KD
- T75 worksurface wire cutout is standard on all worksurfaces.(T75D: Delete cutout is optional)

Options

Accessories

- K28: Articulating Keyboard w/ Mouse - \$390
- K31-SK: Center drawer w/ skirt - \$310
- K31: Center drawer w/o skirt - \$205

Concealed Floor Power Infeed Cover

- PCEB: White Metal Finish concealed floor power infeed cover - \$150

Delete Top

- DFT: Delete fixed top. Deduct \$1325 Veneer(W), \$1125 High Pressure Laminate (G), \$743 Thermally Fused Laminate (M) per top

Metal Feet

- MTL10: Replace solid wood feet with metal feet, standard MFW White - \$55 ea

Premium Metal Finish

- Specify premium Metal Finish. MFMB: Matte Black, MFS: Silver, MFSS: Salmon Sienna, MFSA: Surfing Aquavert, MFPS: Pistachio, MFOS: Oyster, MFNA: Navy, MFOL: Olive, MFGB: Grey Beige MFGG: Graphite Gray, MFG: Gray, MFGM:Matte Gold
- Premium Metal Finish for WMT Wire Management Tray - \$75 ea
- Premium Metal Finish for MTL10 Metal Feet - \$20 ea
- Premium Metal Finish for PCEB Concealed Floor Power Infeed Cover - \$35

Starter Panel

- RSP: Substitute round starter panel in place of flat starter panel. Must substitute all starters, priced per starter panel - \$83 each. See HNY3555SP888

Worksurface Height

- Modify worksurface height to bar height.
- THL-42: Position worksurface at bar height - N/C

Wire Tray

- WMT: Wire metal tray. Mounts under top and comes standard in MFW White - \$210

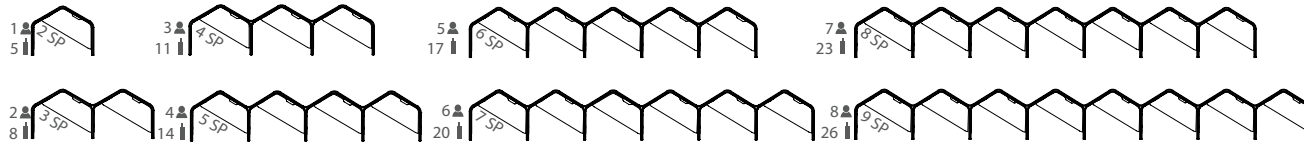

Number of Feet per Typical (MTL10 Option) "SP" Number of Starter Panels per Typical (RSP Option)

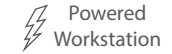
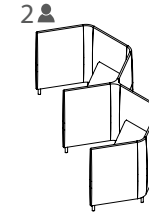

1 Select Model

w" x d" x h"	Weight	Standard Veneer Top Upholstered Panels - COM\$	Premium Veneer Top Upholstered Panels - COM\$
602 x 62 x 55	96	8 HNY60262FP572W 51729	"P" Option N/A
528 x 62 x 55	84	7 HNY52862FP572W 45456	"P" Option N/A
453 x 62 x 55	73	6 HNY45362FP572W 39183	"P" Option N/A
378 x 62 x 55	61	5 HNY37862FP572W 32910	"P" Option N/A
303 x 62 x 55	50	4 HNY30362FP572W 26637	"P" Option N/A
228 x 62 x 55	38	3 HNY22862FP572W 20364	"P" Option N/A
153 x 62 x 55	27	2 HNY15362FP572W 14091	"P" Option N/A
78 x 62 x 55	15	1 HNY7862FP572W 7818	"P" Option N/A

[Click Here for Graded in Pricing](#)

2 Select Finish

Click to view finishes

WWP	WOW
PO01	WNO
PO02	WSO
PO03	WNF(Natural Oak on Flat Cut)
PO07	WSF(Salted Oak on Flat Cut)
PO08	WSF(Salted Oak on Flat Cut)
PO09	WSF(Salted Oak on Flat Cut)
WBW	
WSW	
WEC	

3 Select Feet Finish

Click to view edges

WWP	WOW
PO01	WNO
PO02	WSO
PO03	
PO07	
PO08	
PO09	
WBW	
WSW	
WEC	

4 Select Edge

Click to view details

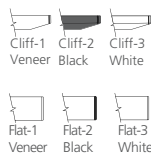

High Pressure Laminate Top Upholstered Panels - COM\$

HNY60262FP572G	50129
HNY52862FP572G	44056
HNY45362FP572G	37983
HNY37862FP572G	31910
HNY30362FP572G	25837
HNY22862FP572G	19764
HNY15362FP572G	13691
HNY7862FP572G	7618

GEC	LW04
GNA +5%	LW05
GWL	LW06
LP01	
LF02	
LF03	
LN01	
LA02	
LW01	
LW02	

WWP	WOW
PO01	WNO
PO02	WSO
PO03	
PO07	
PO08	
PO09	
WBW	
WSW	
WEC	

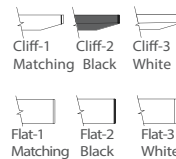

Thermally Fused Laminate Top Upholstered Panels - COM\$

HNY60262FP572M	47073
HNY52862FP572M	41382
HNY45362FP572M	35691
HNY37862FP572M	30000
HNY30362FP572M	24309
HNY22862FP572M	18618
HNY15362FP572M	12927
HNY7862FP572M	7236

MOC
MEC
MSW
MTW
MWL
MNA

WWP	WOW
PO01	WNO
PO02	WSO
PO03	
PO07	
PO08	
PO09	
WEC	
WBW	
WSW	



[Click here to view statement of line](#)

Product Features

- HNY7226WT162 Fixed Desk Height worksurfaces, 29" worksurface height
- 5" Solid wood feet - oval shape
- 4 Power outlets with 1 telecom plate, see options below for telecom plate
- Ships KD
- Wire management tray attaches to worksurface top, standard in MFW White, see premium Metal Finish for options
- Hardwire infeed and jumpers are included in workstations
- T75 worksurface wire cutout is standard on all worksurfaces.(T75D: Delete cutout is optional)

Options

Accessories

- K28: Articulating Keyboard w/ Mouse - \$390
- K31-SK: Center drawer w/ skirt - \$310
- K31: Center drawer w/o skirt - \$205

Concealed Floor Power Infeed Cover

- PCEB: White Metal Finish concealed floor power infeed cover - \$150

Delete Top and Wire Tray

- DFP: Delete fixed top. Deduct \$1535 Veneer (W), \$1335 High Pressure Laminate (G), \$953 Thermally Fused Laminate (M) per top

Metal Feet

- MTL10: Replace solid wood feet with metal feet, standard MFW White - \$55 ea

Premium Metal Finish

- Specify premium Metal Finish. MFMB: Matte Black, MFS: Silver, MFSS: Salmon Sienna, MFSA: Surfing Aquavert, MFPS: Pistachio, MFOS: Oyster, MFNA: Navy, MFOL: Olive, MFGB: Grey Beige MFGG: Graphite Gray, MFG: Gray, MFGM:Matte Gold
- Premium Metal Finish for WMT Wire Management Tray - \$75 ea
- Premium Metal Finish for MTL10 Metal Feet - \$20 ea
- Premium Metal Finish for PCEB Concealed Floor Power Infeed Cover - \$35

Starter Panel

- RSP: Substitute round starter panel in place of flat starter panel. Must substitute all starters, priced per starter panel - \$83 each. See HNY3555SP888

Telecom Plates

- Each power unit has 1 plate. All telecom connectors sold separately.
- RJ45 (1) - \$55, RJ45 (2) - \$110, RJ45 (3) - \$165, USB (1) - \$70, USB (2) - \$140, RJ45/USB - \$125, RJ45/HDMI - \$210, HDMI/USB - \$205

Worksurface Height

- THL-42: Modify worksurface height to bar height - N/C

Facing Diagonal Workstation Typical
Position 1 with Height Adjustable Worksurface

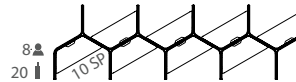
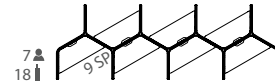
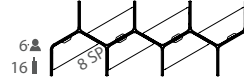
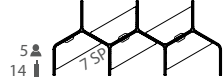
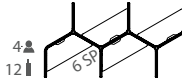
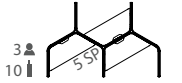

2

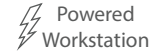
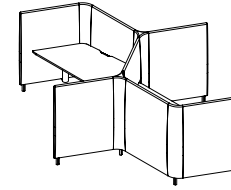

Number of Feet per Typical (MTL10 Option) "SP" Number of Starter Panels per Typical (RSP Option)

1 Select Model

w" x d" x h"	Weight	Standard Veneer Top Upholstered Panels - COM\$	Premium Veneer Top Upholstered Panels - COM\$	High Pressure Laminate Top Upholstered Panels - COM\$	Thermally Fused Laminate Top Upholstered Panels - COM\$
340 x 101 x 55	71	8 HNY340101HA573W 58841	"P" Option N/A	HNY340101HA573G 57233	HNY340101HA573M 54177
303 x 101 x 55	64	7 HNY303101HA573W 51918	"P" Option N/A	HNY303101HA573G 50511	HNY303101HA573M 47837
265 x 101 x 55	56	6 HNY265101HA573W 45266	"P" Option N/A	HNY265101HA573G 44060	HNY265101HA573M 41768
228 x 101 x 55	49	5 HNY228101HA573W 38343	"P" Option N/A	HNY228101HA573G 37338	HNY228101HA573M 35428
191 x 101 x 55	41	4 HNY191101HA573W 31691	"P" Option N/A	HNY191101HA573G 30887	HNY191101HA573M 29359
153 x 101 x 55	34	3 HNY153101HA573W 24768	"P" Option N/A	HNY153101HA573G 24165	HNY153101HA573M 23019
116 x 101 x 55	26	2 HNY116101HA573W 18116	"P" Option N/A	HNY116101HA573G 17714	HNY116101HA573M 16950

[Click Here for Graded in Pricing](#)

2 Select Finish

Click to view finishes

WWP	WOW
PO01	WNO
PO02	WSO
PO03	WNF(Natural Oak on Flat Cut)
PO07	WSF(Salted Oak on Flat Cut)
PO08	WSF(Salted Oak on Flat Cut)
PO09	WSF(Salted Oak on Flat Cut)
WBW	
WSW	
WEC	

3 Select Feet Finish

Click to view edges

WWP	WOW
PO01	WNO
PO02	WSO
PO03	
PO07	
PO08	
PO09	
WBW	
WSW	
WEC	

4 Select Edge

Click to view details

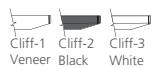

[Click here to view statement of line](#)

Product Features

- 5" Solid wood feet - oval shape, ships KD
- 4 Power outlets with 1 telecom plate, see options below for telecom plate
- Adjustable height from 27" to 47.5" with a maximum weight capacity of 275 lbs. Lift standard in MFW White, optional MFB Black
- HNY7125WT163 Height Adjustable worksurfaces are included
- Wire management tray attaches to worksurface top, standard in MFW White, see premium Metal Finish for options
- T75 worksurface wire cutout is standard on all worksurfaces.(T75D: Delete cutout is optional)

Notes

- 1" Gap between worksurface and panels to drop wires below worksurface
- Metal parts include 5 year warranty
- Programmable height adjustable mechanism, motor includes 2 year warranty

Options

Accessories

- K28: Articulating Keyboard w/ Mouse - \$390
- K31-SK: Center drawer w/ skirt - \$310
- K31: Center drawer w/o skirt - \$205

Concealed Floor Power Infeed Cover

- PCEB: White Metal Finish concealed floor power infeed cover - \$150

Delete Top and Wire Tray

- DHAT: Delete height adjustable top. Deduct \$3845 Veneer(W), \$3644 High Pressure Laminate(G), \$3262 Thermally Fused Laminate(M) per top

Metal Feet

- MTL10: Replace solid wood feet with metal feet, standard MFW White - \$55 ea

Premium Metal Finish

- Specify premium Metal Finish. MFMB: Matte Black, MFS: Silver, MFSS: Salmon Sienna, MFSA: Surfin Aquavert, MFPS: Pistachio, MFOS: Oyster, MFNA: Navy, MFOL: Olive, MFGB: Grey Beige MFGG: Graphite Gray, MFG: Gray, MFGM:Matte Gold
- Premium Metal Finish for WMT Wire Management Tray - \$75 ea
- Premium Metal Finish for MTL10 Metal Feet - \$20 ea
- Premium Metal Finish for PCEB Concealed Floor Power Infeed Cover - \$35

Starter Panel

- RSP: Substitute round starter panel in place of flat starter panel. Must substitute all starters, priced per starter panel - \$83 each. See HNY3555SP888

Telecom Plates

- Each power unit has 1 plate. All telecom connectors sold separately.
- RJ45 (1) - \$55, RJ45 (2) - \$110, RJ45 (3) - \$165, USB (1) - \$70, USB (2) - \$140, RJ45/USB - \$125, RJ45/HDMI - \$210, HDMI/USB - \$205

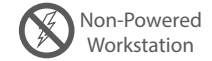
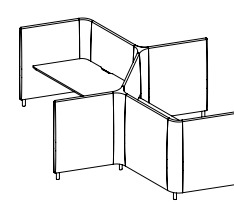
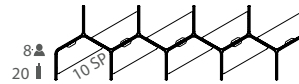
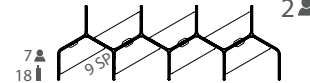
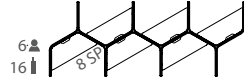
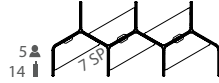
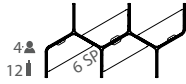
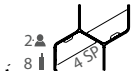

Number of Feet per Typical (MTL10 Option) "SP" Number of Starter Panels per Typical (RSP Option)

1 Select Model

w" x d" x h"	Weight	Standard Veneer Top Upholstered Panels - COM\$	Premium Veneer Top Upholstered Panels - COM\$
340 x 101 x 55	71	8 HNY340101FT573W 37836	"P" Option N/A
303 x 101 x 55	64	7 HNY303101FT573W 33616	"P" Option N/A
265 x 101 x 55	56	6 HNY265101FT573W 29396	"P" Option N/A
228 x 101 x 55	49	5 HNY228101FT573W 25176	"P" Option N/A
191 x 101 x 55	41	4 HNY191101FT573W 20956	"P" Option N/A
153 x 101 x 55	34	3 HNY153101FT573W 16736	"P" Option N/A
116 x 101 x 55	26	2 HNY116101FT573W 12516	"P" Option N/A

[Click Here for Graded in Pricing](#)

2 Select Finish

Click to view finishes

WWP	WOW
PO01	WNO
PO02	WSO
PO03	WNF(Natural Oak on Flat Cut)
PO07	WSF(Salted Oak on Flat Cut)
PO08	
PO09	
WBW	
WSW	
WEC	

3 Select Feet Finish

Click to view edges

WWP	WOW
PO01	WNO
PO02	WSO
PO03	
PO07	
PO08	
PO09	
WBW	
WSW	
WEC	

4 Select Edge

Click to view details

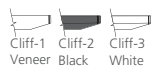

GEC	LW04
GNA +5%	LW05
GWL	LW06
LPO1	
LF02	
LF03	
LN01	
LA02	
LW01	
LW02	

WWP	WOW
PO01	WNO
PO02	WSO
PO03	
PO07	
PO08	
PO09	
WBW	
WSW	
WEC	

MOC
MEC
MSW
MTW
MWL
MNA

WWP	WOW
PO01	WNO
PO02	WSO
PO03	
PO07	
PO08	
PO09	
WBW	
WSW	

High Pressure Laminate Top Upholstered Panels - COM\$

HNY340101FT573G	36236
HNY303101FT573G	32216
HNY265101FT573G	28196
HNY228101FT573G	24176
HNY191101FT573G	20156
HNY153101FT573G	16136
HNY116101FT573G	12116

Thermally Fused Laminate Top Upholstered Panels - COM\$

HNY340101FT573M	33180
HNY303101FT573M	29542
HNY265101FT573M	25904
HNY228101FT573M	22266
HNY191101FT573M	18628
HNY153101FT573M	14990
HNY116101FT573M	11352

[Click here to view statement of line](#)

Product Features

- 5" Solid wood feet - oval shape
- HNY7226WT162 Fixed Desk Height worksurfaces, 29" worksurface height
- Ships KD
- T75 worksurface wire cutout is standard on all worksurfaces.(T75D: Delete cutout is optional)

Options

Accessories

- K28: Articulating Keyboard w/ Mouse - \$390
- K31-SK: Center drawer w/ skirt - \$310
- K31: Center drawer w/o skirt - \$205

Concealed Floor Power Infeed Cover

- PCEB: White Metal Finish concealed floor power infeed cover - \$150

Delete Top

- DFT: Delete fixed top. Deduct \$1325 Veneer(W), \$1125 High Pressure Laminate (G), \$743 Thermally Fused Laminate (M) per top

Metal Feet

- MTL10: Replace solid wood feet with metal feet, standard MFW White - \$55 ea

Premium Metal Finish

- Specify premium Metal Finish. MFMB: Matte Black, MFS: Silver, MFSS: Salmon Sienna, MFSA: Surfing Aquavert, MFPS: Pistachio, MFOS: Oyster, MFNA: Navy, MFOL: Olive, MFGB: Grey Beige MFGG: Graphite Gray, MFG: Gray, MFGM:Matte Gold
- Premium Metal Finish for WMT Wire Management Tray - \$75 ea
- Premium Metal Finish for MTL10 Metal Feet - \$20 ea
- Premium Metal Finish for PCEB Concealed Floor Power Infeed Cover - \$35

Starter Panel

- RSP: Substitute round starter panel in place of flat starter panel. Must substitute all starters, priced per starter panel - \$83 each. See HNY3555SP888

Worksurface Height

- Modify worksurface height to bar height.
- THL-42: Position worksurface at bar height - N/C

Wire Tray

- WMT: Wire metal tray. Mounts under top and comes standard in MFW White - \$210

Facing Diagonal Workstation Typical
Position 1 Desk with Power Fixed Worksurface

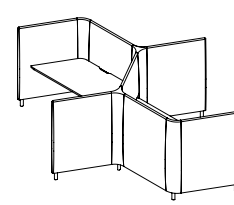
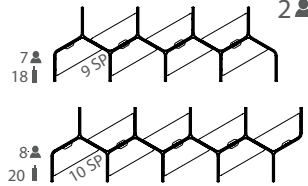
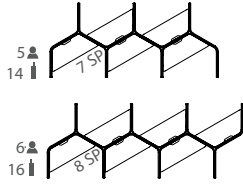
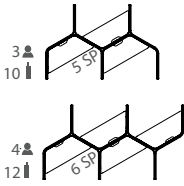
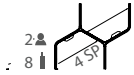

Number of Feet per Typical (MTL10 Option) "SP" Number of Starter Panels per Typical (RSP Option)

1 Select Model

w" x d" x h"	Weight	Standard Veneer Top Upholstered Panels - COM\$	Premium Veneer Top Upholstered Panels - COM\$	High Pressure Laminate Top Upholstered Panels - COM\$	Thermally Fused Laminate Top Upholstered Panels - COM\$
340 x 101 x 55	71	8 HNY340101FP573W 40513	"P" Option N/A	HNY340101FP573G 38913	HNY340101FP573M 35857
303 x 101 x 55	64	7 HNY303101FP573W 35881	"P" Option N/A	HNY303101FP573G 34481	HNY303101FP573M 31807
265 x 101 x 55	56	6 HNY265101FP573W 31520	"P" Option N/A	HNY265101FP573G 30320	HNY265101FP573M 28028
228 x 101 x 55	49	5 HNY228101FP573W 26888	"P" Option N/A	HNY228101FP573G 25888	HNY228101FP573M 23978
191 x 101 x 55	41	4 HNY191101FP573W 22527	"P" Option N/A	HNY191101FP573G 21727	HNY191101FP573M 20199
153 x 101 x 55	34	3 HNY153101FP573W 17895	"P" Option N/A	HNY153101FP573G 17295	HNY153101FP573M 16149
116 x 101 x 55	26	2 HNY116101FP573W 13534	"P" Option N/A	HNY116101FP573G 13134	HNY116101FP573M 12370

[Click Here for Graded in Pricing](#)

2 Select Finish

Click to view finishes	WWP	WOW
	PO01	WNO
	PO02	WSO
	PO03	WNF(Natural Oak on Flat Cut)
	PO08	WSF(Salted Oak on Flat Cut)
	PO09	
	WBW	
	WSW	
	WEC	

3 Select Feet Finish

Click to view edges	WWP	WOW
	PO01	WNO
	PO02	WSO
	PO03	
	PO07	
	PO08	
	PO09	
	WBW	
	WSW	
	WEC	

4 Select Edge

Click to view details



GEC	LW04
GNA +5%	LW05
GWL	LW06
LP01	
LF02	
LF03	
LN01	
LA02	
LW01	
LW02	

WWP	WOW
PO01	WNO
PO02	WSO
PO03	
PO07	
PO08	
PO09	
WBW	
WSW	
WEC	



MOC
MEC
MSW
MTW
MWL
MNA

WWP	WOW
PO01	WNO
PO02	WSO
PO03	
PO07	
PO08	
PO09	
WEC	
WBW	
WSW	



[Click here to view statement of line](#)

Product Features

- HNY7226WT162 Fixed Desk Height worksurfaces, 29" worksurface height
- 5" Solid wood feet - oval shape
- 4 Power outlets with 1 telecom plate, see options below for telecom plate
- Ships KD
- Wire management tray attaches to worksurface top, standard in MFW White, see premium Metal Finish for options
- Hardwire infeed and jumpers are included in workstations
- T75 worksurface wire cutout is standard on all worksurfaces.(T75D: Delete cutout is optional)

Options

Accessories

- K28: Articulating Keyboard w/ Mouse - \$390
- K31-SK: Center drawer w/ skirt - \$310
- K31: Center drawer w/o skirt - \$205

Concealed Floor Power Infeed Cover

- PCEB: White Metal Finish concealed floor power infeed cover - \$150

Delete Top and Wire Tray

- DFP: Delete fixed top. Deduct \$1535 Veneer (W), \$1335 High Pressure Laminate (G), \$953 Thermally Fused Laminate (M) per top

Metal Feet

- MTL10: Replace solid wood feet with metal feet, standard MFW White - \$55 ea

Premium Metal Finish

- Specify premium Metal Finish. MFMB: Matte Black, MFS: Silver, MFSS: Salmon Sienna, MFSA: Surfing Aquavert, MFPS: Pistachio, MFOS: Oyster, MFNA: Navy, MFOL: Olive, MFGB: Grey Beige MFGG: Graphite Gray, MFG: Gray, MFGM:Matte Gold
- Premium Metal Finish for WMT Wire Management Tray - \$75 ea
- Premium Metal Finish for MTL10 Metal Feet - \$20 ea
- Premium Metal Finish for PCEB Concealed Floor Power Infeed Cover - \$35

Starter Panel

- RSP: Substitute round starter panel in place of flat starter panel. Must substitute all starters, priced per starter panel - \$83 each. See HNY3555SP888

Telecom Plates

- Each power unit has 1 plate. All telecom connectors sold separately.
- RJ45 (1) - \$55, RJ45 (2) - \$110, RJ45 (3) - \$165, USB (1) - \$70, USB (2) - \$140, RJ45/USB - \$125, RJ45/HDMI - \$210, HDMI/USB - \$205

Worksurface Height

- THL-42: Modify worksurface height to bar height - N/C

Facing Diagonal Workstation Typical
Position 2 Desk with Height Adjustable Worksurface

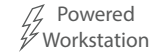
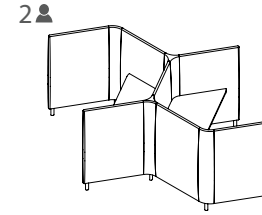
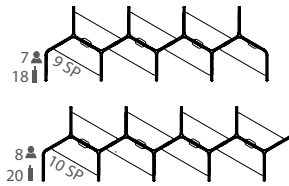
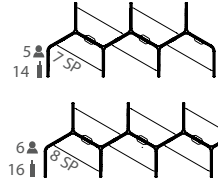
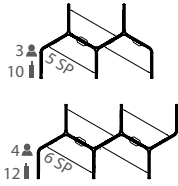

Number of Feet per Typical (MTL10 Option) "SP" Number of Starter Panels per Typical (RSP Option)

1 Select Model

w" x d" x h"	Weight	Standard Veneer Top Upholstered Panels - COM\$	Premium Veneer Top Upholstered Panels - COM\$
340 x 101 x 55	71	8 HNY340101HA574W 58570	"P" Option N/A
303 x 101 x 55	64	7 HNY303101HA574W 51918	"P" Option N/A
265 x 101 x 55	56	6 HNY265101HA574W 44995	"P" Option N/A
228 x 101 x 55	49	5 HNY228101HA574W 38343	"P" Option N/A
191 x 101 x 55	41	4 HNY191101HA574W 31420	"P" Option N/A
153 x 101 x 55	34	3 HNY153101HA574W 24768	"P" Option N/A
116 x 101 x 55	26	2 HNY116101HA574W 17845	"P" Option N/A

[Click Here for Graded in Pricing](#)

2 Select Finish

Click to view finishes

WWP	WOW
PO01	WNO
PO02	WSO
PO03	WNF(Natural Oak on Flat Cut)
PO07	WSF(Salted Oak on Flat Cut)
PO08	WSF(Salted Oak on Flat Cut)
PO09	WSF(Salted Oak on Flat Cut)
WBW	
WSW	
WEC	

3 Select Feet Finish

Click to view edges

WWP	WOW
PO01	WNO
PO02	WSO
PO03	
PO07	
PO08	
PO09	
WBW	
WSW	
WEC	

4 Select Edge

Click to view details



High Pressure Laminate Top Upholstered Panels - COM\$

HNY340101HA574G 56962	"P" Option N/A
HNY303101HA574G 50511	"P" Option N/A
HNY265101HA574G 43789	"P" Option N/A
HNY228101HA574G 37338	"P" Option N/A
HNY191101HA574G 30616	"P" Option N/A
HNY153101HA574G 24165	"P" Option N/A
HNY116101HA574G 17443	"P" Option N/A

GEC	LW04
GNA +5%	LW05
GWL	LW06
LP01	
LF02	
LF03	
LN01	
LA02	
LW01	
LW02	

WWP	WOW
PO01	WNO
PO02	WSO
PO03	
PO07	
PO08	
PO09	
WBW	
WSW	
WEC	



Thermally Fused Laminate Top Upholstered Panels - COM\$

HNY340101HA574M 53906	"P" Option N/A
HNY303101HA574M 47837	"P" Option N/A
HNY265101HA574M 41497	"P" Option N/A
HNY228101HA574M 35428	"P" Option N/A
HNY191101HA574M 29088	"P" Option N/A
HNY153101HA574M 23019	"P" Option N/A
HNY116101HA574M 16679	"P" Option N/A

MOC
MEC
MSW
MTW
MWL
MNA

WWP	WOW
PO01	WNO
PO02	WSO
PO03	
PO07	
PO08	
PO09	
WBW	
WSW	



[Click here to view statement of line](#)

Product Features

- 5" Solid wood feet - oval shape, ships KD
- 4 Power outlets with 1 telecom plate, see options below for telecom plate
- Adjustable height from 27" to 47.5" with a maximum weight capacity of 275 lbs. Lift standard in MFW White, optional MFB Black
- HNY7125WT163 Height Adjustable worksurfaces are included
- Wire management tray attaches to worksurface top, standard in MFW White, see premium Metal Finish for options
- T75 worksurface wire cutout is standard on all worksurfaces.(T75D: Delete cutout is optional)

Notes

- 1" Gap between worksurface and panels to drop wires below worksurface
- Metal parts include 5 year warranty
- Programmable height adjustable mechanism, motor includes 2 year warranty

Options

Accessories

- K28: Articulating Keyboard w/ Mouse - \$390
- K31-SK: Center drawer w/ skirt - \$310
- K31: Center drawer w/o skirt - \$205

Concealed Floor Power Infeed Cover

- PCEB: White Metal Finish concealed floor power infeed cover - \$150

Delete Top and Wire Tray

- DHAT: Delete height adjustable top. Deduct \$3845 Veneer(W), \$3644 High Pressure Laminate(G), \$3262 Thermally Fused Laminate(M) per top

Metal Feet

- MTL10: Replace solid wood feet with metal feet, standard MFW White - \$55 ea

Premium Metal Finish

- Specify premium Metal Finish. MFMB: Matte Black, MFS: Silver, MFSS: Salmon Sienna, MFSA: Surfin Aquavert, MFPS: Pistachio, MFOS: Oyster, MFNA: Navy, MFOL: Olive, MFGB: Grey Beige MFGG: Graphite Gray, MFG: Gray, MFGM:Matte Gold
- Premium Metal Finish for WMT Wire Management Tray - \$75 ea
- Premium Metal Finish for MTL10 Metal Feet - \$20 ea
- Premium Metal Finish for PCEB Concealed Floor Power Infeed Cover - \$35

Starter Panel

- RSP: Substitute round starter panel in place of flat starter panel. Must substitute all starters, priced per starter panel - \$83 each. See HNY3555SP888

Telecom Plates

- Each power unit has 1 plate. All telecom connectors sold separately.
- RJ45 (1) - \$55, RJ45 (2) - \$110, RJ45 (3) - \$165, USB (1) - \$70, USB (2) - \$140, RJ45/USB - \$125, RJ45/HDMI - \$210, HDMI/USB - \$205

Facing Diagonal Workstation Typical
Position 2 Desk with Fixed Worksurface

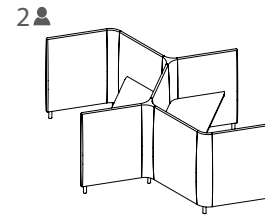
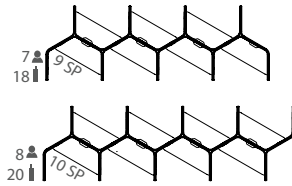
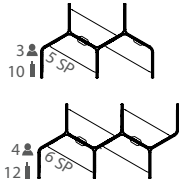

Number of Feet per Typical (MTL10 Option) "SP" Number of Starter Panels per Typical (RSP Option)

1 Select Model

w" x d" x h"	Weight	Standard Veneer Top Upholstered Panels - COM\$	Premium Veneer Top Upholstered Panels - COM\$
340 x 101 x 55	71	8 HNY340101FT574W 37836	"P" Option N/A
303 x 101 x 55	64	7 HNY303101FT574W 33616	"P" Option N/A
265 x 101 x 55	56	6 HNY265101FT574W 29396	"P" Option N/A
228 x 101 x 55	49	5 HNY228101FT574W 25176	"P" Option N/A
191 x 101 x 55	41	4 HNY191101FT574W 20956	"P" Option N/A
153 x 101 x 55	34	3 HNY153101FT574W 16736	"P" Option N/A
116 x 101 x 55	26	2 HNY116101FT574W 12516	"P" Option N/A

[Click Here for Graded in Pricing](#)

2 Select Finish

Click to view finishes

WWP	WOW
PO01	WNO
PO02	WSO
PO03	WNF(Natural Oak on Flat Cut)
PO08	WSF(Salted Oak on Flat Cut)
PO09	
WBW	
WSW	
WEC	

3 Select Feet Finish

Click to view edges

WWP	WOW
PO01	WNO
PO02	WSO
PO03	
PO07	
PO08	
PO09	
WBW	
WSW	
WEC	

4 Select Edge

Click to view details



High Pressure Laminate Top Upholstered Panels - COM\$

HNY340101FT574G 36236	"P" Option N/A
HNY303101FT574G 32216	"P" Option N/A
HNY265101FT574G 28196	"P" Option N/A
HNY228101FT574G 24176	"P" Option N/A
HNY191101FT574G 20156	"P" Option N/A
HNY153101FT574G 16136	"P" Option N/A
HNY116101FT574G 12116	"P" Option N/A

GEC	LW04
GNA +5%	LW05
GWL	LW06
LP01	
LF02	
LF03	
LN01	
LA02	
LW01	
LW02	

WWP	WOW
PO01	WNO
PO02	WSO
PO03	
PO07	
PO08	
PO09	
WBW	
WSW	
WEC	

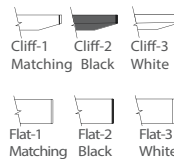

Thermally Fused Laminate Top Upholstered Panels - COM\$

HNY340101FT574M 33180	"P" Option N/A
HNY303101FT574M 29542	"P" Option N/A
HNY265101FT574M 25904	"P" Option N/A
HNY228101FT574M 22266	"P" Option N/A
HNY191101FT574M 18628	"P" Option N/A
HNY153101FT574M 14990	"P" Option N/A
HNY116101FT574M 11352	"P" Option N/A

MOC
MEC
MSW
MTW
MWL
MNA

WWP	WOW
PO01	WNO
PO02	WSO
PO03	
PO07	
PO08	
PO09	
WBW	
WSW	



[Click here to view statement of line](#)

Product Features

- 5" Solid wood feet - oval shape
- HNY7226WT162 Fixed Desk Height worksurfaces, 29" worksurface height
- Ships KD
- T75 worksurface wire cutout is standard on all worksurfaces.(T75D: Delete cutout is optional)

Options

Accessories

- K28: Articulating Keyboard w/ Mouse - \$390
- K31-SK: Center drawer w/ skirt - \$310
- K31: Center drawer w/o skirt - \$205

Concealed Floor Power Infeed Cover

- PCEB: White Metal Finish concealed floor power infeed cover - \$150

Delete Top

- DFT: Delete fixed top. Deduct \$1325 Veneer(W), \$1125 High Pressure Laminate (G), \$743 Thermally Fused Laminate (M) per top

Metal Feet

- MTL10: Replace solid wood feet with metal feet, standard MFW White - \$55 ea

Premium Metal Finish

- Specify premium Metal Finish. MFMB: Matte Black, MFS: Silver, MFSS: Salmon Sienna, MFSA: Surfing Aquavert, MFPS: Pistachio, MFOS: Oyster, MFNA: Navy, MFOL: Olive, MFGB: Grey Beige MFGG: Graphite Gray, MFG: Gray, MFGM:Matte Gold
- Premium Metal Finish for WMT Wire Management Tray - \$75 ea
- Premium Metal Finish for MTL10 Metal Feet - \$20 ea
- Premium Metal Finish for PCEB Concealed Floor Power Infeed Cover - \$35

Starter Panel

- RSP: Substitute round starter panel in place of flat starter panel. Must substitute all starters, priced per starter panel - \$83 each. See HNY3555SP888

Worksurface Height

- Modify worksurface height to bar height.
- THL-42: Position worksurface at bar height - N/C

Wire Tray

- WMT: Wire metal tray. Mounts under top and comes standard in MFW White - \$210

Facing Diagonal Workstation Typical
Position 2 Desk with Power Fixed Worksurface

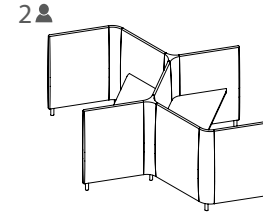
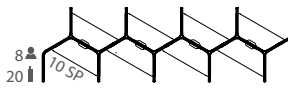
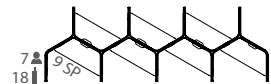
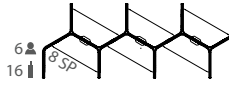
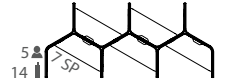
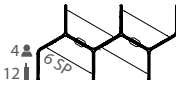
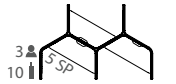

Number of Feet per Typical (MTL10 Option) "SP" Number of Starter Panels per Typical (RSP Option)

1 Select Model

w" x d" x h"	Weight	Standard Veneer Top Upholstered Panels - COM\$	Premium Veneer Top Upholstered Panels - COM\$
340 x 101 x 55	71	8 HNY340101FP574W 40242	"P" Option N/A
303 x 101 x 55	64	7 HNY303101FP574W 35881	"P" Option N/A
265 x 101 x 55	56	6 HNY265101FP574W 31249	"P" Option N/A
228 x 101 x 55	49	5 HNY228101FP574W 26888	"P" Option N/A
191 x 101 x 55	41	4 HNY191101FP574W 22256	"P" Option N/A
153 x 101 x 55	34	3 HNY153101FP574W 17895	"P" Option N/A
116 x 101 x 55	26	2 HNY116101FP574W 13263	"P" Option N/A

[Click Here for Graded in Pricing](#)

2 Select Finish

Click to view finishes

WWP	WOW
PO01	WNO
PO02	WSO
PO03	WNF(Natural Oak on Flat Cut)
PO07	WSF(Salted Oak on Flat Cut)
PO08	WSF(Salted Oak on Flat Cut)
PO09	WSF(Salted Oak on Flat Cut)
WBW	
WSW	
WEC	

3 Select Feet Finish

Click to view edges

WWP	WOW
PO01	WNO
PO02	WSO
PO03	
PO07	
PO08	
PO09	
WBW	
WSW	
WEC	

4 Select Edge

Click to view details

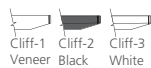

High Pressure Laminate Top Upholstered Panels - COM\$

HNY340101FP574G	38642
HNY303101FP574G	34481
HNY265101FP574G	30049
HNY228101FP574G	25888
HNY191101FP574G	21456
HNY153101FP574G	17295
HNY116101FP574G	12863

GEC	LW04
GNA +5%	LW05
GWL	LW06
LP01	
LF02	
LF03	
LN01	
LA02	
LW01	
LW02	

WWP	WOW
PO01	WNO
PO02	WSO
PO03	
PO07	
PO08	
PO09	
WBW	
WSW	
WEC	



Thermally Fused Laminate Top Upholstered Panels - COM\$

HNY340101FP574M	35586
HNY303101FP574M	31807
HNY265101FP574M	27757
HNY228101FP574M	23978
HNY191101FP574M	19928
HNY153101FP574M	16149
HNY116101FP574M	12099

MOC
MEC
MSW
MTW
MWL
MNA

WWP	WOW
PO01	WNO
PO02	WSO
PO03	
PO07	
PO08	
PO09	
WEC	
WBW	
WSW	



[Click here to view statement of line](#)

Product Features

- HNY7226WT162 Fixed Desk Height worksurfaces, 29" worksurface height
- 5" Solid wood feet - oval shape
- 4 Power outlets with 1 telecom plate, see options below for telecom plate
- Ships KD
- Wire management tray attaches to worksurface top, standard in MFW White, see premium Metal Finish for options
- Hardwire infeed and jumpers are included in workstations
- T75 worksurface wire cutout is standard on all worksurfaces.(T75D: Delete cutout is optional)

Options

Accessories

- K28: Articulating Keyboard w/ Mouse - \$390
- K31-SK: Center drawer w/ skirt - \$310
- K31: Center drawer w/o skirt - \$205

Concealed Floor Power Infeed Cover

- PCEB: White Metal Finish concealed floor power infeed cover - \$150

Delete Top and Wire Tray

- DFP: Delete fixed top. Deduct \$1535 Veneer (W), \$1335 High Pressure Laminate (G), \$953 Thermally Fused Laminate (M) per top

Metal Feet

- MTL10: Replace solid wood feet with metal feet, standard MFW White - \$55 ea

Premium Metal Finish

- Specify premium Metal Finish. MFMB: Matte Black, MFS: Silver, MFSS: Salmon Sienna, MFSA: Surfing Aquavert, MFPS: Pistachio, MFOS: Oyster, MFNA: Navy, MFOL: Olive, MFGB: Grey Beige MFGG: Graphite Gray, MFG: Gray, MFGM:Matte Gold
- Premium Metal Finish for WMT Wire Management Tray - \$75 ea
- Premium Metal Finish for MTL10 Metal Feet - \$20 ea
- Premium Metal Finish for PCEB Concealed Floor Power Infeed Cover - \$35

Starter Panel

- RSP: Substitute round starter panel in place of flat starter panel. Must substitute all starters, priced per starter panel - \$83 each. See HNY3555SP888

Telecom Plates

- Each power unit has 1 plate. All telecom connectors sold separately.
- RJ45 (1) - \$55, RJ45 (2) - \$110, RJ45 (3) - \$165, USB (1) - \$70, USB (2) - \$140, RJ45/USB - \$125, RJ45/HDMI - \$210, HDMI/USB - \$205

Worksurface Height

- THL-42: Modify worksurface height to bar height - N/C

4
8

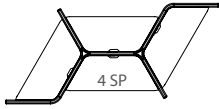

8
14

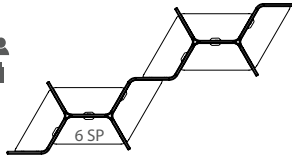

4
8

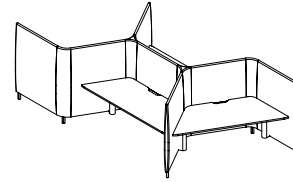

Height Adjustable Workstation



Number of Feet per Typical (MTL10 Option) "SP" Number of Starter Panels per Typical (RSP Option)

1 Select Model

w" x d" x h"	Weight	Standard Veneer Top Upholstered Panels - COM\$
295 x 153 x 55	49	8 HNY295153HA575W 51214
166 x 78 x 55	26	4 HNY16678HA575W 26101

Premium Veneer Top Upholstered Panels - COM\$

"P" Option N/A
"P" Option N/A

High Pressure Laminate Top Upholstered Panels - COM\$

HNY295153HA575G 49606
HNY16678HA575G 25297

Thermally Fused Laminate Top Upholstered Panels - COM\$

HNY295153HA575M 46550
HNY16678HA575M 23769

[Click here to view statement of line](#)

Product Features

- 5" Solid wood feet - oval shape, ships KD
- 4 Power outlets with 1 telecom plate, see options below for telecom plate
- Adjustable height from 27" to 47.5" with a maximum weight capacity of 275 lbs.
- Lift standard in MFW White, optional MFB Black
- HNY7125WT163 Height Adjustable worksurfaces are included
- Wire management tray attaches to worksurface top, standard in MFW White, see premium Metal Finish for options
- T75 worksurface wire cutout is standard on all worksurfaces.(T75D: Delete cutout is optional)

Notes

- 1" Gap between worksurface and panels to drop wires below worksurface
- Metal parts include 5 year warranty
- Programmable height adjustable mechanism, motor includes 2 year warranty

Options

Accessories

- K28: Articulating Keyboard w/ Mouse - \$390
- K31-SK: Center drawer w/ skirt - \$310
- K31: Center drawer w/o skirt - \$205

Concealed Floor Power Infeed Cover

- PCEB: White Metal Finish concealed floor power infeed cover - \$150

Delete Top and Wire Tray

- DHAT: Delete height adjustable top. Deduct \$3845 Veneer(W), \$3644 High Pressure Laminate(G), \$3262 Thermally Fused Laminate(M) per top

Metal Feet

- MTL10: Replace solid wood feet with metal feet, standard MFW White - \$55 ea

Premium Metal Finish

- Specify premium Metal Finish. MFMB: Matte Black, MFS: Silver, MFSS: Salmon Sienna, MFSA: Surfing Aquavert, MFPS: Pistachio, MFOS: Oyster, MFNA: Navy, MFOL: Olive, MFGB: Grey Beige MFGG: Graphite Gray, MFG: Gray, MFGM:Matte Gold
- Premium Metal Finish for WMT Wire Management Tray - \$75 ea
- Premium Metal Finish for MTL10 Metal Feet - \$20 ea
- Premium Metal Finish for PCEB Concealed Floor Power Infeed Cover - \$35

Starter Panel

- RSP: Substitute round starter panel in place of flat starter panel. Must substitute all starters, priced per starter panel - \$83 each. See HNY3555SP888

Telecom Plates

- Each power unit has 1 plate. All telecom connectors sold separately.
- RJ45 (1) - \$55, RJ45 (2) - \$110, RJ45 (3) - \$165, USB (1) - \$70, USB (2) - \$140, RJ45/USB - \$125, RJ45/HDMI - \$210, HDMI/USB - \$205

[Click Here for Graded in Pricing](#)

2 Select Finish

Click to view finishes

WWP	WOW
PO01	WNO
PO02	WSO
PO03	WNF(Natural Oak on Flat Cut)
PO07	WSF(Salted Oak on Flat Cut)
PO08	WSF(Salted Oak on Flat Cut)
PO09	WSF(Salted Oak on Flat Cut)
WBW	
WSW	
WEC	

3 Select Feet Finish

Click to view edges

WWP	WOW
PO01	WNO
PO02	WSO
PO03	
PO07	
PO08	
PO09	
WBW	
WSW	
WEC	

4 Select Edge

Click to view details

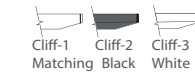

4
8

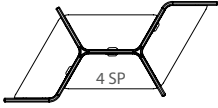

8
14

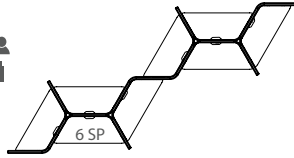

4
8

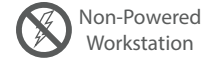
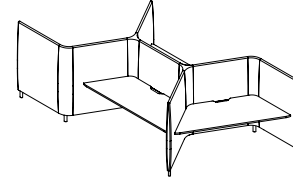

Number of Feet per Typical (MTL10 Option) "SP" Number of Starter Panels per Typical (RSP Option)

1 Select Model

Weight	Standard Veneer Top Upholstered Panels - COM\$
w" x d" x h"	
295 x 153 x 55	49 8 HNY295153FT575W 30336
166 x 78 x 55	26 4 HNY16678FT575W 15624

Premium Veneer Top Upholstered Panels - COM\$

"P" Option N/A
"P" Option N/A

High Pressure Laminate Top Upholstered Panels - COM\$

HNY295153FT575G 28736
HNY16678FT575G 14824

Thermally Fused Laminate Top Upholstered Panels - COM\$

HNY295153FT575M 25680
HNY16678FT575M 13296

Product Features

- 5" Solid wood feet - oval shape
- HNY7226WT162 Fixed Desk Height worksurfaces, 29" worksurface height
- Ships KD
- T75 worksurface wire cutout is standard on all worksurfaces.(T75D: Delete cutout is optional)

Options

Accessories

- K28: Articulating Keyboard w/ Mouse - \$390
- K31-SK: Center drawer w/ skirt - \$310
- K31: Center drawer w/o skirt - \$205

Concealed Floor Power Infeed Cover

- PCEB: White Metal Finish concealed floor power infeed cover - \$150

Delete Top

- DFT: Delete fixed top. Deduct \$1325 Veneer(W), \$1125 High Pressure Laminate (G), \$743 Thermally Fused Laminate (M) per top

Metal Feet

- MTL10: Replace solid wood feet with metal feet, standard MFW White - \$55 ea

Premium Metal Finish

- Specify premium Metal Finish. MFMB: Matte Black, MFS: Silver, MFSS: Salmon Sienna, MFSA: Surfing Aquavert, MFPS: Pistachio, MFOS: Oyster, MFNA: Navy, MFOL: Olive, MFGB: Grey Beige MFGG: Graphite Gray, MFG: Gray, MFGM:Matte Gold
- Premium Metal Finish for WMT Wire Management Tray - \$75 ea
- Premium Metal Finish for MTL10 Metal Feet - \$20 ea
- Premium Metal Finish for PCEB Concealed Floor Power Infeed Cover - \$35

Starter Panel

- RSP: Substitute round starter panel in place of flat starter panel. Must substitute all starters, priced per starter panel - \$83 each. See HNY3555SP888

Worksurface Height

- Modify worksurface height to bar height.
- THL-42: Position worksurface at bar height - N/C

Wire Tray

- WMT: Wire metal tray. Mounts under top and comes standard in MFW White - \$210

[Click Here for Graded in Pricing](#)

2 Select Finish

Click to view finishes

WWP	WOW
PO01	WNO
PO02	WSO
PO03	WNF(Natural Oak on Flat Cut)
PO07	WSF(Salted Oak on Flat Cut)
PO08	
PO09	
WBW	
WSW	
WEC	

3 Select Feet Finish

Click to view edges

WWP	WOW
PO01	WNO
PO02	WSO
PO03	
PO07	
PO08	
PO09	
WBW	
WSW	
WEC	

4 Select Edge

Click to view details

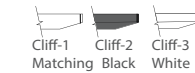
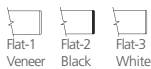

4
8



8
14

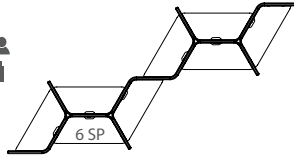

4
8

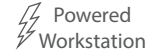
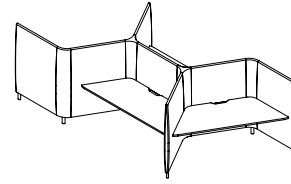

Number of Feet per Typical (MTL10 Option) "SP" Number of Starter Panels per Typical (RSP Option)

1 Select Model

Weight
w" x d" x h"

Standard Veneer Top Upholstered Panels - COM\$
8 HNY295153FP575W 32886
4 HNY16678FP575W 16937

Premium Veneer Top Upholstered Panels - COM\$
"P" Option N/A
"P" Option N/A

High Pressure Laminate Top Upholstered Panels - COM\$
HNY295153FP575G 31286
HNY16678FP575G 16137

Thermally Fused Laminate Top Upholstered Panels - COM\$
HNY295153FP575M 28230
HNY16678FP575M 14609

Product Features

- HNY7226WT162 Fixed Desk Height worksurfaces, 29" worksurface height
- 5" Solid wood feet - oval shape
- 4 Power outlets with 1 telecom plate, see options below for telecom plate
- Ships KD
- Wire management tray attaches to worksurface top, standard in MFW White, see premium Metal Finish for options
- Hardwire infeed and jumpers are included in workstations
- T75 worksurface wire cutout is standard on all worksurfaces.(T75D: Delete cutout is optional)

Options

Accessories

- K28: Articulating Keyboard w/ Mouse - \$390
- K31-SK: Center drawer w/ skirt - \$310
- K31: Center drawer w/o skirt - \$205

Concealed Floor Power Infeed Cover

- PCEB: White Metal Finish concealed floor power infeed cover - \$150

Delete Top and Wire Tray

- DFP: Delete fixed top. Deduct \$1535 Veneer (W), \$1335 High Pressure Laminate (G), \$953 Thermally Fused Laminate (M) per top

Metal Feet

- MTL10: Replace solid wood feet with metal feet, standard MFW White - \$55 ea

Premium Metal Finish

- Specify premium Metal Finish. MFMB: Matte Black, MFS: Silver, MFSS: Salmon Sienna, MFSA: Surfin Aquavert, MFPS: Pistachio, MFOS: Oyster, MFNA: Navy, MFOL: Olive, MFGB: Grey Beige MFGG: Graphite Gray, MFG: Gray, MFGM:Matte Gold
- Premium Metal Finish for WMT Wire Management Tray - \$75 ea
- Premium Metal Finish for MTL10 Metal Feet - \$20 ea
- Premium Metal Finish for PCEB Concealed Floor Power Infeed Cover - \$35

Starter Panel

- RSP: Substitute round starter panel in place of flat starter panel. Must substitute all starters, priced per starter panel - \$83 each. See HNY3555SP888

Telecom Plates

- Each power unit has 1 plate. All telecom connectors sold separately.
- RJ45 (1) - \$55, RJ45 (2) - \$110, RJ45 (3) - \$165, USB (1) - \$70, USB (2) - \$140, RJ45/USB - \$125, RJ45/HDMI - \$210, HDMI/USB - \$205

Worksurface Height

- THL-42: Modify worksurface height to bar height - N/C

[Click Here for Graded in Pricing](#)

2 Select Finish

Click to view finishes

WWP	WOW
PO01	WNO
PO02	WSO
PO03	WNF(Natural Oak on Flat Cut)
PO07	WSF(Salted Oak on Flat Cut)
PO08	
PO09	
WBW	
WSW	
WEC	

3 Select Feet Finish

Click to view edges

WWP	WOW
PO01	WNO
PO02	WSO
PO03	
PO07	
PO08	
PO09	
WBW	
WSW	
WEC	

4 Select Edge

Click to view details

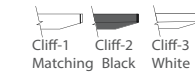

DARRAN

Honey

Inline Hexagon Workstation Typical Position 1 Desk with Height Adjustable Worksurface

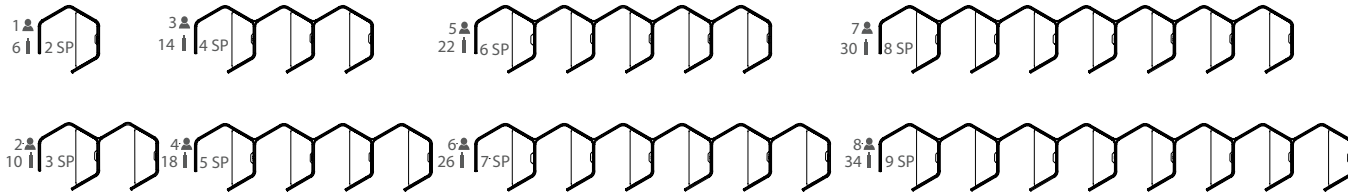

Number of Feet per Typical (MTL10 Option) "SP" Number of Starter Panels per Typical (RSP Option)

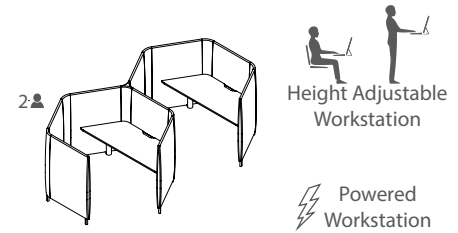

1 Select Model

w" x d" x h"	Weight	Standard Veneer Top Upholstered Panels - COM\$	Premium Veneer Top Upholstered Panels - COM\$	High Pressure Laminate Top Upholstered Panels - COM\$	Thermally Fused Laminate Top Upholstered Panels - COM\$
602 x 86 x 55	128	8 HNY60286HA576W 83710	"P" Option N/A	HNY60286HA576G 82102	HNY60286HA576M 79046
528 x 86 x 55	112	7 HNY52886HA576W 73430	"P" Option N/A	HNY52886HA576G 72023	HNY52886HA576M 69349
453 x 86 x 55	97	6 HNY45386HA576W 63150	"P" Option N/A	HNY45386HA576G 61944	HNY45386HA576M 59652
378 x 86 x 55	81	5 HNY37886HA576W 52870	"P" Option N/A	HNY37886HA576G 51865	HNY37886HA576M 49955
303 x 86 x 55	66	4 HNY30386HA576W 42590	"P" Option N/A	HNY30386HA576G 41786	HNY30386HA576M 40258
228 x 86 x 55	50	3 HNY22886HA576W 32310	"P" Option N/A	HNY22886HA576G 31707	HNY22886HA576M 30561
153 x 86 x 55	35	2 HNY15386HA576W 22030	"P" Option N/A	HNY15386HA576G 21628	HNY15386HA576M 20864
78 x 86 x 55	19	1 HNY7886HA576W 11750	"P" Option N/A	HNY7886HA576G 11549	HNY7886HA576M 11167

[Click Here for Graded in Pricing](#)

2 Select Finish

Click to view finishes

WWP	WOW
PO01	WNO
PO02	WSO
PO03	WNF(Natural Oak on Flat Cut)
PO07	WSF(Salted Oak on Flat Cut)
PO08	WSF(Salted Oak on Flat Cut)
PO09	WSF(Salted Oak on Flat Cut)
WBW	
WSW	
WEC	

3 Select Feet Finish

Click to view edges

WWP	WOW
PO01	WNO
PO02	WSO
PO03	
PO07	
PO08	
PO09	
WBW	
WSW	
WEC	

4 Select Edge

Click to view details

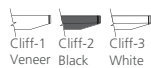

GEC	LW04
GNA +5%	LW05
GWL	LW06
LP01	
LF02	
LF03	
LN01	
LA02	
LW01	
LW02	

WWP	WOW
PO01	WNO
PO02	WSO
PO03	
PO07	
PO08	
PO09	
WBW	
WSW	
WEC	



MOC
MEC
MSW
MTW
MWL
MNA

WWP	WOW
PO01	WNO
PO02	WSO
PO03	
PO07	
PO08	
PO09	
WBW	
WSW	



[Click here to view statement of line](#)

Product Features

- 5" Solid wood feet - oval shape, ships KD
- 4 Power outlets with 1 telecom plate, see options below for telecom plate
- Adjustable height from 27" to 47.5" with a maximum weight capacity of 275 lbs.
- Lift standard in MFW White, optional MFB Black
- HNY7125WT163 Height Adjustable worksurfaces are included
- Wire management tray attaches to worksurface top, standard in MFW White, see premium Metal Finish for options
- T75 worksurface wire cutout is standard on all worksurfaces.(T75D: Delete cutout is optional)

Notes

- 1" Gap between worksurface and panels to drop wires below worksurface
- Metal parts include 5 year warranty
- Programmable height adjustable mechanism, motor includes 2 year warranty

Options

Accessories

- K28: Articulating Keyboard w/ Mouse - \$390
- K31-SK: Center drawer w/ skirt - \$310
- K31: Center drawer w/o skirt - \$205

Concealed Floor Power Infeed Cover

- PCEB: White Metal Finish concealed floor power infeed cover - \$150

Delete Top and Wire Tray

- DHAT: Delete height adjustable top. Deduct \$3845 Veneer(W), \$3644 High Pressure Laminate(G), \$3262 Thermally Fused Laminate(M) per top

Metal Feet

- MTL10: Replace solid wood feet with metal feet, standard MFW White - \$55 ea

Premium Metal Finish

- Specify premium Metal Finish. MFMB: Matte Black, MFS: Silver, MFSS: Salmon Sienna, MFSA: Surfin Aquavert, MFPS: Pistachio, MFOS: Oyster, MFNA: Navy, MFOL: Olive, MFGB: Grey Beige MFGG: Graphite Gray, MFG: Gray, MFGM:Matte Gold
- Premium Metal Finish for WMT Wire Management Tray - \$75 ea
- Premium Metal Finish for MTL10 Metal Feet - \$20 ea
- Premium Metal Finish for PCEB Concealed Floor Power Infeed Cover - \$35

Starter Panel

- RSP: Substitute round starter panel in place of flat starter panel. Must substitute all starters, priced per starter panel - \$83 each. See HNY3555SP888

Telecom Plates

- Each power unit has 1 plate. All telecom connectors sold separately.
- RJ45 (1) - \$55, RJ45 (2) - \$110, RJ45 (3) - \$165, USB (1) - \$70, USB (2) - \$140, RJ45/USB - \$125, RJ45/HDMI - \$210, HDMI/USB - \$205

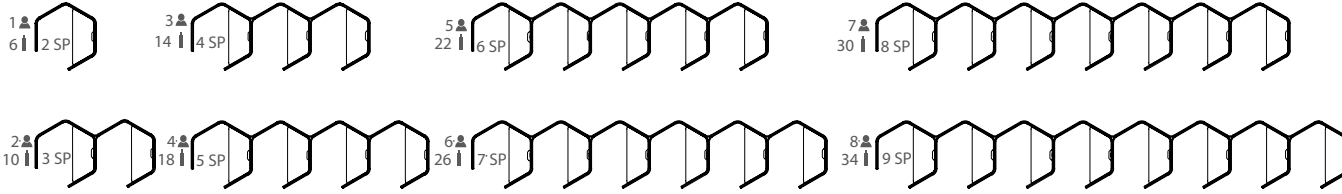

Number of Feet per Typical (MTL10 Option) "SP" Number of Starter Panels per Typical (RSP Option)

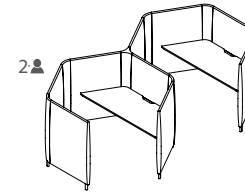

1 Select Model

w" x d" x h"	Weight	Standard Veneer Top Upholstered Panels - COM\$	Premium Veneer Top Upholstered Panels - COM\$
602 x 86 x 55	128	8 HNY60286FT576W 60482	"P" Option N/A
528 x 86 x 55	112	7 HNY52886FT576W 53098	"P" Option N/A
453 x 86 x 55	97	6 HNY45386FT576W 45714	"P" Option N/A
378 x 86 x 55	81	5 HNY37886FT576W 38330	"P" Option N/A
303 x 86 x 55	66	4 HNY30386FT576W 30946	"P" Option N/A
228 x 86 x 55	50	3 HNY22886FT576W 23562	"P" Option N/A
153 x 86 x 55	35	2 HNY15386FT576W 16178	"P" Option N/A
78 x 86 x 55	19	1 HNY7886FT576W 8794	"P" Option N/A

[Click Here for Graded in Pricing](#)

2 Select Finish

Click to view finishes

WWP	WOW
PO01	WNO
PO02	WSO
PO03	WNF(Natural Oak on Flat Cut)
PO07	WSF(Salted Oak on Flat Cut)
PO08	WSF(Salted Oak on Flat Cut)
PO09	WSF(Salted Oak on Flat Cut)
WBW	
WSW	
WEC	

3 Select Feet Finish

Click to view edges

WWP	WOW
PO01	WNO
PO02	WSO
PO03	
PO07	
PO08	
PO09	
WBW	
WSW	
WEC	

4 Select Edge

Click to view details

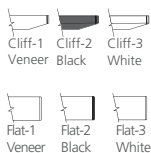

High Pressure Laminate Top Upholstered Panels - COM\$

HNY60286FT576G 58882	"P" Option N/A
HNY52886FT576G 51698	"P" Option N/A
HNY45386FT576G 44514	"P" Option N/A
HNY37886FT576G 37330	"P" Option N/A
HNY30386FT576G 30146	"P" Option N/A
HNY22886FT576G 22962	"P" Option N/A
HNY15386FT576G 15778	"P" Option N/A
HNY7886FT576G 8594	"P" Option N/A

GEC	LW04
GNA +5%	LW05
GWL	LW06
LP01	
LF02	
LF03	
LN01	
LA02	
LW01	
LW02	

WWP	WOW
PO01	WNO
PO02	WSO
PO03	
PO07	
PO08	
PO09	
WBW	
WSW	
WEC	

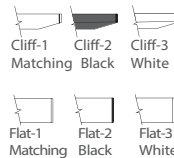

Thermally Fused Laminate Top Upholstered Panels - COM\$

HNY60286FT576M 55826	"P" Option N/A
HNY52886FT576M 49024	"P" Option N/A
HNY45386FT576M 42222	"P" Option N/A
HNY37886FT576M 35420	"P" Option N/A
HNY30386FT576M 28618	"P" Option N/A
HNY22886FT576M 21816	"P" Option N/A
HNY15386FT576M 15014	"P" Option N/A
HNY7886FT576M 8212	"P" Option N/A

MOC
MEC
MSW
MTW
MWL
MNA

WWP	WOW
PO01	WNO
PO02	WSO
PO03	
PO07	
PO08	
PO09	
WBW	
WSW	



[Click here to view statement of line](#)

Product Features

- 5" Solid wood feet - oval shape
- HNY7226WT162 Fixed Desk Height worksurfaces, 29" worksurface height
- Ships KD
- T75 worksurface wire cutout is standard on all worksurfaces.(T75D: Delete cutout is optional)

Options

Accessories

- K28: Articulating Keyboard w/ Mouse - \$390
- K31-SK: Center drawer w/ skirt - \$310
- K31: Center drawer w/o skirt - \$205

Concealed Floor Power Infeed Cover

- PCEB: White Metal Finish concealed floor power infeed cover - \$150

Delete Top

- DFT: Delete fixed top. Deduct \$1325 Veneer(W), \$1125 High Pressure Laminate (G), \$743 Thermally Fused Laminate (M) per top

Metal Feet

- MTL10: Replace solid wood feet with metal feet, standard MFW White - \$55 ea

Premium Metal Finish

- Specify premium Metal Finish. MFMB: Matte Black, MFS: Silver, MFSS: Salmon Sienna, MFSA: Surfing Aquavert, MFPS: Pistachio, MFOS: Oyster, MFNA: Navy, MFOL: Olive, MFGB: Grey Beige MFGG: Graphite Gray, MFG: Gray, MFGM:Matte Gold
- Premium Metal Finish for WMT Wire Management Tray - \$75 ea
- Premium Metal Finish for MTL10 Metal Feet - \$20 ea
- Premium Metal Finish for PCEB Concealed Floor Power Infeed Cover - \$35

Starter Panel

- RSP: Substitute round starter panel in place of flat starter panel. Must substitute all starters, priced per starter panel - \$83 each. See HNY3555SP888

Worksurface Height

- Modify worksurface height to bar height.
- THL-42: Position worksurface at bar height - N/C

Wire Tray

- WMT: Wire metal tray. Mounts under top and comes standard in MFW White - \$210

DARRAN

Honey

Inline Hexagon Workstation Typical Position 1 Desk with Power Fixed Worksurface

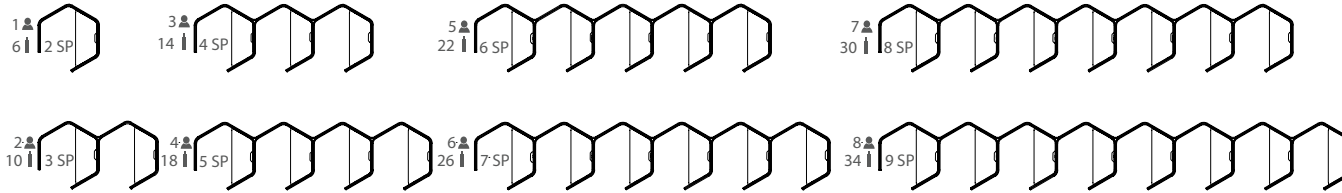

Number of Feet per Typical (MTL10 Option) "SP" Number of Starter Panels per Typical (RSP Option)

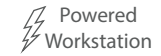
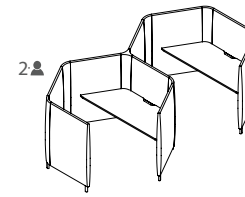

1 Select Model

w" x d" x h"	Weight	Standard Veneer Top Upholstered Panels - COM\$	Premium Veneer Top Upholstered Panels - COM\$	High Pressure Laminate Top Upholstered Panels - COM\$	Thermally Fused Laminate Top Upholstered Panels - COM\$
602 x 86 x 55	128	8 HNY60286FP576W 65382	"P" Option N/A	HNY60286FP576G 63782	HNY60286FP576M 60726
528 x 86 x 55	112	7 HNY52886FP576W 57393	"P" Option N/A	HNY52886FP576G 55993	HNY52886FP576M 53319
453 x 86 x 55	97	6 HNY45386FP576W 49404	"P" Option N/A	HNY45386FP576G 48204	HNY45386FP576M 45912
378 x 86 x 55	81	5 HNY37886FP576W 41415	"P" Option N/A	HNY37886FP576G 40415	HNY37886FP576M 38505
303 x 86 x 55	66	4 HNY30386FP576W 33426	"P" Option N/A	HNY30386FP576G 32626	HNY30386FP576M 31098
228 x 86 x 55	50	3 HNY22886FP576W 25437	"P" Option N/A	HNY22886FP576G 24837	HNY22886FP576M 23691
153 x 86 x 55	35	2 HNY15386FP576W 17448	"P" Option N/A	HNY15386FP576G 17048	HNY15386FP576M 16284
78 x 86 x 55	19	1 HNY7886FP576W 9459	"P" Option N/A	HNY7886FP576G 9259	HNY7886FP576M 8877

[Click Here for Graded in Pricing](#)

2 Select Finish

Click to view finishes

WWP	WOW
PO01	WNO
PO02	WSO
PO03	WNF(Natural Oak on Flat Cut)
PO07	WSF(Salted Oak on Flat Cut)
PO08	WSF(Salted Oak on Flat Cut)
PO09	WSF(Salted Oak on Flat Cut)
WBW	
WSW	
WEC	

3 Select Feet Finish

Click to view edges

WWP	WOW
PO01	WNO
PO02	WSO
PO03	
PO07	
PO08	
PO09	
WBW	
WSW	
WEC	

4 Select Edge

Click to view details

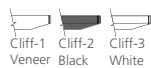

GEC	LW04
GNA +5%	LW05
GWL	LW06
LP01	
LF02	
LF03	
LN01	
LA02	
LW01	
LW02	

WWP	WOW
PO01	WNO
PO02	WSO
PO03	
PO07	
PO08	
PO09	
WBW	
WSW	
WEC	



MOC
MEC
MSW
MTW
MWL
MNA

WWP	WOW
PO01	WNO
PO02	WSO
PO03	
PO07	
PO08	
PO09	
WEC	
WBW	
WSW	



[Click here to view statement of line](#)

Product Features

- HNY7226WT162 Fixed Desk Height worksurfaces, 29" worksurface height
- 5" Solid wood feet - oval shape
- 4 Power outlets with 1 telecom plate, see options below for telecom plate
- Ships KD
- Wire management tray attaches to worksurface top, standard in MFW White, see premium Metal Finish for options
- Hardwire infeed and jumpers are included in workstations
- T75 worksurface wire cutout is standard on all worksurfaces.(T75D: Delete cutout is optional)

Options

Accessories

- K28: Articulating Keyboard w/ Mouse - \$390
- K31-SK: Center drawer w/ skirt - \$310
- K31: Center drawer w/o skirt - \$205

Concealed Floor Power Infeed Cover

- PCEB: White Metal Finish concealed floor power infeed cover - \$150

Delete Top and Wire Tray

- DFP: Delete fixed top. Deduct \$1535 Veneer (W), \$1335 High Pressure Laminate (G), \$953 Thermally Fused Laminate (M) per top

Metal Feet

- MTL10: Replace solid wood feet with metal feet, standard MFW White - \$55 ea

Premium Metal Finish

- Specify premium Metal Finish. MFMB: Matte Black, MFS: Silver, MFSS: Salmon Sienna, MFSA: Surfing Aquavert, MFPS: Pistachio, MFOS: Oyster, MFNA: Navy, MFOL: Olive, MFGB: Grey Beige MFGG: Graphite Gray, MFG: Gray, MFGM:Matte Gold
- Premium Metal Finish for WMT Wire Management Tray - \$75 ea
- Premium Metal Finish for MTL10 Metal Feet - \$20 ea
- Premium Metal Finish for PCEB Concealed Floor Power Infeed Cover - \$35

Starter Panel

- RSP: Substitute round starter panel in place of flat starter panel. Must substitute all starters, priced per starter panel - \$83 each. See HNY3555SP888

Telecom Plates

- Each power unit has 1 plate. All telecom connectors sold separately.
- RJ45 (1) - \$55, RJ45 (2) - \$110, RJ45 (3) - \$165, USB (1) - \$70, USB (2) - \$140, RJ45/USB - \$125, RJ45/HDMI - \$210, HDMI/USB - \$205

Worksurface Height

- THL-42: Modify worksurface height to bar height - N/C

DARRAN

Honey

Inline Hexagon Workstation Typical
Position 2 Desk with Height Adjustable Worksurface

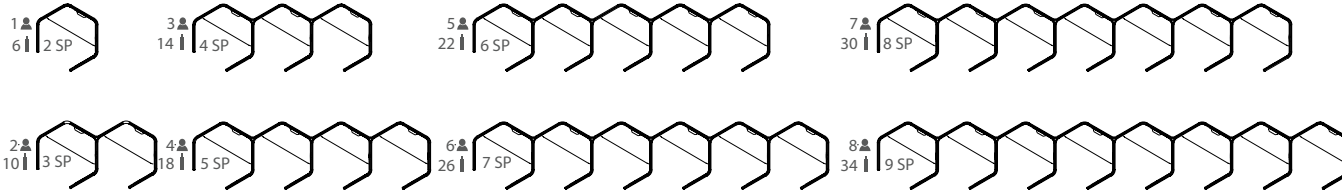

Number of Feet per Typical (MTL10 Option) "SP" Number of Starter Panels per Typical (RSP Option)

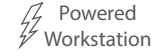
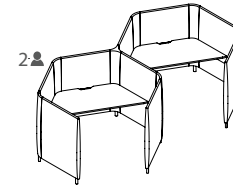

1 Select Model

w" x d" x h"	Weight	Standard Veneer Top Upholstered Panels - COM\$	Premium Veneer Top Upholstered Panels - COM\$	High Pressure Laminate Top Upholstered Panels - COM\$	Thermally Fused Laminate Top Upholstered Panels - COM\$
602 x 86 x 55	128	8 HNY60286HA577W 83185	"P" Option N/A	HNY60286HA577G 81577	HNY60286HA577M 78521
528 x 86 x 55	112	7 HNY52886HA577W 72980	"P" Option N/A	HNY52886HA577G 71573	HNY52886HA577M 68899
453 x 86 x 55	97	6 HNY45386HA577W 62775	"P" Option N/A	HNY45386HA577G 61569	HNY45386HA577M 59277
378 x 86 x 55	81	5 HNY37886HA577W 52570	"P" Option N/A	HNY37886HA577G 51565	HNY37886HA577M 49655
303 x 86 x 55	66	4 HNY30386HA577W 42365	"P" Option N/A	HNY30386HA577G 41561	HNY30386HA577M 40033
228 x 86 x 55	50	3 HNY22886HA577W 32160	"P" Option N/A	HNY22886HA577G 31557	HNY22886HA577M 30411
153 x 86 x 55	35	2 HNY15386HA577W 21955	"P" Option N/A	HNY15386HA577G 21553	HNY15386HA577M 20789
78 x 86 x 55	19	1 HNY7886HA577W 11750	"P" Option N/A	HNY7886HA577G 11549	HNY7886HA577M 11167

2 Select Finish

Click to view finishes

WWP	WOW
PO01	WNO
PO02	WSO
PO03	WNF(Natural Oak on Flat Cut)
PO07	WSF(Salted Oak on Flat Cut)
PO08	WSF(Salted Oak on Flat Cut)
PO09	WSF(Salted Oak on Flat Cut)
WBW	
WSW	
WEC	

3 Select Feet Finish

Click to view edges

WWP	WOW
PO01	WNO
PO02	WSO
PO03	
PO07	
PO08	
PO09	
WBW	
WSW	
WEC	

4 Select Edge

Click to view details

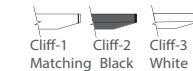

Click here to view statement of line

Product Features

- 5" Solid wood feet - oval shape, ships KD
- 4 Power outlets with 1 telecom plate, see options below for telecom plate
- Adjustable height from 27" to 47.5" with a maximum weight capacity of 275 lbs.
- Lift standard in MFW White, optional MFB Black
- HNY7125WT163 Height Adjustable worksurfaces are included
- Wire management tray attaches to worksurface top, standard in MFW White, see premium Metal Finish for options
- T75 worksurface wire cutout is standard on all worksurfaces.(T75D: Delete cutout is optional)

Notes

- 1" Gap between worksurface and panels to drop wires below worksurface
- Metal parts include 5 year warranty
- Programmable height adjustable mechanism, motor includes 2 year warranty

Options

Accessories

- K28: Articulating Keyboard w/ Mouse - \$390
- K31-SK: Center drawer w/ skirt - \$310
- K31: Center drawer w/o skirt - \$205

Concealed Floor Power Infeed Cover

- PCEB: White Metal Finish concealed floor power infeed cover - \$150

Delete Top and Wire Tray

- DHAT: Delete height adjustable top. Deduct \$3845 Veneer(W), \$3644 High Pressure Laminate(G), \$3262 Thermally Fused Laminate(M) per top

Metal Feet

- MTL10: Replace solid wood feet with metal feet, standard MFW White - \$55 ea

Premium Metal Finish

- Specify premium Metal Finish. MFMB: Matte Black, MFS: Silver, MFSS: Salmon Sienna, MFSA: Surfin Aquavert, MFPS: Pistachio, MFOS: Oyster, MFNA: Navy, MFOL: Olive, MFGB: Grey Beige MFGG: Graphite Gray, MFG: Gray, MFGM:Matte Gold
- Premium Metal Finish for WMT Wire Management Tray - \$75 ea
- Premium Metal Finish for MTL10 Metal Feet - \$20 ea
- Premium Metal Finish for PCEB Concealed Floor Power Infeed Cover - \$35

Starter Panel

- RSP: Substitute round starter panel in place of flat starter panel. Must substitute all starters, priced per starter panel - \$83 each. See HNY3555SP888

Telecom Plates

- Each power unit has 1 plate. All telecom connectors sold separately.
- RJ45 (1) - \$55, RJ45 (2) - \$110, RJ45 (3) - \$165, USB (1) - \$70, USB (2) - \$140, RJ45/USB - \$125, RJ45/HDMI - \$210, HDMI/USB - \$205

DARRAN[®]

Honey

Inline Hexagon Workstation Typical Position 2 Desk with Fixed Worksurface

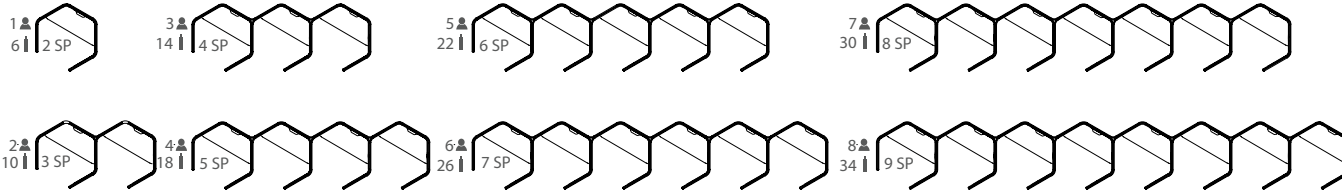

Number of Feet per Typical (MTL10 Option) "SP" Number of Starter Panels per Typical (RSP Option)

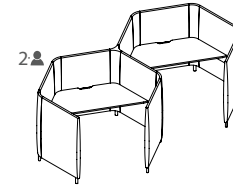

Fixed Top Workstation

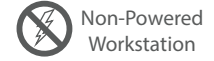

Non-Powered Workstation

1 Select Model

w" x d" x h"	Weight	Standard Veneer Top Upholstered Panels - COM\$	Premium Veneer Top Upholstered Panels - COM\$
602 x 86 x 55	128	8 HNY60286FT577W 60482	"P" Option N/A
528 x 86 x 55	112	7 HNY52886FT577W 53098	"P" Option N/A
453 x 86 x 55	97	6 HNY45386FT577W 45714	"P" Option N/A
378 x 86 x 55	81	5 HNY37886FT577W 38330	"P" Option N/A
303 x 86 x 55	66	4 HNY30386FT577W 30946	"P" Option N/A
228 x 86 x 55	50	3 HNY22886FT577W 23562	"P" Option N/A
153 x 86 x 55	35	2 HNY15386FT577W 16178	"P" Option N/A
78 x 86 x 55	19	1 HNY7886FT577W 8794	"P" Option N/A

[Click Here for Graded in Pricing](#)

2 Select Finish

Click to view finishes

WWP	WOW
PO01	WNO
PO02	WSO
PO03	WNF(Natural Oak on Flat Cut)
PO07	WSF(Salted Oak on Flat Cut)
PO08	WSF(Salted Oak on Flat Cut)
PO09	WSF(Salted Oak on Flat Cut)
WBW	
WSW	
WEC	

3 Select Feet Finish

Click to view edges

WWP	WOW
PO01	WNO
PO02	WSO
PO03	
PO07	
PO08	
PO09	
WBW	
WSW	
WEC	

4 Select Edge

Click to view details

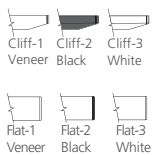

High Pressure Laminate Top Upholstered Panels - COM\$

HNY60286FT577G 58882	"P" Option N/A
HNY52886FT577G 51698	"P" Option N/A
HNY45386FT577G 44514	"P" Option N/A
HNY37886FT577G 37330	"P" Option N/A
HNY30386FT577G 30146	"P" Option N/A
HNY22886FT577G 22962	"P" Option N/A
HNY15386FT577G 15778	"P" Option N/A
HNY7886FT577G 8594	"P" Option N/A

GEC	LW04
GNA +5%	LW05
GWL	LW06
LP01	
LF02	
LF03	
LN01	
LA02	
LW01	
LW02	

WWP	WOW
PO01	WNO
PO02	WSO
PO03	
PO07	
PO08	
PO09	
WBW	
WSW	
WEC	



Thermally Fused Laminate Top Upholstered Panels - COM\$

HNY60286FT577M 55826	"P" Option N/A
HNY52886FT577M 49024	"P" Option N/A
HNY45386FT577M 42222	"P" Option N/A
HNY37886FT577M 35420	"P" Option N/A
HNY30386FT577M 28618	"P" Option N/A
HNY22886FT577M 21816	"P" Option N/A
HNY15386FT577M 15014	"P" Option N/A
HNY7886FT577M 8212	"P" Option N/A

MOC
MEC
MSW
MTW
MWL
MNA

WWP	WOW
PO01	WNO
PO02	WSO
PO03	
PO07	
PO08	
PO09	
WBW	
WSW	



[Click here to view statement of line](#)

Product Features

- 5" Solid wood feet - oval shape
- HNY7226WT162 Fixed Desk Height worksurfaces, 29" worksurface height
- Ships KD
- T75 worksurface wire cutout is standard on all worksurfaces.(T75D: Delete cutout is optional)

Options

Accessories

- K28: Articulating Keyboard w/ Mouse - \$390
- K31-SK: Center drawer w/ skirt - \$310
- K31: Center drawer w/o skirt - \$205

Concealed Floor Power Infeed Cover

- PCEB: White Metal Finish concealed floor power infeed cover - \$150

Delete Top

- DFT: Delete fixed top. Deduct \$1325 Veneer(W), \$1125 High Pressure Laminate (G), \$743 Thermally Fused Laminate (M) per top

Metal Feet

- MTL10: Replace solid wood feet with metal feet, standard MFW White - \$55 ea

Premium Metal Finish

- Specify premium Metal Finish. MFMB: Matte Black, MFS: Silver, MFSS: Salmon Sienna, MFSA: Surfing Aquavert, MFPS: Pistachio, MFOS: Oyster, MFNA: Navy, MFOL: Olive, MFGB: Grey Beige MFGG: Graphite Gray, MFG: Gray, MFGM:Matte Gold
- Premium Metal Finish for WMT Wire Management Tray - \$75 ea
- Premium Metal Finish for MTL10 Metal Feet - \$20 ea
- Premium Metal Finish for PCEB Concealed Floor Power Infeed Cover - \$35

Starter Panel

- RSP: Substitute round starter panel in place of flat starter panel. Must substitute all starters, priced per starter panel - \$83 each. See HNY3555SP888

Worksurface Height

- Modify worksurface height to bar height.
- THL-42: Position worksurface at bar height - N/C

Wire Tray

- WMT: Wire metal tray. Mounts under top and comes standard in MFW White - \$210

DARRAN

Honey

Inline Hexagon Workstation Typical
Position 2 Desk with Power Fixed Worksurface

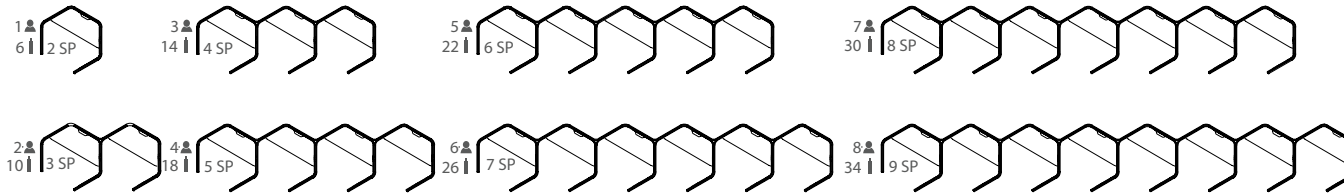

Number of Feet per Typical (MTL10 Option) "SP" Number of Starter Panels per Typical (RSP Option)

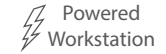
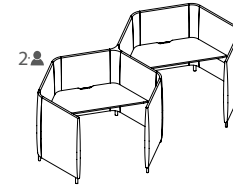

1 Select Model

w" x d" x h"	Weight	Standard Veneer Top Upholstered Panels - COM\$	Premium Veneer Top Upholstered Panels - COM\$
602 x 86 x 55	128	8 HNY60286FP577W 64857	"P" Option N/A
528 x 86 x 55	112	7 HNY52886FP577W 56943	"P" Option N/A
453 x 86 x 55	97	6 HNY45386FP577W 49029	"P" Option N/A
378 x 86 x 55	81	5 HNY37886FP577W 41115	"P" Option N/A
303 x 86 x 55	66	4 HNY30386FP577W 33201	"P" Option N/A
228 x 86 x 55	50	3 HNY22886FP577W 25287	"P" Option N/A
153 x 86 x 55	35	2 HNY15386FP577W 17373	"P" Option N/A
78 x 86 x 55	19	1 HNY7886FP577W 9459	"P" Option N/A

[Click Here for Graded in Pricing](#)

2 Select Finish

Click to view finishes

WWP	WOW
PO01	WNO
PO02	WSO
PO03	WNF(Natural Oak on Flat Cut)
PO07	WSF(Salted Oak on Flat Cut)
PO08	WSF(Salted Oak on Flat Cut)
PO09	WSF(Salted Oak on Flat Cut)
WBW	
WSW	
WEC	

3 Select Feet Finish

Click to view edges

WWP	WOW
PO01	WNO
PO02	WSO
PO03	
PO07	
PO08	
PO09	
WBW	
WSW	
WEC	

4 Select Edge

Click to view details



High Pressure Laminate Top Upholstered Panels - COM\$

HNY60286FP577G 63257	"P" Option N/A
HNY52886FP577G 55543	"P" Option N/A
HNY45386FP577G 47829	"P" Option N/A
HNY37886FP577G 40115	"P" Option N/A
HNY30386FP577G 32401	"P" Option N/A
HNY22886FP577G 24687	"P" Option N/A
HNY15386FP577G 16973	"P" Option N/A
HNY7886FP577G 9259	"P" Option N/A

GEC	LW04
GNA +5%	LW05
GWL	LW06
LP01	
LF02	
LF03	
LN01	
LA02	
LW01	
LW02	

WWP	WOW
PO01	WNO
PO02	WSO
PO03	
PO07	
PO08	
PO09	
WBW	
WSW	
WEC	

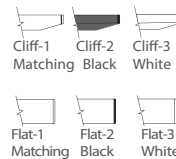

Thermally Fused Laminate Top Upholstered Panels - COM\$

HNY60286FP577M 60201	"P" Option N/A
HNY52886FP577M 52869	"P" Option N/A
HNY45386FP577M 45537	"P" Option N/A
HNY37886FP577M 38205	"P" Option N/A
HNY30386FP577M 30873	"P" Option N/A
HNY22886FP577M 23541	"P" Option N/A
HNY15386FP577M 16209	"P" Option N/A
HNY7886FP577M 8877	"P" Option N/A

MOC
MEC
MSW
MTW
MWL
MNA

WWP	WOW
PO01	WNO
PO02	WSO
PO03	
PO07	
PO08	
PO09	
WEC	
WBW	
WSW	



[Click here to view statement of line](#)

Product Features

- HNY7226WT162 Fixed Desk Height worksurfaces, 29" worksurface height
- 5" Solid wood feet - oval shape
- 4 Power outlets with 1 telecom plate, see options below for telecom plate
- Ships KD
- Wire management tray attaches to worksurface top, standard in MFW White, see premium Metal Finish for options
- Hardwire infeed and jumpers are included in workstations
- T75 worksurface wire cutout is standard on all worksurfaces.(T75D: Delete cutout is optional)

Options

Accessories

- K28: Articulating Keyboard w/ Mouse - \$390
- K31-SK: Center drawer w/ skirt - \$310
- K31: Center drawer w/o skirt - \$205

Concealed Floor Power Infeed Cover

- PCEB: White Metal Finish concealed floor power infeed cover - \$150

Delete Top and Wire Tray

- DFP: Delete fixed top. Deduct \$1535 Veneer (W), \$1335 High Pressure Laminate (G), \$953 Thermally Fused Laminate (M) per top

Metal Feet

- MTL10: Replace solid wood feet with metal feet, standard MFW White - \$55 ea

Premium Metal Finish

- Specify premium Metal Finish. MFMB: Matte Black, MFS: Silver, MFSS: Salmon Sienna, MFSA: Surfing Aquavert, MFPS: Pistachio, MFOS: Oyster, MFNA: Navy, MFOL: Olive, MFGB: Grey Beige MFGG: Graphite Gray, MFG: Gray, MFGM:Matte Gold
- Premium Metal Finish for WMT Wire Management Tray - \$75 ea
- Premium Metal Finish for MTL10 Metal Feet - \$20 ea
- Premium Metal Finish for PCEB Concealed Floor Power Infeed Cover - \$35

Starter Panel

- RSP: Substitute round starter panel in place of flat starter panel. Must substitute all starters, priced per starter panel - \$83 each. See HNY3555SP888

Telecom Plates

- Each power unit has 1 plate. All telecom connectors sold separately.
- RJ45 (1) - \$55, RJ45 (2) - \$110, RJ45 (3) - \$165, USB (1) - \$70, USB (2) - \$140, RJ45/USB - \$125, RJ45/HDMI - \$210, HDMI/USB - \$205

Worksurface Height

- THL-42: Modify worksurface height to bar height - N/C

DARRAN

Honey

Inline Hexagon Workstation Typical Position 3 with Height Adjustable Worksurface

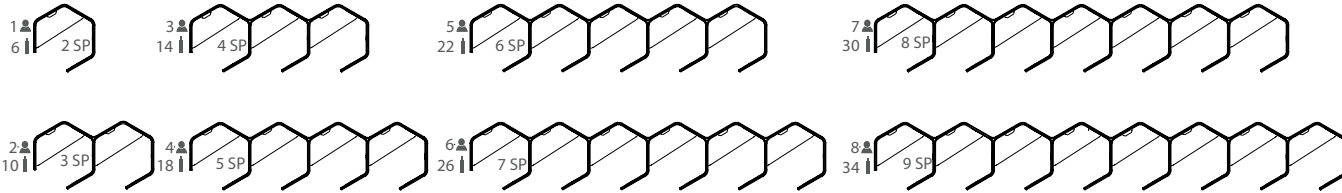

Number of Feet per Typical (MTL10 Option) "SP" Number of Starter Panels per Typical (RSP Option)

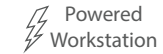
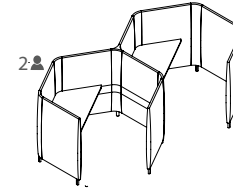

1 Select Model

w" x d" x h"	Weight	Standard Veneer Top Upholstered Panels - COM\$	Premium Veneer Top Upholstered Panels - COM\$
602 x 86 x 55	128	8 HNY60286HA578W 83185	"P" Option N/A
528 x 86 x 55	112	7 HNY52886HA578W 72980	"P" Option N/A
453 x 86 x 55	97	6 HNY45386HA578W 62775	"P" Option N/A
378 x 86 x 55	81	5 HNY37886HA578W 52570	"P" Option N/A
303 x 86 x 55	66	4 HNY30386HA578W 42365	"P" Option N/A
228 x 86 x 55	50	3 HNY22886HA578W 32160	"P" Option N/A
153 x 86 x 55	35	2 HNY15386HA578W 21955	"P" Option N/A
78 x 86 x 55	19	1 HNY7886HA578W 11750	"P" Option N/A

[Click Here for Graded in Pricing](#)

2 Select Finish

Click to view finishes

WWP	WOW
PO01	WNO
PO02	WSO
PO03	WNF(Natural Oak on Flat Cut)
PO07	WSF(Salted Oak on Flat Cut)
PO08	WSF(Salted Oak on Flat Cut)
PO09	WSF(Salted Oak on Flat Cut)
WBW	
WSW	
WEC	

3 Select Feet Finish

Click to view edges

WWP	WOW
PO01	WNO
PO02	WSO
PO03	
PO07	
PO08	
PO09	
WBW	
WSW	
WEC	

4 Select Edge

Click to view details

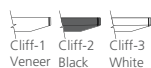

GEC	LW04
GNA +5%	LW05
GWL	LW06
LP01	
LF02	
LF03	
LN01	
LA02	
LW01	
LW02	

WWP	WOW
PO01	WNO
PO02	WSO
PO03	
PO07	
PO08	
PO09	
WBW	
WSW	
WEC	



MOC
MEC
MSW
MTW
MWL
MNA

WWP	WOW
PO01	WNO
PO02	WSO
PO03	
PO07	
PO08	
PO09	
WBW	
WSW	



High Pressure Laminate Top Upholstered Panels - COM\$

HNY60286HA578G	81577
HNY52886HA578G	71573
HNY45386HA578G	61569
HNY37886HA578G	51565
HNY30386HA578G	41561
HNY22886HA578G	31557
HNY15386HA578G	21553
HNY7886HA578G	11549

Thermally Fused Laminate Top Upholstered Panels - COM\$

HNY60286HA578M	78521
HNY52886HA578M	68899
HNY45386HA578M	59277
HNY37886HA578M	49655
HNY30386HA578M	40033
HNY22886HA578M	30411
HNY15386HA578M	20789
HNY7886HA578M	11167

[Click here to view statement of line](#)

Product Features

- 5" Solid wood feet - oval shape, ships KD
- 4 Power outlets with 1 telecom plate, see options below for telecom plate
- Adjustable height from 27" to 47.5" with a maximum weight capacity of 275 lbs.
- Lift standard in MFW White, optional MFB Black
- HNY7125WT163 Height Adjustable worksurfaces are included
- Wire management tray attaches to worksurface top, standard in MFW White, see premium Metal Finish for options
- T75 worksurface wire cutout is standard on all worksurfaces.(T75D: Delete cutout is optional)

Notes

- 1" Gap between worksurface and panels to drop wires below worksurface
- Metal parts include 5 year warranty
- Programmable height adjustable mechanism, motor includes 2 year warranty

Options

Accessories

- K28: Articulating Keyboard w/ Mouse - \$390
- K31-SK: Center drawer w/ skirt - \$310
- K31: Center drawer w/o skirt - \$205

Concealed Floor Power Infeed Cover

- PCEB: White Metal Finish concealed floor power infeed cover - \$150

Delete Top and Wire Tray

- DHAT: Delete height adjustable top. Deduct \$3845 Veneer(W), \$3644 High Pressure Laminate(G), \$3262 Thermally Fused Laminate(M) per top

Metal Feet

- MTL10: Replace solid wood feet with metal feet, standard MFW White - \$55 ea

Premium Metal Finish

- Specify premium Metal Finish. MFMB: Matte Black, MFS: Silver, MFSS: Salmon Sienna, MFSA: Surfin Aquavert, MFPS: Pistachio, MFOS: Oyster, MFNA: Navy, MFOL: Olive, MFGB: Grey Beige MFGG: Graphite Gray, MFG: Gray, MFGM:Matte Gold
- Premium Metal Finish for WMT Wire Management Tray - \$75 ea
- Premium Metal Finish for MTL10 Metal Feet - \$20 ea
- Premium Metal Finish for PCEB Concealed Floor Power Infeed Cover - \$35

Starter Panel

- RSP: Substitute round starter panel in place of flat starter panel. Must substitute all starters, priced per starter panel - \$83 each. See HNY3555SP888

Telecom Plates

- Each power unit has 1 plate. All telecom connectors sold separately.
- RJ45 (1) - \$55, RJ45 (2) - \$110, RJ45 (3) - \$165, USB (1) - \$70, USB (2) - \$140, RJ45/USB - \$125, RJ45/HDMI - \$210, HDMI/USB - \$205

DARRAN

Honey

Inline Hexagon Workstation Typical
Position 3 Desk with Fixed Worksurface

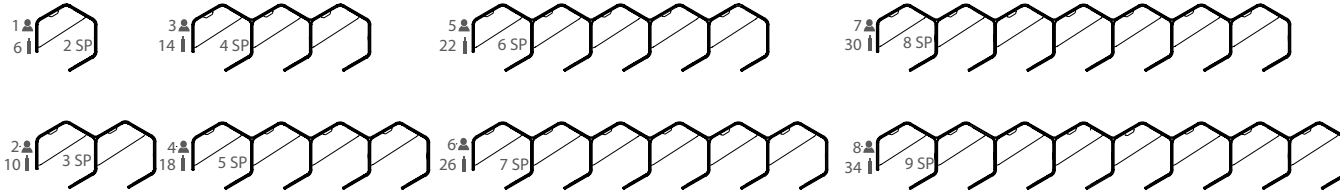

Number of Feet per Typical (MTL10 Option) "SP" Number of Starter Panels per Typical (RSP Option)

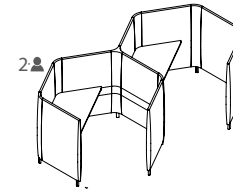

Fixed Top Workstation



Non-Powered Workstation

1 Select Model

w" x d" x h"	Weight	Standard Veneer Top Upholstered Panels - COM\$	Premium Veneer Top Upholstered Panels - COM\$
602 x 86 x 55	128	8 HNY60286FT578W 60482	"P" Option N/A
528 x 86 x 55	112	7 HNY52886FT578W 53098	"P" Option N/A
453 x 86 x 55	97	6 HNY45386FT578W 45714	"P" Option N/A
378 x 86 x 55	81	5 HNY37886FT578W 38330	"P" Option N/A
303 x 86 x 55	66	4 HNY30386FT578W 30946	"P" Option N/A
228 x 86 x 55	50	3 HNY22886FT578W 23562	"P" Option N/A
153 x 86 x 55	35	2 HNY15386FT578W 16178	"P" Option N/A
78 x 86 x 55	19	1 HNY7886FT578W 8794	"P" Option N/A

[Click Here for Graded in Pricing](#)

2 Select Finish

Click to view finishes

WWP	WOW
PO01	WNO
PO02	WSO
PO03	WNF(Natural Oak on Flat Cut)
PO07	WSF(Salted Oak on Flat Cut)
PO08	WSF(Salted Oak on Flat Cut)
PO09	WSF(Salted Oak on Flat Cut)
WBW	
WSW	
WEC	

3 Select Feet Finish

Click to view edges

WWP	WOW
PO01	WNO
PO02	WSO
PO03	
PO07	
PO08	
PO09	
WBW	
WSW	
WEC	

4 Select Edge

Click to view details

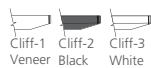

GEC	LW04
GNA +5%	LW05
GWL	LW06
LP01	
LF02	
LF03	
LN01	
LA02	
LW01	
LW02	

WWP	WOW
PO01	WNO
PO02	WSO
PO03	
PO07	
PO08	
PO09	
WBW	
WSW	
WEC	



MOC
MEC
MSW
MTW
MWL
MNA

WWP	WOW
PO01	WNO
PO02	WSO
PO03	
PO07	
PO08	
PO09	
WBW	
WSW	



High Pressure Laminate Top Upholstered Panels - COM\$	Thermally Fused Laminate Top Upholstered Panels - COM\$
HNY60286FT578G 58882	HNY60286FT578M 55826
HNY52886FT578G 51698	HNY52886FT578M 49024
HNY45386FT578G 44514	HNY45386FT578M 42222
HNY37886FT578G 37330	HNY37886FT578M 35420
HNY30386FT578G 30146	HNY30386FT578M 28618
HNY22886FT578G 22962	HNY22886FT578M 21816
HNY15386FT578G 15778	HNY15386FT578M 15014
HNY7886FT578G 8594	HNY7886FT578M 8212

[Click here to view statement of line](#)

Product Features

- 5" Solid wood feet - oval shape
- HNY7226WT162 Fixed Desk Height worksurfaces, 29" worksurface height
- Ships KD
- T75 worksurface wire cutout is standard on all worksurfaces.(T75D: Delete cutout is optional)

Options

Accessories

- K28: Articulating Keyboard w/ Mouse - \$390
- K31-SK: Center drawer w/ skirt - \$310
- K31: Center drawer w/o skirt - \$205

Concealed Floor Power Infeed Cover

- PCEB: White Metal Finish concealed floor power infeed cover - \$150

Delete Top

- DFT: Delete fixed top. Deduct \$1325 Veneer(W), \$1125 High Pressure Laminate (G), \$743 Thermally Fused Laminate (M) per top

Metal Feet

- MTL10: Replace solid wood feet with metal feet, standard MFW White - \$55 ea

Premium Metal Finish

- Specify premium Metal Finish. MFMB: Matte Black, MFS: Silver, MFSS: Salmon Sienna, MFSA: Surfing Aquavert, MFPS: Pistachio, MFOS: Oyster, MFNA: Navy, MFOL: Olive, MFGB: Grey Beige MFGG: Graphite Gray, MFG: Gray, MFGM:Matte Gold
- Premium Metal Finish for WMT Wire Management Tray - \$75 ea
- Premium Metal Finish for MTL10 Metal Feet - \$20 ea
- Premium Metal Finish for PCEB Concealed Floor Power Infeed Cover - \$35

Starter Panel

- RSP: Substitute round starter panel in place of flat starter panel. Must substitute all starters, priced per starter panel - \$83 each. See HNY3555SP888

Worksurface Height

- Modify worksurface height to bar height.
- THL-42: Position worksurface at bar height - N/C

Wire Tray

- WMT: Wire metal tray. Mounts under top and comes standard in MFW White - \$210

DARRAN

Honey

Inline Hexagon Workstation Typical Position 3 Desk with Power Fixed Worksurface

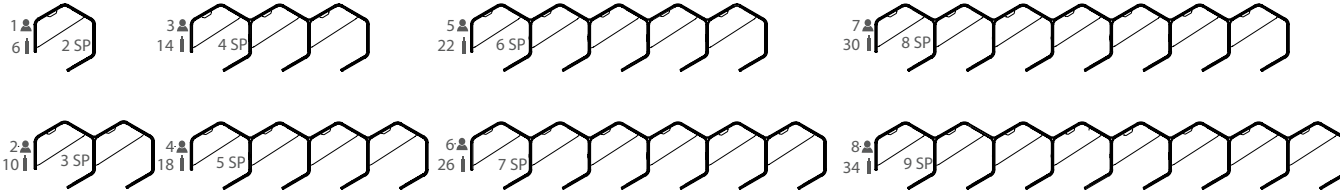

Number of Feet per Typical (MTL10 Option) "SP" Number of Starter Panels per Typical (RSP Option)

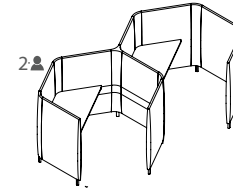

Fixed Top Workstation
Powered Workstation

1 Select Model

w" x d" x h"	Weight	Standard Veneer Top Upholstered Panels - COM\$	Premium Veneer Top Upholstered Panels - COM\$
602 x 86 x 55	128	8 HNY60286FP578W 64857	"P" Option N/A
528 x 86 x 55	112	7 HNY52886FP578W 56943	"P" Option N/A
453 x 86 x 55	97	6 HNY45386FP578W 49029	"P" Option N/A
378 x 86 x 55	81	5 HNY37886FP578W 41115	"P" Option N/A
303 x 86 x 55	66	4 HNY30386FP578W 33201	"P" Option N/A
228 x 86 x 55	50	3 HNY22886FP578W 25287	"P" Option N/A
153 x 86 x 55	35	2 HNY15386FP578W 17373	"P" Option N/A
78 x 86 x 55	19	1 HNY7886FP578W 9459	"P" Option N/A

[Click Here for Graded in Pricing](#)

2 Select Finish

Click to view finishes

WWP	WOW
PO01	WNO
PO02	WSO
PO03	WNF(Natural Oak on Flat Cut)
PO07	WSF(Salted Oak on Flat Cut)
PO08	WSF(Salted Oak on Flat Cut)
PO09	WSF(Salted Oak on Flat Cut)
WBW	
WSW	
WEC	

3 Select Feet Finish

Click to view edges

WWP	WOW
PO01	WNO
PO02	WSO
PO03	
PO07	
PO08	
PO09	
WBW	
WSW	
WEC	

4 Select Edge

Click to view details

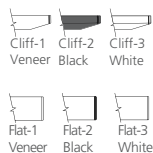

High Pressure Laminate Top Upholstered Panels - COM\$

HNY60286FP578G	63257
HNY52886FP578G	55543
HNY45386FP578G	47829
HNY37886FP578G	40115
HNY30386FP578G	32401
HNY22886FP578G	24687
HNY15386FP578G	16973
HNY7886FP578G	9259

GEC	LW04
GNA +5%	LW05
GWL	LW06
LP01	
LF02	
LF03	
LN01	
LA02	
LW01	
LW02	

WWP	WOW
PO01	WNO
PO02	WSO
PO03	
PO07	
PO08	
PO09	
WBW	
WSW	
WEC	

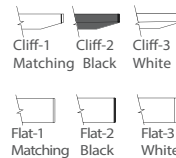

Thermally Fused Laminate Top Upholstered Panels - COM\$

HNY60286FP578M	60201
HNY52886FP578M	52869
HNY45386FP578M	45537
HNY37886FP578M	38205
HNY30386FP578M	30873
HNY22886FP578M	23541
HNY15386FP578M	16209
HNY7886FP578M	8877

MOC
MEC
MSW
MTW
MWL
MNA

WWP	WOW
PO01	WNO
PO02	WSO
PO03	
PO07	
PO08	
PO09	
WEC	
WBW	
WSW	



[Click here to view statement of line](#)

Product Features

- HNY7226WT162 Fixed Desk Height worksurfaces, 29" worksurface height
- 5" Solid wood feet - oval shape
- 4 Power outlets with 1 telecom plate, see options below for telecom plate
- Ships KD
- Wire management tray attaches to worksurface top, standard in MFW White, see premium Metal Finish for options
- Hardwire infeed and jumpers are included in workstations
- T75 worksurface wire cutout is standard on all worksurfaces.(T75D: Delete cutout is optional)

Options

Accessories

- K28: Articulating Keyboard w/ Mouse - \$390
- K31-SK: Center drawer w/ skirt - \$310
- K31: Center drawer w/o skirt - \$205

Concealed Floor Power Infeed Cover

- PCEB: White Metal Finish concealed floor power infeed cover - \$150

Delete Top and Wire Tray

- DFP: Delete fixed top. Deduct \$1535 Veneer (W), \$1335 High Pressure Laminate (G), \$953 Thermally Fused Laminate (M) per top

Metal Feet

- MTL10: Replace solid wood feet with metal feet, standard MFW White - \$55 ea

Premium Metal Finish

- Specify premium Metal Finish. MFMB: Matte Black, MFS: Silver, MFSS: Salmon Sienna, MFSA: Surfing Aquavert, MFPS: Pistachio, MFOS: Oyster, MFNA: Navy, MFOL: Olive, MFGB: Grey Beige MFGG: Graphite Gray, MFG: Gray, MFGM:Matte Gold
- Premium Metal Finish for WMT Wire Management Tray - \$75 ea
- Premium Metal Finish for MTL10 Metal Feet - \$20 ea
- Premium Metal Finish for PCEB Concealed Floor Power Infeed Cover - \$35

Starter Panel

- RSP: Substitute round starter panel in place of flat starter panel. Must substitute all starters, priced per starter panel - \$83 each. See HNY3555SP888

Telecom Plates

- Each power unit has 1 plate. All telecom connectors sold separately.
- RJ45 (1) - \$55, RJ45 (2) - \$110, RJ45 (3) - \$165, USB (1) - \$70, USB (2) - \$140, RJ45/USB - \$125, RJ45/HDMI - \$210, HDMI/USB - \$205

Worksurface Height

- THL-42: Modify worksurface height to bar height - N/C

DARRAN

Honey

Double Hexagon Workstation Typical
Position 1 Desk with Height Adjustable Worksurface

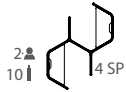

2 people 10' 4 SP
Number of Feet per Typical (MTL10 Option) "SP" Number of Starter Panels per Typical (RSP Option)

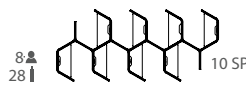
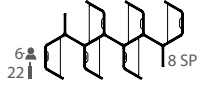
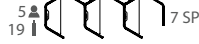
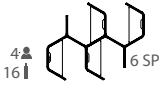
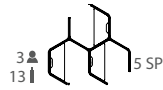

2 people

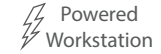
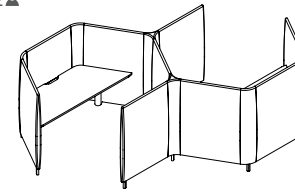

1 Select Model

w" x d" x h"	Weight	Standard Veneer Top Upholstered Panels - COM\$	Premium Veneer Top Upholstered Panels - COM\$	High Pressure Laminate Top Upholstered Panels - COM\$	Thermally Fused Laminate Top Upholstered Panels - COM\$
340 x 150 x 55	103	8 people HNY340150HA579W 72932	"P" Option N/A	HNY340150HA579G 71324	HNY340150HA579M 68268
303 x 150 x 55	92	7 people HNY303150HA579W 64293	"P" Option N/A	HNY303150HA579G 62886	HNY303150HA579M 60212
265 x 150 x 55	80	6 people HNY265150HA579W 55804	"P" Option N/A	HNY265150HA579G 54598	HNY265150HA579M 52306
228 x 150 x 55	69	5 people HNY228150HA579W 47240	"P" Option N/A	HNY228150HA579G 46235	HNY228150HA579M 44325
191 x 150 x 55	57	4 people HNY191150HA579W 38676	"P" Option N/A	HNY191150HA579G 37872	HNY191150HA579M 36344
153 x 150 x 55	46	3 people HNY153150HA579W 30037	"P" Option N/A	HNY153150HA579G 29434	HNY153150HA579M 28288
116 x 150 x 55	34	2 people HNY116150HA579W 21533	"P" Option N/A	HNY116150HA579G 21131	HNY116150HA579M 20367

2 Select Finish

Click to view finishes	WWP	WOW
	PO01	WNO
	PO02	WSO
	PO03	WNF(Natural Oak on Flat Cut)
	PO07	WSF(Salted Oak on Flat Cut)
	PO08	WSF(Salted Oak on Flat Cut)
	PO09	WSF(Salted Oak on Flat Cut)
	WBW	
	WSW	
	WEC	

3 Select Feet Finish

Click to view edges	WWP	WOW
	PO01	WNO
	PO02	WSO
	PO03	
	PO07	
	PO08	
	PO09	
	WBW	
	WSW	
	WEC	

4 Select Edge

Click to view details	Cliff-1 Veneer	Cliff-2 Black	Cliff-3 White
	Flat-1 Veneer	Flat-2 Black	Flat-3 White

GEC	LW04
GNA +5%	LW05
GWL	LW06
LP01	
LF02	
LF03	
LN01	
LA02	
LW01	
LW02	

WWP	WOW
PO01	WNO
PO02	WSO
PO03	
PO07	
PO08	
PO09	
WBW	
WSW	
WEC	

Cliff-1 Matching	Cliff-2 Black	Cliff-3 White
Flat-1 Matching	Flat-2 Black	Flat-3 White

MOC
MEC
MSW
MTW
MWL
MNA

WWP	WOW
PO01	WNO
PO02	WSO
PO03	
PO07	
PO08	
PO09	
WEC	
WBW	
WSW	

Flat-2 Black	Flat-3 White	Flat-4 Matching
--------------	--------------	-----------------

[Click here to view statement of line](#)

Product Features

- 5" Solid wood feet - oval shape, ships KD
- 4 Power outlets with 1 telecom plate, see options below for telecom plate
- Adjustable height from 27" to 47.5" with a maximum weight capacity of 275 lbs.
- Lift standard in MFW White, optional MFB Black
- HNY7125WT163 Height Adjustable worksurfaces are included
- Wire management tray attaches to worksurface top, standard in MFW White, see premium Metal Finish for options
- T75 worksurface wire cutout is standard on all worksurfaces.(T75D: Delete cutout is optional)

Notes

- 1" Gap between worksurface and panels to drop wires below worksurface
- Metal parts include 5 year warranty
- Programmable height adjustable mechanism, motor includes 2 year warranty

Options

- Accessories**
- K28: Articulating Keyboard w/ Mouse - \$390
 - K31-SK: Center drawer w/ skirt - \$310
 - K31: Center drawer w/o skirt - \$205
- Concealed Floor Power Infeed Cover**
- PCEB: White Metal Finish concealed floor power infeed cover - \$150

- Delete Top and Wire Tray**
- DHAT: Delete height adjustable top. Deduct \$3845 Veneer(W), \$3644 High Pressure Laminate(G), \$3262 Thermally Fused Laminate(M) per top

- Metal Feet**
- MTL10: Replace solid wood feet with metal feet, standard MFW White - \$55 ea

- Premium Metal Finish**
- Specify premium Metal Finish. MFMB: Matte Black, MFS: Silver, MFSS: Salmon Sienna, MFSA: Surfin Aquavert, MFPS: Pistachio, MFOS: Oyster, MFNA: Navy, MFOL: Olive, MFGB: Grey Beige MFGG: Graphite Gray, MFG: Gray, MFGM:Matte Gold
 - Premium Metal Finish for WMT Wire Management Tray - \$75 ea
 - Premium Metal Finish for MTL10 Metal Feet - \$20 ea
 - Premium Metal Finish for PCEB Concealed Floor Power Infeed Cover - \$35

- Starter Panel**
- RSP: Substitute round starter panel in place of flat starter panel. Must substitute all starters, priced per starter panel - \$83 each. See HNY3555SP888

- Telecom Plates**
- Each power unit has 1 plate. All telecom connectors sold separately.
 - RJ45 (1) - \$55, RJ45 (2) - \$110, RJ45 (3) - \$165, USB (1) - \$70, USB (2) - \$140, RJ45/USB - \$125, RJ45/HDMI - \$210, HDMI/USB - \$205

Double Hexagon Workstation Typical
Position 1 Desk with Fixed Worksurface

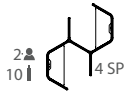

Number of Feet per Typical (MTL10 Option) "SP" Number of Starter Panels per Typical (RSP Option)

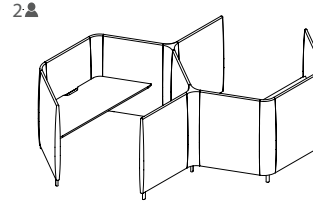
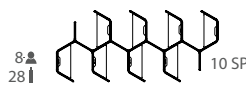
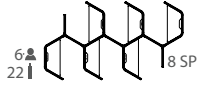
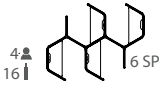
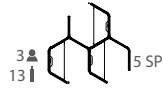

1 Select Model

w" x d" x h"	Weight	Standard Veneer Top Upholstered Panels - COM\$	Premium Veneer Top Upholstered Panels - COM\$
340 x 150 x 55	103	8 HNY340150FT579W 50492	"P" Option N/A
303 x 150 x 55	92	7 HNY303150FT579W 44690	"P" Option N/A
265 x 150 x 55	80	6 HNY265150FT579W 38888	"P" Option N/A
228 x 150 x 55	69	5 HNY228150FT579W 33086	"P" Option N/A
191 x 150 x 55	57	4 HNY191150FT579W 27284	"P" Option N/A
153 x 150 x 55	46	3 HNY153150FT579W 21482	"P" Option N/A
116 x 150 x 55	34	2 HNY116150FT579W 15680	"P" Option N/A

[Click Here for Graded in Pricing](#)

2 Select Finish

Click to view finishes

WWP	WOW
PO01	WNO
PO02	WSO
PO03	WNF(Natural Oak on Flat Cut)
PO07	WSF(Salted Oak on Flat Cut)
PO08	WSF(Salted Oak on Flat Cut)
PO09	WSF(Salted Oak on Flat Cut)
WBW	
WSW	
WEC	

3 Select Feet Finish

Click to view edges

WWP	WOW
PO01	WNO
PO02	WSO
PO03	
PO07	
PO08	
PO09	
WBW	
WSW	
WEC	

4 Select Edge

Click to view details

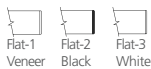

GEC	LW04
GNA +5%	LW05
GWL	LW06
LP01	
LF02	
LF03	
LN01	
LA02	
LW01	
LW02	

WWP	WOW
PO01	WNO
PO02	WSO
PO03	
PO07	
PO08	
PO09	
WBW	
WSW	
WEC	



MOC
MEC
MSW
MTW
MWL
MNA

WWP	WOW
PO01	WNO
PO02	WSO
PO03	
PO07	
PO08	
PO09	
WBW	
WSW	



[Click here to view statement of line](#)

Product Features

- 5" Solid wood feet - oval shape
- HNY7226WT162 Fixed Desk Height worksurfaces, 29" worksurface height
- Ships KD
- T75 worksurface wire cutout is standard on all worksurfaces.(T75D: Delete cutout is optional)

Options

Accessories

- K28: Articulating Keyboard w/ Mouse - \$390
- K31-SK: Center drawer w/ skirt - \$310
- K31: Center drawer w/o skirt - \$205

Concealed Floor Power Infeed Cover

- PCEB: White Metal Finish concealed floor power infeed cover - \$150

Delete Top

- DFT: Delete fixed top. Deduct \$1325 Veneer(W), \$1125 High Pressure Laminate (G), \$743 Thermally Fused Laminate (M) per top

Metal Feet

- MTL10: Replace solid wood feet with metal feet, standard MFW White - \$55 ea

Premium Metal Finish

- Specify premium Metal Finish. MFMB: Matte Black, MFS: Silver, MFSS: Salmon Sienna, MFSA: Surfing Aquavert, MFPS: Pistachio, MFOS: Oyster, MFNA: Navy, MFOL: Olive, MFGB: Grey Beige MFGG: Graphite Gray, MFG: Gray, MFGM:Matte Gold
- Premium Metal Finish for WMT Wire Management Tray - \$75 ea
- Premium Metal Finish for MTL10 Metal Feet - \$20 ea
- Premium Metal Finish for PCEB Concealed Floor Power Infeed Cover - \$35

Starter Panel

- RSP: Substitute round starter panel in place of flat starter panel. Must substitute all starters, priced per starter panel - \$83 each. See HNY3555SP888

Worksurface Height

- Modify worksurface height to bar height.
- THL-42: Position worksurface at bar height - N/C

Wire Tray

- WMT: Wire metal tray. Mounts under top and comes standard in MFW White - \$210

Double Hexagon Workstation Typical
Position 1 Desk with Power Fixed Worksurface

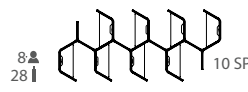
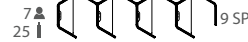
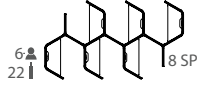
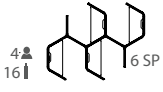
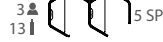
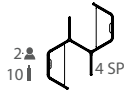

Number of Feet per Typical (MTL10 Option) "SP" Number of Starter Panels per Typical (RSP Option)

2

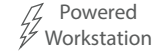
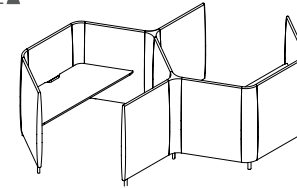

1 Select Model

w" x d" x h"	Weight	Standard Veneer Top Upholstered Panels - COM\$	Premium Veneer Top Upholstered Panels - COM\$	High Pressure Laminate Top Upholstered Panels - COM\$	Thermally Fused Laminate Top Upholstered Panels - COM\$
340 x 150 x 55	103	8 HNY340150FP579W 54604	"P" Option N/A	HNY340150FP579G 53004	HNY340150FP579M 49948
303 x 150 x 55	92	7 HNY303150FP579W 48256	"P" Option N/A	HNY303150FP579G 46856	HNY303150FP579M 44182
265 x 150 x 55	80	6 HNY265150FP579W 42058	"P" Option N/A	HNY265150FP579G 40858	HNY265150FP579M 38566
228 x 150 x 55	69	5 HNY228150FP579W 35785	"P" Option N/A	HNY228150FP579G 34785	HNY228150FP579M 32875
191 x 150 x 55	57	4 HNY191150FP579W 29512	"P" Option N/A	HNY191150FP579G 28712	HNY191150FP579M 27184
153 x 150 x 55	46	3 HNY153150FP579W 23164	"P" Option N/A	HNY153150FP579G 22564	HNY153150FP579M 21418
116 x 150 x 55	34	2 HNY116150FP579W 16951	"P" Option N/A	HNY116150FP579G 16551	HNY116150FP579M 15787

[Click Here for Graded in Pricing](#)

2 Select Finish

Click to view finishes

WWP	WOW
PO01	WNO
PO02	WSO
PO03	WNF(Natural Oak on Flat Cut)
PO07	WSF(Salted Oak on Flat Cut)
PO08	WSF(Salted Oak on Flat Cut)
PO09	WSF(Salted Oak on Flat Cut)
WBW	
WSW	
WEC	

3 Select Feet Finish

Click to view edges

WWP	WOW
PO01	WNO
PO02	WSO
PO03	
PO07	
PO08	
PO09	
WBW	
WSW	
WEC	

4 Select Edge

Click to view details

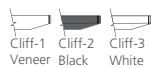

GEC	LW04
GNA +5%	LW05
GWL	LW06
LP01	
LF02	
LF03	
LN01	
LA02	
LW01	
LW02	

WWP	WOW
PO01	WNO
PO02	WSO
PO03	
PO07	
PO08	
PO09	
WBW	
WSW	
WEC	



MOC
MEC
MSW
MTW
MWL
MNA

WWP	WOW
PO01	WNO
PO02	WSO
PO03	
PO07	
PO08	
PO09	
WEC	
WBW	
WSW	



[Click here to view statement of line](#)

Product Features

- HNY7226WT162 Fixed Desk Height worksurfaces, 29" worksurface height
- 5" Solid wood feet - oval shape
- 4 Power outlets with 1 telecom plate, see options below for telecom plate
- Ships KD
- Wire management tray attaches to worksurface top, standard in MFW White, see premium Metal Finish for options
- Hardwire infeed and jumpers are included in workstations
- T75 worksurface wire cutout is standard on all worksurfaces.(T75D: Delete cutout is optional)

Options

Accessories

- K28: Articulating Keyboard w/ Mouse - \$390
- K31-SK: Center drawer w/ skirt - \$310
- K31: Center drawer w/o skirt - \$205

Concealed Floor Power Infeed Cover

- PCEB: White Metal Finish concealed floor power infeed cover - \$150

Delete Top and Wire Tray

- DFP: Delete fixed top. Deduct \$1535 Veneer (W), \$1335 High Pressure Laminate (G), \$953 Thermally Fused Laminate (M) per top

Metal Feet

- MTL10: Replace solid wood feet with metal feet, standard MFW White - \$55 ea

Premium Metal Finish

- Specify premium Metal Finish. MFMB: Matte Black, MFS: Silver, MFSS: Salmon Sienna, MFSA: SurfIn Aquavert, MFPS: Pistachio, MFOS: Oyster, MFNA: Navy, MFOL: Olive, MFGB: Grey Beige MFGG: Graphite Gray, MFG: Gray, MFGM:Matte Gold
- Premium Metal Finish for WMT Wire Management Tray - \$75 ea
- Premium Metal Finish for MTL10 Metal Feet - \$20 ea
- Premium Metal Finish for PCEB Concealed Floor Power Infeed Cover - \$35

Starter Panel

- RSP: Substitute round starter panel in place of flat starter panel. Must substitute all starters, priced per starter panel - \$83 each. See HNY3555SP888

Telecom Plates

- Each power unit has 1 plate. All telecom connectors sold separately.
- RJ45 (1) - \$55, RJ45 (2) - \$110, RJ45 (3) - \$165, USB (1) - \$70, USB (2) - \$140, RJ45/USB - \$125, RJ45/HDMI - \$210, HDMI/USB - \$205

Worksurface Height

- THL-42: Modify worksurface height to bar height - N/C

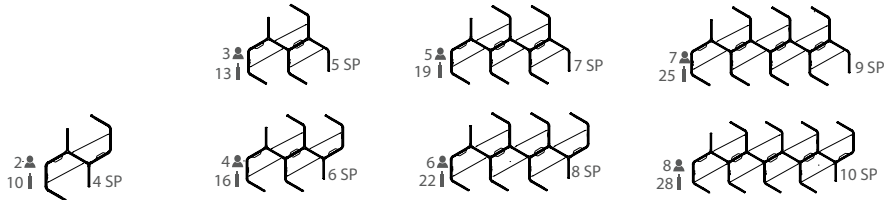

Number of Feet per Typical (MTL10 Option) "SP" Number of Starter Panels per Typical (RSP Option)

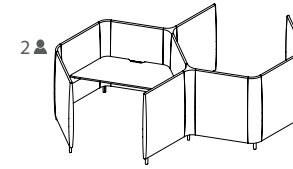

Height Adjustable Workstation

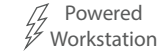

Powered Workstation

1 Select Model

w" x d" x h"	Weight	Standard Veneer Top Upholstered Panels - COM\$	Premium Veneer Top Upholstered Panels - COM\$	High Pressure Laminate Top Upholstered Panels - COM\$	Thermally Fused Laminate Top Upholstered Panels - COM\$
340 x 150 x 55	103	8 HNY340150HA580W 71969	"P" Option N/A	HNY340150HA580G 70361	HNY340150HA580M 67305
303 x 150 x 55	92	7 HNY303150HA580W 63405	"P" Option N/A	HNY303150HA580G 61998	HNY303150HA580M 59324
265 x 150 x 55	80	6 HNY265150HA580W 55112	"P" Option N/A	HNY265150HA580G 53906	HNY265150HA580M 51614
228 x 150 x 55	69	5 HNY228150HA580W 46548	"P" Option N/A	HNY228150HA580G 45543	HNY228150HA580M 43633
191 x 150 x 55	57	4 HNY191150HA580W 38255	"P" Option N/A	HNY191150HA580G 37451	HNY191150HA580M 35923
153 x 150 x 55	46	3 HNY153150HA580W 29691	"P" Option N/A	HNY153150HA580G 29088	HNY153150HA580M 27942
116 x 150 x 55	34	2 HNY116150HA580W 21398	"P" Option N/A	HNY116150HA580G 20996	HNY116150HA580M 20232

[Click Here for Graded in Pricing](#)

2 Select Finish

Click to view finishes

WWP	WOW
PO01	WNO
PO02	WSO
PO03	WNF(Natural Oak on Flat Cut)
PO07	WSF(Salted Oak on Flat Cut)
PO08	WSF(Salted Oak on Flat Cut)
PO09	WSF(Salted Oak on Flat Cut)
WBW	
WSW	
WEC	

3 Select Feet Finish

Click to view edges

WWP	WOW
PO01	WNO
PO02	WSO
PO03	
PO07	
PO08	
PO09	
WBW	
WSW	
WEC	

4 Select Edge

Click to view details



GEC	LW04
GNA +5%	LW05
GWL	LW06
LP01	
LF02	
LF03	
LN01	
LA02	
LW01	
LW02	

WWP	WOW
PO01	WNO
PO02	WSO
PO03	
PO07	
PO08	
PO09	
WBW	
WSW	
WEC	



MOC
MEC
MSW
MTW
MWL
MNA

WWP	WOW
PO01	WNO
PO02	WSO
PO03	
PO07	
PO08	
PO09	
WEC	
WBW	
WSW	



[Click here to view statement of line](#)

Product Features

- 5" Solid wood feet - oval shape, ships KD
- 4 Power outlets with 1 telecom plate, see options below for telecom plate
- Adjustable height from 27" to 47.5" with a maximum weight capacity of 275 lbs.
- Lift standard in MFW White, optional MFB Black
- HNY7125WT163 Height Adjustable worksurfaces are included
- Wire management tray attaches to worksurface top, standard in MFW White, see premium Metal Finish for options
- T75 worksurface wire cutout is standard on all worksurfaces.(T75D: Delete cutout is optional)

Notes

- 1" Gap between worksurface and panels to drop wires below worksurface
- Metal parts include 5 year warranty
- Programmable height adjustable mechanism, motor includes 2 year warranty

Options

Accessories

- K28: Articulating Keyboard w/ Mouse - \$390
- K31-SK: Center drawer w/ skirt - \$310
- K31: Center drawer w/o skirt - \$205

Concealed Floor Power Infeed Cover

- PCEB: White Metal Finish concealed floor power infeed cover - \$150

Delete Top and Wire Tray

- DHAT: Delete height adjustable top. Deduct \$3845 Veneer(W), \$3644 High Pressure Laminate(G), \$3262 Thermally Fused Laminate(M) per top

Metal Feet

- MTL10: Replace solid wood feet with metal feet, standard MFW White - \$55 ea

Premium Metal Finish

- Specify premium Metal Finish. MFMB: Matte Black, MFS: Silver, MFSS: Salmon Sienna, MFSA: Surfin Aquavert, MFPS: Pistachio, MFOS: Oyster, MFNA: Navy, MFOL: Olive, MFGB: Grey Beige MFGG: Graphite Gray, MFG: Gray, MFGM:Matte Gold
- Premium Metal Finish for WMT Wire Management Tray - \$75 ea
- Premium Metal Finish for MTL10 Metal Feet - \$20 ea
- Premium Metal Finish for PCEB Concealed Floor Power Infeed Cover - \$35

Starter Panel

- RSP: Substitute round starter panel in place of flat starter panel. Must substitute all starters, priced per starter panel - \$83 each. See HNY3555SP888

Telecom Plates

- Each power unit has 1 plate. All telecom connectors sold separately.
- RJ45 (1) - \$55, RJ45 (2) - \$110, RJ45 (3) - \$165, USB (1) - \$70, USB (2) - \$140, RJ45/USB - \$125, RJ45/HDMI - \$210, HDMI/USB - \$205

DARRAN

Honey

Double Hexagon Workstation Typical
Position 2 Desk with Fixed Worksurface

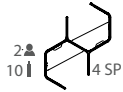

2 10 4 SP

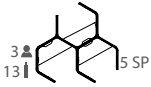

3 13 5 SP

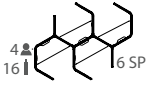

4 16 6 SP

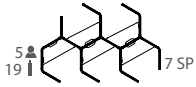

5 19 7 SP

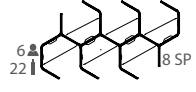

6 22 8 SP

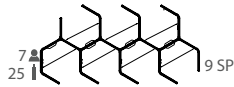

7 25 9 SP

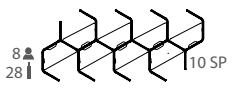

8 28 10 SP

Number of Feet per Typical (MTL10 Option) "SP" Number of Starter Panels per Typical (RSP Option)

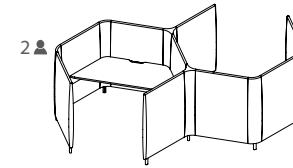

2



Fixed Top Workstation



Non-Powered Workstation

1 Select Model

w" x d" x h"	Weight	Standard Veneer Top Upholstered Panels - COM\$	Premium Veneer Top Upholstered Panels - COM\$	High Pressure Laminate Top Upholstered Panels - COM\$	Thermally Fused Laminate Top Upholstered Panels - COM\$
340 x 150 x 55	103	8 HNY340150FT580W 50492	"P" Option N/A	HNY340150FT580G 48892	HNY340150FT580M 45836
303 x 150 x 55	92	7 HNY303150FT580W 44690	"P" Option N/A	HNY303150FT580G 43290	HNY303150FT580M 40616
265 x 150 x 55	80	6 HNY265150FT580W 38888	"P" Option N/A	HNY265150FT580G 37688	HNY265150FT580M 35396
228 x 150 x 55	69	5 HNY228150FT580W 33086	"P" Option N/A	HNY228150FT580G 32086	HNY228150FT580M 30176
191 x 150 x 55	57	4 HNY191150FT580W 27284	"P" Option N/A	HNY191150FT580G 26484	HNY191150FT580M 24956
153 x 150 x 55	46	3 HNY153150FT580W 21482	"P" Option N/A	HNY153150FT580G 20882	HNY153150FT580M 19736
116 x 150 x 55	34	2 HNY116150FT580W 15680	"P" Option N/A	HNY116150FT580G 15280	HNY116150FT580M 14516

2 Select Finish

Click to view finishes

WWP	WOW
PO01	WNO
PO02	WSO
PO03	WNF(Natural Oak on Flat Cut)
PO07	WSF(Salted Oak on Flat Cut)
PO08	WSF(Salted Oak on Flat Cut)
PO09	WSF(Salted Oak on Flat Cut)
WBW	
WSW	
WEC	

3 Select Feet Finish

Click to view edges

WWP	WOW
PO01	WNO
PO02	WSO
PO03	
PO07	
PO08	
PO09	
WBW	
WSW	
WEC	

4 Select Edge

Click to view details



Cliff-1 Veneer, Cliff-2 Black, Cliff-3 White



Flat-1 Veneer, Flat-2 Black, Flat-3 White

GEC	LW04
GNA +5%	LW05
GWL	LW06
LP01	
LF02	
LF03	
LN01	
LA02	
LW01	
LW02	

WWP	WOW
PO01	WNO
PO02	WSO
PO03	
PO07	
PO08	
PO09	
WBW	
WSW	
WEC	



Cliff-1 Matching, Cliff-2 Black, Cliff-3 White



Flat-1 Matching, Flat-2 Black, Flat-3 White

MOC
MEC
MSW
MTW
MWL
MNA

WWP	WOW
PO01	WNO
PO02	WSO
PO03	
PO07	
PO08	
PO09	
WBW	
WSW	



Flat-2 Black, Flat-3 White, Flat-4 Matching

Click here to view statement of line

Product Features

- 5" Solid wood feet - oval shape
- HNY7226WT162 Fixed Desk Height worksurfaces, 29" worksurface height
- Ships KD
- T75 worksurface wire cutout is standard on all worksurfaces.(T75D: Delete cutout is optional)

Options

Accessories

- K28: Articulating Keyboard w/ Mouse - \$390
- K31-SK: Center drawer w/ skirt - \$310
- K31: Center drawer w/o skirt - \$205

Concealed Floor Power Infeed Cover

- PCEB: White Metal Finish concealed floor power infeed cover - \$150

Delete Top

- DFT: Delete fixed top. Deduct \$1325 Veneer(W), \$1125 High Pressure Laminate (G), \$743 Thermally Fused Laminate (M) per top

Metal Feet

- MTL10: Replace solid wood feet with metal feet, standard MFW White - \$55 ea

Premium Metal Finish

- Specify premium Metal Finish. MFMB: Matte Black, MFS: Silver, MFSS: Salmon Sienna, MFSA: Surfing Aquavert, MFPS: Pistachio, MFOS: Oyster, MFNA: Navy, MFOL: Olive, MFGB: Grey Beige MFGG: Graphite Gray, MFG: Gray, MFGM:Matte Gold
- Premium Metal Finish for WMT Wire Management Tray - \$75 ea
- Premium Metal Finish for MTL10 Metal Feet - \$20 ea
- Premium Metal Finish for PCEB Concealed Floor Power Infeed Cover - \$35

Starter Panel

- RSP: Substitute round starter panel in place of flat starter panel. Must substitute all starters, priced per starter panel - \$83 each. See HNY3555SP888

Worksurface Height

- Modify worksurface height to bar height.
- THL-42: Position worksurface at bar height - N/C

Wire Tray

- WMT: Wire metal tray. Mounts under top and comes standard in MFW White - \$210

DARRAN®

Honey

Double Hexagon Workstation Typical
Position 2 Desk with Power Fixed Worksurface

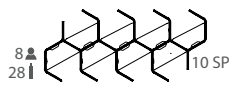
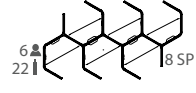
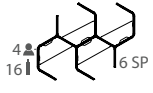
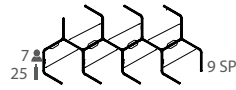
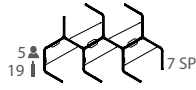
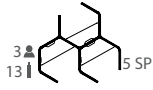
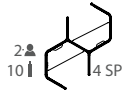

Number of Feet per Typical (MTL10 Option) "SP" Number of Starter Panels per Typical (RSP Option)

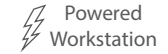
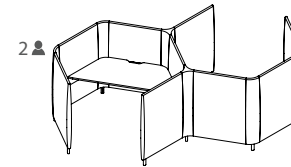

1 Select Model

w" x d" x h"	Weight	Standard Veneer Top Upholstered Panels - COM\$	Premium Veneer Top Upholstered Panels - COM\$	High Pressure Laminate Top Upholstered Panels - COM\$	Thermally Fused Laminate Top Upholstered Panels - COM\$
340 x 150 x 55	103	8 HNY340150FP580W 53641	"P" Option N/A	HNY340150FP580G 52041	HNY340150FP580M 48985
303 x 150 x 55	92	7 HNY303150FP580W 47368	"P" Option N/A	HNY303150FP580G 45968	HNY303150FP580M 43294
265 x 150 x 55	80	6 HNY265150FP580W 41366	"P" Option N/A	HNY265150FP580G 40166	HNY265150FP580M 37874
228 x 150 x 55	69	5 HNY228150FP580W 35093	"P" Option N/A	HNY228150FP580G 34093	HNY228150FP580M 32183
191 x 150 x 55	57	4 HNY191150FP580W 29091	"P" Option N/A	HNY191150FP580G 28291	HNY191150FP580M 26763
153 x 150 x 55	46	3 HNY153150FP580W 22818	"P" Option N/A	HNY153150FP580G 22218	HNY153150FP580M 21072
116 x 150 x 55	34	2 HNY116150FP580W 16816	"P" Option N/A	HNY116150FP580G 16416	HNY116150FP580M 15652

[Click Here for Graded in Pricing](#)

2 Select Finish

Click to view finishes

WWP	WOW
PO01	WNO
PO02	WSO
PO03	WNF(Natural Oak on Flat Cut)
PO07	WSF(Salted Oak on Flat Cut)
PO08	WSF(Salted Oak on Flat Cut)
PO09	WSF(Salted Oak on Flat Cut)
WBW	
WSW	
WEC	

3 Select Feet Finish

Click to view edges

WWP	WOW
PO01	WNO
PO02	WSO
PO03	
PO07	
PO08	
PO09	
WBW	
WSW	
WEC	

4 Select Edge

Click to view details



GEC	LW04
GNA +5%	LW05
GWL	LW06
LP01	
LF02	
LF03	
LN01	
LA02	
LW01	
LW02	

WWP	WOW
PO01	WNO
PO02	WSO
PO03	
PO07	
PO08	
PO09	
WBW	
WSW	
WEC	



MOC
MEC
MSW
MTW
MWL
MNA

WWP	WOW
PO01	WNO
PO02	WSO
PO03	
PO07	
PO08	
PO09	
WEC	
WBW	
WSW	



[Click here to view statement of line](#)

Product Features

- HNY7226WT162 Fixed Desk Height worksurfaces, 29" worksurface height
- 5" Solid wood feet - oval shape
- 4 Power outlets with 1 telecom plate, see options below for telecom plate
- Ships KD
- Wire management tray attaches to worksurface top, standard in MFW White, see premium Metal Finish for options
- Hardwire infeed and jumpers are included in workstations
- T75 worksurface wire cutout is standard on all worksurfaces.(T75D: Delete cutout is optional)

Options

Accessories

- K28: Articulating Keyboard w/ Mouse - \$390
- K31-SK: Center drawer w/ skirt - \$310
- K31: Center drawer w/o skirt - \$205

Concealed Floor Power Infeed Cover

- PCEB: White Metal Finish concealed floor power infeed cover - \$150

Delete Top and Wire Tray

- DFP: Delete fixed top. Deduct \$1535 Veneer (W), \$1335 High Pressure Laminate (G), \$953 Thermally Fused Laminate (M) per top

Metal Feet

- MTL10: Replace solid wood feet with metal feet, standard MFW White - \$55 ea

Premium Metal Finish

- Specify premium Metal Finish. MFMB: Matte Black, MFS: Silver, MFSS: Salmon Sienna, MFSA: Surfing Aquavert, MFPS: Pistachio, MFOS: Oyster, MFNA: Navy, MFOL: Olive, MFGB: Grey Beige MFGG: Graphite Gray, MFG: Gray, MFGM:Matte Gold
- Premium Metal Finish for WMT Wire Management Tray - \$75 ea
- Premium Metal Finish for MTL10 Metal Feet - \$20 ea
- Premium Metal Finish for PCEB Concealed Floor Power Infeed Cover - \$35

Starter Panel

- RSP: Substitute round starter panel in place of flat starter panel. Must substitute all starters, priced per starter panel - \$83 each. See HNY3555SP888

Telecom Plates

- Each power unit has 1 plate. All telecom connectors sold separately.
- RJ45 (1) - \$55, RJ45 (2) - \$110, RJ45 (3) - \$165, USB (1) - \$70, USB (2) - \$140, RJ45/USB - \$125, RJ45/HDMI - \$210, HDMI/USB - \$205

Worksurface Height

- THL-42: Modify worksurface height to bar height - N/C

DARRAN

Honey

Double Hexagon Workstation Typical
Position 3 Desk with Height Adjustable Worksurface

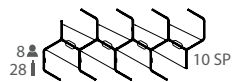
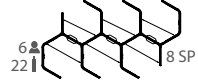
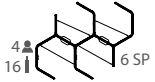
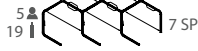
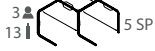
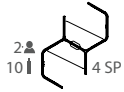

Number of Feet per Typical (MTL10 Option) "SP" Number of Starter Panels per Typical (RSP Option)

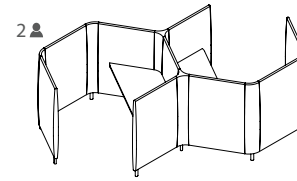

Height Adjustable Workstation

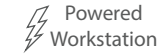

1 Select Model

w" x d" x h"	Weight	Standard Veneer Top Upholstered Panels - COM\$	Premium Veneer Top Upholstered Panels - COM\$	High Pressure Laminate Top Upholstered Panels - COM\$	Thermally Fused Laminate Top Upholstered Panels - COM\$
340 x 150 x 55	103	8 HNY340150HA581W 71698	"P" Option N/A	HNY340150HA581G 70090	HNY340150HA581M 67034
303 x 150 x 55	92	7 HNY303150HA581W 63405	"P" Option N/A	HNY303150HA581G 61998	HNY303150HA581M 59324
265 x 150 x 55	80	6 HNY265150HA581W 54841	"P" Option N/A	HNY265150HA581G 53635	HNY265150HA581M 51343
228 x 150 x 55	69	5 HNY228150HA581W 46548	"P" Option N/A	HNY228150HA581G 45543	HNY228150HA581M 43633
191 x 150 x 55	57	4 HNY191150HA581W 37984	"P" Option N/A	HNY191150HA581G 37180	HNY191150HA581M 35652
153 x 150 x 55	46	3 HNY153150HA581W 29691	"P" Option N/A	HNY153150HA581G 29088	HNY153150HA581M 27942
116 x 150 x 55	34	2 HNY116150HA581W 21127	"P" Option N/A	HNY116150HA581G 20725	HNY116150HA581M 19961

[Click Here for Graded in Pricing](#)

2 Select Finish

Click to view finishes

WWP	WOW
PO01	WNO
PO02	WSO
PO03	WNF(Natural Oak on Flat Cut)
PO07	WSF(Salted Oak on Flat Cut)
PO08	WSF(Salted Oak on Flat Cut)
PO09	WSF(Salted Oak on Flat Cut)
WBW	
WSW	
WEC	

3 Select Feet Finish

Click to view edges

WWP	WOW
PO01	WNO
PO02	WSO
PO03	
PO07	
PO08	
PO09	
WBW	
WSW	
WEC	

4 Select Edge

Click to view details



[Click here to view statement of line](#)

Product Features

- 5" Solid wood feet - oval shape, ships KD
- 4 Power outlets with 1 telecom plate, see options below for telecom plate
- Adjustable height from 27" to 47.5" with a maximum weight capacity of 275 lbs. Lift standard in MFW White, optional MFB Black
- HNY7125WT163 Height Adjustable worksurfaces are included
- Wire management tray attaches to worksurface top, standard in MFW White, see premium Metal Finish for options
- T75 worksurface wire cutout is standard on all worksurfaces.(T75D: Delete cutout is optional)

Notes

- 1" Gap between worksurface and panels to drop wires below worksurface
- Metal parts include 5 year warranty
- Programmable height adjustable mechanism, motor includes 2 year warranty

Options

Accessories

- K28: Articulating Keyboard w/ Mouse - \$390
- K31-SK: Center drawer w/ skirt - \$310
- K31: Center drawer w/o skirt - \$205

Concealed Floor Power Infeed Cover

- PCEB: White Metal Finish concealed floor power infeed cover - \$150

Delete Top and Wire Tray

- DHAT: Delete height adjustable top. Deduct \$3845 Veneer(W), \$3644 High Pressure Laminate(G), \$3262 Thermally Fused Laminate(M) per top

Metal Feet

- MTL10: Replace solid wood feet with metal feet, standard MFW White - \$55 ea

Premium Metal Finish

- Specify premium Metal Finish. MFMB: Matte Black, MFS: Silver, MFSS: Salmon Sienna, MFSA: Surfin Aquavert, MFPS: Pistachio, MFOS: Oyster, MFNA: Navy, MFOL: Olive, MFGB: Grey Beige MFGG: Graphite Gray, MFG: Gray, MFGM:Matte Gold
- Premium Metal Finish for WMT Wire Management Tray - \$75 ea
- Premium Metal Finish for MTL10 Metal Feet - \$20 ea
- Premium Metal Finish for PCEB Concealed Floor Power Infeed Cover - \$35

Starter Panel

- RSP: Substitute round starter panel in place of flat starter panel. Must substitute all starters, priced per starter panel - \$83 each. See HNY3555SP888

Telecom Plates

- Each power unit has 1 plate. All telecom connectors sold separately.
- RJ45 (1) - \$55, RJ45 (2) - \$110, RJ45 (3) - \$165, USB (1) - \$70, USB (2) - \$140, RJ45/USB - \$125, RJ45/HDMI - \$210, HDMI/USB - \$205

DARRAN

Honey

Double Hexagon Workstation Typical
Position 3 Desk with Fixed Worksurface

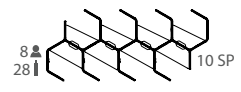
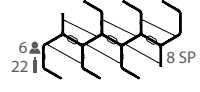
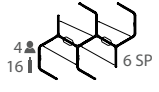
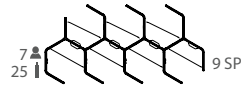
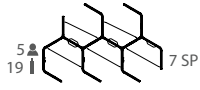
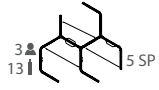
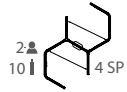

Number of Feet per Typical (MTL10 Option) "SP" Number of Starter Panels per Typical (RSP Option)

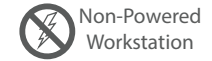
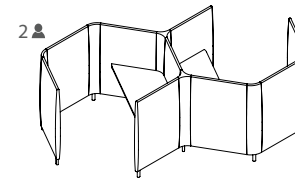

1 Select Model

w" x d" x h"	Weight	Standard Veneer Top Upholstered Panels - COM\$	Premium Veneer Top Upholstered Panels - COM\$
340 x 150 x 55	103	8 HNY340150FT581W 50492	"P" Option N/A
303 x 150 x 55	92	7 HNY303150FT581W 44690	"P" Option N/A
265 x 150 x 55	80	6 HNY265150FT581W 38888	"P" Option N/A
228 x 150 x 55	69	5 HNY228150FT581W 33086	"P" Option N/A
191 x 150 x 55	57	4 HNY191150FT581W 27284	"P" Option N/A
153 x 150 x 55	46	3 HNY153150FT581W 21482	"P" Option N/A
116 x 150 x 55	34	2 HNY116150FT581W 15680	"P" Option N/A

[Click Here for Graded in Pricing](#)

2 Select Finish

Click to view finishes

WWP	WOW
PO01	WNO
PO02	WSO
PO03	WNF(Natural Oak on Flat Cut)
PO07	WSF(Salted Oak on Flat Cut)
PO08	
PO09	
WBW	
WSW	
WEC	

3 Select Feet Finish

Click to view edges

WWP	WOW
PO01	WNO
PO02	WSO
PO03	
PO07	
PO08	
PO09	
WBW	
WSW	
WEC	

4 Select Edge

Click to view details



High Pressure Laminate Top Upholstered Panels - COM\$

HNY340150FT581G	48892
HNY303150FT581G	43290
HNY265150FT581G	37688
HNY228150FT581G	32086
HNY191150FT581G	26484
HNY153150FT581G	20882
HNY116150FT581G	15280

GEC	LW04
GNA +5%	LW05
GWL	LW06
LP01	
LF02	
LF03	
LN01	
LA02	
LW01	
LW02	

WWP	WOW
PO01	WNO
PO02	WSO
PO03	
PO07	
PO08	
PO09	
WBW	
WSW	
WEC	



Thermally Fused Laminate Top Upholstered Panels - COM\$

HNY340150FT581M	45836
HNY303150FT581M	40616
HNY265150FT581M	35396
HNY228150FT581M	30176
HNY191150FT581M	24956
HNY153150FT581M	19736
HNY116150FT581M	14516

MOC
MEC
MSW
MTW
MWL
MNA

WWP	WOW
PO01	WNO
PO02	WSO
PO03	
PO07	
PO08	
PO09	
WBW	
WSW	



[Click here to view statement of line](#)

Product Features

- 5" Solid wood feet - oval shape
- HNY7226WT162 Fixed Desk Height worksurfaces, 29" worksurface height
- Ships KD
- T75 worksurface wire cutout is standard on all worksurfaces.(T75D: Delete cutout is optional)

Options

Accessories

- K28: Articulating Keyboard w/ Mouse - \$390
- K31-SK: Center drawer w/ skirt - \$310
- K31: Center drawer w/o skirt - \$205

Concealed Floor Power Infeed Cover

- PCEB: White Metal Finish concealed floor power infeed cover - \$150

Delete Top

- DFT: Delete fixed top. Deduct \$1325 Veneer(W), \$1125 High Pressure Laminate (G), \$743 Thermally Fused Laminate (M) per top

Metal Feet

- MTL10: Replace solid wood feet with metal feet, standard MFW White - \$55 ea

Premium Metal Finish

- Specify premium Metal Finish. MFMB: Matte Black, MFS: Silver, MFSS: Salmon Sienna, MFSA: Surfing Aquavert, MFPS: Pistachio, MFOS: Oyster, MFNA: Navy, MFOL: Olive, MFGB: Grey Beige MFGG: Graphite Gray, MFG: Gray, MFGM:Matte Gold
- Premium Metal Finish for WMT Wire Management Tray - \$75 ea
- Premium Metal Finish for MTL10 Metal Feet - \$20 ea
- Premium Metal Finish for PCEB Concealed Floor Power Infeed Cover - \$35

Starter Panel

- RSP: Substitute round starter panel in place of flat starter panel. Must substitute all starters, priced per starter panel - \$83 each. See HNY3555SP888

Worksurface Height

- Modify worksurface height to bar height.
- THL-42: Position worksurface at bar height - N/C

Wire Tray

- WMT: Wire metal tray. Mounts under top and comes standard in MFW White - \$210

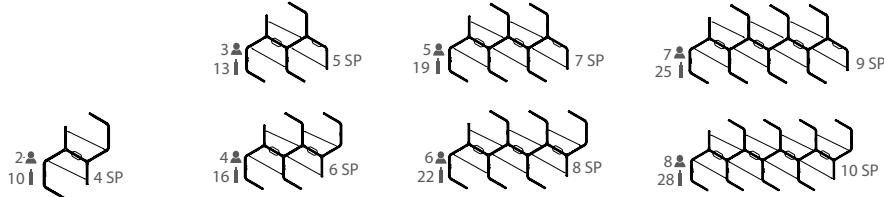

Number of Feet per Typical (MTL10 Option) "SP" Number of Starter Panels per Typical (RSP Option)

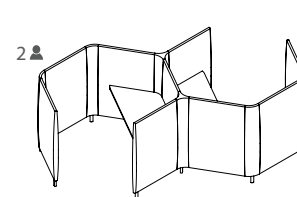

Fixed Top Workstation

Powered Workstation

1 Select Model

w" x d" x h"	Weight	Standard Veneer Top Upholstered Panels - COM\$	Premium Veneer Top Upholstered Panels - COM\$
340 x 150 x 55	103	8 HNY340150FP581W 53370	"P" Option N/A
303 x 150 x 55	92	7 HNY303150FP581W 47368	"P" Option N/A
265 x 150 x 55	80	6 HNY265150FP581W 41095	"P" Option N/A
228 x 150 x 55	69	5 HNY228150FP581W 35093	"P" Option N/A
191 x 150 x 55	57	4 HNY191150FP581W 28820	"P" Option N/A
153 x 150 x 55	46	3 HNY153150FP581W 22818	"P" Option N/A
116 x 150 x 55	34	2 HNY116150FP581W 16545	"P" Option N/A

[Click Here for Graded in Pricing](#)

2 Select Finish

Click to view finishes

WWP	WOW
PO01	WNO
PO02	WSO
PO03	WNF(Natural Oak on Flat Cut)
PO07	WSF(Salted Oak on Flat Cut)
PO08	WSF(Salted Oak on Flat Cut)
PO09	WSF(Salted Oak on Flat Cut)
WBW	
WSW	
WEC	

3 Select Feet Finish

Click to view edges

WWP	WOW
PO01	WNO
PO02	WSO
PO03	
PO07	
PO08	
PO09	
WBW	
WSW	
WEC	

4 Select Edge

Click to view details



High Pressure Laminate Top Upholstered Panels - COM\$

HNY340150FP581G	51770
HNY303150FP581G	45968
HNY265150FP581G	39895
HNY228150FP581G	34093
HNY191150FP581G	28020
HNY153150FP581G	22218
HNY116150FP581G	16145

GEC	LW04
GNA +5%	LW05
GWL	LW06
LP01	
LF02	
LF03	
LN01	
LA02	
LW01	
LW02	

WWP	WOW
PO01	WNO
PO02	WSO
PO03	
PO07	
PO08	
PO09	
WBW	
WSW	
WEC	

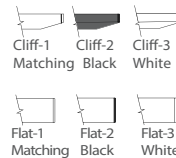

Thermally Fused Laminate Top Upholstered Panels - COM\$

HNY340150FP581M	48714
HNY303150FP581M	43294
HNY265150FP581M	37603
HNY228150FP581M	32183
HNY191150FP581M	26492
HNY153150FP581M	21072
HNY116150FP581M	15381

MOC
MEC
MSW
MTW
MWL
MNA

WWP	WOW
PO01	WNO
PO02	WSO
PO03	
PO07	
PO08	
PO09	
WEC	
WBW	
WSW	



[Click here to view statement of line](#)

Product Features

- HNY7226WT162 Fixed Desk Height worksurfaces, 29" worksurface height
- 5" Solid wood feet - oval shape
- 4 Power outlets with 1 telecom plate, see options below for telecom plate
- Ships KD
- Wire management tray attaches to worksurface top, standard in MFW White, see premium Metal Finish for options
- Hardwire infeed and jumpers are included in workstations
- T75 worksurface wire cutout is standard on all worksurfaces.(T75D: Delete cutout is optional)

Options

Accessories

- K28: Articulating Keyboard w/ Mouse - \$390
- K31-SK: Center drawer w/ skirt - \$310
- K31: Center drawer w/o skirt - \$205

Concealed Floor Power Infeed Cover

- PCEB: White Metal Finish concealed floor power infeed cover - \$150

Delete Top and Wire Tray

- DFP: Delete fixed top. Deduct \$1535 Veneer (W), \$1335 High Pressure Laminate (G), \$953 Thermally Fused Laminate (M) per top

Metal Feet

- MTL10: Replace solid wood feet with metal feet, standard MFW White - \$55 ea

Premium Metal Finish

- Specify premium Metal Finish. MFMB: Matte Black, MFS: Silver, MFSS: Salmon Sienna, MFSA: Surfing Aquavert, MFPS: Pistachio, MFOS: Oyster, MFNA: Navy, MFOL: Olive, MFGB: Grey Beige MFGG: Graphite Gray, MFG: Gray, MFGM:Matte Gold
- Premium Metal Finish for WMT Wire Management Tray - \$75 ea
- Premium Metal Finish for MTL10 Metal Feet - \$20 ea
- Premium Metal Finish for PCEB Concealed Floor Power Infeed Cover - \$35

Starter Panel

- RSP: Substitute round starter panel in place of flat starter panel. Must substitute all starters, priced per starter panel - \$83 each. See HNY3555SP888

Telecom Plates

- Each power unit has 1 plate. All telecom connectors sold separately.
- RJ45 (1) - \$55, RJ45 (2) - \$110, RJ45 (3) - \$165, USB (1) - \$70, USB (2) - \$140, RJ45/USB - \$125, RJ45/HDMI - \$210, HDMI/USB - \$205

Worksurface Height

- THL-42: Modify worksurface height to bar height - N/C

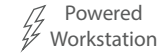
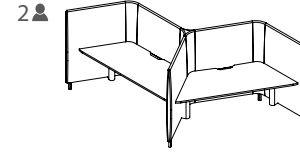
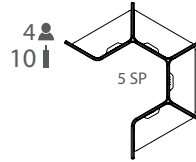
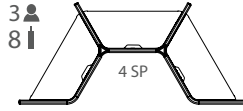
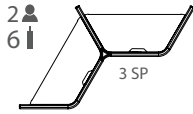

Number of Feet per Typical (MTL10 Option) "SP" Number of Starter Panels per Typical (RSP Option)

1 Select Model

w" x d" x h"	Weight	Standard Veneer Top Upholstered Panels - COM\$	Premium Veneer Top Upholstered Panels - COM\$	High Pressure Laminate Top Upholstered Panels - COM\$	Thermally Fused Laminate Top Upholstered Panels - COM\$
166 x 145 x 55	34	4 HNY166145HA582W 29027	"P" Option N/A	HNY166145HA582G 28223	HNY166145HA582M 26695
166 x 74 x 55	26	3 HNY16674HA582W 22174	"P" Option N/A	HNY16674HA582G 21571	HNY16674HA582M 20425
125 x 74 x 55	19	2 HNY12574HA582W 15321	"P" Option N/A	HNY12574HA582G 14919	HNY12574HA582M 14155
85 x 37 x 55	11	1 HNY8537HA582W 8468	"P" Option N/A	HNY8537HA582G 8267	HNY8537HA582M 7885

[Click Here for Graded in Pricing](#)

2 Select Finish

Click to view finishes

WWP	WOW
PO01	WNO
PO02	WSO
PO03	WNF(Natural Oak on Flat Cut)
PO07	WSF(Salted Oak on Flat Cut)
PO08	WSF(Salted Oak on Flat Cut)
PO09	WSF(Salted Oak on Flat Cut)
WBW	
WSW	
WEC	

3 Select Feet Finish

Click to view edges

WWP	WOW
PO01	WNO
PO02	WSO
PO03	
PO07	
PO08	
PO09	
WBW	
WSW	
WEC	

4 Select Edge

Click to view details

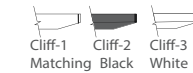

[Click here to view statement of line](#)

Product Features

- 5" Solid wood feet - oval shape, ships KD
- 4 Power outlets with 1 telecom plate, see options below for telecom plate
- Adjustable height from 27" to 47.5" with a maximum weight capacity of 275 lbs.
- Lift standard in MFW White, optional MFB Black
- HNY7125WT163 Height Adjustable worksurfaces are included
- Wire management tray attaches to worksurface top, standard in MFW White, see premium Metal Finish for options
- T75 worksurface wire cutout is standard on all worksurfaces.(T75D: Delete cutout is optional)

Notes

- 1" Gap between worksurface and panels to drop wires below worksurface
- Metal parts include 5 year warranty
- Programmable height adjustable mechanism, motor includes 2 year warranty

Options

Accessories

- K28: Articulating Keyboard w/ Mouse - \$390
- K31-SK: Center drawer w/ skirt - \$310
- K31: Center drawer w/o skirt - \$205

Concealed Floor Power Infeed Cover

- PCEB: White Metal Finish concealed floor power infeed cover - \$150

Delete Top and Wire Tray

- DHAT: Delete height adjustable top. Deduct \$3845 Veneer(W), \$3644 High Pressure Laminate(G), \$3262 Thermally Fused Laminate(M) per top

Metal Feet

- MTL10: Replace solid wood feet with metal feet, standard MFW White - \$55 ea

Premium Metal Finish

- Specify premium Metal Finish. MFMB: Matte Black, MFS: Silver, MFSS: Salmon Sienna, MFSA: Surfing Aquavert, MFPS: Pistachio, MFOS: Oyster, MFNA: Navy, MFOL: Olive, MFGB: Grey Beige MFGG: Graphite Gray, MFG: Gray, MFGM:Matte Gold
- Premium Metal Finish for WMT Wire Management Tray - \$75 ea
- Premium Metal Finish for MTL10 Metal Feet - \$20 ea
- Premium Metal Finish for PCEB Concealed Floor Power Infeed Cover - \$35

Starter Panel

- RSP: Substitute round starter panel in place of flat starter panel. Must substitute all starters, priced per starter panel - \$83 each. See HNY3555SP888

Telecom Plates

- Each power unit has 1 plate. All telecom connectors sold separately.
- RJ45 (1) - \$55, RJ45 (2) - \$110, RJ45 (3) - \$165, USB (1) - \$70, USB (2) - \$140, RJ45/USB - \$125, RJ45/HDMI - \$210, HDMI/USB - \$205

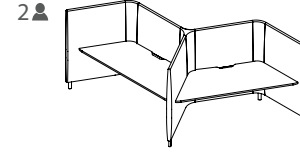
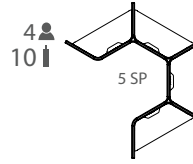
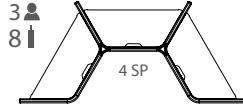
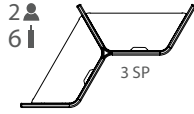

Number of Feet per Typical (MTL10 Option) "SP" Number of Starter Panels per Typical (RSP Option)

1 Select Model

w" x d" x h"	Weight	Standard Veneer Top Upholstered Panels - COM\$	Premium Veneer Top Upholstered Panels - COM\$
166 x 145 x 55	34	4 HNY166145FT582W 18290	"P" Option N/A
166 x 74 x 55	26	3 HNY16674FT582W 14070	"P" Option N/A
125 x 74 x 55	19	2 HNY12574FT582W 9850	"P" Option N/A
85 x 37 x 55	11	1 HNY8537FT582W 5630	"P" Option N/A

[Click Here for Graded in Pricing](#)

2 Select Finish

Click to view finishes

WWP	WOW
PO01	WNO
PO02	WSO
PO03	WNF(Natural Oak on Flat Cut)
PO07	WSF(Salted Oak on Flat Cut)
PO08	WSF(Salted Oak on Flat Cut)
PO09	WSF(Salted Oak on Flat Cut)
WBW	
WSW	
WEC	

3 Select Feet Finish

Click to view edges

WWP	WOW
PO01	WNO
PO02	WSO
PO03	
PO07	
PO08	
PO09	
WBW	
WSW	
WEC	

4 Select Edge

Click to view details

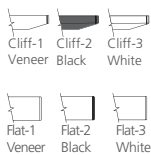

High Pressure Laminate Top Veneer CFTssis

HNY166145FT582G 17490
HNY16674FT582G 13470
HNY12574FT582G 9450
HNY8537FT582G 5430

GEC LW04
GNA +5% LW05
GWL LW06
LP01
LF02
LF03
LN01
LA02
LW01
LW02

WWP	WOW
PO01	WNO
PO02	WSO
PO03	
PO07	
PO08	
PO09	
WBW	
WSW	
WEC	

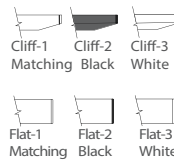

Thermally Fused Laminate Top Upholstered Panels - COM\$

HNY166145FT582M 15962
HNY16674FT582M 12324
HNY12574FT582M 8686
HNY8537FT582M 5048

MOC
MEC
MSW
MTW
MWL
MNA

WWP	WOW
PO01	WNO
PO02	WSO
PO03	
PO07	
PO08	
PO09	
WBW	
WSW	



[Click here to view statement of line](#)

Product Features

- 5" Solid wood feet - oval shape
- HNY7226WT162 Fixed Desk Height worksurfaces, 29" worksurface height
- Ships KD
- T75 worksurface wire cutout is standard on all worksurfaces.(T75D: Delete cutout is optional)

Options

Accessories

- K28: Articulating Keyboard w/ Mouse - \$390
- K31-SK: Center drawer w/ skirt - \$310
- K31: Center drawer w/o skirt - \$205

Concealed Floor Power Infeed Cover

- PCEB: White Metal Finish concealed floor power infeed cover - \$150

Delete Top

- DFT: Delete fixed top. Deduct \$1325 Veneer(W), \$1125 High Pressure Laminate (G), \$743 Thermally Fused Laminate (M) per top

Metal Feet

- MTL10: Replace solid wood feet with metal feet, standard MFW White - \$55 ea

Premium Metal Finish

- Specify premium Metal Finish. MFMB: Matte Black, MFS: Silver, MFSS: Salmon Sienna, MFSA: Surfing Aquavert, MFPS: Pistachio, MFOS: Oyster, MFNA: Navy, MFOL: Olive, MFGB: Grey Beige MFGG: Graphite Gray, MFG: Gray, MFGM:Matte Gold
- Premium Metal Finish for WMT Wire Management Tray - \$75 ea
- Premium Metal Finish for MTL10 Metal Feet - \$20 ea
- Premium Metal Finish for PCEB Concealed Floor Power Infeed Cover - \$35

Starter Panel

- RSP: Substitute round starter panel in place of flat starter panel. Must substitute all starters, priced per starter panel - \$83 each. See HNY3555SP888

Worksurface Height

- Modify worksurface height to bar height.
- THL-42: Position worksurface at bar height - N/C

Wire Tray

- WMT: Wire metal tray. Mounts under top and comes standard in MFW White - \$210

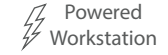
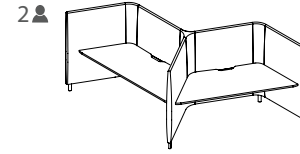
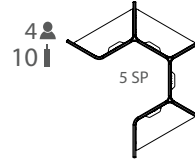
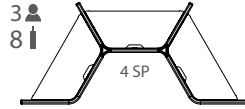
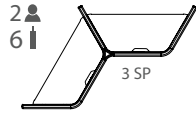

Number of Feet per Typical (MTL10 Option) "SP" Number of Starter Panels per Typical (RSP Option)

1 Select Model

Weight	Standard Veneer Top Upholstered Panels - COM\$
166 x 145 x 55	4 HNY166145FP582W 19863
166 x 74 x 55	3 HNY16674FP582W 15301
125 x 74 x 55	2 HNY12574FP582W 10739
85 x 37 x 55	1 HNY8537FP582W 6177

Premium Veneer Top Upholstered Panels - COM\$

"P" Option N/A
"P" Option N/A
"P" Option N/A
"P" Option N/A

High Pressure Laminate Top Upholstered Panels - COM\$

HNY166145FP582G 19063
HNY16674FP582G 14701
HNY12574FP582G 10339
HNY8537FP582G 5977

Thermally Fused Laminate Top Upholstered Panels - COM\$

HNY166145FP582M 17535
HNY16674FP582M 13555
HNY12574FP582M 9575
HNY8537FP582M 5595

Product Features

- HNY7226WT162 Fixed Desk Height worksurfaces, 29" worksurface height
- 5" Solid wood feet - oval shape
- 4 Power outlets with 1 telecom plate, see options below for telecom plate
- Ships KD
- Wire management tray attaches to worksurface top, standard in MFW White, see premium Metal Finish for options
- Hardwire infeed and jumpers are included in workstations
- T75 worksurface wire cutout is standard on all worksurfaces.(T75D: Delete cutout is optional)

Options

Accessories

- K28: Articulating Keyboard w/ Mouse - \$390
- K31-SK: Center drawer w/ skirt - \$310
- K31: Center drawer w/o skirt - \$205

Concealed Floor Power Infeed Cover

- PCEB: White Metal Finish concealed floor power infeed cover - \$150

Delete Top and Wire Tray

- DFP: Delete fixed top. Deduct \$1535 Veneer (W), \$1335 High Pressure Laminate (G), \$953 Thermally Fused Laminate (M) per top

Metal Feet

- MTL10: Replace solid wood feet with metal feet, standard MFW White - \$55 ea

Premium Metal Finish

- Specify premium Metal Finish. MFMB: Matte Black, MFS: Silver, MFSS: Salmon Sienna, MFSA: Surfing Aquavert, MFPS: Pistachio, MFOS: Oyster, MFNA: Navy, MFOL: Olive, MFGB: Grey Beige MFGG: Graphite Gray, MFG: Gray, MFGM:Matte Gold
- Premium Metal Finish for WMT Wire Management Tray - \$75 ea
- Premium Metal Finish for MTL10 Metal Feet - \$20 ea
- Premium Metal Finish for PCEB Concealed Floor Power Infeed Cover - \$35

Starter Panel

- RSP: Substitute round starter panel in place of flat starter panel. Must substitute all starters, priced per starter panel - \$83 each. See HNY3555SP888

Telecom Plates

- Each power unit has 1 plate. All telecom connectors sold separately.
- RJ45 (1) - \$55, RJ45 (2) - \$110, RJ45 (3) - \$165, USB (1) - \$70, USB (2) - \$140, RJ45/USB - \$125, RJ45/HDMI - \$210, HDMI/USB - \$205

Worksurface Height

- THL-42: Modify worksurface height to bar height - N/C

[Click Here for Graded in Pricing](#)

2 Select Finish

Click to view finishes

WWP	WOW
PO01	WNO
PO02	WSO
PO03	WNF(Natural Oak on Flat Cut)
PO07	WSF(Salted Oak on Flat Cut)
PO08	WSF(Salted Oak on Flat Cut)
PO09	WSF(Salted Oak on Flat Cut)
WBW	
WSW	
WEC	

3 Select Feet Finish

Click to view edges

WWP	WOW
PO01	WNO
PO02	WSO
PO03	
PO07	
PO08	
PO09	
WBW	
WSW	
WEC	

4 Select Edge

Click to view details

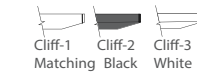

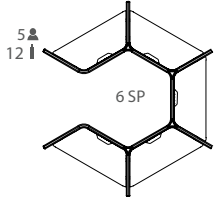

Number of Feet per Typical (MTL10 Option) "SP" Number of Starter Panels per Typical (RSP Option)

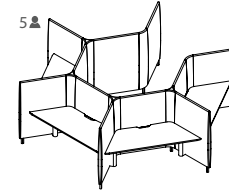

1 Select Model

w" x d" x h"	Weight	Standard Veneer Top Upholstered Panels - COM\$	Premium Veneer Top Upholstered Panels - COM\$
166 x 145 x 55	41	5 HNY166145HA583W 35880	"P" Option N/A

2 Select Finish

Click to view finishes

WWP	WOW
PO01	WNO
PO02	WSO
PO03	WNF(Natural Oak on Flat Cut)
PO07	WSF(Salted Oak on Flat Cut)
PO08	
PO09	
WBW	
WSW	
WEC	

3 Select Feet Finish

Click to view edges

WWP	WOW
PO01	WNO
PO02	WSO
PO03	
PO07	
PO08	
PO09	
WBW	
WSW	
WEC	

4 Select Edge

Click to view details

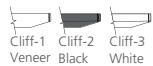

High Pressure Laminate Top Upholstered Panels - COM\$

HNY166145HA583G 34875

GEC	LW04
GNA +5%	LW05
GWL	LW06
LP01	
LF02	
LF03	
LN01	
LA02	
LW01	
LW02	

WWP	WOW
PO01	WNO
PO02	WSO
PO03	
PO07	
PO08	
PO09	
WBW	
WSW	
WEC	



Thermally Fused Laminate Top Upholstered Panels - COM\$

HNY166145HA583M 32965

MOC
MEC
MSW
MTW
MWL
MNA

WWP	WOW
PO01	WNO
PO02	WSO
PO03	
PO07	
PO08	
PO09	
WBW	
WSW	



Click here to view statement of line

Product Features

- 5" Solid wood feet - oval shape, ships KD
- 4 Power outlets with 1 telecom plate, see options below for telecom plate
- Adjustable height from 27" to 47.5" with a maximum weight capacity of 275 lbs. Lift standard in MFW White, optional MFB Black
- HNY7125WT163 Height Adjustable worksurfaces are included
- Wire management tray attaches to worksurface top, standard in MFW White, see premium Metal Finish for options
- T75 worksurface wire cutout is standard on all worksurfaces.(T75D: Delete cutout is optional)

Notes

- 1" Gap between worksurface and panels to drop wires below worksurface
- Metal parts include 5 year warranty
- Programmable height adjustable mechanism, motor includes 2 year warranty

Options

Accessories

- K28: Articulating Keyboard w/ Mouse - \$390
- K31-SK: Center drawer w/ skirt - \$310
- K31: Center drawer w/o skirt - \$205

Concealed Floor Power Infeed Cover

- PCEB: White Metal Finish concealed floor power infeed cover - \$150

Delete Top and Wire Tray

- DHAT: Delete height adjustable top. Deduct \$3845 Veneer(W), \$3644 High Pressure Laminate(G), \$3262 Thermally Fused Laminate(M) per top

Metal Feet

- MTL10: Replace solid wood feet with metal feet, standard MFW White - \$55 ea

Premium Metal Finish

- Specify premium Metal Finish. MFMB: Matte Black, MFS: Silver, MFSS: Salmon Sienna, MFSA: Surfing Aquavert, MFPS: Pistachio, MFOS: Oyster, MFNA: Navy, MFOL: Olive, MFGB: Grey Beige MFGG: Graphite Gray, MFG: Gray, MFGM:Matte Gold
- Premium Metal Finish for WMT Wire Management Tray - \$75 ea
- Premium Metal Finish for MTL10 Metal Feet - \$20 ea
- Premium Metal Finish for PCEB Concealed Floor Power Infeed Cover - \$35

Starter Panel

- RSP: Substitute round starter panel in place of flat starter panel. Must substitute all starters, priced per starter panel - \$83 each. See HNY3555SP888

Telecom Plates

- Each power unit has 1 plate. All telecom connectors sold separately.
- RJ45 (1) - \$55, RJ45 (2) - \$110, RJ45 (3) - \$165, USB (1) - \$70, USB (2) - \$140, RJ45/USB - \$125, RJ45/HDMI - \$210, HDMI/USB - \$205

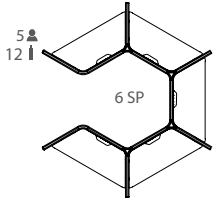

Number of Feet per Typical (MTL10 Option) "SP" Number of Starter Panels per Typical (RSP Option)

1 Select Model

w" x d" x h"	Weight	Standard Veneer Top Upholstered Panels - COM\$	Premium Veneer Top Upholstered Panels - COM\$	High Pressure Laminate Top Upholstered Panels - COM\$	Thermally Fused Laminate Top Upholstered Panels - COM\$
166 x 145 x 55	41	5 HNY166145FT583W 22510	"P" Option N/A	HNY166145FT583G 21510	HNY166145FT583M 19600

2 Select Finish

Click to view finishes

WWP	WOW
PO01	WNO
PO02	WSO
PO03	WNF(Natural Oak on Flat Cut)
PO07	WSF(Salted Oak on Flat Cut)
PO08	
PO09	
WBW	
WSW	
WEC	

3 Select Feet Finish

Click to view edges

WWP	WOW
PO01	WNO
PO02	WSO
PO03	
PO07	
PO08	
PO09	
WBW	
WSW	
WEC	

4 Select Edge

Click to view details

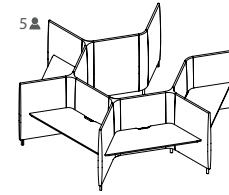

Click here to view statement of line

Product Features

- 5" Solid wood feet - oval shape
- HNY7226WT162 Fixed Desk Height worksurfaces, 29" worksurface height
- Ships KD
- T75 worksurface wire cutout is standard on all worksurfaces.(T75D: Delete cutout is optional)

Options

Accessories

- K28: Articulating Keyboard w/ Mouse - \$390
- K31-SK: Center drawer w/ skirt - \$310
- K31: Center drawer w/o skirt - \$205

Concealed Floor Power Infeed Cover

- PCEB: White Metal Finish concealed floor power infeed cover - \$150

Delete Top

- DFT: Delete fixed top. Deduct \$1325 Veneer(W), \$1125 High Pressure Laminate (G), \$743 Thermally Fused Laminate (M) per top

Metal Feet

- MTL10: Replace solid wood feet with metal feet, standard MFW White - \$55 ea

Premium Metal Finish

- Specify premium Metal Finish. MFMB: Matte Black, MFS: Silver, MFSS: Salmon Sienna, MFSA: Surfing Aquavert, MFPS: Pistachio, MFOS: Oyster, MFNA: Navy, MFOL: Olive, MFGB: Grey Beige MFGG: Graphite Gray, MFG: Gray, MFGM:Matte Gold
- Premium Metal Finish for WMT Wire Management Tray - \$75 ea
- Premium Metal Finish for MTL10 Metal Feet - \$20 ea
- Premium Metal Finish for PCEB Concealed Floor Power Infeed Cover - \$35

Starter Panel

- RSP: Substitute round starter panel in place of flat starter panel. Must substitute all starters, priced per starter panel - \$83 each. See HNY3555SP888

Worksurface Height

- Modify worksurface height to bar height.
- THL-42: Position worksurface at bar height - N/C

Wire Tray

- WMT: Wire metal tray. Mounts under top and comes standard in MFW White - \$210

DARRAN[®]

Honey

Hexagon Workstation Typical
Five Person Workstation with Power Fixed Worksurface

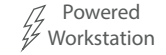
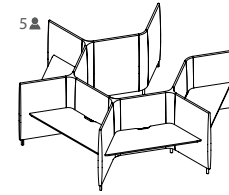
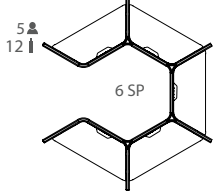

Number of Feet per Typical (MTL10 Option) "SP" Number of Starter Panels per Typical (RSP Option)

1 Select Model

w" x d" x h"	Weight	Standard Veneer Top Upholstered Panels - COM\$	Premium Veneer Top Upholstered Panels - COM\$
166 x 145 x 55	41	5 HNY166145FP583W 24425	"P" Option N/A

2 Select Finish

Click to view finishes

WWP	WOW
PO01	WNO
PO02	WSO
PO03	WNF(Natural Oak on Flat Cut)
PO07	WSF(Salted Oak on Flat Cut)
PO08	
PO09	
WBW	
WSW	
WEC	

3 Select Feet Finish

Click to view edges

WWP	WOW
PO01	WNO
PO02	WSO
PO03	
PO07	
PO08	
PO09	
WBW	
WSW	
WEC	

4 Select Edge

Click to view details

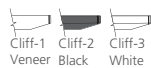

High Pressure Laminate Top Upholstered Panels - COM\$

HNY166145FP583G 23425

GEC	LW04
GNA +5%	LW05
GWL	LW06
LP01	
LF02	
LF03	
LN01	
LA02	
LW01	
LW02	

WWP	WOW
PO01	WNO
PO02	WSO
PO03	
PO07	
PO08	
PO09	
WBW	
WSW	
WEC	



Thermally Fused Laminate Top Upholstered Panels - COM\$

HNY166145FP583M 21515

MOC
MEC
MSW
MTW
MWL
MNA

WWP	WOW
PO01	WNO
PO02	WSO
PO03	
PO07	
PO08	
PO09	
WEC	
WBW	
WSW	



Click here to view statement of line

Product Features

- HNY7226WT162 Fixed Desk Height worksurfaces, 29" worksurface height
- 5" Solid wood feet - oval shape
- 4 Power outlets with 1 telecom plate, see options below for telecom plate
- Ships KD
- Wire management tray attaches to worksurface top, standard in MFW White, see premium Metal Finish for options
- Hardwire infeed and jumpers are included in workstations
- T75 worksurface wire cutout is standard on all worksurfaces.(T75D: Delete cutout is optional)

Options

Accessories

- K28: Articulating Keyboard w/ Mouse - \$390
- K31-SK: Center drawer w/ skirt - \$310
- K31: Center drawer w/o skirt - \$205

Concealed Floor Power Infeed Cover

- PCEB: White Metal Finish concealed floor power infeed cover - \$150

Delete Top and Wire Tray

- DFP: Delete fixed top. Deduct \$1535 Veneer (W), \$1335 High Pressure Laminate (G), \$953 Thermally Fused Laminate (M) per top

Metal Feet

- MTL10: Replace solid wood feet with metal feet, standard MFW White - \$55 ea

Premium Metal Finish

- Specify premium Metal Finish. MFMB: Matte Black, MFS: Silver, MFSS: Salmon Sienna, MFSA: Surfing Aquavert, MFPS: Pistachio, MFOS: Oyster, MFNA: Navy, MFOL: Olive, MFGB: Grey Beige MFGG: Graphite Gray, MFG: Gray, MFGM:Matte Gold
- Premium Metal Finish for WMT Wire Management Tray - \$75 ea
- Premium Metal Finish for MTL10 Metal Feet - \$20 ea
- Premium Metal Finish for PCEB Concealed Floor Power Infeed Cover - \$35

Starter Panel

- RSP: Substitute round starter panel in place of flat starter panel. Must substitute all starters, priced per starter panel - \$83 each. See HNY3555SP888

Telecom Plates

- Each power unit has 1 plate. All telecom connectors sold separately.
- RJ45 (1) - \$55, RJ45 (2) - \$110, RJ45 (3) - \$165, USB (1) - \$70, USB (2) - \$140, RJ45/USB - \$125, RJ45/HDMI - \$210, HDMI/USB - \$205

Worksurface Height

- THL-42: Modify worksurface height to bar height - N/C

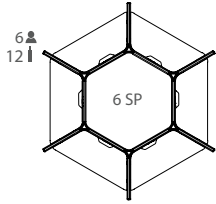

Number of Feet per Typical (MTL10 Option) "SP" Number of Starter Panels per Typical (RSP Option)

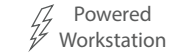
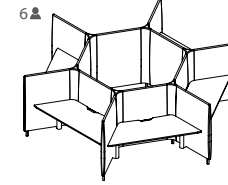

1 Select Model

Weight

Standard Veneer Top Upholstered Panels - COM\$

Premium Veneer Top Upholstered Panels - COM\$

High Pressure Laminate Top Upholstered Panels - COM\$

Thermally Fused Laminate Top Upholstered Panels - COM\$

w" x d" x h"			
166 x 145 x 55	45	6 HNY166145HA584W	41323

"P" Option N/A

HNY166145HA584G 40117

HNY166145HA584M 37825

[Click Here for Graded in Pricing](#)

2 Select Finish

Click to view finishes

WWP	WOW
PO01	WNO
PO02	WSO
PO03	WNF(Natural Oak on Flat Cut)
PO07	WSF(Salted Oak on Flat Cut)
PO08	
PO09	
WBW	
WSW	
WEC	

3 Select Feet Finish

Click to view edges

WWP	WOW
PO01	WNO
PO02	WSO
PO03	
PO07	
PO08	
PO09	
WBW	
WSW	
WEC	

4 Select Edge

Click to view details

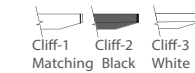
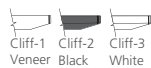

[Click here to view statement of line](#)

Product Features

- 5" Solid wood feet - oval shape, ships KD
- 4 Power outlets with 1 telecom plate, see options below for telecom plate
- Adjustable height from 27" to 47.5" with a maximum weight capacity of 275 lbs. Lift standard in MFW White, optional MFB Black
- HNY7125WT163 Height Adjustable worksurfaces are included
- Wire management tray attaches to worksurface top, standard in MFW White, see premium Metal Finish for options
- T75 worksurface wire cutout is standard on all worksurfaces.(T75D: Delete cutout is optional)

Notes

- 1" Gap between worksurface and panels to drop wires below worksurface
- Metal parts include 5 year warranty
- Programmable height adjustable mechanism, motor includes 2 year warranty

Options

Accessories

- K28: Articulating Keyboard w/ Mouse - \$390
- K31-SK: Center drawer w/ skirt - \$310
- K31: Center drawer w/o skirt - \$205

Concealed Floor Power Infeed Cover

- PCEB: White Metal Finish concealed floor power infeed cover - \$150

Delete Top and Wire Tray

- DHAT: Delete height adjustable top. Deduct \$3845 Veneer(W), \$3644 High Pressure Laminate(G), \$3262 Thermally Fused Laminate(M) per top

Metal Feet

- MTL10: Replace solid wood feet with metal feet, standard MFW White - \$55 ea

Premium Metal Finish

- Specify premium Metal Finish. MFMB: Matte Black, MFS: Silver, MFSS: Salmon Sienna, MFSA: Surfing Aquavert, MFPS: Pistachio, MFOS: Oyster, MFNA: Navy, MFOL: Olive, MFGB: Grey Beige MFGG: Graphite Gray, MFG: Gray, MFGM:Matte Gold
- Premium Metal Finish for WMT Wire Management Tray - \$75 ea
- Premium Metal Finish for MTL10 Metal Feet - \$20 ea
- Premium Metal Finish for PCEB Concealed Floor Power Infeed Cover - \$35

Starter Panel

- RSP: Substitute round starter panel in place of flat starter panel. Must substitute all starters, priced per starter panel - \$83 each. See HNY3555SP888

Telecom Plates

- Each power unit has 1 plate. All telecom connectors sold separately.
- RJ45 (1) - \$55, RJ45 (2) - \$110, RJ45 (3) - \$165, USB (1) - \$70, USB (2) - \$140, RJ45/USB - \$125, RJ45/HDMI - \$210, HDMI/USB - \$205

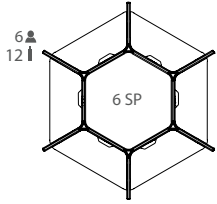

Number of Feet per Typical (MTL10 Option) "SP" Number of Starter Panels per Typical (RSP Option)

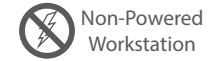
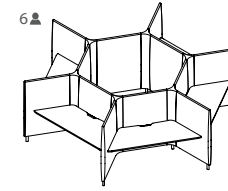

1 Select Model

Weight	Standard Veneer Top Upholstered Panels - COM\$	Premium Veneer Top Upholstered Panels - COM\$	High Pressure Laminate Top Upholstered Panels - COM\$	Thermally Fused Laminate Top Upholstered Panels - COM\$
w" x d" x h"				
166 x 145 x 55	45	6 HNY166145FT584W 25320	"P" Option N/A	HNY166145FT584M 21828

2 Select Finish

Click to view finishes

WWP	WOW
PO01	WNO
PO02	WSO
PO03	WNF(Natural Oak on Flat Cut)
PO07	WSF(Salted Oak on Flat Cut)
PO08	
PO09	
WBW	
WSW	
WEC	

3 Select Feet Finish

Click to view edges

WWP	WOW
PO01	WNO
PO02	WSO
PO03	
PO07	
PO08	
PO09	
WBW	
WSW	
WEC	

4 Select Edge

Click to view details

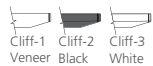

GEC	LW04
GNA +5%	LW05
GWL	LW06
LP01	
LF02	
LF03	
LN01	
LA02	
LW01	
LW02	

WWP	WOW
PO01	WNO
PO02	WSO
PO03	
PO07	
PO08	
PO09	
WBW	
WSW	
WEC	



MOC
MEC
MSW
MTW
MWL
MNA

WWP	WOW
PO01	WNO
PO02	WSO
PO03	
PO07	
PO08	
PO09	
WBW	
WSW	



Click here to view statement of line

Product Features

- 5" Solid wood feet - oval shape
- HNY7226WT162 Fixed Desk Height worksurfaces, 29" worksurface height
- Ships KD
- T75 worksurface wire cutout is standard on all worksurfaces.(T75D: Delete cutout is optional)

Options

Accessories

- K28: Articulating Keyboard w/ Mouse - \$390
- K31-SK: Center drawer w/ skirt - \$310
- K31: Center drawer w/o skirt - \$205

Concealed Floor Power Infeed Cover

- PCEB: White Metal Finish concealed floor power infeed cover - \$150

Delete Top

- DFT: Delete fixed top. Deduct \$1325 Veneer(W), \$1125 High Pressure Laminate (G), \$743 Thermally Fused Laminate (M) per top

Metal Feet

- MTL10: Replace solid wood feet with metal feet, standard MFW White - \$55 ea

Premium Metal Finish

- Specify premium Metal Finish. MFMB: Matte Black, MFS: Silver, MFSS: Salmon Sienna, MFSA: Surfing Aquavert, MFPS: Pistachio, MFOS: Oyster, MFNA: Navy, MFOL: Olive, MFGB: Grey Beige MFGG: Graphite Gray, MFG: Gray, MFGM:Matte Gold
- Premium Metal Finish for WMT Wire Management Tray - \$75 ea
- Premium Metal Finish for MTL10 Metal Feet - \$20 ea
- Premium Metal Finish for PCEB Concealed Floor Power Infeed Cover - \$35

Starter Panel

- RSP: Substitute round starter panel in place of flat starter panel. Must substitute all starters, priced per starter panel - \$83 each. See HNY3555SP888

Worksurface Height

- Modify worksurface height to bar height.
- THL-42: Position worksurface at bar height - N/C

Wire Tray

- WMT: Wire metal tray. Mounts under top and comes standard in MFW White - \$210

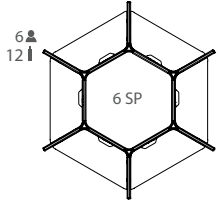

Number of Feet per Typical (MTL10 Option) "SP" Number of Starter Panels per Typical (RSP Option)

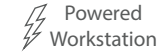
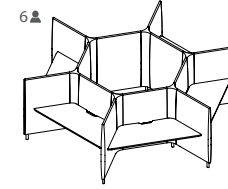

1 Select Model

Weight	Standard Veneer Top Upholstered Panels - COM\$
w" x d" x h"	6 SP
166 x 145 x 55	45 6 HNY166145FP584W 27577

Premium Veneer Top Upholstered Panels - COM\$

"P" Option N/A

High Pressure Laminate Top Upholstered Panels - COM\$

HNY166145FP584G 26377

Thermally Fused Laminate Top Upholstered Panels - COM\$

HNY166145FP584M 24085

[Click here to view statement of line](#)

Product Features

- HNY7226WT162 Fixed Desk Height worksurfaces, 29" worksurface height
- 5" Solid wood feet - oval shape
- 4 Power outlets with 1 telecom plate, see options below for telecom plate
- Ships KD
- Wire management tray attaches to worksurface top, standard in MFW White, see premium Metal Finish for options
- Hardwire infeed and jumpers are included in workstations
- T75 worksurface wire cutout is standard on all worksurfaces.(T75D: Delete cutout is optional)

[Click Here for Graded in Pricing](#)

2 Select Finish

Click to view finishes

WWP	WOW
PO01	WNO
PO02	WSO
PO03	WNF(Natural Oak on Flat Cut)
PO07	WSF(Salted Oak on Flat Cut)
PO08	
PO09	
WBW	
WSW	
WEC	

GEC	LW04
GNA +5%	LW05
GWL	LW06
LP01	
LF02	
LF03	
LN01	
LA02	
LW01	
LW02	

MOC
MEC
MSW
MTW
MWL
MNA

3 Select Feet Finish

Click to view edges

WWP	WOW
PO01	WNO
PO02	WSO
PO03	
PO07	
PO08	
PO09	
WBW	
WSW	
WEC	

WWP	WOW
PO01	WNO
PO02	WSO
PO03	
PO07	
PO08	
PO09	
WBW	
WSW	
WEC	

WWP	WOW
PO01	WNO
PO02	WSO
PO03	
PO07	
PO08	
PO09	
WEC	
WBW	
WSW	

4 Select Edge

Click to view details



Options

Accessories

- K28: Articulating Keyboard w/ Mouse - \$390
- K31-SK: Center drawer w/ skirt - \$310
- K31: Center drawer w/o skirt - \$205

Concealed Floor Power Infeed Cover

- PCEB: White Metal Finish concealed floor power infeed cover - \$150

Delete Top and Wire Tray

- DFP: Delete fixed top. Deduct \$1535 Veneer (W), \$1335 High Pressure Laminate (G), \$953 Thermally Fused Laminate (M) per top

Metal Feet

- MTL10: Replace solid wood feet with metal feet, standard MFW White - \$55 ea

Premium Metal Finish

- Specify premium Metal Finish. MFMB: Matte Black, MFS: Silver, MFSS: Salmon Sienna, MFSA: Surfing Aquavert, MFPS: Pistachio, MFOS: Oyster, MFNA: Navy, MFOL: Olive, MFGB: Grey Beige MFGG: Graphite Gray, MFG: Gray, MFGM:Matte Gold
- Premium Metal Finish for WMT Wire Management Tray - \$75 ea
- Premium Metal Finish for MTL10 Metal Feet - \$20 ea
- Premium Metal Finish for PCEB Concealed Floor Power Infeed Cover - \$35

Starter Panel

- RSP: Substitute round starter panel in place of flat starter panel. Must substitute all starters, priced per starter panel - \$83 each. See HNY3555SP888

Telecom Plates

- Each power unit has 1 plate. All telecom connectors sold separately.
- RJ45 (1) - \$55, RJ45 (2) - \$110, RJ45 (3) - \$165, USB (1) - \$70, USB (2) - \$140, RJ45/USB - \$125, RJ45/HDMI - \$210, HDMI/USB - \$205

Worksurface Height

- THL-42: Modify worksurface height to bar height - N/C

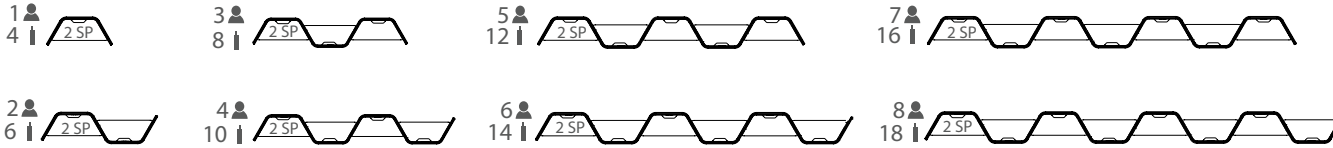

Number of Feet per Typical (MTL10 Option) "SP" Number of Starter Panels per Typical (RSP Option)

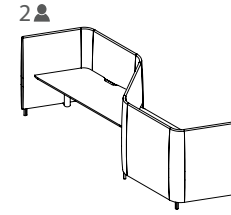

1 Select Model

w" x d" x h"	Weight	Standard Veneer Top Upholstered Panels - COM\$	Premium Veneer Top Upholstered Panels - COM\$	High Pressure Laminate Top Upholstered Panels - COM\$	Thermally Fused Laminate Top Upholstered Panels - COM\$
539 x 41 x 55	67	8 HNY53941HA585W 60828	"P" Option N/A	HNY53941HA585G 59220	HNY53941HA585M 56164
474 x 41 x 55	59	7 HNY47441HA585W 53348	"P" Option N/A	HNY47441HA585G 51941	HNY47441HA585M 49267
409 x 41 x 55	51	6 HNY40941HA585W 45868	"P" Option N/A	HNY40941HA585G 44662	HNY40941HA585M 42370
345 x 41 x 55	43	5 HNY34541HA585W 38388	"P" Option N/A	HNY34541HA585G 37383	HNY34541HA585M 35473
280 x 41 x 55	35	4 HNY28041HA585W 30908	"P" Option N/A	HNY28041HA585G 30104	HNY28041HA585M 28576
215 x 41 x 55	27	3 HNY21541HA585W 23428	"P" Option N/A	HNY21541HA585G 22825	HNY21541HA585M 21679
150 x 41 x 55	19	2 HNY15041HA585W 15948	"P" Option N/A	HNY15041HA585G 15546	HNY15041HA585M 14782
85 x 37 x 55	11	1 HNY8537HA585W 8468	"P" Option N/A	HNY8537HA585G 8267	HNY8537HA585M 7885

[Click Here for Graded in Pricing](#)

2 Select Finish

Click to view finishes

WWP	WOW
PO01	WNO
PO02	WSO
PO03	WNF(Natural Oak on Flat Cut)
PO07	WSF(Salted Oak on Flat Cut)
PO08	WSF(Salted Oak on Flat Cut)
PO09	WSF(Salted Oak on Flat Cut)
WBW	
WSW	
WEC	

3 Select Feet Finish

Click to view edges

WWP	WOW
PO01	WNO
PO02	WSO
PO03	
PO07	
PO08	
PO09	
WBW	
WSW	
WEC	

4 Select Edge

Click to view details

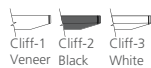

[Click here to view statement of line](#)

Product Features

- 5" Solid wood feet - oval shape, ships KD
- 4 Power outlets with 1 telecom plate, see options below for telecom plate
- Adjustable height from 27" to 47.5" with a maximum weight capacity of 275 lbs.
- Lift standard in MFW White, optional MFB Black
- HNY7125WT163 Height Adjustable worksurfaces are included
- Wire management tray attaches to worksurface top, standard in MFW White, see premium Metal Finish for options
- T75 worksurface wire cutout is standard on all worksurfaces.(T75D: Delete cutout is optional)

Notes

- 1" Gap between worksurface and panels to drop wires below worksurface
- Metal parts include 5 year warranty
- Programmable height adjustable mechanism, motor includes 2 year warranty

Options

Accessories

- K28: Articulating Keyboard w/ Mouse - \$390
- K31-SK: Center drawer w/ skirt - \$310
- K31: Center drawer w/o skirt - \$205

Concealed Floor Power Infeed Cover

- PCEB: White Metal Finish concealed floor power infeed cover - \$150

Delete Top and Wire Tray

- DHAT: Delete height adjustable top. Deduct \$3845 Veneer(W), \$3644 High Pressure Laminate(G), \$3262 Thermally Fused Laminate(M) per top

Metal Feet

- MTL10: Replace solid wood feet with metal feet, standard MFW White - \$55 ea

Premium Metal Finish

- Specify premium Metal Finish. MFMB: Matte Black, MFS: Silver, MFSS: Salmon Sienna, MFSA: Surfing Aquavert, MFPS: Pistachio, MFOS: Oyster, MFNA: Navy, MFOL: Olive, MFGB: Grey Beige MFGG: Graphite Gray, MFG: Gray, MFGM:Matte Gold
- Premium Metal Finish for WMT Wire Management Tray - \$75 ea
- Premium Metal Finish for MTL10 Metal Feet - \$20 ea
- Premium Metal Finish for PCEB Concealed Floor Power Infeed Cover - \$35

Starter Panel

- RSP: Substitute round starter panel in place of flat starter panel. Must substitute all starters, priced per starter panel - \$83 each. See HNY3555SP888

Telecom Plates

- Each power unit has 1 plate. All telecom connectors sold separately.
- RJ45 (1) - \$55, RJ45 (2) - \$110, RJ45 (3) - \$165, USB (1) - \$70, USB (2) - \$140, RJ45/USB - \$125, RJ45/HDMI - \$210, HDMI/USB - \$205

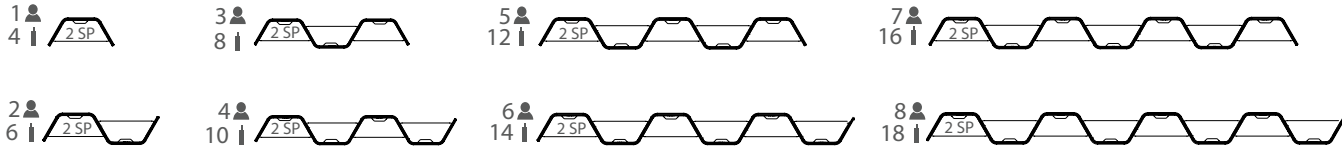

Number of Feet per Typical (MTL10 Option) "SP" Number of Starter Panels per Typical (RSP Option)

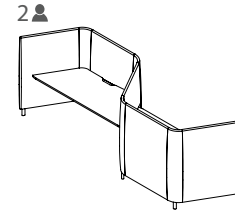

1 Select Model

w" x d" x h"	Weight	Standard Veneer Top Upholstered Panels - COM\$	Premium Veneer Top Upholstered Panels - COM\$	High Pressure Laminate Top Upholstered Panels - COM\$	Thermally Fused Laminate Top Upholstered Panels - COM\$
539 x 41 x 55	67	8 HNY53941FT585W 38656	"P" Option N/A	HNY53941FT585G 37056	HNY53941FT585M 34000
474 x 41 x 55	59	7 HNY47441FT585W 33938	"P" Option N/A	HNY47441FT585G 32538	HNY47441FT585M 29864
409 x 41 x 55	51	6 HNY40941FT585W 29220	"P" Option N/A	HNY40941FT585G 28020	HNY40941FT585M 25728
345 x 41 x 55	43	5 HNY34541FT585W 24502	"P" Option N/A	HNY34541FT585G 23502	HNY34541FT585M 21592
280 x 41 x 55	35	4 HNY28041FT585W 19784	"P" Option N/A	HNY28041FT585G 18984	HNY28041FT585M 17456
215 x 41 x 55	27	3 HNY21541FT585W 15066	"P" Option N/A	HNY21541FT585G 14466	HNY21541FT585M 13320
150 x 41 x 55	19	2 HNY15041FT585W 10348	"P" Option N/A	HNY15041FT585G 9948	HNY15041FT585M 9184
85 x 37 x 55	11	1 HNY8537FT585W 5630	"P" Option N/A	HNY8537FT585G 5430	HNY8537FT585M 5048

[Click Here for Graded in Pricing](#)

2 Select Finish

Click to view finishes

WWP	WOW
PO01	WNO
PO02	WSO
PO03	WNF(Natural Oak on Flat Cut)
PO08	WSF(Salted Oak on Flat Cut)
PO09	
WBW	
WSW	
WEC	

3 Select Feet Finish

Click to view edges

WWP	WOW
PO01	WNO
PO02	WSO
PO03	
PO07	
PO08	
PO09	
WBW	
WSW	
WEC	

4 Select Edge

Click to view details



GEC	LW04
GNA +5%	LW05
GWL	LW06
LP01	
LF02	
LF03	
LN01	
LA02	
LW01	
LW02	

WWP	WOW
PO01	WNO
PO02	WSO
PO03	
PO07	
PO08	
PO09	
WBW	
WSW	
WEC	

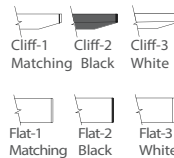

MOC
MEC
MSW
MTW
MWL
MNA

WWP	WOW
PO01	WNO
PO02	WSO
PO03	
PO07	
PO08	
PO09	
WBW	
WSW	



[Click here to view statement of line](#)

Product Features

- 5" Solid wood feet - oval shape
- HNY7226WT162 Fixed Desk Height worksurfaces, 29" worksurface height
- Ships KD
- T75 worksurface wire cutout is standard on all worksurfaces.(T75D: Delete cutout is optional)

Options

Accessories

- K28: Articulating Keyboard w/ Mouse - \$390
- K31-SK: Center drawer w/ skirt - \$310
- K31: Center drawer w/o skirt - \$205

Concealed Floor Power Infeed Cover

- PCEB: White Metal Finish concealed floor power infeed cover - \$150

Delete Top

- DFT: Delete fixed top. Deduct \$1325 Veneer(W), \$1125 High Pressure Laminate (G), \$743 Thermally Fused Laminate (M) per top

Metal Feet

- MTL10: Replace solid wood feet with metal feet, standard MFW White - \$55 ea

Premium Metal Finish

- Specify premium Metal Finish. MFMB: Matte Black, MFS: Silver, MFSS: Salmon Sienna, MFSA: Surfing Aquavert, MFPS: Pistachio, MFOS: Oyster, MFNA: Navy, MFOL: Olive, MFGB: Grey Beige MFGG: Graphite Gray, MFG: Gray, MFGM:Matte Gold
- Premium Metal Finish for WMT Wire Management Tray - \$75 ea
- Premium Metal Finish for MTL10 Metal Feet - \$20 ea
- Premium Metal Finish for PCEB Concealed Floor Power Infeed Cover - \$35

Starter Panel

- RSP: Substitute round starter panel in place of flat starter panel. Must substitute all starters, priced per starter panel - \$83 each. See HNY3555SP888

Worksurface Height

- Modify worksurface height to bar height.
- THL-42: Position worksurface at bar height - N/C

Wire Tray

- WMT: Wire metal tray. Mounts under top and comes standard in MFW White - \$210

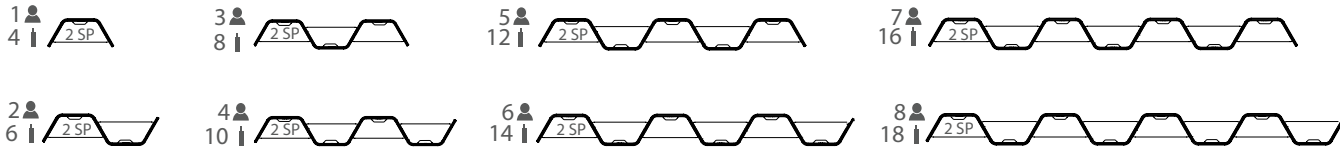

Number of Feet per Typical (MTL10 Option) "SP" Number of Starter Panels per Typical (RSP Option)

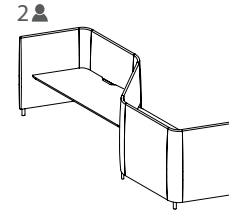

Fixed Top Workstation

Powered Workstation

1 Select Model

w" x d" x h"	Weight	Standard Veneer Top Upholstered Panels - COM\$	Premium Veneer Top Upholstered Panels - COM\$	High Pressure Laminate Top Upholstered Panels - COM\$	Thermally Fused Laminate Top Upholstered Panels - COM\$
539 x 41 x 55	67	8 HNY53941FP585W 42500	"P" Option N/A	HNY53941FP585G 40900	HNY53941FP585M 37844
474 x 41 x 55	59	7 HNY47441FP585W 37311	"P" Option N/A	HNY47441FP585G 35911	HNY47441FP585M 33237
409 x 41 x 55	51	6 HNY40941FP585W 32122	"P" Option N/A	HNY40941FP585G 30922	HNY40941FP585M 28630
345 x 41 x 55	43	5 HNY34541FP585W 26933	"P" Option N/A	HNY34541FP585G 25933	HNY34541FP585M 24023
280 x 41 x 55	35	4 HNY28041FP585W 21744	"P" Option N/A	HNY28041FP585G 20944	HNY28041FP585M 19416
215 x 41 x 55	27	3 HNY21541FP585W 16555	"P" Option N/A	HNY21541FP585G 15955	HNY21541FP585M 14809
150 x 41 x 55	19	2 HNY15041FP585W 11366	"P" Option N/A	HNY15041FP585G 10966	HNY15041FP585M 10202
85 x 37 x 55	11	1 HNY8537FP585W 6177	"P" Option N/A	HNY8537FP585G 5977	HNY8537FP585M 5595

[Click Here for Graded in Pricing](#)

2 Select Finish

Click to view finishes

WWP	WOW
PO01	WNO
PO02	WSO
PO03	WNF(Natural Oak on Flat Cut)
PO07	WSF(Salted Oak on Flat Cut)
PO08	WSF(Salted Oak on Flat Cut)
PO09	WSF(Salted Oak on Flat Cut)
WBW	
WSW	
WEC	

3 Select Feet Finish

Click to view edges

WWP	WOW
PO01	WNO
PO02	WSO
PO03	
PO07	
PO08	
PO09	
WBW	
WSW	
WEC	

4 Select Edge

Click to view details

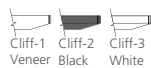

GEC	LW04
GNA +5%	LW05
GWL	LW06
LP01	
LF02	
LF03	
LN01	
LA02	
LW01	
LW02	

WWP	WOW
PO01	WNO
PO02	WSO
PO03	
PO07	
PO08	
PO09	
WBW	
WSW	
WEC	



MOC
MEC
MSW
MTW
MWL
MNA

WWP	WOW
PO01	WNO
PO02	WSO
PO03	
PO07	
PO08	
PO09	
WEC	
WBW	
WSW	



[Click here to view statement of line](#)

Product Features

- HNY7226WT162 Fixed Desk Height worksurfaces, 29" worksurface height
- 5" Solid wood feet - oval shape
- 4 Power outlets with 1 telecom plate, see options below for telecom plate
- Ships KD
- Wire management tray attaches to worksurface top, standard in MFW White, see premium Metal Finish for options
- Hardwire infeed and jumpers are included in workstations
- T75 worksurface wire cutout is standard on all worksurfaces.(T75D: Delete cutout is optional)

Options

Accessories

- K28: Articulating Keyboard w/ Mouse - \$390
- K31-SK: Center drawer w/ skirt - \$310
- K31: Center drawer w/o skirt - \$205

Concealed Floor Power Infeed Cover

- PCEB: White Metal Finish concealed floor power infeed cover - \$150

Delete Top and Wire Tray

- DFP: Delete fixed top. Deduct \$1535 Veneer (W), \$1335 High Pressure Laminate (G), \$953 Thermally Fused Laminate (M) per top

Metal Feet

- MTL10: Replace solid wood feet with metal feet, standard MFW White - \$55 ea

Premium Metal Finish

- Specify premium Metal Finish. MFMB: Matte Black, MFS: Silver, MFSS: Salmon Sienna, MFSA: Surfing Aquavert, MFPS: Pistachio, MFOS: Oyster, MFNA: Navy, MFOL: Olive, MFGB: Grey Beige MFGG: Graphite Gray, MFG: Gray, MFGM:Matte Gold
- Premium Metal Finish for WMT Wire Management Tray - \$75 ea
- Premium Metal Finish for MTL10 Metal Feet - \$20 ea
- Premium Metal Finish for PCEB Concealed Floor Power Infeed Cover - \$35

Starter Panel

- RSP: Substitute round starter panel in place of flat starter panel. Must substitute all starters, priced per starter panel - \$83 each. See HNY3555SP888

Telecom Plates

- Each power unit has 1 plate. All telecom connectors sold separately.
- RJ45 (1) - \$55, RJ45 (2) - \$110, RJ45 (3) - \$165, USB (1) - \$70, USB (2) - \$140, RJ45/USB - \$125, RJ45/HDMI - \$210, HDMI/USB - \$205

Worksurface Height

- THL-42: Modify worksurface height to bar height - N/C

DARRAN

Honey

S-Shaped Workstation Typical
Desk with Height Adjustable Worksurface

5
12

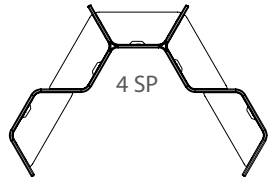

4 SP

8
18



6 SP

8

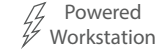
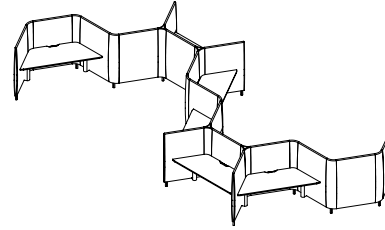

Number of Feet per Typical (MTL10 Option) "SP" Number of Starter Panels per Typical (RSP Option)

1 Select Model

Weight

Standard Veneer Top Upholstered Panels - COM\$

Premium Veneer Top Upholstered Panels - COM\$

High Pressure Laminate Top Upholstered Panels - COM\$

Thermally Fused Laminate Top Upholstered Panels - COM\$

w" x d" x h"			
347 x 145 x 55	65	8 HNY347145HA586W 58320	
217 x 145 x 55	42	5 HNY217145HA586W 37134	

"P" Option N/A
"P" Option N/A

HNY347145HA586G	56712
HNY217145HA586G	36129

HNY347145HA586M	53656
HNY217145HA586M	34219

[Click here to view statement of line](#)

Product Features

- 5" Solid wood feet - oval shape, ships KD
- 4 Power outlets with 1 telecom plate, see options below for telecom plate
- Adjustable height from 27" to 47.5" with a maximum weight capacity of 275 lbs. Lift standard in MFW White, optional MFB Black
- HNY7125WT163 Height Adjustable worksurfaces are included
- Wire management tray attaches to worksurface top, standard in MFW White, see premium Metal Finish for options
- T75 worksurface wire cutout is standard on all worksurfaces.(T75D: Delete cutout is optional)

Notes

- 1" Gap between worksurface and panels to drop wires below worksurface
- Metal parts include 5 year warranty
- Programmable height adjustable mechanism, motor includes 2 year warranty

Options

Accessories

- K28: Articulating Keyboard w/ Mouse - \$390
- K31-SK: Center drawer w/ skirt - \$310
- K31: Center drawer w/o skirt - \$205

Concealed Floor Power Infeed Cover

- PCEB: White Metal Finish concealed floor power infeed cover - \$150

Delete Top and Wire Tray

- DHAT: Delete height adjustable top. Deduct \$3845 Veneer(W), \$3644 High Pressure Laminate(G), \$3262 Thermally Fused Laminate(M) per top

Metal Feet

- MTL10: Replace solid wood feet with metal feet, standard MFW White - \$55 ea

Premium Metal Finish

- Specify premium Metal Finish. MFMB: Matte Black, MFS: Silver, MFSS: Salmon Sienna, MFSA: Surfing Aquavert, MFPS: Pistachio, MFOS: Oyster, MFNA: Navy, MFOL: Olive, MFGB: Grey Beige MFGG: Graphite Gray, MFG: Gray, MFGM:Matte Gold
- Premium Metal Finish for WMT Wire Management Tray - \$75 ea
- Premium Metal Finish for MTL10 Metal Feet - \$20 ea
- Premium Metal Finish for PCEB Concealed Floor Power Infeed Cover - \$35

Starter Panel

- RSP: Substitute round starter panel in place of flat starter panel. Must substitute all starters, priced per starter panel - \$83 each. See HNY3555SP888

Telecom Plates

- Each power unit has 1 plate. All telecom connectors sold separately.
- RJ45 (1) - \$55, RJ45 (2) - \$110, RJ45 (3) - \$165, USB (1) - \$70, USB (2) - \$140, RJ45/USB - \$125, RJ45/HDMI - \$210, HDMI/USB - \$205

[Click Here for Graded in Pricing](#)

2 Select Finish

Click to view finishes

WWP	WOW
PO01	WNO
PO02	WSO
PO03	WNF(Natural Oak on Flat Cut)
PO07	WSF(Salted Oak on Flat Cut)
PO08	
PO09	
WBW	
WSW	
WEC	

3 Select Feet Finish

Click to view edges

WWP	WOW
PO01	WNO
PO02	WSO
PO03	
PO07	
PO08	
PO09	
WBW	
WSW	
WEC	

4 Select Edge

Click to view details

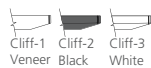

GEC	LW04
GNA +5%	LW05
GWL	LW06
LP01	
LF02	
LF03	
LN01	
LA02	
LW01	
LW02	

WWP	WOW
PO01	WNO
PO02	WSO
PO03	
PO07	
PO08	
PO09	
WBW	
WSW	
WEC	



MOC
MEC
MSW
MTW
MWL
MNA

WWP	WOW
PO01	WNO
PO02	WSO
PO03	
PO07	
PO08	
PO09	
WEC	
WBW	
WSW	



DARRAN

Honey

S-Shaped Workstation Typical
Desk with Fixed Worksurface

5
12

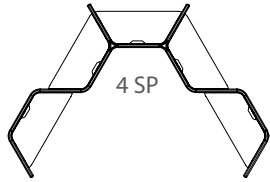

4 SP

8
18



6 SP

8

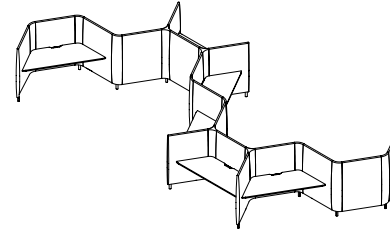

Fixed Top
Workstation



Non-Powered
Workstation

Number of Feet per Typical (MTL10 Option) "SP" Number of Starter Panels per Typical (RSP Option)

1 Select Model

Weight

Standard Veneer Top
Upholstered Panels - COM\$

Premium Veneer Top
Upholstered Panels - COM\$

High Pressure Laminate Top
Upholstered Panels - COM\$

Thermally Fused Laminate Top
Upholstered Panels - COM\$

w" x d" x h"	Weight	8	5
347 x 145 x 55	65	8 HNY347145FT586W 36664	5 HNY217145FT586W 23506
217 x 145 x 55	42		

"P" Option N/A
"P" Option N/A

HNY347145FT586G 35064
HNY217145FT586G 22506

HNY347145FT586M 32008
HNY217145FT586M 20596

Product Features

- 5" Solid wood feet - oval shape
- HNY7226WT162 Fixed Desk Height worksurfaces, 29" worksurface height
- Ships KD
- T75 worksurface wire cutout is standard on all worksurfaces.(T75D: Delete cutout is optional)

Options

Accessories

- K28: Articulating Keyboard w/ Mouse - \$390
- K31-SK: Center drawer w/ skirt - \$310
- K31: Center drawer w/o skirt - \$205

Concealed Floor Power Infeed Cover

- PCEB: White Metal Finish concealed floor power infeed cover - \$150

Delete Top

- DFT: Delete fixed top. Deduct \$1325 Veneer(W), \$1125 High Pressure Laminate (G), \$743 Thermally Fused Laminate (M) per top

Metal Feet

- MTL10: Replace solid wood feet with metal feet, standard MFW White - \$55 ea

Premium Metal Finish

- Specify premium Metal Finish. MFMB: Matte Black, MFS: Silver, MFSS: Salmon Sienna, MFSA: Surfing Aquavert, MFPS: Pistachio, MFOS: Oyster, MFNA: Navy, MFOL: Olive, MFGB: Grey Beige MFGG: Graphite Gray, MFG: Gray, MFGM:Matte Gold
- Premium Metal Finish for WMT Wire Management Tray - \$75 ea
- Premium Metal Finish for MTL10 Metal Feet - \$20 ea
- Premium Metal Finish for PCEB Concealed Floor Power Infeed Cover - \$35

Starter Panel

- RSP: Substitute round starter panel in place of flat starter panel. Must substitute all starters, priced per starter panel - \$83 each. See HNY3555SP888

Worksurface Height

- Modify worksurface height to bar height.
- THL-42: Position worksurface at bar height - N/C

Wire Tray

- WMT: Wire metal tray. Mounts under top and comes standard in MFW White - \$210

[Click here to view statement of line](#)

[Click Here for Graded in Pricing](#)

2 Select Finish

Click to view finishes

WWP	WOW
PO01	WNO
PO02	WSO
PO03	WNF(Natural Oak on Flat Cut)
PO07	WSF(Salted Oak on Flat Cut)
PO08	
PO09	
WBW	
WSW	
WEC	

3 Select Feet Finish

Click to view edges

WWP	WOW
PO01	WNO
PO02	WSO
PO03	
PO07	
PO08	
PO09	
WBW	
WSW	
WEC	

4 Select Edge

Click to view details

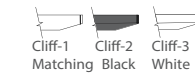

DARRAN

Honey

S-Shaped Workstation Typical
Desk with Power Fixed Worksurface

5
12

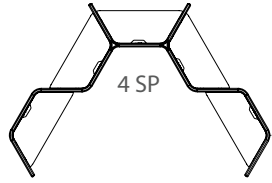

4 SP

8
18



6 SP

8

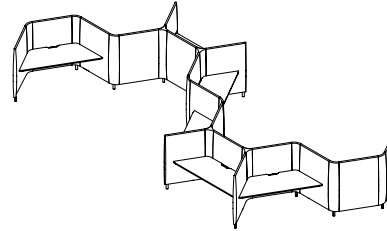

Number of Feet per Typical (MTL10 Option) "SP" Number of Starter Panels per Typical (RSP Option)

1 Select Model

Weight

Standard Veneer Top Upholstered Panels - COM\$

Premium Veneer Top Upholstered Panels - COM\$

High Pressure Laminate Top Upholstered Panels - COM\$

Thermally Fused Laminate Top Upholstered Panels - COM\$

w" x d" x h"			
347 x 145 x 55	65	8 HNY347145FP586W 39992	
217 x 145 x 55	42	5 HNY217145FP586W 25679	

"P" Option N/A
"P" Option N/A

HNY347145FP586G	38392
HNY217145FP586G	24679

HNY347145FP586M	35336
HNY217145FP586M	22769

[Click here to view statement of line](#)

Product Features

- HNY7226WT162 Fixed Desk Height worksurfaces, 29" worksurface height
- 5" Solid wood feet - oval shape
- 4 Power outlets with 1 telecom plate, see options below for telecom plate
- Ships KD
- Wire management tray attaches to worksurface top, standard in MFW White, see premium Metal Finish for options
- Hardwire infeed and jumpers are included in workstations
- T75 worksurface wire cutout is standard on all worksurfaces.(T75D: Delete cutout is optional)

[Click Here for Graded in Pricing](#)

2 Select Finish

Click to view finishes

WWP	WOW
PO01	WNO
PO02	WSO
PO03	WNF(Natural Oak on Flat Cut)
PO07	WSF(Salted Oak on Flat Cut)
PO08	
PO09	
WBW	
WSW	
WEC	

GEC	LW04
GNA +5%	LW05
GWL	LW06
LP01	
LF02	
LF03	
LN01	
LA02	
LW01	
LW02	

MOC
MEC
MSW
MTW
MWL
MNA

3 Select Feet Finish

Click to view edges

WWP	WOW
PO01	WNO
PO02	WSO
PO03	
PO07	
PO08	
PO09	
WBW	
WSW	
WEC	

WWP	WOW
PO01	WNO
PO02	WSO
PO03	
PO07	
PO08	
PO09	
WBW	
WSW	
WEC	

WWP	WOW
PO01	WNO
PO02	WSO
PO03	
PO07	
PO08	
PO09	
WEC	
WBW	
WSW	

4 Select Edge

Click to view details



Options

Accessories

- K28: Articulating Keyboard w/ Mouse - \$390
- K31-SK: Center drawer w/ skirt - \$310
- K31: Center drawer w/o skirt - \$205

Concealed Floor Power Infeed Cover

- PCEB: White Metal Finish concealed floor power infeed cover - \$150

Delete Top and Wire Tray

- DFP: Delete fixed top. Deduct \$1535 Veneer (W), \$1335 High Pressure Laminate (G), \$953 Thermally Fused Laminate (M) per top

Metal Feet

- MTL10: Replace solid wood feet with metal feet, standard MFW White - \$55 ea

Premium Metal Finish

- Specify premium Metal Finish. MFMB: Matte Black, MFS: Silver, MFSS: Salmon Sienna, MFSA: Surfing Aquavert, MFPS: Pistachio, MFOS: Oyster, MFNA: Navy, MFOL: Olive, MFGB: Grey Beige MFGG: Graphite Gray, MFG: Gray, MFGM:Matte Gold
- Premium Metal Finish for WMT Wire Management Tray - \$75 ea
- Premium Metal Finish for MTL10 Metal Feet - \$20 ea
- Premium Metal Finish for PCEB Concealed Floor Power Infeed Cover - \$35

Starter Panel

- RSP: Substitute round starter panel in place of flat starter panel. Must substitute all starters, priced per starter panel - \$83 each. See HNY3555SP888

Telecom Plates

- Each power unit has 1 plate. All telecom connectors sold separately.
- RJ45 (1) - \$55, RJ45 (2) - \$110, RJ45 (3) - \$165, USB (1) - \$70, USB (2) - \$140, RJ45/USB - \$125, RJ45/HDMI - \$210, HDMI/USB - \$205

Worksurface Height

- THL-42: Modify worksurface height to bar height - N/C

Honey

120° Lounge
Lounge with Seat and Back Cushions

[Click here to view statement of line](#)

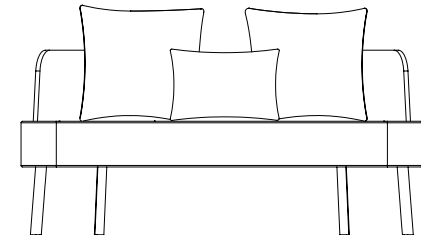

1 Model HNY0170HPB48

w" x d" x h"
60 x 26.5 x 27

COM	COL	1	2	3	4	5	6	7	8	9	10	11/L1	12	13/L2
3563	N/A	3748	3839	3930	4021	4112	4203	4294	4385	4476	4567	4658	4749	4931

Upholstery Requirements
Fabric yds: 5 Leather Sq. Ft.:90
Carton Weight:100

2 Select Finish

[Click to view finishes](#)

- WWP Designer White
- PO01 Olive on Oak
- PO02 Aquavert on Oak
- PO03 Mushroom on Oak
- PO07 Pebble on Oak
- PO08 Vapour on Oak
- PO09 Verde on Oak
- WEC Ebony
- WNO Natural Oak on Oak
- WSO Salted Oak on Oak
- WBW Henna Walnut on Walnut
- WSW Smokey Walnut on Walnut
- WOW Clear Walnut on Walnut

3 Combination Fabrics

[Click to view finishes](#)

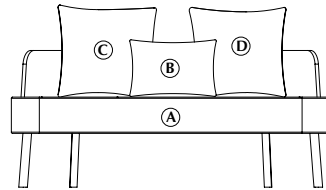

DARRAN is pleased to offer customers the design freedom of combination fabrics. When using fabric, vinyl or leather combinations, pricing/yardage requirements will be as follows:

- A Lounge Seat 2.5 yd. (s)
- B Lounge Pillow 1 yd.
- C Lounge Pillow 1 yd.
- D Lounge Pillow 1 yd.

- When combining two materials of the same grade, pricing will be specified grade + 5%
- If combining two materials of different grades or leather/fabric combination, use the highest grade/price + 5%
- If using COM or COL, pricing will be COM or COL + 5%.
- If both COM + COL are used in combination, use COL + 5%.

Product Features

- 10.5" Solid wood feet - oval shape
- 4" high resiliency foam seat
- 3/4" Bent plywood back with rift cut oak or walnut veneer
- (2) 20" pillows, (1) 16" pillow
- Solid wood base to maximize strength and longevity

Options

Premium Metal Finish

- Specify premium Metal Finish. MFMB: Matte Black, MFS: Silver, MFSS: Salmon Sienna, MFSA: Surfing Aquavert, MFPS: Pistachio, MFOS: Oyster, MFNA: Navy, MFOL: Olive, MFGB: Grey Beige MFGG: Graphite Gray, MFG: Gray, MFGM: Matte Gold
- Premium Metal Finish for MTL12 metal legs: \$20 ea

Metal Feet

- MTL12: Replace solid wood legs with metal legs, standard in MFW White - \$75 ea

Honey

120° Starter Panel
Round End

[Click here to view statement of line](#)

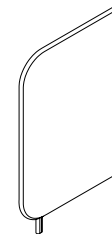

1 Model HNY3555SP888

w" x d" x h"
35 x 3 x 55

COM	COL	1	2	3	4	5	6	7	8	9	10	11/L1	12	13/L2
1041	N/A	1152	1207	1262	1317	1372	1427	1482	1537	1592	1647	1702	1757	1867

Upholstery Requirements
Fabric yds: 3 Leather Sq. Ft.:N/A
Carton Weight:20

Product Features

- 5" Solid wood feet - oval shape

Notes

- To configure workstations, customer is required to send drawing

Options

Metal Feet

- MTL10: Replace solid wood feet with metal feet, standard in MFW White - \$55 ea

Premium Metal Finish

- Specify premium Metal Finish. MFMB: Matte Black, MFS: Silver, MFSS: Salmon Sienna, MFSA: Surf in Aquavert, MFPS: Pistachio, MFOS: Oyster, MFNA: Navy, MFOL: Olive, MFGB: Grey Beige MFGG: Graphite Gray, MFG: Gray, MFGM: Matte Gold
- Premium Metal Finish for MTL10: Metal feet \$20 per foot

2 Select Finish

[Click to view finishes](#)

- WWP Designer White
- PO01 Olive on Oak
- PO02 Aquavert on Oak
- PO03 Mushroom on Oak
- PO07 Pebble on Oak
- PO08 Vapour on Oak
- PO09 Verde on Oak
- WEC Ebony
- WNO Natural Oak on Oak
- WSO Salted Oak on Oak
- WBW Henna Walnut on Walnut
- WSW Smokey Walnut on Walnut
- WOW Clear Walnut on Walnut

3 Combination Fabrics

[Click to view finishes](#)

Combination
Fabric Option
Not Available

Honey

120° Starter Panel
Flat End

[Click here to view statement of line](#)

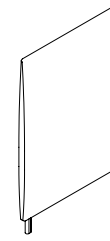

1 Model

HNY3555SP889

w" x d" x h"
35 x 3 x 55

COM	COL	1	2	3	4	5	6	7	8	9	10	11/L1	12	13/L2
942	N/A	1053	1108	1163	1218	1273	1328	1383	1438	1493	1548	1603	1658	1768

Upholstery Requirements
Fabric yds: 3 Leather Sq. Ft.:N/A
Carton Weight:20

Product Features

- 5" Solid wood feet - oval shape

Notes

- To configure workstations, customer is required to send drawing

Options

Metal Feet

- MTL10: Replace solid wood feet with metal feet, standard in MFW White - \$55 ea

Premium Metal Finish

- Specify premium Metal Finish. MFMB: Matte Black, MFS: Silver, MFSS: Salmon Sienna, MFSA: Surfing Aquavert, MFPS: Pistachio, MFOS: Oyster, MFNA: Navy, MFOL: Olive, MFGB: Grey Beige MFGG: Graphite Gray, MFG: Gray, MFGM: Matte Gold
- Premium Metal Finish for MTL10: Metal feet \$20 per foot

2 Select Finish

[Click to view finishes](#)

- WWP Designer White
- PO01 Olive on Oak
- PO02 Aquavert on Oak
- PO03 Mushroom on Oak
- PO07 Pebble on Oak
- PO08 Vapour on Oak
- PO09 Verde on Oak
- WEC Ebony
- WNO Natural Oak on Oak
- WSO Salted Oak on Oak
- WBW Henna Walnut on Walnut
- WSW Smokey Walnut on Walnut
- WOW Clear Walnut on Walnut

3 Combination Fabrics

[Click to view finishes](#)

Combination
Fabric Option
Not Available

Honey

120° Corner Panel Connector
Two Corner Panel

[Click here to view statement of line](#)



1 Model HNY0955CP890

w" x d" x h"
9 x 9 x 55

COM	COL	1	2	3	4	5	6	7	8	9	10	11/L1	12	13/L2
610	N/A	647	665	683	701	719	737	755	773	791	809	827	845	881

Upholstery Requirements
Fabric yds: 1 Leather Sq. Ft.:N/A
Carton Weight:10

Product Features

- 5" Solid wood feet - oval shape

Notes

- To configure workstations, customer is required to send drawing

Options

Metal Feet

- MTL10: Replace solid wood feet with metal feet, standard in MFW White - \$55 ea

Premium Metal Finish

- Specify premium Metal Finish. MFMB: Matte Black, MFS: Silver, MFSS: Salmon Sienna, MFSA: Surfing Aquavert, MFPS: Pistachio, MFOS: Oyster, MFNA: Navy, MFOL: Olive, MFGB: Grey Beige MFGG: Graphite Gray, MFG: Gray, MFGM: Matte Gold
- Premium Metal Finish for MTL10: Metal feet \$20 per foot

2 Select Finish

[Click to view finishes](#)

- WWP Designer White
- PO01 Olive on Oak
- PO02 Aquavert on Oak
- PO03 Mushroom on Oak
- PO07 Pebble on Oak
- PO08 Vapour on Oak
- PO09 Verde on Oak
- WEC Ebony
- WNO Natural Oak on Oak
- WSO Salted Oak on Oak
- WBW Henna Walnut on Walnut
- WSW Smokey Walnut on Walnut
- WOW Clear Walnut on Walnut

3 Combination Fabrics

[Click to view finishes](#)

Combination
Fabric Option
Not Available

Honey

120° Corner Panel Connector
Three Corner Panel

[Click here to view statement of line](#)

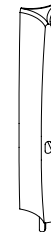

1 Model

HNY0855CP891

w" x d" x h"
8 x 8 x 55

COM	COL	1	2	3	4	5	6	7	8	9	10	11/L1	12	13/L2
752	N/A	808	835	862	889	916	943	970	997	1024	1051	1078	1105	1159

Upholstery Requirements
Fabric yds: 1.5 Leather Sq. Ft.:N/A
Carton Weight:10

Product Features

- 5" Solid wood feet - oval shape

Notes

- To configure workstations, customer is required to send drawing

Options

Metal Feet

- MTL10: Replace solid wood feet with metal feet, standard in MFW White - \$55 ea

Premium Metal Finish

- Specify premium Metal Finish. MFMB: Matte Black, MFS: Silver, MFSS: Salmon Sienna, MFSA: Surf in Aquavert, MFPS: Pistachio, MFOS: Oyster, MFNA: Navy, MFOL: Olive, MFGB: Grey Beige MFGG: Graphite Gray, MFG: Gray, MFGM: Matte Gold
- Premium Metal Finish for MTL10: Metal feet \$20 per foot

2 Select Finish

[Click to view finishes](#)

- WWP Designer White
- PO01 Olive on Oak
- PO02 Aquavert on Oak
- PO03 Mushroom on Oak
- PO07 Pebble on Oak
- PO08 Vapour on Oak
- PO09 Verde on Oak
- WEC Ebony
- WNO Natural Oak on Oak
- WSO Salted Oak on Oak
- WBW Henna Walnut on Walnut
- WSW Smokey Walnut on Walnut
- WOW Clear Walnut on Walnut

3 Combination Fabrics

[Click to view finishes](#)

Combination
Fabric Option
Not Available

Honey

In-Line Panel Connector
Straight Run Connector

[Click here to view statement of line](#)



1 Model HNY1655CP886

w" x d" x h"
16 x 3 x 55

COM	COL	1	2	3	4	5	6	7	8	9	10	11/L1	12	13/L2
532	N/A	569	587	605	623	641	659	677	695	713	731	749	767	803

Upholstery Requirements
Fabric yds: 1 Leather Sq. Ft.:N/A
Carton Weight:20

Product Features

- 5" Solid wood feet - oval shape

Notes

- To configure workstations, customer is required to send drawing

Options

Metal Feet

- MTL10: Replace solid wood feet with metal feet, standard in MFW White - \$55 ea

Premium Metal Finish

- Specify premium Metal Finish. MFMB: Matte Black, MFS: Silver, MFSS: Salmon Sienna, MFSA: Surfing Aquavert, MFPS: Pistachio, MFOS: Oyster, MFNA: Navy, MFOL: Olive, MFGB: Grey Beige MFGG: Graphite Gray, MFG: Gray, MFGM: Matte Gold
- Premium Metal Finish for MTL10: Metal feet \$20 per foot

2 Select Finish

[Click to view finishes](#)

- WWP Designer White
- PO01 Olive on Oak
- PO02 Aquavert on Oak
- PO03 Mushroom on Oak
- PO07 Pebble on Oak
- PO08 Vapour on Oak
- PO09 Verde on Oak
- WEC Ebony
- WNO Natural Oak on Oak
- WSO Salted Oak on Oak
- WBW Henna Walnut on Walnut
- WSW Smokey Walnut on Walnut
- WOW Clear Walnut on Walnut

3 Combination Fabrics

[Click to view finishes](#)

Combination
Fabric Option
Not Available

Honey

120° Adder Panel
No Power Access

[Click here to view statement of line](#)

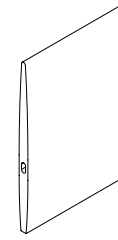

1 Model HNY3450AP894

w" x d" x h"
34 x 3 x 50

COM	COL	1	2	3	4	5	6	7	8	9	10	11/L1	12	13/L2
972	N/A	1083	1138	1193	1248	1303	1358	1413	1468	1523	1578	1633	1688	1798

Upholstery Requirements
Fabric yds: 3 Leather Sq. Ft.:N/A
Carton Weight:20

Product Features

- Adder panel

Notes

- To configure workstations, customer is required to send drawing
- Panel overall height is 55" with feet. Panel overall height without feet is 50"

2 Select Finish

[Click to view finishes](#)

Finish N/A

3 Combination Fabrics

[Click to view finishes](#)

Combination
Fabric Option
Not Available

Honey

120° Adder Access Panel
Single Sided Access

[Click here to view statement of line](#)

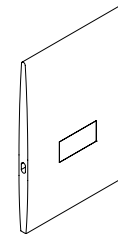

1 Model
HNY3450AP895

w" x d" x h"
34 x 3 x 50

COM	COL	1	2	3	4	5	6	7	8	9	10	11/L1	12	13/L2
1031	N/A	1142	1197	1252	1307	1362	1417	1472	1527	1582	1637	1692	1747	1857

Upholstery Requirements
Fabric yds: 3 Leather Sq. Ft.:N/A
Carton Weight:20

Product Features

- Panel features access panel for wire management

Notes

- To configure workstations, customer is required to send drawing
- Panel overall height is 55" with feet. Panel overall height without feet is 50"
- Removable panel allows wire access for cable management

2 Select Finish

[Click to view finishes](#)

Finish N/A

3 Combination Fabrics

[Click to view finishes](#)

Combination
Fabric Option
Not Available

Honey

120° Single Sided Power Panel
Power Panel

[Click here to view statement of line](#)

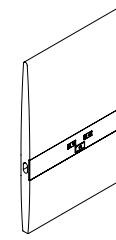

1 Model
HNY3450PP892

w" x d" x h"
34 x 3 x 50

COM	COL	1	2	3	4	5	6	7	8	9	10	11/L1	12	13/L2
1169	N/A	1280	1335	1390	1445	1500	1555	1610	1665	1720	1775	1830	1885	1995

Upholstery Requirements
Fabric yds: 3 Leather Sq. Ft.:N/A
Carton Weight:20

2 Select Finish

[Click to view finishes](#)

Finish N/A

3 Combination Fabrics

[Click to view finishes](#)

Combination
Fabric Option
Not Available

Product Features

- 4 power outlets with 1 telecom plate, see options below for telecom plate

Notes

- To configure workstations, customer is required to send drawing
- Panel overall height is 55" with feet. Panel overall height without feet is 50"
- Jumper(s) or hardwired infeed must be selected to power workstations. See options below.

Options

Jumper(s) and Infeed

- Specify Jumper or Infeed to power workstations
- JC42: 42" Length jumper, passes through corner post connecting panel to panel - \$145.
- JC96: 96" Length jumper, passes through 1 adder panel connecting 3 panels - \$215
- JC150: 150" Length jumper passes through 2 adder panels connecting 4 panels - \$290
- JC204: 204" Length jumper passes through corner post connecting 3 panels - \$350
- HPPF192: 192" hardwired power feed -\$350
- CPF72: 72" corded power feed -\$275

Telecom Plates

- Each power unit has 1 plate. All telecom connectors sold separately.
- RJ45 (1) - \$55, RJ45 (2) - \$110, RJ45 (3) - \$165, USB (1) - \$70, USB (2) - \$140, RJ45/USB - \$125, RJ45/HDMI - \$210, HDMI/USB - \$205

Honey

120° Double Sided Power Panel
Power Panel

[Click here to view statement of line](#)

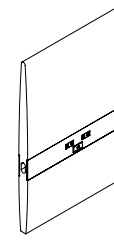

1 Model
HNY3450PP893

w" x d" x h"
34 x 3 x 50

COM	COL	1	2	3	4	5	6	7	8	9	10	11/L1	12	13/L2
1251	N/A	1362	1417	1472	1527	1582	1637	1692	1747	1802	1857	1912	1967	2077

Upholstery Requirements
Fabric yds: 3 Leather Sq. Ft.:N/A
Carton Weight:20

2 Select Finish

[Click to view finishes](#)

Finish N/A

3 Combination Fabrics

[Click to view finishes](#)

Combination
Fabric Option
Not Available

Product Features

- Double sided power panel, each panel side features 4 power outlets with 1 telecom plate. See options below for telecom plate

Notes

- To configure workstations, customer is required to send drawing
- Panel overall height is 55" with feet. Panel overall height without feet is 50"
- Jumper(s) or hardwired infeed must be selected to power workstations. See options below.

Options

Jumper(s) and Infeed

- Specify Jumper or Infeed to power workstations
- JC42: 42" Length jumped, passes through corner post connecting panel to panel - \$145.
- JC96: 96" Length jumper, passes through 1 adder panel connecting 3 panels - \$215
- JC150: 150" Length jumper passes through 2 adder panels connecting 4 panels - \$290
- JC204: 204" Length jumper passes through corner post connecting 3 panels - \$350
- HPF192: 192" hardwired power feed -\$350
- CPF72: 72" corded power feed -\$275

Telecom Plates

- Each power unit has 1 plate. All telecom connectors sold separately.
- RJ45 (1) - \$55, RJ45 (2) - \$110, RJ45 (3) - \$165, USB (1) - \$70, USB (2) - \$140, RJ45/USB - \$125, RJ45/HDMI - \$210, HDMI/USB - \$205

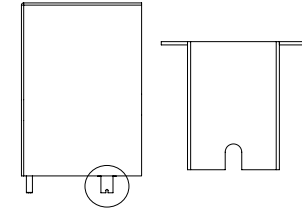

Shown on
HNY3555SP88
Panel not incl

1 Select Model

Weight

Power Infeed Cover

w" x d" x h"

5 x 2 x 6

PCEB

164

[Click Here for Graded in Pricing](#)

2 Select Finish

Click to view finishes

MFW

3 Select Feet Finish

Click to view edges

4 Select Edge

Click to view details

Edge
N/A

[Click here to view statement of line](#)

Product Features

- Conceals wire infeed from the floor and mounts to the bottom of honey panels
- White Metal Finish standard

Notes

- PANEL NOT INCLUDED

Options

Premium Metal Finish - Power Box

- Specify Metal Finish upcharge. MFB Black, MFMB: Matte Black, MFS: Silver, MFSS: Salmon Sienna, MFSA: Surfin Aquavert, MFPS: Pistachio, MFOS: Oyster, MFNA: Navy, MFOL: Olive, MFGB: Grey Beige MFGG: Graphite Gray, MFG: Gray - \$35

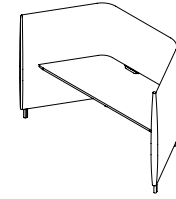

Panels
not included

[Click here to view statement of line](#)

1 Select Model

Weight

Standard Veneer Top

Premium Veneer Top

High Pressure Laminate Top

Thermally Fused Laminate Top

w" x d" x h"	Weight	Standard Veneer Top	Premium Veneer Top
Bar Height 42"			
72 x 26 x 1	60	HNY7226WT260W 1325	"P" Option N/A
63.5 x 19 x 1	50	HNY6319WT160W 1113	"P" Option N/A
Desk Height 29"			
72 x 26 x 1	60	HNY7226WT162W 1325	"P" Option N/A
63.5 x 19 x 1	50	HNY6319WT162W 1113	"P" Option N/A

[Click Here for Graded in Pricing](#)

2 Select Finish

Click to view finishes

WWP	WOW
PO01	WNO
PO02	WSO
PO03	
PO07	
PO08	
PO09	
WBW	
WSW	
WEC	

3 Select Feet Finish

Click to view edges

4 Select Edge

Click to view details

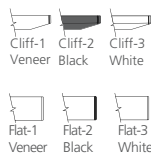

Product Features

- 1" Thick top
- Bar height 42", desk height 29"
- Ships KD
- T75 worksurface wire cutout is standard on all worksurfaces.(T75D: Delete cutout is optional)

Notes

- PANELS NOT INCLUDED

Options

Wire Tray / Premium Metal Finish

- WMT: Wire metal tray. Mounts under top and comes standard in MFW White - \$210

Premium Metal Finish

- Specify premium Metal Finish. MFMB: Matte Black, MFS: Silver, MFSS: Salmon Sienna, MFSA: Surfing Aquavert, MFPS: Pistachio, MFOS: Oyster, MFNA: Navy, MFOL: Olive, MFGB: Grey Beige MFGG: Graphite Gray, MFG: Gray
- Premium Metal Finish for WMT wire management tray - \$75 ea



Height Adjustable Worksurface

Panels not included

[Click here to view statement of line](#)

Product Features

- "W/G" worksurfaces are 1" thick, "M" worksurfaces are 1-1/8" thick
- Lift standard in MFW White, optional MFB Black
- Ships KD
- Wire management tray attaches to worksurface top, standard in MFW White, see premium Metal Finish for options
- T75 worksurface wire cutout is standard on all worksurfaces.(T75D: Delete cutout is optional)

Notes

- 1" Gap between worksurface and panels to drop wires below worksurface
- Metal parts include 5 year warranty
- Programmable height adjustable mechanism, motor includes 2 year warranty
- Height adjustable top with mechanism and wire tray only, panels not included

Options

Premium Metal Finish

- Specify premium Metal Finish. MFMB: Matte Black, MFS: Silver, MFSS: Salmon Sienna, MFSA: Surfin Aquavert, MFPS: Pistachio, MFOS: Oyster, MFNA: Navy, MFOL: Olive, MFGB: Grey Beige MFGG: Graphite Gray, MFG: Gray
- Premium Metal Finish for WMT wire management tray - \$75 ea

1 Select Model

w" x d" x h"	Weight	Standard Veneer Top	Premium Veneer Top
71 x 25.5 x 1	120	HNY7125WT163W 3845	"P" Option N/A
62.5 x 18 x 1	90	HNY6218WT163W 3632	"P" Option N/A

[Click Here for Graded in Pricing](#)

2 Select Finish

Click to view finishes

WWP	WOW
PO01	WNO
PO02	WSO
PO03	
PO07	
PO08	
PO09	
WBW	
WSW	
WEC	

3 Select Feet Finish

Click to view edges

4 Select Edge

Click to view details

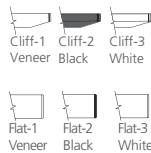

High Pressure Laminate Top

HNY7125WT163G	3644
HNY6218WT163G	3468

GEC	LW05
GWL	LW06
LP01	
LF02	
LF03	
LN01	
LA02	
LW01	
LW02	
LW04	

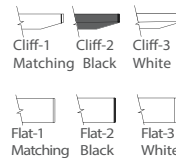

Thermally Fused Laminate Top

HNY7125WT163M	3262
HNY6218WT163M	3091

MOC
MEC
MSW
MTW
MWL
MNA





1 Select Model

Weight

Standard Veneer Top
Metal Base

Premium Veneer Top
Metal Base

High Pressure Laminate Top
Metal Base

Thermally Fused Laminate Top
Metal Base

w" x d" x h"	Weight	Standard Veneer Top Metal Base	Premium Veneer Top Metal Base
30 x 30 x 29	50	HNY3029TR379W 1137	"P" Option N/A
25 x 24 x 24	45	HNY2425TR379W 1072	"P" Option N/A
18 x 18 x 17	30	HNY1817TR379W 854	"P" Option N/A

[Click Here for Graded in Pricing](#)

2 Select Finish

Click to view finishes

WVP	PO07
PM01	PO08
PM02	PO09
PM03	
PM07	
PM08	
PM10	
PO01	
PO02	
PO03	

3 Select Feet Finish

Click to view edges

4 Select Edge

Click to view details

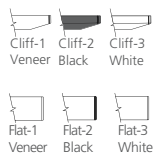

[Click here to view statement of line](#)

Product Features

- 1" Thick top
- Standard white metal base

Options

Premium Metal Finish - Table Base

- Specify Metal Finish for table base
- MFMB: Matte Black, MFS: Silver, MFSS: Salmon Sienna, MFSA: Surfin Aquavert, MFPS: Pistachio, MFOS: Oyster, MFNA: Navy, MFOL: Olive, MFGB: Grey Beige, MFGG: Graphite Gray, MFG: Gray - \$175

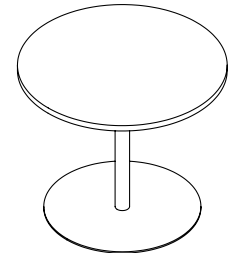

1 Select Model

Weight

w" x d" x h"	Weight	Standard Veneer Top Metal Base	Premium Veneer Top Metal Base	High Pressure Laminate Top Metal Base	Thermally Fused Laminate Top Metal Base
30 DIA x 29	50	HNY3029RD379W 1112	"P" Option N/A	HNY3029RD379G 1112	HNY3029RD379M 868
25 DIA x 24	45	HNY2425RD379W 1072	"P" Option N/A	HNY2425RD379G 1072	HNY2425RD379M 861
18 DIA x 17	30	HNY1817RD379W 889	"P" Option N/A	HNY1817RD379G 878	HNY1817RD379M 698

[Click Here for Graded in Pricing](#)

2 Select Finish

Click to view finishes

WWP	PO07
PM01	PO08
PM02	PO09
PM03	WEC
PM07	WBW
PM08	WSW
PM10	WOW
PO01	WNO
PO02	WSO
PO03	

3 Select Feet Finish

Click to view edges

4 Select Edge

Click to view details

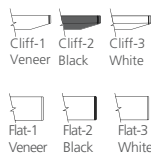

[Click here to view statement of line](#)

Product Features

- 1" Thick top
- Standard white metal base

Options

Premium Metal Finish - Table Base

- Specify Metal Finish for table base
- MFMB: Matte Black, MFS: Silver, MFSS: Salmon Sienna, MFSA: Surfin Aquavert, MFPS: Pistachio, MFOS: Oyster, MFNA: Navy, MFOL: Olive, MFGB: Grey Beige, MFGG: Graphite Gray, MFG: Gray - \$175

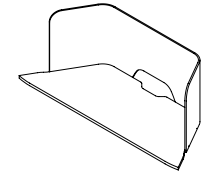

Top
not included

1 Select Model

Weight

Worksurface Screen
PET

w" x d" x h"	Weight	Model	Price
60 x 17 x 24	10	PS60	814

[Click Here for Graded in Pricing](#)

2 Select Finish

Click to view finishes

Finish N/A

3 Select Feet Finish

Click to view edges

4 Select Edge

Click to view details

Edge N/A

[Click here to view statement of line](#)

Product Features

- Screen attaches to worksurface top
- PET Screen 1/2" thick with rounded corners
- Composed of 100% polyester fiber
- 50% post-consumer recycled content
- Adds additional acoustical absorption

Notes

- Available on both 63" and 72" worksurfaces
- Only available on Height Adjustable Worksurfaces

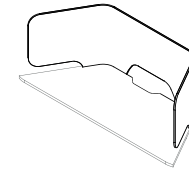

Top
not included

1 Select Model

Weight

Worksurface Screen
 Veneer Privacy Screen

w" x d" x h"	Weight	Model	Weight
69 x 24 x 24	30	VS64W	2102

[Click Here for Graded in Pricing](#)

2 Select Finish

Click to view finishes

PO01	WNO
PO02	WSO
PO03	
PO07	
PO08	
PO09	
WBW	
WSW	
WEC	
WOW	

3 Select Feet Finish

Click to view edges

4 Select Edge

Click to view details



Flat

[Click here to view statement of line](#)

Product Features

- Screens feature veneer on both sides with rounded corners
- 1/2" Thick screen
- Screen attaches to worksurface top

Notes

- Available on both 63" and 72" worksurfaces
- Only available on Height Adjustable Worksurfaces

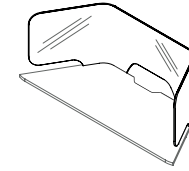

Top
not included

1 Select Model

w" x d" x h"
69 x 24 x 24

Weight

20

Worksurface Screen
Frosted Acrylic

AS64AF

1480

Worksurface Screen
Matte White Acrylic

AS64AW

1545

Worksurface Screen
Matte Black Acrylic

AS64AB

1545

[Click Here for Graded in Pricing](#)

2 Select Finish

Click to view finishes

AF

AW

AB

3 Select Feet Finish

Click to view edges

4 Select Edge

Click to view details



Flat



Flat



Flat

[Click here to view statement of line](#)

Product Features

- Acrylic screens with rounded corners
- 1/4" Thick screen
- Screen attaches to worksurface top

Notes

- Matte acrylic is not a writable surface
- Available on both 63" and 72" worksurfaces
- Only available on Height Adjustable Worksurfaces

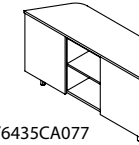

HNY6435CA077

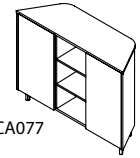

HNY6448CA077

1 Select Model

w" x d" x h"	Weight	Standard Veneer Case Solid Wood Feet	Premium Veneer Case Solid Wood Feet
64 x 20 x 48	180	HNY6448CA077W 4734	"P" Option N/A
64 x 20 x 35	140	HNY6435CA077W 4213	"P" Option N/A

[Click Here for Graded in Pricing](#)

2 Select Finish

Click to view finishes

Case Finishes	Leg Finishes
WWP	PO07 Oak on Flat
PM01	PO08 Cut)
PM02	PO09 WSF(Salted
PM03	WEC Oak on Flat
PM07	WBW Cut)
PM08	WSW
PM10	WOW
PO01	WNO
PO02	WSO
PO03	WNF(Natural

3 Select Feet Finish

Click to view edges

WWP	WOW
PO01	WNO
PO02	WSO
PO03	
PO07	
PO08	
PO09	
WBW	
WSW	
WEC	

4 Select Edge

Click to view details



Flat

High Pressure Laminate Case
Solid Wood Feet

HNY6448CA077G	4304
HNY6435CA077G	3831

Case Finishes Feet Finishes

GEC	LW05
GWL	LW06
LP01	
LF02	
LF03	
LN01	
LA02	
LW01	
LW02	
LW04	

WWP	WOW
PO01	WNO
PO02	WSO
PO03	
PO07	
PO08	
PO09	
WBW	
WSW	
WEC	



Flat

Thermally Fused Laminate Case
Solid Wood Feet

HNY6448CA077M	3391
HNY6435CA077M	2921

Case Finishes Feet Finishes

MOC
MEC
MSW
MTW
MWL
MNA

WWP	WOW
PO01	WNO
PO02	WSO
PO03	
PO07	
PO08	
PO09	
WEC	
WBW	
WSW	



Flat

[Click here to view statement of line](#)

Product Features

- 5" Solid wood feet - oval shape
- Dividers and shelves are finished to match case
- Sliding doors

Notes

- Not to be used as freestanding in open plan must slide into 120° panels

Options

Grommets (Vertical Surface)

- Standard location - \$50 each
- Black Plastic Vertical Surface: TM50-C (Bottom Center)
- Non-Standard Location - \$95 each
- Black Plastic Vertical Surface: TM50-NS

Premium Metal Finish

- Specify premium Metal Finish. MFMB: Matte Black, MFS: Silver, MFSS: Salmon Sienna, MFSA: Surfing Aquavert, MFPS: Pistachio, MFOS: Oyster, MFNA: Navy, MFOL: Olive, MFGB: Grey Beige MFGG: Graphite Gray, MFG: Gray
- Premium Metal Finish for MTL11 Metal Feet: \$20 ea

Metal Feet

- MTL11: Replace solid wood feet with metal feet, standard in MFW White - \$300 per wardrobe



HNY6435CA074W



HNY6448CA074W

1 Select Model

Weight

Standard Veneer Case
Solid Wood Feet

Premium Veneer Case
Solid Wood Feet

High Pressure Laminate Case
Solid Wood Feet

Thermally Fused Laminate Case
Solid Wood Feet

w" x d" x h"	Weight	Standard Veneer Case	Premium Veneer Case
64 x 20 x 48	150	HNY6448CA074W 3530	"P" Option N/A
64 x 20 x 35	120	HNY6435CA074W 3140	"P" Option N/A

[Click Here for Graded in Pricing](#)

2 Select Finish

Click to view finishes

Case Finishes	Leg Finishes
WWP	PO07 ral Oak on
PM01	PO08 Flat Cut)
PM02	PO09 WSF(Salted
PM03	WEC Oak on Flat
PM07	WBW Cut)
PM08	WSW
PM10	WOW
PO01	WNO
PO02	WSO
PO03	WNF(Natu-

3 Select Feet Finish

Click to view edges

WWP	WOW
PO01	WNO
PO02	WSO
PO03	
PO07	
PO08	
PO09	
WBW	
WSW	
WEC	

4 Select Edge

Click to view details



Flat

Case Finishes	Feet Finishes	Case Finishes	Feet Finishes
GEC	LW05	MOC	
GWL	LW06	MEC	
LP01		MSW	
LF02		MTW	
LF03		MWL	
LN01		MNA	
LA02			
LW01			
LW02			
LW04			

WWP	WOW	WWP	WOW
PO01	WNO	PO01	WNO
PO02	WSO	PO02	WSO
PO03		PO03	
PO07		PO07	
PO08		PO08	
PO09		PO09	
WBW		WEC	
WSW		WBW	
WEC		WSW	



Flat



Flat

[Click here to view statement of line](#)

Product Features

- 5" Solid wood feet - oval shape
- Dividers and shelves are finished to match case

Notes

- Not to be used as freestanding in open plan must slide into 120° panels

Options

Grommets (Vertical Surface)

- Standard location - \$50 each
- Black Plastic Vertical Surface: TM50-C (Bottom Center)
- Non-Standard Location - \$95 each
- Black Plastic Vertical Surface: TM50-NS

Premium Metal Finish

- Specify premium Metal Finish. MFMB: Matte Black, MFS: Silver, MFSS: Salmon Sienna, MFSA: Surfing Aquavert, MFPS: Pistachio, MFOS: Oyster, MFNA: Navy, MFOL: Olive, MFGB: Grey Beige MFGG: Graphite Gray, MFG: Gray
- Premium Metal Finish for MTL11 Metal Feet: \$20 ea

Metal Feet

- MTL11: Replace solid wood feet with metal feet, standard in MFW White - \$300 per wardrobe

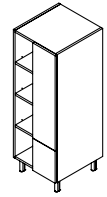

1 Select Model

w" x d" x h"
20 x 20 x 55

Weight
200

Standard Veneer Case
Solid Wood Feet
HNY2055TW300W 3228

Premium Veneer Case
Solid Wood Feet
"P" Option N/A

High Pressure Laminate Case
Solid Wood Feet
HNY2055TW300G 2935

Thermally Fused Laminate Case
Solid Wood Feet
HNY2055TW300M 2005

[Click here to view statement of line](#)

Product Features

- 5" Solid wood feet - oval shape
- Three fixed open shelves, pull out drawer and wardrobe
- Dividers and shelves are finished to match case
- Full extension drawers
- Finished tops
- Soft close suspensions
- Touch latch doors

[Click Here for Graded in Pricing](#)

2 Select Finish

[Click to view finishes](#)

Case Finishes	Leg Finishes
WWP	PO07 ral Oak on
PM01	PO08 Flat Cut)
PM02	PO09 WSF(Salted
PM03	WEC Oak on Flat
PM07	WBW Cut)
PM08	WSW
PM10	WOW
PO01	WNO
PO02	WSO
PO03	WNF(Natu-

Case Finishes	Feet Finishes	Case Finishes	Feet Finishes
GEC	LW05	MOC	
GWL	LW06	MEC	
LP01		MSW	
LF02		MTW	
LF03		MWL	
LN01		MNA	
LA02			
LW01			
LW02			
LW04			

Options

Door

- D2: Door Lock - \$100 per door set
- D6: Delete doors - n/c
- D9SC: Soft Close Door Hinges - \$20 per door

Drawer

- P33: Wood Drawer Upgrade - \$45 per drawer
- D2: Door Lock - \$100 per door set

Premium Metal Finish

- Specify premium Metal Finish. MFMB: Matte Black, MFS: Silver, MFSS: Salmon Sienna, MFSA: Surfing Aquavert, MFPS: Pistachio, MFOS: Oyster, MFNA: Navy, MFOL: Olive, MFGB: Grey Beige MFGG: Graphite Gray, MFG: Gray
- Premium Metal Finish for MTL11 Metal Feet: \$80 per wardrobe

Metal Feet

- MTL11: Replace solid wood feet with metal feet, standard in MFW White - \$300 per wardrobe

3 Select Feet Finish

[Click to view edges](#)

WWP	WOW
PO01	WNO
PO02	WSO
PO03	
PO07	
PO08	
PO09	
WBW	
WSW	
WEC	

WWP	WOW	WWP	WOW
PO01	WNO	PO01	WNO
PO02	WSO	PO02	WSO
PO03		PO03	
PO07		PO07	
PO08		PO08	
PO09		PO09	
WBW		WEC	
WSW		WBW	
WEC		WSW	

4 Select Edge

[Click to view details](#)



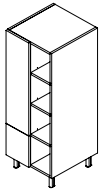

1 Select Model

w" x d" x h"
20 x 20 x 55

Weight	Standard Veneer Case Solid Wood Feet
200	HNY2055TW301W 3228

Premium Veneer Case Solid Wood Feet
"P" Option N/A

High Pressure Laminate Case Solid Wood Feet
HNY2055TW301G 2935

Thermally Fused Laminate Case Solid Wood Feet
HNY2055TW301M 2005

[Click here to view statement of line](#)

Product Features

- 5" Solid wood feet - oval shape
- Three fixed open shelves, pull out drawer and wardrobe
- Dividers and shelves are finished to match case
- Full extension drawers
- Finished tops
- Soft close suspensions
- Touch latch doors

[Click Here for Graded in Pricing](#)

2 Select Finish

Click to view finishes

Case Finishes	Leg Finishes
WWP	PO07 ral Oak on
PM01	PO08 Flat Cut)
PM02	PO09 WSF(Salted
PM03	WEC Oak on Flat
PM07	WBW Cut)
PM08	WSW
PM10	WOW
PO01	WNO
PO02	WSO
PO03	WNF(Natu-

Case Finishes	Feet Finishes	Case Finishes	Feet Finishes
GEC	LW05	MOC	
GWL	LW06	MEC	
LP01		MSW	
LF02		MTW	
LF03		MWL	
LN01		MNA	
LA02			
LW01			
LW02			
LW04			

Options

Door

- D2: Door Lock - \$100 per door set
- D6: Delete doors - n/c
- D9SC: Soft Close Door Hinges - \$20 per door

Drawer

- P33: Wood Drawer Upgrade - \$45 per drawer
- D2: Door Lock - \$100 per door set

Premium Metal Finish

- Specify premium Metal Finish. MFMB: Matte Black, MFS: Silver, MFSS: Salmon Sienna, MFSA: Surfing Aquavert, MFPS: Pistachio, MFOS: Oyster, MFNA: Navy, MFOL: Olive, MFGB: Grey Beige MFGG: Graphite Gray, MFG: Gray
- Premium Metal Finish for MTL11 Metal Feet: \$80 per wardrobe

Metal Feet

- MTL11: Replace solid wood feet with metal feet, standard in MFW White - \$300 per wardrobe

3 Select Feet Finish

Click to view edges

WWP	WOW
PO01	WNO
PO02	WSO
PO03	
PO07	
PO08	
PO09	
WBW	
WSW	
WEC	

WWP	WOW	WWP	WOW
PO01	WNO	PO01	WNO
PO02	WSO	PO02	WSO
PO03		PO03	
PO07		PO07	
PO08		PO08	
PO09		PO09	
WBW		WEC	
WSW		WBW	
WEC		WSW	

4 Select Edge

Click to view details



Flat



Flat



Flat

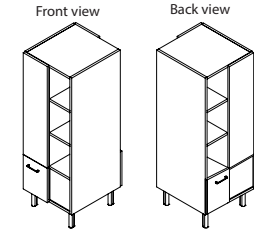

1 Select Model

w" x d" x h"
20 x 20 x 55

Weight

200

2 HNY2055TW299W 3717

Standard Veneer
Solid Wood Case

Premium Veneer
Solid Wood Case

"P" Option N/A

High Pressure Laminate
Solid Wood Case

HNY2055TW299G 3379

Thermally Fused Laminate
Solid Wood Case

HNY2055TW299M 2308

[Click here to view statement of line](#)

Product Features

- 5" Solid wood feet - oval shape
- Comes with three fixed shelves and pull out drawer on each side
- Full extension drawers
- Soft close suspensions
- Finished tops
- Touch latch doors

Notes

- Unit is designed for open plan use
- Sold as one unit

Options

Door

- D2: Door Lock - \$100 per door set
- D6: Delete doors - n/c
- D9SC: Soft Close Door Hinges - \$20 per door

Drawer

- P33: Wood Drawer Upgrade - \$45 per drawer
- D2: Door Lock - \$100 per door set

Premium Metal Finish

- Specify premium Metal Finish. MFMB: Matte Black, MFS: Silver, MFSS: Salmon Sienna, MFSA: Surfin Aquavert, MFPS: Pistachio, MFOS: Oyster, MFNA: Navy, MFOL: Olive, MFGB: Grey Beige MFGG: Graphite Gray, MFG: Gray
- Premium Metal Finish for MTL11 Metal Feet: \$80

Metal Feet

- MTL11: Replace solid wood feet with metal feet, standard in MFW White - \$300 per wardrobe

[Click Here for Graded in Pricing](#)

2 Select Finish

Click to view finishes

Case Finishes	Leg Finishes
WWP	PO07 ral Oak on
PM01	PO08 Flat Cut)
PM02	PO09 WSF(Salted
PM03	WEC Oak on Flat
PM07	WBW Cut)
PM08	WSW
PM10	WOW
PO01	WNO
PO02	WSO
PO03	WNF(Natu-

3 Select Feet Finish

Click to view edges

WWP	WOW
PO01	WNO
PO02	WSO
PO03	
PO07	
PO08	
PO09	
WBW	
WSW	
WEC	

4 Select Edge

Click to view details



Flat

Case Finishes	Feet Finishes	Case Finishes	Feet Finishes
GEC	LW05	MOC	
GWL	LW06	MEC	
LP01		MSW	
LF02		MTW	
LF03		MWL	
LN01		MNA	
LA02			
LW01			
LW02			
LW04			

WWP	WOW	WWP	WOW
PO01	WNO	PO01	WNO
PO02	WSO	PO02	WSO
PO03		PO03	
PO07		PO07	
PO08		PO08	
PO09		PO09	
WBW		WEC	
WSW		WBW	
WEC		WSW	



Flat



Flat

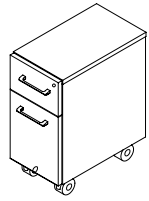

1 Select Model

w" x d" x h"
10 x 18 x 23

Weight
40

Standard Veneer Pedestal

HNY1018PD423W 1413

Premium Veneer Pedestal

"P" Option N/A

High Pressure Laminate Pedestal

HNY1018PD423G 1219

Thermally Fused Laminate Pedestal

HNY1018PD423M 1077

[Click here to view statement of line](#)

Product Features

- Product features.
- 3" Hollow white wheel caster, black caster available
 - Anti-tilt safety feature
 - Finished all sides and top - open plan
 - Full extension drawers
 - Drawer lock

Options

Cushion

- BC10: Bench Cushion
- Specify fabric grade (.5 yd. required)

Drawer

- P33: Wood Drawer Upgrade - \$45 per drawer

BC10 CUSHION FABRIC GRADES.

COM	COL	1	2	3
223	242	260	278	296
4	5	6	7	8
314	332	350	368	386
9	10	11	12	13
404	422	440	458	494

[Click Here for Graded in Pricing](#)

2 Select Finish

Click to view finishes

WWP	PO07	ral Oak on
PM01	PO08	Flat Cut)
PM02	PO09	WSF(Salted
PM03	WEC	Oak on Flat
PM07	WBW	Cut)
PM08	WSW	
PM10	WOW	
PO01	WNO	
PO02	WSO	
PO03	WNF(Natu-	

GEC	LW05
GWL	LW06
LP01	
LF02	
LF03	
LN01	
LA02	
LW01	
LW02	
LW04	

MOC
MEC
MSW
MTW
MWL
MNA

3 Select Feet Finish

Click to view edges

4 Select Edge

Click to view details



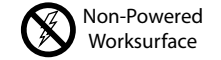
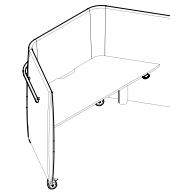

1 Select Model

Weight

Standard Veneer Top
Upholstered Panels - COM\$

Premium Veneer Top
Upholstered Panels - COM\$

High Pressure Laminate Top
Upholstered Panels - COM\$

Thermally Fused Laminate Top
Upholstered Panels - COM\$

w" x d" x h"
85 x 37 x 55

11.5

1 HNY8537HA569W 8758

"P" Option N/A

HNY8537HA569G 8559

HNY8537HA569M 8176

[Click here to view statement of line](#)

Product Features

- 1" Gap between worksurface and panels to drop wires below worksurface
- Programmable height adjustable mechanism, motor includes 2 year warranty
- Wood hand rails around outside mounted on wood standoffs
- 2 locking and 2 non-locking casters. Available in BK: Black (standard) or GR: Grey (optional)
- Adjustable height from 27" to 47.5" with a maximum weight capacity of 275 lbs. Lift standard in MFW White, optional MFB Black
- HNY7125WT163 Height Adjustable worksurfaces is included
- Wire management tray attaches to worksurface top, standard in MFW White, see premium Metal Finish for options
- T75 worksurface wire cutout is standard on all worksurfaces.(T75D: Delete cutout is optional)

[Click Here for Graded in Pricing](#)

2 Select Finish

[Click to view finishes](#)

Case Finishes

WWP	WNO
PO01	WSO
PO02	WEC
PO03	WNF(Natural Oak on Flat Cut)
PO07	WSF(Salted Oak on Flat Cut)
PO08	
PO09	
WBW	
WSW	
WOW	

Case Finishes

GEC	LW05
GWL	LW06
LP01	
LF02	
LF03	
LN01	
LA02	
LW01	
LW02	
LW04	

Case Finishes

MOC
MEC
MSW
MTW
MWL
MNA

Options

Accessories

- K28: Articulating Keyboard w/ Mouse - \$390
- K31-SK: Center drawer w/ skirt - \$310
- K31: Center drawer w/o skirt - \$205

Casters

- 2 locking and 2 non-locking casters. Available in BK: Black (standard) or GR: Grey (optional)

Premium Metal Finish

- Specify premium Metal Finish. MFMB: Matte Black, MFS: Silver, MFSS: Salmon Sienna, MFSA: Surfin Aquavert, MFPS: Pistachio, MFOS: Oyster, MFNA: Navy, MFOL: Olive, MFGB: Grey Beige, MFGG: Graphite Gray, MFG: Gray
- Premium Metal Finish for WMT Wire Management Tray - \$75 ea
- Premium Metal Finish for PCEB Concealed Floor Power Infeed Cover - \$35

Tully Inline Power

- PD-TULLY-IN-72: 2 power/dual USB up, 4 power down, 72" power cord - \$605
- PD-TULLY-IN-120: 2 power/dual USB up, 4 power down, 120" power cord - \$625

3 Select Feet Finish

[Click to view edges](#)

WWP	WOW
PO01	WNO
PO02	WSO
PO03	
PO07	
PO08	
PO09	
WBW	
WSW	
WEC	

WWP	WOW
PO01	WNO
PO02	WSO
PO03	
PO07	
PO08	
PO09	
WBW	
WSW	
WEC	

WWP	WOW
PO01	WNO
PO02	WSO
PO03	
PO07	
PO08	
PO09	
WEC	
WBW	
WSW	

4 Select Edge

[Click to view details](#)

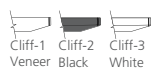

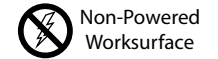
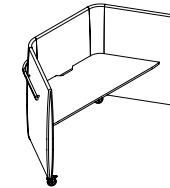

1 Select Model

Weight

Standard Veneer Top
Upholstered Panels - COM\$

Premium Veneer Top
Upholstered Panels - COM\$

High Pressure Laminate Top
Upholstered Panels - COM\$

Thermally Fused Laminate Top
Upholstered Panels - COM\$

w" x d" x h"
85 x 37 x 55 10.5 1 HNY8537FT569W 6239

"P" Option N/A

HNY8537FT569G 6039

HNY8537FT569M 5656

[Click here to view statement of line](#)

Product Features

- T75 worksurface wire cutout is standard on all worksurfaces.(T75D: Delete cutout is optional)
- Wood hand rails around outside mounted on wood standoffs
- 2 locking and 2 non-locking casters. Available in BK: Black (standard) or GR: Grey (optional)
- HNY7226WT162 Fixed Desk Height worksurfaces, 29" worksurface height
- Ships KD

[Click Here for Graded in Pricing](#)

2 Select Finish

[Click to view finishes](#)

Case Finishes

- | | |
|------|------------------------------|
| WWP | WNO |
| PO01 | WSO |
| PO02 | WEC |
| PO03 | WNF(Natural Oak on Flat Cut) |
| PO07 | WSF(Salted Oak on Flat Cut) |
| PO08 | |
| PO09 | |
| WBW | |
| WSW | |
| WOW | |

Case Finishes

- | | |
|------|------|
| GEC | LW05 |
| GWL | LW06 |
| LP01 | |
| LF02 | |
| LF03 | |
| LN01 | |
| LA02 | |
| LW01 | |
| LW02 | |
| LW04 | |

Leg Finishes

- | | |
|------|-----|
| WWP | WOW |
| PO01 | WNO |
| PO02 | WSO |
| PO03 | |
| PO07 | |
| PO08 | |
| PO09 | |
| WBW | |
| WSW | |
| WEC | |

Case Finishes Leg Finishes

- | | |
|------|-----|
| MOC | |
| MEC | |
| MSW | |
| MTW | |
| MWL | |
| MNA | |
| | |
| WWP | WOW |
| PO01 | WNO |
| PO02 | WSO |
| PO03 | |
| PO07 | |
| PO08 | |
| PO09 | |
| WEC | |
| WBW | |
| WSW | |

Options

Accessories

- K28: Articulating Keyboard w/ Mouse - \$390
- K31-SK: Center drawer w/ skirt - \$310
- K31: Center drawer w/o skirt - \$205

Casters

- 2 locking and 2 non-locking casters. Available in BK: Black (standard) or GR: Grey (optional)

Wire Tray

- WMT: Wire metal tray. Mounts under top and comes standard in MFW White - \$210

Premium Metal Finish

- Specify premium Metal Finish. MFMB: Matte Black, MFS: Silver, MFSS: Salmon Sienna, MFSA: Surfin Aquavert, MFPS: Pistachio, MFOS: Oyster, MFNA: Navy, MFOL: Olive, MFGB: Grey Beige MFGG: Graphite Gray, MFG: Gray
- Premium Metal Finish for WMT Wire Management Tray - \$75 ea

Tully Inline Power

- PD-TULLY-IN-72: 2 power/dual USB up, 4 power down, 72" power cord - \$605
- PD-TULLY-IN-120: 2 power/dual USB up, 4 power down, 120" power cord - \$625

3 Select Feet Finish

[Click to view edges](#)

- | | |
|------|-----|
| WWP | WOW |
| PO01 | WNO |
| PO02 | WSO |
| PO03 | |
| PO07 | |
| PO08 | |
| PO09 | |
| WBW | |
| WSW | |
| WEC | |

4 Select Edge

[Click to view details](#)

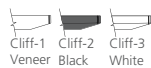



1 Select Model

Weight

Standard Veneer Top

Premium Veneer Top

High Pressure Laminate Top

Thermally Fused Laminate Top

w" x d" x h"
Left Return Desk Height
42 x 24 x 1

25

HNY4224WT167W 954

"P" Option N/A

HNY4224WT167G 755

HNY4224WT167M 490

Left Return Bar Height
42 x 24 x 1

25

HNY4224WT169W 954

"P" Option N/A

HNY4224WT169G 755

HNY4224WT169M 490

[Click Here for Graded in Pricing](#)

2 Select Finish

Click to view finishes

- | | |
|------|------------------------------|
| WWP | WNO |
| PO01 | WSO |
| PO02 | WEC |
| PO03 | WNF(Natural Oak on Flat Cut) |
| PO07 | WSF(Salted Oak on Flat Cut) |
| PO08 | |
| PO09 | |
| WBW | |
| WSW | |
| WOW | |

- GEC LW05
GWL LW06
LP01
LF02
LF03
LN01
LA02
LW01
LW02
LW04

- MOC
MEC
MSW
MTW
MWL
MNA

3 Select Feet Finish

Click to view edges

4 Select Edge

Click to view details

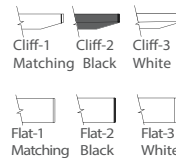
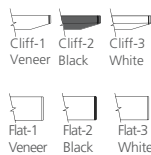

[Click here to view statement of line](#)

Product Features

- "W/G" worksurfaces are 1" thick, "M" worksurfaces are 1-1/8" thick
- Ships KD
- Includes mounting hardware
- Bar height 42"
- Desk Height 29"
- Cannot be sold freestanding, must hook to fixed worksurface desk

Notes

- PANELS NOT INCLUDED
- Desk sold separately

Options

Grommet (Standard Location)

Specify Color and Location Right/Left - \$50 ea.

- Black: TM30-R (Right), TM30-L (Left)
- Silver: TM31-R (Right), TM31-L (Left)
- White: TM34-R (Right), TM34-L (Left)

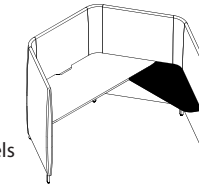

Desk and Panels
not included

Return shown in black
Pricing for return top only

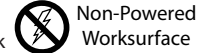

1 Select Model

Weight

Standard Veneer Top

Premium Veneer Top

High Pressure Laminate Top

Thermally Fused Laminate Top

w" x d" x h"
Right Return Desk Height
42 x 24 x 1 25

HNY4224WT168W 954

"P" Option N/A

HNY4224WT168G 755

HNY4224WT168M 490

Right Return Bar Height
42 x 24 x 1 25

HNY4224WT170W 954

"P" Option N/A

HNY4224WT170G 755

HNY4224WT170M 490

[Click Here for Graded in Pricing](#)

2 Select Finish

Click to view finishes

WWP	WNO
PO01	WSO
PO02	WEC
PO03	WNF(Natural Oak on Flat Cut)
PO07	WSF(Salted Oak on Flat Cut)
PO08	
PO09	
WBW	
WSW	
WOW	

GEC	LW05
GWL	LW06
LP01	
LF02	
LF03	
LN01	
LA02	
LW01	
LW02	
LW04	

MOC
MEC
MSW
MTW
MWL
MNA

[Click here to view statement of line](#)

Product Features

- "W/G" worksurfaces are 1" thick, "M" worksurfaces are 1-1/8" thick
- Ships KD
- Includes mounting hardware
- Bar height 42"
- Desk Height 29"
- Cannot be sold freestanding, must hook to fixed worksurface desk

Notes

- PANELS NOT INCLUDED
- Desk sold separately

Options

Grommet (Standard Location)

Specify Color and Location Right/Left - \$50 ea.

- Black: TM30-R (Right), TM30-L (Left)
- Silver: TM31-R (Right), TM31-L (Left)
- White: TM34-R (Right), TM34-L (Left)

3 Select Feet Finish

Click to view edges

4 Select Edge

Click to view details

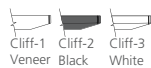

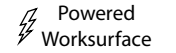
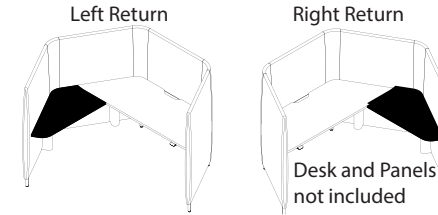

Return shown in black. Pricing for return top with lift only

[Click here to view statement of line](#)

1 Select Model

Weight	Standard Veneer Top		Premium Veneer Top		High Pressure Laminate Top		Thermally Fused Laminate Top	
w" x d" x h"								
Left Return 42 x 24 x 1	25	HNY4224WT165W 1913	"P" Option N/A	HNY4224WT165G 1673	HNY4224WT165M 1525			
Right Return 42 x 24 x 1	25	HNY4224WT166W 1913	"P" Option N/A	HNY4224WT166G 1673	HNY4224WT166M 1525			

[Click Here for Graded in Pricing](#)

2 Select Finish

Click to view finishes

WWP	WNO
PO01	WSO
PO02	WEC
PO03	WNF(Natural Oak on Flat Cut)
PO07	WSF(Salted Oak on Flat Cut)
PO08	
PO09	
WBW	
WSW	
WOW	

3 Select Feet Finish

Click to view edges

4 Select Edge

Click to view details

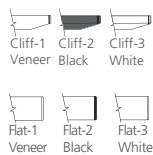

Product Features

- "W/G" worksurfaces are 1" thick, "M" worksurfaces are 1-1/8" thick
- Lift standard in MFW White, optional MFB Black
- Ships KD
- Includes mounting hardware
- Cannot be sold freestanding, must hook to lift desk

Notes

- 1" Gap between worksurface and panels to drop wires below worksurface
- Programmable height adjustable mechanism, motor includes 2 year warranty
- Height adjustable top with mechanism and wire tray only, panels not included
- Lift desk sold separately

Options

Grommet (Standard Location)

Specify Color and Location Right/Left - \$50 ea.

- Black: TM30-R (Right), TM30-L (Left)
- Silver: TM31-R (Right), TM31-L (Left)
- White: TM34-R (Right), TM34-L (Left)

DARRAN®



Honey 90 Degree

Effective June 2022

Designed By Mark Müller and Chris Wright

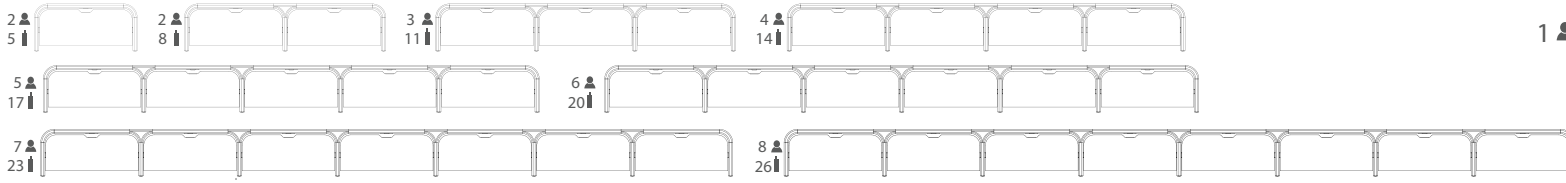

Number of Feet per Typical (MTL10 Option)



1 Select Model

w" x d" x h"	Weight	Standard Veneer Top Upholstered Panels - COM\$
563 x 34 x 55	8	HNY56334HA553W 61022
490 x 34 x 55	7	HNY49034HA553W 53584
421 x 34 x 55	6	HNY42134HA553W 46146
351 x 34 x 55	5	HNY35134HA553W 38708
282 x 34 x 55	4	HNY28234HA553W 31270
212 x 34 x 55	3	HNY21234HA553W 23832
143 x 34 x 55	2	HNY14334HA553W 16394
73 x 34 x 55	1	HNY7334HA553W 8956

2 Select Finish

Click to view finishes	WWP	WOW
	PO01	WNO
	PO02	WSO
	PO03	WNF(Natural Oak on Flat Cut)
	PO07	WSF(Salted Oak on Flat Cut)
	PO08	WSF(Salted Oak on Flat Cut)
	PO09	WSF(Salted Oak on Flat Cut)
	WBW	
	WSW	
	WEC	

3 Select Feet Finish

Click to view edges	WWP	WOW
	PO01	WNO
	PO02	WSO
	PO03	
	PO07	
	PO08	
	PO09	
	WBW	
	WSW	
	WEC	

4 Select Edge

Click to view details

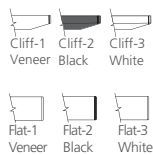

Premium Veneer Top Upholstered Panels - COM\$

"P" Option N/A
"P" Option N/A
"P" Option N/A
"P" Option N/A
"P" Option N/A
"P" Option N/A
"P" Option N/A
"P" Option N/A

High Pressure Laminate Top Upholstered Panels - COM\$

HNY56334HA553G	59414
HNY49034HA553G	52177
HNY42134HA553G	44940
HNY35134HA553G	37703
HNY28234HA553G	30466
HNY21234HA553G	23229
HNY14334HA553G	15992
HNY7334HA553G	8755

GEC	LW04
GNA +5%	LW05
GWL	LW06
LP01	
LF02	
LF03	
LN01	
LA02	
LW01	
LW02	

WWP	WOW
PO01	WNO
PO02	WSO
PO03	
PO07	
PO08	
PO09	
WBW	
WSW	
WEC	



Thermally Fused Laminate Top Upholstered Panels - COM\$

HNY56334HA553M	56358
HNY49034HA553M	49503
HNY42134HA553M	42648
HNY35134HA553M	35793
HNY28234HA553M	28938
HNY21234HA553M	22083
HNY14334HA553M	15228
HNY7334HA553M	8373

MOC
MEC
MSW
MTW
MWL
MNA

WWP	WOW
PO01	WNO
PO02	WSO
PO03	
PO07	
PO08	
PO09	
WEC	
WBW	
WSW	



Click here to view statement of line

Product Features

- HNY6625WT163 Height Adjustable worksurfaces are included
- 5" Solid wood feet - oval shape
- 4 Power outlets with 1 telecom plate, see options below for telecom plate
- Ships KD
- Wire management tray attaches to worksurface top, standard in MFW White, see premium Metal Finish for options
- Hardwire infeed and jumpers are included in workstations
- T75 worksurface wire cutout is standard on all worksurfaces.(T75D: Delete cutout is optional)

Options

Accessories

- K28: Articulating Keyboard w/ Mouse - \$390
- K31-SK: Center drawer w/ skirt - \$310
- K31: Center drawer w/o skirt - \$205

Concealed Floor Power Infeed Cover

- PCEB: White Metal Finish concealed floor power infeed cover - \$150

Delete Top and Wire Tray

- DHAT: Delete height adjustable top. Deduct \$3845 Veneer(W), \$3644 High Pressure Laminate(G), \$3262 Thermally Fused Laminate(M) per top

Metal Feet

- MTL10: Replace solid wood feet with metal feet, standard MFW White - \$55 ea

Premium Metal Finish

- Specify premium Metal Finish. MFMB: Matte Black, MFS: Silver, MFSS: Salmon Sienna, MFSA: Surfing Aquavert, MFPS: Pistachio, MFOS: Oyster, MFNA: Navy, MFOL: Olive, MFGB: Grey Beige MFGG: Graphite Gray, MFG: Gray, MFGM: Matte Gold
- Premium Metal Finish for WMT Wire Management Tray - \$75 ea
- Premium Metal Finish for MTL10 Metal Feet - \$20 ea
- Premium Metal Finish for PCEB Concealed Floor Power Infeed Cover - \$35

Telecom Plates

- Each power unit has 1 plate. All telecom connectors sold separately.
- RJ45 (1) - \$55, RJ45 (2) - \$110, RJ45 (3) - \$165, USB (1) - \$70, USB (2) - \$140, RJ45/USB - \$125, RJ45/HDMI - \$210, HDMI/USB - \$205

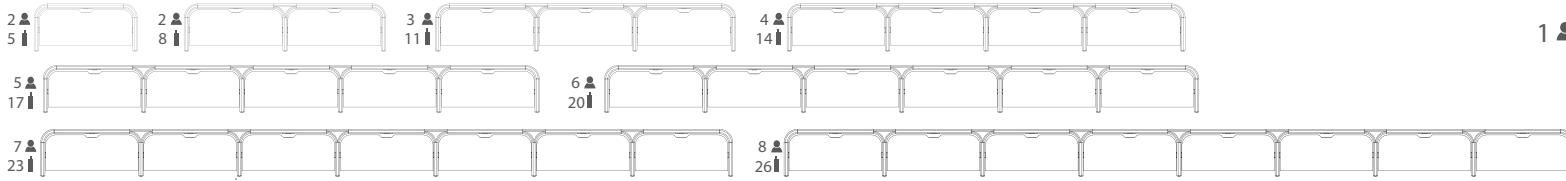

Number of Feet per Typical (MTL10 Option)

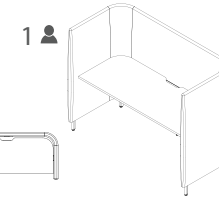

Fixed Top Workstation

Powered Workstation

1 Select Model

Weight

Standard Veneer Top Upholstered Panels - COM\$

Premium Veneer Top Upholstered Panels - COM\$

High Pressure Laminate Top Upholstered Panels - COM\$

Thermally Fused Laminate Top Upholstered Panels - COM\$

w" x d" x h"	Weight	Standard Veneer Top Upholstered Panels - COM\$
563 x 34 x 55	8	42542
490 x 34 x 55	7	37414
421 x 34 x 55	6	32286
351 x 34 x 55	5	27158
282 x 34 x 55	4	22030
212 x 34 x 55	3	16902
143 x 34 x 55	2	11774
73 x 34 x 55	1	6646

"P" Option N/A
"P" Option N/A
"P" Option N/A
"P" Option N/A
"P" Option N/A
"P" Option N/A
"P" Option N/A
"P" Option N/A

Model	Weight	Price
HNY56334FP553G	8	40942
HNY49034FP553G	7	36014
HNY42134FP553G	6	31086
HNY35134FP553G	5	26158
HNY28234FP553G	4	21230
HNY21234FP553G	3	16302
HNY14334FP553G	2	11374
HNY7334FP553G	1	6446

Model	Weight	Price
HNY56334FP553M	8	37886
HNY49034FP553M	7	33340
HNY42134FP553M	6	28794
HNY35134FP553M	5	24248
HNY28234FP553M	4	19702
HNY21234FP553M	3	15156
HNY14334FP553M	2	10610
HNY7334FP553M	1	6064

[Click here to view statement of line](#)

Product Features

- HNY6625WT162 Fixed Desk Height Worksurfaces are included
- 5" Solid wood feet - oval shape
- 4 Power outlets with 1 telecom plate, see options below for telecom plate
- Ships KD
- Wire management tray attaches to worksurface top, standard in MFW White, see premium Metal Finish for options
- Hardwire infeed and jumpers are included in workstations
- T75 worksurface wire cutout is standard on all worksurfaces.(T75D: Delete cutout is optional)

[Click Here for Graded in Pricing](#)

2 Select Finish

Click to view finishes

WWP	WOW
PO01	WNO
PO02	WSO
PO03	WNF(Natural Oak on Flat Cut)
PO07	WSF(Salted Oak on Flat Cut)
PO08	WSF(Salted Oak on Flat Cut)
PO09	WSO
WBW	
WSW	
WEC	

GEC	LW04
GNA +5%	LW05
GWL	LW06
LP01	
LF02	
LF03	
LN01	
LA02	
LW01	
LW02	

MOC
MEC
MSW
MTW
MWL
MNA

3 Select Feet Finish

Click to view edges

WWP	WOW
PO01	WNO
PO02	WSO
PO03	
PO07	
PO08	
PO09	
WBW	
WSW	
WEC	

WWP	WOW
PO01	WNO
PO02	WSO
PO03	
PO07	
PO08	
PO09	
WBW	
WSW	
WEC	

WWP	WOW
PO01	WNO
PO02	WSO
PO03	
PO07	
PO08	
PO09	
WEC	
WBW	
WSW	

4 Select Edge

Click to view details



Options

Accessories

- K28: Articulating Keyboard w/ Mouse - \$390
- K31-SK: Center drawer w/ skirt - \$310
- K31: Center drawer w/o skirt - \$205

Concealed Floor Power Infeed Cover

- PCEB: White Metal Finish concealed floor power infeed cover - \$150

Delete Top and Wire Tray

- DFP: Delete fixed top. Deduct \$1535 Veneer (W), \$1335 High Pressure Laminate (G), \$953 Thermally Fused Laminate (M) per top

Metal Feet

- MTL10: Replace solid wood feet with metal feet, standard MFW White - \$55 ea

Premium Metal Finish

- Specify premium Metal Finish. MFMB: Matte Black, MFS: Silver, MFSS: Salmon Sienna, MFSA: Surfing Aquavert, MFPS: Pistachio, MFOS: Oyster, MFNA: Navy, MFOL: Olive, MFGB: Grey Beige MFGG: Graphite Gray, MFG: Gray, MFGM: Matte Gold
- Premium Metal Finish for WMT Wire Management Tray - \$75 ea
- Premium Metal Finish for MTL10 Metal Feet - \$20 ea
- Premium Metal Finish for PCEB Concealed Floor Power Infeed Cover - \$35

Telecom Plates

- Each power unit has 1 plate. All telecom connectors sold separately.
- RJ45 (1) - \$55, RJ45 (2) - \$110, RJ45 (3) - \$165, USB (1) - \$70, USB (2) - \$140, RJ45/USB - \$125, RJ45/HDMI - \$210, HDMI/USB - \$205

Worksurface Height

- THL-42: Modify worksurface height to bar height - N/C

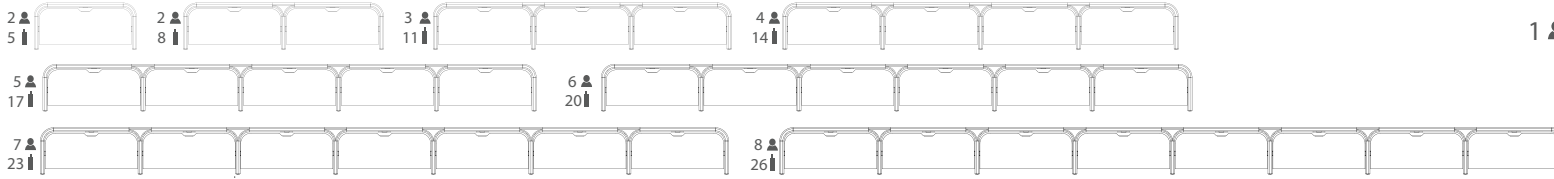

Number of Feet per Typical (MTL10 Option)



1 Select Model

Weight

Standard Veneer Top Upholstered Panels - COM\$

Premium Veneer Top Upholstered Panels - COM\$

High Pressure Laminate Top Upholstered Panels - COM\$

Thermally Fused Laminate Top Upholstered Panels - COM\$

563 x 34 x 55	8	HNY56334FT553W	36928
490 x 34 x 55	7	HNY49034FT553W	32478
421 x 34 x 55	6	HNY42134FT553W	28028
351 x 34 x 55	5	HNY35134FT553W	23578
282 x 34 x 55	4	HNY28234FT553W	19128
212 x 34 x 55	3	HNY21234FT553W	14678
143 x 34 x 55	2	HNY14334FT553W	10228
73 x 34 x 55	1	HNY7334FT553W	5778

"P" Option N/A
"P" Option N/A
"P" Option N/A
"P" Option N/A
"P" Option N/A
"P" Option N/A
"P" Option N/A
"P" Option N/A

HNY56334FT553G	35328
HNY49034FT553G	31078
HNY42134FT553G	26828
HNY35134FT553G	22578
HNY28234FT553G	18328
HNY21234FT553G	14078
HNY14334FT553G	9828
HNY7334FT553G	5578

HNY56334FT553M	32272
HNY49034FT553M	28404
HNY42134FT553M	24536
HNY35134FT553M	20668
HNY28234FT553M	16800
HNY21234FT553M	12932
HNY14334FT553M	9064
HNY7334FT553M	5196

[Click here to view statement of line](#)

Product Features

- HNY6625WT162 Fixed Desk Height Worksurfaces are included
- 5" Solid wood feet - oval shape
- Ships KD
- T75 worksurface wire cutout is standard on all worksurfaces.(T75D: Delete cutout is optional)

Options

Accessories

- K28: Articulating Keyboard w/ Mouse - \$390
- K31-SK: Center drawer w/ skirt - \$310
- K31: Center drawer w/o skirt - \$205

Delete Top

- DFT: Delete fixed top. Deduct \$1325 Veneer(W), \$1125 High Pressure Laminate (G), \$743 Thermally Fused Laminate (M) per top

Metal Feet

- MTL10: Replace solid wood feet with metal feet, standard MFW White - \$55 ea

Premium Metal Finish

- Specify premium Metal Finish. MFMB: Matte Black, MFS: Silver, MFSS: Salmon Sienna, MFSA: Surfing Aquavert, MFPS: Pistachio, MFOS: Oyster, MFNA: Navy, MFOL: Olive, MFGB: Grey Beige MFGG: Graphite Gray, MFG: Gray, MFGM: Matte Gold
- Premium Metal Finish for WMT Wire Management Tray - \$75 ea
- Premium Metal Finish for MTL10 Metal Feet - \$20 ea
- Premium Metal Finish for PCEB Concealed Floor Power Infeed Cover - \$35

Premium Metal Finish

- Specify premium Metal Finish. MFMB: Matte Black, MFS: Silver, MFSS: Salmon Sienna, MFSA: Surfing Aquavert, MFPS: Pistachio, MFOS: Oyster, MFNA: Navy, MFOL: Olive, MFGB: Grey Beige MFGG: Graphite Gray, MFG: Gray, MFGM: Matte Gold
- Premium Metal Finish for WMT Wire Management Tray - \$75 ea
- Premium Metal Finish for MTL10 Metal Feet - \$20 ea
- Premium Metal Finish for PCEB Concealed Floor Power Infeed Cover - \$35

Worksurface Height

Wire Tray

- WMT: Wire metal tray. Mounts under top and comes standard in MFW White - \$210

[Click Here for Graded in Pricing](#)

2 Select Finish

Click to view finishes

WWP	WOW
PO01	WNO
PO02	WSO
PO03	WNF(Natural Oak on Flat Cut)
PO07	WSF(Salted Oak on Flat Cut)
PO08	WSF(Salted Oak on Flat Cut)
PO09	
WBW	
WSW	
WEC	

GEC	LW04
GNA +5%	LW05
GWL	LW06
LP01	
LF02	
LF03	
LN01	
LA02	
LW01	
LW02	

MOC
MEC
MSW
MTW
MWL
MNA

3 Select Feet Finish

Click to view edges

WWP	WOW
PO01	WNO
PO02	WSO
PO03	
PO07	
PO08	
PO09	
WBW	
WSW	
WEC	

WWP	WOW
PO01	WNO
PO02	WSO
PO03	
PO07	
PO08	
PO09	
WBW	
WSW	
WEC	

WWP	WOW
PO01	WNO
PO02	WSO
PO03	
PO07	
PO08	
PO09	
WBW	
WSW	

4 Select Edge

Click to view details

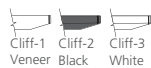

DARRAN

Honey

Inline 90° Workstation Typical
Position 2 Desk with Height Adjustable Worksurface

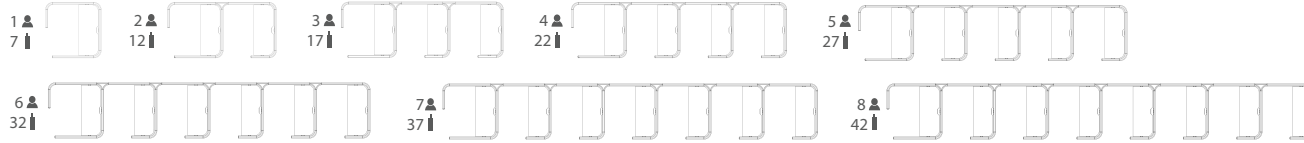

Number of Feet per Typical (MTL10 Option)

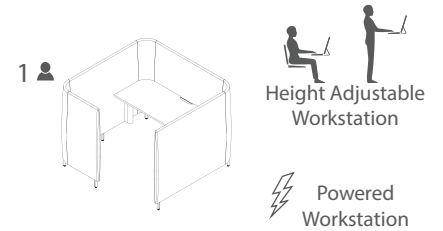

1 Select Model

w" x d" x h"
 560 x 73 x 55
 491 x 73 x 55
 421 x 73 x 55
 352 x 73 x 55
 282 x 73 x 55
 212 x 73 x 55
 143 x 73 x 55
 73 x 73 x 55

Weight

Standard Veneer Top
Upholstered Panels - COM\$

8	HNY56073HA554W	78135
7	HNY49173HA554W	68598
6	HNY42173HA554W	59061
5	HNY35273HA554W	49524
4	HNY28273HA554W	39987
3	HNY21273HA554W	30450
2	HNY14373HA554W	20913
1	HNY7373HA554W	11376

Premium Veneer Top
Upholstered Panels - COM\$

"P"	Option N/A
"P"	Option N/A
"P"	Option N/A
"P"	Option N/A
"P"	Option N/A
"P"	Option N/A
"P"	Option N/A
"P"	Option N/A
"P"	Option N/A

High Pressure Laminate Top
Upholstered Panels - COM\$

HNY56073HA554G	76527
HNY49173HA554G	67191
HNY42173HA554G	57855
HNY35273HA554G	48519
HNY28273HA554G	39183
HNY21273HA554G	29847
HNY14373HA554G	20511
HNY7373HA554G	11175

Thermally Fused Laminate Top
Upholstered Panels - COM\$

HNY56073HA554M	73471
HNY49173HA554M	64517
HNY42173HA554M	55563
HNY35273HA554M	46609
HNY28273HA554M	37655
HNY21273HA554M	28701
HNY14373HA554M	19747
HNY7373HA554M	10793

[Click here to view statement of line](#)

Product Features

- HNY6625WT163 Height Adjustable worksurfaces are included
- 5" Solid wood feet - oval shape
- 4 Power outlets with 1 telecom plate, see options below for telecom plate
- Ships KD
- Wire management tray attaches to worksurface top, standard in MFW White, see premium Metal Finish for options
- Hardwire infeed and jumpers are included in workstations
- T75 worksurface wire cutout is standard on all worksurfaces.(T75D: Delete cutout is optional)

[Click Here for Graded in Pricing](#)

2 Select Finish

Click to view finishes

WWP	WOW
PO01	WNO
PO02	WSO
PO03	WNF(Natural Oak on Flat Cut)
PO07	WSF(Salted Oak on Flat Cut)
PO08	WSF(Salted Oak on Flat Cut)
PO09	WSF(Salted Oak on Flat Cut)
WBW	
WSW	
WEC	

GEC	LW04
GNA +5%	LW05
GWL	LW06
LP01	
LF02	
LF03	
LN01	
LA02	
LW01	
LW02	

MOC
MEC
MSW
MTW
MWL
MNA

3 Select Feet Finish

Click to view edges

WWP	WOW
PO01	WNO
PO02	WSO
PO03	
PO07	
PO08	
PO09	
WBW	
WSW	
WEC	

WWP	WOW
PO01	WNO
PO02	WSO
PO03	
PO07	
PO08	
PO09	
WBW	
WSW	
WEC	

WWP	WOW
PO01	WNO
PO02	WSO
PO03	
PO07	
PO08	
PO09	
WEC	
WBW	
WSW	

4 Select Edge

Click to view details

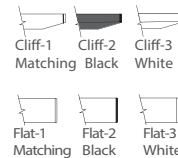

Options

Accessories

- K28: Articulating Keyboard w/ Mouse - \$390
- K31-SK: Center drawer w/ skirt - \$310
- K31: Center drawer w/o skirt - \$205

Concealed Floor Power Infeed Cover

- PCEB: White Metal Finish concealed floor power infeed cover - \$150

Delete Top and Wire Tray

- DHAT: Delete height adjustable top. Deduct \$3845 Veneer(W), \$3644 High Pressure Laminate(G), \$3262 Thermally Fused Laminate(M) per top

Metal Feet

- MTL10: Replace solid wood feet with metal feet, standard MFW White - \$55 ea

Premium Metal Finish

- Specify premium Metal Finish. MFMB: Matte Black, MFS: Silver, MFSS: Salmon Sienna, MFSA: SurfIn Aquavert, MFPS: Pistachio, MFOS: Oyster, MFNA: Navy, MFOL: Olive, MFGB: Grey Beige MFGG: Graphite Gray, MFG: Gray, MFGM: Matte Gold
- Premium Metal Finish for WMT Wire Management Tray - \$75 ea
- Premium Metal Finish for MTL10 Metal Feet - \$20 ea
- Premium Metal Finish for PCEB Concealed Floor Power Infeed Cover - \$35

Telecom Plates

- Each power unit has 1 plate. All telecom connectors sold separately.
- RJ45 (1) - \$55, RJ45 (2) - \$110, RJ45 (3) - \$165, USB (1) - \$70, USB (2) - \$140, RJ45/USB - \$125, RJ45/HDMI - \$210, HDMI/USB - \$205

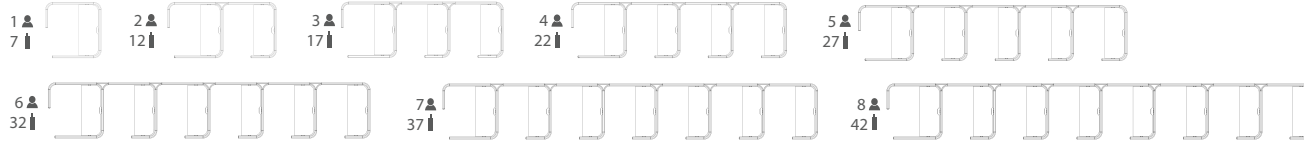

Number of Feet per Typical (MTL10 Option)

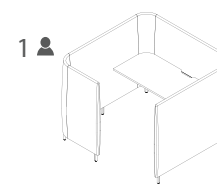

Fixed Top Workstation

Powered Workstation

1 Select Model

w" x d" x h"

Weight	Standard Veneer Top Upholstered Panels - COM\$	Premium Veneer Top Upholstered Panels - COM\$	High Pressure Laminate Top Upholstered Panels - COM\$	Thermally Fused Laminate Top Upholstered Panels - COM\$
560 x 73 x 55	8 HNY56073FP554W 59655	"P" Option N/A	HNY56073FP554G 58055	HNY56073FP554M 54999
491 x 73 x 55	7 HNY49173FP554W 52428	"P" Option N/A	HNY49173FP554G 51028	HNY49173FP554M 48354
421 x 73 x 55	6 HNY42173FP554W 45201	"P" Option N/A	HNY42173FP554G 44001	HNY42173FP554M 41709
351 x 73 x 55	5 HNY35173FP554W 37797	"P" Option N/A	HNY35173FP554G 36800	HNY35173FP554M 34887
282 x 73 x 55	4 HNY28273FP554W 30747	"P" Option N/A	HNY28273FP554G 29947	HNY28273FP554M 28419
212 x 73 x 55	3 HNY21273FP554W 23520	"P" Option N/A	HNY21273FP554G 22920	HNY21273FP554M 21774
143 x 73 x 55	2 HNY14373FP554W 16293	"P" Option N/A	HNY14373FP554G 15893	HNY14373FP554M 15129
73 x 73 x 55	1 HNY7373FP554W 9066	"P" Option N/A	HNY7373FP554G 8866	HNY7373FP554M 8484

[Click Here for Graded in Pricing](#)

2 Select Finish

Click to view finishes

WWP	WOW
PO01	WNO
PO02	WSO
PO03	WNF(Natural Oak on Flat Cut)
PO07	WSF(Salted Oak on Flat Cut)
PO08	WSF(Salted Oak on Flat Cut)
PO09	WSF(Salted Oak on Flat Cut)
WBW	
WSW	
WEC	

3 Select Feet Finish

Click to view edges

WWP	WOW
PO01	WNO
PO02	WSO
PO03	
PO07	
PO08	
PO09	
WBW	
WSW	
WEC	

4 Select Edge

Click to view details



GEC	LW04
GNA +5%	LW05
GWL	LW06
LP01	
LF02	
LF03	
LN01	
LA02	
LW01	
LW02	

WWP	WOW
PO01	WNO
PO02	WSO
PO03	
PO07	
PO08	
PO09	
WBW	
WSW	
WEC	

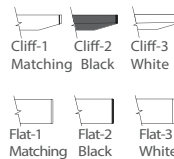

MOC
MEC
MSW
MTW
MWL
MNA

WWP	WOW
PO01	WNO
PO02	WSO
PO03	
PO07	
PO08	
PO09	
WEC	
WBW	
WSW	



[Click here to view statement of line](#)

Product Features

- HNY6625WT162 Fixed Desk Height Worksurfaces are included
- 5" Solid wood feet - oval shape
- 4 Power outlets with 1 telecom plate, see options below for telecom plate
- Ships KD
- Wire management tray attaches to worksurface top, standard in MFW White, see premium Metal Finish for options
- Hardwire infeed and jumpers are included in workstations
- T75 worksurface wire cutout is standard on all worksurfaces.(T75D: Delete cutout is optional)

Options

Accessories

- K28: Articulating Keyboard w/ Mouse - \$390
- K31-SK: Center drawer w/ skirt - \$310
- K31: Center drawer w/o skirt - \$205

Concealed Floor Power Infeed Cover

- PCEB: White Metal Finish concealed floor power infeed cover - \$150

Delete Top and Wire Tray

- DFP: Delete fixed top. Deduct \$1535 Veneer (W), \$1335 High Pressure Laminate (G), \$953 Thermally Fused Laminate (M) per top

Metal Feet

- MTL10: Replace solid wood feet with metal feet, standard MFW White - \$55 ea

Premium Metal Finish

- Specify premium Metal Finish. MFMB: Matte Black, MFS: Silver, MFSS: Salmon Sienna, MFSA: SurfIn Aquavert, MFPS: Pistachio, MFOS: Oyster, MFNA: Navy, MFOL: Olive, MFGB: Grey Beige MFGG: Graphite Gray, MFG: Gray, MFGM: Matte Gold
- Premium Metal Finish for WMT Wire Management Tray - \$75 ea
- Premium Metal Finish for MTL10 Metal Feet - \$20 ea
- Premium Metal Finish for PCEB Concealed Floor Power Infeed Cover - \$35

Telecom Plates

- Each power unit has 1 plate. All telecom connectors sold separately.
- RJ45 (1) - \$55, RJ45 (2) - \$110, RJ45 (3) - \$165, USB (1) - \$70, USB (2) - \$140, RJ45/USB - \$125, RJ45/HDMI - \$210, HDMI/USB - \$205

Worksurface Height

- THL-42: Modify worksurface height to bar height - N/C

DARRAN

Honey

Inline 90° Workstation Typical
Position 2 Desk with Fixed Worksurface

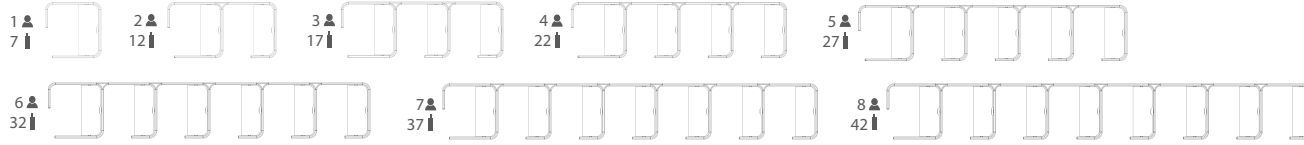

Number of Feet per Typical (MTL10 Option)

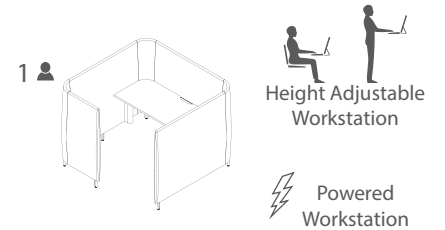

1 Select Model

Weight

Standard Veneer Top Upholstered Panels - COM\$

Premium Veneer Top Upholstered Panels - COM\$

High Pressure Laminate Top Upholstered Panels - COM\$

Thermally Fused Laminate Top Upholstered Panels - COM\$

560 x 73 x 55	8	HNY56073FT554W	52887
491 x 73 x 55	7	HNY49173FT554W	46496
421 x 34 x 55	6	HNY42134FT554W	40105
352 x 73 x 55	5	HNY35273FT554W	33714
282 x 73 x 55	4	HNY28273FT554W	27323
212 x 73 x 55	3	HNY21273FT554W	20932
143 x 73 x 55	2	HNY14373FT554W	14541
73 x 73 x 55	1	HNY7373FT554W	8150

"P" Option N/A			
"P" Option N/A			
"P" Option N/A			
"P" Option N/A			
"P" Option N/A			
"P" Option N/A			
"P" Option N/A			
"P" Option N/A			

HNY56073FT554G	51287
HNY49173FT554G	45096
HNY42134FT554G	38905
HNY35273FT554G	32714
HNY28273FT554G	26523
HNY21273FT554G	20332
HNY14373FT554G	14141
HNY7373FT554G	7950

HNY56073FT554M	48231
HNY49173FT554M	42422
HNY42134FT554M	36613
HNY35273FT554M	30804
HNY28273FT554M	24995
HNY21273FT554M	19186
HNY14373FT554M	13377
HNY7373FT554M	7568

[Click Here for Graded in Pricing](#)

2 Select Finish

Click to view finishes

WWP	WOW
PO01	WNO
PO02	WSO
PO03	WNF(Natural Oak on Flat Cut)
PO07	WSF(Salted Oak on Flat Cut)
PO08	WSF(Salted Oak on Flat Cut)
PO09	WSF(Salted Oak on Flat Cut)
WBW	
WSW	
WEC	

3 Select Feet Finish

Click to view edges

WWP	WOW
PO01	WNO
PO02	WSO
PO03	
PO07	
PO08	
PO09	
WBW	
WSW	
WEC	

4 Select Edge

Click to view details

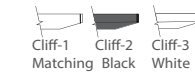
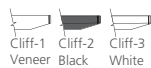

[Click here to view statement of line](#)

Product Features

- HNY6625WT162 Fixed Desk Height Worksurfaces are included
- 5" Solid wood feet - oval shape
- Ships KD
- T75 worksurface wire cutout is standard on all worksurfaces.(T75D: Delete cutout is optional)

Options

Accessories

- K28: Articulating Keyboard w/ Mouse - \$390
- K31-SK: Center drawer w/ skirt - \$310
- K31: Center drawer w/o skirt - \$205

Delete Top

- DFT: Delete fixed top. Deduct \$1325 Veneer(W), \$1125 High Pressure Laminate (G), \$743 Thermally Fused Laminate (M) per top

Metal Feet

- MTL10: Replace solid wood feet with metal feet, standard MFW White - \$55 ea

Premium Metal Finish

- Specify premium Metal Finish. MFMB: Matte Black, MFS: Silver, MFSS: Salmon Sienna, MFSA: Surfing Aquavert, MFPS: Pistachio, MFOS: Oyster, MFNA: Navy, MFOL: Olive, MFGB: Grey Beige MFGG: Graphite Gray, MFG: Gray, MFGM: Matte Gold
- Premium Metal Finish for WMT Wire Management Tray - \$75 ea
- Premium Metal Finish for MTL10 Metal Feet - \$20 ea
- Premium Metal Finish for PCEB Concealed Floor Power Infeed Cover - \$35

Worksurface Height

- THL-42: Modify worksurface height to bar height - N/C

Wire Tray

- WMT: Wire metal tray. Mounts under top and comes standard in MFW White - \$210

DARRAN

Honey

Inline 90° Workstation Typical
Position 3 Desk with Height Adjustable Worksurface

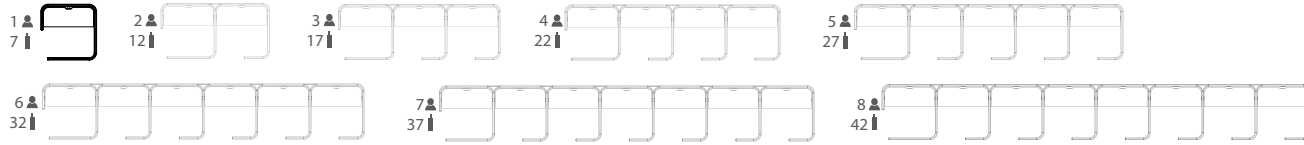

Number of Feet per Typical (MTL10 Option)

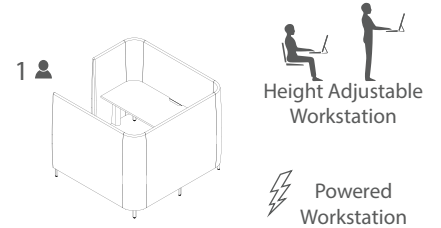

1 Select Model

Weight

Standard Veneer Top Upholstered Panels - COM\$

Premium Veneer Top Upholstered Panels - COM\$

High Pressure Laminate Top Upholstered Panels - COM\$

Thermally Fused Laminate Top Upholstered Panels - COM\$

560 x 73 x 55	8	HNY56073HA555W	77365
491 x 73 x 55	7	HNY49173HA555W	67938
421 x 73 x 55	6	HNY42173HA555W	58511
352 X 73 X 55	5	HNY35273HA555W	49084
282 x 73 x 55	4	HNY28273HA555W	39657
212 x 73 x 55	3	HNY21273HA555W	30230
143 x 73 x 55	2	HNY14373HA555W	20803
73 x 73 x 55	1	HNY7373HA555W	10254

"P" Option N/A
"P" Option N/A
"P" Option N/A
"P" Option N/A
"P" Option N/A
"P" Option N/A
"P" Option N/A
"P" Option N/A

HNY56073HA555G	75757
HNY49173HA555G	66531
HNY42173HA555G	57305
HNY35273HA555G	48079
HNY28273HA555G	38853
HNY21273HA555G	29627
HNY14373HA555G	20401
HNY7373HA555G	11175

HNY56073HA555M	72701
HNY49173HA555M	63857
HNY42173HA555M	55013
HNY35273HA555M	46169
HNY28273HA555M	37325
HNY21273HA555M	28481
HNY14373HA555M	19637
HNY7373HA555M	10793

[Click here to view statement of line](#)

Product Features

- HNY6625WT163 Height Adjustable worksurfaces are included
- 5" Solid wood feet - oval shape
- 4 Power outlets with 1 telecom plate, see options below for telecom plate
- Ships KD
- Wire management tray attaches to worksurface top, standard in MFW White, see premium Metal Finish for options
- Hardwire infeed and jumpers are included in workstations
- T75 worksurface wire cutout is standard on all worksurfaces.(T75D: Delete cutout is optional)

[Click Here for Graded in Pricing](#)

2 Select Finish

Click to view finishes

WWP	WOW
PO01	WNO
PO02	WSO
PO03	WNF(Natural Oak on Flat Cut)
PO07	WSF(Salted Oak on Flat Cut)
PO08	WSF(Salted Oak on Flat Cut)
PO09	WSF(Salted Oak on Flat Cut)
WBW	
WSW	
WEC	

GEC	LW04
GNA +5%	LW05
GWL	LW06
LP01	
LF02	
LF03	
LN01	
LA02	
LW01	
LW02	

MOC
MEC
MSW
MTW
MWL
MNA

3 Select Feet Finish

Click to view edges

WWP	WOW
PO01	WNO
PO02	WSO
PO03	
PO07	
PO08	
PO09	
WBW	
WSW	
WEC	

WWP	WOW
PO01	WNO
PO02	WSO
PO03	
PO07	
PO08	
PO09	
WBW	
WSW	
WEC	

WWP	WOW
PO01	WNO
PO02	WSO
PO03	
PO07	
PO08	
PO09	
WEC	
WBW	
WSW	

4 Select Edge

Click to view details



Options

Accessories

- K28: Articulating Keyboard w/ Mouse - \$390
- K31-SK: Center drawer w/ skirt - \$310
- K31: Center drawer w/o skirt - \$205

Concealed Floor Power Infeed Cover

- PCEB: White Metal Finish concealed floor power infeed cover - \$150

Delete Top and Wire Tray

- DHAT: Delete height adjustable top. Deduct \$3845 Veneer(W), \$3644 High Pressure Laminate(G), \$3262 Thermally Fused Laminate(M) per top

Metal Feet

- MTL10: Replace solid wood feet with metal feet, standard MFW White - \$55 ea

Premium Metal Finish

- Specify premium Metal Finish. MFMB: Matte Black, MFS: Silver, MFSS: Salmon Sienna, MFSA: SurfIn Aquavert, MFPS: Pistachio, MFOS: Oyster, MFNA: Navy, MFOL: Olive, MFGB: Grey Beige MFGG: Graphite Gray, MFG: Gray, MFGM: Matte Gold
- Premium Metal Finish for WMT Wire Management Tray - \$75 ea
- Premium Metal Finish for MTL10 Metal Feet - \$20 ea
- Premium Metal Finish for PCEB Concealed Floor Power Infeed Cover - \$35

Telecom Plates

- Each power unit has 1 plate. All telecom connectors sold separately.
- RJ45 (1) - \$55, RJ45 (2) - \$110, RJ45 (3) - \$165, USB (1) - \$70, USB (2) - \$140, RJ45/USB - \$125, RJ45/HDMI - \$210, HDMI/USB - \$205

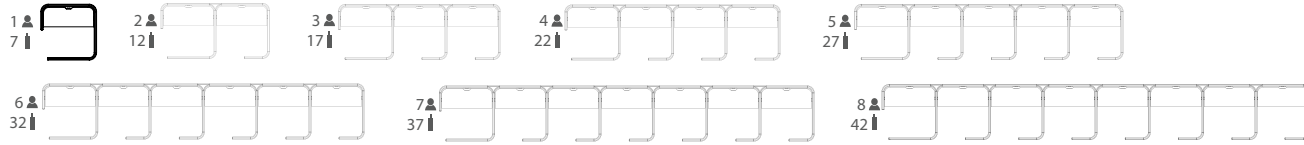

Number of Feet per Typical (MTL10 Option)

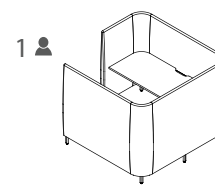

Fixed Top Workstation

Powered Workstation

1 Select Model

w" x d" x h"	Weight	Standard Veneer Top Upholstered Panels - COM\$	Premium Veneer Top Upholstered Panels - COM\$	High Pressure Laminate Top Upholstered Panels - COM\$	Thermally Fused Laminate Top Upholstered Panels - COM\$
560 x 73 x 55	8	HNY56073FP555W 58885	"P" Option N/A	HNY56073FP555G 57285	HNY56073FP555M 54229
491 x 73 x 55	7	HNY49173FP555W 51768	"P" Option N/A	HNY49173FP555G 50368	HNY49173FP555M 43660
421 x 73 x 55	6	HNY42173FP555W 44651	"P" Option N/A	HNY42173FP555G 43451	HNY42173FP555M 41159
352 x 73 x 55	5	HNY35273FP555W 37534	"P" Option N/A	HNY35273FP555G 36534	HNY35273FP555M 34624
282 x 73 x 55	4	HNY28273FP555W 30417	"P" Option N/A	HNY28273FP555G 29617	HNY28273FP555M 28089
212 x 73 x 55	3	HNY21273FP555W 23300	"P" Option N/A	HNY21273FP555G 22700	HNY21273FP555M 21554
143 x 73 x 55	2	HNY14373FP555W 16183	"P" Option N/A	HNY14373FP555G 15783	HNY14373FP555M 15019
73 x 73 x 55	1	HNY7373FP555W 9066	"P" Option N/A	HNY7373FP555G 8866	HNY7373FP555M 8484

[Click Here for Graded in Pricing](#)

2 Select Finish

Click to view finishes	WWP	WOW
	PO01	WNO
	PO02	WSO
	PO03	WNF(Natural Oak on Flat Cut)
	PO07	WSF(Salted Oak on Flat Cut)
	PO08	WSF(Salted Oak on Flat Cut)
	PO09	WSF(Salted Oak on Flat Cut)
	WBW	
	WSW	
	WEC	

3 Select Feet Finish

Click to view edges	WWP	WOW
	PO01	WNO
	PO02	WSO
	PO03	
	PO07	
	PO08	
	PO09	
	WBW	
	WSW	
	WEC	

4 Select Edge

Click to view details

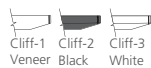

GEC	LW04
GNA +5%	LW05
GWL	LW06
LP01	
LF02	
LF03	
LN01	
LA02	
LW01	
LW02	

WWP	WOW
PO01	WNO
PO02	WSO
PO03	
PO07	
PO08	
PO09	
WBW	
WSW	
WEC	



MOC
MEC
MSW
MTW
MWL
MNA

WWP	WOW
PO01	WNO
PO02	WSO
PO03	
PO07	
PO08	
PO09	
WEC	
WBW	
WSW	



[Click here to view statement of line](#)

Product Features

- HNY6625WT162 Fixed Desk Height Worksurfaces are included
- 5" Solid wood feet - oval shape
- 4 Power outlets with 1 telecom plate, see options below for telecom plate
- Ships KD
- Wire management tray attaches to worksurface top, standard in MFW White, see premium Metal Finish for options
- Hardwire infeed and jumpers are included in workstations
- T75 worksurface wire cutout is standard on all worksurfaces.(T75D: Delete cutout is optional)

Options

Accessories

- K28: Articulating Keyboard w/ Mouse - \$390
- K31-SK: Center drawer w/ skirt - \$310
- K31: Center drawer w/o skirt - \$205

Concealed Floor Power Infeed Cover

- PCEB: White Metal Finish concealed floor power infeed cover - \$150

Delete Top and Wire Tray

- DFP: Delete fixed top. Deduct \$1535 Veneer (W), \$1335 High Pressure Laminate (G), \$953 Thermally Fused Laminate (M) per top

Metal Feet

- MTL10: Replace solid wood feet with metal feet, standard MFW White - \$55 ea

Premium Metal Finish

- Specify premium Metal Finish. MFMB: Matte Black, MFS: Silver, MFSS: Salmon Sienna, MFSA: Surfing Aquavert, MFPS: Pistachio, MFOS: Oyster, MFNA: Navy, MFOL: Olive, MFGB: Grey Beige MFGG: Graphite Gray, MFG: Gray, MFGM: Matte Gold
- Premium Metal Finish for WMT Wire Management Tray - \$75 ea
- Premium Metal Finish for MTL10 Metal Feet - \$20 ea
- Premium Metal Finish for PCEB Concealed Floor Power Infeed Cover - \$35

Telecom Plates

- Each power unit has 1 plate. All telecom connectors sold separately.
- RJ45 (1) - \$55, RJ45 (2) - \$110, RJ45 (3) - \$165, USB (1) - \$70, USB (2) - \$140, RJ45/USB - \$125, RJ45/HDMI - \$210, HDMI/USB - \$205

Worksurface Height

- THL-42: Modify worksurface height to bar height - N/C

DARRAN

Honey

Inline 90° Workstation Typical
Position 3 Desk with Fixed Worksurface

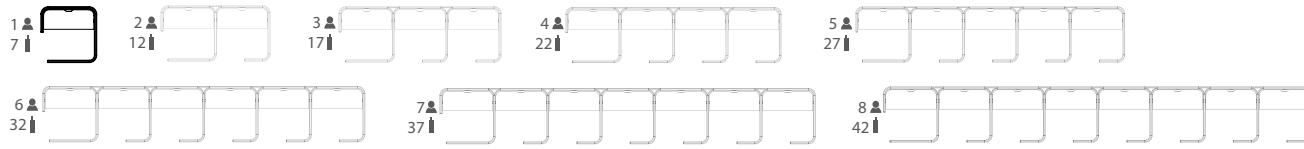

Number of Feet per Typical (MTL10 Option)

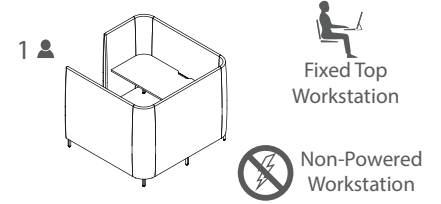

1 Select Model

Weight

Standard Veneer Top Upholstered Panels - COM\$

Premium Veneer Top Upholstered Panels - COM\$

High Pressure Laminate Top Upholstered Panels - COM\$

Thermally Fused Laminate Top Upholstered Panels - COM\$

560 x 73 x 55	8	HNY56073FT555W	52887
491 x 73 x 55	7	HNY49173FT555W	46496
421 x 34 x 55	6	HNY42134FT555W	40105
352 x 73 x 55	5	HNY35273FT555W	33714
282 x 73 x 55	4	HNY28273FT555W	27323
212 x 73 x 55	3	HNY21273FT555W	20932
143 x 73 x 55	2	HNY14373FT555W	14541
73 x 73 x 55	1	HNY7373FT555W	8150

"P" Option N/A
 "P" Option N/A
 "P" Option N/A
 "P" Option N/A
 "P" Option N/A
 "P" Option N/A
 "P" Option N/A
 "P" Option N/A

HNY56073FT555G	51287
HNY49173FT555G	45096
HNY42134FT555G	38905
HNY35273FT555G	32714
HNY28273FT555G	26523
HNY21273FT555G	20332
HNY14373FT555G	14141
HNY7373FT555G	7950

HNY56073FT555M	48231
HNY49173FP555M	47694
HNY42134FT555M	36613
HNY35273FT555M	30804
HNY28273FT555M	24995
HNY21273FT555M	19186
HNY14373FT555M	13377
HNY7373FT555M	7568

[Click here to view statement of line](#)

Product Features

- HNY6625WT162 Fixed Desk Height Worksurfaces are included
- 5" Solid wood feet - oval shape
- Ships KD
- T75 worksurface wire cutout is standard on all worksurfaces.(T75D: Delete cutout is optional)

Options

Accessories

- K28: Articulating Keyboard w/ Mouse - \$390
- K31-SK: Center drawer w/ skirt - \$310
- K31: Center drawer w/o skirt - \$205

Delete Top

- DFT: Delete fixed top. Deduct \$1325 Veneer(W), \$1125 High Pressure Laminate (G), \$743 Thermally Fused Laminate (M) per top

Metal Feet

- MTL10: Replace solid wood feet with metal feet, standard MFW White - \$55 ea

Premium Metal Finish

- Specify premium Metal Finish. MFMB: Matte Black, MFS: Silver, MFSS: Salmon Sienna, MFSA: Surfing Aquavert, MFPS: Pistachio, MFOS: Oyster, MFNA: Navy, MFOL: Olive, MFGB: Grey Beige MFGG: Graphite Gray, MFG: Gray, MFGM: Matte Gold
- Premium Metal Finish for WMT Wire Management Tray - \$75 ea
- Premium Metal Finish for MTL10 Metal Feet - \$20 ea
- Premium Metal Finish for PCEB Concealed Floor Power Infeed Cover - \$35

Worksurface Height

- THL-42: Modify worksurface height to bar height - N/C

Wire Tray

- WMT: Wire metal tray. Mounts under top and comes standard in MFW White - \$210

[Click Here for Graded in Pricing](#)

2 Select Finish

Click to view finishes

WWP	WOW
PO01	WNO
PO02	WSO
PO03	WNF(Natural Oak on Flat Cut)
PO07	WSF(Salted Oak on Flat Cut)
PO08	WSF(Salted Oak on Flat Cut)
PO09	WSF(Salted Oak on Flat Cut)
WBW	
WSW	
WEC	

GEC	LW04
GNA +5%	LW05
GWL	LW06
LP01	
LF02	
LF03	
LN01	
LA02	
LW01	
LW02	

MOC
MEC
MSW
MTW
MWL
MNA

3 Select Feet Finish

Click to view edges

WWP	WOW
PO01	WNO
PO02	WSO
PO03	
PO07	
PO08	
PO09	
WBW	
WSW	
WEC	

WWP	WOW
PO01	WNO
PO02	WSO
PO03	
PO07	
PO08	
PO09	
WBW	
WSW	
WEC	

WWP	WOW
PO01	WNO
PO02	WSO
PO03	
PO07	
PO08	
PO09	
WEC	
WBW	
WSW	

4 Select Edge

Click to view details

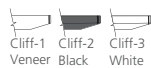

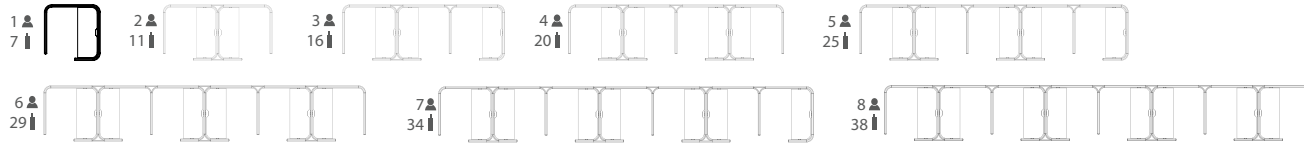

Number of Feet per Typical (MTL10 Option)

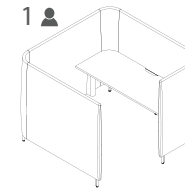

Height Adjustable Workstation

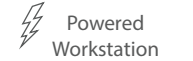

Powered Workstation

1 Select Model

Weight

Standard Veneer Top Upholstered Panels - COM\$

Premium Veneer Top Upholstered Panels - COM\$

High Pressure Laminate Top Upholstered Panels - COM\$

Thermally Fused Laminate Top Upholstered Panels - COM\$

1 person 71"	2 people 111"	3 people 161"	4 people 201"	5 people 251"	6 people 291"	7 people 341"	8 people 381"
560 x 73 x 55	491 x 73 x 55	421 x 73 x 55	352 X 73 x 55	282 x 73 x 55	212 x 73 x 55	143 x 73 x 55	73 x 73 x 55
8 people HNY56073HA556W	7 people HNY49173HA556W	6 people HNY42173HA556W	5 people HNY35273HA556W	4 people HNY28273HA556W	3 people HNY21273HA556W	2 people HNY14373HA556W	1 person HNY7373HA555W
74025	65583	55956	47514	37887	29445	19818	11376

"P" Option N/A
"P" Option N/A
"P" Option N/A
"P" Option N/A
"P" Option N/A
"P" Option N/A
"P" Option N/A
"P" Option N/A

HNY56073HA556G	72417
HNY49173HA556G	64176
HNY42173HA556G	54750
HNY35273HA556G	46509
HNY28273HA556G	37083
HNY21273HA556G	28842
HNY14373HA556G	19416
HNY7373HA556G	11175

HNY56073HA556M	69361
HNY49173HA556M	61502
HNY42173HA556M	52458
HNY35273HA556M	44599
HNY28273HA556M	35555
HNY21273HA556M	27696
HNY14373HA556M	18652
HNY7373HA556M	10793

[Click here to view statement of line](#)

Product Features

- HNY6625WT163 Height Adjustable worksurfaces are included
- 5" Solid wood feet - oval shape
- 4 Power outlets with 1 telecom plate, see options below for telecom plate
- Ships KD
- Wire management tray attaches to worksurface top, standard in MFW White, see premium Metal Finish for options
- Hardwire infeed and jumpers are included in workstations
- T75 worksurface wire cutout is standard on all worksurfaces.(T75D: Delete cutout is optional)

[Click Here for Graded in Pricing](#)

2 Select Finish

Click to view finishes

WWP	WOW
PO01	WNO
PO02	WSO
PO03	WNF(Natural Oak on Flat Cut)
PO07	WSF(Salted Oak on Flat Cut)
PO08	WSF(Salted Oak on Flat Cut)
PO09	WSF(Salted Oak on Flat Cut)
WBW	
WSW	
WEC	

GEC	LW04
GNA +5%	LW05
GWL	LW06
LP01	
LF02	
LF03	
LN01	
LA02	
LW01	
LW02	

MOC
MEC
MSW
MTW
MWL
MNA

3 Select Feet Finish

Click to view edges

WWP	WOW
PO01	WNO
PO02	WSO
PO03	
PO07	
PO08	
PO09	
WBW	
WSW	
WEC	

WWP	WOW
PO01	WNO
PO02	WSO
PO03	
PO07	
PO08	
PO09	
WBW	
WSW	
WEC	

WWP	WOW
PO01	WNO
PO02	WSO
PO03	
PO07	
PO08	
PO09	
WEC	
WBW	
WSW	

4 Select Edge

Click to view details

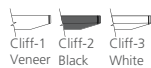

Options

Accessories

- K28: Articulating Keyboard w/ Mouse - \$390
- K31-SK: Center drawer w/ skirt - \$310
- K31: Center drawer w/o skirt - \$205

Concealed Floor Power Infeed Cover

- PCEB: White Metal Finish concealed floor power infeed cover - \$150

Delete Top and Wire Tray

- DHAT: Delete height adjustable top. Deduct \$3845 Veneer(W), \$3644 High Pressure Laminate(G), \$3262 Thermally Fused Laminate(M) per top

Metal Feet

- MTL10: Replace solid wood feet with metal feet, standard MFW White - \$55 ea

Premium Metal Finish

- Specify premium Metal Finish. MFMB: Matte Black, MFS: Silver, MFSS: Salmon Sienna, MFSA: SurfIn Aquavert, MFPS: Pistachio, MFOS: Oyster, MFNA: Navy, MFOL: Olive, MFGB: Grey Beige MFGG: Graphite Gray, MFG: Gray, MFGM: Matte Gold
- Premium Metal Finish for WMT Wire Management Tray - \$75 ea
- Premium Metal Finish for MTL10 Metal Feet - \$20 ea
- Premium Metal Finish for PCEB Concealed Floor Power Infeed Cover - \$35

Telecom Plates

- Each power unit has 1 plate. All telecom connectors sold separately.
- RJ45 (1) - \$55, RJ45 (2) - \$110, RJ45 (3) - \$165, USB (1) - \$70, USB (2) - \$140, RJ45/USB - \$125, RJ45/HDMI - \$210, HDMI/USB - \$205

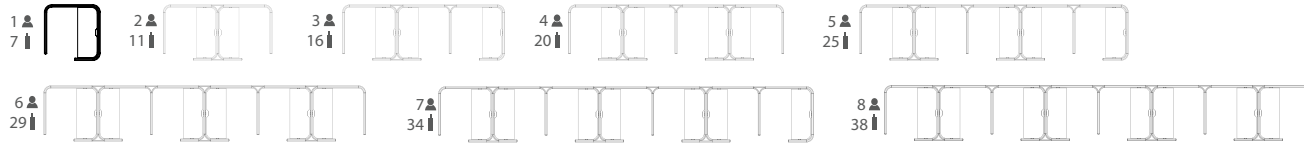

Number of Feet per Typical (MTL10 Option)

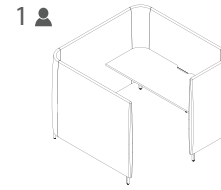

Fixed Top Workstation

Powered Workstation

1 Select Model

w" x d" x h"	Weight	Standard Veneer Top Upholstered Panels - COM\$
560 x 73 x 55	8	HNY56073FP556W 55545
491 x 73 x 55	7	HNY49173FP556W 49413
421 x 73 x 55	6	HNY42173FP556W 42096
352 x 73 x 55	5	HNY35273FP556W 35964
282 x 73 x 55	4	HNY28273FP556W 28647
212 x 73 x 55	3	HNY21273FP556W 22515
143 x 73 x 55	2	HNY14373FP556W 15198
73 x 73 x 55	1	HNY7373FP556W 9066

2 Select Finish

Click to view finishes	WWP	WOW
	PO01	WNO
	PO02	WSO
	PO03	WNF(Natural Oak on Flat Cut)
	PO07	WSF(Salted Oak on Flat Cut)
	PO08	WSF(Salted Oak on Flat Cut)
	PO09	WSF(Salted Oak on Flat Cut)
	WBW	
	WSW	
	WEC	

3 Select Feet Finish

Click to view edges	WWP	WOW
	PO01	WNO
	PO02	WSO
	PO03	
	PO07	
	PO08	
	PO09	
	WBW	
	WSW	
	WEC	

4 Select Edge

Click to view details

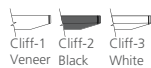

Premium Veneer Top Upholstered Panels - COM\$

"P" Option N/A
"P" Option N/A
"P" Option N/A
"P" Option N/A
"P" Option N/A
"P" Option N/A
"P" Option N/A
"P" Option N/A
"P" Option N/A

High Pressure Laminate Top Upholstered Panels - COM\$

HNY56073FP556G 53945
HNY49173FP556G 48013
HNY42173FP556G 40896
HNY35273FP556G 34964
HNY28273FP556G 27847
HNY21273FP556G 21915
HNY14373FP556G 14798
HNY7373FP556G 8866

GEC	LW04
GNA +5%	LW05
GWL	LW06
LP01	
LF02	
LF03	
LN01	
LA02	
LW01	
LW02	

WWP	WOW
PO01	WNO
PO02	WSO
PO03	
PO07	
PO08	
PO09	
WBW	
WSW	
WEC	

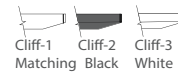

Thermally Fused Laminate Top Upholstered Panels - COM\$

HNY56073FP556M 50889
HNY49173FP556M 45339
HNY42173FP556M 38604
HNY35273FP556M 33054
HNY28273FP556M 26319
HNY21273FP556M 20769
HNY14373FP556M 14034
HNY7373FP556M 8484

MOC
MEC
MSW
MTW
MWL
MNA

WWP	WOW
PO01	WNO
PO02	WSO
PO03	
PO07	
PO08	
PO09	
WEC	
WBW	
WSW	



Click here to view statement of line

Product Features

- HNY6625WT162 Fixed Desk Height Worksurfaces are included
- 5" Solid wood feet - oval shape
- 4 Power outlets with 1 telecom plate, see options below for telecom plate
- Ships KD
- Wire management tray attaches to worksurface top, standard in MFW White, see premium Metal Finish for options
- Hardwire infeed and jumpers are included in workstations
- T75 worksurface wire cutout is standard on all worksurfaces.(T75D: Delete cutout is optional)

Options

Accessories

- K28: Articulating Keyboard w/ Mouse - \$390
- K31-SK: Center drawer w/ skirt - \$310
- K31: Center drawer w/o skirt - \$205

Concealed Floor Power Infeed Cover

- PCEB: White Metal Finish concealed floor power infeed cover - \$150

Delete Top and Wire Tray

- DFP: Delete fixed top. Deduct \$1535 Veneer (W), \$1335 High Pressure Laminate (G), \$953 Thermally Fused Laminate (M) per top

Metal Feet

- MTL10: Replace solid wood feet with metal feet, standard MFW White - \$55 ea

Premium Metal Finish

- Specify premium Metal Finish. MFMB: Matte Black, MFS: Silver, MFSS: Salmon Sienna, MFSA: SurfIn Aquavert, MFPS: Pistachio, MFOS: Oyster, MFNA: Navy, MFOL: Olive, MFGB: Grey Beige MFGG: Graphite Gray, MFG: Gray, MFGM: Matte Gold
- Premium Metal Finish for WMT Wire Management Tray - \$75 ea
- Premium Metal Finish for MTL10 Metal Feet - \$20 ea
- Premium Metal Finish for PCEB Concealed Floor Power Infeed Cover - \$35

Telecom Plates

- Each power unit has 1 plate. All telecom connectors sold separately.
- RJ45 (1) - \$55, RJ45 (2) - \$110, RJ45 (3) - \$165, USB (1) - \$70, USB (2) - \$140, RJ45/USB - \$125, RJ45/HDMI - \$210, HDMI/USB - \$205

Worksurface Height

- THL-42: Modify worksurface height to bar height - N/C

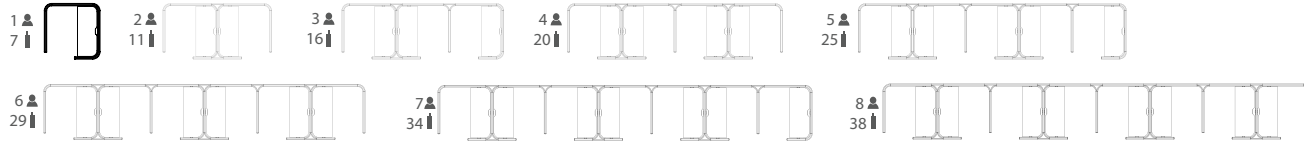

Number of Feet per Typical (MTL10 Option)



1 Select Model

w" x d" x h"	Weight	Standard Veneer Top Upholstered Panels - COM\$
560 x 73 x 55	8	HNY56073FT556W 51583
491 x 73 x 55	7	HNY49173FT556W 45518
421 x 34 x 55	6	HNY42134FT556W 39127
352 x 73 x 55	5	HNY35273FT556W 33062
282 x 73 x 55	4	HNY28273FT556W 26671
212 x 73 x 55	3	HNY21273FT556W 20606
143 x 73 x 55	2	HNY14373FT556W 14215
73 x 73 x 55	1	HNY7373FT556W 8150

2 Select Finish

Click to view finishes

WWP	WOW
PO01	WNO
PO02	WSO
PO03	WNF(Natural Oak on Flat Cut)
PO07	WSF(Salted Oak on Flat Cut)
PO08	WSF(Salted Oak on Flat Cut)
PO09	WSF(Salted Oak on Flat Cut)
WBW	
WSW	
WEC	

3 Select Feet Finish

Click to view edges

WWP	WOW
PO01	WNO
PO02	WSO
PO03	
PO07	
PO08	
PO09	
WBW	
WSW	
WEC	

4 Select Edge

Click to view details

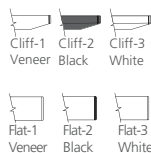

Premium Veneer Top Upholstered Panels - COM\$

"P" Option N/A
"P" Option N/A
"P" Option N/A
"P" Option N/A
"P" Option N/A
"P" Option N/A
"P" Option N/A
"P" Option N/A
"P" Option N/A

High Pressure Laminate Top Upholstered Panels - COM\$

HNY56073FT556G 49983
HNY49173FT556G 44118
HNY42134FT556G 37927
HNY35273FT556G 32062
HNY28273FT556G 25871
HNY21273FT556G 20006
HNY14373FT556G 13815
HNY7373FT556G 7950

GEC LW04
GNA +5% LW05
GWL LW06
LP01
LF02
LF03
LN01
LA02
LW01
LW02

WWP	WOW
PO01	WNO
PO02	WSO
PO03	
PO07	
PO08	
PO09	
WBW	
WSW	
WEC	

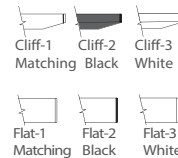

Thermally Fused Laminate Top Upholstered Panels - COM\$

HNY56073FT556M 46927
HNY49173FT556M 41444
HNY42134FT556M 35635
HNY35273FT556M 30152
HNY28273FT556M 24343
HNY21273FT556M 18860
HNY14373FT556M 13051
HNY7373FT556M 7568

MOC
MEC
MSW
MTW
MWL
MNA

WWP	WOW
PO01	WNO
PO02	WSO
PO03	
PO07	
PO08	
PO09	
WBW	
WSW	



Click here to view statement of line

Product Features

- HNY6625WT162 Fixed Desk Height Worksurfaces are included
- 5" Solid wood feet - oval shape
- Ships KD
- T75 worksurface wire cutout is standard on all worksurfaces.(T75D: Delete cutout is optional)

Options

Accessories

- K28: Articulating Keyboard w/ Mouse - \$390
- K31-SK: Center drawer w/ skirt - \$310
- K31: Center drawer w/o skirt - \$205

Delete Top

- DFT: Delete fixed top. Deduct \$1325 Veneer(W), \$1125 High Pressure Laminate (G), \$743 Thermally Fused Laminate (M) per top

Metal Feet

- MTL10: Replace solid wood feet with metal feet, standard MFW White - \$55 ea

Premium Metal Finish

- Specify premium Metal Finish. MFMB: Matte Black, MFS: Silver, MFSS: Salmon Sienna, MFSA: Surfing Aquavert, MFPS: Pistachio, MFOS: Oyster, MFNA: Navy, MFOL: Olive, MFGB: Grey Beige MFGG: Graphite Gray, MFG: Gray, MFGM: Matte Gold
- Premium Metal Finish for WMT Wire Management Tray - \$75 ea
- Premium Metal Finish for MTL10 Metal Feet - \$20 ea
- Premium Metal Finish for PCEB Concealed Floor Power Infeed Cover - \$35

Worksurface Height

- THL-42: Modify worksurface height to bar height - N/C

Wire Tray

- WMT: Wire metal tray. Mounts under top and comes standard in MFW White - \$210

DARRAN

Honey

Inline 90° Workstation Typical
Position 5 Desk with Height Adjustable Worksurface

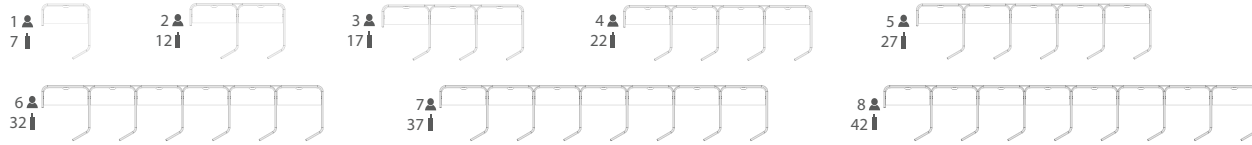

Number of Feet per Typical (MTL10 Option)

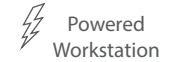
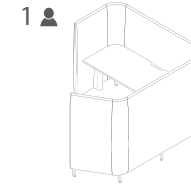

1 Select Model

Weight

Standard Veneer Top Upholstered Panels - COM\$

Premium Veneer Top Upholstered Panels - COM\$

High Pressure Laminate Top Upholstered Panels - COM\$

Thermally Fused Laminate Top Upholstered Panels - COM\$

w" x d" x h"	Standard Veneer Top Upholstered Panels - COM\$	Premium Veneer Top Upholstered Panels - COM\$
560 x 83 x 55	8 HNY56083HA557W 77062	"P" Option N/A
491 x 83 x 55	7 HNY49183HA557W 67619	"P" Option N/A
421 x 83 x 55	6 HNY42183HA557W 58176	"P" Option N/A
352 X 83 X 55	5 HNY35283HA557W 48733	"P" Option N/A
282 x 83 x 55	4 HNY28283HA557W 39290	"P" Option N/A
212 x 83 x 55	3 HNY21283HA557W 29847	"P" Option N/A
143 x 83 x 55	2 HNY14383HA557W 20404	"P" Option N/A
73 x 83 x 55	1 HNY7383HA557W 10961	"P" Option N/A

"P" Option N/A	HNY56083HA557G 75454
"P" Option N/A	HNY49183HA557G 66212
"P" Option N/A	HNY42183HA557G 56970
"P" Option N/A	HNY35283HA557G 47728
"P" Option N/A	HNY28283HA557G 38486
"P" Option N/A	HNY21283HA557G 29244
"P" Option N/A	HNY14383HA557G 20002
"P" Option N/A	HNY7383HA557G 10760

HNY56083HA557M 72398	HNY49183HA557M 63538
HNY42183HA557M 54678	HNY35283HA557M 45818
HNY28283HA557M 36958	HNY21283HA557M 28098
HNY14383HA557M 19238	HNY7383HA557M 10378

[Click here to view statement of line](#)

Product Features

- HNY6625WT163 Height Adjustable worksurfaces are included
- 5" Solid wood feet - oval shape
- 4 Power outlets with 1 telecom plate, see options below for telecom plate
- Ships KD
- Wire management tray attaches to worksurface top, standard in MFW White, see premium Metal Finish for options
- Hardwire infeed and jumpers are included in workstations
- T75 worksurface wire cutout is standard on all worksurfaces.(T75D: Delete cutout is optional)

[Click Here for Graded in Pricing](#)

2 Select Finish

Click to view finishes

WWP	WOW
PO01	WNO
PO02	WSO
PO03	WNF(Natural Oak on Flat Cut)
PO07	WSF(Salted Oak on Flat Cut)
PO08	WSF(Salted Oak on Flat Cut)
PO09	WSF(Salted Oak on Flat Cut)
WBW	
WSW	
WEC	

3 Select Feet Finish

Click to view edges

WWP	WOW
PO01	WNO
PO02	WSO
PO03	
PO07	
PO08	
PO09	
WBW	
WSW	
WEC	

4 Select Edge

Click to view details

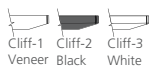

GEC	LW04
GNA +5%	LW05
GWL	LW06
LP01	
LF02	
LF03	
LN01	
LA02	
LW01	
LW02	

WWP	WOW
PO01	WNO
PO02	WSO
PO03	
PO07	
PO08	
PO09	
WBW	
WSW	
WEC	



MOC
MEC
MSW
MTW
MWL
MNA

WWP	WOW
PO01	WNO
PO02	WSO
PO03	
PO07	
PO08	
PO09	
WEC	
WBW	
WSW	



Options

Accessories

- K28: Articulating Keyboard w/ Mouse - \$390
- K31-SK: Center drawer w/ skirt - \$310
- K31: Center drawer w/o skirt - \$205

Concealed Floor Power Infeed Cover

- PCEB: White Metal Finish concealed floor power infeed cover - \$150

Delete Top and Wire Tray

- DHAT: Delete height adjustable top. Deduct \$3845 Veneer(W), \$3644 High Pressure Laminate(G), \$3262 Thermally Fused Laminate(M) per top

Metal Feet

- MTL10: Replace solid wood feet with metal feet, standard MFW White - \$55 ea

Premium Metal Finish

- Specify premium Metal Finish. MFMB: Matte Black, MFS: Silver, MFSS: Salmon Sienna, MFSA: SurfIn Aquavert, MFPS: Pistachio, MFOS: Oyster, MFNA: Navy, MFOL: Olive, MFGB: Grey Beige MFGG: Graphite Gray, MFG: Gray, MFGM: Matte Gold
- Premium Metal Finish for WMT Wire Management Tray - \$75 ea
- Premium Metal Finish for MTL10 Metal Feet - \$20 ea
- Premium Metal Finish for PCEB Concealed Floor Power Infeed Cover - \$35

Telecom Plates

- Each power unit has 1 plate. All telecom connectors sold separately.
- RJ45 (1) - \$55, RJ45 (2) - \$110, RJ45 (3) - \$165, USB (1) - \$70, USB (2) - \$140, RJ45/USB - \$125, RJ45/HDMI - \$210, HDMI/USB - \$205

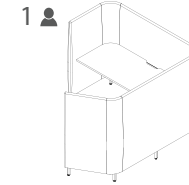
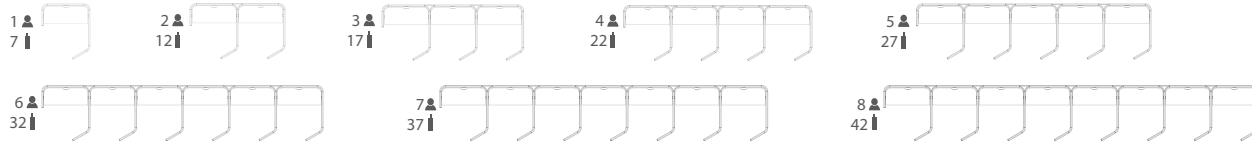

Fixed Top Workstation

Powered Workstation

Number of Feet per Typical (MTL10 Option) "SP" Number of Starter Panels per Typical (RSP Option)

1 Select Model

Weight

Standard Veneer Top Upholstered Panels - COM\$

Premium Veneer Top Upholstered Panels - COM\$

High Pressure Laminate Top Upholstered Panels - COM\$

Thermally Fused Laminate Top Upholstered Panels - COM\$

560 x 83 x 55	8	HNY56083FP557W	53669
491 x 83 x 55	7	HNY49183FP557W	51449
421 x 83 x 55	6	HNY42183FP557W	44316
352 x 83 x 55	5	HNY35283FP557W	37183
282 x 83 x 55	4	HNY28283FP557W	30050
212 x 83 x 55	3	HNY21283FP557W	22917
143 x 83 x 55	2	HNY14383FP557W	15784
73 x 83 x 55	1	HNY7383FP557W	8651

"P" Option N/A
"P" Option N/A
"P" Option N/A
"P" Option N/A
"P" Option N/A
"P" Option N/A
"P" Option N/A
"P" Option N/A

HNY56083FP557G	56982
HNY49183FP557G	50049
HNY42183FP557G	43116
HNY35283FP557G	36183
HNY28283FP557G	29250
HNY21283FP557G	22317
HNY14383FP557G	15384
HNY7383FP557G	8451

HNY56083FP557M	58582
HNY49183FP557M	47375
HNY42183FP557M	40824
HNY35283FP557M	34273
HNY28283FP557M	27722
HNY21283FP557M	21171
HNY14383FP557M	14620
HNY7383FP557M	8069

Click here to view statement of line

Product Features

- HNY6625WT162 Fixed Desk Height Worksurfaces are included
- 5" Solid wood feet - oval shape
- 4 Power outlets with 1 telecom plate, see options below for telecom plate
- Ships KD
- Wire management tray attaches to worksurface top, standard in MFW White, see premium Metal Finish for options
- Hardwire infeed and jumpers are included in workstations
- T75 worksurface wire cutout is standard on all worksurfaces.(T75D: Delete cutout is optional)

Click Here for Graded in Pricing

2 Select Finish

Click to view finishes

WWP	WOW
PO01	WNO
PO02	WSO
PO03	WNF(Natural Oak on Flat Cut)
PO07	WSF(Salted Oak on Flat Cut)
PO08	WSF(Salted Oak on Flat Cut)
PO09	WSF(Salted Oak on Flat Cut)
WBW	
WSW	
WEC	

GEC	LW04
GNA +5%	LW05
GWL	LW06
LP01	
LF02	
LF03	
LN01	
LA02	
LW01	
LW02	

MOC
MEC
MSW
MTW
MWL
MNA

3 Select Feet Finish

Click to view edges

WWP	WOW
PO01	WNO
PO02	WSO
PO03	
PO07	
PO08	
PO09	
WBW	
WSW	
WEC	

WWP	WOW
PO01	WNO
PO02	WSO
PO03	
PO07	
PO08	
PO09	
WBW	
WSW	
WEC	

WWP	WOW
PO01	WNO
PO02	WSO
PO03	
PO07	
PO08	
PO09	
WEC	
WBW	
WSW	

4 Select Edge

Click to view details

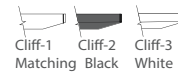

Options

Accessories

- K28: Articulating Keyboard w/ Mouse - \$390
- K31-SK: Center drawer w/ skirt - \$310
- K31: Center drawer w/o skirt - \$205

Concealed Floor Power Infeed Cover

- PCEB: White Metal Finish concealed floor power infeed cover - \$150

Delete Top and Wire Tray

- DFP: Delete fixed top. Deduct \$1535 Veneer (W), \$1335 High Pressure Laminate (G), \$953 Thermally Fused Laminate (M) per top

Metal Feet

- MTL10: Replace solid wood feet with metal feet, standard MFW White - \$55 ea

Premium Metal Finish

- Specify premium Metal Finish. MFMB: Matte Black, MFS: Silver, MFSS: Salmon Sienna, MFSA: SurfIn Aquavert, MFPS: Pistachio, MFOS: Oyster, MFNA: Navy, MFOL: Olive, MFGB: Grey Beige MFGG: Graphite Gray, MFG: Gray, MFGM: Matte Gold
- Premium Metal Finish for WMT Wire Management Tray - \$75 ea
- Premium Metal Finish for MTL10 Metal Feet - \$20 ea
- Premium Metal Finish for PCEB Concealed Floor Power Infeed Cover - \$35

Telecom Plates

- Each power unit has 1 plate. All telecom connectors sold separately.
- RJ45 (1) - \$55, RJ45 (2) - \$110, RJ45 (3) - \$165, USB (1) - \$70, USB (2) - \$140, RJ45/USB - \$125, RJ45/HDMI - \$210, HDMI/USB - \$205

Worksurface Height

- THL-42: Modify worksurface height to bar height - N/C

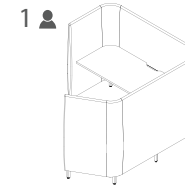
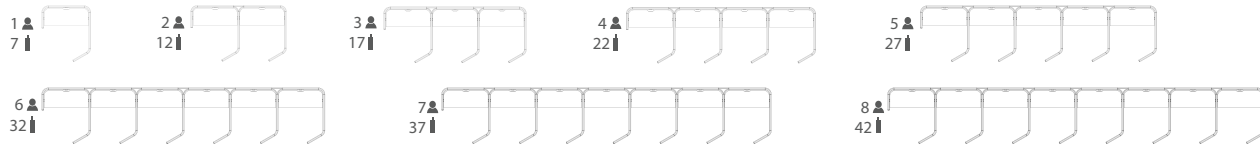

Fixed Top Workstation

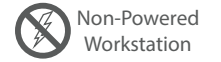

Number of Feet per Typical (MTL10 Option)

1 Select Model

Weight	Standard Veneer Top Upholstered Panels - COM\$
560 x 83 x 55	8 HNY56083FT557W 52584
491 x 83 x 55	7 HNY49183FT557W 46177
421 x 83 x 55	6 HNY42183FT557W 39770
352 x 83 x 55	5 HNY35283FT557W 33363
282 x 83 x 55	4 HNY28283FT557W 26956
212 x 83 x 55	3 HNY21283FT557W 20549
143 x 83 x 55	2 HNY14383FT557W 14142
73 x 83 x 55	1 HNY7383FT557W 7735

Premium Veneer Top Upholstered Panels - COM\$

"P" Option N/A
"P" Option N/A
"P" Option N/A
"P" Option N/A
"P" Option N/A
"P" Option N/A
"P" Option N/A
"P" Option N/A

High Pressure Laminate Top Upholstered Panels - COM\$

HNY56083FT557G	50984
HNY49183FT557G	44777
HNY42183FT557G	38570
HNY35283FT557G	32363
HNY28283FT557G	26156
HNY21283FT557G	19949
HNY14383FT557G	13742
HNY7383FT557G	7535

Thermally Fused Laminate Top Upholstered Panels - COM\$

HNY56083FT557M	47928
HNY49183FT557M	42103
HNY42183FT557M	36278
HNY35283FT557M	30453
HNY28283FT557M	24628
HNY21283FT557M	18803
HNY14383FT557M	12978
HNY7383FT557M	7153

Click here to view statement of line

Product Features

- HNY6625WT162 Fixed Desk Height Worksurfaces are included
- 5" Solid wood feet - oval shape
- Ships KD
- T75 worksurface wire cutout is standard on all worksurfaces.(T75D: Delete cutout is optional)

Options

Accessories

- K28: Articulating Keyboard w/ Mouse - \$390
- K31-SK: Center drawer w/ skirt - \$310
- K31: Center drawer w/o skirt - \$205

Delete Top

- DFT: Delete fixed top. Deduct \$1325 Veneer(W), \$1125 High Pressure Laminate (G), \$743 Thermally Fused Laminate (M) per top

Metal Feet

- MTL10: Replace solid wood feet with metal feet, standard MFW White - \$55 ea

Premium Metal Finish

- Specify premium Metal Finish. MFMB: Matte Black, MFS: Silver, MFSS: Salmon Sienna, MFSA: Surfing Aquavert, MFPS: Pistachio, MFOS: Oyster, MFNA: Navy, MFOL: Olive, MFGB: Grey Beige MFGG: Graphite Gray, MFG: Gray, MFGM: Matte Gold
- Premium Metal Finish for WMT Wire Management Tray - \$75 ea
- Premium Metal Finish for MTL10 Metal Feet - \$20 ea
- Premium Metal Finish for PCEB Concealed Floor Power Infeed Cover - \$35

Worksurface Height

- THL-42: Modify worksurface height to bar height - N/C

Wire Tray

- WMT: Wire metal tray. Mounts under top and comes standard in MFW White - \$210

Click Here for Graded in Pricing

2 Select Finish

Click to view finishes

WWP	WOW
PO01	WNO
PO02	WSO
PO03	WNF(Natural Oak on Flat Cut)
PO07	WSF(Salted Oak on Flat Cut)
PO08	WSF(Salted Oak on Flat Cut)
PO09	WSF(Salted Oak on Flat Cut)
WBW	
WSW	
WEC	

3 Select Feet Finish

Click to view edges

WWP	WOW
PO01	WNO
PO02	WSO
PO03	
PO07	
PO08	
PO09	
WBW	
WSW	
WEC	

4 Select Edge

Click to view details

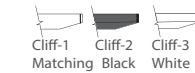
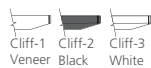

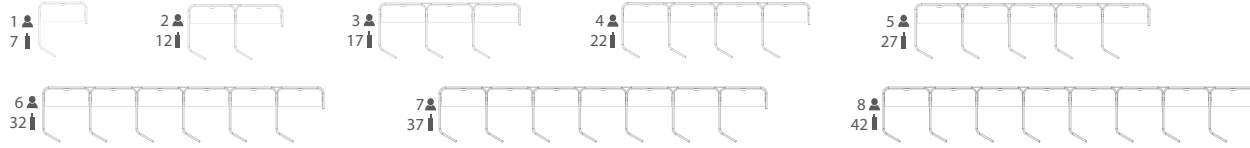

Number of Feet per Typical (MTL10 Option)

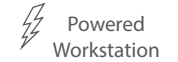
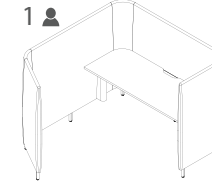

1 Select Model

Weight

Standard Veneer Top Upholstered Panels - COM\$

Premium Veneer Top Upholstered Panels - COM\$

High Pressure Laminate Top Upholstered Panels - COM\$

Thermally Fused Laminate Top Upholstered Panels - COM\$

560 x 83 x 55	8	HNY56083HA558W	77062
491 x 83 x 55	7	HNY49183HA558W	67619
421 x 83 x 55	6	HNY42183HA558W	58176
352 X 83 X 55	5	HNY35283HA558W	48733
282 x 83 x 55	4	HNY28283HA558W	39290
212 x 83 x 55	3	HNY21283HA558W	29847
143 x 83 x 55	2	HNY14383HA558W	20404
73 x 83 x 55	1	HNY7383HA558W	10961

"P" Option N/A
"P" Option N/A
"P" Option N/A
"P" Option N/A
"P" Option N/A
"P" Option N/A
"P" Option N/A
"P" Option N/A

HNY56083HA558G	75454
HNY49183HA558G	66212
HNY42183HA558G	56970
HNY35283HA558G	47728
HNY28283HA558G	38486
HNY21283HA558G	29244
HNY14383HA558G	20002
HNY7383HA558G	10760

HNY56083HA558M	72398
HNY49183HA558M	63538
HNY42183HA558M	54678
HNY35283HA558M	45818
HNY28283HA558M	36958
HNY21283HA558M	28098
HNY14383HA558M	19238
HNY7383HA558M	10378

[Click here to view statement of line](#)

Product Features

- HNY6625WT163 Height Adjustable worksurfaces are included
- 5" Solid wood feet - oval shape
- 4 Power outlets with 1 telecom plate, see options below for telecom plate
- Ships KD
- Wire management tray attaches to worksurface top, standard in MFW White, see premium Metal Finish for options
- Hardwire infeed and jumpers are included in workstations
- T75 worksurface wire cutout is standard on all worksurfaces.(T75D: Delete cutout is optional)

[Click Here for Graded in Pricing](#)

2 Select Finish

Click to view finishes

WWP	WOW
PO01	WNO
PO02	WSO
PO03	WNF(Natural Oak on Flat Cut)
PO07	WSF(Salted Oak on Flat Cut)
PO08	WSF(Salted Oak on Flat Cut)
PO09	WSF(Salted Oak on Flat Cut)
WBW	
WSW	
WEC	

GEC	LW04
GNA +5%	LW05
GWL	LW06
LP01	
LF02	
LF03	
LN01	
LA02	
LW01	
LW02	

MOC
MEC
MSW
MTW
MWL
MNA

3 Select Feet Finish

Click to view edges

WWP	WOW
PO01	WNO
PO02	WSO
PO03	
PO07	
PO08	
PO09	
WBW	
WSW	
WEC	

WWP	WOW
PO01	WNO
PO02	WSO
PO03	
PO07	
PO08	
PO09	
WBW	
WSW	
WEC	

WWP	WOW
PO01	WNO
PO02	WSO
PO03	
PO07	
PO08	
PO09	
WEC	
WBW	
WSW	

4 Select Edge

Click to view details

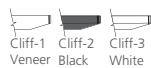

Options

Accessories

- K28: Articulating Keyboard w/ Mouse - \$390
- K31-SK: Center drawer w/ skirt - \$310
- K31: Center drawer w/o skirt - \$205

Concealed Floor Power Infeed Cover

- PCEB: White Metal Finish concealed floor power infeed cover - \$150

Delete Top and Wire Tray

- DHAT: Delete height adjustable top. Deduct \$3845 Veneer(W), \$3644 High Pressure Laminate(G), \$3262 Thermally Fused Laminate(M) per top

Metal Feet

- MTL10: Replace solid wood feet with metal feet, standard MFW White - \$55 ea

Premium Metal Finish

- Specify premium Metal Finish. MFMB: Matte Black, MFS: Silver, MFSS: Salmon Sienna, MFSA: SurfIn Aquavert, MFPS: Pistachio, MFOS: Oyster, MFNA: Navy, MFOL: Olive, MFGB: Grey Beige MFGG: Graphite Gray, MFG: Gray, MFGM: Matte Gold
- Premium Metal Finish for WMT Wire Management Tray - \$75 ea
- Premium Metal Finish for MTL10 Metal Feet - \$20 ea
- Premium Metal Finish for PCEB Concealed Floor Power Infeed Cover - \$35

Telecom Plates

- Each power unit has 1 plate. All telecom connectors sold separately.
- RJ45 (1) - \$55, RJ45 (2) - \$110, RJ45 (3) - \$165, USB (1) - \$70, USB (2) - \$140, RJ45/USB - \$125, RJ45/HDMI - \$210, HDMI/USB - \$205

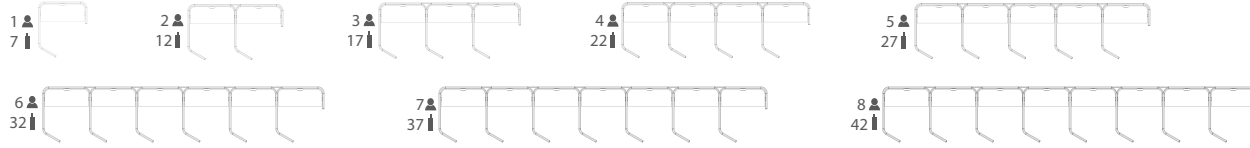

Number of Feet per Typical (MTL10 Option)

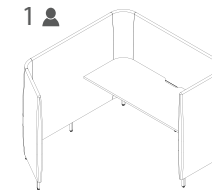

Fixed Top Workstation

Powered Workstation

1 Select Model

Weight

Standard Veneer Top Upholstered Panels - COM\$

Premium Veneer Top Upholstered Panels - COM\$

High Pressure Laminate Top Upholstered Panels - COM\$

Thermally Fused Laminate Top Upholstered Panels - COM\$

w" x d" x h"	Standard Veneer Top Upholstered Panels - COM\$	Premium Veneer Top Upholstered Panels - COM\$
560 x 83 x 55	8 HNY56083FP558W 53669	"P" Option N/A
491 x 83 x 55	7 HNY49183FP558W 51449	"P" Option N/A
421 x 83 x 55	6 HNY42183FP558W 44316	"P" Option N/A
352 x 83 x 55	5 HNY35283FP558W 37183	"P" Option N/A
282 x 83 x 55	4 HNY28283FP558W 30050	"P" Option N/A
212 x 83 x 55	3 HNY21283FP558W 22917	"P" Option N/A
143 x 83 x 55	2 HNY14383FP558W 15784	"P" Option N/A
73 x 83 x 55	1 HNY7383FP558W 8651	"P" Option N/A

"P" Option N/A
"P" Option N/A
"P" Option N/A
"P" Option N/A
"P" Option N/A
"P" Option N/A
"P" Option N/A
"P" Option N/A

HNY56083FP558G	56982
HNY49183FP558G	50049
HNY42183FP558G	43116
HNY35283FP558G	36183
HNY28283FP558G	29250
HNY21283FP558G	22317
HNY14383FP558G	15384
HNY7383FP558G	8451

HNY56083FP558W	58582
HNY49183FP558M	47375
HNY42183FP558M	40824
HNY35283FP558M	34273
HNY28283FP558M	27722
HNY21283FP558M	21171
HNY14383FP558M	14620
HNY7383FP558M	8069

[Click here to view statement of line](#)

Product Features

- HNY6625WT162 Fixed Desk Height Worksurfaces are included
- 5" Solid wood feet - oval shape
- 4 Power outlets with 1 telecom plate, see options below for telecom plate
- Ships KD
- Wire management tray attaches to worksurface top, standard in MFW White, see premium Metal Finish for options
- Hardwire infeed and jumpers are included in workstations
- T75 worksurface wire cutout is standard on all worksurfaces.(T75D: Delete cutout is optional)

[Click Here for Graded in Pricing](#)

2 Select Finish

Click to view finishes

WWP	WOW
PO01	WNO
PO02	WSO
PO03	WNF(Natural Oak on Flat Cut)
PO07	WSF(Salted Oak on Flat Cut)
PO08	WSF(Salted Oak on Flat Cut)
PO09	WSF(Salted Oak on Flat Cut)
WBW	
WSW	
WEC	

3 Select Feet Finish

Click to view edges

WWP	WOW
PO01	WNO
PO02	WSO
PO03	
PO07	
PO08	
PO09	
WBW	
WSW	
WEC	

4 Select Edge

Click to view details

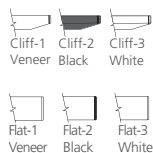

GEC	LW04
GNA +5%	LW05
GWL	LW06
LP01	
LF02	
LF03	
LN01	
LA02	
LW01	
LW02	

WWP	WOW
PO01	WNO
PO02	WSO
PO03	
PO07	
PO08	
PO09	
WBW	
WSW	
WEC	

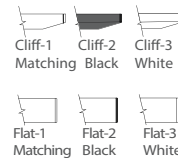

MOC
MEC
MSW
MTW
MWL
MNA

WWP	WOW
PO01	WNO
PO02	WSO
PO03	
PO07	
PO08	
PO09	
WEC	
WBW	
WSW	



Options

Accessories

- K28: Articulating Keyboard w/ Mouse - \$390
- K31-SK: Center drawer w/ skirt - \$310
- K31: Center drawer w/o skirt - \$205

Concealed Floor Power Infeed Cover

- PCEB: White Metal Finish concealed floor power infeed cover - \$150

Delete Top and Wire Tray

- DFP: Delete fixed top. Deduct \$1535 Veneer (W), \$1335 High Pressure Laminate (G), \$953 Thermally Fused Laminate (M) per top

Metal Feet

- MTL10: Replace solid wood feet with metal feet, standard MFW White - \$55 ea

Premium Metal Finish

- Specify premium Metal Finish. MFMB: Matte Black, MFS: Silver, MFSS: Salmon Sienna, MFSA: Surfing Aquavert, MFPS: Pistachio, MFOS: Oyster, MFNA: Navy, MFOL: Olive, MFGB: Grey Beige MFGG: Graphite Gray, MFG: Gray, MFGM: Matte Gold

Telecom Plates

- Premium Metal Finish for WMT Wire Management Tray - \$75 ea
- Premium Metal Finish for MTL10 Metal Feet - \$20 ea
- Premium Metal Finish for PCEB Concealed Floor Power Infeed Cover - \$35

Worksurface Height

- Each power unit has 1 plate. All telecom connectors sold separately.
- RJ45 (1) - \$55, RJ45 (2) - \$110, RJ45 (3) - \$165, USB (1) - \$70, USB (2) - \$140, RJ45/USB - \$125, RJ45/HDMI - \$210, HDMI/USB - \$205
- THL-42: Modify worksurface height to bar height - N/C

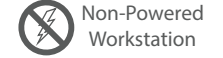
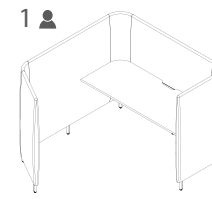
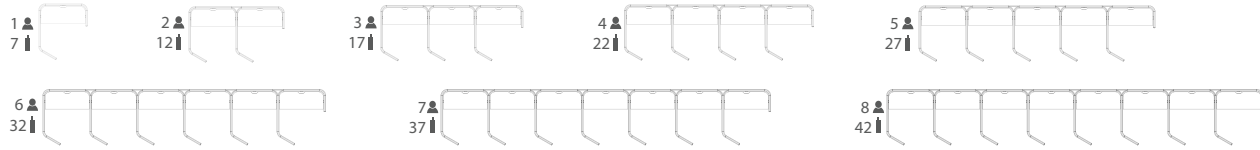

Number of Feet per Typical (MTL10 Option)

1 Select Model

Weight	Standard Veneer Top Upholstered Panels - COM\$	Premium Veneer Top Upholstered Panels - COM\$
560 x 83 x 55	8 HNY56083FT558W 52584	"P" Option N/A
491 x 83 x 55	7 HNY49183FT558W 46177	"P" Option N/A
421 x 83 x 55	6 HNY42183FT558W 39770	"P" Option N/A
352 x 83 x 55	5 HNY35283FT558W 33363	"P" Option N/A
282 x 83 x 55	4 HNY28283FT558W 26956	"P" Option N/A
212 x 83 x 55	3 HNY21283FT558W 20549	"P" Option N/A
143 x 83 x 55	2 HNY14383FT558W 14142	"P" Option N/A
73 x 83 x 55	1 HNY7383FT558W 7735	"P" Option N/A

2 Select Finish

Click to view finishes	WWP	WOW
	PO01	WNO
	PO02	WSO
	PO03	WNF(Natural Oak on Flat Cut)
	PO07	WSF(Salted Oak on Flat Cut)
	PO08	
	PO09	
	WBW	
	WSW	
	WEC	

3 Select Feet Finish

Click to view edges	WWP	WOW
	PO01	WNO
	PO02	WSO
	PO03	
	PO07	
	PO08	
	PO09	
	WBW	
	WSW	
	WEC	

4 Select Edge

Click to view details

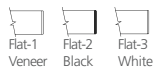

High Pressure Laminate Top Upholstered Panels - COM\$

HNY56083FT558G	50984
HNY49183FT558G	44777
HNY42183FT558G	38570
HNY35283FT558G	32363
HNY28283FT558G	26156
HNY21283FT558G	19949
HNY14383FT558G	13742
HNY7383FT558G	7535

GEC	LW04
GNA +5%	LW05
GWL	LW06
LP01	
LF02	
LF03	
LN01	
LA02	
LW01	
LW02	

WWP	WOW
PO01	WNO
PO02	WSO
PO03	
PO07	
PO08	
PO09	
WBW	
WSW	
WEC	



Thermally Fused Laminate Top Upholstered Panels - COM\$

HNY56083FT558M	47928
HNY49183FT558M	42103
HNY42183FT558M	36278
HNY35283FT558M	30453
HNY28283FT558M	24628
HNY21283FT558M	18803
HNY14383FT558M	12978
HNY7383FT558M	7153

MOC
MEC
MSW
MTW
MWL
MNA

WWP	WOW
PO01	WNO
PO02	WSO
PO03	
PO07	
PO08	
PO09	
WBW	
WSW	



Click here to view statement of line

Product Features

- HNY6625WT162 Fixed Desk Height Worksurfaces are included
- 5" Solid wood feet - oval shape
- Ships KD
- T75 worksurface wire cutout is standard on all worksurfaces.(T75D: Delete cutout is optional)

Options

Accessories

- K28: Articulating Keyboard w/ Mouse - \$390
- K31-SK: Center drawer w/ skirt - \$310
- K31: Center drawer w/o skirt - \$205

Delete Top

- DFT: Delete fixed top. Deduct \$1325 Veneer(W), \$1125 High Pressure Laminate (G), \$743 Thermally Fused Laminate (M) per top

Metal Feet

- MTL10: Replace solid wood feet with metal feet, standard MFW White - \$55 ea

Premium Metal Finish

- Specify premium Metal Finish. MFMB: Matte Black, MFS: Silver, MFSS: Salmon Sienna, MFSA: Surfing Aquavert, MFPS: Pistachio, MFOS: Oyster, MFNA: Navy, MFOL: Olive, MFGB: Grey Beige MFGG: Graphite Gray, MFG: Gray, MFGM: Matte Gold
- Premium Metal Finish for WMT Wire Management Tray - \$75 ea
- Premium Metal Finish for MTL10 Metal Feet - \$20 ea
- Premium Metal Finish for PCEB Concealed Floor Power Infeed Cover - \$35

Worksurface Height

- THL-42: Modify worksurface height to bar height - N/C

Wire Tray

- WMT: Wire metal tray. Mounts under top and comes standard in MFW White - \$210

DARRAN

Honey

Linear 90° Workstation Typical
Height Adjustable Worksurface

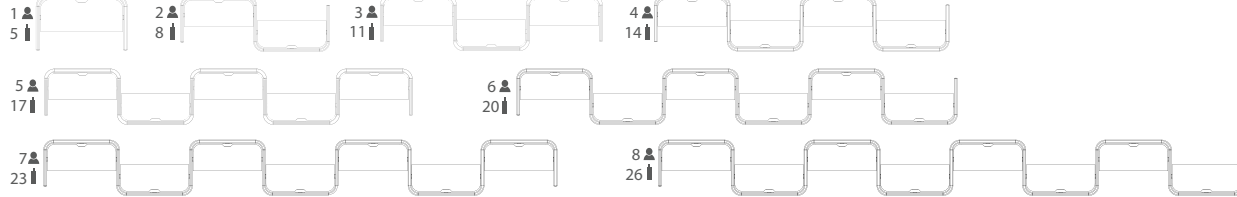

Number of Feet per Typical (MTL10 Option)

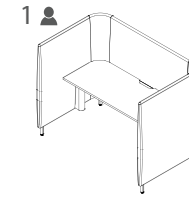

1 Select Model

Weight

Standard Veneer Top Upholstered Panels - COM\$

Premium Veneer Top Upholstered Panels - COM\$

High Pressure Laminate Top Upholstered Panels - COM\$

Thermally Fused Laminate Top Upholstered Panels - COM\$

w" x d" x h"	Standard Veneer Top Upholstered Panels - COM\$	Premium Veneer Top Upholstered Panels - COM\$
560 x 53 x 55	8 HNY56053HA559W 64635	"P" Option N/A
491 x 53 x 55	7 HNY49153HA559W 56676	"P" Option N/A
421 x 53 x 55	6 HNY42153HA559W 48717	"P" Option N/A
352 x 53 x 55	5 HNY35253HA559W 40758	"P" Option N/A
282 x 53 x 55	4 HNY28253HA559W 32799	"P" Option N/A
212 x 53 x 55	3 HNY21253HA559W 24840	"P" Option N/A
143 x 53 x 55	2 HNY14353HA559W 16881	"P" Option N/A
73 x 45 x 55	1 HNY7345HA559W 8922	"P" Option N/A

"P" Option N/A
"P" Option N/A
"P" Option N/A
"P" Option N/A
"P" Option N/A
"P" Option N/A
"P" Option N/A
"P" Option N/A
"P" Option N/A

HNY56053HA559G	63027
HNY49153HA559G	55269
HNY42153HA559G	47511
HNY35253HA559G	39753
HNY28253HA559G	31995
HNY21253HA559G	24237
HNY14353HA559G	16479
HNY7345HA559G	8721

HNY56053HA559M	59971
HNY49153HA559M	52595
HNY42153HA559M	45219
HNY35253HA559M	37843
HNY28253HA559M	30467
HNY21253HA559M	23091
HNY14353HA559M	15715
HNY7345HA559M	8339

[Click here to view statement of line](#)

Product Features

- HNY6625WT163 Height Adjustable worksurfaces are included
- 5" Solid wood feet - oval shape
- 4 Power outlets with 1 telecom plate, see options below for telecom plate
- Ships KD
- Wire management tray attaches to worksurface top, standard in MFW White, see premium Metal Finish for options
- Hardwire infeed and jumpers are included in workstations
- T75 worksurface wire cutout is standard on all worksurfaces.(T75D: Delete cutout is optional)

[Click Here for Graded in Pricing](#)

2 Select Finish

Click to view finishes

WWP	WOW
PO01	WNO
PO02	WSO
PO03	WNF(Natural Oak on Flat Cut)
PO07	WSF(Salted Oak on Flat Cut)
PO08	WSF(Salted Oak on Flat Cut)
PO09	WSF(Salted Oak on Flat Cut)
WBW	
WSW	
WEC	

GEC	LW04
GNA +5%	LW05
GWL	LW06
LP01	
LF02	
LF03	
LN01	
LA02	
LW01	
LW02	

MOC
MEC
MSW
MTW
MWL
MNA

3 Select Feet Finish

Click to view edges

WWP	WOW
PO01	WNO
PO02	WSO
PO03	
PO07	
PO08	
PO09	
WBW	
WSW	
WEC	

WWP	WOW
PO01	WNO
PO02	WSO
PO03	
PO07	
PO08	
PO09	
WBW	
WSW	
WEC	

WWP	WOW
PO01	WNO
PO02	WSO
PO03	
PO07	
PO08	
PO09	
WEC	
WBW	
WSW	

4 Select Edge

Click to view details

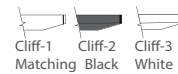
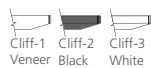

DARRAN

Honey

Linear 90° Workstation Typical

Fixed Power Worksurface

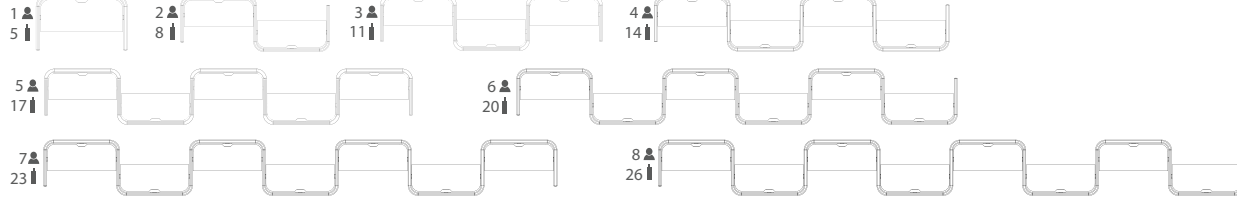

Number of Feet per Typical (MTL10 Option)

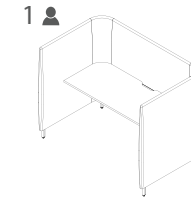

1 Select Model

Weight

Standard Veneer Top Upholstered Panels - COM\$

Premium Veneer Top Upholstered Panels - COM\$

High Pressure Laminate Top Upholstered Panels - COM\$

Thermally Fused Laminate Top Upholstered Panels - COM\$

w" x d" x h"	Standard Veneer Top Upholstered Panels - COM\$	Premium Veneer Top Upholstered Panels - COM\$
560 x 53 x 55	8 HNY56053FP559W 46155	"P" Option N/A
491 x 53 x 55	7 HNY49153FP559W 40506	"P" Option N/A
421 x 53 x 55	6 HNY42153FP559W 34857	"P" Option N/A
352 x 53 x 55	5 HNY35253FP559W 29208	"P" Option N/A
282 x 53 x 55	4 HNY28253FP559W 23559	"P" Option N/A
212 x 53 x 55	3 HNY21253FP559W 17910	"P" Option N/A
143 x 53 x 55	2 HNY14353FP559W 12261	"P" Option N/A
73 x 45 x 55	1 HNY7345FP559W 6612	"P" Option N/A

"P" Option N/A
 "P" Option N/A
 "P" Option N/A
 "P" Option N/A
 "P" Option N/A
 "P" Option N/A
 "P" Option N/A
 "P" Option N/A

High Pressure Laminate Top Upholstered Panels - COM\$	Thermally Fused Laminate Top Upholstered Panels - COM\$
HNY56053FP559G 44555	HNY56053FP559M 41499
HNY49153FP559G 39106	HNY49153FP559M 36432
HNY42153FP559G 33657	HNY42153FP559M 31365
HNY35253FP559G 28208	HNY35253FP559M 26298
HNY28253FP559G 22759	HNY28253FP559M 21231
HNY21253FP559G 17310	HNY21253FP559M 16164
HNY14353FP559G 11861	HNY14353FP559M 11097
HNY7345FP559G 6412	HNY7345FP559M 6030

MOC
 MEC
 MSW
 MTW
 MWL
 MNA

[Click Here for Graded in Pricing](#)

2 Select Finish

Click to view finishes

WWP	WOW
PO01	WNO
PO02	WSO
PO03	WNF(Natural Oak on Flat Cut)
PO07	WSF(Salted Oak on Flat Cut)
PO08	WSF(Salted Oak on Flat Cut)
PO09	WSF(Salted Oak on Flat Cut)
WBW	
WSW	
WEC	

GEC	LW04
GNA +5%	LW05
GWL	LW06
LP01	
LF02	
LF03	
LN01	
LA02	
LW01	
LW02	

3 Select Feet Finish

Click to view edges

WWP	WOW
PO01	WNO
PO02	WSO
PO03	
PO07	
PO08	
PO09	
WBW	
WSW	
WEC	

WWP	WOW
PO01	WNO
PO02	WSO
PO03	
PO07	
PO08	
PO09	
WBW	
WSW	
WEC	

WWP	WOW
PO01	WNO
PO02	WSO
PO03	
PO07	
PO08	
PO09	
WEC	
WBW	
WSW	

4 Select Edge

Click to view details

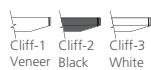

[Click here to view statement of line](#)

Product Features

- HNY6625WT162 Fixed Desk Height Worksurfaces are included
- 5" Solid wood feet - oval shape
- 4 Power outlets with 1 telecom plate, see options below for telecom plate
- Ships KD
- Wire management tray attaches to worksurface top, standard in MFW White, see premium Metal Finish for options
- Hardwire infeed and jumpers are included in workstations
- T75 worksurface wire cutout is standard on all worksurfaces.(T75D: Delete cutout is optional)

Options

Accessories

- K28: Articulating Keyboard w/ Mouse - \$390
- K31-SK: Center drawer w/ skirt - \$310
- K31: Center drawer w/o skirt - \$205

Concealed Floor Power Infeed Cover

- PCEB: White Metal Finish concealed floor power infeed cover - \$150

Delete Top and Wire Tray

- DFP: Delete fixed top. Deduct \$1535 Veneer (W), \$1335 High Pressure Laminate (G), \$953 Thermally Fused Laminate (M) per top

Metal Feet

- MTL10: Replace solid wood feet with metal feet, standard MFW White - \$55 ea

Premium Metal Finish

- Specify premium Metal Finish. MFMB: Matte Black, MFS: Silver, MFSS: Salmon Sienna, MFSA: Surfing Aquavert, MFPS: Pistachio, MFOS: Oyster, MFNA: Navy, MFOL: Olive, MFGB: Grey Beige MFGG: Graphite Gray, MFG: Gray, MFGM: Matte Gold
- Premium Metal Finish for WMT Wire Management Tray - \$75 ea
- Premium Metal Finish for MTL10 Metal Feet - \$20 ea
- Premium Metal Finish for PCEB Concealed Floor Power Infeed Cover - \$35

Telecom Plates

- Each power unit has 1 plate. All telecom connectors sold separately.
- RJ45 (1) - \$55, RJ45 (2) - \$110, RJ45 (3) - \$165, USB (1) - \$70, USB (2) - \$140, RJ45/USB - \$125, RJ45/HDMI - \$210, HDMI/USB - \$205
- THL-42: Modify worksurface height to bar height - N/C

DARRAN

Honey

Linear 90° Workstation Typical

Fixed Worksurface

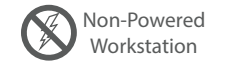
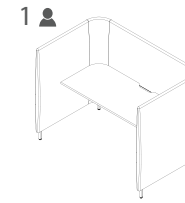
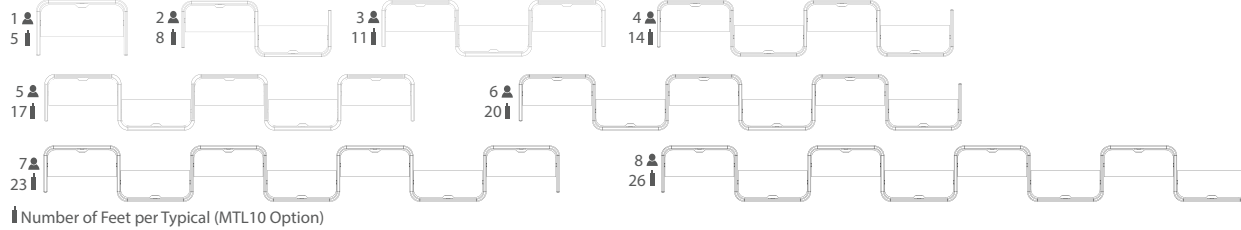

1 Select Model

Weight

Standard Veneer Top Upholstered Panels - COM\$

Premium Veneer Top Upholstered Panels - COM\$

High Pressure Laminate Top Upholstered Panels - COM\$

Thermally Fused Laminate Top Upholstered Panels - COM\$

w" x d" x h"	Weight	Standard Veneer Top Upholstered Panels - COM\$
560 x 53 x 55	8	HNY56053FT559W 39568
491 x 53 x 55	7	HNY49153FT559W 34736
421 x 53 x 55	6	HNY42153FT559W 29904
352 x 53 x 55	5	HNY35253FT559W 25072
282 x 53 x 55	4	HNY28253FT559W 20240
212 x 53 x 55	3	HNY21253FT559W 15408
143 x 53 x 55	2	HNY14353FT559W 10576
73 x 45 x 55	1	HNY7345FT559W 5744

"P" Option N/A
"P" Option N/A
"P" Option N/A
"P" Option N/A
"P" Option N/A
"P" Option N/A
"P" Option N/A
"P" Option N/A
"P" Option N/A

HNY56053FT559G	37968
HNY49153FT559G	33336
HNY42153FT559G	28704
HNY35253FT559G	24072
HNY28253FT559G	19440
HNY21253FT559G	14808
HNY14353FT559G	10176
HNY7345FT559G	5544

HNY56053FT559M	34912
HNY49153FT559M	30662
HNY42153FT559M	26412
HNY35253FT559M	22162
HNY28253FT559M	17912
HNY21253FT559M	13662
HNY14353FT559M	9381
HNY7345FT559M	5162

[Click here to view statement of line](#)

Product Features

- HNY6625WT162 Fixed Desk Height Worksurfaces are included
- 5" Solid wood feet - oval shape
- Ships KD
- T75 worksurface wire cutout is standard on all worksurfaces.(T75D: Delete cutout is optional)

Options

Accessories

- K28: Articulating Keyboard w/ Mouse - \$390
- K31-SK: Center drawer w/ skirt - \$310
- K31: Center drawer w/o skirt - \$205

Delete Top

- DFT: Delete fixed top. Deduct \$1325 Veneer(W), \$1125 High Pressure Laminate (G), \$743 Thermally Fused Laminate (M) per top

Metal Feet

- MTL10: Replace solid wood feet with metal feet, standard MFW White - \$55 ea

Premium Metal Finish

- Specify premium Metal Finish. MFMB: Matte Black, MFS: Silver, MFSS: Salmon Sienna, MFSA: Surf in Aquavert, MFPS: Pistachio, MFOS: Oyster, MFNA: Navy, MFOL: Olive, MFGB: Grey Beige MFGG: Graphite Gray, MFG: Gray, MFGM: Matte Gold
- Premium Metal Finish for WMT Wire Management Tray - \$75 ea
- Premium Metal Finish for MTL10 Metal Feet - \$20 ea
- Premium Metal Finish for PCEB Concealed Floor Power Infeed Cover - \$35

Worksurface Height

- THL-42: Modify worksurface height to bar height - N/C

Wire Tray

- WMT: Wire metal tray. Mounts under top and comes standard in MFW White - \$210

[Click Here for Graded in Pricing](#)

2 Select Finish

Click to view finishes

WWP	WOW
PO01	WNO
PO02	WSO
PO03	WNF(Natural Oak on Flat Cut)
PO07	WSF(Salted Oak on Flat Cut)
PO08	WSF(Salted Oak on Flat Cut)
PO09	WSF(Salted Oak on Flat Cut)
WBW	
WSW	
WEC	

3 Select Feet Finish

Click to view edges

WWP	WOW
PO01	WNO
PO02	WSO
PO03	
PO07	
PO08	
PO09	
WBW	
WSW	
WEC	

4 Select Edge

Click to view details

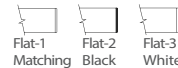



Number of Feet per Typical (MTL10 Option)

1 Select Model

Weight

Standard Veneer Top
Upholstered Panels - COM\$

Premium Veneer Top
Upholstered Panels - COM\$

High Pressure Laminate Top
Upholstered Panels - COM\$

Thermally Fused Laminate Top
Upholstered Panels - COM\$

w" x d" x h"	Standard Veneer Top Upholstered Panels - COM\$	Premium Veneer Top Upholstered Panels - COM\$	High Pressure Laminate Top Upholstered Panels - COM\$	Thermally Fused Laminate Top Upholstered Panels - COM\$
282 x 64 x 55	8 HNY28264HA560W 51938	"P" Option N/A	HNY28264HA560G 50330	HNY28264HA560M 47274
212 x 64 x 55	6 HNY21264HA560W 39618	"P" Option N/A	HNY21264HA560G 38412	HNY21264HA560M 36120
143 x 64 x 55	4 HNY14364HA560W 27298	"P" Option N/A	HNY14364HA560G 26494	HNY14364HA560M 24966
73 x 64 x 55	2 HNY7364HA560W 14978	"P" Option N/A	HNY7364HA560G 14576	HNY7364HA560M 13812

[Click Here for Graded in Pricing](#)

2 Select Finish

Click to view finishes

WWP	WOW
PO01	WNO
PO02	WSO
PO03	WNF(Natural Oak on Flat Cut)
PO07	WSF(Salted Oak on Flat Cut)
PO08	WSF(Salted Oak on Flat Cut)
PO09	WSF(Salted Oak on Flat Cut)
WBW	
WSW	
WEC	

3 Select Feet Finish

Click to view edges

WWP	WOW
PO01	WNO
PO02	WSO
PO03	
PO07	
PO08	
PO09	
WBW	
WSW	
WEC	

4 Select Edge

Click to view details

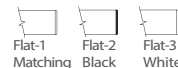
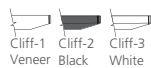

[Click here to view statement of line](#)

Product Features

- HNY6625WT163 Height Adjustable worksurfaces are included
- 5" Solid wood feet - oval shape
- 4 Power outlets with 1 telecom plate, see options below for telecom plate
- Ships KD
- Wire management tray attaches to worksurface top, standard in MFW White, see premium Metal Finish for options
- Hardwire infeed and jumpers are included in workstations
- T75 worksurface wire cutout is standard on all worksurfaces.(T75D: Delete cutout is optional)

Options

Accessories

- K28: Articulating Keyboard w/ Mouse - \$390
- K31-SK: Center drawer w/ skirt - \$310
- K31: Center drawer w/o skirt - \$205

Concealed Floor Power Infeed Cover

- PCEB: White Metal Finish concealed floor power infeed cover - \$150

Delete Top and Wire Tray

- DHAT: Delete height adjustable top. Deduct \$3845 Veneer(W), \$3644 High Pressure Laminate(G), \$3262 Thermally Fused Laminate(M) per top

Metal Feet

- MTL10: Replace solid wood feet with metal feet, standard MFW White - \$55 ea

Premium Metal Finish

- Specify premium Metal Finish. MFMB: Matte Black, MFS: Silver, MFSS: Salmon Sienna, MFSA: SurfIn Aquavert, MFPS: Pistachio, MFOS: Oyster, MFNA: Navy, MFOL: Olive, MFGB: Grey Beige MFGG: Graphite Gray, MFG: Gray, MFGM: Matte Gold
- Premium Metal Finish for WMT Wire Management Tray - \$75 ea
- Premium Metal Finish for MTL10 Metal Feet - \$20 ea
- Premium Metal Finish for PCEB Concealed Floor Power Infeed Cover - \$35

Telecom Plates

- Each power unit has 1 plate. All telecom connectors sold separately.
- RJ45 (1) - \$55, RJ45 (2) - \$110, RJ45 (3) - \$165, USB (1) - \$70, USB (2) - \$140, RJ45/USB - \$125, RJ45/HDMI - \$210, HDMI/USB - \$205

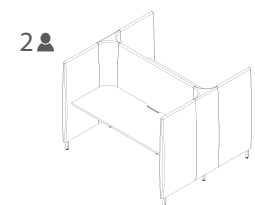

Number of Feet per Typical (MTL10 Option)

1 Select Model

Weight

Standard Veneer Top Upholstered Panels - COM\$

Premium Veneer Top Upholstered Panels - COM\$

High Pressure Laminate Top Upholstered Panels - COM\$

Thermally Fused Laminate Top Upholstered Panels - COM\$

w" x d" x h"	Weight	Standard Veneer Top Upholstered Panels - COM\$
282 x 64 x 55	8	HNY28264FP560W 33458
212 x 64 x 55	6	HNY21264FP560W 25758
143 x 64 x 55	4	HNY14364FP560W 18058
73 x 64 x 55	2	HNY7364FP560W 10358

"P" Option N/A
"P" Option N/A
"P" Option N/A
"P" Option N/A

HNY28264FP560G	31858
HNY21264FP560G	24558
HNY14364FP560G	17258
HNY7364FP560G	9958

HNY28264FP560M	28802
HNY21264FP560M	22266
HNY14364FP560M	15730
HNY7364FP560M	9194

Product Features

- HNY6625WT162 Fixed Desk Height Worksurfaces are included
- 5" Solid wood feet - oval shape
- 4 Power outlets with 1 telecom plate, see options below for telecom plate
- Ships KD
- Wire management tray attaches to worksurface top, standard in MFW White, see premium Metal Finish for options
- Hardwire infeed and jumpers are included in workstations
- T75 worksurface wire cutout is standard on all worksurfaces.(T75D: Delete cutout is optional)

Options

Accessories

- K28: Articulating Keyboard w/ Mouse - \$390
- K31-SK: Center drawer w/ skirt - \$310
- K31: Center drawer w/o skirt - \$205

Concealed Floor Power Infeed Cover

- PCEB: White Metal Finish concealed floor power infeed cover - \$150

Delete Top and Wire Tray

- DFP: Delete fixed top. Deduct \$1535 Veneer (W), \$1335 High Pressure Laminate (G), \$953 Thermally Fused Laminate (M) per top

Metal Feet

- MTL10: Replace solid wood feet with metal feet, standard MFW White - \$55 ea

Premium Metal Finish

- Specify premium Metal Finish. MFMB: Matte Black, MFS: Silver, MFSS: Salmon Sienna, MFSA: SurfIn Aquavert, MFPS: Pistachio, MFOS: Oyster, MFNA: Navy, MFOL: Olive, MFGB: Grey Beige MFGG: Graphite Gray, MFG: Gray, MFGM: Matte Gold
- Premium Metal Finish for WMT Wire Management Tray - \$75 ea
- Premium Metal Finish for MTL10 Metal Feet - \$20 ea
- Premium Metal Finish for PCEB Concealed Floor Power Infeed Cover - \$35

Telecom Plates

- Each power unit has 1 plate. All telecom connectors sold separately.
- RJ45 (1) - \$55, RJ45 (2) - \$110, RJ45 (3) - \$165, USB (1) - \$70, USB (2) - \$140, RJ45/USB - \$125, RJ45/HDMI - \$210, HDMI/USB - \$205
- THL-42: Modify worksurface height to bar height - N/C

[Click Here for Graded in Pricing](#)

2 Select Finish

Click to view finishes

WWP	WOW
PO01	WNO
PO02	WSO
PO03	WNF(Natural Oak on Flat Cut)
PO07	WSF(Salted Oak on Flat Cut)
PO08	WSF(Salted Oak on Flat Cut)
PO09	WSW
PO09	WEC
WBW	
WSW	
WEC	

GEC	LW04
GNA +5%	LW05
GWL	LW06
LP01	
LF02	
LF03	
LN01	
LA02	
LW01	
LW02	

MOC
MEC
MSW
MTW
MWL
MNA

3 Select Feet Finish

Click to view edges

WWP	WOW
PO01	WNO
PO02	WSO
PO03	
PO07	
PO08	
PO09	
WBW	
WSW	
WEC	

WWP	WOW
PO01	WNO
PO02	WSO
PO03	
PO07	
PO08	
PO09	
WBW	
WSW	
WEC	

WWP	WOW
PO01	WNO
PO02	WSO
PO03	
PO07	
PO08	
PO09	
WEC	
WBW	
WSW	

4 Select Edge

Click to view details

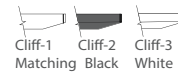
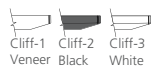

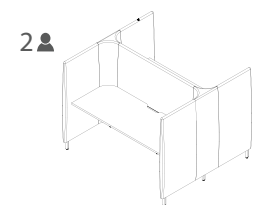

Number of Feet per Typical (MTL10 Option)

1 Select Model

w" x d" x h"	Weight	Standard Veneer Top Upholstered Panels - COM\$	Premium Veneer Top Upholstered Panels - COM\$	High Pressure Laminate Top Upholstered Panels - COM\$	Thermally Fused Laminate Top Upholstered Panels - COM\$
282 x 64 x 55	8	HNY28264FT560W 30480	"P" Option N/A	HNY28264FT560G 28880	HNY28264FT560M 25824
212 x 64 x 55	6	HNY21264FT560W 23477	"P" Option N/A	HNY21264FT560G 22277	HNY21264FT560M 19985
143 x 64 x 55	4	HNY14364FT560W 16474	"P" Option N/A	HNY14364FT560G 15674	HNY14364FT560M 14146
73 x 64 x 55	2	HNY7364FT560W 9471	"P" Option N/A	HNY7364FT560G 9071	HNY7364FT560M 8307

[Click Here for Graded in Pricing](#)

2 Select Finish

Click to view finishes

WWP	WOW
PO01	WNO
PO02	WSO
PO03	WNF(Natural Oak on Flat Cut)
PO07	WSF(Salted Oak on Flat Cut)
PO08	WSF(Salted Oak on Flat Cut)
PO09	WSF(Salted Oak on Flat Cut)
WBW	
WSW	
WEC	

3 Select Feet Finish

Click to view edges

WWP	WOW
PO01	WNO
PO02	WSO
PO03	
PO07	
PO08	
PO09	
WBW	
WSW	
WEC	

4 Select Edge

Click to view details



GEC	LW04
GNA +5%	LW05
GWL	LW06
LP01	
LF02	
LF03	
LN01	
LA02	
LW01	
LW02	

WWP	WOW
PO01	WNO
PO02	WSO
PO03	
PO07	
PO08	
PO09	
WBW	
WSW	
WEC	



MOC
MEC
MSW
MTW
MWL
MNA

WWP	WOW
PO01	WNO
PO02	WSO
PO03	
PO07	
PO08	
PO09	
WEC	
WBW	
WSW	



[Click here to view statement of line](#)

Product Features

- HNY6625WT162 Fixed Desk Height Worksurfaces are included
- 5" Solid wood feet - oval shape
- Ships KD
- T75 worksurface wire cutout is standard on all worksurfaces.(T75D: Delete cutout is optional)

Options

Accessories

- K28: Articulating Keyboard w/ Mouse - \$390
- K31-SK: Center drawer w/ skirt - \$310
- K31: Center drawer w/o skirt - \$205

Delete Top

- DFT: Delete fixed top. Deduct \$1325 Veneer(W), \$1125 High Pressure Laminate (G), \$743 Thermally Fused Laminate (M) per top

Metal Feet

- MTL10: Replace solid wood feet with metal feet, standard MFW White - \$55 ea

Premium Metal Finish

- Specify premium Metal Finish. MFMB: Matte Black, MFS: Silver, MFSS: Salmon Sienna, MFSA: Surfing Aquavert, MFPS: Pistachio, MFOS: Oyster, MFNA: Navy, MFOL: Olive, MFGB: Grey Beige MFGG: Graphite Gray, MFG: Gray, MFGM: Matte Gold
- Premium Metal Finish for WMT Wire Management Tray - \$75 ea
- Premium Metal Finish for MTL10 Metal Feet - \$20 ea
- Premium Metal Finish for PCEB Concealed Floor Power Infeed Cover - \$35

Worksurface Height

- THL-42: Modify worksurface height to bar height - N/C

Wire Tray

- WMT: Wire metal tray. Mounts under top and comes standard in MFW White - \$210

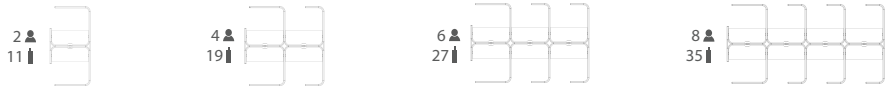

Number of Feet per Typical (MTL10 Option)

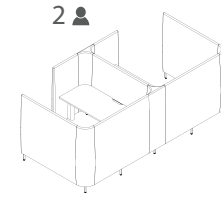

1 Select Model

Weight

w" x d" x h"	Standard Veneer Top Upholstered Panels - COM\$	Premium Veneer Top Upholstered Panels - COM\$	High Pressure Laminate Top Upholstered Panels - COM\$	Thermally Fused Laminate Top Upholstered Panels - COM\$
282 x 143 x 55	8 HNY282143HA561W 68712	"P" Option N/A	HNY282143HA561G 67104	HNY282143HA561M 64048
212 x 143 x 55	6 HNY212143HA561W 52414	"P" Option N/A	HNY212143HA561G 51208	HNY212143HA561M 48916
143 x 143 x 55	4 HNY143143HA561W 36116	"P" Option N/A	HNY143143HA561G 35312	HNY143143HA561M 33784
73 x 143 x 55	2 HNY73143HA561W 19818	"P" Option N/A	HNY73143HA561G 19416	HNY73143HA561M 18652

[Click Here for Graded in Pricing](#)

2 Select Finish

Click to view finishes

WWP	WOW
PO01	WNO
PO02	WSO
PO03	WNF(Natural Oak on Flat Cut)
PO07	WSF(Salted Oak on Flat Cut)
PO08	
PO09	
WBW	
WSW	
WEC	

3 Select Feet Finish

Click to view edges

WWP	WOW
PO01	WNO
PO02	WSO
PO03	
PO07	
PO08	
PO09	
WBW	
WSW	
WEC	

4 Select Edge

Click to view details



GEC	LW04
GNA +5%	LW05
GWL	LW06
LP01	
LF02	
LF03	
LN01	
LA02	
LW01	
LW02	

WWP	WOW
PO01	WNO
PO02	WSO
PO03	
PO07	
PO08	
PO09	
WBW	
WSW	
WEC	

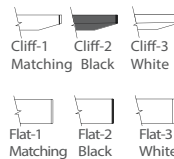

MOC
MEC
MSW
MTW
MWL
MNA

WWP	WOW
PO01	WNO
PO02	WSO
PO03	
PO07	
PO08	
PO09	
WEC	
WBW	
WSW	



[Click here to view statement of line](#)

Product Features

- HNY6625WT163 Height Adjustable worksurfaces are included
- 5" Solid wood feet - oval shape
- 4 Power outlets with 1 telecom plate, see options below for telecom plate
- Ships KD
- Wire management tray attaches to worksurface top, standard in MFW White, see premium Metal Finish for options
- Hardwire infeed and jumpers are included in workstations
- T75 worksurface wire cutout is standard on all worksurfaces.(T75D: Delete cutout is optional)

Options

Accessories

- K28: Articulating Keyboard w/ Mouse - \$390
- K31-SK: Center drawer w/ skirt - \$310
- K31: Center drawer w/o skirt - \$205

Concealed Floor Power Infeed Cover

- PCEB: White Metal Finish concealed floor power infeed cover - \$150

Delete Top and Wire Tray

- DHAT: Delete height adjustable top. Deduct \$3845 Veneer(W), \$3644 High Pressure Laminate(G), \$3262 Thermally Fused Laminate(M) per top

Metal Feet

- MTL10: Replace solid wood feet with metal feet, standard MFW White - \$55 ea

Premium Metal Finish

- Specify premium Metal Finish. MFMB: Matte Black, MFS: Silver, MFSS: Salmon Sienna, MFSA: Surfing Aquavert, MFPS: Pistachio, MFOS: Oyster, MFNA: Navy, MFOL: Olive, MFGB: Grey Beige MFGG: Graphite Gray, MFG: Gray, MFGM: Matte Gold
- Premium Metal Finish for WMT Wire Management Tray - \$75 ea
- Premium Metal Finish for MTL10 Metal Feet - \$20 ea
- Premium Metal Finish for PCEB Concealed Floor Power Infeed Cover - \$35

Telecom Plates

- Each power unit has 1 plate. All telecom connectors sold separately.
- RJ45 (1) - \$55, RJ45 (2) - \$110, RJ45 (3) - \$165, USB (1) - \$70, USB (2) - \$140, RJ45/USB - \$125, RJ45/HDMI - \$210, HDMI/USB - \$205

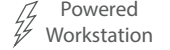
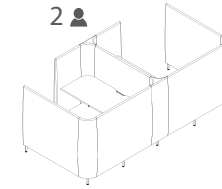
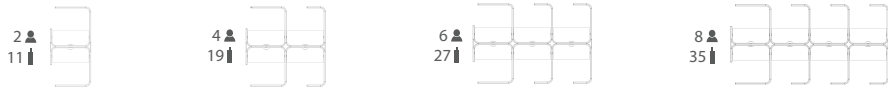

Number of Feet per Typical (MTL10 Option)

1 Select Model

Weight

Standard Veneer Top Upholstered Panels - COM\$

Premium Veneer Top Upholstered Panels - COM\$

High Pressure Laminate Top Upholstered Panels - COM\$

Thermally Fused Laminate Top Upholstered Panels - COM\$

w" x d" x h"	Weight	Standard Veneer Top Upholstered Panels - COM\$
282 x 143 x 55	8	HNY282143FP561W 50232
212 x 143 x 55	6	HNY212143FP561W 38554
143 x 143 x 55	4	HNY143143FP561W 26876
73 x 143 x 55	2	HNY73143FP561W 15198

"P" Option N/A
"P" Option N/A
"P" Option N/A
"P" Option N/A

HNY282143FP561G	48632
HNY212143FP561G	37354
HNY143143FP561G	26076
HNY73143FP561G	14798

HNY282143FP561M	45576
HNY212143FP561M	35062
HNY143143FP561M	24548
HNY73143FP561M	14034

Product Features

- HNY6625WT162 Fixed Desk Height Worksurfaces are included
- 5" Solid wood feet - oval shape
- 4 Power outlets with 1 telecom plate, see options below for telecom plate
- Ships KD
- Wire management tray attaches to worksurface top, standard in MFW White, see premium Metal Finish for options
- Hardwire infeed and jumpers are included in workstations
- T75 worksurface wire cutout is standard on all worksurfaces.(T75D: Delete cutout is optional)

Options

Accessories

- K28: Articulating Keyboard w/ Mouse - \$390
- K31-SK: Center drawer w/ skirt - \$310
- K31: Center drawer w/o skirt - \$205

Concealed Floor Power Infeed Cover

- PCEB: White Metal Finish concealed floor power infeed cover - \$150

Delete Top and Wire Tray

- DFP: Delete fixed top. Deduct \$1535 Veneer (W), \$1335 High Pressure Laminate (G), \$953 Thermally Fused Laminate (M) per top

Metal Feet

- MTL10: Replace solid wood feet with metal feet, standard MFW White - \$55 ea

Premium Metal Finish

- Specify premium Metal Finish. MFMB: Matte Black, MFS: Silver, MFSS: Salmon Sienna, MFSA: SurfIn Aquavert, MFPS: Pistachio, MFOS: Oyster, MFNA: Navy, MFOL: Olive, MFGB: Grey Beige MFGG: Graphite Gray, MFG: Gray, MFGM: Matte Gold
- Premium Metal Finish for WMT Wire Management Tray - \$75 ea
- Premium Metal Finish for MTL10 Metal Feet - \$20 ea
- Premium Metal Finish for PCEB Concealed Floor Power Infeed Cover - \$35

Telecom Plates

- Each power unit has 1 plate. All telecom connectors sold separately.
- RJ45 (1) - \$55, RJ45 (2) - \$110, RJ45 (3) - \$165, USB (1) - \$70, USB (2) - \$140, RJ45/USB - \$125, RJ45/HDMI - \$210, HDMI/USB - \$205
- THL-42: Modify worksurface height to bar height - N/C

[Click Here for Graded in Pricing](#)

2 Select Finish

Click to view finishes

WWP	WOW
PO01	WNO
PO02	WSO
PO03	WNF(Natural Oak on Flat Cut)
PO07	WSF(Salted Oak on Flat Cut)
PO08	WSF(Salted Oak on Flat Cut)
PO09	WSF(Salted Oak on Flat Cut)
WBW	
WSW	
WEC	

3 Select Feet Finish

Click to view edges

WWP	WOW
PO01	WNO
PO02	WSO
PO03	
PO07	
PO08	
PO09	
WBW	
WSW	
WEC	

4 Select Edge

Click to view details

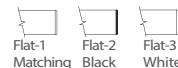

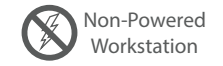
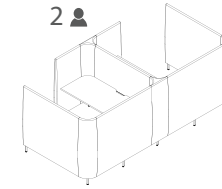
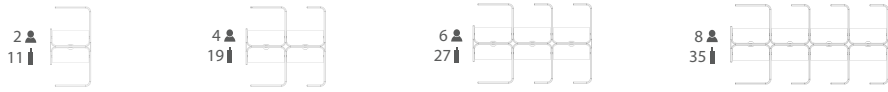

Number of Feet per Typical (MTL10 Option)

1 Select Model

Weight

Standard Veneer Top Upholstered Panels - COM\$

Premium Veneer Top Upholstered Panels - COM\$

High Pressure Laminate Top Upholstered Panels - COM\$

Thermally Fused Laminate Top Upholstered Panels - COM\$

w" x d" x h"	Weight	Standard Veneer Top Upholstered Panels - COM\$
282 x 143 x 55	11	8 HNY282143FT561W 46870
212 x 143 x 55	11	6 HNY212143FT561W 35985
143 x 143 x 55	11	4 HNY143143FT561W 25100
73 x 143 x 55	11	2 HNY73143FT561W 14215

"P" Option N/A
"P" Option N/A
"P" Option N/A
"P" Option N/A

HNY282143FT561G	45270
HNY212143FT561G	34785
HNY143143FT561G	24300
HNY73143FT561G	13815

HNY282143FT561M	42214
HNY212143FT561M	32493
HNY143143FT561M	22772
HNY73143FT561M	13051

Click here to view statement of line

Product Features

- HNY6625WT162 Fixed Desk Height Worksurfaces are included
- 5" Solid wood feet - oval shape
- Ships KD
- T75 worksurface wire cutout is standard on all worksurfaces.(T75D: Delete cutout is optional)

Options

Accessories

- K28: Articulating Keyboard w/ Mouse - \$390
- K31-SK: Center drawer w/ skirt - \$310
- K31: Center drawer w/o skirt - \$205

Delete Top

- DFT: Delete fixed top. Deduct \$1325 Veneer(W), \$1125 High Pressure Laminate (G), \$743 Thermally Fused Laminate (M) per top

Metal Feet

- MTL10: Replace solid wood feet with metal feet, standard MFW White - \$55 ea

Premium Metal Finish

- Specify premium Metal Finish. MFMB: Matte Black, MFS: Silver, MFSS: Salmon Sienna, MFSA: Surfing Aquavert, MFPS: Pistachio, MFOS: Oyster, MFNA: Navy, MFOL: Olive, MFGB: Grey Beige MFGG: Graphite Gray, MFG: Gray, MFGM: Matte Gold
- Premium Metal Finish for WMT Wire Management Tray - \$75 ea
- Premium Metal Finish for MTL10 Metal Feet - \$20 ea
- Premium Metal Finish for PCEB Concealed Floor Power Infeed Cover - \$35

Worksurface Height

- THL-42: Modify worksurface height to bar height - N/C

Wire Tray

- WMT: Wire metal tray. Mounts under top and comes standard in MFW White - \$210

[Click Here for Graded in Pricing](#)

2 Select Finish

Click to view finishes

WWP	WOW
PO01	WNO
PO02	WSO
PO03	WNF(Natural Oak on Flat Cut)
PO07	WSF(Salted Oak on Flat Cut)
PO08	WSF(Salted Oak on Flat Cut)
PO09	WSF(Salted Oak on Flat Cut)
WBW	
WSW	
WEC	

GEC	LW04
GNA +5%	LW05
GWL	LW06
LP01	
LF02	
LF03	
LN01	
LA02	
LW01	
LW02	

MOC
MEC
MSW
MTW
MWL
MNA

3 Select Feet Finish

Click to view edges

WWP	WOW
PO01	WNO
PO02	WSO
PO03	
PO07	
PO08	
PO09	
WBW	
WSW	
WEC	

WWP	WOW
PO01	WNO
PO02	WSO
PO03	
PO07	
PO08	
PO09	
WBW	
WSW	
WEC	

WWP	WOW
PO01	WNO
PO02	WSO
PO03	
PO07	
PO08	
PO09	
WEC	
WBW	
WSW	

4 Select Edge

Click to view details



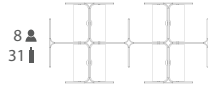

Number of Feet per Typical (MTL10 Option)

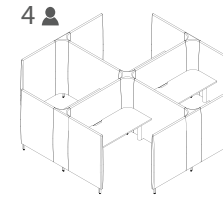

1 Select Model

Weight

w" x d" x h"
282 x 143 x 55
143 x 143 x 55

Standard Veneer Top Upholstered Panels - COM\$
8 HNY282143HA563W 64592
4 HNY143143HA563W 33508

Premium Veneer Top Upholstered Panels - COM\$
"P" Option N/A
"P" Option N/A

High Pressure Laminate Top Upholstered Panels - COM\$
HNY282143HA563G 62984
HNY143143HA563G 32704

Thermally Fused Laminate Top Upholstered Panels - COM\$
HNY282143HA563M 59928
HNY143143HA563M 31176

[Click here to view statement of line](#)

Product Features

- HNY6625WT163 Height Adjustable worksurfaces are included
- 5" Solid wood feet - oval shape
- 4 Power outlets with 1 telecom plate, see options below for telecom plate
- Ships KD
- Wire management tray attaches to worksurface top, standard in MFW White, see premium Metal Finish for options
- Hardwire infeed and jumpers are included in workstations
- T75 worksurface wire cutout is standard on all worksurfaces.(T75D: Delete cutout is optional)

[Click Here for Graded in Pricing](#)

2 Select Finish

Click to view finishes

WWP	WOW
PO01	WNO
PO02	WSO
PO03	WNF(Natural Oak on Flat Cut)
PO07	WSF(Salted Oak on Flat Cut)
PO08	
PO09	
WBW	
WSW	
WEC	

GEC	LW04
GNA +5%	LW05
GWL	LW06
LP01	
LF02	
LF03	
LN01	
LA02	
LW01	
LW02	

MOC
MEC
MSW
MTW
MWL
MNA

3 Select Feet Finish

Click to view edges

WWP	WOW
PO01	WNO
PO02	WSO
PO03	
PO07	
PO08	
PO09	
WBW	
WSW	
WEC	

WWP	WOW
PO01	WNO
PO02	WSO
PO03	
PO07	
PO08	
PO09	
WBW	
WSW	
WEC	

WWP	WOW
PO01	WNO
PO02	WSO
PO03	
PO07	
PO08	
PO09	
WEC	
WBW	
WSW	

4 Select Edge

Click to view details

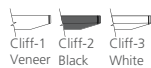

Options

Accessories

- K28: Articulating Keyboard w/ Mouse - \$390
- K31-SK: Center drawer w/ skirt - \$310
- K31: Center drawer w/o skirt - \$205

Concealed Floor Power Infeed Cover

- PCEB: White Metal Finish concealed floor power infeed cover - \$150

Delete Top and Wire Tray

- DHAT: Delete height adjustable top. Deduct \$3845 Veneer(W), \$3644 High Pressure Laminate(G), \$3262 Thermally Fused Laminate(M) per top

Metal Feet

- MTL10: Replace solid wood feet with metal feet, standard MFW White - \$55 ea

Premium Metal Finish

- Specify premium Metal Finish. MFMB: Matte Black, MFS: Silver, MFSS: Salmon Sienna, MFSA: SurfIn Aquavert, MFPS: Pistachio, MFOS: Oyster, MFNA: Navy, MFOL: Olive, MFGB: Grey Beige MFGG: Graphite Gray, MFG: Gray, MFGM: Matte Gold
- Premium Metal Finish for WMT Wire Management Tray - \$75 ea
- Premium Metal Finish for MTL10 Metal Feet - \$20 ea
- Premium Metal Finish for PCEB Concealed Floor Power Infeed Cover - \$35

Telecom Plates

- Each power unit has 1 plate. All telecom connectors sold separately.
- RJ45 (1) - \$55, RJ45 (2) - \$110, RJ45 (3) - \$165, USB (1) - \$70, USB (2) - \$140, RJ45/USB - \$125, RJ45/HDMI - \$210, HDMI/USB - \$205

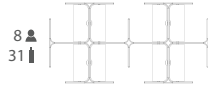

Number of Feet per Typical (MTL10 Option)

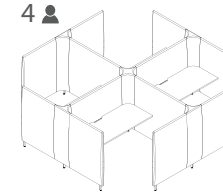

1 Select Model

Weight

w" x d" x h"
282 x 143 x 55
143 x 143 x 55

Standard Veneer Top
Upholstered Panels - COM\$

8 HNY282143FP563W 46112
4 HNY143143FP563W 24268

Premium Veneer Top
Upholstered Panels - COM\$

"P" Option N/A
"P" Option N/A

High Pressure Laminate Top
Upholstered Panels - COM\$

HNY282143FP563G 44512
HNY143143FP563G 23468

Thermally Fused Laminate Top
Upholstered Panels - COM\$

HNY282143FP563M 41456
HNY143143FP563M 21940

Product Features

- HNY6625WT162 Fixed Desk Height Worksurfaces are included
- 5" Solid wood feet - oval shape
- 4 Power outlets with 1 telecom plate, see options below for telecom plate
- Ships KD
- Wire management tray attaches to worksurface top, standard in MFW White, see premium Metal Finish for options
- Hardwire infeed and jumpers are included in workstations
- T75 worksurface wire cutout is standard on all worksurfaces.(T75D: Delete cutout is optional)

Options

Accessories

- K28: Articulating Keyboard w/ Mouse - \$390
- K31-SK: Center drawer w/ skirt - \$310
- K31: Center drawer w/o skirt - \$205

Concealed Floor Power Infeed Cover

- PCEB: White Metal Finish concealed floor power infeed cover - \$150

Delete Top and Wire Tray

- DFP: Delete fixed top. Deduct \$1535 Veneer (W), \$1335 High Pressure Laminate (G), \$953 Thermally Fused Laminate (M) per top

Metal Feet

- MTL10: Replace solid wood feet with metal feet, standard MFW White - \$55 ea

Premium Metal Finish

- Specify premium Metal Finish. MFMB: Matte Black, MFS: Silver, MFSS: Salmon Sienna, MFSA: Surfing Aquavert, MFPS: Pistachio, MFOS: Oyster, MFNA: Navy, MFOL: Olive, MFGB: Grey Beige MFGG: Graphite Gray, MFG: Gray, MFGM: Matte Gold
- Premium Metal Finish for WMT Wire Management Tray - \$75 ea
- Premium Metal Finish for MTL10 Metal Feet - \$20 ea
- Premium Metal Finish for PCEB Concealed Floor Power Infeed Cover - \$35

Telecom Plates

- Each power unit has 1 plate. All telecom connectors sold separately.
- RJ45 (1) - \$55, RJ45 (2) - \$110, RJ45 (3) - \$165, USB (1) - \$70, USB (2) - \$140, RJ45/USB - \$125, RJ45/HDMI - \$210, HDMI/USB - \$205
- THL-42: Modify worksurface height to bar height - N/C

[Click Here for Graded in Pricing](#)

2 Select Finish

Click to view finishes

WWP	WOW
PO01	WNO
PO02	WSO
PO03	WNF(Natural Oak on Flat Cut)
PO07	WSF(Salted Oak on Flat Cut)
PO08	WSF(Salted Oak on Flat Cut)
PO09	WSF(Salted Oak on Flat Cut)
WBW	
WSW	
WEC	

3 Select Feet Finish

Click to view edges

WWP	WOW
PO01	WNO
PO02	WSO
PO03	
PO07	
PO08	
PO09	
WBW	
WSW	
WEC	

4 Select Edge

Click to view details

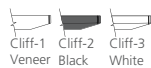

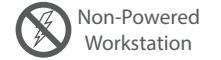
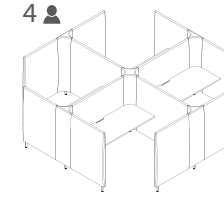
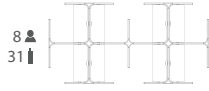

Number of Feet per Typical (MTL10 Option)

1 Select Model

Weight

w" x d" x h"
282 x 143 x 55
143 x 143 x 55

Standard Veneer Top Upholstered Panels - COM\$	
8 HNY282143FT563W	42742
4 HNY143143FT563W	22588

Premium Veneer Top Upholstered Panels - COM\$	
"P" Option N/A	
"P" Option N/A	

High Pressure Laminate Top Upholstered Panels - COM\$	
HNY282143FT563G	41142
HNY143143FT563G	21788

Thermally Fused Laminate Top Upholstered Panels - COM\$	
HNY282143FT563M	38086
HNY143143FT563M	20260

[Click here to view statement of line](#)

Product Features

- HNY6625WT162 Fixed Desk Height Worksurfaces are included
- 5" Solid wood feet - oval shape
- Ships KD
- T75 worksurface wire cutout is standard on all worksurfaces.(T75D: Delete cutout is optional)

Options

Accessories

- K28: Articulating Keyboard w/ Mouse - \$390
- K31-SK: Center drawer w/ skirt - \$310
- K31: Center drawer w/o skirt - \$205

Delete Top

- DFT: Delete fixed top. Deduct \$1325 Veneer(W), \$1125 High Pressure Laminate (G), \$743 Thermally Fused Laminate (M) per top

Metal Feet

- MTL10: Replace solid wood feet with metal feet, standard MFW White - \$55 ea

Premium Metal Finish

- Specify premium Metal Finish. MFMB: Matte Black, MFS: Silver, MFSS: Salmon Sienna, MFSA: Surfing Aquavert, MFPS: Pistachio, MFOS: Oyster, MFNA: Navy, MFOL: Olive, MFGB: Grey Beige MFGG: Graphite Gray, MFG: Gray, MFGM: Matte Gold
- Premium Metal Finish for WMT Wire Management Tray - \$75 ea
- Premium Metal Finish for MTL10 Metal Feet - \$20 ea
- Premium Metal Finish for PCEB Concealed Floor Power Infeed Cover - \$35

Worksurface Height

- THL-42: Modify worksurface height to bar height - N/C

Wire Tray

- WMT: Wire metal tray. Mounts under top and comes standard in MFW White - \$210

[Click Here for Graded in Pricing](#)

2 Select Finish

Click to view finishes

WWP	WOW
PO01	WNO
PO02	WSO
PO03	WNF(Natural Oak on Flat Cut)
PO07	WSF(Salted Oak on Flat Cut)
PO08	
PO09	
WBW	
WSW	
WEC	

3 Select Feet Finish

Click to view edges

WWP	WOW
PO01	WNO
PO02	WSO
PO03	
PO07	
PO08	
PO09	
WBW	
WSW	
WEC	

4 Select Edge

Click to view details

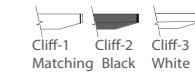
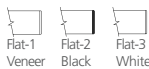

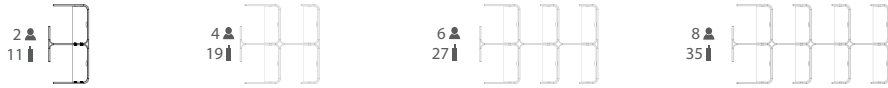

Number of Feet per Typical (MTL10 Option)

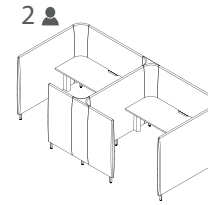

1 Select Model

Weight

w" x d" x h"
282 x 143 x 55
212 x 143 x 55
143 x 143 x 55
73 x 143 x 55

Standard Veneer Top
Upholstered Panels - COM\$

8	HNY282143HA562W	71486
6	HNY212143HA562W	54467
4	HNY143143HA562W	37448
2	HNY73143HA562W	20429

Premium Veneer Top
Upholstered Panels - COM\$

"P"	Option N/A
"P"	Option N/A
"P"	Option N/A
"P"	Option N/A

High Pressure Laminate Top
Upholstered Panels - COM\$

HNY282143HA562G	69878
HNY212143HA562G	53261
HNY143143HA562G	36644
HNY73143HA562G	20027

Thermally Fused Laminate Top
Upholstered Panels - COM\$

HNY282143HA562M	66822
HNY212143HA562M	50969
HNY143143HA562M	35116
HNY73143HA562M	19263

[Click here to view statement of line](#)

Product Features

- HNY6625WT163 Height Adjustable worksurfaces are included
- 5" Solid wood feet - oval shape
- 4 Power outlets with 1 telecom plate, see options below for telecom plate
- Ships KD
- Wire management tray attaches to worksurface top, standard in MFW White, see premium Metal Finish for options
- Hardwire infeed and jumpers are included in workstations
- T75 worksurface wire cutout is standard on all worksurfaces.(T75D: Delete cutout is optional)

[Click Here for Graded in Pricing](#)

2 Select Finish

Click to view finishes

WWP	WOW
PO01	WNO
PO02	WSO
PO03	WNF(Natural Oak on Flat Cut)
PO07	WSF(Salted Oak on Flat Cut)
PO08	WSF(Salted Oak on Flat Cut)
PO09	
WBW	
WSW	
WEC	

3 Select Feet Finish

Click to view edges

WWP	WOW
PO01	WNO
PO02	WSO
PO03	
PO07	
PO08	
PO09	
WBW	
WSW	
WEC	

4 Select Edge

Click to view details

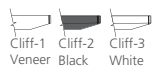

GEC	LW04
GNA +5%	LW05
GWL	LW06
LP01	
LF02	
LF03	
LN01	
LA02	
LW01	
LW02	

WWP	WOW
PO01	WNO
PO02	WSO
PO03	
PO07	
PO08	
PO09	
WBW	
WSW	
WEC	



MOC
MEC
MSW
MTW
MWL
MNA

WWP	WOW
PO01	WNO
PO02	WSO
PO03	
PO07	
PO08	
PO09	
WEC	
WBW	
WSW	



Options

Accessories

- K28: Articulating Keyboard w/ Mouse - \$390
- K31-SK: Center drawer w/ skirt - \$310
- K31: Center drawer w/o skirt - \$205

Concealed Floor Power Infeed Cover

- PCEB: White Metal Finish concealed floor power infeed cover - \$150

Delete Top and Wire Tray

- DHAT: Delete height adjustable top. Deduct \$3845 Veneer(W), \$3644 High Pressure Laminate(G), \$3262 Thermally Fused Laminate(M) per top

Metal Feet

- MTL10: Replace solid wood feet with metal feet, standard MFW White - \$55 ea

Premium Metal Finish

- Specify premium Metal Finish. MFMB: Matte Black, MFS: Silver, MFSS: Salmon Sienna, MFSA: Surfin Aquavert, MFPS: Pistachio, MFOS: Oyster, MFNA: Navy, MFOL: Olive, MFGB: Grey Beige MFGG: Graphite Gray, MFG: Gray, MFGM: Matte Gold
- Premium Metal Finish for WMT Wire Management Tray - \$75 ea
- Premium Metal Finish for MTL10 Metal Feet - \$20 ea
- Premium Metal Finish for PCEB Concealed Floor Power Infeed Cover - \$35

Telecom Plates

- Each power unit has 1 plate. All telecom connectors sold separately.



Number of Feet per Typical (MTL10 Option)

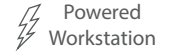

1 Select Model

Weight

w" x d" x h"	Standard Veneer Top Upholstered Panels - COM\$
282 x 143 x 55	8 HNY282143FP562W 53006
212 x 143 x 55	6 HNY212143FP562W 40607
143 x 143 x 55	4 HNY143143FP562W 28208
73 x 143 x 55	2 HNY73143FP562W 15809

Premium Veneer Top Upholstered Panels - COM\$

"P" Option N/A
"P" Option N/A
"P" Option N/A
"P" Option N/A

High Pressure Laminate Top Upholstered Panels - COM\$

HNY282143FP562G	51406
HNY212143FP562G	39407
HNY143143FP562G	27408
HNY73143FP562G	15409

Thermally Fused Laminate Top Upholstered Panels - COM\$

HNY282143FP562M	48350
HNY212143FP562M	37115
HNY143143FP562M	25880
HNY73143FP562M	14645

[Click here to view statement of line](#)

Product Features

- HNY6625WT162 Fixed Desk Height Worksurfaces are included
- 5" Solid wood feet - oval shape
- 4 Power outlets with 1 telecom plate, see options below for telecom plate
- Ships KD
- Wire management tray attaches to worksurface top, standard in MFW White, see premium Metal Finish for options
- Hardwire infeed and jumpers are included in workstations
- T75 worksurface wire cutout is standard on all worksurfaces.(T75D: Delete cutout is optional)

[Click Here for Graded in Pricing](#)

2 Select Finish

Click to view finishes

WWP	WOW
PO01	WNO
PO02	WSO
PO03	WNF(Natural Oak on Flat Cut)
PO07	WSF(Salted Oak on Flat Cut)
PO08	WSF(Salted Oak on Flat Cut)
PO09	WSF(Salted Oak on Flat Cut)
WBW	
WSW	
WEC	

3 Select Feet Finish

Click to view edges

WWP	WOW
PO01	WNO
PO02	WSO
PO03	
PO07	
PO08	
PO09	
WBW	
WSW	
WEC	

4 Select Edge

Click to view details

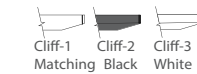
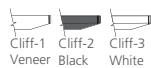

WWP	WOW
PO01	WNO
PO02	WSO
PO03	
PO07	
PO08	
PO09	
WEC	
WBW	
WSW	

Options

Accessories

- K28: Articulating Keyboard w/ Mouse - \$390
- K31-SK: Center drawer w/ skirt - \$310
- K31: Center drawer w/o skirt - \$205

Concealed Floor Power Infeed Cover

- PCEB: White Metal Finish concealed floor power infeed cover - \$150

Delete Top and Wire Tray

- DFP: Delete fixed top. Deduct \$1535 Veneer (W), \$1335 High Pressure Laminate (G), \$953 Thermally Fused Laminate (M) per top

Metal Feet

- MTL10: Replace solid wood feet with metal feet, standard MFW White - \$55 ea

Premium Metal Finish

- Specify premium Metal Finish. MFMB: Matte Black, MFS: Silver, MFSS: Salmon Sienna, MFSA: Surfing Aquavert, MFPS: Pistachio, MFOS: Oyster, MFNA: Navy, MFOL: Olive, MFGB: Grey Beige MFGG: Graphite Gray, MFG: Gray, MFGM: Matte Gold
- Premium Metal Finish for WMT Wire Management Tray - \$75 ea
- Premium Metal Finish for MTL10 Metal Feet - \$20 ea
- Premium Metal Finish for PCEB Concealed Floor Power Infeed Cover - \$35

Telecom Plates

- Each power unit has 1 plate. All telecom connectors sold separately.
- RJ45 (1) - \$55, RJ45 (2) - \$110, RJ45 (3) - \$165, USB (1) - \$70, USB (2) - \$140, RJ45/USB - \$125, RJ45/HDMI - \$210, HDMI/USB - \$205
- THL-42: Modify worksurface height to bar height - N/C



Number of Feet per Typical (MTL10 Option)

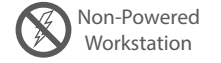

1 Select Model

Weight

w" x d" x h"	Standard Veneer Top Upholstered Panels - COM\$	Premium Veneer Top Upholstered Panels - COM\$	High Pressure Laminate Top Upholstered Panels - COM\$	Thermally Fused Laminate Top Upholstered Panels - COM\$
282 x 143 x 55	8 HNY282143FT562W 46870	"P" Option N/A	HNY282143FT562G 45270	HNY282143FT562M 42214
212 x 143 x 55	6 HNY212143FT562W 35985	"P" Option N/A	HNY212143FT562G 34785	HNY212143FT562M 32493
143 x 143 x 55	4 HNY143143FT562W 25100	"P" Option N/A	HNY143143FT562G 24300	HNY143143FT562M 22772
73 x 143 x 55	2 HNY73143FT562W 14215	"P" Option N/A	HNY73143FT562G 13815	HNY73143FT562M 13051

[Click Here for Graded in Pricing](#)

2 Select Finish

Click to view finishes

WWP	WOW
PO01	WNO
PO02	WSO
PO03	WNF(Natural Oak on Flat Cut)
PO07	WSF(Salted Oak on Flat Cut)
PO08	WSF(Salted Oak on Flat Cut)
PO09	WSF(Salted Oak on Flat Cut)
WBW	
WSW	
WEC	

3 Select Feet Finish

Click to view edges

WWP	WOW
PO01	WNO
PO02	WSO
PO03	
PO07	
PO08	
PO09	
WBW	
WSW	
WEC	

4 Select Edge

Click to view details



GEC	LW04
GNA +5%	LW05
GWL	LW06
LP01	
LF02	
LF03	
LN01	
LA02	
LW01	
LW02	

WWP	WOW
PO01	WNO
PO02	WSO
PO03	
PO07	
PO08	
PO09	
WBW	
WSW	
WEC	



MOC
MEC
MSW
MTW
MWL
MNA

WWP	WOW
PO01	WNO
PO02	WSO
PO03	
PO07	
PO08	
PO09	
WEC	
WBW	
WSW	



[Click here to view statement of line](#)

Product Features

- HNY6625WT162 Fixed Desk Height Worksurfaces are included
- 5" Solid wood feet - oval shape
- Ships KD
- T75 worksurface wire cutout is standard on all worksurfaces.(T75D: Delete cutout is optional)

Options

Accessories

- K28: Articulating Keyboard w/ Mouse - \$390
- K31-SK: Center drawer w/ skirt - \$310
- K31: Center drawer w/o skirt - \$205

Delete Top

- DFT: Delete fixed top. Deduct \$1325 Veneer(W), \$1125 High Pressure Laminate (G), \$743 Thermally Fused Laminate (M) per top

Metal Feet

- MTL10: Replace solid wood feet with metal feet, standard MFW White - \$55 ea

Premium Metal Finish

- Specify premium Metal Finish. MFMB: Matte Black, MFS: Silver, MFSS: Salmon Sienna, MFSA: Surfing Aquavert, MFPS: Pistachio, MFOS: Oyster, MFNA: Navy, MFOL: Olive, MFGB: Grey Beige MFGG: Graphite Gray, MFG: Gray, MFGM: Matte Gold
- Premium Metal Finish for WMT Wire Management Tray - \$75 ea
- Premium Metal Finish for MTL10 Metal Feet - \$20 ea
- Premium Metal Finish for PCEB Concealed Floor Power Infeed Cover - \$35

Worksurface Height

- THL-42: Modify worksurface height to bar height - N/C

Wire Tray

- WMT: Wire metal tray. Mounts under top and comes standard in MFW White - \$210



Number of Feet per Typical (MTL10 Option)

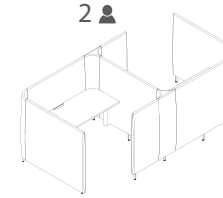

1 Select Model

Weight

w" x d" x h"
143 x 143 x 55
73 x 143 x 55

	Standard Veneer Top Upholstered Panels - COM\$
4	HNY143143HA564W 35732
2	HNY73143HA564W 20539

	Premium Veneer Top Upholstered Panels - COM\$
	"P" Option N/A
	"P" Option N/A

	High Pressure Laminate Top Upholstered Panels - COM\$
	HNY143143HA564G 34928
	HNY73143HA564G 20137

	Thermally Fused Laminate Top Upholstered Panels - COM\$
	HNY143143HA564M 33400
	HNY73143HA564M 19373

[Click here to view statement of line](#)

Product Features

- HNY6625WT163 Height Adjustable worksurfaces are included
- 5" Solid wood feet - oval shape
- 4 Power outlets with 1 telecom plate, see options below for telecom plate
- Ships KD
- Wire management tray attaches to worksurface top, standard in MFW White, see premium Metal Finish for options
- Hardwire infeed and jumpers are included in workstations
- T75 worksurface wire cutout is standard on all worksurfaces.(T75D: Delete cutout is optional)

[Click Here for Graded in Pricing](#)

2 Select Finish

Click to view finishes

WWP	WOW
PO01	WNO
PO02	WSO
PO03	WNF(Natural Oak on Flat Cut)
PO07	WSF(Salted Oak on Flat Cut)
PO08	
PO09	
WBW	
WSW	
WEC	

GEC	LW04
GNA +5%	LW05
GWL	LW06
LP01	
LF02	
LF03	
LN01	
LA02	
LW01	
LW02	

MOC
MEC
MSW
MTW
MWL
MNA

3 Select Feet Finish

Click to view edges

WWP	WOW
PO01	WNO
PO02	WSO
PO03	
PO07	
PO08	
PO09	
WBW	
WSW	
WEC	

WWP	WOW
PO01	WNO
PO02	WSO
PO03	
PO07	
PO08	
PO09	
WBW	
WSW	
WEC	

WWP	WOW
PO01	WNO
PO02	WSO
PO03	
PO07	
PO08	
PO09	
WEC	
WBW	
WSW	

4 Select Edge

Click to view details



Options

Accessories

- K28: Articulating Keyboard w/ Mouse - \$390
- K31-SK: Center drawer w/ skirt - \$310
- K31: Center drawer w/o skirt - \$205

Concealed Floor Power Infeed Cover

- PCEB: White Metal Finish concealed floor power infeed cover - \$150

Delete Top and Wire Tray

- DHAT: Delete height adjustable top. Deduct \$3845 Veneer(W), \$3644 High Pressure Laminate(G), \$3262 Thermally Fused Laminate(M) per top

Metal Feet

- MTL10: Replace solid wood feet with metal feet, standard MFW White - \$55 ea

Premium Metal Finish

- Specify premium Metal Finish. MFMB: Matte Black, MFS: Silver, MFSS: Salmon Sienna, MFSA: Surfing Aquavert, MFPS: Pistachio, MFOS: Oyster, MFNA: Navy, MFOL: Olive, MFGB: Grey Beige MFGG: Graphite Gray, MFG: Gray, MFGM: Matte Gold
- Premium Metal Finish for WMT Wire Management Tray - \$75 ea
- Premium Metal Finish for MTL10 Metal Feet - \$20 ea
- Premium Metal Finish for PCEB Concealed Floor Power Infeed Cover - \$35

Telecom Plates

- Each power unit has 1 plate. All telecom connectors sold separately.

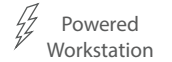
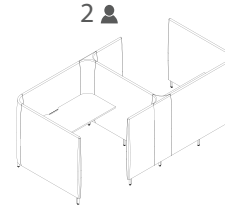

Number of Feet per Typical (MTL10 Option)

1 Select Model

Weight

Standard Veneer Top Upholstered Panels - COM\$	
4 HNY143143FP564W	26492
2 HNY73143FP564W	15919

Premium Veneer Top Upholstered Panels - COM\$	
"P" Option N/A	
"P" Option N/A	

High Pressure Laminate Top Upholstered Panels - COM\$	
HNY143143FP564G	25692
HNY73143FP564G	15519

Thermally Fused Laminate Top Upholstered Panels - COM\$	
HNY143143FP564M	24164
HNY73143FP564M	14755

[Click here to view statement of line](#)

Product Features

- HNY6625WT162 Fixed Desk Height Worksurfaces are included
- 5" Solid wood feet - oval shape
- 4 Power outlets with 1 telecom plate, see options below for telecom plate
- Ships KD
- Wire management tray attaches to worksurface top, standard in MFW White, see premium Metal Finish for options
- Hardwire infeed and jumpers are included in workstations
- T75 worksurface wire cutout is standard on all worksurfaces.(T75D: Delete cutout is optional)

[Click Here for Graded in Pricing](#)

2 Select Finish

Click to view finishes

WWP	WOW
PO01	WNO
PO02	WSO
PO03	WNF(Natural Oak on Flat Cut)
PO07	WSF(Salted Oak on Flat Cut)
PO08	
PO09	
WBW	
WSW	
WEC	

GEC	LW04
GNA +5%	LW05
GWL	LW06
LP01	
LF02	
LF03	
LN01	
LA02	
LW01	
LW02	

MOC
MEC
MSW
MTW
MWL
MNA

3 Select Feet Finish

Click to view edges

WWP	WOW
PO01	WNO
PO02	WSO
PO03	
PO07	
PO08	
PO09	
WBW	
WSW	
WEC	

WWP	WOW
PO01	WNO
PO02	WSO
PO03	
PO07	
PO08	
PO09	
WBW	
WSW	
WEC	

WWP	WOW
PO01	WNO
PO02	WSO
PO03	
PO07	
PO08	
PO09	
WEC	
WBW	
WSW	

4 Select Edge

Click to view details



Options

Accessories

- K28: Articulating Keyboard w/ Mouse - \$390
- K31-SK: Center drawer w/ skirt - \$310
- K31: Center drawer w/o skirt - \$205

Concealed Floor Power Infeed Cover

- PCEB: White Metal Finish concealed floor power infeed cover - \$150

Delete Top and Wire Tray

- DFP: Delete fixed top. Deduct \$1535 Veneer (W), \$1335 High Pressure Laminate (G), \$953 Thermally Fused Laminate (M) per top

Metal Feet

- MTL10: Replace solid wood feet with metal feet, standard MFW White - \$55 ea

Premium Metal Finish

- Specify premium Metal Finish. MFMB: Matte Black, MFS: Silver, MFSS: Salmon Sienna, MFSA: SurfIn Aquavert, MFPS: Pistachio, MFOS: Oyster, MFNA: Navy, MFOL: Olive, MFGB: Grey Beige MFGG: Graphite Gray, MFG: Gray, MFGM: Matte Gold
- Premium Metal Finish for WMT Wire Management Tray - \$75 ea
- Premium Metal Finish for MTL10 Metal Feet - \$20 ea
- Premium Metal Finish for PCEB Concealed Floor Power Infeed Cover - \$35

Telecom Plates

- Each power unit has 1 plate. All telecom connectors sold separately.
- RJ45 (1) - \$55, RJ45 (2) - \$110, RJ45 (3) - \$165, USB (1) - \$70, USB (2) - \$140, RJ45/USB - \$125, RJ45/HDMI - \$210, HDMI/USB - \$205
- THL-42: Modify worksurface height to bar height - N/C

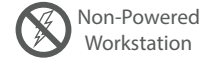
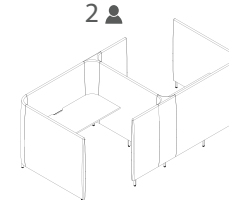

Number of Feet per Typical (MTL10 Option)

1 Select Model

Weight

w" x d" x h"	Standard Veneer Top Upholstered Panels - COM\$	Premium Veneer Top Upholstered Panels - COM\$
143 x 143 x 55	4 HNY143143FT564W 23322	"P" Option N/A
73 x 143 x 55	2 HNY73143FT564W 14215	"P" Option N/A

[Click Here for Graded in Pricing](#)

2 Select Finish

Click to view finishes

WWP	WOW
PO01	WNO
PO02	WSO
PO03	WNF(Natural Oak on Flat Cut)
PO07	WSF(Salted Oak on Flat Cut)
PO08	
PO09	
WBW	
WSW	
WEC	

3 Select Feet Finish

Click to view edges

WWP	WOW
PO01	WNO
PO02	WSO
PO03	
PO07	
PO08	
PO09	
WBW	
WSW	
WEC	

4 Select Edge

Click to view details

High Pressure Laminate Top Upholstered Panels - COM\$

HNY143143FT564G	22522
HNY73143FT564G	13815

GEC	LW04
GNA +5%	LW05
GWL	LW06
LP01	
LF02	
LF03	
LN01	
LA02	
LW01	
LW02	

WWP	WOW
PO01	WNO
PO02	WSO
PO03	
PO07	
PO08	
PO09	
WBW	
WSW	
WEC	



Thermally Fused Laminate Top Upholstered Panels - COM\$

HNY143143FT564M	20994
HNY73143FT564M	13051

MOC
MEC
MSW
MTW
MWL
MNA

WWP	WOW
PO01	WNO
PO02	WSO
PO03	
PO07	
PO08	
PO09	
WEC	
WBW	
WSW	



[Click here to view statement of line](#)

Product Features

- HNY6625WT162 Fixed Desk Height Worksurfaces are included
- 5" Solid wood feet - oval shape
- Ships KD
- T75 worksurface wire cutout is standard on all worksurfaces.(T75D: Delete cutout is optional)

Options

Accessories

- K28: Articulating Keyboard w/ Mouse - \$390
- K31-SK: Center drawer w/ skirt - \$310
- K31: Center drawer w/o skirt - \$205

Delete Top

- DFT: Delete fixed top. Deduct \$1325 Veneer(W), \$1125 High Pressure Laminate (G), \$743 Thermally Fused Laminate (M) per top

Metal Feet

- MTL10: Replace solid wood feet with metal feet, standard MFW White - \$55 ea

Premium Metal Finish

- Specify premium Metal Finish. MFMB: Matte Black, MFS: Silver, MFSS: Salmon Sienna, MFSA: Surfing Aquavert, MFPS: Pistachio, MFOS: Oyster, MFNA: Navy, MFOL: Olive, MFGB: Grey Beige MFGG: Graphite Gray, MFG: Gray, MFGM: Matte Gold
- Premium Metal Finish for WMT Wire Management Tray - \$75 ea
- Premium Metal Finish for MTL10 Metal Feet - \$20 ea
- Premium Metal Finish for PCEB Concealed Floor Power Infeed Cover - \$35

Worksurface Height

- THL42: Modify worksurface height to bar height - N/C

Wire Tray

- WMT: Wire metal tray. Mounts under top and comes standard in MFW White - \$210

Honey

90° Starter Panel
Flat End

[Click here to view statement of line](#)



1 Model HNY2455SP908

w" x d" x h"
24 x 3 x 55

COM	COL	1	2	3	4	5	6	7	8	9	10	11/L1	12	13/L2
959	N/A	1024	1056	1088	1120	1152	1184	1216	1248	1280	1312	1344	1376	1440

Upholstery Requirements
Fabric yds: 1.75 Leather Sq. Ft.:N/A
Carton Weight:15

Product Features

- 5" Solid wood feet - oval shape

Notes

- To configure workstations, customer is required to send drawing

Options

Metal Feet

- MTL10: Replace solid wood feet with metal feet, standard in MFW White - \$55 ea

Premium Metal Finish

- Specify premium Metal Finish. MFMB: Matte Black, MFS: Silver, MFSS: Salmon Sienna, MFSA: Surfing Aquavert, MFPS: Pistachio, MFOS: Oyster, MFNA: Navy, MFOL: Olive, MFGB: Grey Beige MFGG: Graphite Gray, MFG: Gray, MFGM: Matte Gold
- Premium Metal Finish for MTL10: Metal feet \$20 per foot

2 Select Finish

[Click to view finishes](#)

- WWP Designer White
- PO01 Olive on Oak
- PO02 Aquavert on Oak
- PO03 Mushroom on Oak
- PO07 Pebble on Oak
- PO08 Vapour on Oak
- PO09 Verde on Oak
- WEC Ebony
- WNO Natural Oak on Oak
- WSO Salted Oak on Oak
- WBW Henna Walnut on Walnut
- WSW Smokey Walnut on Walnut
- WOW Clear Walnut on Walnut

3 Combination Fabrics

[Click to view finishes](#)

Combination
Fabric Option
Not Available

Honey

90° Starter Panel
Flat End

[Click here to view statement of line](#)

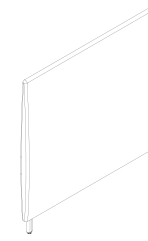

1 Model HNY5555SP909

w" x d" x h"
54 x 3 x 55

COM	COL	1	2	3	4	5	6	7	8	9	10	11/L1	12	13/L2
1390	N/A	1520	1584	1648	1712	1776	1840	1904	1968	2032	2096	2160	2224	2352

Upholstery Requirements
Fabric yds: 3.5 Leather Sq. Ft.:N/A
Carton Weight:35

Product Features

- 5" Solid wood feet - oval shape

Notes

- To configure workstations, customer is required to send drawing

Options

Metal Feet

- MTL10: Replace solid wood feet with metal feet, standard in MFW White - \$55 ea

Premium Metal Finish

- Specify premium Metal Finish. MFMB: Matte Black, MFS: Silver, MFSS: Salmon Sienna, MFSA: Surfing Aquavert, MFPS: Pistachio, MFOS: Oyster, MFNA: Navy, MFOL: Olive, MFGB: Grey Beige MFGG: Graphite Gray, MFG: Gray, MFGM: Matte Gold
- Premium Metal Finish for MTL10: Metal feet \$20 per foot

2 Select Finish

[Click to view finishes](#)

- WWP Designer White
- PO01 Olive on Oak
- PO02 Aquavert on Oak
- PO03 Mushroom on Oak
- PO07 Pebble on Oak
- PO08 Vapour on Oak
- PO09 Verde on Oak
- WEC Ebony
- WNO Natural Oak on Oak
- WSO Salted Oak on Oak
- WBW Henna Walnut on Walnut
- WSW Smokey Walnut on Walnut
- WOW Clear Walnut on Walnut

3 Combination Fabrics

[Click to view finishes](#)

Combination
Fabric Option
Not Available

Honey

90° Corner Panel Connector
Two Way Corner Connector

[Click here to view statement of line](#)



1 Model HNY1055CP905

w" x d" x h"
9.5 x 9.5 x 55

COM	COL	1	2	3	4	5	6	7	8	9	10	11/L1	12	13/L2
594	N/A	631	649	667	685	703	721	739	757	775	793	811	829	865

Upholstery Requirements
Fabric yds: 1 Leather Sq. Ft.:N/A
Carton Weight:10

Product Features

- 5" Solid wood feet - oval shape

Notes

- To configure workstations, customer is required to send drawing

Options

Metal Feet

- MTL10: Replace solid wood feet with metal feet, standard in MFW White - \$55 ea

Premium Metal Finish

- Specify premium Metal Finish. MFMB: Matte Black, MFS: Silver, MFSS: Salmon Sienna, MFSA: Surfing Aquavert, MFPS: Pistachio, MFOS: Oyster, MFNA: Navy, MFOL: Olive, MFGB: Grey Beige MFGG: Graphite Gray, MFG: Gray, MFGM: Matte Gold
- Premium Metal Finish for MTL10: Metal feet \$20 per foot

2 Select Finish

[Click to view finishes](#)

- WWP Designer White
- PO01 Olive on Oak
- PO02 Aquavert on Oak
- PO03 Mushroom on Oak
- PO07 Pebble on Oak
- PO08 Vapour on Oak
- PO09 Verde on Oak
- WEC Ebony
- WNO Natural Oak on Oak
- WSO Salted Oak on Oak
- WBW Henna Walnut on Walnut
- WSW Smokey Walnut on Walnut
- WOW Clear Walnut on Walnut

3 Combination Fabrics

[Click to view finishes](#)

Combination
Fabric Option
Not Available

Honey

90° Corner Panel Connector
 Three Way Corner Connector

[Click here to view statement of line](#)



1 Model HNY1255CP906

w" x d" x h"
 12 x 9.5 x 55

COM	COL	1	2	3	4	5	6	7	8	9	10	11/L1	12	13/L2
819	N/A	893	929	965	1001	1037	1073	1109	1145	1181	1217	1253	1289	1361

Upholstery Requirements
 Fabric yds: 2 Leather Sq. Ft.:N/A
 Carton Weight:15

Product Features

- 5" Solid wood feet - oval shape

Notes

- To configure workstations, customer is required to send drawing

Options

Metal Feet

- MTL10: Replace solid wood feet with metal feet, standard in MFW White - \$55 ea

Premium Metal Finish

- Specify premium Metal Finish. MFMB: Matte Black, MFS: Silver, MFSS: Salmon Sienna, MFSA: Surfing Aquavert, MFPS: Pistachio, MFOS: Oyster, MFNA: Navy, MFOL: Olive, MFGB: Grey Beige MFGG: Graphite Gray, MFG: Gray, MFGM: Matte Gold
 - Premium Metal Finish for MTL10: Metal feet \$20 per foot

2 Select Finish

[Click to view finishes](#)

- WWP Designer White
- PO01 Olive on Oak
- PO02 Aquavert on Oak
- PO03 Mushroom on Oak
- PO07 Pebble on Oak
- PO08 Vapour on Oak
- PO09 Verde on Oak
- WEC Ebony
- WNO Natural Oak on Oak
- WSO Salted Oak on Oak
- WBW Henna Walnut on Walnut
- WSW Smokey Walnut on Walnut
- WOW Clear Walnut on Walnut

3 Combination Fabrics

[Click to view finishes](#)

Combination
 Fabric Option
 Not Available

Honey

90° Corner Panel Connector
 Four Way Corner Connector

[Click here to view statement of line](#)



1 Model HNY1655CP907

w" x d" x h"
 16 x 16 x 55

COM	COL	1	2	3	4	5	6	7	8	9	10	11/L1	12	13/L2
1087	N/A	1171	1212	1253	1294	1335	1376	1417	1458	1499	1540	1581	1622	1704

Upholstery Requirements
 Fabric yds: 2.25 Leather Sq. Ft.:N/A
 Carton Weight:20

Product Features

- 5" Solid wood feet - oval shape

Notes

- To configure workstations, customer is required to send drawing

Options

Metal Feet

- MTL10: Replace solid wood feet with metal feet, standard in MFW White - \$55 ea

Premium Metal Finish

- Specify premium Metal Finish. MFMB: Matte Black, MFS: Silver, MFSS: Salmon Sienna, MFSA: Surfing Aquavert, MFPS: Pistachio, MFOS: Oyster, MFNA: Navy, MFOL: Olive, MFGB: Grey Beige MFGG: Graphite Gray, MFG: Gray, MFGM: Matte Gold
 - Premium Metal Finish for MTL10: Metal feet \$20 per foot

2 Select Finish

[Click to view finishes](#)

- WWP Designer White
- PO01 Olive on Oak
- PO02 Aquavert on Oak
- PO03 Mushroom on Oak
- PO07 Pebble on Oak
- PO08 Vapour on Oak
- PO09 Verde on Oak
- WEC Ebony
- WNO Natural Oak on Oak
- WSO Salted Oak on Oak
- WBW Henna Walnut on Walnut
- WSW Smokey Walnut on Walnut
- WOW Clear Walnut on Walnut

3 Combination Fabrics

[Click to view finishes](#)

Combination
 Fabric Option
 Not Available

Honey

90° Adder Panel
No Power Access

[Click here to view statement of line](#)

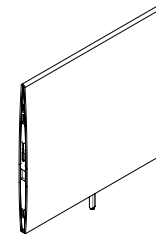

1 Model HNY5455AP904

w" x d" x h"
53.5 x 3 x 55

COM	COL	1	2	3	4	5	6	7	8	9	10	11/L1	12	13/L2
1347	N/A	1477	1541	1605	1669	1733	1797	1861	1925	1989	2053	2117	2181	2309

Upholstery Requirements
Fabric yds: 3.5 Leather Sq. Ft.:N/A
Carton Weight:35

Product Features

- 5" Solid wood feet - oval shape

Notes

- To configure workstations, customer is required to send drawing
- Panel overall height is 55" with feet. Panel overall height without feet is 50"

Options

Metal Feet

- MTL10: Replace solid wood feet with metal feet, standard in MFW White - \$55 ea

Premium Metal Finish

- Specify premium Metal Finish. MFMB: Matte Black, MFS: Silver, MFSS: Salmon Sienna, MFSA: Surfin Aquavert, MFPS: Pistachio, MFOS: Oyster, MFNA: Navy, MFOL: Olive, MFGB: Grey Beige MFGG: Graphite Gray, MFG: Gray, MFGM: Matte Gold
- Premium Metal Finish for MTL10: Metal feet \$20 per foot

2 Select Finish

[Click to view finishes](#)

- WWP Designer White
- PO01 Olive on Oak
- PO02 Aquavert on Oak
- PO03 Mushroom on Oak
- PO07 Pebble on Oak
- PO08 Vapour on Oak
- PO09 Verde on Oak
- WEC Ebony
- WNO Natural Oak on Oak
- WSO Salted Oak on Oak
- WBW Henna Walnut on Walnut
- WSW Smokey Walnut on Walnut
- WOW Clear Walnut on Walnut

3 Combination Fabrics

[Click to view finishes](#)

Combination
Fabric Option
Not Available

Honey

90° Adder Panel
Single Sided Access

[Click here to view statement of line](#)

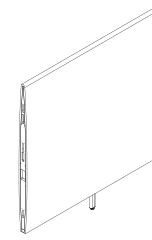

1 Model HNY5455AP910

w" x d" x h"
53.5 x 3 x 55

COM	COL	1	2	3	4	5	6	7	8	9	10	11/L1	12	13/L2
1395	N/A	1525	1589	1653	1717	1781	1845	1909	1973	2037	2101	2165	2229	2357

Upholstery Requirements
Fabric yds: 3.5 Leather Sq. Ft.:N/A
Carton Weight:35

2 Select Finish

[Click to view finishes](#)

- WWP Designer White
- PO01 Olive on Oak
- PO02 Aquavert on Oak
- PO03 Mushroom on Oak
- PO07 Pebble on Oak
- PO08 Vapour on Oak
- PO09 Verde on Oak
- WEC Ebony
- WNO Natural Oak on Oak
- WSO Salted Oak on Oak
- WBW Henna Walnut on Walnut
- WSW Smokey Walnut on Walnut
- WOW Clear Walnut on Walnut

3 Combination Fabrics

[Click to view finishes](#)

Combination
Fabric Option
Not Available

Product Features

- 5" Solid wood feet - oval shape
- Panel features access panel for wire management

Notes

- To configure workstations, customer is required to send drawing
- Panel overall height is 55" with feet. Panel overall height without feet is 50"
- Removable panel allows wire access for cable management

Options

Metal Feet

- MTL10: Replace solid wood feet with metal feet, standard in MFW White - \$55 ea

Premium Metal Finish

- Specify premium Metal Finish. MFMB: Matte Black, MFS: Silver, MFSS: Salmon Sienna, MFSA: Surfin Aquavert, MFPS: Pistachio, MFOS: Oyster, MFNA: Navy, MFOL: Olive, MFGB: Grey Beige MFGG: Graphite Gray, MFG: Gray, MFGM: Matte Gold
- Premium Metal Finish for MTL10: Metal feet \$20 per foot

Honey

90° Single Sided Power Panel
Power Panel

[Click here to view statement of line](#)

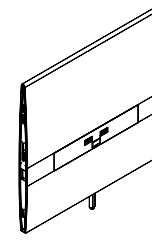

1 Model HNY5455PP911

w" x d" x h"
53.5 x 3 x 55

COM	COL	1	2	3	4	5	6	7	8	9	10	11/L1	12	13/L2
1654	N/A	1784	1848	1912	1976	2040	2104	2168	2232	2296	2360	2424	2488	2616

Upholstery Requirements
Fabric yds: 3.5 Leather Sq. Ft.:N/A
Carton Weight:35

2 Select Finish

[Click to view finishes](#)

- WWP Designer White
- PO01 Olive on Oak
- PO02 Aquavert on Oak
- PO03 Mushroom on Oak
- PO07 Pebble on Oak
- PO08 Vapour on Oak
- PO09 Verde on Oak
- WEC Ebony
- WNO Natural Oak on Oak
- WSO Salted Oak on Oak
- WBW Henna Walnut on Walnut
- WSW Smokey Walnut on Walnut
- WOW Clear Walnut on Walnut

3 Combination Fabrics

[Click to view finishes](#)

Combination
Fabric Option
Not Available

Product Features

- 5" Solid wood feet - oval shape
- 4 power outlets with 1 telecom plate, see options below for telecom plate

Notes

- To configure workstations, customer is required to send drawing
- Panel overall height is 55" with feet. Panel overall height without feet is 50"
- Jumper(s) or hardwired infeed must be selected to power workstations. See options below.

Options

Metal Feet

- MTL10: Replace solid wood feet with metal feet, standard in MFW White - \$55 ea

Jumper(s) and Infeed

- Specify Jumper or Infeed to power workstations
- JC70: 70" Length Jumper-Passes through corner post connecting 2 panels-\$180
- JC140: 140" Length Jumper-passes through one 54" added panel connecting 3 panels-\$270
- JC210: 210" Length Jumper-passes through (2) 53" added panels connecting 4 panels-\$360
- JC280: 280" Length Jumper- passes through (3) 53" added panels connecting 5 panels-\$450
- JC115: 115" Length Jumper-passes through one 34" adder panel connecting (3) panels-\$240
- CPF72: 72" corded power feed -\$275
- HPF192: 192" hardwired power feed -\$350

Telecom Plates

- Each power unit has 1 plate. All telecom connectors sold separately.
- RJ45 (1) - \$55, RJ45 (2) - \$110, RJ45 (3) - \$165, USB (1) - \$70, USB (2) - \$140, RJ45/USB - \$125, RJ45/HDMI - \$210, HDMI/USB - \$205

Honey

90° Double Sided Power Panel
Power Panel

[Click here to view statement of line](#)

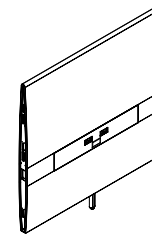

1 Model HNY5455PP912

w" x d" x h"
53.5 x 3 x 55

COM	COL	1	2	3	4	5	6	7	8	9	10	11/L1	12	13/L2
1463	N/A	1593	1657	1721	1785	1849	1913	1977	2041	2105	2169	2233	2297	2425

Upholstery Requirements
Fabric yds: 3.5 Leather Sq. Ft.:N/A
Carton Weight:35

2 Select Finish

[Click to view finishes](#)

- WWP Designer White
- PO01 Olive on Oak
- PO02 Aquavert on Oak
- PO03 Mushroom on Oak
- PO07 Pebble on Oak
- PO08 Vapour on Oak
- PO09 Verde on Oak
- WEC Ebony
- WNO Natural Oak on Oak
- WSO Salted Oak on Oak
- WBW Henna Walnut on Walnut
- WSW Smokey Walnut on Walnut
- WOW Clear Walnut on Walnut

3 Combination Fabrics

[Click to view finishes](#)

Combination
Fabric Option
Not Available

Product Features

- 5" Solid wood feet - oval shape
- Double sided power panel, each panel side features 4 power outlets with 1 telecom plate. See options below for telecom plate

Notes

- To configure workstations, customer is required to send drawing
- Panel overall height is 55" with feet. Panel overall height without feet is 50"
- Jumper(s) or hardwired infeed must be selected to power workstations. See options below.

Options

Metal Feet

- MTL10: Replace solid wood feet with metal feet, standard in MFW White - \$55 ea

Jumper(s) and Infeed

- Specify Jumper or Infeed to power workstations
- JC70:70" Length Jumper-Passes through corner post connecting 2 panels-\$180
- JC140: 140" Length Jumper-passes through one 54" added panel connecting 3 panels-\$270
- JC210: 210" Length Jumper-passes through (2) 53" added panels connecting 4 panels-\$360
- JC280: 280" Length Jumper- passes through (3) 53" added panels connecting 5 panels-\$450
- JC115: 115" Length Jumper-passes through one 34" adder panel connecting (3) panels-\$240
- CPF72: 72" corded power feed -\$275
- HPP192: 192" hardwired power feed -\$350

Telecom Plates

- Each power unit has 1 plate. All telecom connectors sold separately.
- RJ45 (1) - \$55, RJ45 (2) - \$110, RJ45 (3) - \$165, USB (1) - \$70, USB (2) - \$140, RJ45/USB - \$125, RJ45/HDMI - \$210, HDMI/USB - \$205



Panels
not included

[Click here to view statement of line](#)

Product Features

- 1" Thick top
- Bar height 42", desk height 29"
- Ships KD
- T75 worksurface wire cutout is standard on all worksurfaces.(T75D: Delete cutout is optional)

Notes

- PANELS NOT INCLUDED

Options

Wire Tray / Premium Metal Finish

- WMT: Wire metal tray. Mounts under top and comes standard in MFW White - \$210

Premium Metal Finish

- Specify premium Metal Finish. MFMB: Matte Black, MFS: Silver, MFSS: Salmon Sienna, MFSA: Surfing Aquavert, MFPS: Pistachio, MFOS: Oyster, MFNA: Navy, MFOL: Olive, MFGB: Grey Beige MFGG: Graphite Gray, MFG: Gray, MFGM: Matte Gold
- Premium Metal Finish for WMT wire management tray - \$75 ea

1 Select Model

Weight

Standard Veneer Top

Premium Veneer Top

High Pressure Laminate Top

Thermally Fused Laminate Top

w" x d" x h"	Weight	Standard Veneer Top	Premium Veneer Top
Bar Height 42"			
67 x 26 x 1	55	HNY6726WT160W 1325	"P" Option N/A
47 x 26 x 1	50	HNY4726WT160W 1155	"P" Option N/A
Desk Height 29"			
67 x 26 x 1	55	HNY6726WT162W 1325	"P" Option N/A
47 x 26 x 1	50	HNY4726WT162W 1259	"P" Option N/A

"P" Option N/A
"P" Option N/A

HNY6726WT160G 1125
HNY4726WT160W 1082

HNY6726WT160M 743
HNY4726WT160M 710

"P" Option N/A
"P" Option N/A

HNY6726WT162G 1125
HNY4726WT162G 1082

HNY6726WT162M 743
HNY4726WT162M 710

[Click Here for Graded in Pricing](#)

2 Select Finish

Click to view finishes

WWP	WOW
PO01	WNO
PO02	WSO
PO03	WNF(Natural Oak on Flat Cut)
PO07	WSF(Salted Oak on Flat Cut)
PO08	
PO09	
WBW	
WSW	
WEC	

GEC LW05
GWL LW06
LP01
LF02
LF03
LN01
LA02
LW01
LW02
LW04

MOC
MEC
MSW
MTW
MWL
MNA

3 Select Feet Finish

Click to view edges

4 Select Edge

Click to view details

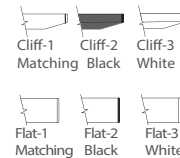
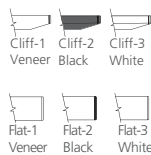

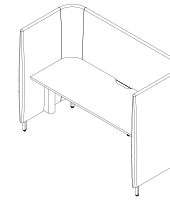

Panels
not included

[Click here to view statement of line](#)

Product Features

- Worksurfaces are 1" thick.
- Lift standard in MFW White, optional MFB Black
- Ships KD
- Wire management tray attaches to worksurface top, standard in MFW White, see premium Metal Finish for options

Notes

- 1" Gap between worksurface and panels to drop wires below worksurface
- Metal parts include 5 year warranty
- Programmable height adjustable mechanism, motor includes 2 year warranty
- Height adjustable top with mechanism and wire tray only, panels not included

Options

Premium Metal Finish

- Specify premium Metal Finish. MFMB: Matte Black, MFS: Silver, MFSS: Salmon Sienna, MFSA: Surfin Aquavert, MFPS: Pistachio, MFOS: Oyster, MFNA: Navy, MFOL: Olive, MFGB: Grey Beige MFGG: Graphite Gray, MFG: Gray, MFGM: Matte Gold
- Premium Metal Finish for WMT wire management tray - \$75 ea

1 Select Model

Weight

Standard Veneer Top

Premium Veneer Top

High Pressure Laminate Top

Thermally Fused Laminate Top

w" x d" x h"	Weight	Standard Veneer Top	Premium Veneer Top
66 X 25 X 1	110	HNY6727WT163W 3845	"P" Option N/A
46 X 25 X 1	100	HNY4727WT163W 3780	"P" Option N/A

2 Select Finish

[Click to view finishes](#)

WWP	WOW
PO01	WNO
PO02	WSO
PO03	WNF(Natural Oak on Flat Cut)
PO07	WSF(Salted Oak on Flat Cut)
PO08	
PO09	
WBW	
WSW	
WEC	

3 Select Feet Finish

[Click to view edges](#)

4 Select Edge

[Click to view details](#)

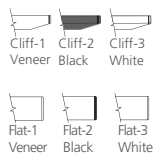

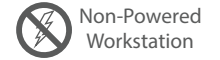
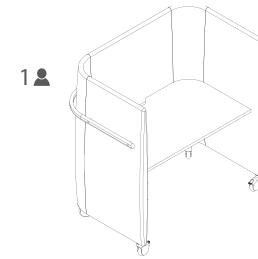

1 Select Model

w" x d" x h"	Weight	Standard Veneer Top Upholstered Panels - COM\$	
73 x 34 x 55	200	HNY7334FT569W	6551
54 x 34 x 55	180	HNY5434FT569W	6112

Premium Veneer Top Upholstered Panels - COM\$

"P" Option N/A
"P" Option N/A

High Pressure Laminate Top Upholstered Panels - COM\$

HNY7334FT569G	6352
HNY5434FT569G	5934

Thermally Fused Laminate Top Upholstered Panels - COM\$

HNY7334FT659M	5969
HNY5434FT569M	5563

[Click here to view statement of line](#)

Product Features

- T75 worksurface wire cutout is standard on all worksurfaces.(T75D: Delete cutout is optional)
- Wood hand rails around outside mounted on wood standoffs
- HNY6726WT160 Fixed Desk Height worksurfaces, 29" worksurface height
- Ships KD

Options

Accessories

- K28: Articulating Keyboard w/ Mouse - \$390
- K31-SK: Center drawer w/ skirt - \$310
- K31: Center drawer w/o skirt - \$205

Casters

- 2 locking and 2 non-locking casters. Available in BK: Black (standard) or GR: Grey (optional)

Wire Tray

- WMT: Wire metal tray. Mounts under top and comes standard in MFW White - \$210

Premium Metal Finish

- Specify premium Metal Finish. MFMB: Matte Black, MFS: Silver, MFSS: Salmon Sienna, MFSA: SurfIn Aquavert, MFPS: Pistachio, MFOS: Oyster, MFNA: Navy, MFOL: Olive, MFGB: Grey Beige MFGG: Graphite Gray, MFG: Gray, MFGM:Matte Gold
- Premium Metal Finish for WMT Wire Management Tray - \$75 ea

Tully Inline Power

- PD-TULLY-IN-72: 2 power/dual USB up, 4 power down, 72" power cord - \$660
- PD-TULLY-IN-120: 2 power/dual USB up, 4 power down, 120" power cord - \$682

[Click Here for Graded in Pricing](#)

2 Select Finish

[Click to view finishes](#)

Top Finishes

WWP	WNO
PO01	WSO
PO02	WEC
PO03	WNF(Natural Oak on Flat Cut)
PO07	WSF(Salted Oak on Flat Cut)
PO08	
PO09	
WBW	
WSW	
WOW	

Top Finishes

GEC	LW05
GWL	LW06
LP01	
LF02	
LF03	
LN01	
LA02	
LW01	
LW02	
LW04	

Top Finishes

MOC
MEC
MSW
MTW
MWL
MNA

3 Select Feet Finish

[Click to view edges](#)

4 Select Edge

[Click to view details](#)

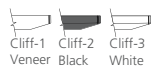

1

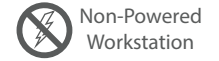
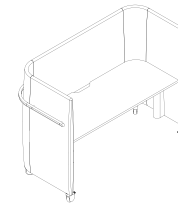

1 Select Model

w" x d" x h"	Weight	Standard Veneer Top Upholstered Panels - COM\$	Premium Veneer Top Upholstered Panels - COM\$
73 x 34 x 55	245	HNY7334HA569W 9071	"P" Option N/A
54 x 34 x 55	225	HNY5434HA569W 8632	"P" Option N/A

[Click Here for Graded in Pricing](#)

2 Select Finish

Click to view finishes

Top Finishes

WWP	WNO
PO01	WSO
PO02	WEC
PO03	WNF(Natural Oak on Flat Cut)
PO07	WSF(Salted Oak on Flat Cut)
PO08	WSF(Salted Oak on Flat Cut)
PO09	WSF(Salted Oak on Flat Cut)
WBW	
WSW	
WOW	

3 Select Feet Finish

Click to view edges

4 Select Edge

Click to view details



Premium Veneer Top Upholstered Panels - COM\$

"P" Option N/A
"P" Option N/A

High Pressure Laminate Top Upholstered Panels - COM\$

HNY7334HA569G 8871
HNY5434HA569G 8453

Top Finishes

GEC	LW05
GWL	LW06
LP01	
LF02	
LF03	
LN01	
LA02	
LW01	
LW02	
LW04	

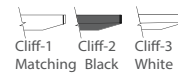

Thermally Fused Laminate Top Upholstered Panels - COM\$

HNY7334HA569M 8488
HNY5434HA569M 8082

Top Finishes

MOC
MEC
MSW
MTW
MWL
MNA



[Click here to view statement of line](#)

Product Features

- 1" Gap between worksurface and panels to drop wires below worksurface
- Programmable height adjustable mechanism, motor includes 2 year warranty
- Wood hand rails around outside mounted on wood standoffs
- 2 locking and 2 non-locking casters. Available in BK: Black (standard) or GR: Grey (optional)
- Adjustable height from 27" to 47.5" with a maximum weight capacity of 275 lbs. Lift standard in MFW White, optional MFB Black
- HNY6625WT163 Height Adjustable worksurfaces is included
- Wire management tray attaches to worksurface top, standard in MFW White, see premium Metal Finish for options
- T75 worksurface wire cutout is standard on all worksurfaces.(T75D: Delete cutout is optional)

Options

Accessories

- K28: Articulating Keyboard w/ Mouse - \$390
- K31-SK: Center drawer w/ skirt - \$310
- K31: Center drawer w/o skirt - \$205

Casters

- 2 locking and 2 non-locking casters. Available in BK: Black (standard) or GR: Grey (optional)

Premium Metal Finish

- Specify premium Metal Finish. MFMB: Matte Black, MFS: Silver, MFSS: Salmon Sienna, MFSA: Surfin Aquavert, MFPS: Pistachio, MFOS: Oyster, MFNA: Navy, MFOL: Olive, MFGB: Grey Beige MFGG: Graphite Gray, MFG: Gray, MFGM:Matte Gold
- Premium Metal Finish for WMT Wire Management Tray - \$75 ea
- Premium Metal Finish for PCEB Concealed Floor Power Infeed Cover - \$35

Tully Inline Power

- PD-TULLY-IN-72: 2 power/dual USB up, 4 power down, 72" power cord - \$660
- PD-TULLY-IN-120: 2 power/dual USB up, 4 power down, 120" power cord - \$682

Honey

90° Worksurface Privacy Screen
 Worksurface PET Privacy Screen

[Click here to view statement of line](#)

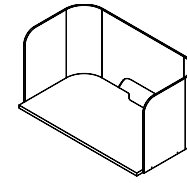

Top
not included

1 Select Model

w" x d" x h"	Weight
46 x 23 x 24	10
66 x 23 x 24	10

Worksurface Screen		PET		
PS46	475			
PS66	495			

Product Features

- Screen attaches to worksurface top
- PET Screen 1/2" thick with rounded corners
- Composed of 100% polyester fiber
- 50% post-consumer recycled content
- Adds additional acoustical absorption

Notes

- Available on both 47" and 67" worksurfaces
- Only available on Height Adjustable Worksurfaces

2 Select Finish

[Click to view finishes](#) Finish N/A

3 Select Edge

[Click to view edges](#) Edge N/A

Select acoustic color

- [Click to view details](#)
- Big Red 45
 - City Brown 06
 - Dark Gray 17
 - Indigo Blue 21
 - Green Apple 39
 - Dark Green 05
 - Medium Gray 63
 - Heathered Granite 71
 - Heathered Oatmeal 75
 - Heathered Teal 76

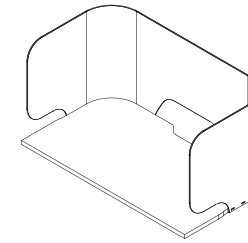

Top
not included

1 Select Model

w" x d" x h"
46 x 24 x 24

Weight

20

Worksurface Screen
Frosted Acrylic

AS46AF

1679

Worksurface Screen
Matte White Acrylic

AS46AW

1804

Worksurface Screen
Matte Black Acrylic

AS46AB

1804

[Click Here for Graded in Pricing](#)

2 Select Finish

Click to view finishes

AF

AW

AB

3 Select Feet Finish

Click to view edges

4 Select Edge

Click to view details



Flat



Flat



Flat

[Click here to view statement of line](#)

Product Features

- Acrylic screens with rounded corners
- 1/4" Thick screen
- Screen attaches to worksurface top

Notes

- Matte acrylic is not a writable surface
- Available on 46" wide 90° worksurfaces
- Only available on Height Adjustable Worksurfaces

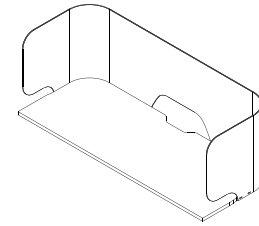

Top
not included

1 Select Model

w" x d" x h"
66 x 24 x 24

Weight

20

Worksurface Screen
Frosted Acrylic

AS64AF

1897

Worksurface Screen
Matte White Acrylic

AS64AW

2022

Worksurface Screen
Matte Black Acrylic

AS64AB

2022

[Click Here for Graded in Pricing](#)

2 Select Finish

Click to view finishes

AF

AW

AB

3 Select Feet Finish

Click to view edges

4 Select Edge

Click to view details



Flat



Flat



Flat

[Click here to view statement of line](#)

Product Features

- Acrylic screens with rounded corners
- 1/4" Thick screen
- Screen attaches to worksurface top

Notes

- Matte acrylic is not a writable surface
- Available on 66" wide 90° worksurfaces
- Only available on Height Adjustable Worksurfaces

DARRAN®

Zip Wire Manager

Style Number	List Price
WMS1 - Fabric	\$77
WMS3 - Neoprene	\$88

Specifications

- > Dimensions: 30" x 1.5" diameter
- > Attaches to wire basket
- > Zips up, bundles and routes loose, messy cables into a single tube
- > Routes and guides cables from Honey height adjustable worksurface to power panel
- > Accommodates large or small cables, up to 10 cords at once
- > WMS1: Fabric wire manager matches panel fabric. Not sold separately from panels.
- > WMS3 : Neoprene wire manager

Available: Honey



Fabric Sleeve
WMS1



Neoprene Sleeve
WMS3

Honey Options

Wire Management Sleeve



Neoprene Colors



White



Black



Gray

DARRAN®

Honey Options

Worksurface Reconfiguration Cover

Style Number List Price
 HBC: 4 Worksurface Reconfiguration Covers \$109

Honey has the ability to adapt with your office as you modify seating positions. The panels can be reconfigured to allow additional workspaces or to modify workspaces to lounge areas. When workspaces are attached to a panel, mounting is required. The Worksurface Reconfiguration Covers allow those mounting positions to be concealed. These covers simply press fit into the Honey panels.

Available: Honey

Standard Colors

STANDARD OPTIONAL



MFW White
 Satin Finish
 (Standard)

MFB Black
 Satin Finish
 (Optional - N/C)



Worksurface Reconfiguration
 Covers

Premium Colors - \$15

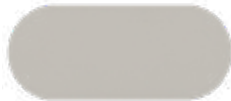

MFG Gray
 Satin Finish
 (Premium)



MFGG Graphite Gray
 Matte Finish
 (Premium)



MFS Silver
 Satin Finish
 (Premium)



MFMB Matte Black
 Matte Finish
 (Premium)



MFNA Navy
 Matte Finish
 (Premium)



MFOL Olive
 Matte Finish
 (Premium)



MFGB Grey Beige
 Matte Finish
 (Premium)



MFSA Surfing Aquavert
 Matte Finish
 (Premium)



MFOS Oyster
 Matte Finish
 (Premium)

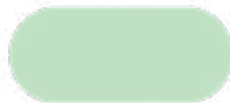

MFPS Pistachio
 Matte Finish
 (Premium)



MFSS Salmon Sienna
 Matte Finish
 (Premium)

DARRAN®

Trek Desktop LED Task Light

Style Number	List Price
TSATL-CM Clamp Mount	\$584
TSATL-SM Surface Mount	\$556
TSATL-FBU Freestanding Base w/ USB	\$693
Trek - Includes 9.5" Extended Arm	
TDATL-CM Clamp Mount	\$649
TDATL-SM Surface Mount	\$622
TDATL-FBU Freestanding Base w/ USB	\$758
HTLOCS - Occupancy sensor, option	\$93

*Surface Mount application requires field installation, 2-1/8" grommet hole bored on site.

Specifications

- › Made with fully-recyclable aluminum and plastic.
- › ENERGY CONSUMPTION: 7.2 system watts; 13.5 system watts with USB
- › NUMBER OF LEDS: 18 fractional LEDs
- › LIGHT OUTPUT: 294 lumens
- › EFFICACY: 41 Lm/W
- › LED RATED LIFESPAN: > 50,000 hours
- › COLOR TEMPERATURE: 3500K
- › COLOR RENDERING INDEX: 85
- › BRIGHTNESS ADJUSTABILITY: 100%–15% continuous
- › AUTO SHUT OFF: after 10 hours
- › USB CHARGE PORT: dedicated Type-A connector 5V, 1.2A max
- › POWER SUPPLY: 18-watt wall transformer with 9' black cord
- › CORD: 3' silver cord with quick connector
- › ETL listed: compliant to UL 153/8750 & CSA C22.2, No. 250.4; FCC Part 15 Class B; TAA; BAA; CEC Title 20
- › WARRANTY: 10 years fixture, 5 years power supply

Available: All DARRAN collections



Trek
Includes 9.5" Extended Arm



Trek
No Extended Arm



Honey Options



Surface Mount



Clamp Mount



Freestanding with USB Mount

Select Finish Color



DARRAN®

Coat Hook

Style Number	List Price
HSCH (Single Sided)	\$104
HDCH (Double Sided)	\$153

Specifications

- > Decorative finished coat hook, select veneer finish for knob.
- > Available in White or Black Standard Metal Finish. Premium finishes are available.
- > Coat hook slides into position on the tops of the Honey panel system and can be easily repositioned.
- > Available in single or double sided coat hook.
- > Each knob can hold weight up to 50lbs.

Note:
Signage Company can add vinyl lettering to feature a persons name, logo etc.

Available: Honey

Standard Colors - Available in single or double sided coat hook



MFW White
Satin Finish
(Standard)

MFB Black
Satin Finish
(Optional - N/C)

Premium Colors - +\$25



MFG Gray
Satin Finish
(Premium)

MFGB Graphite Gray
Matte Finish
(Premium)

MFS Silver
Satin Finish
(Premium)

MFMB Matte Black
Matte Finish
(Premium)

MFNA Navy
Matte Finish
(Premium)

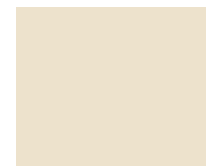

MFOL Olive
Matte Finish
(Premium)

MFGB Grey Beige
Matte Finish
(Premium)

MFSA Surfing Aquavert
Matte Finish
(Premium)

MFOS Oyster
Matte Finish
(Premium)

MFPS Pistachio
Matte Finish
(Premium)

MFSS Salmon Sienna
Matte Finish
(Premium)

Honey Options



Single Sided Coat Hook



Double Sided Coat Hook

Wood Finish for Knob

- PO01 Olive
- PO02 Aquave
- PO03 Mushroom
- PO07 Pebble
- PO08 Vapour
- PO09 Verde
- PM01 Olive
- PM02 Aquavert
- PM03 Mushroom
- PM07 Pebble
- PM08 Vapour
- PM10 Verde
- WOW Clear Walnut
- WNO Natural Oak
- WSO Salted Oak
- WBW Henna Walnut
- WSW Smokey Walnut
- WWP Designer White

DARRAN®

Rotating Bag Hook

Style Number
HPH

List Price
\$55

Specifications

- › 360° swivel rotation
- › Under surface mounted
- › Holds up to 25lbs
- › Notched grooves in the base provide four stop points at 90 degree intervals where hook clicks into place while rotating.

Available: All DARRAN collections

Standard Finishes

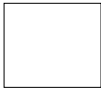

White



Black

Honey Options



DARRAN®

Hanging Leather Storage Pocket

Style Number	List Price
HSSB (Single Sided)	\$279
HDSB (Double Sided)	\$436

Specifications

- > Store and organize paperwork for easy access.
- > Pricing includes Green Hides Lena Leather. Must specify color or specify customers own leather (HSSB requires 3.5 sqft. HDSB requires 7 sqft.)
- > Metal hooks available in White or Black Standard Metal Finish. Premium finishes are available.
- > Hanging Leather Storage Pockets offered in single and double sided.
- > Hanging Leather Storage Pocket slides into position on the tops of the Honey panel system and can be easily repositioned.
- > Can hold up to 20lbs.

Note:
Signage Company can add vinyl lettering to feature a persons name, logo etc.

Available: Honey

Standard Colors (Metal)

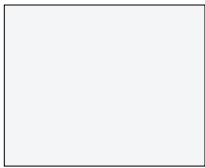

MFW White
Satin Finish
(Standard)

MFB Black
Satin Finish
(Optional - N/C)

[Click here to view Green Hides Lena Leather](#)

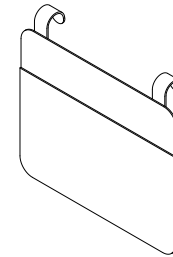

Single Sided

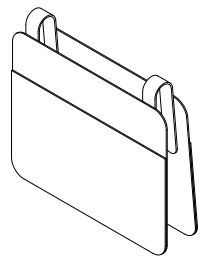

Double Sided

Premium Colors - +\$50

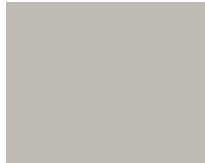

MFG Gray
Satin Finish
(Premium)

MFGG Graphite Gray
Matte Finish
(Premium)

MFS Silver
Satin Finish
(Premium)

MFMB Matte Black
Matte Finish
(Premium)

MFNA Navy
Matte Finish
(Premium)

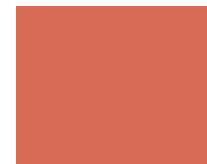
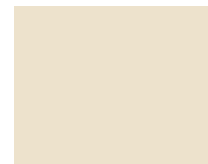

MFOL Olive
Matte Finish
(Premium)

MFGB Grey Beige
Matte Finish
(Premium)

MFSA Surfing Aquavert
Matte Finish
(Premium)

MFOS Oyster
Matte Finish
(Premium)

MFPS Pistachio
Matte Finish
(Premium)

MFSS Salmon Sienna
Matte Finish
(Premium)

Marker Board

Style Number	List Price
HDMB	\$273

Specifications

- > Dry erase marker board, available in White Metal Finish
- > Single side use, marker boards can nest together for double sided application.
- > Marker board slides into position on the tops of the Honey panel system and can be easily repositioned.

Available: Honey



DARRAN®

Hanging Planter

Style Number	List Price
HHP1(Rounded Ceramic)	\$159
HHP2(Cylindrical Stone Powder)	\$276

Specifications

- > Mounted to metal panel hook.
- > No drainage holes.
- > Metal hooks available in White or Black Standard Metal Finish. Premium finishes are available.
- > Hanging planter comes in a rounded ceramic or cylindrical stone powder.

Available: Honey

Standard Colors (Metal)



MFW White
Satin Finish
(Standard)

MFB Black
Satin Finish
(Optional - N/C)

Premium Colors(Matte) - +\$50



MFNG Gray
Satin Finish
(Premium)

MFGG Graphite Gray
Matte Finish
(Premium)

MFS Silver
Satin Finish
(Premium)

MFMB Matte Black
Matte Finish
(Premium)

MFNA Navy
Matte Finish
(Premium)

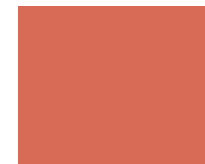
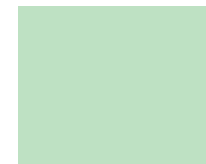
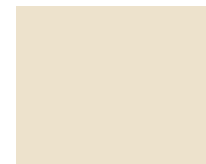

MFOL Olive
Matte Finish
(Premium)

MFGB Grey Beige
Matte Finish
(Premium)

MFSA Surfin Aquavert
Matte Finish
(Premium)

MFOS Oyster
Matte Finish
(Premium)

MFPS Pistachio
Matte Finish
(Premium)

MFSS Salmon Sienna
Matte Finish
(Premium)

Honey Options



DARRAN®

Round Wastebasket with Lid

Style Number List Price
HTC \$415

Specifications

- > Size: 7.5" diameter x 10.7" high
- > Easy-push swing lid allows you to store in plain sight; The trash is contained and out of view.
- > Attaches to inside corner of Honey workstation configurations.
- > Trash can sits on 3/4" thick wood round disc.
- > Easy to clean. Wipe clean with a damp cloth; The durable interior can be rinsed out with mild soap and water when needed.
- > Made of durable BPA and Chlorine free shatter-resistant plastic.
- > Standard with removable lid.

Available: Honey

Honey Options



Step 1: Select Wastebasket Color



White/Gray



Charcoal



Black

Step 2: Select wood finish for base

- PO01 Olive
- PO02 Aquavert
- PO03 Mushroom
- PO07 Pebble
- PO08 Vapour
- PO09 Verde

- WOW Clear Walnut
- WNO Natural Oak
- WSO Salted Oak
- WBW Henna Walnut
- WSW Smokey Walnut
- WWP Designer White

- PM01 Olive
- PM02 Aquavert
- PM03 Mushroom
- PM07 Pebble
- PM08 Vapour
- PM10 Verde

Aircharge wireless charging grommet

Style Number	List Price
 ACWG WIRELESS GROMMET	\$213

Specifications

- > When used with GROVE Tables an additional \$350 LIST will apply for the special cutout required.
- > AirCharge offers a convenient way to charge any Qi compatible smartphone or device without the need to carry charging cables or find an available power outlet.
- > The Aircharge is powered by the latest Qi compliant IC offering reliable and efficient wireless charging in a convenient 3" grommet hub. Simply place your phone on the Aircharge and an LED will confirm pairing and begin wireless charging.
- > Recess: Efficient space conservation and quick access
- > Input: DC 5V (with included AC power adapter), DC 9V, 1.67A (with optional QC 2.0 power adapter)
- > Output: 5 watts Max. with DC 5V, 2A power adapter, 10 watts Max. with QC 2.0 power adapter
- > Qi V1.2 compliant IC
- > Charging distance: 6mm Max.

Available: All DARRAN collections



Cove power unit - non-linking

Style Number	List Price
 PD-COVE PLUG	\$600
Non-linking version	

Specifications

- > Size 5.75"L x 2.5"W
- > (2) 15 Amp Receptacles and (2) USB charging ports
- > Surface Mount
- > 108" Cord
- > Standard Silver Finish, Available in White or Black Finish upon request
- > ETL Listed

Available: All DARRAN collections



Soba wire manager

Style Number	List Price
STARTER UNITS	
SCDW	\$218
White wire manager	
SCDB	\$218
Black wire manager	



Specifications

- > Dimensions: 9ft x 9in x 3.15in
- > Zips up, bundles and routes loose, messy cables into a single tube
- > Routes and guides cables behind desks, TVs, and anywhere cables tend to get messy
- > Accommodates large or small cables, up to three cables at once
- > Support channels, used to route cables, include powerful adhesive backing which allows easy attachment to surfaces.

Available: All DARRAN collections



VILLA Power unit with daisylink

Style Number	List Price
STARTER UNITS	
 VIL-DCH HARDWIRED	\$975
Includes (1) Villa unit with 120" Hardwire Infeed	
 VIL-DCP PLUG	\$975
Includes (1) Villa with Plug Infeed - Includes 72" Cord and 32" Infeed Jumper for 104" total cord infeed	
ADDITIONAL LINKING UNITS	
VIL-DCL ADDITIONAL	\$950
(Includes linking Villa and Jumper cable up to 96")	

Specifications

- > Size: Top Grommet 5.68"L X 3.39"W; Under Top 12"L x 3.13"W x 3.08"D
- > (4) Power receptacles; (2) surface and (2) undersurface, (2) 2.1A USB charging ports and (1) Knockout for RJ45 Data Port
- > Surface Mount
- > Daisy Chain - Hardwire Max (10) Units, Plug/Corded Max (5) Units
- > Standard Silver Finish, Black Finish available upon request
- > UL or ETL Certified

Available: All DARRAN collections, excludes grove

RJ45 Knockout	
RJ45 (1)	\$55



Tully power unit

Style Number

List Price



PD-TULLY

\$349

Specifications

- > 5.5" W x 3.2" H x 1.8" D
- > Finish: Smooth molded plastic integrated within a single piece cover
- > Mounts to the edge of your work surface, with no table cut outs or installation required.
- > (2) Power receptacles, (2) USB 2.1 Amp ports
- > 72" Cord (10' cord available, contact customer service).
- > Standard in White. Available in gray, black, neon red, harvest pumpkin, light green, daisy blue.
- > UL310, Class 2, FCC Part 15A approved
- > Clamp accessory accommodates table thickness from .75"-1.5"

Available: Honey, EdgeWorks, NSS Open,, Thinking Quietly.

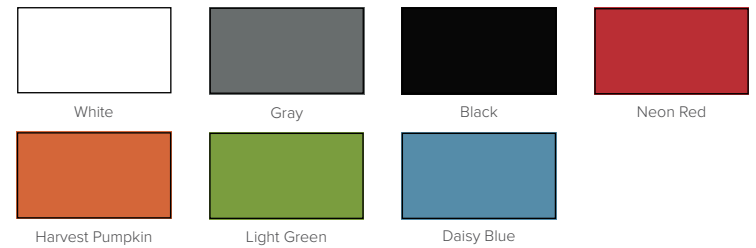

Tully Inline Power unit

Style Number

List Price



PD-Tully-IN72 72" Cord
 PD-Tully-IN120 120" Cord

\$660
 \$682

Specifications

PD TULLY Worksurface Unit

- > 5.5" W x 3.2" H x 1.81" D
- > Finish: Smooth molded plastic integrated within a single piece cover
- > Mounts to the edge of your work surface, with no table cut outs or installation required.
- > (2) Power receptacles, (2) USB 2.1 Amp ports
- > 72" and 120" Plug Cord
- > Standard in White. Available in gray, black, neon red, harvest pumpkin, light green, daisy blue.
- > UL310, Class 2, FCC Part 15A approved
- > Clamp accessory accomodates table thickness from .75"-1.5"

Tully Under Worksurface Unit

- > 11.75" x 2.5" x 2.05"
- > 4 - 15A, AC Power Outlets mounted under the worksurface
- > 24" Cord that connects to PD Tully
- > Comes with wire manager hooks to secure power cord when not in use
- > UL 962A Listed, UL 1310 Recognized, Meets UL Spill Requirements, Class 2, FCC Part 15 A Approved

Available: All Collections



Power Unit Color

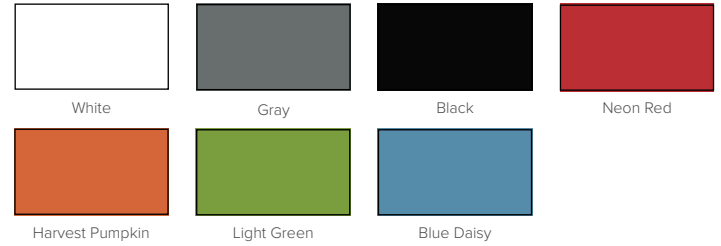

Cord Color

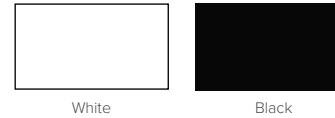

Keno power unit

Style Number

List Price



PD-KENO

\$213

Specifications

- > Size 5.5"L x 2.125"W x 2.5"H
- > 2 TR AC Outlets
- > 1 4.2A USB module w/ 2 charging ports
- > 10' Power cord

Available: Honey, EdgeWorks, NSS Open, Thinking Quietly

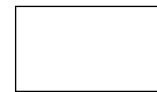

White



Black

Nuuk single power unit with undersurface mount

Style Number

List Price



PD-NUUK1-UM

\$317

Specifications

- > 1 AC receptacle with (1.5A) and fast-charging (2.4A) USB ports for rapid re-charging
- > 6' Power cord, available in black or white
- > Optional fabric woven cord in Graphite or Ivory - \$50
- > UL962A listed
- > UL1310 listed power supply
- > Size: 4.44"L x 4.11"x 2.33H
- > Undersurface mount



Available: On all DARRAN collections

Step 1: Select Body Color

White	Black	Cayenne	Clementine	Cranberry
Currant	Dijon	Eggplant	Forest	Goldenrod
Grape	Gulf	Kiwi	Maize	Marine
Merlot	Ocean	Paprika	Pineapple	Porcelain
Pumpkin	Punch	Raisin	Silver-Sage	Silver
Sky	Spruce	Teal	Tranquil	

Step 2: Select AC Receptacle Color

White	Linen	Black

Step 3: Select Cord Color

Ivory +\$50	Graphite +\$50	Black	White

Nuuk dual power unit with undersurface mount

Style Number

List Price



PD-NUUK2-UM

\$366

Specifications

- > 2 AC receptacle with (1.5A) and fast-charging (2.4A) USB ports for rapid re-charging
- > 6' Power cord, available in black or white
- > Optional fabric woven cord in Graphite or Ivory - \$50
- > UL962A listed
- > UL1310 listed power supply
- > Size: 6.11"L x 4.11"W x 2.33"H
- > Undersurface mount



Available: All DARRAN collections

Step 1: Select Body Color

White	Black	Cayenne	Clementine	Cranberry
Currant	Dijon	Eggplant	Forest	Goldenrod
Grape	Gulf	Kiwi	Maize	Marine
Merlot	Ocean	Paprika	Pineapple	Porcelain
Pumpkin	Punch	Raisin	Silver-Sage	Silver
Sky	Spruce	Teal	Tranquil	

Step 2: Select AC Receptacle Color

White	Linen	Black

Step 3: Select Cord Color

Ivory +\$50	Graphite +\$50	Black	White

Nuuk single power unit with clamp

Style Number

List Price



PD-NUUK1-CL

\$355

Specifications

- > 1 AC receptacle with (1.5A) and fast-charging (2.4A) USB ports for rapid re-charging
- > 6' Power cord, available in black or white
- > Optional fabric woven cord in Graphite or Ivory - \$50
- > UL962A listed
- > UL1310 listed power supply
- > Size: 4.44"L x 4.35"W x 3.03"H
- > Clamp mount: clamps onto surfaces of 3/4-1-1/4" thickness





Available: On all DARRAN collections, excluding Grove





Step 1: Select Body Color

 White	 Black	 Cayenne	 Clementine	 Cranberry
 Currant	 Dijon	 Eggplant	 Forest	 Goldenrod
 Grape	 Gulf	 Kiwi	 Maize	 Marine
 Merlot	 Ocean	 Paprika	 Pineapple	 Porcelain
 Pumpkin	 Punch	 Raisin	 Silver-Sage	 Silver
 Sky	 Spruce	 Teal	 Tranquil	

Step 2: Select AC Receptacle Color

 White	 Linen	 Black
--	--	--

Step 3: Select Cord Color

 Ivory +\$50	 Graphite +\$50	 Black	 White
--	---	--	--

Nuuk dual power unit with clamp

Style Number

List Price



PD-NUUK2-CL

\$409

Specifications

- > 2 AC receptacle with (1.5A) and fast-charging (2.4A) USB ports for rapid re-charging
- > 6' Power cord, available in black or white
- > Optional fabric woven cord in Graphite or Ivory - \$50
- > UL962A listed
- > UL1310 listed power supply
- > Size: 6.11"L x 4.35"W x 2.33"H
- > Clamp mount: clamps onto surfaces of 3/4-1-1/4" thickness





Available: All DARRAN collections, excluding Grove





Step 1: Select Body Color

 White	 Black	 Cayenne	 Clementine	 Cranberry
 Currant	 Dijon	 Eggplant	 Forest	 Goldenrod
 Grape	 Gulf	 Kiwi	 Maize	 Marine
 Merlot	 Ocean	 Paprika	 Pineapple	 Porcelain
 Pumpkin	 Punch	 Raisin	 Silver-Sage	 Silver
 Sky	 Spruce	 Teal	 Tranquil	

Step 2: Select AC Receptacle Color

 White	 Linen	 Black
--	--	--

Step 3: Select Cord Color

 Ivory +\$50	 Graphite +\$50	 Black	 White
--	---	--	--

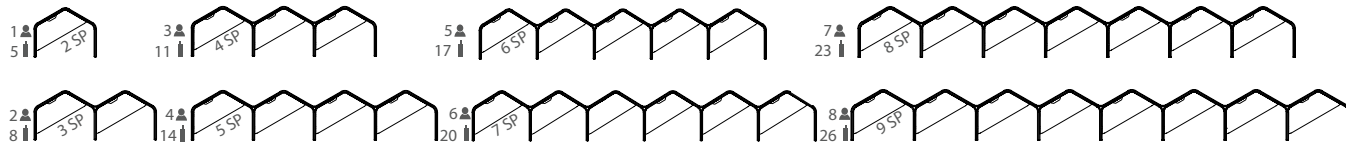

Number of Feet per Typical (MTL10 Option) "SP" Number of Starter Panels per Typical (RSP Option)

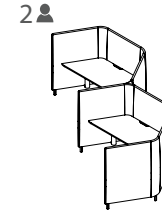

1 Select Model

w" x d" x h"	Weight	Standard Veneer Top Upholstered Panels - COM\$	Premium Veneer Top Upholstered Panels - COM\$	High Pressure Laminate Top Upholstered Panels - COM\$	Thermally Fused Laminate Top Upholstered Panels - COM\$
602 x 62 x 55	96	8 HNY60262HA571W 70057	"P" Option N/A	HNY60262HA571G 68449	HNY60262HA571M 65393
528 x 62 x 55	84	7 HNY52862HA571W 61493	"P" Option N/A	HNY52862HA571G 60086	HNY52862HA571M 57412
453 x 62 x 55	73	6 HNY45362HA571W 52929	"P" Option N/A	HNY45362HA571G 51723	HNY45362HA571M 49431
378 x 62 x 55	61	5 HNY37862HA571W 44365	"P" Option N/A	HNY37862HA571G 43360	HNY37862HA571M 41450
303 x 62 x 55	50	4 HNY30362HA571W 35801	"P" Option N/A	HNY30362HA571G 34997	HNY30362HA571M 33469
228 x 62 x 55	38	3 HNY22862HA571W 27237	"P" Option N/A	HNY22862HA571G 26634	HNY22862HA571M 25488
153 x 62 x 55	27	2 HNY15362HA571W 18673	"P" Option N/A	HNY15362HA571G 18271	HNY15362HA571M 17507
78 x 62 x 55	15	1 HNY7862HA571W 10109	"P" Option N/A	HNY7862HA571G 9908	HNY7862HA571M 9526

[Click Here for Graded in Pricing](#)

2 Select Finish

Click to view finishes

WWP	WOW
PO01	WNO
PO02	WSO
PO03	WNF(Natural Oak on Flat Cut)
PO07	WSF(Salted Oak on Flat Cut)
PO08	WSF(Salted Oak on Flat Cut)
PO09	WSF(Salted Oak on Flat Cut)
WBW	
WSW	
WEC	

3 Select Feet Finish

Click to view edges

WWP	WOW
PO01	WNO
PO02	WSO
PO03	
PO07	
PO08	
PO09	
WBW	
WSW	
WEC	

4 Select Edge

Click to view details

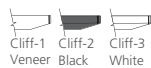

GEC	LW05
GWL	LW06
LP01	
LF02	
LF03	
LN01	
LA02	
LW01	
LW02	
LW04	

WWP	WOW
PO01	WNO
PO02	WSO
PO03	
PO07	
PO08	
PO09	
WBW	
WSW	
WEC	



MOC
MEC
MSW
MTW
MWL
MNA

WWP	WOW
PO01	WNO
PO02	WSO
PO03	
PO07	
PO08	
PO09	
WBW	
WSW	



[Click here to view statement of line](#)

Product Features

- 5" Solid wood feet - oval shape, ships KD
- 4 Power outlets with 1 telecom plate, see options below for telecom plate
- Adjustable height from 27" to 47.5" with a maximum weight capacity of 275 lbs. Lift standard in MFW White, optional MFB Black
- HNY7125WT163 Height Adjustable worksurfaces are included
- Wire management tray attaches to worksurface top, standard in MFW White, see premium Metal Finish for options
- T75 worksurface wire cutout is standard on all worksurfaces.(T75D: Delete cutout is optional)

Notes

- 1" Gap between worksurface and panels to drop wires below worksurface
- Metal parts include 5 year warranty
- Programmable height adjustable mechanism, motor includes 2 year warranty

Options

Accessories

- K28: Articulating Keyboard w/ Mouse - \$390
- K31-SK: Center drawer w/ skirt - \$310
- K31: Center drawer w/o skirt - \$205

Concealed Floor Power Infeed Cover

- PCEB: White Metal Finish concealed floor power infeed cover - \$150

Delete Top and Wire Tray

- DHAT: Delete height adjustable top. Deduct \$3265 Veneer(W), \$3095 High Pressure Laminate(G), \$2770 Thermally Fused Laminate(M) per top

Metal Feet

- MTL10: Replace solid wood feet with metal feet, standard MFW White - \$55 ea

Premium Metal Finish

- Specify premium Metal Finish. MFMB: Matte Black, MFS: Silver, MFSS: Salmon Sienna, MFSA: Surfin Aquavert, MFPS: Pistachio, MFOS: Oyster, MFNA: Navy, MFOL: Olive, MFGB: Grey Beige MFGG: Graphite Gray, MFG: Gray, MFGM:Matte Gold
- Premium Metal Finish for WMT Wire Management Tray - \$75 ea
- Premium Metal Finish for MTL10 Metal Feet - \$20 ea
- Premium Metal Finish for PCEB Concealed Floor Power Infeed Cover - \$35

Starter Panel

- RSP: Substitute round starter panel in place of flat starter panel. Must substitute all starters, priced per starter panel - \$83 each. See HNY3555SP888

Telecom Plates

- Each power unit has 1 plate. All telecom connectors sold separately.
- RJ45 (1) - \$55, RJ45 (2) - \$110, RJ45 (3) - \$165, USB (1) - \$70, USB (2) - \$140, RJ45/USB - \$125, RJ45/HDMI - \$210, HDMI/USB - \$205

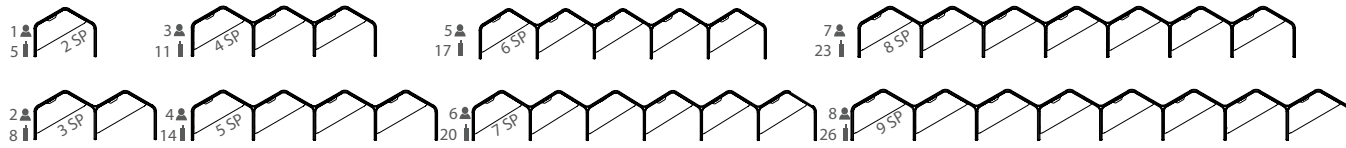

Number of Feet per Typical (MTL10 Option) "SP" Number of Starter Panels per Typical (RSP Option)

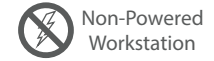
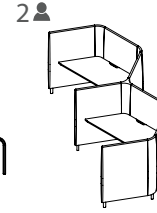

1 Select Model

w" x d" x h"	Weight	Standard Veneer Top Upholstered Panels - COM\$	Premium Veneer Top Upholstered Panels - COM\$
602 x 62 x 55	96	8 HNY60262FT571W 47826	"P" Option N/A
528 x 62 x 55	84	7 HNY52862FT571W 42024	"P" Option N/A
453 x 62 x 55	73	6 HNY45362FT571W 36222	"P" Option N/A
378 x 62 x 55	61	5 HNY37862FT571W 30420	"P" Option N/A
303 x 62 x 55	50	4 HNY30362FT571W 24618	"P" Option N/A
228 x 62 x 55	38	3 HNY22862FT571W 18816	"P" Option N/A
153 x 62 x 55	27	2 HNY15362FT571W 13014	"P" Option N/A
78 x 62 x 55	15	1 HNY7862FT571W 7212	"P" Option N/A

[Click Here for Graded in Pricing](#)

2 Select Finish

Click to view finishes

WWP	WOW
PO01	WNO
PO02	WSO
PO03	WNF(Natural Oak on Flat Cut)
PO07	WSF(Salted Oak on Flat Cut)
PO08	WSF(Salted Oak on Flat Cut)
PO09	WSF(Salted Oak on Flat Cut)
WBW	
WSW	
WEC	

3 Select Feet Finish

Click to view edges

WWP	WOW
PO01	WNO
PO02	WSO
PO03	
PO07	
PO08	
PO09	
WBW	
WSW	
WEC	

4 Select Edge

Click to view details

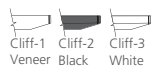

High Pressure Laminate Top Upholstered Panels - COM\$

HNY60262FT571G	46226
HNY52862FT571G	40624
HNY45362FT571G	35022
HNY37862FT571G	29420
HNY30362FT571G	23818
HNY22862FT571G	18216
HNY15362FT571G	12614
HNY7862FT571G	7012

GEC	LW05
GWL	LW06
LP01	
LF02	
LF03	
LN01	
LA02	
LW01	
LW02	
LW04	

WWP	WOW
PO01	WNO
PO02	WSO
PO03	
PO07	
PO08	
PO09	
WBW	
WSW	
WEC	



Thermally Fused Laminate Top Upholstered Panels - COM\$

HNY60262FT571M	43170
HNY52862FT571M	37950
HNY45362FT571M	32730
HNY37862FT571M	27510
HNY30362FT571M	22290
HNY22862FT571M	17070
HNY15362FT571M	11850
HNY7862FT571M	6630

MOC
MEC
MSW
MTW
MWL
MNA

WWP	WOW
PO01	WNO
PO02	WSO
PO03	
PO07	
PO08	
PO09	
WBW	
WSW	



[Click here to view statement of line](#)

Product Features

- 5" Solid wood feet - oval shape
- HNY7226WT162 Fixed Desk Height worksurfaces, 29" worksurface height
- Ships KD
- T75 worksurface wire cutout is standard on all worksurfaces.(T75D: Delete cutout is optional)

Options

Accessories

- K28: Articulating Keyboard w/ Mouse - \$390
- K31-SK: Center drawer w/ skirt - \$310
- K31: Center drawer w/o skirt - \$205

Concealed Floor Power Infeed Cover

- PCEB: White Metal Finish concealed floor power infeed cover - \$150

Delete Top

- DFT: Delete fixed top. Deduct \$1125 Veneer(W), \$955 High Pressure Laminate (G), \$630 Thermally Fused Laminate (M) per top

Metal Feet

- MTL10: Replace solid wood feet with metal feet, standard MFW White - \$55 ea

Premium Metal Finish

- Specify premium Metal Finish. MFMB: Matte Black, MFS: Silver, MFSS: Salmon Sienna, MFSA: Surfing Aquavert, MFPS: Pistachio, MFOS: Oyster, MFNA: Navy, MFOL: Olive, MFGB: Grey Beige MFGG: Graphite Gray, MFG: Gray, MFGM:Matte Gold
- Premium Metal Finish for WMT Wire Management Tray - \$75 ea
- Premium Metal Finish for MTL10 Metal Feet - \$20 ea
- Premium Metal Finish for PCEB Concealed Floor Power Infeed Cover - \$35

Starter Panel

- RSP: Substitute round starter panel in place of flat starter panel. Must substitute all starters, priced per starter panel - \$83 each. See HNY3555SP888

Worksurface Height

- Modify worksurface height to bar height.
- THL-42: Position worksurface at bar height - N/C

Wire Tray

- WMT: Wire metal tray. Mounts under top and comes standard in MFW White - \$210

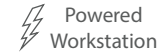
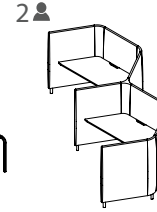
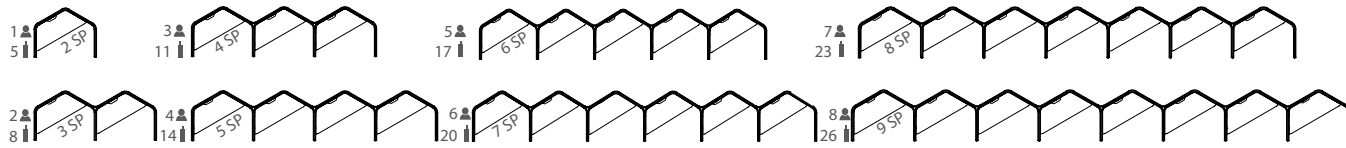

Number of Feet per Typical (MTL10 Option) "SP" Number of Starter Panels per Typical (RSP Option)

1 Select Model

w" x d" x h"	Weight	Standard Veneer Top Upholstered Panels - COM\$	Premium Veneer Top Upholstered Panels - COM\$
602 x 62 x 55	96	8 HNY60262FP571W 51729	"P" Option N/A
528 x 62 x 55	84	7 HNY52862FP571W 45456	"P" Option N/A
453 x 62 x 55	73	6 HNY45362FP571W 39183	"P" Option N/A
378 x 62 x 55	61	5 HNY37862FP571W 32910	"P" Option N/A
303 x 62 x 55	50	4 HNY30362FP571W 26637	"P" Option N/A
228 x 62 x 55	38	3 HNY22862FP571W 20364	"P" Option N/A
153 x 62 x 55	27	2 HNY15362FP571W 14091	"P" Option N/A
78 x 62 x 55	15	1 HNY7862FP571W 7818	"P" Option N/A

[Click Here for Graded in Pricing](#)

2 Select Finish

Click to view finishes

WWP	WOW
PO01	WNO
PO02	WSO
PO03	WNF(Natural Oak on Flat Cut)
PO07	WSF(Salted Oak on Flat Cut)
PO08	WSF(Salted Oak on Flat Cut)
PO09	WSF(Salted Oak on Flat Cut)
WBW	
WSW	
WEC	

3 Select Feet Finish

Click to view edges

WWP	WOW
PO01	WNO
PO02	WSO
PO03	
PO07	
PO08	
PO09	
WBW	
WSW	
WEC	

4 Select Edge

Click to view details

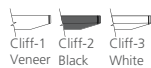

High Pressure Laminate Top Upholstered Panels - COM\$

HNY60262FP571G	50129
HNY52862FP571G	44056
HNY45362FP571G	37983
HNY37862FP571G	31910
HNY30362FP571G	25837
HNY22862FP571G	19764
HNY15362FP571G	13691
HNY7862FP571G	7618

GEC	LW05
GWL	LW06
LP01	
LF02	
LF03	
LN01	
LA02	
LW01	
LW02	
LW04	

WWP	WOW
PO01	WNO
PO02	WSO
PO03	
PO07	
PO08	
PO09	
WBW	
WSW	
WEC	



Thermally Fused Laminate Top Upholstered Panels - COM\$

HNY60262FP571M	47073
HNY52862FP571M	41382
HNY45362FP571M	35691
HNY37862FP571M	30000
HNY30362FP571M	24309
HNY22862FP571M	18618
HNY15362FP571M	12927
HNY7862FP571M	7236

MOC
MEC
MSW
MTW
MWL
MNA

WWP	WOW
PO01	WNO
PO02	WSO
PO03	
PO07	
PO08	
PO09	
WBW	
WSW	



[Click here to view statement of line](#)

Product Features

- HNY7226WT162 Fixed Desk Height worksurfaces, 29" worksurface height
- 5" Solid wood feet - oval shape
- 4 Power outlets with 1 telecom plate, see options below for telecom plate
- Ships KD
- Wire management tray attaches to worksurface top, standard in MFW White, see premium Metal Finish for options
- Hardwire infeed and jumpers are included in workstations
- T75 worksurface wire cutout is standard on all worksurfaces.(T75D: Delete cutout is optional)

Options

Accessories

- K28: Articulating Keyboard w/ Mouse - \$390
- K31-SK: Center drawer w/ skirt - \$310
- K31: Center drawer w/o skirt - \$205

Concealed Floor Power Infeed Cover

- PCEB: White Metal Finish concealed floor power infeed cover - \$150

Delete Top and Wire Tray

- DFP: Delete fixed top. Deduct \$1335 Veneer (W), \$1165 High Pressure Laminate (G), \$840 Thermally Fused Laminate (M) per top

Metal Feet

- MTL10: Replace solid wood feet with metal feet, standard MFW White - \$55 ea

Premium Metal Finish

- Specify premium Metal Finish. MFMB: Matte Black, MFS: Silver, MFSS: Salmon Sienna, MFSA: Surfing Aquavert, MFPS: Pistachio, MFOS: Oyster, MFNA: Navy, MFOL: Olive, MFGB: Grey Beige MFGG: Graphite Gray, MFG: Gray, MFGM:Matte Gold
- Premium Metal Finish for WMT Wire Management Tray - \$75 ea
- Premium Metal Finish for MTL10 Metal Feet - \$20 ea
- Premium Metal Finish for PCEB Concealed Floor Power Infeed Cover - \$35

Starter Panel

- RSP: Substitute round starter panel in place of flat starter panel. Must substitute all starters, priced per starter panel - \$83 each. See HNY3555SP888

Telecom Plates

- Each power unit has 1 plate. All telecom connectors sold separately.
- RJ45 (1) - \$55, RJ45 (2) - \$110, RJ45 (3) - \$165, USB (1) - \$70, USB (2) - \$140, RJ45/USB - \$125, RJ45/HDMI - \$210, HDMI/USB - \$205

Worksurface Height

- THL-42: Modify worksurface height to bar height - N/C

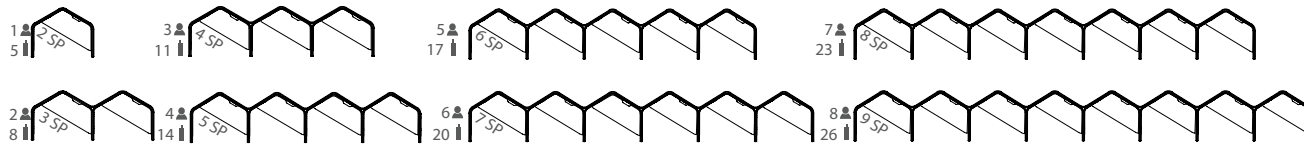

Number of Feet per Typical (MTL10 Option) "SP" Number of Starter Panels per Typical (RSP Option)

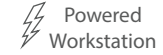
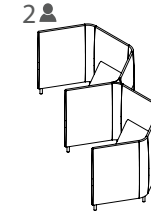

1 Select Model

w" x d" x h"	Weight	Standard Veneer Top Upholstered Panels - COM\$	Premium Veneer Top Upholstered Panels - COM\$	High Pressure Laminate Top Upholstered Panels - COM\$	Thermally Fused Laminate Top Upholstered Panels - COM\$
602 x 62 x 55	96	8 HNY60262HA572W 70057	"P" Option N/A	HNY60262HA572G 68449	HNY60262HA572M 65393
528 x 62 x 55	84	7 HNY52862HA572W 61493	"P" Option N/A	HNY52862HA572G 60086	HNY52862HA572M 57412
453 x 62 x 55	73	6 HNY45362HA572W 52929	"P" Option N/A	HNY45362HA572G 51723	HNY45362HA572M 49431
378 x 62 x 55	61	5 HNY37862HA572W 44365	"P" Option N/A	HNY37862HA572G 43360	HNY37862HA572M 41450
303 x 62 x 55	50	4 HNY30362HA572W 35801	"P" Option N/A	HNY30362HA572G 34997	HNY30362HA572M 33469
228 x 62 x 55	38	3 HNY22862HA572W 27237	"P" Option N/A	HNY22862HA572G 26634	HNY22862HA572M 25488
153 x 62 x 55	27	2 HNY15362HA572W 18673	"P" Option N/A	HNY15362HA572G 18271	HNY15362HA572M 17507
78 x 62 x 55	15	1 HNY7862HA572W 10109	"P" Option N/A	HNY7862HA572G 9908	HNY7862HA572M 9526

[Click Here for Graded in Pricing](#)

2 Select Finish

Click to view finishes

WWP	WOW
PO01	WNO
PO02	WSO
PO03	WNF(Natural Oak on Flat Cut)
PO07	WSF(Salted Oak on Flat Cut)
PO08	WSF(Salted Oak on Flat Cut)
PO09	WSF(Salted Oak on Flat Cut)
WBW	
WSW	
WEC	

3 Select Feet Finish

Click to view edges

WWP	WOW
PO01	WNO
PO02	WSO
PO03	
PO07	
PO08	
PO09	
WBW	
WSW	
WEC	

4 Select Edge

Click to view details

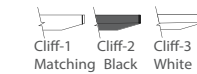
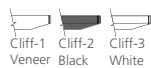

[Click here to view statement of line](#)

Product Features

- 5" Solid wood feet - oval shape, ships KD
- 4 Power outlets with 1 telecom plate, see options below for telecom plate
- Adjustable height from 27" to 47.5" with a maximum weight capacity of 275 lbs. Lift standard in MFW White, optional MFB Black
- HNY7125WT163 Height Adjustable worksurfaces are included
- Wire management tray attaches to worksurface top, standard in MFW White, see premium Metal Finish for options
- T75 worksurface wire cutout is standard on all worksurfaces.(T75D: Delete cutout is optional)

Notes

- 1" Gap between worksurface and panels to drop wires below worksurface
- Metal parts include 5 year warranty
- Programmable height adjustable mechanism, motor includes 2 year warranty

Options

Accessories

- K28: Articulating Keyboard w/ Mouse - \$390
- K31-SK: Center drawer w/ skirt - \$310
- K31: Center drawer w/o skirt - \$205

Concealed Floor Power Infeed Cover

- PCEB: White Metal Finish concealed floor power infeed cover - \$150

Delete Top and Wire Tray

- DHAT: Delete height adjustable top. Deduct \$3265 Veneer(W), \$3095 High Pressure Laminate(G), \$2770 Thermally Fused Laminate(M) per top

Metal Feet

- MTL10: Replace solid wood feet with metal feet, standard MFW White - \$55 ea

Premium Metal Finish

- Specify premium Metal Finish. MFMB: Matte Black, MFS: Silver, MFSS: Salmon Sienna, MFSA: Surfin Aquavert, MFPS: Pistachio, MFOS: Oyster, MFNA: Navy, MFOL: Olive, MFGB: Grey Beige MFGG: Graphite Gray, MFG: Gray, MFGM:Matte Gold
- Premium Metal Finish for WMT Wire Management Tray - \$75 ea
- Premium Metal Finish for MTL10 Metal Feet - \$20 ea
- Premium Metal Finish for PCEB Concealed Floor Power Infeed Cover - \$35

Starter Panel

- RSP: Substitute round starter panel in place of flat starter panel. Must substitute all starters, priced per starter panel - \$83 each. See HNY3555SP888

Telecom Plates

- Each power unit has 1 plate. All telecom connectors sold separately.
- RJ45 (1) - \$55, RJ45 (2) - \$110, RJ45 (3) - \$165, USB (1) - \$70, USB (2) - \$140, RJ45/USB - \$125, RJ45/HDMI - \$210, HDMI/USB - \$205

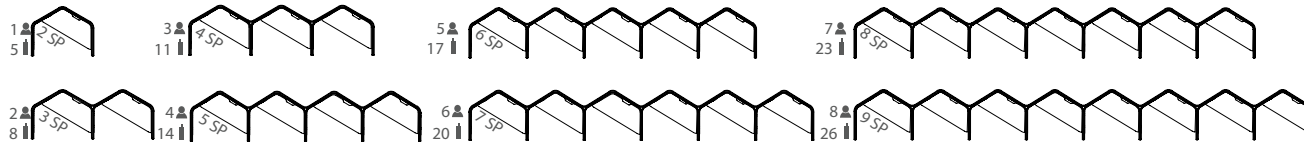

Number of Feet per Typical (MTL10 Option) "SP" Number of Starter Panels per Typical (RSP Option)

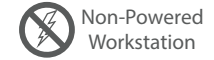
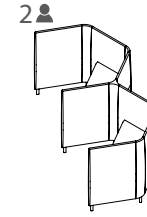

1 Select Model

w" x d" x h"	Weight	Standard Veneer Top Upholstered Panels - COM\$	Premium Veneer Top Upholstered Panels - COM\$	High Pressure Laminate Top Upholstered Panels - COM\$	Thermally Fused Laminate Top Upholstered Panels - COM\$
602 x 62 x 55	96	8 HNY60262FT572W 47826	"P" Option N/A	HNY60262FT572G 46226	HNY60262FT572M 43170
528 x 62 x 55	84	7 HNY52862FT572W 42024	"P" Option N/A	HNY52862FT572G 40624	HNY52862FT572M 37950
453 x 62 x 55	73	6 HNY45362FT572W 36222	"P" Option N/A	HNY45362FT572G 35022	HNY45362FT572M 32730
378 x 62 x 55	61	5 HNY37862FT572W 30420	"P" Option N/A	HNY37862FT572G 29420	HNY37862FT572M 27510
303 x 62 x 55	50	4 HNY30362FT572W 24618	"P" Option N/A	HNY30362FT572G 23818	HNY30362FT572M 22290
228 x 62 x 55	38	3 HNY22862FT572W 18816	"P" Option N/A	HNY22862FT572G 18216	HNY22862FT572M 17070
153 x 62 x 55	27	2 HNY15362FT572W 13014	"P" Option N/A	HNY15362FT572G 12614	HNY15362FT572M 11850
78 x 62 x 55	15	1 HNY7862FT572W 7212	"P" Option N/A	HNY7862FT572G 7012	HNY7862FT572M 6630

[Click Here for Graded in Pricing](#)

2 Select Finish

Click to view finishes

WWP	WOW
PO01	WNO
PO02	WSO
PO03	WNF(Natural Oak on Flat Cut)
PO07	WSF(Salted Oak on Flat Cut)
PO08	WSF(Salted Oak on Flat Cut)
PO09	WSF(Salted Oak on Flat Cut)
WBW	
WSW	
WEC	

3 Select Feet Finish

Click to view edges

WWP	WOW
PO01	WNO
PO02	WSO
PO03	
PO07	
PO08	
PO09	
WBW	
WSW	
WEC	

4 Select Edge

Click to view details

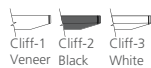

[Click here to view statement of line](#)

Product Features

- 5" Solid wood feet - oval shape
- HNY7226WT162 Fixed Desk Height worksurfaces, 29" worksurface height
- Ships KD
- T75 worksurface wire cutout is standard on all worksurfaces.(T75D: Delete cutout is optional)

Options

Accessories

- K28: Articulating Keyboard w/ Mouse - \$390
- K31-SK: Center drawer w/ skirt - \$310
- K31: Center drawer w/o skirt - \$205

Concealed Floor Power Infeed Cover

- PCEB: White Metal Finish concealed floor power infeed cover - \$150

Delete Top

- DFT: Delete fixed top. Deduct \$1125 Veneer(W), \$955 High Pressure Laminate (G), \$630 Thermally Fused Laminate (M) per top

Metal Feet

- MTL10: Replace solid wood feet with metal feet, standard MFW White - \$55 ea

Premium Metal Finish

- Specify premium Metal Finish. MFMB: Matte Black, MFS: Silver, MFSS: Salmon Sienna, MFSA: Surfing Aquavert, MFPS: Pistachio, MFOS: Oyster, MFNA: Navy, MFOL: Olive, MFGB: Grey Beige MFGG: Graphite Gray, MFG: Gray, MFGM:Matte Gold
- Premium Metal Finish for WMT Wire Management Tray - \$75 ea
- Premium Metal Finish for MTL10 Metal Feet - \$20 ea
- Premium Metal Finish for PCEB Concealed Floor Power Infeed Cover - \$35

Starter Panel

- RSP: Substitute round starter panel in place of flat starter panel. Must substitute all starters, priced per starter panel - \$83 each. See HNY3555SP888

Worksurface Height

- Modify worksurface height to bar height.
- THL-42: Position worksurface at bar height - N/C

Wire Tray

- WMT: Wire metal tray. Mounts under top and comes standard in MFW White - \$210

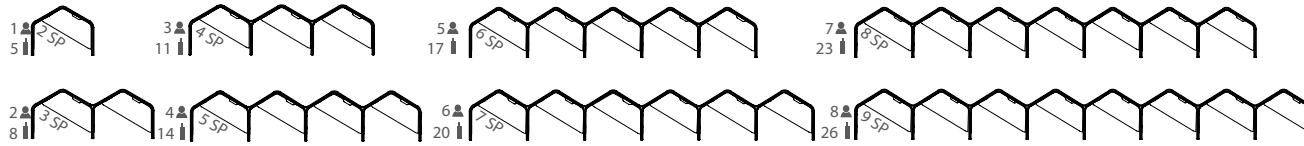

Number of Feet per Typical (MTL10 Option) "SP" Number of Starter Panels per Typical (RSP Option)

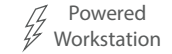
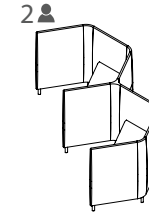

1 Select Model

w" x d" x h"	Weight	Standard Veneer Top Upholstered Panels - COM\$	Premium Veneer Top Upholstered Panels - COM\$
602 x 62 x 55	96	8 HNY60262FP572W 51729	"P" Option N/A
528 x 62 x 55	84	7 HNY52862FP572W 45456	"P" Option N/A
453 x 62 x 55	73	6 HNY45362FP572W 39183	"P" Option N/A
378 x 62 x 55	61	5 HNY37862FP572W 32910	"P" Option N/A
303 x 62 x 55	50	4 HNY30362FP572W 26637	"P" Option N/A
228 x 62 x 55	38	3 HNY22862FP572W 20364	"P" Option N/A
153 x 62 x 55	27	2 HNY15362FP572W 14091	"P" Option N/A
78 x 62 x 55	15	1 HNY7862FP572W 7818	"P" Option N/A

[Click Here for Graded in Pricing](#)

2 Select Finish

Click to view finishes

WWP	WOW
PO01	WNO
PO02	WSO
PO03	WNF(Natural Oak on Flat Cut)
PO07	WSF(Salted Oak on Flat Cut)
PO08	WSF(Salted Oak on Flat Cut)
PO09	WSF(Salted Oak on Flat Cut)
WBW	
WSW	
WEC	

3 Select Feet Finish

Click to view edges

WWP	WOW
PO01	WNO
PO02	WSO
PO03	
PO07	
PO08	
PO09	
WBW	
WSW	
WEC	

4 Select Edge

Click to view details



High Pressure Laminate Top Upholstered Panels - COM\$

HNY60262FP572G	50129
HNY52862FP572G	44056
HNY45362FP572G	37983
HNY37862FP572G	31910
HNY30362FP572G	25837
HNY22862FP572G	19764
HNY15362FP572G	13691
HNY7862FP572G	7618

GEC	LW05
GWL	LW06
LP01	
LF02	
LF03	
LN01	
LA02	
LW01	
LW02	
LW04	

WWP	WOW
PO01	WNO
PO02	WSO
PO03	
PO07	
PO08	
PO09	
WBW	
WSW	
WEC	

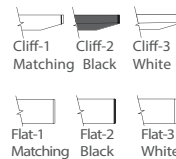

Thermally Fused Laminate Top Upholstered Panels - COM\$

HNY60262FP572M	47073
HNY52862FP572M	41382
HNY45362FP572M	35691
HNY37862FP572M	30000
HNY30362FP572M	24309
HNY22862FP572M	18618
HNY15362FP572M	12927
HNY7862FP572M	7236

MOC
MEC
MSW
MTW
MWL
MNA

WWP	WOW
PO01	WNO
PO02	WSO
PO03	
PO07	
PO08	
PO09	
WEC	
WBW	
WSW	



[Click here to view statement of line](#)

Product Features

- HNY7226WT162 Fixed Desk Height worksurfaces, 29" worksurface height
- 5" Solid wood feet - oval shape
- 4 Power outlets with 1 telecom plate, see options below for telecom plate
- Ships KD
- Wire management tray attaches to worksurface top, standard in MFW White, see premium Metal Finish for options
- Hardwire infeed and jumpers are included in workstations
- T75 worksurface wire cutout is standard on all worksurfaces.(T75D: Delete cutout is optional)

Options

Accessories

- K28: Articulating Keyboard w/ Mouse - \$390
- K31-SK: Center drawer w/ skirt - \$310
- K31: Center drawer w/o skirt - \$205

Concealed Floor Power Infeed Cover

- PCEB: White Metal Finish concealed floor power infeed cover - \$150

Delete Top and Wire Tray

- DFP: Delete fixed top. Deduct \$1335 Veneer (W), \$1165 High Pressure Laminate (G), \$840 Thermally Fused Laminate (M) per top

Metal Feet

- MTL10: Replace solid wood feet with metal feet, standard MFW White - \$55 ea

Premium Metal Finish

- Specify premium Metal Finish. MFMB: Matte Black, MFS: Silver, MFSS: Salmon Sienna, MFSA: Surfing Aquavert, MFPS: Pistachio, MFOS: Oyster, MFNA: Navy, MFOL: Olive, MFGB: Grey Beige MFGG: Graphite Gray, MFG: Gray, MFGM:Matte Gold
- Premium Metal Finish for WMT Wire Management Tray - \$75 ea
- Premium Metal Finish for MTL10 Metal Feet - \$20 ea
- Premium Metal Finish for PCEB Concealed Floor Power Infeed Cover - \$35

Starter Panel

- RSP: Substitute round starter panel in place of flat starter panel. Must substitute all starters, priced per starter panel - \$83 each. See HNY3555SP888

Telecom Plates

- Each power unit has 1 plate. All telecom connectors sold separately.
- RJ45 (1) - \$55, RJ45 (2) - \$110, RJ45 (3) - \$165, USB (1) - \$70, USB (2) - \$140, RJ45/USB - \$125, RJ45/HDMI - \$210, HDMI/USB - \$205

Worksurface Height

- THL-42: Modify worksurface height to bar height - N/C

Facing Diagonal Workstation Typical
Position 1 with Height Adjustable Worksurface

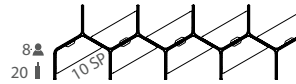
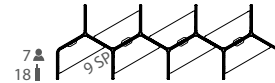
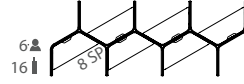
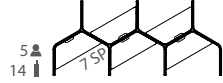
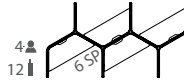

2

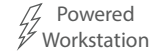
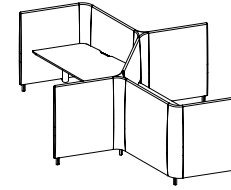

Number of Feet per Typical (MTL10 Option) "SP" Number of Starter Panels per Typical (RSP Option)

1 Select Model

w" x d" x h"	Weight	Standard Veneer Top Upholstered Panels - COM\$	Premium Veneer Top Upholstered Panels - COM\$	High Pressure Laminate Top Upholstered Panels - COM\$	Thermally Fused Laminate Top Upholstered Panels - COM\$
340 x 101 x 55	71	8 HNY340101HA573W 58841	"P" Option N/A	HNY340101HA573G 57233	HNY340101HA573M 54177
303 x 101 x 55	64	7 HNY303101HA573W 51918	"P" Option N/A	HNY303101HA573G 50511	HNY303101HA573M 47837
265 x 101 x 55	56	6 HNY265101HA573W 45266	"P" Option N/A	HNY265101HA573G 44060	HNY265101HA573M 41768
228 x 101 x 55	49	5 HNY228101HA573W 38343	"P" Option N/A	HNY228101HA573G 37338	HNY228101HA573M 35428
191 x 101 x 55	41	4 HNY191101HA573W 31691	"P" Option N/A	HNY191101HA573G 30887	HNY191101HA573M 29359
153 x 101 x 55	34	3 HNY153101HA573W 24768	"P" Option N/A	HNY153101HA573G 24165	HNY153101HA573M 23019
116 x 101 x 55	26	2 HNY116101HA573W 18116	"P" Option N/A	HNY116101HA573G 17714	HNY116101HA573M 16950

[Click Here for Graded in Pricing](#)

2 Select Finish

Click to view finishes

WWP	WOW
PO01	WNO
PO02	WSO
PO03	WNF(Natural Oak on Flat Cut)
PO07	WSF(Salted Oak on Flat Cut)
PO08	WSF(Salted Oak on Flat Cut)
PO09	WSF(Salted Oak on Flat Cut)
WBW	
WSW	
WEC	

3 Select Feet Finish

Click to view edges

WWP	WOW
PO01	WNO
PO02	WSO
PO03	
PO07	
PO08	
PO09	
WBW	
WSW	
WEC	

4 Select Edge

Click to view details

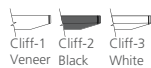

[Click here to view statement of line](#)

Product Features

- 5" Solid wood feet - oval shape, ships KD
- 4 Power outlets with 1 telecom plate, see options below for telecom plate
- Adjustable height from 27" to 47.5" with a maximum weight capacity of 275 lbs.
- Lift standard in MFW White, optional MFB Black
- HNY7125WT163 Height Adjustable worksurfaces are included
- Wire management tray attaches to worksurface top, standard in MFW White, see premium Metal Finish for options
- T75 worksurface wire cutout is standard on all worksurfaces.(T75D: Delete cutout is optional)

Notes

- 1" Gap between worksurface and panels to drop wires below worksurface
- Metal parts include 5 year warranty
- Programmable height adjustable mechanism, motor includes 2 year warranty

Options

Accessories

- K28: Articulating Keyboard w/ Mouse - \$390
- K31-SK: Center drawer w/ skirt - \$310
- K31: Center drawer w/o skirt - \$205

Concealed Floor Power Infeed Cover

- PCEB: White Metal Finish concealed floor power infeed cover - \$150

Delete Top and Wire Tray

- DHAT: Delete height adjustable top. Deduct \$3265 Veneer(W), \$3095 High Pressure Laminate(G), \$2770 Thermally Fused Laminate(M) per top

Metal Feet

- MTL10: Replace solid wood feet with metal feet, standard MFW White - \$55 ea

Premium Metal Finish

- Specify premium Metal Finish. MFMB: Matte Black, MFS: Silver, MFSS: Salmon Sienna, MFSA: Surfin Aquavert, MFPS: Pistachio, MFOS: Oyster, MFNA: Navy, MFOL: Olive, MFGB: Grey Beige MFGG: Graphite Gray, MFG: Gray, MFGM:Matte Gold
- Premium Metal Finish for WMT Wire Management Tray - \$75 ea
- Premium Metal Finish for MTL10 Metal Feet - \$20 ea
- Premium Metal Finish for PCEB Concealed Floor Power Infeed Cover - \$35

Starter Panel

- RSP: Substitute round starter panel in place of flat starter panel. Must substitute all starters, priced per starter panel - \$83 each. See HNY3555SP888

Telecom Plates

- Each power unit has 1 plate. All telecom connectors sold separately.
- RJ45 (1) - \$55, RJ45 (2) - \$110, RJ45 (3) - \$165, USB (1) - \$70, USB (2) - \$140, RJ45/USB - \$125, RJ45/HDMI - \$210, HDMI/USB - \$205

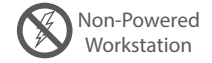
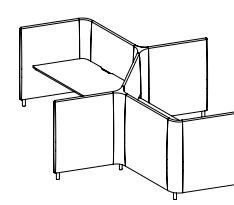
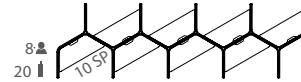
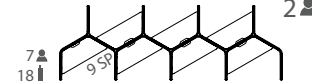
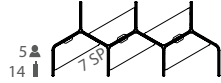
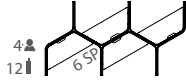
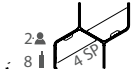

Number of Feet per Typical (MTL10 Option) "SP" Number of Starter Panels per Typical (RSP Option)

1 Select Model

w" x d" x h"	Weight	Standard Veneer Top Upholstered Panels - COM\$	Premium Veneer Top Upholstered Panels - COM\$
340 x 101 x 55	71	8 HNY340101FT573W 37836	"P" Option N/A
303 x 101 x 55	64	7 HNY303101FT573W 33616	"P" Option N/A
265 x 101 x 55	56	6 HNY265101FT573W 29396	"P" Option N/A
228 x 101 x 55	49	5 HNY228101FT573W 25176	"P" Option N/A
191 x 101 x 55	41	4 HNY191101FT573W 20956	"P" Option N/A
153 x 101 x 55	34	3 HNY153101FT573W 16736	"P" Option N/A
116 x 101 x 55	26	2 HNY116101FT573W 12516	"P" Option N/A

[Click Here for Graded in Pricing](#)

2 Select Finish

Click to view finishes

WWP	WOW
PO01	WNO
PO02	WSO
PO03	WNF(Natural Oak on Flat Cut)
PO07	WSF(Salted Oak on Flat Cut)
PO08	
PO09	
WBW	
WSW	
WEC	

3 Select Feet Finish

Click to view edges

WWP	WOW
PO01	WNO
PO02	WSO
PO03	
PO07	
PO08	
PO09	
WBW	
WSW	
WEC	

4 Select Edge

Click to view details

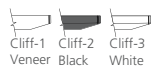

GEC	LW05
GWL	LW06
LP01	
LF02	
LF03	
LN01	
LA02	
LW01	
LW02	
LW04	

WWP	WOW
PO01	WNO
PO02	WSO
PO03	
PO07	
PO08	
PO09	
WBW	
WSW	
WEC	



MOC
MEC
MSW
MTW
MWL
MNA

WWP	WOW
PO01	WNO
PO02	WSO
PO03	
PO07	
PO08	
PO09	
WBW	
WSW	



[Click here to view statement of line](#)

Product Features

- 5" Solid wood feet - oval shape
- HNY7226WT162 Fixed Desk Height worksurfaces, 29" worksurface height
- Ships KD
- T75 worksurface wire cutout is standard on all worksurfaces.(T75D: Delete cutout is optional)

Options

Accessories

- K28: Articulating Keyboard w/ Mouse - \$390
- K31-SK: Center drawer w/ skirt - \$310
- K31: Center drawer w/o skirt - \$205

Concealed Floor Power Infeed Cover

- PCEB: White Metal Finish concealed floor power infeed cover - \$150

Delete Top

- DFT: Delete fixed top. Deduct \$1125 Veneer(W), \$955 High Pressure Laminate (G), \$630 Thermally Fused Laminate (M) per top

Metal Feet

- MTL10: Replace solid wood feet with metal feet, standard MFW White - \$55 ea

Premium Metal Finish

- Specify premium Metal Finish. MFMB: Matte Black, MFS: Silver, MFSS: Salmon Sienna, MFSA: Surfing Aquavert, MFPS: Pistachio, MFOS: Oyster, MFNA: Navy, MFOL: Olive, MFGB: Grey Beige MFGG: Graphite Gray, MFG: Gray, MFGM:Matte Gold
- Premium Metal Finish for WMT Wire Management Tray - \$75 ea
- Premium Metal Finish for MTL10 Metal Feet - \$20 ea
- Premium Metal Finish for PCEB Concealed Floor Power Infeed Cover - \$35

Starter Panel

- RSP: Substitute round starter panel in place of flat starter panel. Must substitute all starters, priced per starter panel - \$83 each. See HNY3555SP888

Worksurface Height

- Modify worksurface height to bar height.
- THL-42: Position worksurface at bar height - N/C

Wire Tray

- WMT: Wire metal tray. Mounts under top and comes standard in MFW White - \$210

Facing Diagonal Workstation Typical
Position 1 Desk with Power Fixed Worksurface

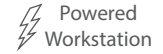
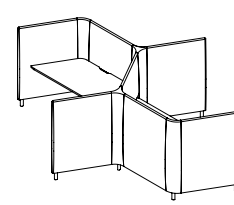
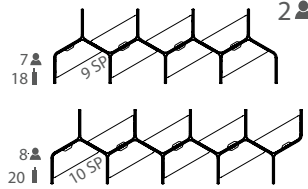
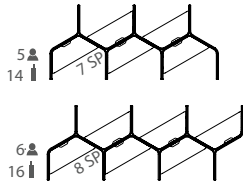
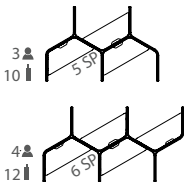
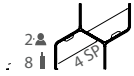

Number of Feet per Typical (MTL10 Option) "SP" Number of Starter Panels per Typical (RSP Option)

1 Select Model

w" x d" x h"	Weight	Standard Veneer Top Upholstered Panels - COM\$	Premium Veneer Top Upholstered Panels - COM\$	High Pressure Laminate Top Upholstered Panels - COM\$	Thermally Fused Laminate Top Upholstered Panels - COM\$
340 x 101 x 55	71	8 HNY340101FP573W 40513	"P" Option N/A	HNY340101FP573G 38913	HNY340101FP573M 35857
303 x 101 x 55	64	7 HNY303101FP573W 35881	"P" Option N/A	HNY303101FP573G 34481	HNY303101FP573M 31807
265 x 101 x 55	56	6 HNY265101FP573W 31520	"P" Option N/A	HNY265101FP573G 30320	HNY265101FP573M 28028
228 x 101 x 55	49	5 HNY228101FP573W 26888	"P" Option N/A	HNY228101FP573G 25888	HNY228101FP573M 23978
191 x 101 x 55	41	4 HNY191101FP573W 22527	"P" Option N/A	HNY191101FP573G 21727	HNY191101FP573M 20199
153 x 101 x 55	34	3 HNY153101FP573W 17895	"P" Option N/A	HNY153101FP573G 17295	HNY153101FP573M 16149
116 x 101 x 55	26	2 HNY116101FP573W 13534	"P" Option N/A	HNY116101FP573G 13134	HNY116101FP573M 12370

[Click Here for Graded in Pricing](#)

2 Select Finish

Click to view finishes

WWP	WOW
PO01	WNO
PO02	WSO
PO03	WNF(Natural Oak on Flat Cut)
PO07	WSF(Salted Oak on Flat Cut)
PO08	WSF(Salted Oak on Flat Cut)
PO09	WSF(Salted Oak on Flat Cut)
WBW	
WSW	
WEC	

3 Select Feet Finish

Click to view edges

WWP	WOW
PO01	WNO
PO02	WSO
PO03	
PO07	
PO08	
PO09	
WBW	
WSW	
WEC	

4 Select Edge

Click to view details

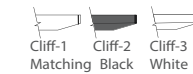
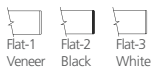

[Click here to view statement of line](#)

Product Features

- HNY7226WT162 Fixed Desk Height worksurfaces, 29" worksurface height
- 5" Solid wood feet - oval shape
- 4 Power outlets with 1 telecom plate, see options below for telecom plate
- Ships KD
- Wire management tray attaches to worksurface top, standard in MFW White, see premium Metal Finish for options
- Hardwire infeed and jumpers are included in workstations
- T75 worksurface wire cutout is standard on all worksurfaces.(T75D: Delete cutout is optional)

Options

Accessories

- K28: Articulating Keyboard w/ Mouse - \$390
- K31-SK: Center drawer w/ skirt - \$310
- K31: Center drawer w/o skirt - \$205

Concealed Floor Power Infeed Cover

- PCEB: White Metal Finish concealed floor power infeed cover - \$150

Delete Top and Wire Tray

- DFP: Delete fixed top. Deduct \$1335 Veneer (W), \$1165 High Pressure Laminate (G), \$840 Thermally Fused Laminate (M) per top

Metal Feet

- MTL10: Replace solid wood feet with metal feet, standard MFW White - \$55 ea

Premium Metal Finish

- Specify premium Metal Finish. MFMB: Matte Black, MFS: Silver, MFSS: Salmon Sienna, MFSA: SurfIn Aquavert, MFPS: Pistachio, MFOS: Oyster, MFNA: Navy, MFOL: Olive, MFGB: Grey Beige MFGG: Graphite Gray, MFG: Gray, MFGM:Matte Gold
- Premium Metal Finish for WMT Wire Management Tray - \$75 ea
- Premium Metal Finish for MTL10 Metal Feet - \$20 ea
- Premium Metal Finish for PCEB Concealed Floor Power Infeed Cover - \$35

Starter Panel

- RSP: Substitute round starter panel in place of flat starter panel. Must substitute all starters, priced per starter panel - \$83 each. See HNY3555SP888

Telecom Plates

- Each power unit has 1 plate. All telecom connectors sold separately.
- RJ45 (1) - \$55, RJ45 (2) - \$110, RJ45 (3) - \$165, USB (1) - \$70, USB (2) - \$140, RJ45/USB - \$125, RJ45/HDMI - \$210, HDMI/USB - \$205

Worksurface Height

- THL-42: Modify worksurface height to bar height - N/C

Facing Diagonal Workstation Typical
Position 2 Desk with Height Adjustable Worksurface

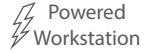
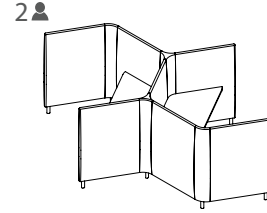
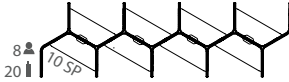
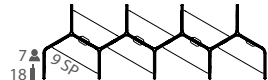
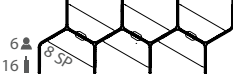
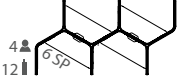
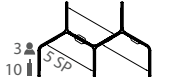

Number of Feet per Typical (MTL10 Option) "SP" Number of Starter Panels per Typical (RSP Option)

1 Select Model

Table with columns: w" x d" x h", Weight, Standard Veneer Top Upholstered Panels - COM\$, Premium Veneer Top Upholstered Panels - COM\$, High Pressure Laminate Top Upholstered Panels - COM\$, Thermally Fused Laminate Top Upholstered Panels - COM\$.

Click Here for Graded in Pricing

2 Select Finish

Click to view finishes

Table with columns: WWP, WOV, PO01, WNO, PO02, WSO, PO03, WNF(Natural Oak on Flat Cut), PO07, WSF(Salted Oak on Flat Cut), PO08, PO09, WBW, WSW, WEC.

3 Select Feet Finish

Click to view edges

Table with columns: WWP, WOV, PO01, WNO, PO02, WSO, PO03, PO07, PO08, PO09, WBW, WSW, WEC.

4 Select Edge

Click to view details

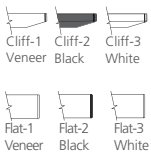
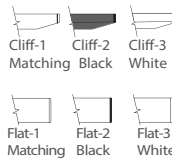

Table with columns: GEC, LW05, GWL, LW06, LP01, LF02, LF03, LN01, LA02, LW01, LW02, LW04.

Table with columns: MOC, MEC, MSW, MTW, MWL, MNA.

Table with columns: WWP, WOV, PO01, WNO, PO02, WSO, PO03, PO07, PO08, PO09, WBW, WSW, WEC.

Table with columns: WWP, WOV, PO01, WNO, PO02, WSO, PO03, PO07, PO08, PO09, WBW, WSW.



Click here to view statement of line

Product Features

- 5" Solid wood feet - oval shape, ships KD
- 4 Power outlets with 1 telecom plate, see options below for telecom plate
- Adjustable height from 27" to 47.5" with a maximum weight capacity of 275 lbs.
Lift standard in MFW White, optional MFB Black
- HNY7125WT163 Height Adjustable worksurfaces are included
- Wire management tray attaches to worksurface top, standard in MFW White, see premium Metal Finish for options
- T75 worksurface wire cutout is standard on all worksurfaces.(T75D: Delete cutout is optional)

Notes

- 1" Gap between worksurface and panels to drop wires below worksurface
- Metal parts include 5 year warranty
- Programmable height adjustable mechanism, motor includes 2 year warranty

Options

Accessories

- K28: Articulating Keyboard w/ Mouse - \$390
- K31-SK: Center drawer w/ skirt - \$310
- K31: Center drawer w/o skirt - \$205

Concealed Floor Power Infeed Cover

- PCEB: White Metal Finish concealed floor power infeed cover - \$150

Delete Top and Wire Tray

- DHAT: Delete height adjustable top. Deduct \$3265 Veneer(W), \$3095 High Pressure Laminate(G), \$2770 Thermally Fused Laminate(M) per top

Metal Feet

- MTL10: Replace solid wood feet with metal feet, standard MFW White - \$55 ea

Premium Metal Finish

- Specify premium Metal Finish. MFMB: Matte Black, MFS: Silver, MFSS: Salmon Sienna, MFSA: Surfin Aquavert, MFPS: Pistachio, MFOS: Oyster, MFNA: Navy, MFOL: Olive, MFGB: Grey Beige MFGG: Graphite Gray, MFG: Gray, MFGM:Matte Gold
- Premium Metal Finish for WMT Wire Management Tray - \$75 ea
- Premium Metal Finish for MTL10 Metal Feet - \$20 ea
- Premium Metal Finish for PCEB Concealed Floor Power Infeed Cover - \$35

Starter Panel

- RSP: Substitute round starter panel in place of flat starter panel. Must substitute all starters, priced per starter panel - \$83 each. See HNY3555SP888

Telecom Plates

- Each power unit has 1 plate. All telecom connectors sold separately.
- RJ45 (1) - \$55, RJ45 (2) - \$110, RJ45 (3) - \$165, USB (1) - \$70, USB (2) - \$140, RJ45/USB - \$125, RJ45/HDMI - \$210, HDMI/USB - \$205

Facing Diagonal Workstation Typical
Position 2 Desk with Fixed Worksurface

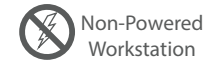
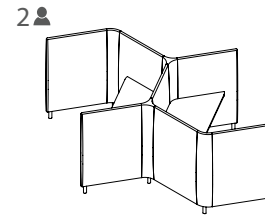
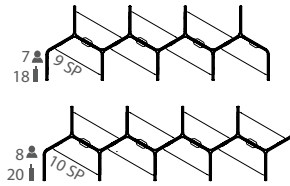
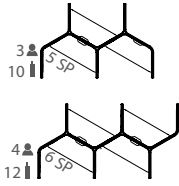

Number of Feet per Typical (MTL10 Option) "SP" Number of Starter Panels per Typical (RSP Option)

1 Select Model

w" x d" x h"	Weight	Standard Veneer Top Upholstered Panels - COM\$	Premium Veneer Top Upholstered Panels - COM\$
340 x 101 x 55	71	8 HNY340101FT574W 37836	"P" Option N/A
303 x 101 x 55	64	7 HNY303101FT574W 33616	"P" Option N/A
265 x 101 x 55	56	6 HNY265101FT574W 29396	"P" Option N/A
228 x 101 x 55	49	5 HNY228101FT574W 25176	"P" Option N/A
191 x 101 x 55	41	4 HNY191101FT574W 20956	"P" Option N/A
153 x 101 x 55	34	3 HNY153101FT574W 16736	"P" Option N/A
116 x 101 x 55	26	2 HNY116101FT574W 12516	"P" Option N/A

[Click Here for Graded in Pricing](#)

2 Select Finish

Click to view finishes

WWP	WOW
PO01	WNO
PO02	WSO
PO03	WNF(Natural Oak on Flat Cut)
PO07	WSF(Salted Oak on Flat Cut)
PO08	WSF(Salted Oak on Flat Cut)
PO09	WSF(Salted Oak on Flat Cut)
WBW	
WSW	
WEC	

3 Select Feet Finish

Click to view edges

WWP	WOW
PO01	WNO
PO02	WSO
PO03	
PO07	
PO08	
PO09	
WBW	
WSW	
WEC	

4 Select Edge

Click to view details

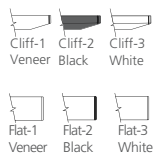

High Pressure Laminate Top Upholstered Panels - COM\$

HNY340101FT574G	36236
HNY303101FT574G	32216
HNY265101FT574G	28196
HNY228101FT574G	24176
HNY191101FT574G	20156
HNY153101FT574G	16136
HNY116101FT574G	12116

GEC	LW05
GWL	LW06
LP01	
LF02	
LF03	
LN01	
LA02	
LW01	
LW02	
LW04	

WWP	WOW
PO01	WNO
PO02	WSO
PO03	
PO07	
PO08	
PO09	
WBW	
WSW	
WEC	

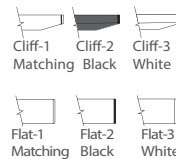

Thermally Fused Laminate Top Upholstered Panels - COM\$

HNY340101FT574M	33180
HNY303101FT574M	29542
HNY265101FT574M	25904
HNY228101FT574M	22266
HNY191101FT574M	18628
HNY153101FT574M	14990
HNY116101FT574M	11352

MOC
MEC
MSW
MTW
MWL
MNA

WWP	WOW
PO01	WNO
PO02	WSO
PO03	
PO07	
PO08	
PO09	
WBW	
WSW	



[Click here to view statement of line](#)

Product Features

- 5" Solid wood feet - oval shape
- HNY7226WT162 Fixed Desk Height worksurfaces, 29" worksurface height
- Ships KD
- T75 worksurface wire cutout is standard on all worksurfaces.(T75D: Delete cutout is optional)

Options

Accessories

- K28: Articulating Keyboard w/ Mouse - \$390
- K31-SK: Center drawer w/ skirt - \$310
- K31: Center drawer w/o skirt - \$205

Concealed Floor Power Infeed Cover

- PCEB: White Metal Finish concealed floor power infeed cover - \$150

Delete Top

- DFT: Delete fixed top. Deduct \$1125 Veneer(W), \$955 High Pressure Laminate (G), \$630 Thermally Fused Laminate (M) per top

Metal Feet

- MTL10: Replace solid wood feet with metal feet, standard MFW White - \$55 ea

Premium Metal Finish

- Specify premium Metal Finish. MFMB: Matte Black, MFS: Silver, MFSS: Salmon Sienna, MFSA: Surfing Aquavert, MFPS: Pistachio, MFOS: Oyster, MFNA: Navy, MFOL: Olive, MFGB: Grey Beige MFGG: Graphite Gray, MFG: Gray, MFGM:Matte Gold
- Premium Metal Finish for WMT Wire Management Tray - \$75 ea
- Premium Metal Finish for MTL10 Metal Feet - \$20 ea
- Premium Metal Finish for PCEB Concealed Floor Power Infeed Cover - \$35

Starter Panel

- RSP: Substitute round starter panel in place of flat starter panel. Must substitute all starters, priced per starter panel - \$83 each. See HNY3555SP888

Worksurface Height

- Modify worksurface height to bar height.
- THL-42: Position worksurface at bar height - N/C

Wire Tray

- WMT: Wire metal tray. Mounts under top and comes standard in MFW White - \$210

Facing Diagonal Workstation Typical
Position 2 Desk with Power Fixed Worksurface

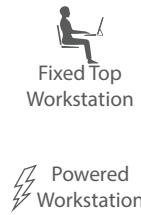
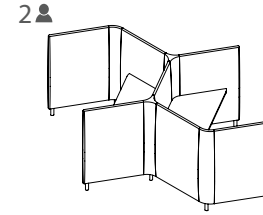
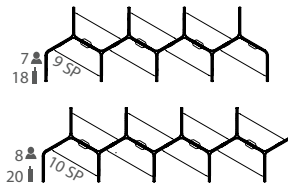
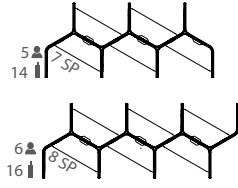
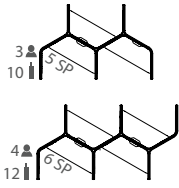

Number of Feet per Typical (MTL10 Option) "SP" Number of Starter Panels per Typical (RSP Option)

1 Select Model

w" x d" x h"	Weight	Standard Veneer Top Upholstered Panels - COM\$	Premium Veneer Top Upholstered Panels - COM\$
340 x 101 x 55	71	8 HNY340101FP574W 40242	"P" Option N/A
303 x 101 x 55	64	7 HNY303101FP574W 35881	"P" Option N/A
265 x 101 x 55	56	6 HNY265101FP574W 31249	"P" Option N/A
228 x 101 x 55	49	5 HNY228101FP574W 26888	"P" Option N/A
191 x 101 x 55	41	4 HNY191101FP574W 22256	"P" Option N/A
153 x 101 x 55	34	3 HNY153101FP574W 17895	"P" Option N/A
116 x 101 x 55	26	2 HNY116101FP574W 13263	"P" Option N/A

[Click Here for Graded in Pricing](#)

2 Select Finish

Click to view finishes

WWP	WOW
PO01	WNO
PO02	WSO
PO03	WNF(Natural Oak on Flat Cut)
PO07	WSF(Salted Oak on Flat Cut)
PO08	WSF(Salted Oak on Flat Cut)
PO09	WSF(Salted Oak on Flat Cut)
WBW	
WSW	
WEC	

3 Select Feet Finish

Click to view edges

WWP	WOW
PO01	WNO
PO02	WSO
PO03	
PO07	
PO08	
PO09	
WBW	
WSW	
WEC	

4 Select Edge

Click to view details

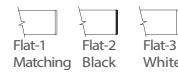
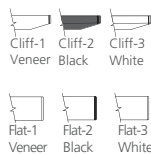

GEC	LW05
GWL	LW06
LP01	
LF02	
LF03	
LN01	
LA02	
LW01	
LW02	
LW04	

WWP	WOW
PO01	WNO
PO02	WSO
PO03	
PO07	
PO08	
PO09	
WBW	
WSW	
WEC	

MOC
MEC
MSW
MTW
MWL
MNA

WWP	WOW
PO01	WNO
PO02	WSO
PO03	
PO07	
PO08	
PO09	
WEC	
WBW	
WSW	

High Pressure Laminate Top Upholstered Panels - COM\$

HNY340101FP574G	38642
HNY303101FP574G	34481
HNY265101FP574G	30049
HNY228101FP574G	25888
HNY191101FP574G	21456
HNY153101FP574G	17295
HNY116101FP574G	12863

Thermally Fused Laminate Top Upholstered Panels - COM\$

HNY340101FP574M	35586
HNY303101FP574M	31807
HNY265101FP574M	27757
HNY228101FP574M	23978
HNY191101FP574M	19928
HNY153101FP574M	16149
HNY116101FP574M	12099

[Click here to view statement of line](#)

Product Features

- HNY7226WT162 Fixed Desk Height worksurfaces, 29" worksurface height
- 5" Solid wood feet - oval shape
- 4 Power outlets with 1 telecom plate, see options below for telecom plate
- Ships KD
- Wire management tray attaches to worksurface top, standard in MFW White, see premium Metal Finish for options
- Hardwire infeed and jumpers are included in workstations
- T75 worksurface wire cutout is standard on all worksurfaces.(T75D: Delete cutout is optional)

Options

Accessories

- K28: Articulating Keyboard w/ Mouse - \$390
- K31-SK: Center drawer w/ skirt - \$310
- K31: Center drawer w/o skirt - \$205

Concealed Floor Power Infeed Cover

- PCEB: White Metal Finish concealed floor power infeed cover - \$150

Delete Top and Wire Tray

- DFP: Delete fixed top. Deduct \$1335 Veneer (W), \$1165 High Pressure Laminate (G), \$840 Thermally Fused Laminate (M) per top

Metal Feet

- MTL10: Replace solid wood feet with metal feet, standard MFW White - \$55 ea

Premium Metal Finish

- Specify premium Metal Finish. MFMB: Matte Black, MFS: Silver, MFSS: Salmon Sienna, MFSA: Surfing Aquavert, MFPS: Pistachio, MFOS: Oyster, MFNA: Navy, MFOL: Olive, MFGB: Grey Beige MFGG: Graphite Gray, MFG: Gray, MFGM:Matte Gold
- Premium Metal Finish for WMT Wire Management Tray - \$75 ea
- Premium Metal Finish for MTL10 Metal Feet - \$20 ea
- Premium Metal Finish for PCEB Concealed Floor Power Infeed Cover - \$35

Starter Panel

- RSP: Substitute round starter panel in place of flat starter panel. Must substitute all starters, priced per starter panel - \$83 each. See HNY3555SP888

Telecom Plates

- Each power unit has 1 plate. All telecom connectors sold separately.
- RJ45 (1) - \$55, RJ45 (2) - \$110, RJ45 (3) - \$165, USB (1) - \$70, USB (2) - \$140, RJ45/USB - \$125, RJ45/HDMI - \$210, HDMI/USB - \$205

Worksurface Height

- THL-42: Modify worksurface height to bar height - N/C

4
8

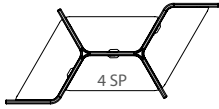

8
14

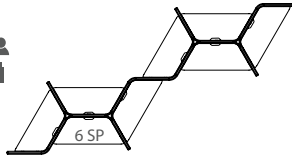

4
8

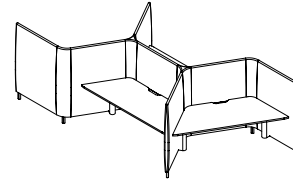

Height Adjustable Workstation



Number of Feet per Typical (MTL10 Option) "SP" Number of Starter Panels per Typical (RSP Option)

1 Select Model

Weight	Standard Veneer Top Upholstered Panels - COM\$
295 x 153 x 55	8 HNY295153HA575W 51214
166 x 78 x 55	4 HNY16678HA575W 26101

Premium Veneer Top Upholstered Panels - COM\$
"P" Option N/A
"P" Option N/A

High Pressure Laminate Top Upholstered Panels - COM\$
HNY295153HA575G 49606
HNY16678HA575G 25297

Thermally Fused Laminate Top Upholstered Panels - COM\$
HNY295153HA575M 46550
HNY16678HA575M 23769

[Click here to view statement of line](#)

Product Features

- 5" Solid wood feet - oval shape, ships KD
- 4 Power outlets with 1 telecom plate, see options below for telecom plate
- Adjustable height from 27" to 47.5" with a maximum weight capacity of 275 lbs.
- Lift standard in MFW White, optional MFB Black
- HNY7125WT163 Height Adjustable worksurfaces are included
- Wire management tray attaches to worksurface top, standard in MFW White, see premium Metal Finish for options
- T75 worksurface wire cutout is standard on all worksurfaces.(T75D: Delete cutout is optional)

Notes

- 1" Gap between worksurface and panels to drop wires below worksurface
- Metal parts include 5 year warranty
- Programmable height adjustable mechanism, motor includes 2 year warranty

Options

Accessories

- K28: Articulating Keyboard w/ Mouse - \$390
- K31-SK: Center drawer w/ skirt - \$310
- K31: Center drawer w/o skirt - \$205

Concealed Floor Power Infeed Cover

- PCEB: White Metal Finish concealed floor power infeed cover - \$150

Delete Top and Wire Tray

- DHAT: Delete height adjustable top. Deduct \$3265 Veneer(W), \$3095 High Pressure Laminate(G), \$2770 Thermally Fused Laminate(M) per top

Metal Feet

- MTL10: Replace solid wood feet with metal feet, standard MFW White - \$55 ea

Premium Metal Finish

- Specify premium Metal Finish. MFMB: Matte Black, MFS: Silver, MFSS: Salmon Sienna, MFSA: Surfing Aquavert, MFPS: Pistachio, MFOS: Oyster, MFNA: Navy, MFOL: Olive, MFGB: Grey Beige MFGG: Graphite Gray, MFG: Gray, MFGM:Matte Gold
- Premium Metal Finish for WMT Wire Management Tray - \$75 ea
- Premium Metal Finish for MTL10 Metal Feet - \$20 ea
- Premium Metal Finish for PCEB Concealed Floor Power Infeed Cover - \$35

Starter Panel

- RSP: Substitute round starter panel in place of flat starter panel. Must substitute all starters, priced per starter panel - \$83 each. See HNY3555SP888

Telecom Plates

- Each power unit has 1 plate. All telecom connectors sold separately.
- RJ45 (1) - \$55, RJ45 (2) - \$110, RJ45 (3) - \$165, USB (1) - \$70, USB (2) - \$140, RJ45/USB - \$125, RJ45/HDMI - \$210, HDMI/USB - \$205

[Click Here for Graded in Pricing](#)

2 Select Finish

Click to view finishes

WWP	WOW
PO01	WNO
PO02	WSO
PO03	WNF(Natural Oak on Flat Cut)
PO07	WSF(Salted Oak on Flat Cut)
PO08	WSF(Salted Oak on Flat Cut)
PO09	WSF(Salted Oak on Flat Cut)
WBW	
WSW	
WEC	

3 Select Feet Finish

Click to view edges

WWP	WOW
PO01	WNO
PO02	WSO
PO03	
PO07	
PO08	
PO09	
WBW	
WSW	
WEC	

4 Select Edge

Click to view details

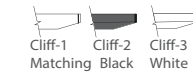
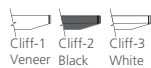

4
8

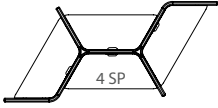

8
14

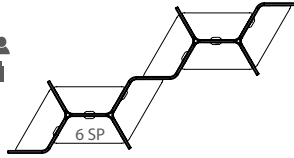

4
8

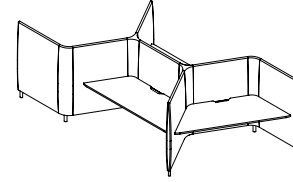

Fixed Top
Workstation

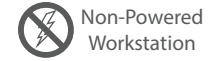

Non-Powered
Workstation

Number of Feet per Typical (MTL10 Option) "SP" Number of Starter Panels per Typical (RSP Option)

1 Select Model

Weight	Standard Veneer Top Upholstered Panels - COM\$
295 x 153 x 55	8 HNY295153FT575W 30336
166 x 78 x 55	4 HNY16678FT575W 15624

Premium Veneer Top Upholstered Panels - COM\$

"P" Option N/A
"P" Option N/A

High Pressure Laminate Top Upholstered Panels - COM\$

HNY295153FT575G 28736
HNY16678FT575G 14824

Thermally Fused Laminate Top Upholstered Panels - COM\$

HNY295153FT575M 25680
HNY16678FT575M 13296

Product Features

- 5" Solid wood feet - oval shape
- HNY7226WT162 Fixed Desk Height worksurfaces, 29" worksurface height
- Ships KD
- T75 worksurface wire cutout is standard on all worksurfaces.(T75D: Delete cutout is optional)

Options

Accessories

- K28: Articulating Keyboard w/ Mouse - \$390
- K31-SK: Center drawer w/ skirt - \$310
- K31: Center drawer w/o skirt - \$205

Concealed Floor Power Infeed Cover

- PCEB: White Metal Finish concealed floor power infeed cover - \$150

Delete Top

- DFT: Delete fixed top. Deduct \$1125 Veneer(W), \$955 High Pressure Laminate (G), \$630 Thermally Fused Laminate (M) per top

Metal Feet

- MTL10: Replace solid wood feet with metal feet, standard MFW White - \$55 ea

Premium Metal Finish

- Specify premium Metal Finish. MFMB: Matte Black, MFS: Silver, MFSS: Salmon Sienna, MFSA: Surfing Aquavert, MFPS: Pistachio, MFOS: Oyster, MFNA: Navy, MFOL: Olive, MFGB: Grey Beige MFGG: Graphite Gray, MFG: Gray, MFGM:Matte Gold
- Premium Metal Finish for WMT Wire Management Tray - \$75 ea
- Premium Metal Finish for MTL10 Metal Feet - \$20 ea
- Premium Metal Finish for PCEB Concealed Floor Power Infeed Cover - \$35

Starter Panel

- RSP: Substitute round starter panel in place of flat starter panel. Must substitute all starters, priced per starter panel - \$83 each. See HNY3555SP888

Worksurface Height

- Modify worksurface height to bar height.
- THL-42: Position worksurface at bar height - N/C

Wire Tray

- WMT: Wire metal tray. Mounts under top and comes standard in MFW White - \$210

[Click Here for Graded in Pricing](#)

2 Select Finish

Click to view finishes

WWP	WOW
PO01	WNO
PO02	WSO
PO03	WNF(Natural Oak on Flat Cut)
PO07	WSF(Salted Oak on Flat Cut)
PO08	
PO09	
WBW	
WSW	
WEC	

3 Select Feet Finish

Click to view edges

WWP	WOW
PO01	WNO
PO02	WSO
PO03	
PO07	
PO08	
PO09	
WBW	
WSW	
WEC	

4 Select Edge

Click to view details



4
8



Number of Feet per Typical (MTL10 Option) "SP" Number of Starter Panels per Typical (RSP Option)

8
14

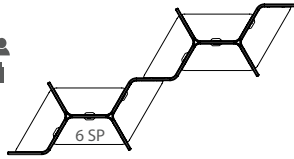

4
8

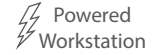
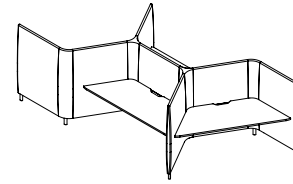

1 Select Model

Weight	Standard Veneer Top Upholstered Panels - COM\$
295 x 153 x 55	8 HNY295153FP575W 32886
166 x 78 x 55	4 HNY16678FP575W 16937

Premium Veneer Top Upholstered Panels - COM\$
"P" Option N/A
"P" Option N/A

High Pressure Laminate Top Upholstered Panels - COM\$
HNY295153FP575G 31286
HNY16678FP575G 16137

Thermally Fused Laminate Top Upholstered Panels - COM\$
HNY295153FP575M 28230
HNY16678FP575M 14609

Product Features

- HNY7226WT162 Fixed Desk Height worksurfaces, 29" worksurface height
- 5" Solid wood feet - oval shape
- 4 Power outlets with 1 telecom plate, see options below for telecom plate
- Ships KD
- Wire management tray attaches to worksurface top, standard in MFW White, see premium Metal Finish for options
- Hardwire infeed and jumpers are included in workstations
- T75 worksurface wire cutout is standard on all worksurfaces.(T75D: Delete cutout is optional)

Options

Accessories

- K28: Articulating Keyboard w/ Mouse - \$390
- K31-SK: Center drawer w/ skirt - \$310
- K31: Center drawer w/o skirt - \$205

Concealed Floor Power Infeed Cover

- PCEB: White Metal Finish concealed floor power infeed cover - \$150

Delete Top and Wire Tray

- DFP: Delete fixed top. Deduct \$1335 Veneer (W), \$1165 High Pressure Laminate (G), \$840 Thermally Fused Laminate (M) per top

Metal Feet

- MTL10: Replace solid wood feet with metal feet, standard MFW White - \$55 ea

Premium Metal Finish

- Specify premium Metal Finish. MFMB: Matte Black, MFS: Silver, MFSS: Salmon Sienna, MFSA: Surfin Aquavert, MFPS: Pistachio, MFOS: Oyster, MFNA: Navy, MFOL: Olive, MFGB: Grey Beige MFGG: Graphite Gray, MFG: Gray, MFGM:Matte Gold
- Premium Metal Finish for WMT Wire Management Tray - \$75 ea
- Premium Metal Finish for MTL10 Metal Feet - \$20 ea
- Premium Metal Finish for PCEB Concealed Floor Power Infeed Cover - \$35

Starter Panel

- RSP: Substitute round starter panel in place of flat starter panel. Must substitute all starters, priced per starter panel - \$83 each. See HNY3555SP888

Telecom Plates

- Each power unit has 1 plate. All telecom connectors sold separately.
- RJ45 (1) - \$55, RJ45 (2) - \$110, RJ45 (3) - \$165, USB (1) - \$70, USB (2) - \$140, RJ45/USB - \$125, RJ45/HDMI - \$210, HDMI/USB - \$205

Worksurface Height

- THL-42: Modify worksurface height to bar height - N/C

[Click Here for Graded in Pricing](#)

2 Select Finish

Click to view finishes

WWP	WOW
PO01	WNO
PO02	WSO
PO03	WNF(Natural Oak on Flat Cut)
PO07	WSF(Salted Oak on Flat Cut)
PO08	WSF(Salted Oak on Flat Cut)
PO09	WSF(Salted Oak on Flat Cut)
WBW	
WSW	
WEC	

3 Select Feet Finish

Click to view edges

WWP	WOW
PO01	WNO
PO02	WSO
PO03	
PO07	
PO08	
PO09	
WBW	
WSW	
WEC	

4 Select Edge

Click to view details



DARRAN

Honey

Inline Hexagon Workstation Typical Position 1 Desk with Height Adjustable Worksurface

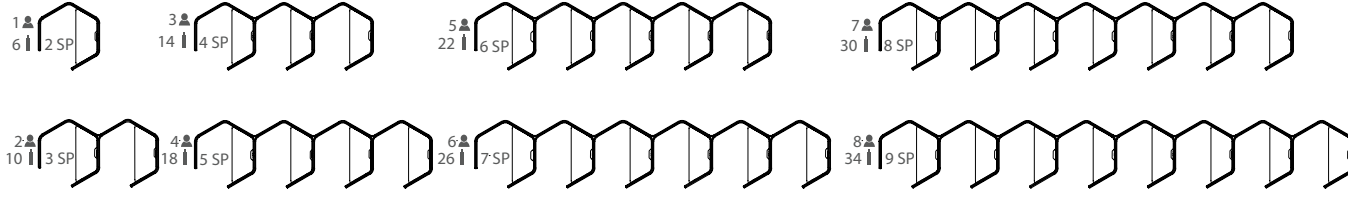

Number of Feet per Typical (MTL10 Option) "SP" Number of Starter Panels per Typical (RSP Option)

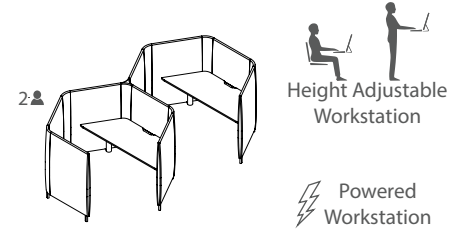

1 Select Model

w" x d" x h"	Weight	Standard Veneer Top Upholstered Panels - COM\$	Premium Veneer Top Upholstered Panels - COM\$	High Pressure Laminate Top Upholstered Panels - COM\$	Thermally Fused Laminate Top Upholstered Panels - COM\$
602 x 86 x 55	128	8 HNY60286HA576W 83710	"P" Option N/A	HNY60286HA576G 82102	HNY60286HA576M 79046
528 x 86 x 55	112	7 HNY52886HA576W 73430	"P" Option N/A	HNY52886HA576G 72023	HNY52886HA576M 69349
453 x 86 x 55	97	6 HNY45386HA576W 63150	"P" Option N/A	HNY45386HA576G 61944	HNY45386HA576M 59652
378 x 86 x 55	81	5 HNY37886HA576W 52870	"P" Option N/A	HNY37886HA576G 51865	HNY37886HA576M 49955
303 x 86 x 55	66	4 HNY30386HA576W 42590	"P" Option N/A	HNY30386HA576G 41786	HNY30386HA576M 40258
228 x 86 x 55	50	3 HNY22886HA576W 32310	"P" Option N/A	HNY22886HA576G 31707	HNY22886HA576M 30561
153 x 86 x 55	35	2 HNY15386HA576W 22030	"P" Option N/A	HNY15386HA576G 21628	HNY15386HA576M 20864
78 x 86 x 55	19	1 HNY7886HA576W 11750	"P" Option N/A	HNY7886HA576G 11549	HNY7886HA576M 11167

2 Select Finish

Click to view finishes

WWP	WOW
PO01	WNO
PO02	WSO
PO03	WNF(Natural Oak on Flat Cut)
PO07	WSF(Salted Oak on Flat Cut)
PO08	WSF(Salted Oak on Flat Cut)
PO09	WSF(Salted Oak on Flat Cut)
WBW	
WSW	
WEC	

3 Select Feet Finish

Click to view edges

WWP	WOW
PO01	WNO
PO02	WSO
PO03	
PO07	
PO08	
PO09	
WBW	
WSW	
WEC	

4 Select Edge

Click to view details



GEC	LW05
GWL	LW06
LP01	
LF02	
LF03	
LN01	
LA02	
LW01	
LW02	
LW04	

WWP	WOW
PO01	WNO
PO02	WSO
PO03	
PO07	
PO08	
PO09	
WBW	
WSW	
WEC	



MOC
MEC
MSW
MTW
MWL
MNA

WWP	WOW
PO01	WNO
PO02	WSO
PO03	
PO07	
PO08	
PO09	
WBW	
WSW	



Click here to view statement of line

Product Features

- 5" Solid wood feet - oval shape, ships KD
- 4 Power outlets with 1 telecom plate, see options below for telecom plate
- Adjustable height from 27" to 47.5" with a maximum weight capacity of 275 lbs.
- Lift standard in MFW White, optional MFB Black
- HNY7125WT163 Height Adjustable worksurfaces are included
- Wire management tray attaches to worksurface top, standard in MFW White, see premium Metal Finish for options
- T75 worksurface wire cutout is standard on all worksurfaces.(T75D: Delete cutout is optional)

Notes

- 1" Gap between worksurface and panels to drop wires below worksurface
- Metal parts include 5 year warranty
- Programmable height adjustable mechanism, motor includes 2 year warranty

Options

Accessories

- K28: Articulating Keyboard w/ Mouse - \$390
- K31-SK: Center drawer w/ skirt - \$310
- K31: Center drawer w/o skirt - \$205

Concealed Floor Power Infeed Cover

- PCEB: White Metal Finish concealed floor power infeed cover - \$150

Delete Top and Wire Tray

- DHAT: Delete height adjustable top. Deduct \$3265 Veneer(W), \$3095 High Pressure Laminate(G), \$2770 Thermally Fused Laminate(M) per top

Metal Feet

- MTL10: Replace solid wood feet with metal feet, standard MFW White - \$55 ea

Premium Metal Finish

- Specify premium Metal Finish. MFMB: Matte Black, MFS: Silver, MFSS: Salmon Sienna, MFSA: Surfin Aquavert, MFPS: Pistachio, MFOS: Oyster, MFNA: Navy, MFOL: Olive, MFGB: Grey Beige MFGG: Graphite Gray, MFG: Gray, MFGM:Matte Gold
- Premium Metal Finish for WMT Wire Management Tray - \$75 ea
- Premium Metal Finish for MTL10 Metal Feet - \$20 ea
- Premium Metal Finish for PCEB Concealed Floor Power Infeed Cover - \$35

Starter Panel

- RSP: Substitute round starter panel in place of flat starter panel. Must substitute all starters, priced per starter panel - \$83 each. See HNY3555SP888

Telecom Plates

- Each power unit has 1 plate. All telecom connectors sold separately.
- RJ45 (1) - \$55, RJ45 (2) - \$110, RJ45 (3) - \$165, USB (1) - \$70, USB (2) - \$140, RJ45/USB - \$125, RJ45/HDMI - \$210, HDMI/USB - \$205

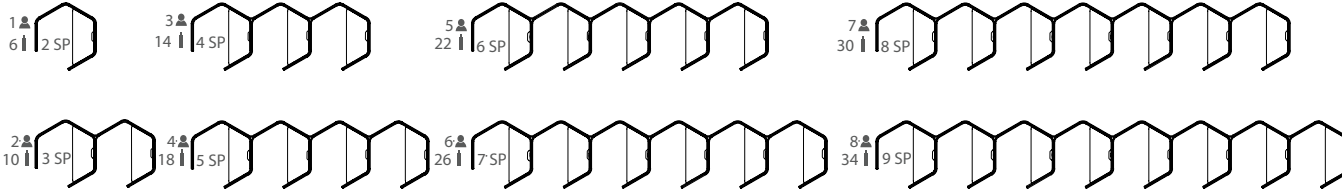

Number of Feet per Typical (MTL10 Option) "SP" Number of Starter Panels per Typical (RSP Option)

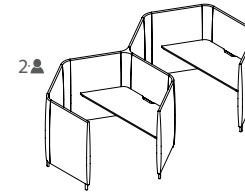

Fixed Top Workstation

Non-Powered Workstation

1 Select Model

w" x d" x h"	Weight	Standard Veneer Top Upholstered Panels - COM\$	Premium Veneer Top Upholstered Panels - COM\$
602 x 86 x 55	128	8 HNY60286FT576W 60482	"P" Option N/A
528 x 86 x 55	112	7 HNY52886FT576W 53098	"P" Option N/A
453 x 86 x 55	97	6 HNY45386FT576W 45714	"P" Option N/A
378 x 86 x 55	81	5 HNY37886FT576W 38330	"P" Option N/A
303 x 86 x 55	66	4 HNY30386FT576W 30946	"P" Option N/A
228 x 86 x 55	50	3 HNY22886FT576W 23562	"P" Option N/A
153 x 86 x 55	35	2 HNY15386FT576W 16178	"P" Option N/A
78 x 86 x 55	19	1 HNY7886FT576W 8794	"P" Option N/A

[Click Here for Graded in Pricing](#)

2 Select Finish

Click to view finishes

WWP	WOW
PO01	WNO
PO02	WSO
PO03	WNF(Natural Oak on Flat Cut)
PO07	WSF(Salted Oak on Flat Cut)
PO08	WSF(Salted Oak on Flat Cut)
PO09	WSF(Salted Oak on Flat Cut)
WBW	
WSW	
WEC	

3 Select Feet Finish

Click to view edges

WWP	WOW
PO01	WNO
PO02	WSO
PO03	
PO07	
PO08	
PO09	
WBW	
WSW	
WEC	

4 Select Edge

Click to view details



High Pressure Laminate Top Upholstered Panels - COM\$

HNY60286FT576G 58882	"P" Option N/A
HNY52886FT576G 51698	"P" Option N/A
HNY45386FT576G 44514	"P" Option N/A
HNY37886FT576G 37330	"P" Option N/A
HNY30386FT576G 30146	"P" Option N/A
HNY22886FT576G 22962	"P" Option N/A
HNY15386FT576G 15778	"P" Option N/A
HNY7886FT576G 8594	"P" Option N/A

GEC LW05
GWL LW06
LP01
LF02
LF03
LN01
LA02
LW01
LW02
LW04

WWP	WOW
PO01	WNO
PO02	WSO
PO03	
PO07	
PO08	
PO09	
WBW	
WSW	
WEC	



Thermally Fused Laminate Top Upholstered Panels - COM\$

HNY60286FT576M 55826	"P" Option N/A
HNY52886FT576M 49024	"P" Option N/A
HNY45386FT576M 42222	"P" Option N/A
HNY37886FT576M 35420	"P" Option N/A
HNY30386FT576M 28618	"P" Option N/A
HNY22886FT576M 21816	"P" Option N/A
HNY15386FT576M 15014	"P" Option N/A
HNY7886FT576M 8212	"P" Option N/A

MOC
MEC
MSW
MTW
MWL
MNA

WWP	WOW
PO01	WNO
PO02	WSO
PO03	
PO07	
PO08	
PO09	
WBW	
WSW	



[Click here to view statement of line](#)

Product Features

- 5" Solid wood feet - oval shape
- HNY7226WT162 Fixed Desk Height worksurfaces, 29" worksurface height
- Ships KD
- T75 worksurface wire cutout is standard on all worksurfaces.(T75D: Delete cutout is optional)

Options

Accessories

- K28: Articulating Keyboard w/ Mouse - \$390
- K31-SK: Center drawer w/ skirt - \$310
- K31: Center drawer w/o skirt - \$205

Concealed Floor Power Infeed Cover

- PCEB: White Metal Finish concealed floor power infeed cover - \$150

Delete Top

- DFT: Delete fixed top. Deduct \$1125 Veneer(W), \$955 High Pressure Laminate (G), \$630 Thermally Fused Laminate (M) per top

Metal Feet

- MTL10: Replace solid wood feet with metal feet, standard MFW White - \$55 ea

Premium Metal Finish

- Specify premium Metal Finish. MFMB: Matte Black, MFS: Silver, MFSS: Salmon Sienna, MFSA: Surfing Aquavert, MFPS: Pistachio, MFOS: Oyster, MFNA: Navy, MFOL: Olive, MFGB: Grey Beige MFGG: Graphite Gray, MFG: Gray, MFGM:Matte Gold
- Premium Metal Finish for WMT Wire Management Tray - \$75 ea
- Premium Metal Finish for MTL10 Metal Feet - \$20 ea
- Premium Metal Finish for PCEB Concealed Floor Power Infeed Cover - \$35

Starter Panel

- RSP: Substitute round starter panel in place of flat starter panel. Must substitute all starters, priced per starter panel - \$83 each. See HNY3555SP888

Worksurface Height

- Modify worksurface height to bar height.
- THL-42: Position worksurface at bar height - N/C

Wire Tray

- WMT: Wire metal tray. Mounts under top and comes standard in MFW White - \$210

DARRAN

Honey

Inline Hexagon Workstation Typical
Position 1 Desk with Power Fixed Worksurface

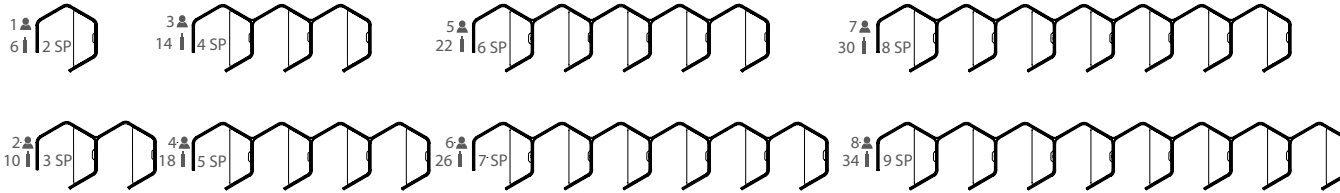

Number of Feet per Typical (MTL10 Option) "SP" Number of Starter Panels per Typical (RSP Option)

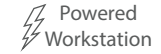
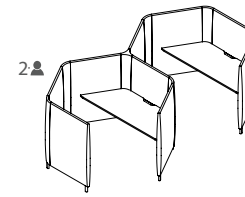

1 Select Model

w" x d" x h"	Weight	Standard Veneer Top Upholstered Panels - COM\$	Premium Veneer Top Upholstered Panels - COM\$
602 x 86 x 55	128	8 HNY60286FP576W 65382	"P" Option N/A
528 x 86 x 55	112	7 HNY52886FP576W 57393	"P" Option N/A
453 x 86 x 55	97	6 HNY45386FP576W 49404	"P" Option N/A
378 x 86 x 55	81	5 HNY37886FP576W 41415	"P" Option N/A
303 x 86 x 55	66	4 HNY30386FP576W 33426	"P" Option N/A
228 x 86 x 55	50	3 HNY22886FP576W 25437	"P" Option N/A
153 x 86 x 55	35	2 HNY15386FP576W 17448	"P" Option N/A
78 x 86 x 55	19	1 HNY7886FP576W 9459	"P" Option N/A

[Click Here for Graded in Pricing](#)

2 Select Finish

Click to view finishes

WWP	WOW
PO01	WNO
PO02	WSO
PO03	WNF(Natural Oak on Flat Cut)
PO07	WSF(Salted Oak on Flat Cut)
PO08	WSF(Salted Oak on Flat Cut)
PO09	WSF(Salted Oak on Flat Cut)
WBW	
WSW	
WEC	

3 Select Feet Finish

Click to view edges

WWP	WOW
PO01	WNO
PO02	WSO
PO03	
PO07	
PO08	
PO09	
WBW	
WSW	
WEC	

4 Select Edge

Click to view details



High Pressure Laminate Top Upholstered Panels - COM\$

HNY60286FP576G	63782
HNY52886FP576G	55993
HNY45386FP576G	48204
HNY37886FP576G	40415
HNY30386FP576G	32626
HNY22886FP576G	24837
HNY15386FP576G	17048
HNY7886FP576G	9259

GEC	LW05
GWL	LW06
LP01	
LF02	
LF03	
LN01	
LA02	
LW01	
LW02	
LW04	

WWP	WOW
PO01	WNO
PO02	WSO
PO03	
PO07	
PO08	
PO09	
WBW	
WSW	
WEC	

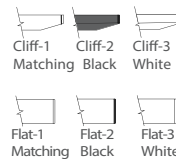

Thermally Fused Laminate Top Upholstered Panels - COM\$

HNY60286FP576M	60726
HNY52886FP576M	53319
HNY45386FP576M	45912
HNY37886FP576M	38505
HNY30386FP576M	31098
HNY22886FP576M	23691
HNY15386FP576M	16284
HNY7886FP576M	8877

MOC
MEC
MSW
MTW
MWL
MNA

WWP	WOW
PO01	WNO
PO02	WSO
PO03	
PO07	
PO08	
PO09	
WEC	
WBW	
WSW	



[Click here to view statement of line](#)

Product Features

- HNY7226WT162 Fixed Desk Height worksurfaces, 29" worksurface height
- 5" Solid wood feet - oval shape
- 4 Power outlets with 1 telecom plate, see options below for telecom plate
- Ships KD
- Wire management tray attaches to worksurface top, standard in MFW White, see premium Metal Finish for options
- Hardwire infeed and jumpers are included in workstations
- T75 worksurface wire cutout is standard on all worksurfaces.(T75D: Delete cutout is optional)

Options

Accessories

- K28: Articulating Keyboard w/ Mouse - \$390
- K31-SK: Center drawer w/ skirt - \$310
- K31: Center drawer w/o skirt - \$205

Concealed Floor Power Infeed Cover

- PCEB: White Metal Finish concealed floor power infeed cover - \$150

Delete Top and Wire Tray

- DFP: Delete fixed top. Deduct \$1335 Veneer (W), \$1165 High Pressure Laminate (G), \$840 Thermally Fused Laminate (M) per top

Metal Feet

- MTL10: Replace solid wood feet with metal feet, standard MFW White - \$55 ea

Premium Metal Finish

- Specify premium Metal Finish. MFMB: Matte Black, MFS: Silver, MFSS: Salmon Sienna, MFSA: SurfIn Aquavert, MFPS: Pistachio, MFOS: Oyster, MFNA: Navy, MFOL: Olive, MFGB: Grey Beige MFGG: Graphite Gray, MFG: Gray, MFGM:Matte Gold
- Premium Metal Finish for WMT Wire Management Tray - \$75 ea
- Premium Metal Finish for MTL10 Metal Feet - \$20 ea
- Premium Metal Finish for PCEB Concealed Floor Power Infeed Cover - \$35

Starter Panel

- RSP: Substitute round starter panel in place of flat starter panel. Must substitute all starters, priced per starter panel - \$83 each. See HNY3555SP888

Telecom Plates

- Each power unit has 1 plate. All telecom connectors sold separately.
- RJ45 (1) - \$55, RJ45 (2) - \$110, RJ45 (3) - \$165, USB (1) - \$70, USB (2) - \$140, RJ45/USB - \$125, RJ45/HDMI - \$210, HDMI/USB - \$205

Worksurface Height

- THL-42: Modify worksurface height to bar height - N/C

DARRAN

Honey

Inline Hexagon Workstation Typical
Position 2 Desk with Height Adjustable Worksurface

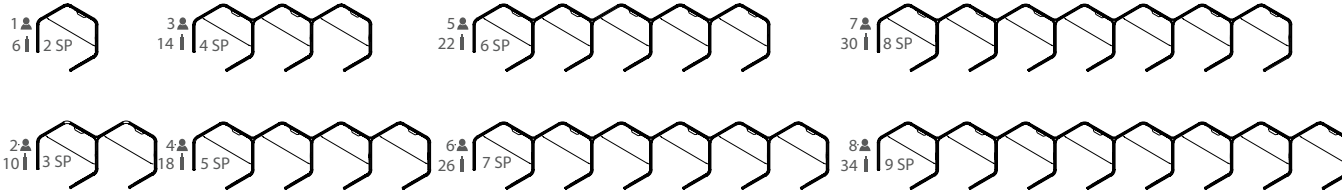

Number of Feet per Typical (MTL10 Option) "SP" Number of Starter Panels per Typical (RSP Option)

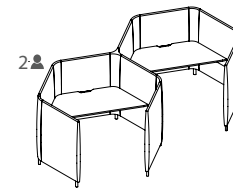

1 Select Model

w" x d" x h"	Weight	Standard Veneer Top Upholstered Panels - COM\$	Premium Veneer Top Upholstered Panels - COM\$	High Pressure Laminate Top Upholstered Panels - COM\$	Thermally Fused Laminate Top Upholstered Panels - COM\$
602 x 86 x 55	128	8 HNY60286HA577W 83185	"P" Option N/A	HNY60286HA577G 81577	HNY60286HA577M 78521
528 x 86 x 55	112	7 HNY52886HA577W 72980	"P" Option N/A	HNY52886HA577G 71573	HNY52886HA577M 68899
453 x 86 x 55	97	6 HNY45386HA577W 62775	"P" Option N/A	HNY45386HA577G 61569	HNY45386HA577M 59277
378 x 86 x 55	81	5 HNY37886HA577W 52570	"P" Option N/A	HNY37886HA577G 51565	HNY37886HA577M 49655
303 x 86 x 55	66	4 HNY30386HA577W 42365	"P" Option N/A	HNY30386HA577G 41561	HNY30386HA577M 40033
228 x 86 x 55	50	3 HNY22886HA577W 32160	"P" Option N/A	HNY22886HA577G 31557	HNY22886HA577M 30411
153 x 86 x 55	35	2 HNY15386HA577W 21955	"P" Option N/A	HNY15386HA577G 21553	HNY15386HA577M 20789
78 x 86 x 55	19	1 HNY7886HA577W 11750	"P" Option N/A	HNY7886HA577G 11549	HNY7886HA577M 11167

[Click Here for Graded in Pricing](#)

2 Select Finish

Click to view finishes

WWP	WOW
PO01	WNO
PO02	WSO
PO03	WNF(Natural Oak on Flat Cut)
PO07	WSF(Salted Oak on Flat Cut)
PO08	WSF(Salted Oak on Flat Cut)
PO09	WSF(Salted Oak on Flat Cut)
WBW	
WSW	
WEC	

3 Select Feet Finish

Click to view edges

WWP	WOW
PO01	WNO
PO02	WSO
PO03	
PO07	
PO08	
PO09	
WBW	
WSW	
WEC	

4 Select Edge

Click to view details

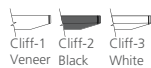

[Click here to view statement of line](#)

Product Features

- 5" Solid wood feet - oval shape, ships KD
- 4 Power outlets with 1 telecom plate, see options below for telecom plate
- Adjustable height from 27" to 47.5" with a maximum weight capacity of 275 lbs.
- Lift standard in MFW White, optional MFB Black
- HNY7125WT163 Height Adjustable worksurfaces are included
- Wire management tray attaches to worksurface top, standard in MFW White, see premium Metal Finish for options
- T75 worksurface wire cutout is standard on all worksurfaces.(T75D: Delete cutout is optional)

Notes

- 1" Gap between worksurface and panels to drop wires below worksurface
- Metal parts include 5 year warranty
- Programmable height adjustable mechanism, motor includes 2 year warranty

Options

Accessories

- K28: Articulating Keyboard w/ Mouse - \$390
- K31-SK: Center drawer w/ skirt - \$310
- K31: Center drawer w/o skirt - \$205

Concealed Floor Power Infeed Cover

- PCEB: White Metal Finish concealed floor power infeed cover - \$150

Delete Top and Wire Tray

- DHAT: Delete height adjustable top. Deduct \$3265 Veneer(W), \$3095 High Pressure Laminate(G), \$2770 Thermally Fused Laminate(M) per top

Metal Feet

- MTL10: Replace solid wood feet with metal feet, standard MFW White - \$55 ea

Premium Metal Finish

- Specify premium Metal Finish. MFMB: Matte Black, MFS: Silver, MFSS: Salmon Sienna, MFSA: Surfin Aquavert, MFPS: Pistachio, MFOS: Oyster, MFNA: Navy, MFOL: Olive, MFGB: Grey Beige MFGG: Graphite Gray, MFG: Gray, MFGM:Matte Gold
- Premium Metal Finish for WMT Wire Management Tray - \$75 ea
- Premium Metal Finish for MTL10 Metal Feet - \$20 ea
- Premium Metal Finish for PCEB Concealed Floor Power Infeed Cover - \$35

Starter Panel

- RSP: Substitute round starter panel in place of flat starter panel. Must substitute all starters, priced per starter panel - \$83 each. See HNY3555SP888

Telecom Plates

- Each power unit has 1 plate. All telecom connectors sold separately.
- RJ45 (1) - \$55, RJ45 (2) - \$110, RJ45 (3) - \$165, USB (1) - \$70, USB (2) - \$140, RJ45/USB - \$125, RJ45/HDMI - \$210, HDMI/USB - \$205

DARRAN[®]

Honey

Inline Hexagon Workstation Typical Position 2 Desk with Fixed Worksurface

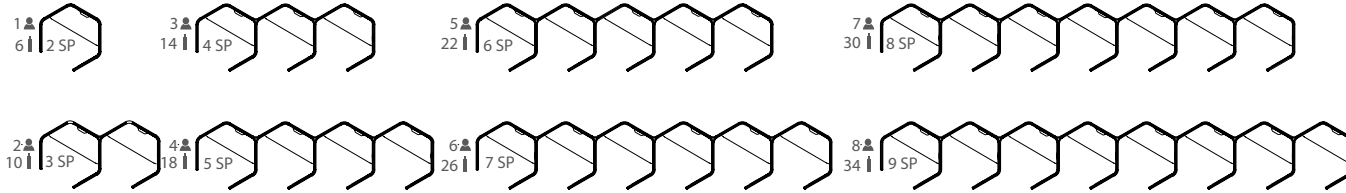

Number of Feet per Typical (MTL10 Option) "SP" Number of Starter Panels per Typical (RSP Option)

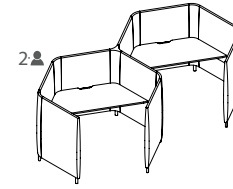

1 Select Model

w" x d" x h"	Weight	Standard Veneer Top Upholstered Panels - COM\$	Premium Veneer Top Upholstered Panels - COM\$
602 x 86 x 55	128	8 HNY60286FT577W 60482	"P" Option N/A
528 x 86 x 55	112	7 HNY52886FT577W 53098	"P" Option N/A
453 x 86 x 55	97	6 HNY45386FT577W 45714	"P" Option N/A
378 x 86 x 55	81	5 HNY37886FT577W 38330	"P" Option N/A
303 x 86 x 55	66	4 HNY30386FT577W 30946	"P" Option N/A
228 x 86 x 55	50	3 HNY22886FT577W 23562	"P" Option N/A
153 x 86 x 55	35	2 HNY15386FT577W 16178	"P" Option N/A
78 x 86 x 55	19	1 HNY7886FT577W 8794	"P" Option N/A

[Click Here for Graded in Pricing](#)

2 Select Finish

Click to view finishes

WWP	WOW
PO01	WNO
PO02	WSO
PO03	WNF(Natural Oak on Flat Cut)
PO07	WSF(Salted Oak on Flat Cut)
PO08	WSF(Salted Oak on Flat Cut)
PO09	WSF(Salted Oak on Flat Cut)
WBW	
WSW	
WEC	

3 Select Feet Finish

Click to view edges

WWP	WOW
PO01	WNO
PO02	WSO
PO03	
PO07	
PO08	
PO09	
WBW	
WSW	
WEC	

4 Select Edge

Click to view details

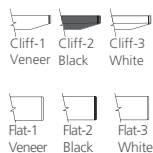

High Pressure Laminate Top Upholstered Panels - COM\$

HNY60286FT577G	58882
HNY52886FT577G	51698
HNY45386FT577G	44514
HNY37886FT577G	37330
HNY30386FT577G	30146
HNY22886FT577G	22962
HNY15386FT577G	15778
HNY7886FT577G	8594

GEC	LW05
GWL	LW06
LP01	
LF02	
LF03	
LN01	
LA02	
LW01	
LW02	
LW04	

WWP	WOW
PO01	WNO
PO02	WSO
PO03	
PO07	
PO08	
PO09	
WBW	
WSW	
WEC	

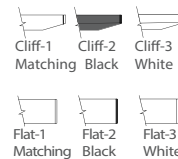

Thermally Fused Laminate Top Upholstered Panels - COM\$

HNY60286FT577M	55826
HNY52886FT577M	49024
HNY45386FT577M	42222
HNY37886FT577M	35420
HNY30386FT577M	28618
HNY22886FT577M	21816
HNY15386FT577M	15014
HNY7886FT577M	8212

MOC
MEC
MSW
MTW
MWL
MNA

WWP	WOW
PO01	WNO
PO02	WSO
PO03	
PO07	
PO08	
PO09	
WBW	
WSW	



[Click here to view statement of line](#)

Product Features

- 5" Solid wood feet - oval shape
- HNY7226WT162 Fixed Desk Height worksurfaces, 29" worksurface height
- Ships KD
- T75 worksurface wire cutout is standard on all worksurfaces.(T75D: Delete cutout is optional)

Options

Accessories

- K28: Articulating Keyboard w/ Mouse - \$390
- K31-SK: Center drawer w/ skirt - \$310
- K31: Center drawer w/o skirt - \$205

Concealed Floor Power Infeed Cover

- PCEB: White Metal Finish concealed floor power infeed cover - \$150

Delete Top

- DFT: Delete fixed top. Deduct \$1125 Veneer(W), \$955 High Pressure Laminate (G), \$630 Thermally Fused Laminate (M) per top

Metal Feet

- MTL10: Replace solid wood feet with metal feet, standard MFW White - \$55 ea

Premium Metal Finish

- Specify premium Metal Finish. MFMB: Matte Black, MFS: Silver, MFSS: Salmon Sienna, MFSA: Surfing Aquavert, MFPS: Pistachio, MFOS: Oyster, MFNA: Navy, MFOL: Olive, MFGB: Grey Beige MFGG: Graphite Gray, MFG: Gray, MFGM:Matte Gold
- Premium Metal Finish for WMT Wire Management Tray - \$75 ea
- Premium Metal Finish for MTL10 Metal Feet - \$20 ea
- Premium Metal Finish for PCEB Concealed Floor Power Infeed Cover - \$35

Starter Panel

- RSP: Substitute round starter panel in place of flat starter panel. Must substitute all starters, priced per starter panel - \$83 each. See HNY3555SP888

Worksurface Height

- Modify worksurface height to bar height.
- THL-42: Position worksurface at bar height - N/C

Wire Tray

- WMT: Wire metal tray. Mounts under top and comes standard in MFW White - \$210

DARRAN

Honey

Inline Hexagon Workstation Typical
Position 2 Desk with Power Fixed Worksurface

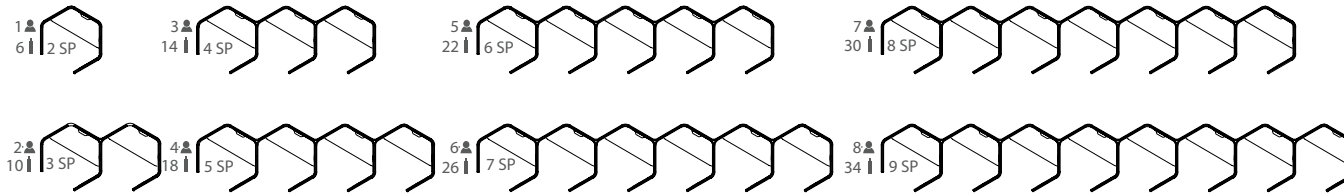

Number of Feet per Typical (MTL10 Option) "SP" Number of Starter Panels per Typical (RSP Option)

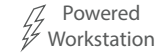
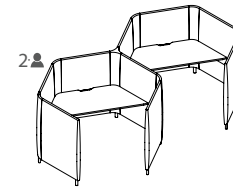

1 Select Model

w" x d" x h"	Weight	Standard Veneer Top Upholstered Panels - COM\$	Premium Veneer Top Upholstered Panels - COM\$
602 x 86 x 55	128	8 HNY60286FP577W 64857	"P" Option N/A
528 x 86 x 55	112	7 HNY52886FP577W 56943	"P" Option N/A
453 x 86 x 55	97	6 HNY45386FP577W 49029	"P" Option N/A
378 x 86 x 55	81	5 HNY37886FP577W 41115	"P" Option N/A
303 x 86 x 55	66	4 HNY30386FP577W 33201	"P" Option N/A
228 x 86 x 55	50	3 HNY22886FP577W 25287	"P" Option N/A
153 x 86 x 55	35	2 HNY15386FP577W 17373	"P" Option N/A
78 x 86 x 55	19	1 HNY7886FP577W 9459	"P" Option N/A

[Click Here for Graded in Pricing](#)

2 Select Finish

Click to view finishes

WWP	WOW
PO01	WNO
PO02	WSO
PO03	WNF(Natural Oak on Flat Cut)
PO07	WSF(Salted Oak on Flat Cut)
PO08	WSF(Salted Oak on Flat Cut)
PO09	WSF(Salted Oak on Flat Cut)
WBW	
WSW	
WEC	

3 Select Feet Finish

Click to view edges

WWP	WOW
PO01	WNO
PO02	WSO
PO03	
PO07	
PO08	
PO09	
WBW	
WSW	
WEC	

4 Select Edge

Click to view details



High Pressure Laminate Top Upholstered Panels - COM\$

HNY60286FP577G	63257
HNY52886FP577G	55543
HNY45386FP577G	47829
HNY37886FP577G	40115
HNY30386FP577G	32401
HNY22886FP577G	24687
HNY15386FP577G	16973
HNY7886FP577G	9259

GEC	LW05
GWL	LW06
LP01	
LF02	
LF03	
LN01	
LA02	
LW01	
LW02	
LW04	

WWP	WOW
PO01	WNO
PO02	WSO
PO03	
PO07	
PO08	
PO09	
WBW	
WSW	
WEC	

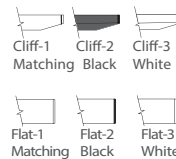

Thermally Fused Laminate Top Upholstered Panels - COM\$

HNY60286FP577M	60201
HNY52886FP577M	52869
HNY45386FP577M	45537
HNY37886FP577M	38205
HNY30386FP577M	30873
HNY22886FP577M	23541
HNY15386FP577M	16209
HNY7886FP577M	8877

MOC
MEC
MSW
MTW
MWL
MNA

WWP	WOW
PO01	WNO
PO02	WSO
PO03	
PO07	
PO08	
PO09	
WEC	
WBW	
WSW	



[Click here to view statement of line](#)

Product Features

- HNY7226WT162 Fixed Desk Height worksurfaces, 29" worksurface height
- 5" Solid wood feet - oval shape
- 4 Power outlets with 1 telecom plate, see options below for telecom plate
- Ships KD
- Wire management tray attaches to worksurface top, standard in MFW White, see premium Metal Finish for options
- Hardwire infeed and jumpers are included in workstations
- T75 worksurface wire cutout is standard on all worksurfaces.(T75D: Delete cutout is optional)

Options

Accessories

- K28: Articulating Keyboard w/ Mouse - \$390
- K31-SK: Center drawer w/ skirt - \$310
- K31: Center drawer w/o skirt - \$205

Concealed Floor Power Infeed Cover

- PCEB: White Metal Finish concealed floor power infeed cover - \$150

Delete Top and Wire Tray

- DFP: Delete fixed top. Deduct \$1335 Veneer (W), \$1165 High Pressure Laminate (G), \$840 Thermally Fused Laminate (M) per top

Metal Feet

- MTL10: Replace solid wood feet with metal feet, standard MFW White - \$55 ea

Premium Metal Finish

- Specify premium Metal Finish. MFMB: Matte Black, MFS: Silver, MFSS: Salmon Sienna, MFSA: Surfing Aquavert, MFPS: Pistachio, MFOS: Oyster, MFNA: Navy, MFOL: Olive, MFGB: Grey Beige MFGG: Graphite Gray, MFG: Gray, MFGM:Matte Gold
- Premium Metal Finish for WMT Wire Management Tray - \$75 ea
- Premium Metal Finish for MTL10 Metal Feet - \$20 ea
- Premium Metal Finish for PCEB Concealed Floor Power Infeed Cover - \$35

Starter Panel

- RSP: Substitute round starter panel in place of flat starter panel. Must substitute all starters, priced per starter panel - \$83 each. See HNY3555SP888

Telecom Plates

- Each power unit has 1 plate. All telecom connectors sold separately.
- RJ45 (1) - \$55, RJ45 (2) - \$110, RJ45 (3) - \$165, USB (1) - \$70, USB (2) - \$140, RJ45/USB - \$125, RJ45/HDMI - \$210, HDMI/USB - \$205

Worksurface Height

- THL-42: Modify worksurface height to bar height - N/C

DARRAN

Honey

Inline Hexagon Workstation Typical Position 3 with Height Adjustable Worksurface

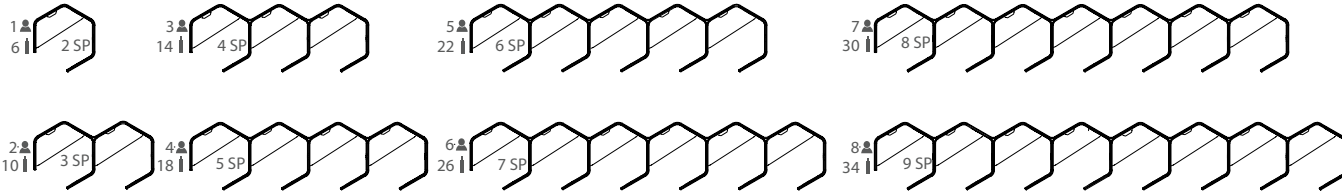

Number of Feet per Typical (MTL10 Option) "SP" Number of Starter Panels per Typical (RSP Option)

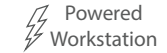
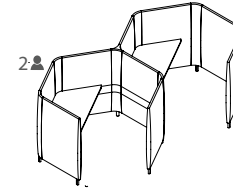

1 Select Model

w" x d" x h"	Weight	Standard Veneer Top Upholstered Panels - COM\$	Premium Veneer Top Upholstered Panels - COM\$
602 x 86 x 55	128	8 HNY60286HA578W 83185	"P" Option N/A
528 x 86 x 55	112	7 HNY52886HA578W 72980	"P" Option N/A
453 x 86 x 55	97	6 HNY45386HA578W 62775	"P" Option N/A
378 x 86 x 55	81	5 HNY37886HA578W 52570	"P" Option N/A
303 x 86 x 55	66	4 HNY30386HA578W 42365	"P" Option N/A
228 x 86 x 55	50	3 HNY22886HA578W 32160	"P" Option N/A
153 x 86 x 55	35	2 HNY15386HA578W 21955	"P" Option N/A
78 x 86 x 55	19	1 HNY7886HA578W 11750	"P" Option N/A

[Click Here for Graded in Pricing](#)

2 Select Finish

Click to view finishes

WWP	WOW
PO01	WNO
PO02	WSO
PO03	WNF(Natural Oak on Flat Cut)
PO07	WSF(Salted Oak on Flat Cut)
PO08	WSF(Salted Oak on Flat Cut)
PO09	WSF(Salted Oak on Flat Cut)
WBW	
WSW	
WEC	

3 Select Feet Finish

Click to view edges

WWP	WOW
PO01	WNO
PO02	WSO
PO03	
PO07	
PO08	
PO09	
WBW	
WSW	
WEC	

4 Select Edge

Click to view details

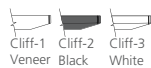

High Pressure Laminate Top Upholstered Panels - COM\$

HNY60286HA578G 81577	"P" Option N/A
HNY52886HA578G 71573	"P" Option N/A
HNY45386HA578G 61569	"P" Option N/A
HNY37886HA578G 51565	"P" Option N/A
HNY30386HA578G 41561	"P" Option N/A
HNY22886HA578G 31557	"P" Option N/A
HNY15386HA578G 21553	"P" Option N/A
HNY7886HA578G 11549	"P" Option N/A

GEC LW05
GWL LW06
LP01
LF02
LF03
LN01
LA02
LW01
LW02
LW04

WWP	WOW
PO01	WNO
PO02	WSO
PO03	
PO07	
PO08	
PO09	
WBW	
WSW	
WEC	



Thermally Fused Laminate Top Upholstered Panels - COM\$

HNY60286HA578M 78521	"P" Option N/A
HNY52886HA578M 68899	"P" Option N/A
HNY45386HA578M 59277	"P" Option N/A
HNY37886HA578M 49655	"P" Option N/A
HNY30386HA578M 40033	"P" Option N/A
HNY22886HA578M 30411	"P" Option N/A
HNY15386HA578M 20789	"P" Option N/A
HNY7886HA578M 11167	"P" Option N/A

MOC
MEC
MSW
MTW
MWL
MNA

WWP	WOW
PO01	WNO
PO02	WSO
PO03	
PO07	
PO08	
PO09	
WBW	
WSW	



[Click here to view statement of line](#)

Product Features

- 5" Solid wood feet - oval shape, ships KD
- 4 Power outlets with 1 telecom plate, see options below for telecom plate
- Adjustable height from 27" to 47.5" with a maximum weight capacity of 275 lbs.
- Lift standard in MFW White, optional MFB Black
- HNY7125WT163 Height Adjustable worksurfaces are included
- Wire management tray attaches to worksurface top, standard in MFW White, see premium Metal Finish for options
- T75 worksurface wire cutout is standard on all worksurfaces.(T75D: Delete cutout is optional)

Notes

- 1" Gap between worksurface and panels to drop wires below worksurface
- Metal parts include 5 year warranty
- Programmable height adjustable mechanism, motor includes 2 year warranty

Options

Accessories

- K28: Articulating Keyboard w/ Mouse - \$390
- K31-SK: Center drawer w/ skirt - \$310
- K31: Center drawer w/o skirt - \$205

Concealed Floor Power Infeed Cover

- PCEB: White Metal Finish concealed floor power infeed cover - \$150

Delete Top and Wire Tray

- DHAT: Delete height adjustable top. Deduct \$3265 Veneer(W), \$3095 High Pressure Laminate(G), \$2770 Thermally Fused Laminate(M) per top

Metal Feet

- MTL10: Replace solid wood feet with metal feet, standard MFW White - \$55 ea

Premium Metal Finish

- Specify premium Metal Finish. MFMB: Matte Black, MFS: Silver, MFSS: Salmon Sienna, MFSA: Surfin Aquavert, MFPS: Pistachio, MFOS: Oyster, MFNA: Navy, MFOL: Olive, MFGB: Grey Beige MFGG: Graphite Gray, MFG: Gray, MFGM:Matte Gold
- Premium Metal Finish for WMT Wire Management Tray - \$75 ea
- Premium Metal Finish for MTL10 Metal Feet - \$20 ea
- Premium Metal Finish for PCEB Concealed Floor Power Infeed Cover - \$35

Starter Panel

- RSP: Substitute round starter panel in place of flat starter panel. Must substitute all starters, priced per starter panel - \$83 each. See HNY3555SP888

Telecom Plates

- Each power unit has 1 plate. All telecom connectors sold separately.
- RJ45 (1) - \$55, RJ45 (2) - \$110, RJ45 (3) - \$165, USB (1) - \$70, USB (2) - \$140, RJ45/USB - \$125, RJ45/HDMI - \$210, HDMI/USB - \$205

DARRAN

Honey

Inline Hexagon Workstation Typical
Position 3 Desk with Fixed Worksurface

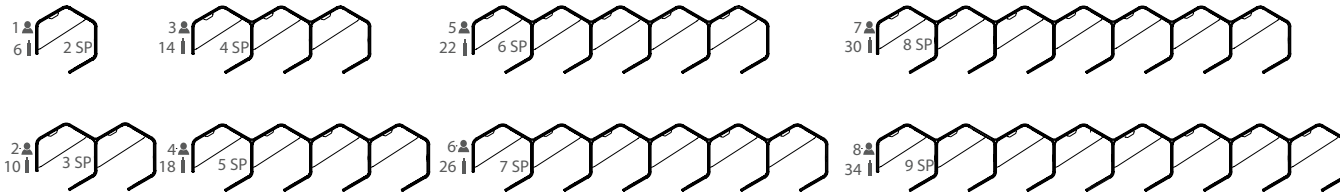

Number of Feet per Typical (MTL10 Option) "SP" Number of Starter Panels per Typical (RSP Option)

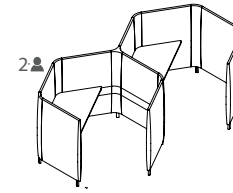

Fixed Top Workstation

Non-Powered Workstation

1 Select Model

w" x d" x h"	Weight	Standard Veneer Top Upholstered Panels - COM\$	Premium Veneer Top Upholstered Panels - COM\$
602 x 86 x 55	128	8 HNY60286FT578W 60482	"P" Option N/A
528 x 86 x 55	112	7 HNY52886FT578W 53098	"P" Option N/A
453 x 86 x 55	97	6 HNY45386FT578W 45714	"P" Option N/A
378 x 86 x 55	81	5 HNY37886FT578W 38330	"P" Option N/A
303 x 86 x 55	66	4 HNY30386FT578W 30946	"P" Option N/A
228 x 86 x 55	50	3 HNY22886FT578W 23562	"P" Option N/A
153 x 86 x 55	35	2 HNY15386FT578W 16178	"P" Option N/A
78 x 86 x 55	19	1 HNY7886FT578W 8794	"P" Option N/A

[Click Here for Graded in Pricing](#)

2 Select Finish

Click to view finishes

WWP	WOW
PO01	WNO
PO02	WSO
PO03	WNF(Natural Oak on Flat Cut)
PO07	WSF(Salted Oak on Flat Cut)
PO08	WSF(Salted Oak on Flat Cut)
PO09	WSF(Salted Oak on Flat Cut)
WBW	
WSW	
WEC	

3 Select Feet Finish

Click to view edges

WWP	WOW
PO01	WNO
PO02	WSO
PO03	
PO07	
PO08	
PO09	
WBW	
WSW	
WEC	

4 Select Edge

Click to view details

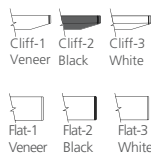

High Pressure Laminate Top Upholstered Panels - COM\$

HNY60286FT578G	58882
HNY52886FT578G	51698
HNY45386FT578G	44514
HNY37886FT578G	37330
HNY30386FT578G	30146
HNY22886FT578G	22962
HNY15386FT578G	15778
HNY7886FT578G	8594

GEC	LW05
GWL	LW06
LP01	
LF02	
LF03	
LN01	
LA02	
LW01	
LW02	
LW04	

WWP	WOW
PO01	WNO
PO02	WSO
PO03	
PO07	
PO08	
PO09	
WBW	
WSW	
WEC	

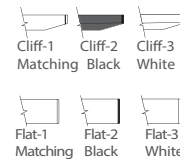

Thermally Fused Laminate Top Upholstered Panels - COM\$

HNY60286FT578M	55826
HNY52886FT578M	49024
HNY45386FT578M	42222
HNY37886FT578M	35420
HNY30386FT578M	28618
HNY22886FT578M	21816
HNY15386FT578M	15014
HNY7886FT578M	8212

MOC
MEC
MSW
MTW
MWL
MNA

WWP	WOW
PO01	WNO
PO02	WSO
PO03	
PO07	
PO08	
PO09	
WBW	
WSW	



[Click here to view statement of line](#)

Product Features

- 5" Solid wood feet - oval shape
- HNY7226WT162 Fixed Desk Height worksurfaces, 29" worksurface height
- Ships KD
- T75 worksurface wire cutout is standard on all worksurfaces.(T75D: Delete cutout is optional)

Options

Accessories

- K28: Articulating Keyboard w/ Mouse - \$390
- K31-SK: Center drawer w/ skirt - \$310
- K31: Center drawer w/o skirt - \$205

Concealed Floor Power Infeed Cover

- PCEB: White Metal Finish concealed floor power infeed cover - \$150

Delete Top

- DFT: Delete fixed top. Deduct \$1125 Veneer(W), \$955 High Pressure Laminate (G), \$630 Thermally Fused Laminate (M) per top

Metal Feet

- MTL10: Replace solid wood feet with metal feet, standard MFW White - \$55 ea

Premium Metal Finish

- Specify premium Metal Finish. MFMB: Matte Black, MFS: Silver, MFSS: Salmon Sienna, MFSA: Surfing Aquavert, MFPS: Pistachio, MFOS: Oyster, MFNA: Navy, MFOL: Olive, MFGB: Grey Beige MFGG: Graphite Gray, MFG: Gray, MFGM:Matte Gold
- Premium Metal Finish for WMT Wire Management Tray - \$75 ea
- Premium Metal Finish for MTL10 Metal Feet - \$20 ea
- Premium Metal Finish for PCEB Concealed Floor Power Infeed Cover - \$35

Starter Panel

- RSP: Substitute round starter panel in place of flat starter panel. Must substitute all starters, priced per starter panel - \$83 each. See HNY3555SP888

Worksurface Height

- Modify worksurface height to bar height.
- THL-42: Position worksurface at bar height - N/C

Wire Tray

- WMT: Wire metal tray. Mounts under top and comes standard in MFW White - \$210

DARRAN

Honey

Inline Hexagon Workstation Typical
Position 3 Desk with Power Fixed Worksurface

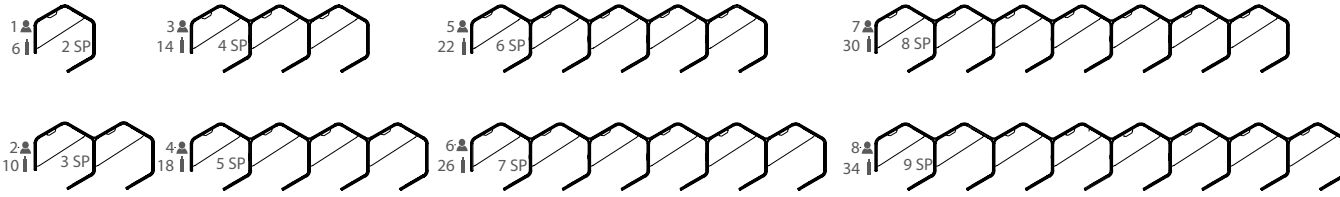

Number of Feet per Typical (MTL10 Option) "SP" Number of Starter Panels per Typical (RSP Option)

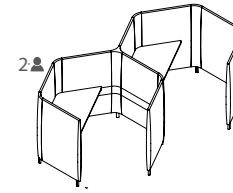

Fixed Top Workstation

Powered Workstation

1 Select Model

w" x d" x h"	Weight	Standard Veneer Top Upholstered Panels - COM\$	Premium Veneer Top Upholstered Panels - COM\$
602 x 86 x 55	128	8 HNY60286FP578W 64857	"P" Option N/A
528 x 86 x 55	112	7 HNY52886FP578W 56943	"P" Option N/A
453 x 86 x 55	97	6 HNY45386FP578W 49029	"P" Option N/A
378 x 86 x 55	81	5 HNY37886FP578W 41115	"P" Option N/A
303 x 86 x 55	66	4 HNY30386FP578W 33201	"P" Option N/A
228 x 86 x 55	50	3 HNY22886FP578W 25287	"P" Option N/A
153 x 86 x 55	35	2 HNY15386FP578W 17373	"P" Option N/A
78 x 86 x 55	19	1 HNY7886FP578W 9459	"P" Option N/A

[Click Here for Graded in Pricing](#)

2 Select Finish

Click to view finishes

WWP	WOW
PO01	WNO
PO02	WSO
PO03	WNF(Natural Oak on Flat Cut)
PO07	WSF(Salted Oak on Flat Cut)
PO08	WSF(Salted Oak on Flat Cut)
PO09	WSF(Salted Oak on Flat Cut)
WBW	
WSW	
WEC	

3 Select Feet Finish

Click to view edges

WWP	WOW
PO01	WNO
PO02	WSO
PO03	
PO07	
PO08	
PO09	
WBW	
WSW	
WEC	

4 Select Edge

Click to view details



High Pressure Laminate Top Upholstered Panels - COM\$

HNY60286FP578G	63257
HNY52886FP578G	55543
HNY45386FP578G	47829
HNY37886FP578G	40115
HNY30386FP578G	32401
HNY22886FP578G	24687
HNY15386FP578G	16973
HNY7886FP578G	9259

GEC	LW05
GWL	LW06
LP01	
LF02	
LF03	
LN01	
LA02	
LW01	
LW02	
LW04	

WWP	WOW
PO01	WNO
PO02	WSO
PO03	
PO07	
PO08	
PO09	
WBW	
WSW	
WEC	

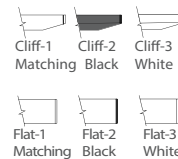

Thermally Fused Laminate Top Upholstered Panels - COM\$

HNY60286FP578M	60201
HNY52886FP578M	52869
HNY45386FP578M	45537
HNY37886FP578M	38205
HNY30386FP578M	30873
HNY22886FP578M	23541
HNY15386FP578M	16209
HNY7886FP578M	8877

MOC
MEC
MSW
MTW
MWL
MNA

WWP	WOW
PO01	WNO
PO02	WSO
PO03	
PO07	
PO08	
PO09	
WEC	
WBW	
WSW	



[Click here to view statement of line](#)

Product Features

- HNY7226WT162 Fixed Desk Height worksurfaces, 29" worksurface height
- 5" Solid wood feet - oval shape
- 4 Power outlets with 1 telecom plate, see options below for telecom plate
- Ships KD
- Wire management tray attaches to worksurface top, standard in MFW White, see premium Metal Finish for options
- Hardwire infeed and jumpers are included in workstations
- T75 worksurface wire cutout is standard on all worksurfaces.(T75D: Delete cutout is optional)

Options

Accessories

- K28: Articulating Keyboard w/ Mouse - \$390
- K31-SK: Center drawer w/ skirt - \$310
- K31: Center drawer w/o skirt - \$205

Concealed Floor Power Infeed Cover

- PCEB: White Metal Finish concealed floor power infeed cover - \$150

Delete Top and Wire Tray

- DFP: Delete fixed top. Deduct \$1335 Veneer (W), \$1165 High Pressure Laminate (G), \$840 Thermally Fused Laminate (M) per top

Metal Feet

- MTL10: Replace solid wood feet with metal feet, standard MFW White - \$55 ea

Premium Metal Finish

- Specify premium Metal Finish. MFMB: Matte Black, MFS: Silver, MFSS: Salmon Sienna, MFSA: Surfing Aquavert, MFPS: Pistachio, MFOS: Oyster, MFNA: Navy, MFOL: Olive, MFGB: Grey Beige MFGG: Graphite Gray, MFG: Gray, MFGM:Matte Gold
- Premium Metal Finish for WMT Wire Management Tray - \$75 ea
- Premium Metal Finish for MTL10 Metal Feet - \$20 ea
- Premium Metal Finish for PCEB Concealed Floor Power Infeed Cover - \$35

Starter Panel

- RSP: Substitute round starter panel in place of flat starter panel. Must substitute all starters, priced per starter panel - \$83 each. See HNY3555SP888

Telecom Plates

- Each power unit has 1 plate. All telecom connectors sold separately.
- RJ45 (1) - \$55, RJ45 (2) - \$110, RJ45 (3) - \$165, USB (1) - \$70, USB (2) - \$140, RJ45/USB - \$125, RJ45/HDMI - \$210, HDMI/USB - \$205

Worksurface Height

- THL-42: Modify worksurface height to bar height - N/C

DARRAN

Honey

Double Hexagon Workstation Typical
Position 1 Desk with Height Adjustable Worksurface

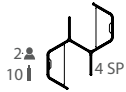

Number of Feet per Typical (MTL10 Option) "SP" Number of Starter Panels per Typical (RSP Option)

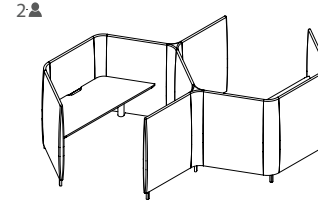
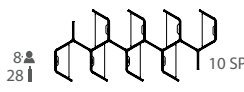
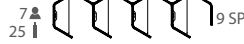
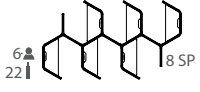
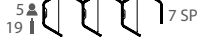
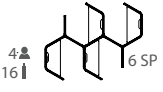
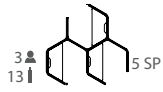

1 Select Model

w" x d" x h"	Weight	Standard Veneer Top Upholstered Panels - COM\$	Premium Veneer Top Upholstered Panels - COM\$	High Pressure Laminate Top Upholstered Panels - COM\$	Thermally Fused Laminate Top Upholstered Panels - COM\$
340 x 150 x 55	103	8 HNY340150HA579W 72932	"P" Option N/A	HNY340150HA579G 71324	HNY340150HA579M 68268
303 x 150 x 55	92	7 HNY303150HA579W 64293	"P" Option N/A	HNY303150HA579G 62886	HNY303150HA579M 60212
265 x 150 x 55	80	6 HNY265150HA579W 55804	"P" Option N/A	HNY265150HA579G 54598	HNY265150HA579M 52306
228 x 150 x 55	69	5 HNY228150HA579W 47240	"P" Option N/A	HNY228150HA579G 46235	HNY228150HA579M 44325
191 x 150 x 55	57	4 HNY191150HA579W 38676	"P" Option N/A	HNY191150HA579G 37872	HNY191150HA579M 36344
153 x 150 x 55	46	3 HNY153150HA579W 30037	"P" Option N/A	HNY153150HA579G 29434	HNY153150HA579M 28288
116 x 150 x 55	34	2 HNY116150HA579W 21533	"P" Option N/A	HNY116150HA579G 21131	HNY116150HA579M 20367

2 Select Finish

Click to view finishes

WWP	WOW
PO01	WNO
PO02	WSO
PO03	WNF(Natural Oak on Flat Cut)
PO07	WSF(Salted Oak on Flat Cut)
PO08	WSF(Salted Oak on Flat Cut)
PO09	WSF(Salted Oak on Flat Cut)
WBW	
WSW	
WEC	

3 Select Feet Finish

Click to view edges

WWP	WOW
PO01	WNO
PO02	WSO
PO03	
PO07	
PO08	
PO09	
WBW	
WSW	
WEC	

4 Select Edge

Click to view details



GEC	LW05
GWL	LW06
LP01	
LF02	
LF03	
LN01	
LA02	
LW01	
LW02	
LW04	

WWP	WOW
PO01	WNO
PO02	WSO
PO03	
PO07	
PO08	
PO09	
WBW	
WSW	
WEC	



MOC
MEC
MSW
MTW
MWL
MNA

WWP	WOW
PO01	WNO
PO02	WSO
PO03	
PO07	
PO08	
PO09	
WEC	
WBW	
WSW	



Click here to view statement of line

Product Features

- 5" Solid wood feet - oval shape, ships KD
- 4 Power outlets with 1 telecom plate, see options below for telecom plate
- Adjustable height from 27" to 47.5" with a maximum weight capacity of 275 lbs.
- Lift standard in MFW White, optional MFB Black
- HNY7125WT163 Height Adjustable worksurfaces are included
- Wire management tray attaches to worksurface top, standard in MFW White, see premium Metal Finish for options
- T75 worksurface wire cutout is standard on all worksurfaces.(T75D: Delete cutout is optional)

Notes

- 1" Gap between worksurface and panels to drop wires below worksurface
- Metal parts include 5 year warranty
- Programmable height adjustable mechanism, motor includes 2 year warranty

Options

Accessories

- K28: Articulating Keyboard w/ Mouse - \$390
- K31-SK: Center drawer w/ skirt - \$310
- K31: Center drawer w/o skirt - \$205

Concealed Floor Power Infeed Cover

- PCEB: White Metal Finish concealed floor power infeed cover - \$150

Delete Top and Wire Tray

- DHAT: Delete height adjustable top. Deduct \$3265 Veneer(W), \$3095 High Pressure Laminate(G), \$2770 Thermally Fused Laminate(M) per top

Metal Feet

- MTL10: Replace solid wood feet with metal feet, standard MFW White - \$55 ea

Premium Metal Finish

- Specify premium Metal Finish. MFMB: Matte Black, MFS: Silver, MFSS: Salmon Sienna, MFSA: Surfing Aquavert, MFPS: Pistachio, MFOS: Oyster, MFNA: Navy, MFOL: Olive, MFGB: Grey Beige MFGG: Graphite Gray, MFG: Gray, MFGM:Matte Gold
- Premium Metal Finish for WMT Wire Management Tray - \$75 ea
- Premium Metal Finish for MTL10 Metal Feet - \$20 ea
- Premium Metal Finish for PCEB Concealed Floor Power Infeed Cover - \$35

Starter Panel

- RSP: Substitute round starter panel in place of flat starter panel. Must substitute all starters, priced per starter panel - \$83 each. See HNY3555SP888

Telecom Plates

- Each power unit has 1 plate. All telecom connectors sold separately.
- RJ45 (1) - \$55, RJ45 (2) - \$110, RJ45 (3) - \$165, USB (1) - \$70, USB (2) - \$140, RJ45/USB - \$125, RJ45/HDMI - \$210, HDMI/USB - \$205

Double Hexagon Workstation Typical
Position 1 Desk with Fixed Worksurface

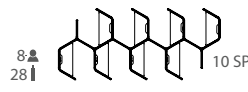
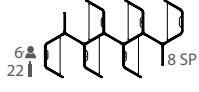
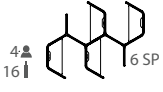
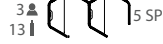
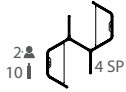

Number of Feet per Typical (MTL10 Option) "SP" Number of Starter Panels per Typical (RSP Option)

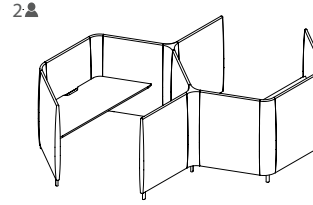

1 Select Model

w" x d" x h"	Weight	Standard Veneer Top Upholstered Panels - COM\$	Premium Veneer Top Upholstered Panels - COM\$
340 x 150 x 55	103	8 HNY340150FT579W 50492	"P" Option N/A
303 x 150 x 55	92	7 HNY303150FT579W 44690	"P" Option N/A
265 x 150 x 55	80	6 HNY265150FT579W 38888	"P" Option N/A
228 x 150 x 55	69	5 HNY228150FT579W 33086	"P" Option N/A
191 x 150 x 55	57	4 HNY191150FT579W 27284	"P" Option N/A
153 x 150 x 55	46	3 HNY153150FT579W 21482	"P" Option N/A
116 x 150 x 55	34	2 HNY116150FT579W 15680	"P" Option N/A

[Click Here for Graded in Pricing](#)

2 Select Finish

Click to view finishes

WWP	WOW
PO01	WNO
PO02	WSO
PO03	WNF(Natural Oak on Flat Cut)
PO07	WSF(Salted Oak on Flat Cut)
PO08	WSF(Salted Oak on Flat Cut)
PO09	WSF(Salted Oak on Flat Cut)
WBW	
WSW	
WEC	

3 Select Feet Finish

Click to view edges

WWP	WOW
PO01	WNO
PO02	WSO
PO03	
PO07	
PO08	
PO09	
WBW	
WSW	
WEC	

4 Select Edge

Click to view details

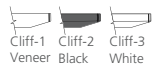

GEC	LW05
GWL	LW06
LP01	
LF02	
LF03	
LN01	
LA02	
LW01	
LW02	
LW04	

WWP	WOW
PO01	WNO
PO02	WSO
PO03	
PO07	
PO08	
PO09	
WBW	
WSW	
WEC	



MOC
MEC
MSW
MTW
MWL
MNA

WWP	WOW
PO01	WNO
PO02	WSO
PO03	
PO07	
PO08	
PO09	
WBW	
WSW	



High Pressure Laminate Top Upholstered Panels - COM\$

HNY340150FT579G	48892
HNY303150FT579G	43290
HNY265150FT579G	37688
HNY228150FT579G	32086
HNY191150FT579G	26484
HNY153150FT579G	20882
HNY116150FT579G	15280

Thermally Fused Laminate Top Upholstered Panels - COM\$

HNY340150FT579M	45836
HNY303150FT579M	40616
HNY265150FT579M	35396
HNY228150FT579M	30176
HNY191150FT579M	24956
HNY153150FT579M	19736
HNY116150FT579M	14516

[Click here to view statement of line](#)

Product Features

- 5" Solid wood feet - oval shape
- HNY7226WT162 Fixed Desk Height worksurfaces, 29" worksurface height
- Ships KD
- T75 worksurface wire cutout is standard on all worksurfaces.(T75D: Delete cutout is optional)

Options

Accessories

- K28: Articulating Keyboard w/ Mouse - \$390
- K31-SK: Center drawer w/ skirt - \$310
- K31: Center drawer w/o skirt - \$205

Concealed Floor Power Infeed Cover

- PCEB: White Metal Finish concealed floor power infeed cover - \$150

Delete Top

- DFT: Delete fixed top. Deduct \$1125 Veneer(W), \$955 High Pressure Laminate (G), \$630 Thermally Fused Laminate (M) per top

Metal Feet

- MTL10: Replace solid wood feet with metal feet, standard MFW White - \$55 ea

Premium Metal Finish

- Specify premium Metal Finish. MFMB: Matte Black, MFS: Silver, MFSS: Salmon Sienna, MFSA: Surfing Aquavert, MFPS: Pistachio, MFOS: Oyster, MFNA: Navy, MFOL: Olive, MFGB: Grey Beige MFGG: Graphite Gray, MFG: Gray, MFGM:Matte Gold
- Premium Metal Finish for WMT Wire Management Tray - \$75 ea
- Premium Metal Finish for MTL10 Metal Feet - \$20 ea
- Premium Metal Finish for PCEB Concealed Floor Power Infeed Cover - \$35

Starter Panel

- RSP: Substitute round starter panel in place of flat starter panel. Must substitute all starters, priced per starter panel - \$83 each. See HNY3555SP888

Worksurface Height

- Modify worksurface height to bar height.
- THL-42: Position worksurface at bar height - N/C

Wire Tray

- WMT: Wire metal tray. Mounts under top and comes standard in MFW White - \$210

Double Hexagon Workstation Typical
Position 1 Desk with Power Fixed Worksurface

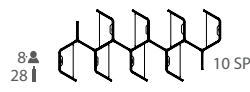
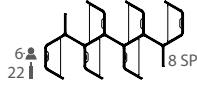
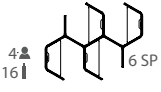
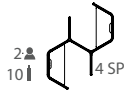

Number of Feet per Typical (MTL10 Option) "SP" Number of Starter Panels per Typical (RSP Option)

2

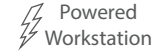
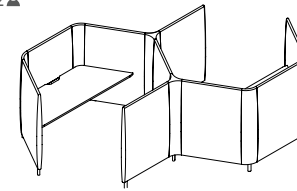

1 Select Model

w" x d" x h"	Weight	Standard Veneer Top Upholstered Panels - COM\$	Premium Veneer Top Upholstered Panels - COM\$
340 x 150 x 55	103	8 HNY340150FP579W 54604	"P" Option N/A
303 x 150 x 55	92	7 HNY303150FP579W 48256	"P" Option N/A
265 x 150 x 55	80	6 HNY265150FP579W 42058	"P" Option N/A
228 x 150 x 55	69	5 HNY228150FP579W 35785	"P" Option N/A
191 x 150 x 55	57	4 HNY191150FP579W 29512	"P" Option N/A
153 x 150 x 55	46	3 HNY153150FP579W 23164	"P" Option N/A
116 x 150 x 55	34	2 HNY116150FP579W 16951	"P" Option N/A

2 Select Finish

Click to view finishes	WWP	WOW
	PO01	WNO
	PO02	WSO
	PO03	WNF(Natural Oak on Flat Cut)
	PO08	WSF(Salted Oak on Flat Cut)
	PO09	
	WBW	
	WSW	
	WEC	

3 Select Feet Finish

Click to view edges	WWP	WOW
	PO01	WNO
	PO02	WSO
	PO03	
	PO07	
	PO08	
	PO09	
	WBW	
	WSW	
	WEC	

4 Select Edge

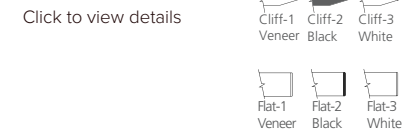

High Pressure Laminate Top Upholstered Panels - COM\$

HNY340150FP579G	53004
HNY303150FP579G	46856
HNY265150FP579G	40858
HNY228150FP579G	34785
HNY191150FP579G	28712
HNY153150FP579G	22564
HNY116150FP579G	16551

GEC	LW05
GWL	LW06
LP01	
LF02	
LF03	
LN01	
LA02	
LW01	
LW02	
LW04	

WWP	WOW
PO01	WNO
PO02	WSO
PO03	
PO07	
PO08	
PO09	
WBW	
WSW	
WEC	



Thermally Fused Laminate Top Upholstered Panels - COM\$

HNY340150FP579M	49948
HNY303150FP579M	44182
HNY265150FP579M	38566
HNY228150FP579M	32875
HNY191150FP579M	27184
HNY153150FP579M	21418
HNY116150FP579M	15787

MOC
MEC
MSW
MTW
MWL
MNA

WWP	WOW
PO01	WNO
PO02	WSO
PO03	
PO07	
PO08	
PO09	
WEC	
WBW	
WSW	



Click here to view statement of line

Product Features

- HNY7226WT162 Fixed Desk Height worksurfaces, 29" worksurface height
- 5" Solid wood feet - oval shape
- 4 Power outlets with 1 telecom plate, see options below for telecom plate
- Ships KD
- Wire management tray attaches to worksurface top, standard in MFW White, see premium Metal Finish for options
- Hardwire infeed and jumpers are included in workstations
- T75 worksurface wire cutout is standard on all worksurfaces.(T75D: Delete cutout is optional)

Options

Accessories

- K28: Articulating Keyboard w/ Mouse - \$390
- K31-SK: Center drawer w/ skirt - \$310
- K31: Center drawer w/o skirt - \$205

Concealed Floor Power Infeed Cover

- PCEB: White Metal Finish concealed floor power infeed cover - \$150

Delete Top and Wire Tray

- DFP: Delete fixed top. Deduct \$1335 Veneer (W), \$1165 High Pressure Laminate (G), \$840 Thermally Fused Laminate (M) per top

Metal Feet

- MTL10: Replace solid wood feet with metal feet, standard MFW White - \$55 ea

Premium Metal Finish

- Specify premium Metal Finish. MFMB: Matte Black, MFS: Silver, MFSS: Salmon Sienna, MFSA: Surfing Aquavert, MFPS: Pistachio, MFOS: Oyster, MFNA: Navy, MFOL: Olive, MFGB: Grey Beige MFGG: Graphite Gray, MFG: Gray, MFGM:Matte Gold
- Premium Metal Finish for WMT Wire Management Tray - \$75 ea
- Premium Metal Finish for MTL10 Metal Feet - \$20 ea
- Premium Metal Finish for PCEB Concealed Floor Power Infeed Cover - \$35

Starter Panel

- RSP: Substitute round starter panel in place of flat starter panel. Must substitute all starters, priced per starter panel - \$83 each. See HNY3555SP888

Telecom Plates

- Each power unit has 1 plate. All telecom connectors sold separately.
- RJ45 (1) - \$55, RJ45 (2) - \$110, RJ45 (3) - \$165, USB (1) - \$70, USB (2) - \$140, RJ45/USB - \$125, RJ45/HDMI - \$210, HDMI/USB - \$205

Worksurface Height

- THL-42: Modify worksurface height to bar height - N/C

DARRAN

Honey

Double Hexagon Workstation Typical
Position 2 Desk with Height Adjustable Worksurface

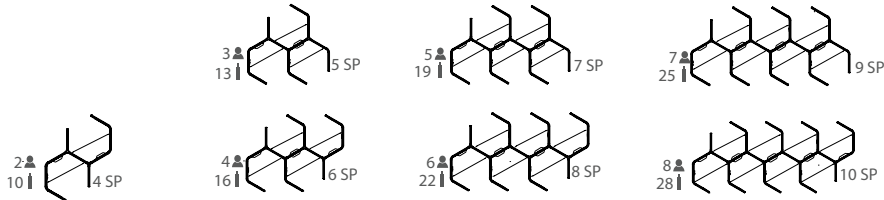

Number of Feet per Typical (MTL10 Option) "SP" Number of Starter Panels per Typical (RSP Option)

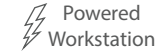
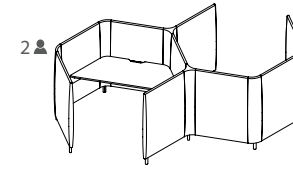

1 Select Model

w" x d" x h"	Weight	Standard Veneer Top Upholstered Panels - COM\$	Premium Veneer Top Upholstered Panels - COM\$	High Pressure Laminate Top Upholstered Panels - COM\$	Thermally Fused Laminate Top Upholstered Panels - COM\$
340 x 150 x 55	103	8 HNY340150HA580W 71969	"P" Option N/A	HNY340150HA580G 70361	HNY340150HA580M 67305
303 x 150 x 55	92	7 HNY303150HA580W 63405	"P" Option N/A	HNY303150HA580G 61998	HNY303150HA580M 59324
265 x 150 x 55	80	6 HNY265150HA580W 55112	"P" Option N/A	HNY265150HA580G 53906	HNY265150HA580M 51614
228 x 150 x 55	69	5 HNY228150HA580W 46548	"P" Option N/A	HNY228150HA580G 45543	HNY228150HA580M 43633
191 x 150 x 55	57	4 HNY191150HA580W 38255	"P" Option N/A	HNY191150HA580G 37451	HNY191150HA580M 35923
153 x 150 x 55	46	3 HNY153150HA580W 29691	"P" Option N/A	HNY153150HA580G 29088	HNY153150HA580M 27942
116 x 150 x 55	34	2 HNY116150HA580W 21398	"P" Option N/A	HNY116150HA580G 20996	HNY116150HA580M 20232

[Click Here for Graded in Pricing](#)

2 Select Finish

Click to view finishes

WWP	WOW
PO01	WNO
PO02	WSO
PO03	WNF(Natural Oak on Flat Cut)
PO07	WSF(Salted Oak on Flat Cut)
PO08	WSF(Salted Oak on Flat Cut)
PO09	WSF(Salted Oak on Flat Cut)
WBW	
WSW	
WEC	

3 Select Feet Finish

Click to view edges

WWP	WOW
PO01	WNO
PO02	WSO
PO03	
PO07	
PO08	
PO09	
WBW	
WSW	
WEC	

4 Select Edge

Click to view details

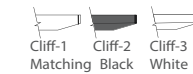

[Click here to view statement of line](#)

Product Features

- 5" Solid wood feet - oval shape, ships KD
- 4 Power outlets with 1 telecom plate, see options below for telecom plate
- Adjustable height from 27" to 47.5" with a maximum weight capacity of 275 lbs. Lift standard in MFW White, optional MFB Black
- HNY7125WT163 Height Adjustable worksurfaces are included
- Wire management tray attaches to worksurface top, standard in MFW White, see premium Metal Finish for options
- T75 worksurface wire cutout is standard on all worksurfaces.(T75D: Delete cutout is optional)

Notes

- 1" Gap between worksurface and panels to drop wires below worksurface
- Metal parts include 5 year warranty
- Programmable height adjustable mechanism, motor includes 2 year warranty

Options

Accessories

- K28: Articulating Keyboard w/ Mouse - \$390
- K31-SK: Center drawer w/ skirt - \$310
- K31: Center drawer w/o skirt - \$205

Concealed Floor Power Infeed Cover

- PCEB: White Metal Finish concealed floor power infeed cover - \$150

Delete Top and Wire Tray

- DHAT: Delete height adjustable top. Deduct \$3265 Veneer(W), \$3095 High Pressure Laminate(G), \$2770 Thermally Fused Laminate(M) per top

Metal Feet

- MTL10: Replace solid wood feet with metal feet, standard MFW White - \$55 ea

Premium Metal Finish

- Specify premium Metal Finish. MFMB: Matte Black, MFS: Silver, MFSS: Salmon Sienna, MFSA: Surfin Aquavert, MFPS: Pistachio, MFOS: Oyster, MFNA: Navy, MFOL: Olive, MFGB: Grey Beige MFGG: Graphite Gray, MFG: Gray, MFGM:Matte Gold
- Premium Metal Finish for WMT Wire Management Tray - \$75 ea
- Premium Metal Finish for MTL10 Metal Feet - \$20 ea
- Premium Metal Finish for PCEB Concealed Floor Power Infeed Cover - \$35

Starter Panel

- RSP: Substitute round starter panel in place of flat starter panel. Must substitute all starters, priced per starter panel - \$83 each. See HNY3555SP888

Telecom Plates

- Each power unit has 1 plate. All telecom connectors sold separately.
- RJ45 (1) - \$55, RJ45 (2) - \$110, RJ45 (3) - \$165, USB (1) - \$70, USB (2) - \$140, RJ45/USB - \$125, RJ45/HDMI - \$210, HDMI/USB - \$205

DARRAN

Honey

Double Hexagon Workstation Typical
Position 2 Desk with Fixed Worksurface

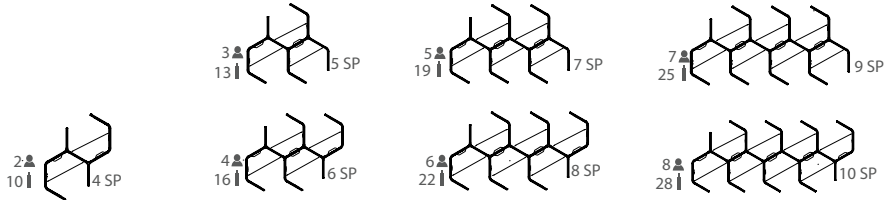

Number of Feet per Typical (MTL10 Option) "SP" Number of Starter Panels per Typical (RSP Option)

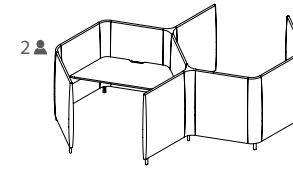

Fixed Top Workstation



Non-Powered Workstation

1 Select Model

w" x d" x h"	Weight	Standard Veneer Top Upholstered Panels - COM\$	Premium Veneer Top Upholstered Panels - COM\$	High Pressure Laminate Top Upholstered Panels - COM\$	Thermally Fused Laminate Top Upholstered Panels - COM\$
340 x 150 x 55	103	8 HNY340150FT580W 50492	"P" Option N/A	HNY340150FT580G 48892	HNY340150FT580M 45836
303 x 150 x 55	92	7 HNY303150FT580W 44690	"P" Option N/A	HNY303150FT580G 43290	HNY303150FT580M 40616
265 x 150 x 55	80	6 HNY265150FT580W 38888	"P" Option N/A	HNY265150FT580G 37688	HNY265150FT580M 35396
228 x 150 x 55	69	5 HNY228150FT580W 33086	"P" Option N/A	HNY228150FT580G 32086	HNY228150FT580M 30176
191 x 150 x 55	57	4 HNY191150FT580W 27284	"P" Option N/A	HNY191150FT580G 26484	HNY191150FT580M 24956
153 x 150 x 55	46	3 HNY153150FT580W 21482	"P" Option N/A	HNY153150FT580G 20882	HNY153150FT580M 19736
116 x 150 x 55	34	2 HNY116150FT580W 15680	"P" Option N/A	HNY116150FT580G 15280	HNY116150FT580M 14516

[Click Here for Graded in Pricing](#)

2 Select Finish

Click to view finishes

WWP	WOW
PO01	WNO
PO02	WSO
PO03	WNF(Natural Oak on Flat Cut)
PO07	WSF(Salted Oak on Flat Cut)
PO08	WSF(Salted Oak on Flat Cut)
PO09	WSF(Salted Oak on Flat Cut)
WBW	
WSW	
WEC	

3 Select Feet Finish

Click to view edges

WWP	WOW
PO01	WNO
PO02	WSO
PO03	
PO07	
PO08	
PO09	
WBW	
WSW	
WEC	

4 Select Edge

Click to view details



GEC	LW05
GWL	LW06
LP01	
LF02	
LF03	
LN01	
LA02	
LW01	
LW02	
LW04	

WWP	WOW
PO01	WNO
PO02	WSO
PO03	
PO07	
PO08	
PO09	
WBW	
WSW	
WEC	



MOC
MEC
MSW
MTW
MWL
MNA

WWP	WOW
PO01	WNO
PO02	WSO
PO03	
PO07	
PO08	
PO09	
WBW	
WSW	



[Click here to view statement of line](#)

Product Features

- 5" Solid wood feet - oval shape
- HNY7226WT162 Fixed Desk Height worksurfaces, 29" worksurface height
- Ships KD
- T75 worksurface wire cutout is standard on all worksurfaces.(T75D: Delete cutout is optional)

Options

Accessories

- K28: Articulating Keyboard w/ Mouse - \$390
- K31-SK: Center drawer w/ skirt - \$310
- K31: Center drawer w/o skirt - \$205

Concealed Floor Power Infeed Cover

- PCEB: White Metal Finish concealed floor power infeed cover - \$150

Delete Top

- DFT: Delete fixed top. Deduct \$1125 Veneer(W), \$955 High Pressure Laminate (G), \$630 Thermally Fused Laminate (M) per top

Metal Feet

- MTL10: Replace solid wood feet with metal feet, standard MFW White - \$55 ea

Premium Metal Finish

- Specify premium Metal Finish. MFMB: Matte Black, MFS: Silver, MFSS: Salmon Sienna, MFSA: Surfing Aquavert, MFPS: Pistachio, MFOS: Oyster, MFNA: Navy, MFOL: Olive, MFGB: Grey Beige MFGG: Graphite Gray, MFG: Gray, MFGM:Matte Gold
- Premium Metal Finish for WMT Wire Management Tray - \$75 ea
- Premium Metal Finish for MTL10 Metal Feet - \$20 ea
- Premium Metal Finish for PCEB Concealed Floor Power Infeed Cover - \$35

Starter Panel

- RSP: Substitute round starter panel in place of flat starter panel. Must substitute all starters, priced per starter panel - \$83 each. See HNY3555SP888

Worksurface Height

- Modify worksurface height to bar height.
- THL-42: Position worksurface at bar height - N/C

Wire Tray

- WMT: Wire metal tray. Mounts under top and comes standard in MFW White - \$210

DARRAN

Honey

Double Hexagon Workstation Typical
Position 2 Desk with Power Fixed Worksurface

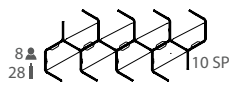
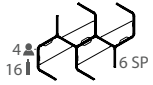
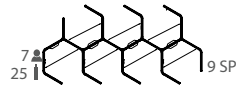
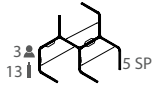
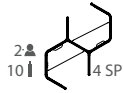

Number of Feet per Typical (MTL10 Option) "SP" Number of Starter Panels per Typical (RSP Option)

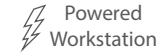
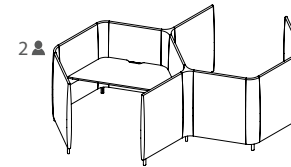

1 Select Model

w" x d" x h"	Weight	Standard Veneer Top Upholstered Panels - COM\$	Premium Veneer Top Upholstered Panels - COM\$	High Pressure Laminate Top Upholstered Panels - COM\$	Thermally Fused Laminate Top Upholstered Panels - COM\$
340 x 150 x 55	103	8 HNY340150FP580W 53641	"P" Option N/A	HNY340150FP580G 52041	HNY340150FP580M 48985
303 x 150 x 55	92	7 HNY303150FP580W 47368	"P" Option N/A	HNY303150FP580G 45968	HNY303150FP580M 43294
265 x 150 x 55	80	6 HNY265150FP580W 41366	"P" Option N/A	HNY265150FP580G 40166	HNY265150FP580M 37874
228 x 150 x 55	69	5 HNY228150FP580W 35093	"P" Option N/A	HNY228150FP580G 34093	HNY228150FP580M 32183
191 x 150 x 55	57	4 HNY191150FP580W 29091	"P" Option N/A	HNY191150FP580G 28291	HNY191150FP580M 26763
153 x 150 x 55	46	3 HNY153150FP580W 22818	"P" Option N/A	HNY153150FP580G 22218	HNY153150FP580M 21072
116 x 150 x 55	34	2 HNY116150FP580W 16816	"P" Option N/A	HNY116150FP580G 16416	HNY116150FP580M 15652

[Click Here for Graded in Pricing](#)

2 Select Finish

Click to view finishes

WWP	WOW
PO01	WNO
PO02	WSO
PO03	WNF(Natural Oak on Flat Cut)
PO07	WSF(Salted Oak on Flat Cut)
PO08	WSF(Salted Oak on Flat Cut)
PO09	WSF(Salted Oak on Flat Cut)
WBW	
WSW	
WEC	

3 Select Feet Finish

Click to view edges

WWP	WOW
PO01	WNO
PO02	WSO
PO03	
PO07	
PO08	
PO09	
WBW	
WSW	
WEC	

4 Select Edge

Click to view details



GEC	LW05
GWL	LW06
LP01	
LF02	
LF03	
LN01	
LA02	
LW01	
LW02	
LW04	

WWP	WOW
PO01	WNO
PO02	WSO
PO03	
PO07	
PO08	
PO09	
WBW	
WSW	
WEC	



MOC
MEC
MSW
MTW
MWL
MNA

WWP	WOW
PO01	WNO
PO02	WSO
PO03	
PO07	
PO08	
PO09	
WEC	
WBW	
WSW	



[Click here to view statement of line](#)

Product Features

- HNY7226WT162 Fixed Desk Height worksurfaces, 29" worksurface height
- 5" Solid wood feet - oval shape
- 4 Power outlets with 1 telecom plate, see options below for telecom plate
- Ships KD
- Wire management tray attaches to worksurface top, standard in MFW White, see premium Metal Finish for options
- Hardwire infeed and jumpers are included in workstations
- T75 worksurface wire cutout is standard on all worksurfaces.(T75D: Delete cutout is optional)

Options

Accessories

- K28: Articulating Keyboard w/ Mouse - \$390
- K31-SK: Center drawer w/ skirt - \$310
- K31: Center drawer w/o skirt - \$205

Concealed Floor Power Infeed Cover

- PCEB: White Metal Finish concealed floor power infeed cover - \$150

Delete Top and Wire Tray

- DFP: Delete fixed top. Deduct \$1335 Veneer (W), \$1165 High Pressure Laminate (G), \$840 Thermally Fused Laminate (M) per top

Metal Feet

- MTL10: Replace solid wood feet with metal feet, standard MFW White - \$55 ea

Premium Metal Finish

- Specify premium Metal Finish. MFMB: Matte Black, MFS: Silver, MFSS: Salmon Sienna, MFSA: Surfing Aquavert, MFPS: Pistachio, MFOS: Oyster, MFNA: Navy, MFOL: Olive, MFGB: Grey Beige MFGG: Graphite Gray, MFG: Gray, MFGM:Matte Gold
- Premium Metal Finish for WMT Wire Management Tray - \$75 ea
- Premium Metal Finish for MTL10 Metal Feet - \$20 ea
- Premium Metal Finish for PCEB Concealed Floor Power Infeed Cover - \$35

Starter Panel

- RSP: Substitute round starter panel in place of flat starter panel. Must substitute all starters, priced per starter panel - \$83 each. See HNY3555SP888

Telecom Plates

- Each power unit has 1 plate. All telecom connectors sold separately.
- RJ45 (1) - \$55, RJ45 (2) - \$110, RJ45 (3) - \$165, USB (1) - \$70, USB (2) - \$140, RJ45/USB - \$125, RJ45/HDMI - \$210, HDMI/USB - \$205

Worksurface Height

- THL-42: Modify worksurface height to bar height - N/C

DARRAN

Honey

Double Hexagon Workstation Typical Position 3 Desk with Height Adjustable Worksurface

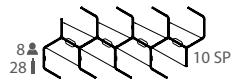
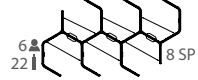
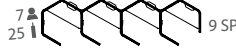
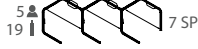
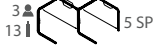

Number of Feet per Typical (MTL10 Option) "SP" Number of Starter Panels per Typical (RSP Option)

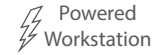
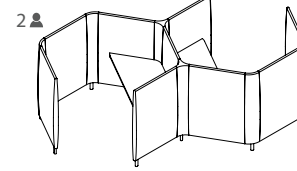

1 Select Model

w" x d" x h"	Weight	Standard Veneer Top Upholstered Panels - COM\$	Premium Veneer Top Upholstered Panels - COM\$	High Pressure Laminate Top Upholstered Panels - COM\$	Thermally Fused Laminate Top Upholstered Panels - COM\$
340 x 150 x 55	103	8 HNY340150HA581W 71698	"P" Option N/A	HNY340150HA581G 70090	HNY340150HA581M 67034
303 x 150 x 55	92	7 HNY303150HA581W 63405	"P" Option N/A	HNY303150HA581G 61998	HNY303150HA581M 59324
265 x 150 x 55	80	6 HNY265150HA581W 54841	"P" Option N/A	HNY265150HA581G 53635	HNY265150HA581M 51343
228 x 150 x 55	69	5 HNY228150HA581W 46548	"P" Option N/A	HNY228150HA581G 45543	HNY228150HA581M 43633
191 x 150 x 55	57	4 HNY191150HA581W 37984	"P" Option N/A	HNY191150HA581G 37180	HNY191150HA581M 35652
153 x 150 x 55	46	3 HNY153150HA581W 29691	"P" Option N/A	HNY153150HA581G 29088	HNY153150HA581M 27942
116 x 150 x 55	34	2 HNY116150HA581W 21127	"P" Option N/A	HNY116150HA581G 20725	HNY116150HA581M 19961

2 Select Finish

Click to view finishes

WWP	WOW
PO01	WNO
PO02	WSO
PO03	WNF(Natural Oak on Flat Cut)
PO07	WSF(Salted Oak on Flat Cut)
PO08	
PO09	
WBW	
WSW	
WEC	

3 Select Feet Finish

Click to view edges

WWP	WOW
PO01	WNO
PO02	WSO
PO03	
PO07	
PO08	
PO09	
WBW	
WSW	
WEC	

4 Select Edge

Click to view details

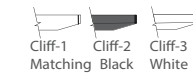

[Click here to view statement of line](#)

Product Features

- 5" Solid wood feet - oval shape, ships KD
- 4 Power outlets with 1 telecom plate, see options below for telecom plate
- Adjustable height from 27" to 47.5" with a maximum weight capacity of 275 lbs. Lift standard in MFW White, optional MFB Black
- HNY7125WT163 Height Adjustable worksurfaces are included
- Wire management tray attaches to worksurface top, standard in MFW White, see premium Metal Finish for options
- T75 worksurface wire cutout is standard on all worksurfaces.(T75D: Delete cutout is optional)

Notes

- 1" Gap between worksurface and panels to drop wires below worksurface
- Metal parts include 5 year warranty
- Programmable height adjustable mechanism, motor includes 2 year warranty

Options

Accessories

- K28: Articulating Keyboard w/ Mouse - \$390
- K31-SK: Center drawer w/ skirt - \$310
- K31: Center drawer w/o skirt - \$205

Concealed Floor Power Infeed Cover

- PCEB: White Metal Finish concealed floor power infeed cover - \$150

Delete Top and Wire Tray

- DHAT: Delete height adjustable top. Deduct \$3265 Veneer(W), \$3095 High Pressure Laminate(G), \$2770 Thermally Fused Laminate(M) per top

Metal Feet

- MTL10: Replace solid wood feet with metal feet, standard MFW White - \$55 ea

Premium Metal Finish

- Specify premium Metal Finish. MFMB: Matte Black, MFS: Silver, MFSS: Salmon Sienna, MFSA: Surfin Aquavert, MFPS: Pistachio, MFOS: Oyster, MFNA: Navy, MFOL: Olive, MFGB: Grey Beige MFGG: Graphite Gray, MFG: Gray, MFGM:Matte Gold
- Premium Metal Finish for WMT Wire Management Tray - \$75 ea
- Premium Metal Finish for MTL10 Metal Feet - \$20 ea
- Premium Metal Finish for PCEB Concealed Floor Power Infeed Cover - \$35

Starter Panel

- RSP: Substitute round starter panel in place of flat starter panel. Must substitute all starters, priced per starter panel - \$83 each. See HNY3555SP888

Telecom Plates

- Each power unit has 1 plate. All telecom connectors sold separately.
- RJ45 (1) - \$55, RJ45 (2) - \$110, RJ45 (3) - \$165, USB (1) - \$70, USB (2) - \$140, RJ45/USB - \$125, RJ45/HDMI - \$210, HDMI/USB - \$205

DARRAN

Honey Double Hexagon Workstation Typical
Position 3 Desk with Fixed Worksurface

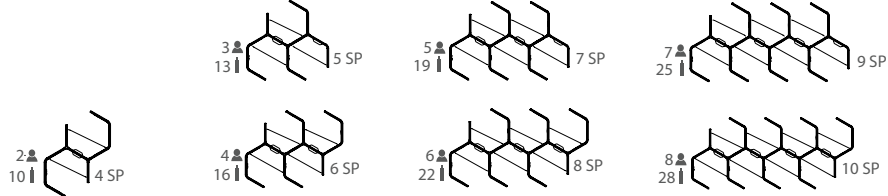

Number of Feet per Typical (MTL10 Option) "SP" Number of Starter Panels per Typical (RSP Option)

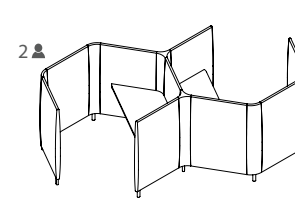

Fixed Top Workstation

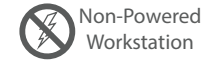

1 Select Model

w" x d" x h"	Weight	Standard Veneer Top Upholstered Panels - COM\$	Premium Veneer Top Upholstered Panels - COM\$
340 x 150 x 55	103	8 HNY340150FT581W 50492	"P" Option N/A
303 x 150 x 55	92	7 HNY303150FT581W 44690	"P" Option N/A
265 x 150 x 55	80	6 HNY265150FT581W 38888	"P" Option N/A
228 x 150 x 55	69	5 HNY228150FT581W 33086	"P" Option N/A
191 x 150 x 55	57	4 HNY191150FT581W 27284	"P" Option N/A
153 x 150 x 55	46	3 HNY153150FT581W 21482	"P" Option N/A
116 x 150 x 55	34	2 HNY116150FT581W 15680	"P" Option N/A

[Click Here for Graded in Pricing](#)

2 Select Finish

Click to view finishes

WWP	WOW
PO01	WNO
PO02	WSO
PO03	WNF(Natural Oak on Flat Cut)
PO07	WSF(Salted Oak on Flat Cut)
PO08	
PO09	
WBW	
WSW	
WEC	

3 Select Feet Finish

Click to view edges

WWP	WOW
PO01	WNO
PO02	WSO
PO03	
PO07	
PO08	
PO09	
WBW	
WSW	
WEC	

4 Select Edge

Click to view details

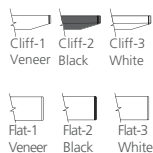

High Pressure Laminate Top Upholstered Panels - COM\$

HNY340150FT581G	48892
HNY303150FT581G	43290
HNY265150FT581G	37688
HNY228150FT581G	32086
HNY191150FT581G	26484
HNY153150FT581G	20882
HNY116150FT581G	15280

GEC	LW05
GWL	LW06
LP01	
LF02	
LF03	
LN01	
LA02	
LW01	
LW02	
LW04	

WWP	WOW
PO01	WNO
PO02	WSO
PO03	
PO07	
PO08	
PO09	
WBW	
WSW	
WEC	

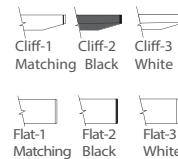

Thermally Fused Laminate Top Upholstered Panels - COM\$

HNY340150FT581M	45836
HNY303150FT581M	40616
HNY265150FT581M	35396
HNY228150FT581M	30176
HNY191150FT581M	24956
HNY153150FT581M	19736
HNY116150FT581M	14516

MOC
MEC
MSW
MTW
MWL
MNA

WWP	WOW
PO01	WNO
PO02	WSO
PO03	
PO07	
PO08	
PO09	
WBW	
WSW	



[Click here to view statement of line](#)

Product Features

- 5" Solid wood feet - oval shape
- HNY7226WT162 Fixed Desk Height worksurfaces, 29" worksurface height
- Ships KD
- T75 worksurface wire cutout is standard on all worksurfaces.(T75D: Delete cutout is optional)

Options

Accessories

- K28: Articulating Keyboard w/ Mouse - \$390
- K31-SK: Center drawer w/ skirt - \$310
- K31: Center drawer w/o skirt - \$205

Concealed Floor Power Infeed Cover

- PCEB: White Metal Finish concealed floor power infeed cover - \$150

Delete Top

- DFT: Delete fixed top. Deduct \$1125 Veneer(W), \$955 High Pressure Laminate (G), \$630 Thermally Fused Laminate (M) per top

Metal Feet

- MTL10: Replace solid wood feet with metal feet, standard MFW White - \$55 ea

Premium Metal Finish

- Specify premium Metal Finish. MFMB: Matte Black, MFS: Silver, MFSS: Salmon Sienna, MFSA: Surfing Aquavert, MFPS: Pistachio, MFOS: Oyster, MFNA: Navy, MFOL: Olive, MFGB: Grey Beige MFGG: Graphite Gray, MFG: Gray, MFGM:Matte Gold
- Premium Metal Finish for WMT Wire Management Tray - \$75 ea
- Premium Metal Finish for MTL10 Metal Feet - \$20 ea
- Premium Metal Finish for PCEB Concealed Floor Power Infeed Cover - \$35

Starter Panel

- RSP: Substitute round starter panel in place of flat starter panel. Must substitute all starters, priced per starter panel - \$83 each. See HNY3555SP888

Worksurface Height

- Modify worksurface height to bar height.
- THL-42: Position worksurface at bar height - N/C

Wire Tray

- WMT: Wire metal tray. Mounts under top and comes standard in MFW White - \$210

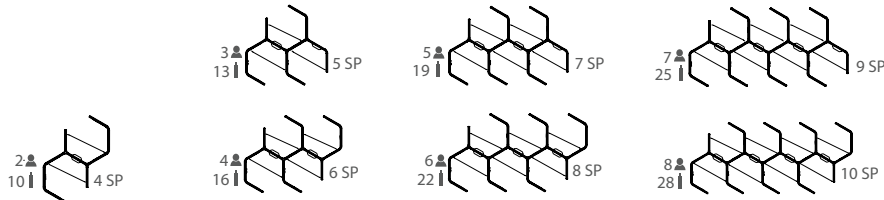

Number of Feet per Typical (MTL10 Option) "SP" Number of Starter Panels per Typical (RSP Option)

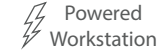
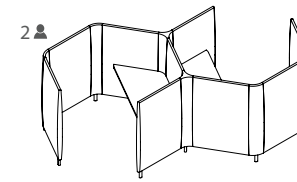

1 Select Model

Weight	Standard Veneer Top Upholstered Panels - COM\$	Premium Veneer Top Upholstered Panels - COM\$	High Pressure Laminate Top Upholstered Panels - COM\$	Thermally Fused Laminate Top Upholstered Panels - COM\$
340 x 150 x 55	103 8 HNY340150FP581W 53370	"P" Option N/A	HNY340150FP581G 51770	HNY340150FP581M 48714
303 x 150 x 55	92 7 HNY303150FP581W 47368	"P" Option N/A	HNY303150FP581G 45968	HNY303150FP581M 43294
265 x 150 x 55	80 6 HNY265150FP581W 41095	"P" Option N/A	HNY265150FP581G 39895	HNY265150FP581M 37603
228 x 150 x 55	69 5 HNY228150FP581W 35093	"P" Option N/A	HNY228150FP581G 34093	HNY228150FP581M 32183
191 x 150 x 55	57 4 HNY191150FP581W 28820	"P" Option N/A	HNY191150FP581G 28020	HNY191150FP581M 26492
153 x 150 x 55	46 3 HNY153150FP581W 22818	"P" Option N/A	HNY153150FP581G 22218	HNY153150FP581M 21072
116 x 150 x 55	34 2 HNY116150FP581W 16545	"P" Option N/A	HNY116150FP581G 16145	HNY116150FP581M 15381

[Click Here for Graded in Pricing](#)

2 Select Finish

Click to view finishes

WWP	WOW
PO01	WNO
PO02	WSO
PO03	WNF(Natural Oak on Flat Cut)
PO07	WSF(Salted Oak on Flat Cut)
PO08	WSF(Salted Oak on Flat Cut)
PO09	WSF(Salted Oak on Flat Cut)
WBW	
WSW	
WEC	

3 Select Feet Finish

Click to view edges

WWP	WOW
PO01	WNO
PO02	WSO
PO03	
PO07	
PO08	
PO09	
WBW	
WSW	
WEC	

4 Select Edge

Click to view details

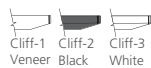

GEC	LW05
GWL	LW06
LP01	
LF02	
LF03	
LN01	
LA02	
LW01	
LW02	
LW04	

WWP	WOW
PO01	WNO
PO02	WSO
PO03	
PO07	
PO08	
PO09	
WBW	
WSW	
WEC	



MOC
MEC
MSW
MTW
MWL
MNA

WWP	WOW
PO01	WNO
PO02	WSO
PO03	
PO07	
PO08	
PO09	
WEC	
WBW	
WSW	



[Click here to view statement of line](#)

Product Features

- HNY7226WT162 Fixed Desk Height worksurfaces, 29" worksurface height
- 5" Solid wood feet - oval shape
- 4 Power outlets with 1 telecom plate, see options below for telecom plate
- Ships KD
- Wire management tray attaches to worksurface top, standard in MFW White, see premium Metal Finish for options
- Hardwire infeed and jumpers are included in workstations
- T75 worksurface wire cutout is standard on all worksurfaces.(T75D: Delete cutout is optional)

Options

Accessories

- K28: Articulating Keyboard w/ Mouse - \$390
- K31-SK: Center drawer w/ skirt - \$310
- K31: Center drawer w/o skirt - \$205

Concealed Floor Power Infeed Cover

- PCEB: White Metal Finish concealed floor power infeed cover - \$150

Delete Top and Wire Tray

- DFP: Delete fixed top. Deduct \$1335 Veneer (W), \$1165 High Pressure Laminate (G), \$840 Thermally Fused Laminate (M) per top

Metal Feet

- MTL10: Replace solid wood feet with metal feet, standard MFW White - \$55 ea

Premium Metal Finish

- Specify premium Metal Finish. MFMB: Matte Black, MFS: Silver, MFSS: Salmon Sienna, MFSA: Surfing Aquavert, MFPS: Pistachio, MFOS: Oyster, MFNA: Navy, MFOL: Olive, MFGB: Grey Beige MFGG: Graphite Gray, MFG: Gray, MFGM:Matte Gold
- Premium Metal Finish for WMT Wire Management Tray - \$75 ea
- Premium Metal Finish for MTL10 Metal Feet - \$20 ea
- Premium Metal Finish for PCEB Concealed Floor Power Infeed Cover - \$35

Starter Panel

- RSP: Substitute round starter panel in place of flat starter panel. Must substitute all starters, priced per starter panel - \$83 each. See HNY3555SP888

Telecom Plates

- Each power unit has 1 plate. All telecom connectors sold separately.
- RJ45 (1) - \$55, RJ45 (2) - \$110, RJ45 (3) - \$165, USB (1) - \$70, USB (2) - \$140, RJ45/USB - \$125, RJ45/HDMI - \$210, HDMI/USB - \$205

Worksurface Height

- THL-42: Modify worksurface height to bar height - N/C

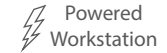
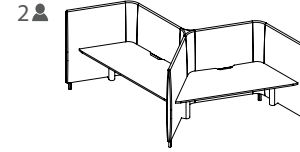
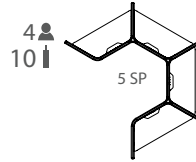
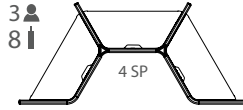
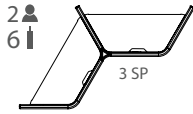

Number of Feet per Typical (MTL10 Option) "SP" Number of Starter Panels per Typical (RSP Option)

1 Select Model

w" x d" x h"	Weight	Standard Veneer Top Upholstered Panels - COM\$	Premium Veneer Top Upholstered Panels - COM\$	High Pressure Laminate Top Upholstered Panels - COM\$	Thermally Fused Laminate Top Upholstered Panels - COM\$
166 x 145 x 55	34	4 HNY166145HA582W 29027	"P" Option N/A	HNY166145HA582G 28223	HNY166145HA582M 26695
166 x 74 x 55	26	3 HNY16674HA582W 22174	"P" Option N/A	HNY16674HA582G 21571	HNY16674HA582M 20425
125 x 74 x 55	19	2 HNY12574HA582W 15321	"P" Option N/A	HNY12574HA582G 14919	HNY12574HA582M 14155
85 x 37 x 55	11	1 HNY8537HA582W 8468	"P" Option N/A	HNY8537HA582G 8267	HNY8537HA582M 7885

[Click Here for Graded in Pricing](#)

2 Select Finish

Click to view finishes

WWP	WOW
PO01	WNO
PO02	WSO
PO03	WNF(Natural Oak on Flat Cut)
PO07	WSF(Salted Oak on Flat Cut)
PO08	WSF(Salted Oak on Flat Cut)
PO09	WSF(Salted Oak on Flat Cut)
WBW	
WSW	
WEC	

3 Select Feet Finish

Click to view edges

WWP	WOW
PO01	WNO
PO02	WSO
PO03	
PO07	
PO08	
PO09	
WBW	
WSW	
WEC	

4 Select Edge

Click to view details



GEC	LW05
GWL	LW06
LP01	
LF02	
LF03	
LN01	
LA02	
LW01	
LW02	
LW04	

WWP	WOW
PO01	WNO
PO02	WSO
PO03	
PO07	
PO08	
PO09	
WBW	
WSW	
WEC	



MOC
MEC
MSW
MTW
MWL
MNA

WWP	WOW
PO01	WNO
PO02	WSO
PO03	
PO07	
PO08	
PO09	
WEC	
WBW	
WSW	



[Click here to view statement of line](#)

Product Features

- 5" Solid wood feet - oval shape, ships KD
- 4 Power outlets with 1 telecom plate, see options below for telecom plate
- Adjustable height from 27" to 47.5" with a maximum weight capacity of 275 lbs.
- Lift standard in MFW White, optional MFB Black
- HNY7125WT163 Height Adjustable worksurfaces are included
- Wire management tray attaches to worksurface top, standard in MFW White, see premium Metal Finish for options
- T75 worksurface wire cutout is standard on all worksurfaces.(T75D: Delete cutout is optional)

Notes

- 1" Gap between worksurface and panels to drop wires below worksurface
- Metal parts include 5 year warranty
- Programmable height adjustable mechanism, motor includes 2 year warranty

Options

Accessories

- K28: Articulating Keyboard w/ Mouse - \$390
- K31-SK: Center drawer w/ skirt - \$310
- K31: Center drawer w/o skirt - \$205

Concealed Floor Power Infeed Cover

- PCEB: White Metal Finish concealed floor power infeed cover - \$150

Delete Top and Wire Tray

- DHAT: Delete height adjustable top. Deduct \$3265 Veneer(W), \$3095 High Pressure Laminate(G), \$2770 Thermally Fused Laminate(M) per top

Metal Feet

- MTL10: Replace solid wood feet with metal feet, standard MFW White - \$55 ea

Premium Metal Finish

- Specify premium Metal Finish. MFMB: Matte Black, MFS: Silver, MFSS: Salmon Sienna, MFSA: Surfing Aquavert, MFPS: Pistachio, MFOS: Oyster, MFNA: Navy, MFOL: Olive, MFGB: Grey Beige MFGG: Graphite Gray, MFG: Gray, MFGM:Matte Gold
- Premium Metal Finish for WMT Wire Management Tray - \$75 ea
- Premium Metal Finish for MTL10 Metal Feet - \$20 ea
- Premium Metal Finish for PCEB Concealed Floor Power Infeed Cover - \$35

Starter Panel

- RSP: Substitute round starter panel in place of flat starter panel. Must substitute all starters, priced per starter panel - \$83 each. See HNY3555SP888

Telecom Plates

- Each power unit has 1 plate. All telecom connectors sold separately.
- RJ45 (1) - \$55, RJ45 (2) - \$110, RJ45 (3) - \$165, USB (1) - \$70, USB (2) - \$140, RJ45/USB - \$125, RJ45/HDMI - \$210, HDMI/USB - \$205

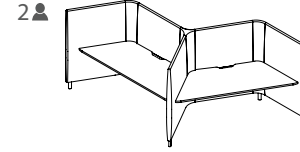
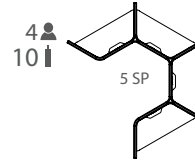
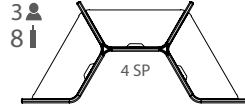
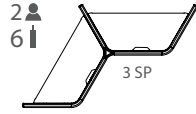

Number of Feet per Typical (MTL10 Option) "SP" Number of Starter Panels per Typical (RSP Option)

1 Select Model

w" x d" x h"	Weight	Standard Veneer Top Upholstered Panels - COM\$	Premium Veneer Top Upholstered Panels - COM\$
166 x 145 x 55	34	4 HNY166145FT582W 18290	"P" Option N/A
166 x 74 x 55	26	3 HNY16674FT582W 14070	"P" Option N/A
125 x 74 x 55	19	2 HNY12574FT582W 9850	"P" Option N/A
85 x 37 x 55	11	1 HNY8537FT582W 5630	"P" Option N/A

[Click Here for Graded in Pricing](#)

2 Select Finish

Click to view finishes

WWP	WOW
PO01	WNO
PO02	WSO
PO03	WNF(Natural Oak on Flat Cut)
PO07	WSF(Salted Oak on Flat Cut)
PO08	
PO09	
WBW	
WSW	
WEC	

3 Select Feet Finish

Click to view edges

WWP	WOW
PO01	WNO
PO02	WSO
PO03	
PO07	
PO08	
PO09	
WBW	
WSW	
WEC	

4 Select Edge

Click to view details



GEC	LW05
GWL	LW06
LP01	
LF02	
LF03	
LN01	
LA02	
LW01	
LW02	
LW04	

WWP	WOW
PO01	WNO
PO02	WSO
PO03	
PO07	
PO08	
PO09	
WBW	
WSW	
WEC	



MOC
MEC
MSW
MTW
MWL
MNA

WWP	WOW
PO01	WNO
PO02	WSO
PO03	
PO07	
PO08	
PO09	
WBW	
WSW	



[Click here to view statement of line](#)

Product Features

- 5" Solid wood feet - oval shape
- HNY7226WT162 Fixed Desk Height worksurfaces, 29" worksurface height
- Ships KD
- T75 worksurface wire cutout is standard on all worksurfaces.(T75D: Delete cutout is optional)

Options

Accessories

- K28: Articulating Keyboard w/ Mouse - \$390
- K31-SK: Center drawer w/ skirt - \$310
- K31: Center drawer w/o skirt - \$205

Concealed Floor Power Infeed Cover

- PCEB: White Metal Finish concealed floor power infeed cover - \$150

Delete Top

- DFT: Delete fixed top. Deduct \$1125 Veneer(W), \$955 High Pressure Laminate (G), \$630 Thermally Fused Laminate (M) per top

Metal Feet

- MTL10: Replace solid wood feet with metal feet, standard MFW White - \$55 ea

Premium Metal Finish

- Specify premium Metal Finish. MFMB: Matte Black, MFS: Silver, MFSS: Salmon Sienna, MFSA: Surfing Aquavert, MFPS: Pistachio, MFOS: Oyster, MFNA: Navy, MFOL: Olive, MFGB: Grey Beige MFGG: Graphite Gray, MFG: Gray, MFGM:Matte Gold

- Premium Metal Finish for WMT Wire Management Tray - \$75 ea

- Premium Metal Finish for MTL10 Metal Feet - \$20 ea

- Premium Metal Finish for PCEB Concealed Floor Power Infeed Cover - \$35

Starter Panel

- RSP: Substitute round starter panel in place of flat starter panel. Must substitute all starters, priced per starter panel - \$83 each. See HNY3555SP888

Worksurface Height

- Modify worksurface height to bar height.
- THL-42: Position worksurface at bar height - N/C

Wire Tray

- WMT: Wire metal tray. Mounts under top and comes standard in MFW White - \$210

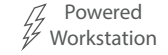
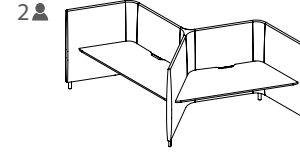
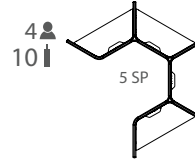
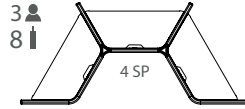
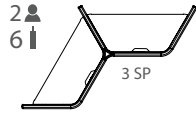

Number of Feet per Typical (MTL10 Option) "SP" Number of Starter Panels per Typical (RSP Option)

1 Select Model

w" x d" x h"	Weight	Standard Veneer Top Upholstered Panels - COM\$	Premium Veneer Top Upholstered Panels - COM\$
166 x 145 x 55	34	4 HNY166145FP582W 19863	"P" Option N/A
166 x 74 x 55	26	3 HNY16674FP582W 15301	"P" Option N/A
125 x 74 x 55	19	2 HNY12574FP582W 10739	"P" Option N/A
85 x 37 x 55	11	1 HNY8537FP582W 6177	"P" Option N/A

[Click Here for Graded in Pricing](#)

2 Select Finish

Click to view finishes

WWP	WOW
PO01	WNO
PO02	WSO
PO03	WNF(Natural Oak on Flat Cut)
PO07	WSF(Salted Oak on Flat Cut)
PO08	WSF(Salted Oak on Flat Cut)
PO09	WSF(Salted Oak on Flat Cut)
WBW	
WSW	
WEC	

3 Select Feet Finish

Click to view edges

WWP	WOW
PO01	WNO
PO02	WSO
PO03	
PO07	
PO08	
PO09	
WBW	
WSW	
WEC	

4 Select Edge

Click to view details

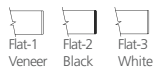

High Pressure Laminate Top Upholstered Panels - COM\$

HNY166145FP582G	19063
HNY16674FP582G	14701
HNY12574FP582G	10339
HNY8537FP582G	5977

GEC	LW05
GWL	LW06
LP01	
LF02	
LF03	
LN01	
LA02	
LW01	
LW02	
LW04	

WWP	WOW
PO01	WNO
PO02	WSO
PO03	
PO07	
PO08	
PO09	
WBW	
WSW	
WEC	



Thermally Fused Laminate Top Upholstered Panels - COM\$

HNY166145FP582M	17535
HNY16674FP582M	13555
HNY12574FP582M	9575
HNY8537FP582M	5595

MOC
MEC
MSW
MTW
MWL
MNA

WWP	WOW
PO01	WNO
PO02	WSO
PO03	
PO07	
PO08	
PO09	
WEC	
WBW	
WSW	



[Click here to view statement of line](#)

Product Features

- HNY7226WT162 Fixed Desk Height worksurfaces, 29" worksurface height
- 5" Solid wood feet - oval shape
- 4 Power outlets with 1 telecom plate, see options below for telecom plate
- Ships KD
- Wire management tray attaches to worksurface top, standard in MFW White, see premium Metal Finish for options
- Hardwire infeed and jumpers are included in workstations
- T75 worksurface wire cutout is standard on all worksurfaces.(T75D: Delete cutout is optional)

Options

Accessories

- K28: Articulating Keyboard w/ Mouse - \$390
- K31-SK: Center drawer w/ skirt - \$310
- K31: Center drawer w/o skirt - \$205

Concealed Floor Power Infeed Cover

- PCEB: White Metal Finish concealed floor power infeed cover - \$150

Delete Top and Wire Tray

- DFP: Delete fixed top. Deduct \$1335 Veneer (W), \$1165 High Pressure Laminate (G), \$840 Thermally Fused Laminate (M) per top

Metal Feet

- MTL10: Replace solid wood feet with metal feet, standard MFW White - \$55 ea

Premium Metal Finish

- Specify premium Metal Finish. MFMB: Matte Black, MFS: Silver, MFSS: Salmon Sienna, MFSA: Surfing Aquavert, MFPS: Pistachio, MFOS: Oyster, MFNA: Navy, MFOL: Olive, MFGB: Grey Beige MFGG: Graphite Gray, MFG: Gray, MFGM:Matte Gold
- Premium Metal Finish for WMT Wire Management Tray - \$75 ea
- Premium Metal Finish for MTL10 Metal Feet - \$20 ea
- Premium Metal Finish for PCEB Concealed Floor Power Infeed Cover - \$35

Starter Panel

- RSP: Substitute round starter panel in place of flat starter panel. Must substitute all starters, priced per starter panel - \$83 each. See HNY3555SP888

Telecom Plates

- Each power unit has 1 plate. All telecom connectors sold separately.
- RJ45 (1) - \$55, RJ45 (2) - \$110, RJ45 (3) - \$165, USB (1) - \$70, USB (2) - \$140, RJ45/USB - \$125, RJ45/HDMI - \$210, HDMI/USB - \$205

Worksurface Height

- THL-42: Modify worksurface height to bar height - N/C

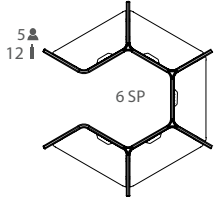

Number of Feet per Typical (MTL10 Option) "SP" Number of Starter Panels per Typical (RSP Option)

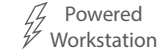
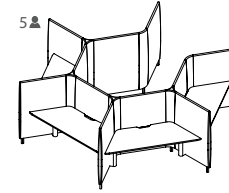

1 Select Model

Weight	Standard Veneer Top Upholstered Panels - COM\$	Premium Veneer Top Upholstered Panels - COM\$	High Pressure Laminate Top Upholstered Panels - COM\$	Thermally Fused Laminate Top Upholstered Panels - COM\$
w" x d" x h" 166 x 145 x 55	41	5 HNY166145HA583W 35880	"P" Option N/A	HNY166145HA583M 32965

2 Select Finish

Click to view finishes

WWP	WOW
PO01	WNO
PO02	WSO
PO03	WNF(Natural Oak on Flat Cut)
PO07	WSF(Salted Oak on Flat Cut)
PO08	
PO09	
WBW	
WSW	
WEC	

3 Select Feet Finish

Click to view edges

WWP	WOW
PO01	WNO
PO02	WSO
PO03	
PO07	
PO08	
PO09	
WBW	
WSW	
WEC	

4 Select Edge

Click to view details

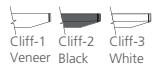

GEC	LW05
GWL	LW06
LP01	
LF02	
LF03	
LN01	
LA02	
LW01	
LW02	
LW04	

WWP	WOW
PO01	WNO
PO02	WSO
PO03	
PO07	
PO08	
PO09	
WBW	
WSW	
WEC	



MOC
MEC
MSW
MTW
MWL
MNA

WWP	WOW
PO01	WNO
PO02	WSO
PO03	
PO07	
PO08	
PO09	
WBW	
WSW	



Click here to view statement of line

Product Features

- 5" Solid wood feet - oval shape, ships KD
- 4 Power outlets with 1 telecom plate, see options below for telecom plate
- Adjustable height from 27" to 47.5" with a maximum weight capacity of 275 lbs.
- Lift standard in MFW White, optional MFB Black
- HNY7125WT163 Height Adjustable worksurfaces are included
- Wire management tray attaches to worksurface top, standard in MFW White, see premium Metal Finish for options
- T75 worksurface wire cutout is standard on all worksurfaces.(T75D: Delete cutout is optional)

Notes

- 1" Gap between worksurface and panels to drop wires below worksurface
- Metal parts include 5 year warranty
- Programmable height adjustable mechanism, motor includes 2 year warranty

Options

Accessories

- K28: Articulating Keyboard w/ Mouse - \$390
- K31-SK: Center drawer w/ skirt - \$310
- K31: Center drawer w/o skirt - \$205

Concealed Floor Power Infeed Cover

- PCEB: White Metal Finish concealed floor power infeed cover - \$150

Delete Top and Wire Tray

- DHAT: Delete height adjustable top. Deduct \$3265 Veneer(W), \$3095 High Pressure Laminate(G), \$2770 Thermally Fused Laminate(M) per top

Metal Feet

- MTL10: Replace solid wood feet with metal feet, standard MFW White - \$55 ea

Premium Metal Finish

- Specify premium Metal Finish. MFMB: Matte Black, MFS: Silver, MFSS: Salmon Sienna, MFSA: Surfing Aquavert, MFPS: Pistachio, MFOS: Oyster, MFNA: Navy, MFOL: Olive, MFGB: Grey Beige MFGG: Graphite Gray, MFG: Gray, MFGM:Matte Gold
- Premium Metal Finish for WMT Wire Management Tray - \$75 ea
- Premium Metal Finish for MTL10 Metal Feet - \$20 ea
- Premium Metal Finish for PCEB Concealed Floor Power Infeed Cover - \$35

Starter Panel

- RSP: Substitute round starter panel in place of flat starter panel. Must substitute all starters, priced per starter panel - \$83 each. See HNY3555SP888

Telecom Plates

- Each power unit has 1 plate. All telecom connectors sold separately.
- RJ45 (1) - \$55, RJ45 (2) - \$110, RJ45 (3) - \$165, USB (1) - \$70, USB (2) - \$140, RJ45/USB - \$125, RJ45/HDMI - \$210, HDMI/USB - \$205

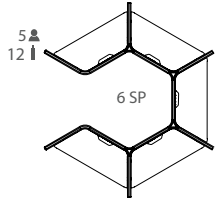

Number of Feet per Typical (MTL10 Option) "SP" Number of Starter Panels per Typical (RSP Option)

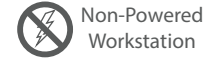
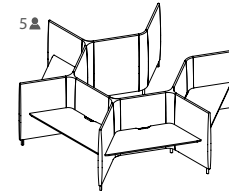

1 Select Model

w" x d" x h"
166 x 145 x 55

Weight
41

Standard Veneer Top Upholstered Panels - COM\$
5 HNY166145FT583W 22510

Premium Veneer Top Upholstered Panels - COM\$
"P" Option N/A

High Pressure Laminate Top Upholstered Panels - COM\$
HNY166145FT583G 21510

Thermally Fused Laminate Top Upholstered Panels - COM\$
HNY166145FT583M 19600

[Click here to view statement of line](#)

Product Features

- 5" Solid wood feet - oval shape
- HNY7226WT162 Fixed Desk Height worksurfaces, 29" worksurface height
- Ships KD
- T75 worksurface wire cutout is standard on all worksurfaces.(T75D: Delete cutout is optional)

Options

Accessories

- K28: Articulating Keyboard w/ Mouse - \$390
- K31-SK: Center drawer w/ skirt - \$310
- K31: Center drawer w/o skirt - \$205

Concealed Floor Power Infeed Cover

- PCEB: White Metal Finish concealed floor power infeed cover - \$150

Delete Top

- DFT: Delete fixed top. Deduct \$1125 Veneer(W), \$955 High Pressure Laminate (G), \$630 Thermally Fused Laminate (M) per top

Metal Feet

- MTL10: Replace solid wood feet with metal feet, standard MFW White - \$55 ea

Premium Metal Finish

- Specify premium Metal Finish. MFMB: Matte Black, MFS: Silver, MFSS: Salmon Sienna, MFSA: Surfing Aquavert, MFPS: Pistachio, MFOS: Oyster, MFNA: Navy, MFOL: Olive, MFGB: Grey Beige MFGG: Graphite Gray, MFG: Gray, MFGM:Matte Gold
- Premium Metal Finish for WMT Wire Management Tray - \$75 ea
- Premium Metal Finish for MTL10 Metal Feet - \$20 ea
- Premium Metal Finish for PCEB Concealed Floor Power Infeed Cover - \$35

Starter Panel

- RSP: Substitute round starter panel in place of flat starter panel. Must substitute all starters, priced per starter panel - \$83 each. See HNY3555SP888

Worksurface Height

- Modify worksurface height to bar height.
- THL-42: Position worksurface at bar height - N/C

Wire Tray

- WMT: Wire metal tray. Mounts under top and comes standard in MFW White - \$210

[Click Here for Graded in Pricing](#)

2 Select Finish

Click to view finishes

WWP	WOW
PO01	WNO
PO02	WSO
PO03	WNF(Natural Oak on Flat Cut)
PO07	WSF(Salted Oak on Flat Cut)
PO08	
PO09	
WBW	
WSW	
WEC	

3 Select Feet Finish

Click to view edges

WWP	WOW
PO01	WNO
PO02	WSO
PO03	
PO07	
PO08	
PO09	
WBW	
WSW	
WEC	

4 Select Edge

Click to view details



GEC	LW05
GWL	LW06
LP01	
LF02	
LF03	
LN01	
LA02	
LW01	
LW02	
LW04	

WWP	WOW
PO01	WNO
PO02	WSO
PO03	
PO07	
PO08	
PO09	
WBW	
WSW	
WEC	



MOC
MEC
MSW
MTW
MWL
MNA

WWP	WOW
PO01	WNO
PO02	WSO
PO03	
PO07	
PO08	
PO09	
WBW	
WSW	



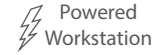
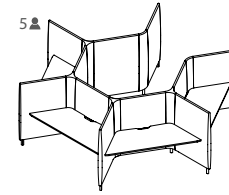
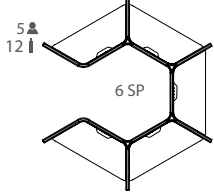

Number of Feet per Typical (MTL10 Option) "SP" Number of Starter Panels per Typical (RSP Option)

1 Select Model

w" x d" x h"	Weight	Standard Veneer Top Upholstered Panels - COM\$	Premium Veneer Top Upholstered Panels - COM\$
166 x 145 x 55	41	5 HNY166145FP583W 24425	"P" Option N/A

[Click Here for Graded in Pricing](#)

2 Select Finish

Click to view finishes

WWP	WOW
PO01	WNO
PO02	WSO
PO03	WNF(Natural Oak on Flat Cut)
PO07	WSF(Salted Oak on Flat Cut)
PO08	WSF(Salted Oak on Flat Cut)
PO09	WSF(Salted Oak on Flat Cut)
WBW	
WSW	
WEC	

3 Select Feet Finish

Click to view edges

WWP	WOW
PO01	WNO
PO02	WSO
PO03	
PO07	
PO08	
PO09	
WBW	
WSW	
WEC	

4 Select Edge

Click to view details

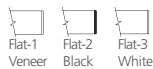

High Pressure Laminate Top Upholstered Panels - COM\$

HNY166145FP583G 23425

GEC	LW05
GWL	LW06
LP01	
LF02	
LF03	
LN01	
LA02	
LW01	
LW02	
LW04	

WWP	WOW
PO01	WNO
PO02	WSO
PO03	
PO07	
PO08	
PO09	
WBW	
WSW	
WEC	



Thermally Fused Laminate Top Upholstered Panels - COM\$

HNY166145FP583M 21515

MOC
MEC
MSW
MTW
MWL
MNA

WWP	WOW
PO01	WNO
PO02	WSO
PO03	
PO07	
PO08	
PO09	
WEC	
WBW	
WSW	



[Click here to view statement of line](#)

Product Features

- HNY7226WT162 Fixed Desk Height worksurfaces, 29" worksurface height
- 5" Solid wood feet - oval shape
- 4 Power outlets with 1 telecom plate, see options below for telecom plate
- Ships KD
- Wire management tray attaches to worksurface top, standard in MFW White, see premium Metal Finish for options
- Hardwire infeed and jumpers are included in workstations
- T75 worksurface wire cutout is standard on all worksurfaces.(T75D: Delete cutout is optional)

Options

Accessories

- K28: Articulating Keyboard w/ Mouse - \$390
- K31-SK: Center drawer w/ skirt - \$310
- K31: Center drawer w/o skirt - \$205

Concealed Floor Power Infeed Cover

- PCEB: White Metal Finish concealed floor power infeed cover - \$150

Delete Top and Wire Tray

- DFP: Delete fixed top. Deduct \$1335 Veneer (W), \$1165 High Pressure Laminate (G), \$840 Thermally Fused Laminate (M) per top

Metal Feet

- MTL10: Replace solid wood feet with metal feet, standard MFW White - \$55 ea

Premium Metal Finish

- Specify premium Metal Finish. MFMB: Matte Black, MFS: Silver, MFSS: Salmon Sienna, MFSA: Surfing Aquavert, MFPS: Pistachio, MFOS: Oyster, MFNA: Navy, MFOL: Olive, MFGB: Grey Beige MFGG: Graphite Gray, MFG: Gray, MFGM:Matte Gold
- Premium Metal Finish for WMT Wire Management Tray - \$75 ea
- Premium Metal Finish for MTL10 Metal Feet - \$20 ea
- Premium Metal Finish for PCEB Concealed Floor Power Infeed Cover - \$35

Starter Panel

- RSP: Substitute round starter panel in place of flat starter panel. Must substitute all starters, priced per starter panel - \$83 each. See HNY3555SP888

Telecom Plates

- Each power unit has 1 plate. All telecom connectors sold separately.
- RJ45 (1) - \$55, RJ45 (2) - \$110, RJ45 (3) - \$165, USB (1) - \$70, USB (2) - \$140, RJ45/USB - \$125, RJ45/HDMI - \$210, HDMI/USB - \$205

Worksurface Height

- THL-42: Modify worksurface height to bar height - N/C

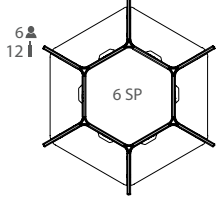

Number of Feet per Typical (MTL10 Option) "SP" Number of Starter Panels per Typical (RSP Option)

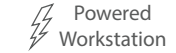
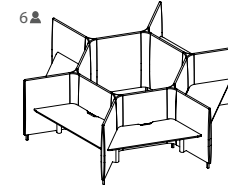

1 Select Model

Weight	Standard Veneer Top Upholstered Panels - COM\$	Premium Veneer Top Upholstered Panels - COM\$	High Pressure Laminate Top Upholstered Panels - COM\$	Thermally Fused Laminate Top Upholstered Panels - COM\$
w" x d" x h" 166 x 145 x 55	45	6 HNY166145HA584W 41323	"P" Option N/A	HNY166145HA584M 37825

2 Select Finish

Click to view finishes

WWP	WOW
PO01	WNO
PO02	WSO
PO03	WNF(Natural Oak on Flat Cut)
PO07	WSF(Salted Oak on Flat Cut)
PO08	
PO09	
WBW	
WSW	
WEC	

3 Select Feet Finish

Click to view edges

WWP	WOW
PO01	WNO
PO02	WSO
PO03	
PO07	
PO08	
PO09	
WBW	
WSW	
WEC	

4 Select Edge

Click to view details

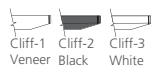

GEC	LW05
GWL	LW06
LP01	
LF02	
LF03	
LN01	
LA02	
LW01	
LW02	
LW04	

WWP	WOW
PO01	WNO
PO02	WSO
PO03	
PO07	
PO08	
PO09	
WBW	
WSW	
WEC	



MOC
MEC
MSW
MTW
MWL
MNA

WWP	WOW
PO01	WNO
PO02	WSO
PO03	
PO07	
PO08	
PO09	
WBW	
WSW	



Click here to view statement of line

Product Features

- 5" Solid wood feet - oval shape, ships KD
- 4 Power outlets with 1 telecom plate, see options below for telecom plate
- Adjustable height from 27" to 47.5" with a maximum weight capacity of 275 lbs.
- Lift standard in MFW White, optional MFB Black
- HNY7125WT163 Height Adjustable worksurfaces are included
- Wire management tray attaches to worksurface top, standard in MFW White, see premium Metal Finish for options
- T75 worksurface wire cutout is standard on all worksurfaces.(T75D: Delete cutout is optional)

Notes

- 1" Gap between worksurface and panels to drop wires below worksurface
- Metal parts include 5 year warranty
- Programmable height adjustable mechanism, motor includes 2 year warranty

Options

Accessories

- K28: Articulating Keyboard w/ Mouse - \$390
- K31-SK: Center drawer w/ skirt - \$310
- K31: Center drawer w/o skirt - \$205

Concealed Floor Power Infeed Cover

- PCEB: White Metal Finish concealed floor power infeed cover - \$150

Delete Top and Wire Tray

- DHAT: Delete height adjustable top. Deduct \$3265 Veneer(W), \$3095 High Pressure Laminate(G), \$2770 Thermally Fused Laminate(M) per top

Metal Feet

- MTL10: Replace solid wood feet with metal feet, standard MFW White - \$55 ea

Premium Metal Finish

- Specify premium Metal Finish. MFMB: Matte Black, MFS: Silver, MFSS: Salmon Sienna, MFSA: Surfing Aquavert, MFPS: Pistachio, MFOS: Oyster, MFNA: Navy, MFOL: Olive, MFGB: Grey Beige MFGG: Graphite Gray, MFG: Gray, MFGM:Matte Gold
- Premium Metal Finish for WMT Wire Management Tray - \$75 ea
- Premium Metal Finish for MTL10 Metal Feet - \$20 ea
- Premium Metal Finish for PCEB Concealed Floor Power Infeed Cover - \$35

Starter Panel

- RSP: Substitute round starter panel in place of flat starter panel. Must substitute all starters, priced per starter panel - \$83 each. See HNY3555SP888

Telecom Plates

- Each power unit has 1 plate. All telecom connectors sold separately.
- RJ45 (1) - \$55, RJ45 (2) - \$110, RJ45 (3) - \$165, USB (1) - \$70, USB (2) - \$140, RJ45/USB - \$125, RJ45/HDMI - \$210, HDMI/USB - \$205

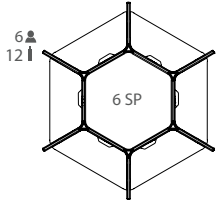

Number of Feet per Typical (MTL10 Option) "SP" Number of Starter Panels per Typical (RSP Option)

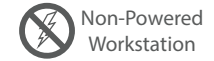
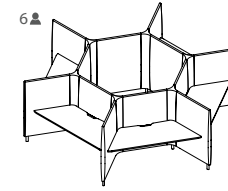

1 Select Model

Weight	Standard Veneer Top Upholstered Panels - COM\$	Premium Veneer Top Upholstered Panels - COM\$	High Pressure Laminate Top Upholstered Panels - COM\$	Thermally Fused Laminate Top Upholstered Panels - COM\$
w" x d" x h"	166 x 145 x 55	6 HNY166145FT584W 25320	"P" Option N/A	HNY166145FT584M 21828

2 Select Finish

Click to view finishes

WWP	WOW
PO01	WNO
PO02	WSO
PO03	WNF(Natural Oak on Flat Cut)
PO07	WSF(Salted Oak on Flat Cut)
PO08	
PO09	
WBW	
WSW	
WEC	

3 Select Feet Finish

Click to view edges

WWP	WOW
PO01	WNO
PO02	WSO
PO03	
PO07	
PO08	
PO09	
WBW	
WSW	
WEC	

4 Select Edge

Click to view details

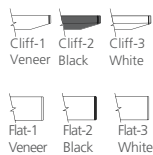

GEC	LW05
GWL	LW06
LP01	
LF02	
LF03	
LN01	
LA02	
LW01	
LW02	
LW04	

WWP	WOW
PO01	WNO
PO02	WSO
PO03	
PO07	
PO08	
PO09	
WBW	
WSW	
WEC	

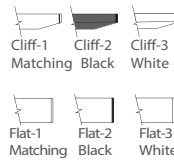

MOC
MEC
MSW
MTW
MWL
MNA

WWP	WOW
PO01	WNO
PO02	WSO
PO03	
PO07	
PO08	
PO09	
WBW	
WSW	



Click here to view statement of line

Product Features

- 5" Solid wood feet - oval shape
- HNY7226WT162 Fixed Desk Height worksurfaces, 29" worksurface height
- Ships KD
- T75 worksurface wire cutout is standard on all worksurfaces.(T75D: Delete cutout is optional)

Options

Accessories

- K28: Articulating Keyboard w/ Mouse - \$390
- K31-SK: Center drawer w/ skirt - \$310
- K31: Center drawer w/o skirt - \$205

Concealed Floor Power Infeed Cover

- PCEB: White Metal Finish concealed floor power infeed cover - \$150

Delete Top

- DFT: Delete fixed top. Deduct \$1125 Veneer(W), \$955 High Pressure Laminate (G), \$630 Thermally Fused Laminate (M) per top

Metal Feet

- MTL10: Replace solid wood feet with metal feet, standard MFW White - \$55 ea

Premium Metal Finish

- Specify premium Metal Finish. MFMB: Matte Black, MFS: Silver, MFSS: Salmon Sienna, MFSA: Surfing Aquavert, MFPS: Pistachio, MFOS: Oyster, MFNA: Navy, MFOL: Olive, MFGB: Grey Beige MFGG: Graphite Gray, MFG: Gray, MFGM:Matte Gold
- Premium Metal Finish for WMT Wire Management Tray - \$75 ea
- Premium Metal Finish for MTL10 Metal Feet - \$20 ea
- Premium Metal Finish for PCEB Concealed Floor Power Infeed Cover - \$35

Starter Panel

- RSP: Substitute round starter panel in place of flat starter panel. Must substitute all starters, priced per starter panel - \$83 each. See HNY3555SP888

Worksurface Height

- Modify worksurface height to bar height.
- THL-42: Position worksurface at bar height - N/C

Wire Tray

- WMT: Wire metal tray. Mounts under top and comes standard in MFW White - \$210

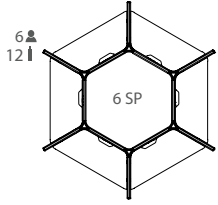

Number of Feet per Typical (MTL10 Option) "SP" Number of Starter Panels per Typical (RSP Option)

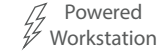
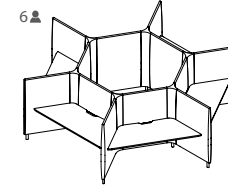

1 Select Model

Weight	Standard Veneer Top Upholstered Panels - COM\$
w" x d" x h"	6 SP
166 x 145 x 55	45 6 HNY166145FP584W 27577

Premium Veneer Top Upholstered Panels - COM\$

"P" Option N/A

High Pressure Laminate Top Upholstered Panels - COM\$

HNY166145FP584G 26377

Thermally Fused Laminate Top Upholstered Panels - COM\$

HNY166145FP584M 24085

[Click here to view statement of line](#)

Product Features

- HNY7226WT162 Fixed Desk Height worksurfaces, 29" worksurface height
- 5" Solid wood feet - oval shape
- 4 Power outlets with 1 telecom plate, see options below for telecom plate
- Ships KD
- Wire management tray attaches to worksurface top, standard in MFW White, see premium Metal Finish for options
- Hardwire infeed and jumpers are included in workstations
- T75 worksurface wire cutout is standard on all worksurfaces.(T75D: Delete cutout is optional)

[Click Here for Graded in Pricing](#)

2 Select Finish

Click to view finishes

WWP	WOW
PO01	WNO
PO02	WSO
PO03	WNF(Natural Oak on Flat Cut)
PO07	WSF(Salted Oak on Flat Cut)
PO08	
PO09	
WBW	
WSW	
WEC	

GEC	LW05
GWL	LW06
LP01	
LF02	
LF03	
LN01	
LA02	
LW01	
LW02	
LW04	

MOC
MEC
MSW
MTW
MWL
MNA

3 Select Feet Finish

Click to view edges

WWP	WOW
PO01	WNO
PO02	WSO
PO03	
PO07	
PO08	
PO09	
WBW	
WSW	
WEC	

WWP	WOW
PO01	WNO
PO02	WSO
PO03	
PO07	
PO08	
PO09	
WBW	
WSW	
WEC	

WWP	WOW
PO01	WNO
PO02	WSO
PO03	
PO07	
PO08	
PO09	
WEC	
WBW	
WSW	

4 Select Edge

Click to view details

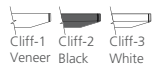

Options

Accessories

- K28: Articulating Keyboard w/ Mouse - \$390
- K31-SK: Center drawer w/ skirt - \$310
- K31: Center drawer w/o skirt - \$205

Concealed Floor Power Infeed Cover

- PCEB: White Metal Finish concealed floor power infeed cover - \$150

Delete Top and Wire Tray

- DFP: Delete fixed top. Deduct \$1335 Veneer (W), \$1165 High Pressure Laminate (G), \$840 Thermally Fused Laminate (M) per top

Metal Feet

- MTL10: Replace solid wood feet with metal feet, standard MFW White - \$55 ea

Premium Metal Finish

- Specify premium Metal Finish. MFMB: Matte Black, MFS: Silver, MFSS: Salmon Sienna, MFSA: Surfing Aquavert, MFPS: Pistachio, MFOS: Oyster, MFNA: Navy, MFOL: Olive, MFGB: Grey Beige MFGG: Graphite Gray, MFG: Gray, MFGM:Matte Gold
- Premium Metal Finish for WMT Wire Management Tray - \$75 ea
- Premium Metal Finish for MTL10 Metal Feet - \$20 ea
- Premium Metal Finish for PCEB Concealed Floor Power Infeed Cover - \$35

Starter Panel

- RSP: Substitute round starter panel in place of flat starter panel. Must substitute all starters, priced per starter panel - \$83 each. See HNY3555SP888

Telecom Plates

- Each power unit has 1 plate. All telecom connectors sold separately.
- RJ45 (1) - \$55, RJ45 (2) - \$110, RJ45 (3) - \$165, USB (1) - \$70, USB (2) - \$140, RJ45/USB - \$125, RJ45/HDMI - \$210, HDMI/USB - \$205

Worksurface Height

- THL-42: Modify worksurface height to bar height - N/C

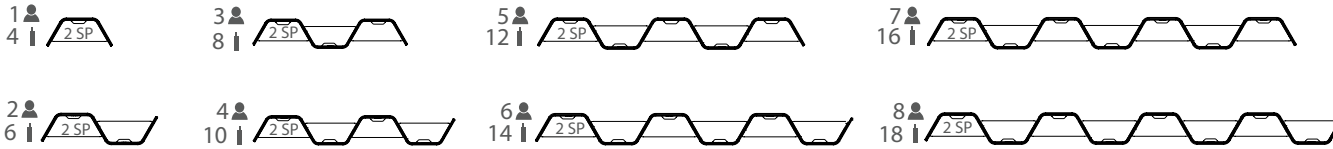

Number of Feet per Typical (MTL10 Option) "SP" Number of Starter Panels per Typical (RSP Option)

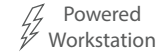
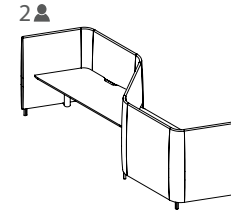

1 Select Model

w" x d" x h"	Weight	Standard Veneer Top Upholstered Panels - COM\$	Premium Veneer Top Upholstered Panels - COM\$
539 x 41 x 55	67	8 HNY53941HA585W 60828	"P" Option N/A
474 x 41 x 55	59	7 HNY47441HA585W 53348	"P" Option N/A
409 x 41 x 55	51	6 HNY40941HA585W 45868	"P" Option N/A
345 x 41 x 55	43	5 HNY34541HA585W 38388	"P" Option N/A
280 x 41 x 55	35	4 HNY28041HA585W 30908	"P" Option N/A
215 x 41 x 55	27	3 HNY21541HA585W 23428	"P" Option N/A
150 x 41 x 55	19	2 HNY15041HA585W 15948	"P" Option N/A
85 x 37 x 55	11	1 HNY8537HA585W 8468	"P" Option N/A

[Click Here for Graded in Pricing](#)

2 Select Finish

Click to view finishes

WWP	WOW
PO01	WNO
PO02	WSO
PO03	WNF(Natural Oak on Flat Cut)
PO07	WSF(Salted Oak on Flat Cut)
PO08	WSF(Salted Oak on Flat Cut)
PO09	WSF(Salted Oak on Flat Cut)
WBW	
WSW	
WEC	

3 Select Feet Finish

Click to view edges

WWP	WOW
PO01	WNO
PO02	WSO
PO03	
PO07	
PO08	
PO09	
WBW	
WSW	
WEC	

4 Select Edge

Click to view details

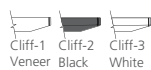

High Pressure Laminate Top Upholstered Panels - COM\$

HNY53941HA585G	59220
HNY47441HA585G	51941
HNY40941HA585G	44662
HNY34541HA585G	37383
HNY28041HA585G	30104
HNY21541HA585G	22825
HNY15041HA585G	15546
HNY8537HA585G	8267

GEC	LW05
GWL	LW06
LP01	
LF02	
LF03	
LN01	
LA02	
LW01	
LW02	
LW04	

WWP	WOW
PO01	WNO
PO02	WSO
PO03	
PO07	
PO08	
PO09	
WBW	
WSW	
WEC	



Thermally Fused Laminate Top Upholstered Panels - COM\$

HNY53941HA585M	56164
HNY47441HA585M	49267
HNY40941HA585M	42370
HNY34541HA585M	35473
HNY28041HA585M	28576
HNY21541HA585M	21679
HNY15041HA585M	14782
HNY8537HA585M	7885

MOC
MEC
MSW
MTW
MWL
MNA

WWP	WOW
PO01	WNO
PO02	WSO
PO03	
PO07	
PO08	
PO09	
WBW	
WSW	



[Click here to view statement of line](#)

Product Features

- 5" Solid wood feet - oval shape, ships KD
- 4 Power outlets with 1 telecom plate, see options below for telecom plate
- Adjustable height from 27" to 47.5" with a maximum weight capacity of 275 lbs.
- Lift standard in MFW White, optional MFB Black
- HNY7125WT163 Height Adjustable worksurfaces are included
- Wire management tray attaches to worksurface top, standard in MFW White, see premium Metal Finish for options
- T75 worksurface wire cutout is standard on all worksurfaces.(T75D: Delete cutout is optional)

Notes

- 1" Gap between worksurface and panels to drop wires below worksurface
- Metal parts include 5 year warranty
- Programmable height adjustable mechanism, motor includes 2 year warranty

Options

Accessories

- K28: Articulating Keyboard w/ Mouse - \$390
- K31-SK: Center drawer w/ skirt - \$310
- K31: Center drawer w/o skirt - \$205

Concealed Floor Power Infeed Cover

- PCEB: White Metal Finish concealed floor power infeed cover - \$150

Delete Top and Wire Tray

- DHAT: Delete height adjustable top. Deduct \$3265 Veneer(W), \$3095 High Pressure Laminate(G), \$2770 Thermally Fused Laminate(M) per top

Metal Feet

- MTL10: Replace solid wood feet with metal feet, standard MFW White - \$55 ea

Premium Metal Finish

- Specify premium Metal Finish. MFMB: Matte Black, MFS: Silver, MFSS: Salmon Sienna, MFSA: Surfin Aquavert, MFPS: Pistachio, MFOS: Oyster, MFNA: Navy, MFOL: Olive, MFGB: Grey Beige MFGG: Graphite Gray, MFG: Gray, MFGM:Matte Gold
- Premium Metal Finish for WMT Wire Management Tray - \$75 ea
- Premium Metal Finish for MTL10 Metal Feet - \$20 ea
- Premium Metal Finish for PCEB Concealed Floor Power Infeed Cover - \$35

Starter Panel

- RSP: Substitute round starter panel in place of flat starter panel. Must substitute all starters, priced per starter panel - \$83 each. See HNY3555SP888

Telecom Plates

- Each power unit has 1 plate. All telecom connectors sold separately.
- RJ45 (1) - \$55, RJ45 (2) - \$110, RJ45 (3) - \$165, USB (1) - \$70, USB (2) - \$140, RJ45/USB - \$125, RJ45/HDMI - \$210, HDMI/USB - \$205

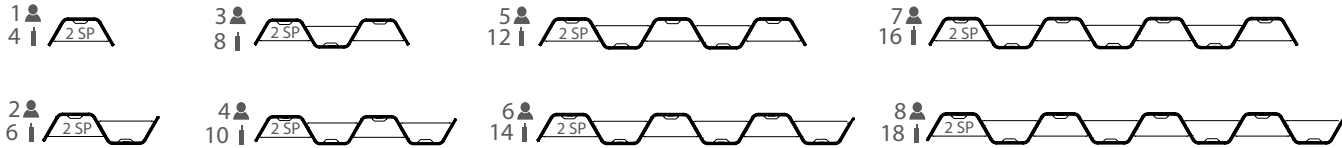

Number of Feet per Typical (MTL10 Option) "SP" Number of Starter Panels per Typical (RSP Option)

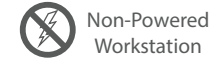
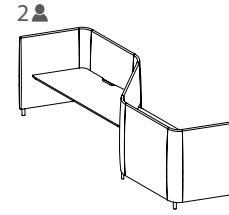

1 Select Model

w" x d" x h"	Weight	Standard Veneer Top Upholstered Panels - COM\$	Premium Veneer Top Upholstered Panels - COM\$	High Pressure Laminate Top Upholstered Panels - COM\$	Thermally Fused Laminate Top Upholstered Panels - COM\$
539 x 41 x 55	67	8 HNY53941FT585W 38656	"P" Option N/A	HNY53941FT585G 37056	HNY53941FT585M 34000
474 x 41 x 55	59	7 HNY47441FT585W 33938	"P" Option N/A	HNY47441FT585G 32538	HNY47441FT585M 29864
409 x 41 x 55	51	6 HNY40941FT585W 29220	"P" Option N/A	HNY40941FT585G 28020	HNY40941FT585M 25728
345 x 41 x 55	43	5 HNY34541FT585W 24502	"P" Option N/A	HNY34541FT585G 23502	HNY34541FT585M 21592
280 x 41 x 55	35	4 HNY28041FT585W 19784	"P" Option N/A	HNY28041FT585G 18984	HNY28041FT585M 17456
215 x 41 x 55	27	3 HNY21541FT585W 15066	"P" Option N/A	HNY21541FT585G 14466	HNY21541FT585M 13320
150 x 41 x 55	19	2 HNY15041FT585W 10348	"P" Option N/A	HNY15041FT585G 9948	HNY15041FT585M 9184
85 x 37 x 55	11	1 HNY8537FT585W 5630	"P" Option N/A	HNY8537FT585G 5430	HNY8537FT585M 5048

[Click Here for Graded in Pricing](#)

2 Select Finish

Click to view finishes

WWP	WOW
PO01	WNO
PO02	WSO
PO03	WNF(Natural Oak on Flat Cut)
PO07	WSF(Salted Oak on Flat Cut)
PO08	WSF(Salted Oak on Flat Cut)
PO09	WSF(Salted Oak on Flat Cut)
WBW	
WSW	
WEC	

3 Select Feet Finish

Click to view edges

WWP	WOW
PO01	WNO
PO02	WSO
PO03	
PO07	
PO08	
PO09	
WBW	
WSW	
WEC	

4 Select Edge

Click to view details

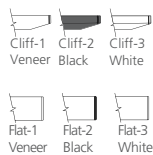

GEC	LW05
GWL	LW06
LP01	
LF02	
LF03	
LN01	
LA02	
LW01	
LW02	
LW04	

WWP	WOW
PO01	WNO
PO02	WSO
PO03	
PO07	
PO08	
PO09	
WBW	
WSW	
WEC	

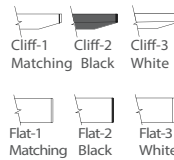

MOC
MEC
MSW
MTW
MWL
MNA

WWP	WOW
PO01	WNO
PO02	WSO
PO03	
PO07	
PO08	
PO09	
WBW	
WSW	



[Click here to view statement of line](#)

Product Features

- 5" Solid wood feet - oval shape
- HNY7226WT162 Fixed Desk Height worksurfaces, 29" worksurface height
- Ships KD
- T75 worksurface wire cutout is standard on all worksurfaces.(T75D: Delete cutout is optional)

Options

Accessories

- K28: Articulating Keyboard w/ Mouse - \$390
- K31-SK: Center drawer w/ skirt - \$310
- K31: Center drawer w/o skirt - \$205

Concealed Floor Power Infeed Cover

- PCEB: White Metal Finish concealed floor power infeed cover - \$150

Delete Top

- DFT: Delete fixed top. Deduct \$1125 Veneer(W), \$955 High Pressure Laminate (G), \$630 Thermally Fused Laminate (M) per top

Metal Feet

- MTL10: Replace solid wood feet with metal feet, standard MFW White - \$55 ea

Premium Metal Finish

- Specify premium Metal Finish. MFMB: Matte Black, MFS: Silver, MFSS: Salmon Sienna, MFSA: Surfing Aquavert, MFPS: Pistachio, MFOS: Oyster, MFNA: Navy, MFOL: Olive, MFGB: Grey Beige MFGG: Graphite Gray, MFG: Gray, MFGM:Matte Gold
- Premium Metal Finish for WMT Wire Management Tray - \$75 ea
- Premium Metal Finish for MTL10 Metal Feet - \$20 ea
- Premium Metal Finish for PCEB Concealed Floor Power Infeed Cover - \$35

Starter Panel

- RSP: Substitute round starter panel in place of flat starter panel. Must substitute all starters, priced per starter panel - \$83 each. See HNY3555SP888

Worksurface Height

- Modify worksurface height to bar height.
- THL-42: Position worksurface at bar height - N/C

Wire Tray

- WMT: Wire metal tray. Mounts under top and comes standard in MFW White - \$210

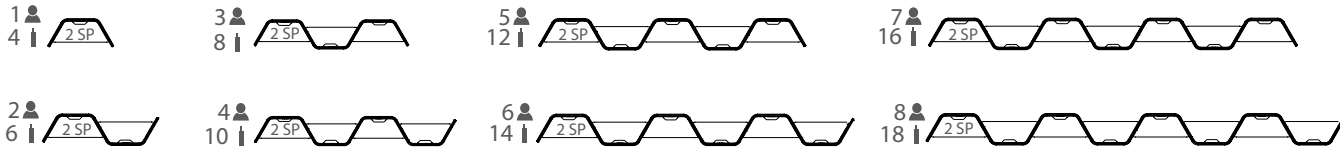

Number of Feet per Typical (MTL10 Option) "SP" Number of Starter Panels per Typical (RSP Option)

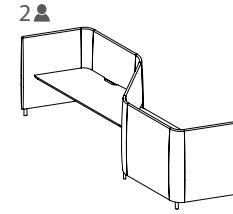

Fixed Top Workstation

Powered Workstation

1 Select Model

w" x d" x h"	Weight	Standard Veneer Top Upholstered Panels - COM\$	Premium Veneer Top Upholstered Panels - COM\$	High Pressure Laminate Top Upholstered Panels - COM\$	Thermally Fused Laminate Top Upholstered Panels - COM\$
539 x 41 x 55	67	8 HNY53941FP585W 42500	"P" Option N/A	HNY53941FP585G 40900	HNY53941FP585M 37844
474 x 41 x 55	59	7 HNY47441FP585W 37311	"P" Option N/A	HNY47441FP585G 35911	HNY47441FP585M 33237
409 x 41 x 55	51	6 HNY40941FP585W 32122	"P" Option N/A	HNY40941FP585G 30922	HNY40941FP585M 28630
345 x 41 x 55	43	5 HNY34541FP585W 26933	"P" Option N/A	HNY34541FP585G 25933	HNY34541FP585M 24023
280 x 41 x 55	35	4 HNY28041FP585W 21744	"P" Option N/A	HNY28041FP585G 20944	HNY28041FP585M 19416
215 x 41 x 55	27	3 HNY21541FP585W 16555	"P" Option N/A	HNY21541FP585G 15955	HNY21541FP585M 14809
150 x 41 x 55	19	2 HNY15041FP585W 11366	"P" Option N/A	HNY15041FP585G 10966	HNY15041FP585M 10202
85 x 37 x 55	11	1 HNY8537FP585W 6177	"P" Option N/A	HNY8537FP585G 5977	HNY8537FP585M 5595

[Click Here for Graded in Pricing](#)

2 Select Finish

Click to view finishes

WWP	WOW
PO01	WNO
PO02	WSO
PO03	WNF(Natural Oak on Flat Cut)
PO07	WSF(Salted Oak on Flat Cut)
PO08	WSF(Salted Oak on Flat Cut)
PO09	WSF(Salted Oak on Flat Cut)
WBW	
WSW	
WEC	

3 Select Feet Finish

Click to view edges

WWP	WOW
PO01	WNO
PO02	WSO
PO03	
PO07	
PO08	
PO09	
WBW	
WSW	
WEC	

4 Select Edge

Click to view details

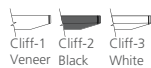

[Click here to view statement of line](#)

Product Features

- HNY7226WT162 Fixed Desk Height worksurfaces, 29" worksurface height
- 5" Solid wood feet - oval shape
- 4 Power outlets with 1 telecom plate, see options below for telecom plate
- Ships KD
- Wire management tray attaches to worksurface top, standard in MFW White, see premium Metal Finish for options
- Hardwire infeed and jumpers are included in workstations
- T75 worksurface wire cutout is standard on all worksurfaces.(T75D: Delete cutout is optional)

Options

Accessories

- K28: Articulating Keyboard w/ Mouse - \$390
- K31-SK: Center drawer w/ skirt - \$310
- K31: Center drawer w/o skirt - \$205

Concealed Floor Power Infeed Cover

- PCEB: White Metal Finish concealed floor power infeed cover - \$150

Delete Top and Wire Tray

- DFP: Delete fixed top. Deduct \$1335 Veneer (W), \$1165 High Pressure Laminate (G), \$840 Thermally Fused Laminate (M) per top

Metal Feet

- MTL10: Replace solid wood feet with metal feet, standard MFW White - \$55 ea

Premium Metal Finish

- Specify premium Metal Finish. MFMB: Matte Black, MFS: Silver, MFSS: Salmon Sienna, MFSA: SurfIn Aquavert, MFPS: Pistachio, MFOS: Oyster, MFNA: Navy, MFOL: Olive, MFGB: Grey Beige MFGG: Graphite Gray, MFG: Gray, MFGM:Matte Gold
- Premium Metal Finish for WMT Wire Management Tray - \$75 ea
- Premium Metal Finish for MTL10 Metal Feet - \$20 ea
- Premium Metal Finish for PCEB Concealed Floor Power Infeed Cover - \$35

Starter Panel

- RSP: Substitute round starter panel in place of flat starter panel. Must substitute all starters, priced per starter panel - \$83 each. See HNY3555SP888

Telecom Plates

- Each power unit has 1 plate. All telecom connectors sold separately.
- RJ45 (1) - \$55, RJ45 (2) - \$110, RJ45 (3) - \$165, USB (1) - \$70, USB (2) - \$140, RJ45/USB - \$125, RJ45/HDMI - \$210, HDMI/USB - \$205

Worksurface Height

- THL-42: Modify worksurface height to bar height - N/C

DARRAN

Honey

S-Shaped Workstation Typical
Desk with Height Adjustable Worksurface

5
12

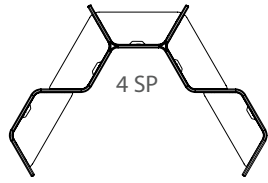

8
18



8

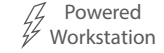
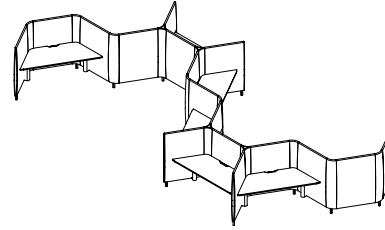

Number of Feet per Typical (MTL10 Option) "SP" Number of Starter Panels per Typical (RSP Option)

1 Select Model

Weight	Standard Veneer Top Upholstered Panels - COM\$
347 x 145 x 55	8 HNY347145HA586W 58320
217 x 145 x 55	5 HNY217145HA586W 37134

Premium Veneer Top Upholstered Panels - COM\$
"P" Option N/A
"P" Option N/A

High Pressure Laminate Top Upholstered Panels - COM\$
HNY347145HA586G 56712
HNY217145HA586G 36129

Thermally Fused Laminate Top Upholstered Panels - COM\$
HNY347145HA586M 53656
HNY217145HA586M 34219

[Click here to view statement of line](#)

Product Features

- 5" Solid wood feet - oval shape, ships KD
- 4 Power outlets with 1 telecom plate, see options below for telecom plate
- Adjustable height from 27" to 47.5" with a maximum weight capacity of 275 lbs. Lift standard in MFW White, optional MFB Black
- HNY7125WT163 Height Adjustable worksurfaces are included
- Wire management tray attaches to worksurface top, standard in MFW White, see premium Metal Finish for options
- T75 worksurface wire cutout is standard on all worksurfaces.(T75D: Delete cutout is optional)

Notes

- 1" Gap between worksurface and panels to drop wires below worksurface
- Metal parts include 5 year warranty
- Programmable height adjustable mechanism, motor includes 2 year warranty

Options

Accessories

- K28: Articulating Keyboard w/ Mouse - \$390
- K31-SK: Center drawer w/ skirt - \$310
- K31: Center drawer w/o skirt - \$205

Concealed Floor Power Infeed Cover

- PCEB: White Metal Finish concealed floor power infeed cover - \$150

Delete Top and Wire Tray

- DHAT: Delete height adjustable top. Deduct \$3265 Veneer(W), \$3095 High Pressure Laminate(G), \$2770 Thermally Fused Laminate(M) per top

Metal Feet

- MTL10: Replace solid wood feet with metal feet, standard MFW White - \$55 ea

Premium Metal Finish

- Specify premium Metal Finish. MFMB: Matte Black, MFS: Silver, MFSS: Salmon Sienna, MFSA: Surfing Aquavert, MFPS: Pistachio, MFOS: Oyster, MFNA: Navy, MFOL: Olive, MFGB: Grey Beige MFGG: Graphite Gray, MFG: Gray, MFGM:Matte Gold
- Premium Metal Finish for WMT Wire Management Tray - \$75 ea
- Premium Metal Finish for MTL10 Metal Feet - \$20 ea
- Premium Metal Finish for PCEB Concealed Floor Power Infeed Cover - \$35

Starter Panel

- RSP: Substitute round starter panel in place of flat starter panel. Must substitute all starters, priced per starter panel - \$83 each. See HNY3555SP888

Telecom Plates

- Each power unit has 1 plate. All telecom connectors sold separately.
- RJ45 (1) - \$55, RJ45 (2) - \$110, RJ45 (3) - \$165, USB (1) - \$70, USB (2) - \$140, RJ45/USB - \$125, RJ45/HDMI - \$210, HDMI/USB - \$205

[Click Here for Graded in Pricing](#)

2 Select Finish

Click to view finishes

WWP	WOW
PO01	WNO
PO02	WSO
PO03	WNF(Natural Oak on Flat Cut)
PO07	WSF(Salted Oak on Flat Cut)
PO08	WSF(Salted Oak on Flat Cut)
PO09	WSF(Salted Oak on Flat Cut)
WBW	
WSW	
WEC	

3 Select Feet Finish

Click to view edges

WWP	WOW
PO01	WNO
PO02	WSO
PO03	
PO07	
PO08	
PO09	
WBW	
WSW	
WEC	

4 Select Edge

Click to view details



GEC	LW05
GWL	LW06
LP01	
LF02	
LF03	
LN01	
LA02	
LW01	
LW02	
LW04	

WWP	WOW
PO01	WNO
PO02	WSO
PO03	
PO07	
PO08	
PO09	
WBW	
WSW	
WEC	



MOC
MEC
MSW
MTW
MWL
MNA

WWP	WOW
PO01	WNO
PO02	WSO
PO03	
PO07	
PO08	
PO09	
WEC	
WBW	
WSW	



DARRAN

Honey

S-Shaped Workstation Typical
Desk with Fixed Worksurface

5
12

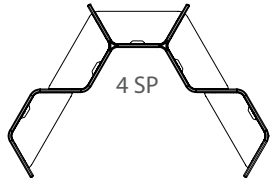

4 SP

8
18



6 SP

8

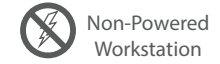
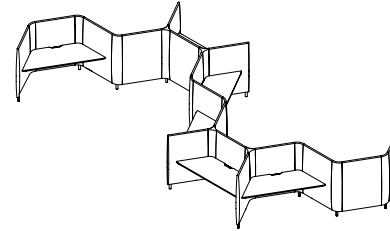

Number of Feet per Typical (MTL10 Option) "SP" Number of Starter Panels per Typical (RSP Option)

1 Select Model

Weight

Standard Veneer Top
Upholstered Panels - COM\$

Premium Veneer Top
Upholstered Panels - COM\$

High Pressure Laminate Top
Upholstered Panels - COM\$

Thermally Fused Laminate Top
Upholstered Panels - COM\$

w" x d" x h"	Weight	8	5
347 x 145 x 55	65	8 HNY347145FT586W 36664	5 HNY217145FT586W 23506
217 x 145 x 55	42		

"P" Option N/A
"P" Option N/A

HNY347145FT586G 35064
HNY217145FT586G 22506

HNY347145FT586M 32008
HNY217145FT586M 20596

Product Features

- 5" Solid wood feet - oval shape
- HNY7226WT162 Fixed Desk Height worksurfaces, 29" worksurface height
- Ships KD
- T75 worksurface wire cutout is standard on all worksurfaces.(T75D: Delete cutout is optional)

Options

Accessories

- K28: Articulating Keyboard w/ Mouse - \$390
- K31-SK: Center drawer w/ skirt - \$310
- K31: Center drawer w/o skirt - \$205

Concealed Floor Power Infeed Cover

- PCEB: White Metal Finish concealed floor power infeed cover - \$150

Delete Top

- DFT: Delete fixed top. Deduct \$1125 Veneer(W), \$955 High Pressure Laminate (G), \$630 Thermally Fused Laminate (M) per top

Metal Feet

- MTL10: Replace solid wood feet with metal feet, standard MFW White - \$55 ea

Premium Metal Finish

- Specify premium Metal Finish. MFMB: Matte Black, MFS: Silver, MFSS: Salmon Sienna, MFSA: Surfing Aquavert, MFPS: Pistachio, MFOS: Oyster, MFNA: Navy, MFOL: Olive, MFGB: Grey Beige MFGG: Graphite Gray, MFG: Gray, MFGM:Matte Gold
- Premium Metal Finish for WMT Wire Management Tray - \$75 ea
- Premium Metal Finish for MTL10 Metal Feet - \$20 ea
- Premium Metal Finish for PCEB Concealed Floor Power Infeed Cover - \$35

Starter Panel

- RSP: Substitute round starter panel in place of flat starter panel. Must substitute all starters, priced per starter panel - \$83 each. See HNY3555SP888

Worksurface Height

- Modify worksurface height to bar height.
- THL-42: Position worksurface at bar height - N/C

Wire Tray

- WMT: Wire metal tray. Mounts under top and comes standard in MFW White - \$210

[Click here to view statement of line](#)

[Click Here for Graded in Pricing](#)

2 Select Finish

Click to view finishes

WWP	WOW
PO01	WNO
PO02	WSO
PO03	WNF(Natural Oak on Flat Cut)
PO07	WSF(Salted Oak on Flat Cut)
PO08	
PO09	
WBW	
WSW	
WEC	

3 Select Feet Finish

Click to view edges

WWP	WOW
PO01	WNO
PO02	WSO
PO03	
PO07	
PO08	
PO09	
WBW	
WSW	
WEC	

4 Select Edge

Click to view details



GEC	LW05
GWL	LW06
LP01	
LF02	
LF03	
LN01	
LA02	
LW01	
LW02	
LW04	

WWP	WOW
PO01	WNO
PO02	WSO
PO03	
PO07	
PO08	
PO09	
WBW	
WSW	
WEC	



MOC
MEC
MSW
MTW
MWL
MNA

WWP	WOW
PO01	WNO
PO02	WSO
PO03	
PO07	
PO08	
PO09	
WBW	
WSW	



DARRAN

Honey

S-Shaped Workstation Typical
Desk with Power Fixed Worksurface

5
12

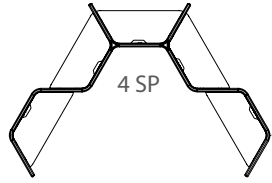

4 SP

8
18



6 SP

8

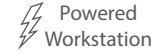
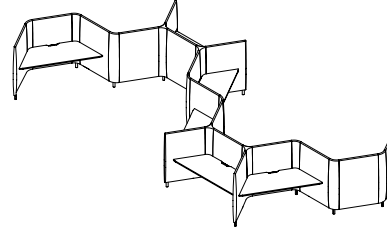

Number of Feet per Typical (MTL10 Option) "SP" Number of Starter Panels per Typical (RSP Option)

1 Select Model

w" x d" x h"	Weight	Standard Veneer Top Upholstered Panels - COM\$
347 x 145 x 55	65	8 HNY347145FP586W 39992
217 x 145 x 55	42	5 HNY217145FP586W 25679

Premium Veneer Top Upholstered Panels - COM\$

"P" Option N/A
"P" Option N/A

High Pressure Laminate Top Upholstered Panels - COM\$

HNY347145FP586G 38392
HNY217145FP586G 24679

Thermally Fused Laminate Top Upholstered Panels - COM\$

HNY347145FP586M 35336
HNY217145FP586M 22769

Product Features

- HNY7226WT162 Fixed Desk Height worksurfaces, 29" worksurface height
- 5" Solid wood feet - oval shape
- 4 Power outlets with 1 telecom plate, see options below for telecom plate
- Ships KD
- Wire management tray attaches to worksurface top, standard in MFW White, see premium Metal Finish for options
- Hardwire infeed and jumpers are included in workstations
- T75 worksurface wire cutout is standard on all worksurfaces.(T75D: Delete cutout is optional)

Options

Accessories

- K28: Articulating Keyboard w/ Mouse - \$390
- K31-SK: Center drawer w/ skirt - \$310
- K31: Center drawer w/o skirt - \$205

Concealed Floor Power Infeed Cover

- PCEB: White Metal Finish concealed floor power infeed cover - \$150

Delete Top and Wire Tray

- DFP: Delete fixed top. Deduct \$1335 Veneer (W), \$1165 High Pressure Laminate (G), \$840 Thermally Fused Laminate (M) per top

Metal Feet

- MTL10: Replace solid wood feet with metal feet, standard MFW White - \$55 ea

Premium Metal Finish

- Specify premium Metal Finish. MFMB: Matte Black, MFS: Silver, MFSS: Salmon Sienna, MFSA: Surfing Aquavert, MFPS: Pistachio, MFOS: Oyster, MFNA: Navy, MFOL: Olive, MFGB: Grey Beige MFGG: Graphite Gray, MFG: Gray, MFGM:Matte Gold
- Premium Metal Finish for WMT Wire Management Tray - \$75 ea
- Premium Metal Finish for MTL10 Metal Feet - \$20 ea
- Premium Metal Finish for PCEB Concealed Floor Power Infeed Cover - \$35

Starter Panel

- RSP: Substitute round starter panel in place of flat starter panel. Must substitute all starters, priced per starter panel - \$83 each. See HNY3555SP888

Telecom Plates

- Each power unit has 1 plate. All telecom connectors sold separately.
- RJ45 (1) - \$55, RJ45 (2) - \$110, RJ45 (3) - \$165, USB (1) - \$70, USB (2) - \$140, RJ45/USB - \$125, RJ45/HDMI - \$210, HDMI/USB - \$205

Worksurface Height

- THL-42: Modify worksurface height to bar height - N/C

[Click Here for Graded in Pricing](#)

2 Select Finish

Click to view finishes

WWP	WOW
PO01	WNO
PO02	WSO
PO03	WNF(Natural Oak on Flat Cut)
PO07	WSF(Salted Oak on Flat Cut)
PO08	
PO09	
WBW	
WSW	
WEC	

3 Select Feet Finish

Click to view edges

WWP	WOW
PO01	WNO
PO02	WSO
PO03	
PO07	
PO08	
PO09	
WBW	
WSW	
WEC	

4 Select Edge

Click to view details



GEC	LW05
GWL	LW06
LP01	
LF02	
LF03	
LN01	
LA02	
LW01	
LW02	
LW04	

WWP	WOW
PO01	WNO
PO02	WSO
PO03	
PO07	
PO08	
PO09	
WBW	
WSW	
WEC	



MOC
MEC
MSW
MTW
MWL
MNA

WWP	WOW
PO01	WNO
PO02	WSO
PO03	
PO07	
PO08	
PO09	
WEC	
WBW	
WSW	





Chameleon Price List

Effective November 1, 2022

Designed By Mark Müller

Date	Page	Modification	Description
9.26.22		WNF and WSF	WNF and WSF finish added to all items
10.5.22		Chameleon new items	Credenzas, wall hung cabinets, pedestals and storage added
10.18.22	16-17	Modesties	Veneer and HPL ½ modesties added to Table Desks
10.18.22	54	Caster color	Mobile pedestals have a standard gray caster with a black ring
10.27.22		Hardware	Hardware N/A on Sliding Door note added under Hardware on credenzas with sliding doors
10.28.22	36-37,40,46-47	Cushions	Added cushion pricing
11.08.22		Metal Finish	Added MFGM Matte Gold and MFDB Dark Bronze Premium Metal Finish
11.10.22		Price Increase	9% price increase applied to all items excluding options
12.6.22			Chassis components are ¾" thick instead of 5/8" thick
12.21.22	1	Removed Quartered Ash Veneer	
02.21.23		Changed felt to acoustic material on privacy screens, interpersonal screens and modesty panels	

Features & Advantages1
Finishes | Specifications2
Edges | Pulls7
Configured Storage.....8
Ganging.....11
Stacking.....13
Power Guide.....14
Grommets | Wire management15
Power Options16
Chameleon Grain Direction19
Drawer Dimensions | Filing Reference.....20
Table Desk.....21
Height Adjustable Table Desk23
Conference Table24
Ganging Credenzas26
Freestanding Credenzas30
Sit-On Storage.....40
Mobile Pedestals.....43
Wall hung44
Freestanding Screens47
Towers.....51
Bookcases.....56
Privacy Screens58
Power & data options.....68



Page 16
Table desks with Solid Wood Legs
Soft Rectangle Table Top with Solid Wood Legs



Page 17
Table desks with Solid Wood Legs
Soft rectangle Runoff with solid wood legs



Page 18
Height Adjustable Table Desk
Soft Rectangle Table Top with white height adjustable base



Page 19
Conference Table
Round Table with solid wood legs



Page 20
Swivel Conference Table
Round Table with solid wood legs

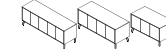

Page 21
Freestanding Storage Credenza
Door Storage



Page 22
Freestanding Credenza
Door Storage,Box/File,Open Storage, Door Storage



Page 23
Freestanding Credenza
Door Storage, File, Open Storage, Door Storage



Page 24
Freestanding Credenza
Door Storage,Open Storage,Box/File,Door Storage



Page 25
Freestanding Credenza
Door Storage, Open Storage, File, Door Storage

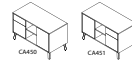

Page 26
Freestanding Credenza
Box/File Storage

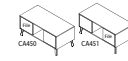

Page 27
Freestanding Credenza
File Storage

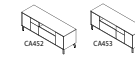

Page 28
Freestanding Credenza
Box/File Drop Door Storage



Page 29
Freestanding Credenza
File Drop Door



Page 30
Freestanding Credenza
Box/File Drop Door Storage



Page 31
Freestanding Credenza
File Drop Door



Page 32
Freestanding Credenza
Box/File Drop Door



Page 33
Freestanding Credenza
File Drop Door

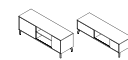

Page 34
Freestanding Credenza
Sliding Door/Door Storage

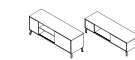

Page 35
Freestanding Credenza
Door Storage/Sliding Door



Page 36
Freestanding Credenza
Sliding Door/Open Storage

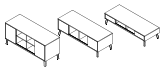

Page 37
Freestanding Credenza
Sliding Door Storage x2

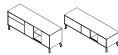

Page 38
Freestanding Credenza
Box Lateral/Door/Open/Sliding Door

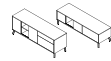

Page 39
Freestanding Credenza
Sliding Door/Open/Door/Box Lateral



Page 40
Freestanding Credenza
Box Drawer/ Sliding Door

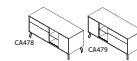

Page 41
Freestanding Credenza
Box Lateral/Open/ Sliding Door

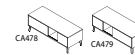

Page 42
Freestanding Credenza
Lateral File/Sliding Door

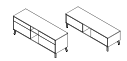

Page 43
Freestanding Credenza
Box Lateral/Open/Box Lateral



Page 44
Freestanding Screen
Box Lateral/Open Storage



Page 45
Freestanding
Box Lateral/Open Storage



Page 46
Freestanding
30" Open Credenza

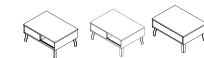

Page 47
Freestanding
30" Drop Door/Sliding Door/Box Drawer

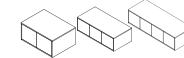

Page 48
Sit-On Door Storage
30"/45"/60" Sit On Storage

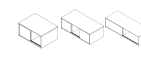

Page 49
Sit-On Door Storage
30"/45"/60" Sit On Sliding Door Cabinet



Page 50
Sit-On Door Storage
30"/45"/60" Sit On Drop Door Cabinet

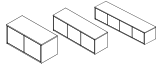

Page 51
Single Height Wall Hung Cabinet
30"/45"/60" Open Cabinet

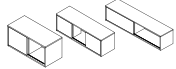

Page 52
Single Height Wall Hung Cabinet
30"/45"/60" Sliding Door

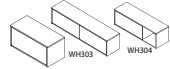

Page 53
Single Height Wall Hung Cabinet
30"/45"/60" Lift-Up Door Cabinet



Page 54
Mobile Pedestals
Open Plan Mobile Desk Pedestal
With Casters



Page 55
Vertical Half Tower
Storage - Panel Door



Page 56
Vertical Half Tower
Storage Wardrobe - Panel Door



Page 57
Vertical Full Tower
Storage Wardrobe - Panel Door



side storage access

Page 58
Vertical Full Tower
Storage Side Access Wardrobe -
Panel Door



Page 59
Vertical Full Tower
Storage - Panel Door

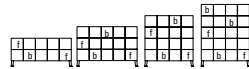

Page 60
Open Plan Bookcase
Fixed Type A Insert Placement

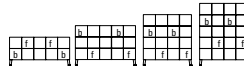

Page 61
Open Plan Bookcase
Fixed Type B Insert Placement



Page 62
Interpersonal Screen
Acoustic Interpersonal Screen



modesty

Page 63
Privacy Screen
Acoustic Modesty



CST4 optional caster

Page 64
Freestanding Screen - 40"W x
56"H
Screen with Solid Wood Legs



CST4 optional caster

Page 65
Freestanding Screen - 54"W x
56"H
Screen with Solid Wood Legs



CST4 optional caster

Page 66
Freestanding Screen - 40"W x
66"H
Screen with Solid Wood Legs



CST4 optional caster

Page 67
Freestanding Screen - 54"W
x 66"H
Screen with Solid Wood Legs



privacy screen

Page 68
Privacy Screen
Acoustic Worksurface Interper-
sonal Screen

DARRAN®

Veneer and HPL tops

Veneer tops and high-pressure laminate tops feature a 45-pound density substrate with balanced 3-ply construction. Tops are 1" thick with soft rectangle shape. DARRAN only uses Oak and Walnut Veneers. Tops feature a sealed and polished MDF edge standard, or 2mm Veneer edge, or 1mm PVC band to match HPL top, or 3mm PVC black or white band. Tops are finished in 5-sheen matte finish.

Forbo Tops

Forbo is a durable, sustainable surface linoleum manufactured from natural bio-based raw materials that contributes to a healthy indoor environment inspired by nature. Solid color Forbo is available on table tops in a selection of hues.

Cleaning wood & laminate

In addition to regular dusting, give your furniture an occasional cleaning in accordance with our cleaning instructions. DARRAN wood and laminate products can be cleaned with a soft cloth and a mild soap and water mixture. Use approximately 32 oz of water mixed with one tablespoon of dish soap, always wiping with the grain. Dry with a soft cloth, going with the grain, to avoid spotting or streaking.

Wood products should be waxed periodically using a non-wax liquid; please do not use any waxy polish or cleaner. Interior of drawers may also be cleaned with mild soap and water mixture, or any household cleaner that is not petroleum or thinner-based.

Cases

Chassis components are ¾" thick with 3-ply balanced construction. Pedestal and Cabinets feature cam and dowel construction reinforced with glue.

Drawer fronts

Drawer fronts are vertically matched in balanced sets

Adjustable glides

Glides provide 5/8" of vertical leveling adjustment. Glide bottom is durable plastic.

Suspensions

All casegoods utilize cold rolled steel zinc plated high-grade drawer suspensions. All suspensions are warranted for the lifetime of the product. Box and File drawers are full extension, featuring steel ball bearings for a smoother quieter range of motion with soft close operation and are rated 100lbs. Lateral file drawers are a progressive action full extension suspension with the soft close operation and is rated at 150lbs.

Filing

Chameleon features a highly durable black plastic extrusion that is securely fastened into a route on top of the drawer to support hanging files. An adjustable crossbar is provided for all

Chameleon Features & Advantages

file drawers that enables legal/letter filing front to back or side-to-side based on the drawer size.

Locks

Locks are optional on pedestals and doors. Each drawer pedestal is independently locked. Lock plugs are factory or field installed.

Keying

Keying is available either factory or field installed. Factory installed keying offers two options: random or designated. When the random keying option is selected an arbitrary key number will be assigned to the unit. When the designated keying option is selected a key number must be specified between 101 and 110. Higher numbers may be specified if noted on the purchase order and may be factory or field installed. Black and silver face lock have silver keys.

Wire management

Wire management capabilities include standard and optional worksurface grommets. Specify W21 under surface wire channels for organization and management of all communication wires and cords. Sold separately to conceal wire under worksurfaces.

Grommets

Metal grommets are provided to match the drawer pull selection. Grommet is available in black, silver or white. Must specify standard or non-standard location. Black plastic grommets are available as an option for vertical applications.

Powerports

A large selection of power options are available to handle power, data, docking stations and communication. See options section for selection.

LED tasklights

LED task lighting provides high efficiency, low energy lighting with a long life. Surface mounted light is encased in silver aluminum channel with milk lense and rounded end caps. Lights are field installed. Product specifications listed below:

- Diffuser creates a softer light and eliminates hot spots
- Touch dimmer switch
- Can be "daisy chained" up to 90W
- 4.6 watts per foot
- 120 LEDs per meter
- Certification: UL Listed
- 50,000 hour life span.

Color Temp is 4000K

DARRAN®

STANDARD VENEER

Finishes on Red Oak

- PO01 Olive
- PO02 Aquavert
- PO03 Mushroom
- PO07 Pebble
- PO08 Vapour
- PO09 Verde



visible wood grain

Paint Finishes on MDF

- PM01 Olive
- PM02 Aquavert
- PM03 Mushroom
- PM07 Pebble
- PM08 Vapour
- PM10 Verde
- WWP Designer White
- WEC Ebony



painted full coverage

PREMIUM VENEER

- WLA Lofty Ash
- WOW Clear Walnut
- WNO Natural Oak
- WSO Salted Oak

HIGH PRESSURE LAMINATE

- GWL Designer White
- GEC Ebony
- GNA Narvik Ash + 5%
- LP01 Surfin USA
- LF02 Just Rose
- LF03 Folkstone
- LN01 Cafe Sienna
- LA02 Verde Chair + 20
- LW01 Neo Walnut
- LW02 Fawn Cypress
- LW04 Phantom Pearl
- LW05 Phantom Ecru
- LW06 Phantom Cocoa

Chameleon Finishes | Specifications

TFL

- MAC Amber Cherry
- MEC Ebony
- MOC KoKo Cherry
- MGW Gunstock Walnut
- MNA Narvik Ash
- MSW Skyline
- MTW Studio Teak
- MWL Designer White

*Send 3x3 or larger finish chip for color match. Custom finish upcharge is 3% or \$250 Net (whichever is greater).



Finish

Welltech Finish delivers a superior furniture coating with exceptional performance that can withstand stringent cleaning agents and possesses unparalleled durability, allowing DARRAN to provide lasting, sustainable products to our customers.

Felts

Performance felt is a unique blend of non-dyed wool and man made fibers. This felt can fulfill the most critical design requirements and is a sustainable LEED contributing product. Color variation will occur due to natural fibers.

Felts are available on Screen Inserts, mobile Seat Pads, and Bookcase Inserts.



FL07
Vanilla



FL06
Burnt Orange



FL08
Mango



FL12
Burgundy



FL10
Meadow Green



FL05
Sky Blue



FL11
Light Blue



FL09
Teal



FL01
Sand



FL04
Pebble Grey



FL03
Light Grey



FL02
Charcoal



Bookcase inserts



Screen inserts can be felt or veneer

Acoustic material

Felt-like acoustic material is fabricated from compressed recycled plastic bottles, and gives warmth to contemporary design.

Acoustic material is available on privacy and modesty panels.

Standard



Charcoal Gray
17



Heather Gray
3

PREMIUM



Midnight Blue
21

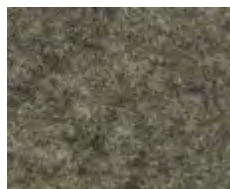

Olive
35

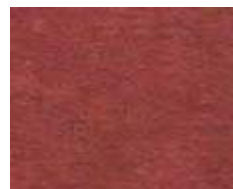

Burgundy
29



Spring Green
39

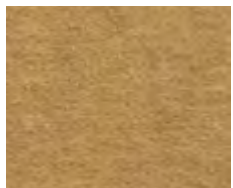

Amber
18

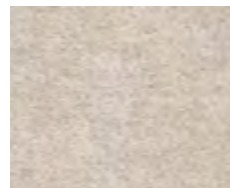

Ash
2



Slate
34



Privacy panel

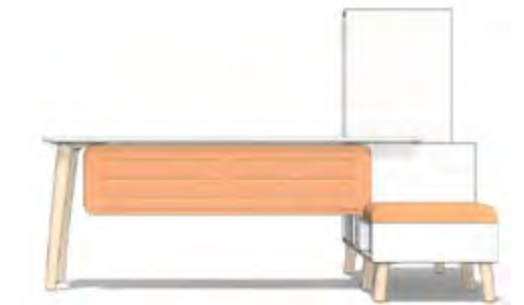

Modesty panel



Modesty panel

Chameleon metal finishes give the appearance of minimalistic designs that are adaptable in all changing work environments. Metal finishes available on table desk legs, modesty panels and privacy panels.

Metal is standard in MFW White. Premium Metal Finish: Priced per unit on product page.

STANDARD

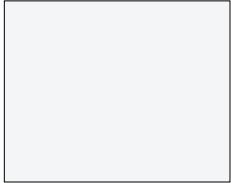

MFW White
Satin Finish
(Standard)

PREMIUM



MFGB Graphite Gray
Matte Finish
(Premium)



MFS Silver
Satin Finish
(Premium)



MFMB Matte Black
Matte Finish
(Premium)



MFNA Navy
Matte Finish
(Premium)



MFOL Olive
Matte Finish
(Premium)



MFGB Grey Beige
Matte Finish
(Premium)



MFSA Surfin Aquavert
Matte Finish
(Premium)



MFOS Oyster
Matte Finish
(Premium)



MFPS Pistachio
Matte Finish
(Premium)



MFSS Salmon Sienna
Matte Finish
(Premium)

STANDARD PROFILE

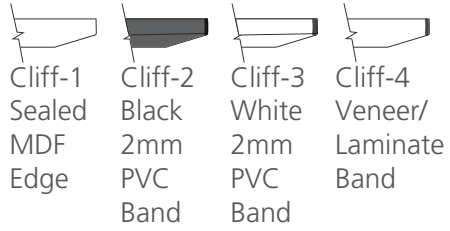

PREMIUM PROFILE

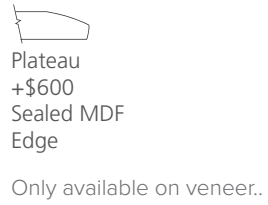

Chameleon features a polished MDF edge standard. 2mm Veneer or 3mm PVC banding is available. Veneer edge is not available with Forbo top. Contact customer service for pricing

PULLS

Push to Open Standard: Optional Hardware Below



PL - 406 Gloss White
PL - 407 Matte Chrome



PL - 506 Gloss White
PL - 507 Matte Chrome



Vertical grommet sleeve TM60 - \$50

The aesthetic of Chameleon is found in its diverse layout options for ganging and stacking. Credenzas gang with an optional Vertical Grommet Sleeve TM60 - \$50. Grommets are field installed, a template will be provided when a TM60 is specified. The template details the location of 3 grommets for the installer.

Location 1



Location 2
or
Location 1



Location 3
or
Location 2
or
Location 1



To gang credenzas, bore pilot holes to connect units together. Bore four 5/16" holes with provided template. Squeeze clamp both units together to align. Bore four additional 5/16" holes in the connecting credenza end panel. Use connector bolts and sleeve to connect.

Backs are fixed, image below is for illustration purposes to show how units gang and wire management.

Ganging

Front View



Ganging

Back View



Infeed

Concealed 4" wire channel and fixed back
Bottom panel exit for floor plug



Infeed

Back panel exit for wall plug



Chameleon stacking units can have up to one unit stacked on another. Chameleon units can not be stacked more than two units high with a max height of 42".



All chameleon cases are constructed with a concealed 4" wire channel and a fixed back panel. Power runs through concealed 4" wire channel, and exits the case at the bottom to a floor or wall power source.



Top View

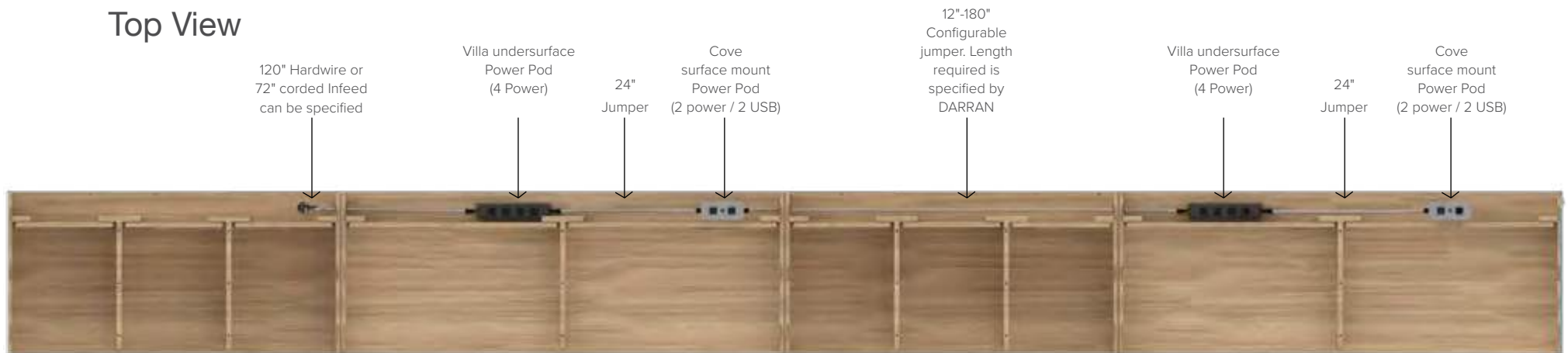

TM30
Black
1-5/8" Dia.

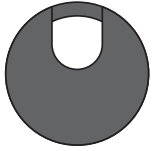

TM31
Silver
1-5/8" Dia.

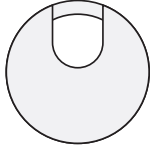

TM34
White
1-5/8" Dia.

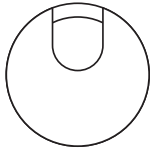

Optional Grommets

Factory Installed (Over Beltline Wire Management Cavity)
Grommets (Standard Location)

- Specify Color and Left/Right/Center - \$50 ea.
 - Black: TM30-R (Right), TM30-L (Left), TM30-C (Center)
 - Silver: TM31-R (Right), TM31-L (Left), TM31-C (Center)
 - White: TM34-R (Right), TM34-L (Left), TM34-C (Center)

Grommets (Non-Standard Location)

- Provide drawing w/ Grommet Location and Specify Color - \$95 ea.
 - Black: TM30-NS
 - Silver: TM31-NS
 - White: TM33-NS

TM60
Black
1-5/8" Dia..



Chameleon Grommets | Wire Management

Grommets (Vertical Surface)

- Field Installed - \$50 ea.
 - Black Plastic Vertical Surface: TM60

Conference Wire Management

Power and data cables can be discretely housed and managed. 10"W x 1.5"D x 1.25"H
 W21: Grey Wire Manager (10.5") - \$35

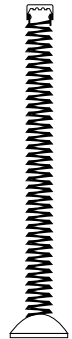
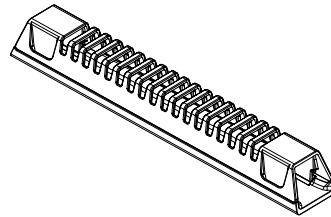

Coil Wire Management

W18 - Coil (Black) - \$160

- *Field Installed
 - Weighted base, table top attachment plate
 - 39-1/2" Length



Vertebrae Wire management

- W22 - Vertebrae (Clear) - \$135
 W23 - Vertebrae (Gray) - \$140

*Field Installed

Configure Chameleon power based on project specification. The Daisy Chain starter power unit is required first, then specify the number of Daisy Chain Linking Units needed. For Hardwire Systems the max number of Linking Units to be daisy chained off of a Starter Power Unit is 11. For Corded Systems the max number of Linking Units to be daisy chained off of a Starter Power Unit is 2.

Chameleon Daisy Chain Starter Power Unit



CHM-DCH HARDWIRED  \$975
 Includes (1) cove pod with top 2 power and 2 USB ports, (1) 24" Jumper (1) Villa under mount pod with 4 power with 120"Hardwire Infeed

+

Chameleon Daisy Chain Linking Unit



CHM-DCL \$950
 Includes (1) 24" Jumper, (1) Villa under mount pod with 4 power, (1) 24" Jumper, (1) Cove pod with top 2 power and 2 USB ports

Style Number List Price

Chameleon Daisy Chain Starter Power Unit

CHM-DCH HARDWIRED  \$975

Includes (1) cove pod with top 2 power and 2 USB ports, (1) 24" Jumper (1) Villa under mount pod with 4 power with 120" Hardwire Infeed

CHM-DCP PLUG  \$975

Includes (1) cove pod with top 2 power and 2 USB ports, (1) 24" Jumper (1) Villa under mount pod with 4 power with 72" Plug Infeed

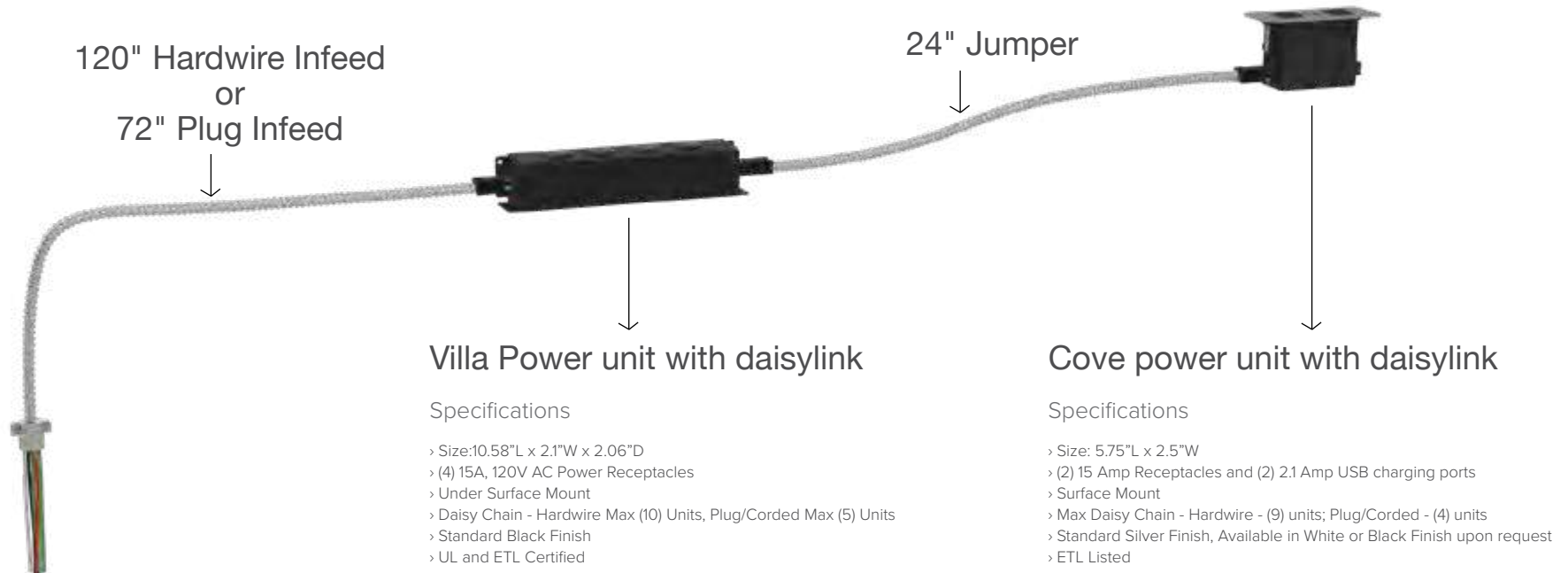

Style Number List Price

LINKING UNIT

CHM-DCL \$950

Includes (1) 24" Jumper, (1) Villa under mount pod with 4 power, (1) 24" Jumper, (1) Cove pod with top 2 power and 2 USB ports

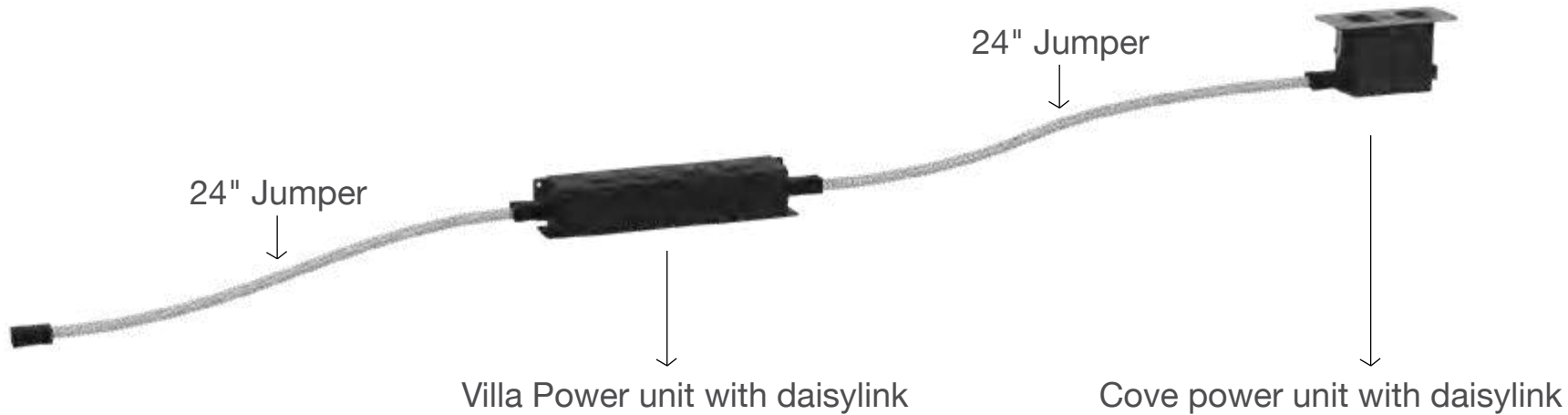

Villa Power unit with daisylink

Specifications

- > Size: 10.58"L x 2.1"W x 2.06"D
- > (4) 15A, 120V AC Power Receptacles
- > Under Surface Mount
- > Daisy Chain - Hardwire Max (10) Units, Plug/Corded Max (5) Units
- > Standard Black Finish
- > UL and ETL Certified

Cove power unit with daisylink

Specifications

- > Size: 5.75"L x 2.5"W
- > (2) 15 Amp Receptacles and (2) 2.1 Amp USB charging ports
- > Surface Mount
- > Max Daisy Chain - Hardwire - (9) units; Plug/Corded - (4) units
- > Standard Silver Finish, Available in White or Black Finish upon request
- > ETL Listed

Grain Direction

Veneer and laminate chassis parts are vertical grain. Veneer and laminate backs over 75" are horizontal grain.



Desk

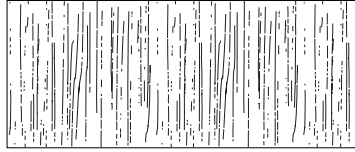

Runoff Desk
Grain Direction on
Laminate Units Above 75"
runs end to end

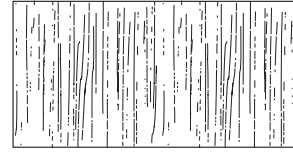

Bridge
Grain Direction on
Laminate Units Above 75"
runs end to end



Credenza

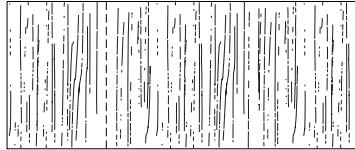

Return
Grain Direction on
Laminate Units Above 75"
runs end to end

Interior Drawer Dimensions

UNIT DEPTH	DRAWER TYPE	OVERALL DIMENSIONS			INTERIOR DRAWER DIMENSIONS			NOTES
		W	D	H	W	D	H	
15-5/8" Letter	22" Box	13-1/8	16-1/16	4	12-1/8	15-1/16	3-7/16	Units less than 72"
	22" File	13-1/8	16-1/16	9-13/16	12-1/8	15-1/16	9-5/16	Units less than 72"
29" Lateral	22" Box	27-3/4	16-1/16	4	26-3/4	15-1/16	3-7/16	Workstation Credenzas less than 82"
	22" File	27-3/4	16-1/16	9-13/16	26-3/4	15-1/16	9-5/16	Workstation Credenzas less than 82"

Filing Reference

Filing for 22" depth units

13 1/8" Wide File Drawer - 16 1/16" Deep

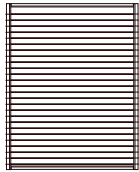

Letter Front to Back

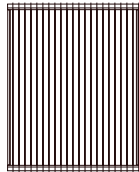

Legal Side to Side with File Rail

30" Lateral file drawer

30" : 27-3/4" Wide File Drawer - 16-1/16" Deep

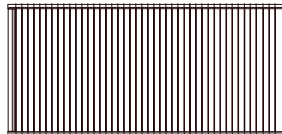

Legal Side to Side

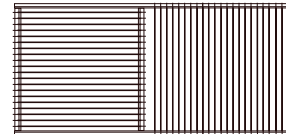

Legal Side to Side Letter Front to Back with File Rail

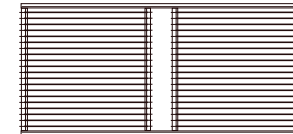

Letter Front to Back with File Rail

Chameleon

Table desks with Solid Wood Legs
Soft Rectangle Table Top with Solid Wood Legs

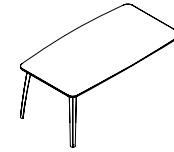

[Click here to view statement of line](#)

1 Select Model

w" x d" x h"
72 x 36 x 29
72 x 30 x 29
66 x 33 x 29
66 x 30 x 29
60 x 30 x 29

Weight

Standard Veneer Top Solid Wood Legs	Premium Veneer Top Solid Wood Legs	High Pressure Laminate Top Solid Wood Legs	Thermally Fused Laminate Top Solid Wood Legs
CHM7236DT097W 4317	CHM7236DT097P 4749	CHM7236DT097G 4297	CHM7236DT097M 2998
CHM7230DT097W 4298	CHM7230DT097P 4729	CHM7230DT097G 4277	CHM7230DT097M 2829
CHM6633DT097W 4304	CHM6633DT097P 4734	CHM6633DT097G 4284	CHM6633DT097M 2971
CHM6630DT097W 4243	CHM6630DT097P 4668	CHM6630DT097G 4221	CHM6630DT097M 2807
CHM6030DT097W 4213	CHM6030DT097P 4635	CHM6030DT097G 4177	CHM6030DT097M 2785

Product Features

- 1" Thick top
- WellTech Finish
- Solid wood legs
- Ships KD

Options

Accessories

- K28: Articulating Keyboard w/ Mouse - \$390
- K31: Center drawer - \$205
- K31-SK: Center drawer w/ skirt - \$310

Grommets (Standard Location)

- Specify Color and Left/Right - \$50 ea.
- Black: TM30-R (Right), TM30-L (Left)
 - Silver: TM31-R (Right), TM31-L (Left)
 - White: TM34-R (Right), TM34-L (Left)

Grommets (Non-Standard Location)

- Provide drawing w/ grommet location and specify color - \$95 ea.
- Black: TM30-NS
 - Silver: TM31-NS
 - White: TM34-NS

Modesty

- HMAP14: Acoustic Modesty Panel - \$527
- HMVP5414: 54 x 14 x 3/4 Half Veneer modesty - \$740
- HMVP4614: 46 x 14 x 3/4 Half Veneer modesty - \$705
- HMVP3814: 38 x 14 x 3/4 Half Veneer modesty - \$670
- HMLP5414: 54 x 14 x 3/4 Half HPL modesty - \$740
- HMLP4614: 46 x 14 x 3/4 Half HPL modesty - \$705
- HMLP3814: 38 x 14 x 3/4 Half HPL modesty - \$670

Privacy Screen

- FAPS14: Acoustic Privacy Screen (Approach Privacy) - \$527
- SAPS14: Acoustic Privacy Screen (Side Privacy) - \$468

Modify Leg

- M-1: Modify one 28" height leg to 7" height leg - no charge
- M-2: Modify two 28" height leg to 7" height leg - no charge
- M-3: Modify one 28" height leg to 14" height leg - no charge
- M-4: Modify two 28" height leg to 14" height leg - no charge

2 Select Finish

[Click to view finishes](#)

Top Finishes	Leg Finishes
WNF	PO02 WOW PO09
WSF	PO03 WNO
WWP	PO07 WSO
WEC	PO08 WLA
PM01	PO09 WWP
PM02	WEC
PM03	PO01
PM07	PO02
PM08	PO03
PM10	PO07
PO01	PO08

Top Finishes	Leg Finishes
WOW	WOW PO08
WNO	WNO PO09
WSO	WLA
WLA	WLA
	WWP
	WEC
	PO01
	PO02
	PO03
	PO07

Top Finishes	Leg Finishes
GWL LW05	WWP
GEC LW06	WOW
LP01	WNO
LF02	WSO
LF03	WLA
LN01	WEC
LA02	PO01
LW01	PO02
LW02	PO03
LW04	PO07
	PO08
	PO09

Top Finishes	Leg Finishes
MAC	WOW PO08
MEC	WNO PO09
MOC	WSO
MGW	WLA
MNA	WWP
MSW	WEC
MTW	PO01
MWL	PO02
	PO03
	PO07

3 Select Edge

[Click to view edges](#)

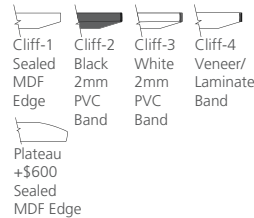
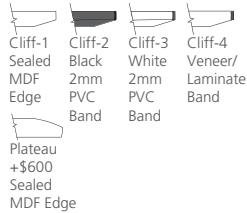

4 Select Hardware

[Click to view details](#)

Hardware
N/A

Hardware
N/A

Hardware
N/A

Hardware
N/A

Chameleon

Table desks with Solid Wood Legs
Soft rectangle Runoff with solid wood legs

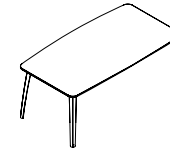

[Click here to view statement of line](#)

1 Select Model

w" x d" x h"
Legs left, right hookup
72 x 36 x 29
72 x 30 x 29
66 x 33 x 29
66 x 30 x 29
60 x 30 x 29
Legs right, left hookup
72 x 36 x 29
72 x 30 x 29
66 x 33 x 29
66 x 30 x 29
60 x 30 x 29

Weight

Standard Veneer Top Solid Wood Legs	Premium Veneer Top Solid Wood Legs	High Pressure Laminate Top Solid Wood Legs	Thermally Fused Laminate Top Solid Wood Legs
CHM7236DR774W 3542	CHM7236DR774P 3896	CHM7236DR774G 3523	CHM7236DR774M 2022
CHM7230DR774W 3493	CHM7230DR774P 3843	CHM7230DR774G 3402	CHM7230DR774M 1843
CHM6633DR774W 3530	CHM6633DR774P 3883	CHM6633DR774G 3508	CHM6633DR774M 1995
CHM6630DR774W 3462	CHM6630DR774P 3809	CHM6630DR774G 3389	CHM6630DR774M 1821
CHM6030DR774W 3432	CHM6030DR774P 3775	CHM6030DR774G 3375	CHM6030DR774M 1799
CHM7236DR775W 3542	CHM7236DR775P 3896	CHM7236DR775G 3523	CHM7236DR775M 2022
CHM7230DR775W 3493	CHM7230DR775P 3843	CHM7230DR775G 3402	CHM7230DR775M 1843
CHM6633DR775W 3530	CHM6633DR775P 3883	CHM6633DR775G 3508	CHM6633DR775M 1995
CHM6630DR775W 3462	CHM6630DR775P 3809	CHM6630DR775G 3389	CHM6630DR775M 1821
CHM6030DR775W 3432	CHM6030DR775P 3775	CHM6030DR775G 3375	CHM6030DR775M 1799

2 Select Finish

[Click to view finishes](#)

Top Finishes	Leg Finishes
WNF	PO02 WOW PO09
WSF	PO03 WNO
WWP	PO07 WSO
WEC	PO08 WLA
PM01	PO09 WWP
PM02	WEC
PM03	PO01
PM07	PO02
PM08	PO03
PM10	PO07
PO01	PO08

Top Finishes	Leg Finishes
WOW	WOW PO08
WNO	WNO PO09
WSO	WSO
WLA	WLA
	WWP
	WEC
	PO01
	PO02
	PO03
	PO07

Top Finishes	Leg Finishes
GWL LW05	WWP
GEC LW06	WOW
LP01	WNO
LF02	WSO
LF03	WLA
LN01	WEC
LA02	PO01
LW01	PO02
LW02	PO03
LW04	PO07
	PO08
	PO09

Top Finishes	Leg Finishes
MAC	WOW PO08
MEC	WNO PO09
MOC	WSO
MGW	WLA
MNA	WWP
MSW	WEC
MTW	PO01
MWL	PO02
	PO03
	PO07

3 Select Edge

[Click to view edges](#)

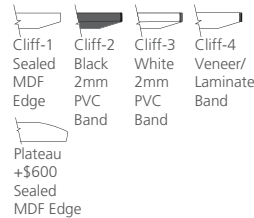

4 Select Hardware

[Click to view details](#)

Hardware
N/A

Hardware
N/A

Hardware
N/A

Hardware
N/A

Product Features

- 1" Thick top
- WellTech Finish
- Solid wood legs

Notes

- Table is designed to rest freely on top of case goods with non-slip bumper.

Options

Accessories

- K28: Articulating Keyboard w/ Mouse - \$390
- K31: Center drawer - \$205
- K31-SK: Center drawer w/ skirt - \$310

Grommets (Standard Location)

- Specify Color and Left/Right - \$50 ea.
- Black: TM30-R (Right), TM30-L (Left)
- Silver: TM31-R (Right), TM31-L (Left)
- White: TM34-R (Right), TM34-L (Left)

Grommets (Non-Standard Location)

- Provide drawing w/ grommet location and specify color - \$95 ea.
- Black: TM30-NS
- Silver: TM31-NS
- White: TM34-NS

Modesty

- HMAP14: Acoustic Modesty Panel - \$527
- HMVP5414: 54 x 14 x 3/4 Half Veneer modesty - \$740
- HMVP4614: 46 x 14 x 3/4 Half Veneer modesty - \$705
- HMVP3814: 38 x 14 x 3/4 Half Veneer modesty - \$670
- HMLP5414: 54 x 14 x 3/4 Half HPL modesty - \$740
- HMLP4614: 46 x 14 x 3/4 Half HPL modesty - \$705
- HMLP3814: 38 x 14 x 3/4 Half HPL modesty - \$670

Privacy Screen

- FAPS14: Acoustic Privacy Screen (Approach Privacy) - \$527
- SAPS14: Acoustic Privacy Screen (Side Privacy) - \$468

Chameleon

Height Adjustable Table Desk
Soft Rectangle Table Top with white height adjustable base

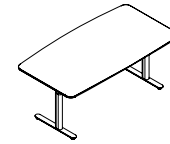

[Click here to view statement of line](#)

1 Select Model

w" x d" x h"
72 x 36 x 29
72 x 30 x 29
66 x 33 x 29
66 x 30 x 29
60 x 30 x 29

Weight

Standard Veneer Top Metal Base	Premium Veneer Top Metal Base	High Pressure Laminate Top Metal Base	Thermally Fused Laminate Top Metal Base
CHM7236DT090W 4219	CHM7236DT090P 4641	CHM7236DT090G 4132	CHM7236DT090M 3543
CHM7230DT090W 4181	CHM7230DT090P 4599	CHM7230DT090G 4138	CHM7230DT090M 3265
CHM6633DT090W 4207	CHM6633DT090P 4628	CHM6633DT090G 4111	CHM6633DT090M 3516
CHM6630DT090W 4144	CHM6630DT090P 4559	CHM6630DT090G 4099	CHM6630DT090M 3243
CHM6030DT090W 4108	CHM6030DT090P 4519	CHM6030DT090G 4065	CHM6030DT090M 1799

Product Features

- Adjustable height from 29" to 50" with a maximum weight capacity of 220 lbs.
- Lift standard in MFW White
- Metal parts include 5 year warranty
- Programmable height adjustable mechanism, motor includes 2 year warranty
- Oval leg shape

Options

Grommets (Standard Location)

Specify Color and Left/Right - \$50 ea.

- Black: TM30-R (Right), TM30-L (Left)
- Silver: TM31-R (Right), TM31-L (Left)
- White: TM34-R (Right), TM34-L (Left)

Grommets (Non-Standard Location)

Provide drawing w/ grommet location and specify color - \$95 ea.

- Black: TM30-NS
- Silver: TM31-NS
- White: TM34-NS

Modesty

- HMAP14: Acoustic Modesty Panel - \$527
- HMVP5414: 54 x 14 x 3/4 Half Veneer modesty - \$740
- HMVP4614: 46 x 14 x 3/4 Half Veneer modesty - \$705
- HMVP3814: 38 x 14 x 3/4 Half Veneer modesty - \$670
- HMLP5414: 54 x 14 x 3/4 Half HPL modesty - \$740
- HMLP4614: 46 x 14 x 3/4 Half HPL modesty - \$705
- HMLP3814: 38 x 14 x 3/4 Half HPL modesty - \$670

Privacy Screen

- FAPS14: Acoustic Privacy Screen (Approach Privacy) - \$527
- SAPS14: Acoustic Privacy Screen (Side Privacy) - \$468

Wire Management

- W18: Coil wire manager - \$160

2 Select Finish

[Click to view finishes](#)

Metal Finish
MFW White

Top Finishes

- | | |
|------|------|
| WNF | PO02 |
| WSF | PO03 |
| WWP | PO07 |
| WEC | PO08 |
| PM01 | PO09 |
| PM02 | |
| PM03 | |
| PM07 | |
| PM08 | |
| PM10 | |
| PO01 | |

Top Finishes

- WOW
WNO
WSO
WLA

Top Finishes

- GWL LW05
GEC LW06
LP01
LF02
LF03
LN01
LA02
LW01
LW02
LW04

Top Finishes

- MAC
MEC
MOC
MGW
MNA
MSW
MTW
MWL

3 Select Edge

[Click to view edges](#)

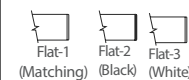
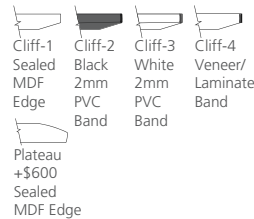
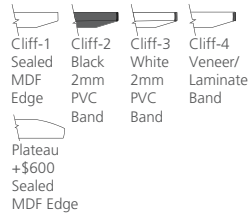

4 Select Hardware

[Click to view details](#)

Hardware
N/A

Hardware
N/A

Hardware
N/A

Hardware
N/A

Chameleon

Conference Table
Round Table with solid wood legs



[Click here to view statement of line](#)

1 Select Model

w" x d" x h"	Weight
60 DIA x 29	125
54 DIA x 29	95
48 DIA x 29	85
42 DIA x 29	75

Standard Veneer Top Solid Wood Legs		Premium Veneer Top Solid Wood Legs		High Pressure Laminate Top Solid Wood Legs		Thermally Fused Laminate Top Solid Wood Legs	
--	--	---------------------------------------	--	---	--	---	--

CHM6060RD121W	4047	CHM6060RD121P	4452	CHM6060RD121G	3717	CHM6060RD121M	3052
CHM5454RD121W	3727	CHM5454RD121P	4100	CHM5454RD121G	3491	CHM5454RD121M	3031
CHM4848RD121W	3401	CHM4848RD121P	3741	CHM4848RD121G	3261	CHM4848RD121M	2807
CHM4242RD121W	3075	CHM4242RD121P	3384	CHM4242RD121G	3035	CHM4242RD121M	2785

Product Features

- 1" Thick top
- WellTech Finish
- Solid wood legs
- Ships KD

Options

Delete Leg

- DWL128: Delete one 28" leg - deduct \$300
- DWL228: Delete two 28" legs - deduct \$600

Modify Leg

- M-1: Modify one 28" height leg to 7" height leg - no charge
- M-2: Modify two 28" height leg to 7" height leg - no charge
- M-3: Modify one 28" height leg to 14" height leg - no charge
- M-4: Modify two 28" height leg to 14" height leg - no charge

2 Select Finish

[Click to view finishes](#)

Top Finishes		Leg Finishes	
WNF	PO02	WOW	PO09
WSF	PO03	WNO	
WWP	PO07	WSO	
WEC	PO08	WLA	
PM01	PO09	WWP	
PM02		WEC	
PM03		PO01	
PM07		PO02	
PM08		PO03	
PM10		PO07	
PO01		PO08	

Top Finishes		Leg Finishes	
WOW	WOW	PO08	
WNO	WNO	PO09	
WSO	WSO		
WLA	WLA		
	WWP		
	WEC		
	PO01		
	PO02		
	PO03		
	PO07		

Top Finishes		Leg Finishes	
GWL	LW05	WWP	
GEC	LW06	WOW	
LP01		WNO	
LF02		WSO	
LF03		WLA	
LN01		WEC	
LA02		PO01	
LW01		PO02	
LW02		PO03	
LW04		PO07	
		PO08	
		PO09	

Top Finishes		Leg Finishes	
MAC	WOW	PO08	
MEC	WNO	PO09	
MOC	WSO		
MGW	WLA		
MNA	WWP		
MSW	WEC		
MTW	PO01		
MWL	PO02		
	PO03		
	PO07		

3 Select Edge

[Click to view edges](#)

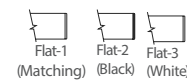
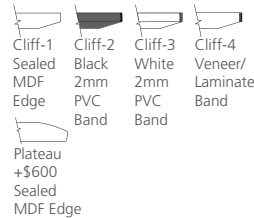
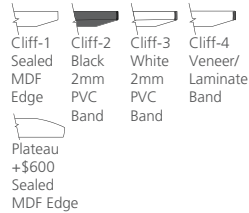

4 Select Hardware

[Click to view details](#)

Hardware
N/A

Hardware
N/A

Hardware
N/A

Hardware
N/A

Chameleon

Swivel Conference Table
Round Table with solid wood legs



[Click here to view statement of line](#)

1 Select Model

w" x d" x h"

Weight	Standard Veneer Top Solid Wood Legs		Premium Veneer Top Solid Wood Legs		High Pressure Laminate Top Solid Wood Legs		Thermally Fused Laminate Top Solid Wood Legs	
	60 DIA	125	CHM6060DR750W 3760	CHM6060DR750P 4136	CHM6060DR750G 3431	CHM6060DR750M 2834	60 DIA	125
54 DIA	95	CHM5454DR750W 3441	CHM5454DR750P 3785	CHM5454DR750G 3204	CHM5454DR750M 2813	54 DIA	95	CHM5454DR750W 3441
48 DIA	85	CHM4848DR750W 2861	CHM4848DR750P 3147	CHM4848DR750G 2975	CHM4848DR750M 2567	48 DIA	85	CHM4848DR750W 2861
42 DIA	75	CHM4242DR750W 2790	CHM4242DR750P 3069	CHM4242DR750G 2749	CHM4242DR750M 2546	42 DIA	75	CHM4242DR750W 2790

Product Features

- 1" Thick top
- WellTech Finish
- Solid wood legs
- Table Top features rotating swivel mechanism and legs come with low profile nylon casters to protect carpet, tile and hardwood flooring

2 Select Finish

[Click to view finishes](#)

Top Finishes		Leg Finishes		Top Finishes		Leg Finishes		Top Finishes		Leg Finishes		Top Finishes		Leg Finishes	
WNF	PO02	WOW	PO09	WOW	WOW	PO08	GWL	LW05	WWP	MAC	WOW	PO08	MAC	WOW	PO08
WSF	PO03	WNO		WNO	WNO	PO09	GEC	LW06	WOW	MEC	WNO	PO09	MEC	WNO	PO09
WWP	PO07	WSO		WSO	WSO		LP01		WNO	MOC	WSO		MOC	WSO	
WEC	PO08	WLA		WLA	WLA		LF02		WSO	MGW	WLA		MGW	WLA	
PM01	PO09	WWP		WWP	WWP		LF03		WLA	MNA	WWP		MNA	WWP	
PM02		WEC		WEC	WEC		LN01		WEC	MSW	WEC		MSW	WEC	
PM03		PO01		PO01	PO01		LA02		PO01	MTW	PO01		MTW	PO01	
PM07		PO02		PO02	PO02		LW01		PO02	MWL	PO02		MWL	PO02	
PM08		PO03		PO03	PO03		LW02		PO03		PO03			PO03	
PM10		PO07		PO07	PO07		LW04		PO07		PO07			PO07	
PO01		PO08		PO08	PO08				PO08		PO08			PO08	
									PO09		PO09			PO09	

3 Select Edge

[Click to view edges](#)

Cliff-1		Cliff-2		Cliff-3		Cliff-4		Cliff-1		Cliff-2		Cliff-3		Cliff-4		Flat-1		Flat-2		Flat-3	
Sealed	Black	White	Veneer/	Sealed	Black	White	Veneer/	Sealed	Black	White	Veneer/	Sealed	Black	White	Veneer/	(Matching)	(Black)	(White)			
MDF	2mm	2mm	Laminate	MDF	2mm	2mm	Laminate	MDF	2mm	2mm	Laminate	MDF	2mm	2mm	Laminate						
Edge	PVC	PVC	Band	Edge	PVC	PVC	Band	Edge	PVC	PVC	Band	Edge	PVC	PVC	Band						
Band	Band	Band	Band	Band	Band	Band	Band	Band	Band	Band	Band	Band	Band	Band	Band						
Plateau	+\$600	Sealed	MDF Edge	Plateau	+\$600	Sealed	MDF Edge														

4 Select Hardware

[Click to view details](#)

Hardware	Hardware	Hardware	Hardware
N/A	N/A	N/A	N/A

Chameleon

Freestanding Storage Credenza Door Storage

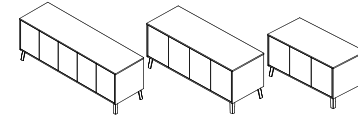

[Click here to view statement of line](#)

1 Select Model

w" x d" x h"
21" Height Case with 7" Leg
75 x 22 x 28
60 x 22 x 28
45 x 22 x 28
14" Height Case with 7" Leg
75 x 22 x 21
60 x 22 x 21
45 x 22 x 21

Weight

Standard Veneer Chassis Solid Wood Legs	Premium Veneer Chassis Solid Wood Legs	High Pressure Laminate Chassis Solid Wood Legs	Thermally Fused Laminate Chassis Solid Wood Legs
CHM7528CA125W 4628	CHM7528CA125P 5085	CHM7528CA125G 4399	CHM7528CA125M 3281
CHM6028CA125W 4110	CHM6028CA125P 4519	CHM6028CA125G 3903	CHM6028CA125M 2916
CHM4528CA125W 3772	CHM4528CA125P 4142	CHM4528CA125G 3581	CHM4528CA125M 2671
CHM7521CA125W 4083	CHM7521CA125P 4486	CHM7521CA125G 3881	CHM7521CA125M 2894
CHM6021CA125W 3728	CHM6021CA125P 3794	CHM6021CA125G 3543	CHM6021CA125M 2644
CHM4521CA125W 3450	CHM4521CA125P 3794	CHM4521CA125G 3276	CHM4521CA125M 2448

Product Features

- 4" cavity for wire management
- One Adjustable Shelf behind each door.(On 28" Height Only)
- Solid Wood Legs, Field installed.
- Dividers and shelves are finished to match case

Notes

- Unit designed for open plan use.

Options

Top Grommets(Over Belt Line Cavity Wire Management)

- Specify Color and Left/Right/Center- \$50 ea.
- Black: TM30-R(Right), TM30-L(Left), TM30-C(Center)
 - Silver: TM31-R(Right),TM31-L(Left),TM31-C(Center)
 - White: TM34-R(Right),TM34-L(Left),TM34-C(Center)

Grommets (For Ganging)

- Vertical sleeve grommet, template provided for field installation
- TM60: Vertical Grommet Sleeve - \$50

Door lock

- D2: Door/ Lock (locks 1 door or 1 pedestal) - \$100 each

2 Select Finish

[Click to view finishes](#)

Case Finishes	Leg Finishes	Case Finishes	Leg Finishes	Case Finishes	Leg Finishes	Case Finishes	Leg Finishes
WNF	PO02 WOW	PO09	WOW	WOW	PO08	GWL	LW05 WWP
WSF	PO03 WNO		WLA	WNO	PO09	GEC	LW06 WOW
WWP	PO07 WSO		WNO	WSO		LP01	WNO WNO
WEC	PO08 WLA		WSO	WLA		LF02	WSO WSO
PM01	PO09 WWP			WWP		LF03	WLA WLA
PM02	WEC			WEC		LN01	WEC WEC
PM03	PO01			PO01		LA02	PO01 PO01
PM07	PO02			PO02		LW01	PO02 PO02
PM08	PO03			PO03		LW02	PO03 PO03
PM10	PO07			PO07		LW04	PO07 PO07
PO01	PO08			PO08			PO08 PO08
				PO09			PO09 PO09

3 Select Edge

[Click to view edges](#)

Edge
N/A

Edge
N/A

Edge
N/A

Edge
N/A

4 Select Hardware

[Click to view details](#)

Push to Open Standard:
Optional Hardware Below

Push to Open Standard:
Optional Hardware Below

Push to Open Standard:
Optional Hardware Below

Push to Open Standard:
Optional Hardware Below



Chameleon

Freestanding Credenza

Door Storage,Box/File,Open Storage, Door Storage

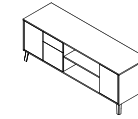

[Click here to view statement of line](#)

1 Select Model

w" x d" x h"
75 x 22 x 28
60 X 22 X 28

Weight

Standard Veneer Chassis Solid Wood Legs		Premium Veneer Chassis Solid Wood Legs		High Pressure Laminate Chassis Solid Wood Legs		Thermally Fused Laminate Chassis Solid Wood Legs	
CHM7528CA448W	4780	CHM7528CA448P	5254	CHM7528CA448G	4540	CHM7528CA448M	3390
CHM6028CA448W	4360	CHM6028CA448P	4791	CHM6028CA448G	4142	CHM6028CA448M	3091

Product Features

- 4" cavity for wire management
- One adjustable shelf behind each door storage/open storage.
- Solid Wood Legs, Field installed.
- Dividers and shelves are finished to match case

Notes

- Unit designed for open plan use.

Options

Top Grommets(Over Belt Line Cavity Wire Management)

Specify Color and Left/Right/Center- \$50 ea.

- Black: TM30-R(Right), TM30-L(Left), TM30-C(Center)
- Silver: TM31-R(Right),TM31-L(Left),TM31-C(Center)
- White: TM34-R(Right),TM34-L(Left),TM34-C(Center)

Grommets (For Ganging)

Vertical sleeve grommet, template provided for field installation

- TM60: Vertical Grommet Sleeve - \$50

Door lock

- D2: Door/ Lock (locks 1 door or 1 pedestal) - \$100 each

2 Select Finish

[Click to view finishes](#)

Case Finishes	Leg Finishes
WNF	PO02 WOW PO09
WSF	PO03 WNO
WWP	PO07 WSO
WEC	PO08 WLA
PM01	PO09 WWP
PM02	WEC
PM03	PO01
PM07	PO02
PM08	PO03
PM10	PO07
PO01	PO08

Case Finishes	Leg Finishes
WOW	WOW PO08
WLA	WNO PO09
WNO	WSO
WSO	WLA
	WWP
	WEC
	PO01
	PO02
	PO03
	PO07

Case Finishes	Leg Finishes
GWL LW05	WWP
GEC LW06	WOW
LP01	WNO
LF02	WSO
LF03	WLA
LN01	WEC
LA02	PO01
LW01	PO02
LW02	PO03
LW04	PO07
	PO08
	PO09

Case Finishes	Leg Finishes
MAC	WOW PO08
MEC	WNO PO09
MOC	WSO
MGW	WLA
MNA	WWP
MSW	WEC
MTW	PO01
MWL	PO02
	PO03
	PO07

3 Select Edge

[Click to view edges](#)

Edge
N/A

Edge
N/A

Edge
N/A

Edge
N/A

4 Select Hardware

[Click to view details](#)

Push to Open Standard:
Optional Hardware Below

Push to Open Standard:
Optional Hardware Below

Push to Open Standard:
Optional Hardware Below

Push to Open Standard:
Optional Hardware Below



Chameleon

Freestanding Credenza

Door Storage, File, Open Storage, Door Storage

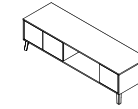

[Click here to view statement of line](#)

1 Select Model

w" x d" x h"
75 x 22 x 21
60 x 22 x 21

Weight

Standard Veneer Chassis Solid Wood Legs		Premium Veneer Chassis Solid Wood Legs		High Pressure Laminate Chassis Solid Wood Legs		Thermally Fused Laminate Chassis Solid Wood Legs	
CHM7521CA448W	4137	CHM7521CA448P	4546	CHM7521CA448G	3930	CHM7521CA448M	2933
CHM6021CA448W	3859	CHM6021CA448P	4241	CHM6021CA448G	3668	CHM6021CA448M	2736

Product Features

- 4" cavity for wire management
- Solid Wood Legs, Field installed.
- Dividers are finished to match case

Notes

- Unit designed for open plan use.

Options

Top Grommets(Over Belt Line Cavity Wire Management)

- Specify Color and Left/Right/Center- \$50 ea.
- Black: TM30-R(Right), TM30-L(Left), TM30-C(Center)
 - Silver: TM31-R(Right),TM31-L(Left),TM31-C(Center)
 - White: TM34-R(Right),TM34-L(Left),TM34-C(Center)

Grommets (For Ganging)

- Vertical sleeve grommet, template provided for field installation
- TM60: Vertical Grommet Sleeve - \$50

Door lock

- D2: Door/ Lock (locks 1 door or 1 pedestal) - \$100 each

2 Select Finish

[Click to view finishes](#)

Case Finishes	Leg Finishes
WNF	PO02 WOW PO09
WSF	PO03 WNO
WWP	PO07 WSO
WEC	PO08 WLA
PM01	PO09 WWP
PM02	WEC
PM03	PO01
PM07	PO02
PM08	PO03
PM10	PO07
PO01	PO08

Case Finishes	Leg Finishes
WOW	WOW PO08
WLA	WNO PO09
WNO	WSO
WSO	WLA
	WWP
	WEC
	PO01
	PO02
	PO03
	PO07

Case Finishes	Leg Finishes
GWL LW05	WWP
GEC LW06	WOW
LP01	WNO
LF02	WSO
LF03	WLA
LN01	WEC
LA02	PO01
LW01	PO02
LW02	PO03
LW04	PO07
	PO08
	PO09

Case Finishes	Leg Finishes
MAC	WOW PO08
MEC	WNO PO09
MOC	WSO
MGW	WLA
MNA	WWP
MSW	WEC
MTW	PO01
MWL	PO02
	PO03
	PO07

3 Select Edge

[Click to view edges](#)

Edge
N/A

Edge
N/A

Edge
N/A

Edge
N/A

4 Select Hardware

[Click to view details](#)

Push to Open Standard:
Optional Hardware Below

Push to Open Standard:
Optional Hardware Below

Push to Open Standard:
Optional Hardware Below

Push to Open Standard:
Optional Hardware Below



Chameleon

Freestanding Credenza

Door Storage, Open Storage, Box/File, Door Storage

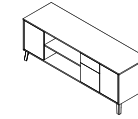

[Click here to view statement of line](#)

1 Select Model

w" x d" x h"
75 x 22 x 28
60 x 22 x 28

Weight

Standard Veneer Chassis Solid Wood Legs		Premium Veneer Chassis Solid Wood Legs		High Pressure Laminate Chassis Solid Wood Legs		Thermally Fused Laminate Chassis Solid Wood Legs	
CHM7528CA449W	4780	CHM7528CA449P	5254	CHM7528CA449G	4540	CHM7528CA449M	3390
CHM6028CA449W	4360	CHM6028CA449P	4791	CHM6028CA449G	4142	CHM6028CA449M	3091

Product Features

- 4" cavity for wire management
- One Adjustable Shelf behind each door.
- Solid Wood Legs, Field installed.
- Dividers and shelves are finished to match case

Notes

- Unit designed for open plan use.

Options

Top Grommets(Over Belt Line Cavity Wire Management)

- Specify Color and Left/Right/Center- \$50 ea.
- Black: TM30-R(Right), TM30-L(Left), TM30-C(Center)
 - Silver: TM31-R(Right),TM31-L(Left),TM31-C(Center)
 - White: TM34-R(Right),TM34-L(Left),TM34-C(Center)

Grommets (For Ganging)

- Vertical sleeve grommet, template provided for field installation
- TM60: Vertical Grommet Sleeve - \$50

Door lock

- D2: Door/ Lock (locks 1 door or 1 pedestal) - \$100 each

2 Select Finish

[Click to view finishes](#)

Case Finishes	Leg Finishes
WNF	PO02 WOW PO09
WSF	PO03 WNO
WWP	PO07 WSO
WEC	PO08 WLA
PM01	PO09 WWP
PM02	WEC
PM03	PO01
PM07	PO02
PM08	PO03
PM10	PO07
PO01	PO08

Case Finishes	Leg Finishes
WOW	PO08
WLA	PO09
WNO	
WSO	
	WLA
	WWP
	WEC
	PO01
	PO02
	PO03
	PO07

Case Finishes	Leg Finishes
GWL LW05	WWP
GEC LW06	WOW
LP01	WNO
LF02	WSO
LF03	WLA
LN01	WEC
LA02	PO01
LW01	PO02
LW02	PO03
LW04	PO07
	PO08
	PO09

Case Finishes	Leg Finishes
MAC	WOW PO08
MEC	WNO PO09
MOC	WSO
MGW	WLA
MNA	WWP
MSW	WEC
MTW	PO01
MWL	PO02
	PO03
	PO07

3 Select Edge

[Click to view edges](#)

Edge
N/A

Edge
N/A

Edge
N/A

Edge
N/A

4 Select Hardware

[Click to view details](#)

Push to Open Standard:
Optional Hardware Below

Push to Open Standard:
Optional Hardware Below

Push to Open Standard:
Optional Hardware Below

Push to Open Standard:
Optional Hardware Below



Chameleon

Freestanding Credenza

Door Storage, Open Storage, File, Door Storage

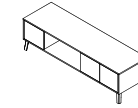

[Click here to view statement of line](#)

1 Select Model

w" x d" x h"
75 x 22 x 21
60 x 22 x 21

Weight

Standard Veneer Chassis Solid Wood Legs		Premium Veneer Chassis Solid Wood Legs		High Pressure Laminate Chassis Solid Wood Legs		Thermally Fused Laminate Chassis Solid Wood Legs	
CHM7521CA449W	4137	CHM7521CA449P	4546	CHM7521CA449G	3930	CHM7521CA449M	2933
CHM6021CA449W	3859	CHM6021CA449P	4241	CHM6021CA449G	3668	CHM6021CA449M	2736

Product Features

- 4" cavity for wire management
- Solid Wood Legs, Field installed.
- Dividers are finished to match case

Notes

- Unit designed for open plan use.

Options

Top Grommets(Over Belt Line Cavity Wire Management)

- Specify Color and Left/Right/Center- \$50 ea.
- Black: TM30-R(Right), TM30-L(Left), TM30-C(Center)
 - Silver: TM31-R(Right),TM31-L(Left),TM31-C(Center)
 - White: TM34-R(Right),TM34-L(Left),TM34-C(Center)

Grommets (For Ganging)

- Vertical sleeve grommet, template provided for field installation
- TM60: Vertical Grommet Sleeve - \$50

Door lock

- D2: Door/ Lock (locks 1 door or 1 pedestal) - \$100 each

2 Select Finish

[Click to view finishes](#)

Case Finishes	Leg Finishes
WNF	PO02 WOW PO09
WSF	PO03 WNO
WWP	PO07 WSO
WEC	PO08 WLA
PM01	PO09 WWP
PM02	WEC
PM03	PO01
PM07	PO02
PM08	PO03
PM10	PO07
PO01	PO08

Case Finishes	Leg Finishes
WOW	WOW PO08
WNO	WNO PO09
WSO	WLA
WLA	WLA
	WWP
	WEC
	PO01
	PO02
	PO03
	PO07

Case Finishes	Leg Finishes
GWL LW05	WWP
GEC LW06	WOW
LP01	WLA
LF02	WNO
LF03	WSO
LN01	WEC
LA02	PO01
LW01	PO02
LW02	PO03
LW04	PO07
	PO08
	PO09

Case Finishes	Leg Finishes
MAC	WOW PO08
MEC	WNO PO09
MOC	WSO
MGW	WLA
MNA	WWP
MSW	WEC
MTW	PO01
MWL	PO02
	PO03
	PO07

3 Select Edge

[Click to view edges](#)

Edge
N/A

Edge
N/A

Edge
N/A

Edge
N/A

4 Select Hardware

[Click to view details](#)

Push to Open Standard:
Optional Hardware Below

Push to Open Standard:
Optional Hardware Below

Push to Open Standard:
Optional Hardware Below

Push to Open Standard:
Optional Hardware Below



Chameleon

Freestanding Credenza Box/File Storage

[Click here to view statement of line](#)

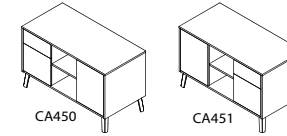

1 Select Model

w" x d" x h"
Box/File Left
45 x 22 x 28
Box/File Right
45 x 22 x 28

Weight

Standard Veneer Chassis Solid Wood Legs	Premium Veneer Chassis Solid Wood Legs	High Pressure Laminate Chassis Solid Wood Legs	Thermally Fused Laminate Chassis Solid Wood Legs
--	---	---	---

CHM4528CA450W 4012	CHM4528CA450P 4410	CHM4528CA450G 3810	CHM4528CA450M 2845
CHM4528CA451W 4012	CHM4528CA451P 4410	CHM4528CA451G 3810	CHM4528CA451M 2845

Product Features

- 4" cavity for wire management
- One Adjustable Shelf behind each door.
- Solid Wood Legs, Field installed.
- Dividers and shelves are finished to match case

Notes

- Unit designed for open plan use.

Options

Top Grommets(Over Belt Line Cavity Wire Management)

- Specify Color and Left/Right/Center- \$50 ea.
- Black: TM30-R(Right), TM30-L(Left), TM30-C(Center)
 - Silver: TM31-R(Right),TM31-L(Left),TM31-C(Center)
 - White: TM34-R(Right),TM34-L(Left),TM34-C(Center)

Grommets (For Ganging)

- Vertical sleeve grommet, template provided for field installation
- TM60: Vertical Grommet Sleeve - \$50

Door lock

- D2: Door/ Lock (locks 1 door or 1 pedestal) - \$100 each

2 Select Finish

[Click to view finishes](#)

Case Finishes	Leg Finishes
WNF	PO02 WOW PO09
WSF	PO03 WNO
WWP	PO07 WSO
WEC	PO08 WLA
PM01	PO09 WWP
PM02	WEC
PM03	PO01
PM07	PO02
PM08	PO03
PM10	PO07
PO01	PO08

Case Finishes	Leg Finishes
WOW	WOW PO08
WNO	WNO PO09
WSO	WLA
WLA	WLA
	WWP
	WEC
	PO01
	PO02
	PO03
	PO07

Case Finishes	Leg Finishes
GWL LW05	WWP
GEC LW06	WOW
LP01	WLA
LF02	WNO
LF03	WSO
LN01	WEC
LA02	PO01
LW01	PO02
LW02	PO03
LW04	PO07
	PO08
	PO09

Case Finishes	Leg Finishes
MAC	WOW PO08
MEC	WNO PO09
MOC	WSO
MGW	WLA
MNA	WWP
MSW	WEC
MTW	PO01
MWL	PO02
	PO03
	PO07

3 Select Edge

[Click to view edges](#)

Edge
N/A

Edge
N/A

Edge
N/A

Edge
N/A

4 Select Hardware

[Click to view details](#)

Push to Open Standard:
Optional Hardware Below

Push to Open Standard:
Optional Hardware Below

Push to Open Standard:
Optional Hardware Below

Push to Open Standard:
Optional Hardware Below



Chameleon

Freestanding Credenza

File Storage

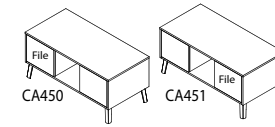

[Click here to view statement of line](#)

1 Select Model

w" x d" x h"
File Left
45 x 22 x 21
File Right
45 x 22 x 21

Weight

Standard Veneer Chassis Solid Wood Legs	Premium Veneer Chassis Solid Wood Legs	High Pressure Laminate Chassis Solid Wood Legs	Thermally Fused Laminate Chassis Solid Wood Legs
--	---	---	---

CHM4521CA450W 3581	CHM4521CA450P 3935	CHM4521CA450G 3401	CHM4521CA450M 2540
CHM4521CA451W 3581	CHM4521CA451P 3935	CHM4521CA451G 3401	CHM4521CA451M 2540

Product Features

- 4" cavity for wire management
- Solid Wood Legs, Field installed.
- Dividers are finished to match case

Notes

- Unit designed for open plan use.

Options

Top Grommets(Over Belt Line Cavity Wire Management)

- Specify Color and Left/Right/Center- \$50 ea.
- Black: TM30-R(Right), TM30-L(Left), TM30-C(Center)
 - Silver: TM31-R(Right),TM31-L(Left),TM31-C(Center)
 - White: TM34-R(Right),TM34-L(Left),TM34-C(Center)

Grommets (For Ganging)

- Vertical sleeve grommet, template provided for field installation
- TM60: Vertical Grommet Sleeve - \$50

Door lock

- D2: Door/ Lock (locks 1 door or 1 pedestal) - \$100 each

2 Select Finish

[Click to view finishes](#)

Case Finishes	Leg Finishes
WNF	PO02 WOW PO09
WSF	PO03 WNO
WWP	PO07 WSO
WEC	PO08 WLA
PM01	PO09 WWP
PM02	WEC
PM03	PO01
PM07	PO02
PM08	PO03
PM10	PO07
PO01	PO08

Case Finishes	Leg Finishes
WOW	WOW PO08
WNO	WNO PO09
WSO	WLA
WLA	WLA
	WWP
	WEC
	PO01
	PO02
	PO03
	PO07

Case Finishes	Leg Finishes
GWL LW05	WWP
GEC LW06	WOW
LP01	WLA
LF02	WNO
LF03	WSO
LN01	WEC
LA02	PO01
LW01	PO02
LW02	PO03
LW04	PO07
	PO08
	PO09

Case Finishes	Leg Finishes
MAC	WOW PO08
MEC	WNO PO09
MOC	WSO
MGW	WLA
MNA	WWP
MSW	WEC
MTW	PO01
MWL	PO02
	PO03
	PO07

3 Select Edge

[Click to view edges](#)

Edge
N/A

Edge
N/A

Edge
N/A

Edge
N/A

4 Select Hardware

[Click to view details](#)

Push to Open Standard:
Optional Hardware Below

Push to Open Standard:
Optional Hardware Below

Push to Open Standard:
Optional Hardware Below

Push to Open Standard:
Optional Hardware Below



Chameleon

Freestanding Credenza
Box/File Drop Door Storage

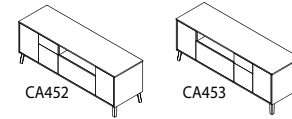

[Click here to view statement of line](#)

1 Select Model

w" x d" x h"
Box/File Drop Door
75 x 22 x 28
Drop Door Box/File
75 x 22 x 28

Weight

Standard Veneer Chassis Solid Wood Legs	Premium Veneer Chassis Solid Wood Legs	High Pressure Laminate Chassis Solid Wood Legs	Thermally Fused Laminate Chassis Solid Wood Legs
--	---	---	---

CHM7528CA452W 5298	CHM7528CA452P 5821	CHM7528CA452G 5031	CHM7528CA452M 3756
CHM7528CA453W 5298	CHM7528CA453P 5821	CHM7528CA453G 5031	CHM7528CA453M 3756

Product Features

- 4" cavity for wire management
- One Adjustable Shelf behind each door.
- Solid Wood Legs, Field installed.
- Dividers and shelves are finished to match case

Notes

- Unit designed for open plan use.

Options

Top Grommets(Over Belt Line Cavity Wire Management)

- Specify Color and Left/Right/Center- \$50 ea.
- Black: TM30-R(Right), TM30-L(Left), TM30-C(Center)
 - Silver: TM31-R(Right),TM31-L(Left),TM31-C(Center)
 - White: TM34-R(Right),TM34-L(Left),TM34-C(Center)

Grommets (For Ganging)

- Vertical sleeve grommet, template provided for field installation
- TM60: Vertical Grommet Sleeve - \$50

Door lock

- D2: Door/ Lock (locks 1 door or 1 pedestal) - \$100 each

2 Select Finish

[Click to view finishes](#)

Case Finishes	Leg Finishes
WNF	PO02 WOW PO09
WSF	PO03 WNO
WWP	PO07 WSO
WEC	PO08 WLA
PM01	PO09 WWP
PM02	WEC
PM03	PO01
PM07	PO02
PM08	PO03
PM10	PO07
PO01	PO08

Case Finishes	Leg Finishes
WOW	WOW PO08
WNO	WNO PO09
WSO	WLA
WLA	WLA
	WWP
	WEC
	PO01
	PO02
	PO03
	PO07

Case Finishes	Leg Finishes
GWL LW05	WWP
GEC LW06	WOW
LP01	WLA
LF02	WNO
LF03	WSO
LN01	WEC
LA02	PO01
LW01	PO02
LW02	PO03
LW04	PO07
	PO08
	PO09

Case Finishes	Leg Finishes
MAC	WOW PO08
MEC	WNO PO09
MOC	WSO
MGW	WLA
MNA	WWP
MSW	WEC
MTW	PO01
MWL	PO02
	PO03
	PO07

3 Select Edge

[Click to view edges](#)

Edge
N/A

Edge
N/A

Edge
N/A

Edge
N/A

4 Select Hardware

[Click to view details](#)

Push to Open Standard:
Optional Hardware Below

Push to Open Standard:
Optional Hardware Below

Push to Open Standard:
Optional Hardware Below

Push to Open Standard:
Optional Hardware Below



Chameleon

Freestanding Credenza
File Drop Door

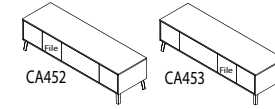

[Click here to view statement of line](#)

1 Select Model

w" x d" x h"
File Drop Door
75 x 22 x 21
Drop Door File
75 x 22 x 21

Weight

Standard Veneer Chassis Solid Wood Legs	Premium Veneer Chassis Solid Wood Legs	High Pressure Laminate Chassis Solid Wood Legs	Thermally Fused Laminate Chassis Solid Wood Legs
--	---	---	---

CHM7521CA452W 4655	CHM7521CA452P 5113	CHM7521CA452G 4420	CHM7521CA452M 3298
CHM7521CA453W 4655	CHM7521CA453P 5113	CHM7521CA453G 4420	CHM7521CA453M 3298

Product Features

- 4" cavity for wire management
- Solid Wood Legs, Field installed.
- Dividers are finished to match case

Notes

- Unit designed for open plan use.

Options

Top Grommets(Over Belt Line Cavity Wire Management)

- Specify Color and Left/Right/Center- \$50 ea.
- Black: TM30-R(Right), TM30-L(Left), TM30-C(Center)
 - Silver: TM31-R(Right),TM31-L(Left),TM31-C(Center)
 - White: TM34-R(Right),TM34-L(Left),TM34-C(Center)

Grommets (For Ganging)

- Vertical sleeve grommet, template provided for field installation
- TM60: Vertical Grommet Sleeve - \$50

Door lock

- D2: Door/ Lock (locks 1 door or 1 pedestal) - \$100 each

2 Select Finish

[Click to view finishes](#)

Case Finishes	Leg Finishes
WNF	PO02 WOW PO09
WSF	PO03 WNO
WWP	PO07 WSO
WEC	PO08 WLA
PM01	PO09 WWP
PM02	WEC
PM03	PO01
PM07	PO02
PM08	PO03
PM10	PO07
PO01	PO08

Case Finishes	Leg Finishes
WOW	WOW PO08
WNO	WNO PO09
WSO	WLA
WLA	WLA
	WWP
	WEC
	PO01
	PO02
	PO03
	PO07

Case Finishes	Leg Finishes
GWL LW05	WWP
GEC LW06	WOW
LP01	WLA
LF02	WNO
LF03	WSO
LN01	WEC
LA02	PO01
LW01	PO02
LW02	PO03
LW04	PO07
	PO08
	PO09

Case Finishes	Leg Finishes
MAC	WOW PO08
MEC	WNO PO09
MOC	WSO
MGW	WLA
MNA	WWP
MSW	WEC
MTW	PO01
MWL	PO02
	PO03
	PO07

3 Select Edge

[Click to view edges](#)

Edge
N/A

Edge
N/A

Edge
N/A

Edge
N/A

4 Select Hardware

[Click to view details](#)

Push to Open Standard:
Optional Hardware Below

Push to Open Standard:
Optional Hardware Below

Push to Open Standard:
Optional Hardware Below

Push to Open Standard:
Optional Hardware Below



Chameleon

Freestanding Credenza
Box/File Drop Door Storage

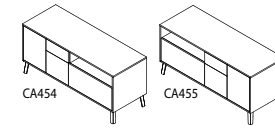

[Click here to view statement of line](#)

1 Select Model

w" x d" x h"
Door Storage/Box File/Drop Door
60 x 22 x 28
Drop Door/Box File/Door Storage
60 x 22 x 28

Height

Standard Veneer Chassis Solid Wood Legs	Premium Veneer Chassis Solid Wood Legs	High Pressure Laminate Chassis Solid Wood Legs	Thermally Fused Laminate Chassis Solid Wood Legs
--	---	---	---

CHM6028CA454W 4878	CHM6028CA454P 5358	CHM6028CA454G 4633	CHM6028CA454M 3456
CHM6028CA455W 4878	CHM6028CA455P 5358	CHM6028CA455G 4633	CHM6028CA455M 3456

Product Features

- 4" cavity for wire management
- One Adjustable Shelf behind each door.
- Solid Wood Legs, Field installed.
- Dividers and shelves are finished to match case

Notes

- Unit designed for open plan use.

Options

Top Grommets(Over Belt Line Cavity Wire Management)

- Specify Color and Left/Right/Center- \$50 ea.
- Black: TM30-R(Right), TM30-L(Left), TM30-C(Center)
 - Silver: TM31-R(Right),TM31-L(Left),TM31-C(Center)
 - White: TM34-R(Right),TM34-L(Left),TM34-C(Center)

Grommets (For Ganging)

- Vertical sleeve grommet, template provided for field installation
- TM60: Vertical Grommet Sleeve - \$50

Door lock

- D2: Door/ Lock (locks 1 door or 1 pedestal) - \$100 each

2 Select Finish

[Click to view finishes](#)

Case Finishes	Leg Finishes
WNF	PO02 WOW PO09
WSF	PO03 WNO
WWP	PO07 WSO
WEC	PO08 WLA
PM01	PO09 WWP
PM02	WEC
PM03	PO01
PM07	PO02
PM08	PO03
PM10	PO07
PO01	PO08

Case Finishes	Leg Finishes
WOW	PO08
WNO	PO09
WSO	
WLA	
WWP	
WEC	
PO01	
PO02	
PO03	
PO07	

Case Finishes	Leg Finishes
GWL LW05	WWP
GEC LW06	WOW
LP01	WLA
LF02	WNO
LF03	WSO
LN01	WEC
LA02	PO01
LW01	PO02
LW02	PO03
LW04	PO07
	PO08
	PO09

Case Finishes	Leg Finishes
MAC	WOW PO08
MEC	WNO PO09
MOC	WSO
MGW	WLA
MNA	WWP
MSW	WEC
MTW	PO01
MWL	PO02
	PO03
	PO07

3 Select Edge

[Click to view edges](#)

Edge
N/A

Edge
N/A

Edge
N/A

Edge
N/A

4 Select Hardware

[Click to view details](#)

Push to Open Standard:
Optional Hardware Below

Push to Open Standard:
Optional Hardware Below

Push to Open Standard:
Optional Hardware Below

Push to Open Standard:
Optional Hardware Below



Chameleon

Freestanding Credenza

File Drop Door

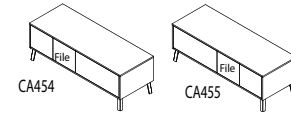

[Click here to view statement of line](#)

1 Select Model

w" x d" x h"
 Door Storage/File/Drop Door
 60 x 22 x 21
 Drop Door File
 60 x 22 x 21

Weight

Standard Veneer Chassis Solid Wood Legs	Premium Veneer Chassis Solid Wood Legs	High Pressure Laminate Chassis Solid Wood Legs	Thermally Fused Laminate Chassis Solid Wood Legs
--	---	---	---

CHM6021CA454W 4377	CHM6021CA454P 4807	CHM6021CA454G 4159	CHM6021CA454M 3102
CHM6021CA455W 4377	CHM6021CA455P 4807	CHM6021CA455G 4159	CHM6021CA455M 3102

Product Features

- 4" cavity for wire management
- Solid Wood Legs, Field installed.
- Dividers are finished to match case

Notes

- Unit designed for open plan use.

Options

Top Grommets(Over Belt Line Cavity Wire Management)

- Specify Color and Left/Right/Center- \$50 ea.
- Black: TM30-R(Right), TM30-L(Left), TM30-C(Center)
 - Silver: TM31-R(Right),TM31-L(Left),TM31-C(Center)
 - White: TM34-R(Right),TM34-L(Left),TM34-C(Center)

Grommets (For Ganging)

- Vertical sleeve grommet, template provided for field installation
- TM60: Vertical Grommet Sleeve - \$50

Door lock

- D2: Door/ Lock (locks 1 door or 1 pedestal) - \$100 each

2 Select Finish

[Click to view finishes](#)

Case Finishes	Leg Finishes
WNF	PO02 WOW PO09
WSF	PO03 WNO
WWP	PO07 WSO
WEC	PO08 WLA
PM01	PO09 WWP
PM02	WEC
PM03	PO01
PM07	PO02
PM08	PO03
PM10	PO07
PO01	PO08

Case Finishes	Leg Finishes
WOW	PO08
WNO	PO09
WSO	
WLA	
WWP	
WEC	
PO01	
PO02	
PO03	
PO07	

Case Finishes	Leg Finishes
GWL LW05	WWP
GEC LW06	WOW
LP01	WLA
LF02	WNO
LF03	WSO
LN01	WEC
LA02	PO01
LW01	PO02
LW02	PO03
LW04	PO07
	PO08
	PO09

Case Finishes	Leg Finishes
MAC	WOW PO08
MEC	WNO PO09
MOC	WSO
MGW	WLA
MNA	WWP
MSW	WEC
MTW	PO01
MWL	PO02
	PO03
	PO07

3 Select Edge

[Click to view edges](#)

Edge
N/A

Edge
N/A

Edge
N/A

Edge
N/A

4 Select Hardware

[Click to view details](#)

Push to Open Standard:
Optional Hardware Below

Push to Open Standard:
Optional Hardware Below

Push to Open Standard:
Optional Hardware Below

Push to Open Standard:
Optional Hardware Below



Chameleon

Freestanding Credenza
Box/File Drop Door

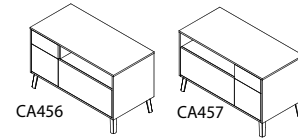

[Click here to view statement of line](#)

1 Select Model

w" x d" x h"
Box File/Drop Door
45 x 22 x 28
Drop Door/Box File
45 x 22 x 28

Weight

Standard Veneer Chassis Solid Wood Legs	Premium Veneer Chassis Solid Wood Legs	High Pressure Laminate Chassis Solid Wood Legs	Thermally Fused Laminate Chassis Solid Wood Legs
--	---	---	---

CHM4528CA456W 4529	CHM4528CA456P 4976	CHM4528CA456G 4301	CHM4528CA456M 3211
CHM4528CA457W 4529	CHM4528CA457P 4976	CHM4528CA457G 4301	CHM4528CA457M 3211

Product Features

- 4" cavity for wire management
- One Adjustable Shelf behind each door.
- Solid Wood Legs, Field installed.
- Dividers and shelves are finished to match case

Notes

- Unit designed for open plan use.

Options

Top Grommets(Over Belt Line Cavity Wire Management)

- Specify Color and Left/Right/Center- \$50 ea.
- Black: TM30-R(Right), TM30-L(Left), TM30-C(Center)
 - Silver: TM31-R(Right),TM31-L(Left),TM31-C(Center)
 - White: TM34-R(Right),TM34-L(Left),TM34-C(Center)

Grommets (For Ganging)

Vertical sleeve grommet, template provided for field installation

- TM60: Vertical Grommet Sleeve - \$50

Door lock

- D2: Door/ Lock (locks 1 door or 1 pedestal) - \$100 each

2 Select Finish

[Click to view finishes](#)

Case Finishes	Leg Finishes
WNF	PO02 WOW PO09
WSF	PO03 WNO
WWP	PO07 WSO
WEC	PO08 WLA
PM01	PO09 WWP
PM02	WEC
PM03	PO01
PM07	PO02
PM08	PO03
PM10	PO07
PO01	PO08

Case Finishes	Leg Finishes
WOW	WOW PO08
WNO	WNO PO09
WSO	WLA
WLA	WLA
	WWP
	WEC
	PO01
	PO02
	PO03
	PO07

Case Finishes	Leg Finishes
GWL LW05	WWP
GEC LW06	WOW
LP01	WLA
LF02	WNO
LF03	WSO
LN01	WEC
LA02	PO01
LW01	PO02
LW02	PO03
LW04	PO07
	PO08
	PO09

Case Finishes	Leg Finishes
MAC	WOW PO08
MEC	WNO PO09
MOC	WSO
MGW	WLA
MNA	WWP
MSW	WEC
MTW	PO01
MWL	PO02
	PO03
	PO07

3 Select Edge

[Click to view edges](#)

Edge
N/A

Edge
N/A

Edge
N/A

Edge
N/A

4 Select Hardware

[Click to view details](#)

Push to Open Standard:
Optional Hardware Below

Push to Open Standard:
Optional Hardware Below

Push to Open Standard:
Optional Hardware Below

Push to Open Standard:
Optional Hardware Below



Chameleon

Freestanding Credenza
File Drop Door

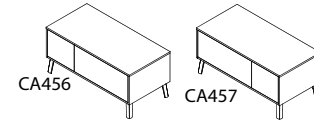

[Click here to view statement of line](#)

1 Select Model

w" x d" x h"
File/Drop Door
45 x 22 x 21
Drop Door/File
45 x 22 x 21

Weight

Standard Veneer Chassis Solid Wood Legs	Premium Veneer Chassis Solid Wood Legs	High Pressure Laminate Chassis Solid Wood Legs	Thermally Fused Laminate Chassis Solid Wood Legs
--	---	---	---

CHM4521CA456W 4099	CHM4521CA456P 4130	CHM4521CA456P 3892	CHM4521CA456M 2905
CHM4521CA457W 4099	CHM4521CA457P 4502	CHM4521CA457G 3892	CHM4521CA457M 2905

Product Features

- 4" cavity for wire management
- Solid Wood Legs, Field installed.
- Dividers are finished to match case

Notes

- Unit designed for open plan use.

Options

Top Grommets(Over Belt Line Cavity Wire Management)

- Specify Color and Left/Right/Center- \$50 ea.
- Black: TM30-R(Right), TM30-L(Left), TM30-C(Center)
 - Silver: TM31-R(Right),TM31-L(Left),TM31-C(Center)
 - White: TM34-R(Right),TM34-L(Left),TM34-C(Center)

Grommets (For Ganging)

- Vertical sleeve grommet, template provided for field installation
- TM60: Vertical Grommet Sleeve - \$50

Door lock

- D2: Door/ Lock (locks 1 door or 1 pedestal) - \$100 each

2 Select Finish

[Click to view finishes](#)

Case Finishes	Leg Finishes
WNF	PO02 WOW PO09
WSF	PO03 WNO
WWP	PO07 WSO
WEC	PO08 WLA
PM01	PO09 WWP
PM02	WEC
PM03	PO01
PM07	PO02
PM08	PO03
PM10	PO07
PO01	PO08

Case Finishes	Leg Finishes
WOW	WOW PO08
WNO	WNO PO09
WSO	WLA
WLA	WLA
	WWP
	WEC
	PO01
	PO02
	PO03
	PO07

Case Finishes	Leg Finishes
GWL LW05	WWP
GEC LW06	WOW
LP01	WLA
LF02	WNO
LF03	WSO
LN01	WEC
LA02	PO01
LW01	PO02
LW02	PO03
LW04	PO07
	PO08
	PO09

Case Finishes	Leg Finishes
MAC	WOW PO08
MEC	WNO PO09
MOC	WSO
MGW	WLA
MNA	WWP
MSW	WEC
MTW	PO01
MWL	PO02
	PO03
	PO07

3 Select Edge

[Click to view edges](#)

Edge
N/A

Edge
N/A

Edge
N/A

Edge
N/A

4 Select Hardware

[Click to view details](#)

Push to Open Standard:
Optional Hardware Below

Push to Open Standard:
Optional Hardware Below

Push to Open Standard:
Optional Hardware Below

Push to Open Standard:
Optional Hardware Below



Chameleon

Freestanding Credenza
Sliding Door/Door Storage

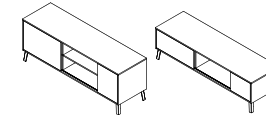

[Click here to view statement of line](#)

1 Select Model

w" x d" x h"
21" Height Case
75 x 22 x 28
14" Height Case
75 x 22 x 21

Weight

Standard Veneer Chassis Solid Wood Legs	Premium Veneer Chassis Solid Wood Legs	High Pressure Laminate Chassis Solid Wood Legs	Thermally Fused Laminate Chassis Solid Wood Legs
--	---	---	---

CHM7528CA458W 4557	CHM7528CA458P 5009	CHM7528CA458G 4328	CHM7528CA458M 3232
CHM7521CA458W 4050	CHM7521CA458P 4453	CHM7521CA458G 3848	CHM7521CA458M 2873

Product Features

- 4" cavity for wire management
- One Adjustable Shelf behind each door.(On 28" Height Only)
- Solid Wood Legs, Field installed.
- Dividers and shelves are finished to match case

Notes

- Unit designed for open plan use.

Options

Top Grommets(Over Belt Line Cavity Wire Management)

- Specify Color and Left/Right/Center- \$50 ea.
- Black: TM30-R(Right), TM30-L(Left), TM30-C(Center)
 - Silver: TM31-R(Right),TM31-L(Left),TM31-C(Center)
 - White: TM34-R(Right),TM34-L(Left),TM34-C(Center)

Grommets (For Ganging)

- Vertical sleeve grommet, template provided for field installation
- TM60: Vertical Grommet Sleeve - \$50

Door lock

- D2: Door/ Lock (locks 1 door or 1 pedestal) - \$100 each

2 Select Finish

[Click to view finishes](#)

Case Finishes	Leg Finishes
WNF	PO02 WOW PO09
WSF	PO03 WNO
WWP	PO07 WSO
WEC	PO08 WLA
PM01	PO09 WWP
PM02	WEC
PM03	PO01
PM07	PO02
PM08	PO03
PM10	PO07
PO01	PO08

Case Finishes	Leg Finishes
WOW	WOW PO08
WNO	WNO PO09
WSO	WLA
WLA	WLA
	WWP
	WEC
	PO01
	PO02
	PO03
	PO07

Case Finishes	Leg Finishes
GWL LW05	WWP
GEC LW06	WOW
LP01	WLA
LF02	WNO
LF03	WSO
LN01	WEC
LA02	PO01
LW01	PO02
LW02	PO03
LW04	PO07
	PO08
	PO09

Case Finishes	Leg Finishes
MAC	WOW PO08
MEC	WNO PO09
MOC	WSO
MGW	WLA
MNA	WWP
MSW	WEC
MTW	PO01
MWL	PO02
	PO03
	PO07

3 Select Edge

[Click to view edges](#)

Edge
N/A

Edge
N/A

Edge
N/A

Edge
N/A

4 Select Hardware

[Click to view details](#)

Push to Open Standard:
Optional Hardward Below
N/A on Sliding Door

Push to Open Standard:
Optional Hardward Below
N/A on Sliding Door

Push to Open Standard:
Optional Hardward Below
N/A on Sliding Door

Push to Open Standard:
Optional Hardward Below
N/A on Sliding Door



Chameleon

Freestanding Credenza
Door Storage/Sliding Door

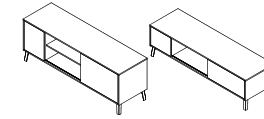

[Click here to view statement of line](#)

1 Select Model

w" x d" x h"
21" Height Case
75 x 22 x 28
14" Height Case
75 x 22 x 21

Weight

Standard Veneer Chassis Solid Wood Legs	Premium Veneer Chassis Solid Wood Legs	High Pressure Laminate Chassis Solid Wood Legs	Thermally Fused Laminate Chassis Solid Wood Legs
--	---	---	---

CHM7528CA459W 4557	CHM7528CA459P 5009	CHM7528CA459G 4328	CHM7528CA459M 3232
CHM7521CA459W 4050	CHM7521CA459P 4453	CHM7521CA459G 3848	CHM7521CA459M 2873

Product Features

- 4" cavity for wire management
- One Adjustable Shelf behind each door.(On 28" Height Only)
- Solid Wood Legs, Field installed.
- Dividers and shelves are finished to match case

Notes

- Unit designed for open plan use.

Options

Top Grommets(Over Belt Line Cavity Wire Management)

- Specify Color and Left/Right/Center- \$50 ea.
- Black: TM30-R(Right), TM30-L(Left), TM30-C(Center)
 - Silver: TM31-R(Right),TM31-L(Left),TM31-C(Center)
 - White: TM34-R(Right),TM34-L(Left),TM34-C(Center)

Grommets (For Ganging)

- Vertical sleeve grommet, template provided for field installation
- TM60: Vertical Grommet Sleeve - \$50

Door lock

- D2: Door/ Lock (locks 1 door or 1 pedestal) - \$100 each

2 Select Finish

[Click to view finishes](#)

Case Finishes	Leg Finishes
WNF	PO02 WOW PO09
WSF	PO03 WNO
WWP	PO07 WSO
WEC	PO08 WLA
PM01	PO09 WWP
PM02	WEC
PM03	PO01
PM07	PO02
PM08	PO03
PM10	PO07
PO01	PO08

Case Finishes	Leg Finishes
WOW	WOW PO08
WNO	WNO PO09
WSO	WLA
WLA	WLA
	WWP
	WEC
	PO01
	PO02
	PO03
	PO07

Case Finishes	Leg Finishes
GWL LW05	WWP
GEC LW06	WOW
LP01	WLA
LF02	WNO
LF03	WSO
LN01	WEC
LA02	PO01
LW01	PO02
LW02	PO03
LW04	PO07
	PO08
	PO09

Case Finishes	Leg Finishes
MAC	WOW PO08
MEC	WNO PO09
MOC	WSO
MGW	WLA
MNA	WWP
MSW	WEC
MTW	PO01
MWL	PO02
	PO03
	PO07

3 Select Edge

[Click to view edges](#)

Edge
N/A

Edge
N/A

Edge
N/A

Edge
N/A

4 Select Hardware

[Click to view details](#)

Push to Open Standard:
Optional Hardward Below
N/A on Sliding Door

Push to Open Standard:
Optional Hardward Below
N/A on Sliding Door

Push to Open Standard:
Optional Hardward Below
N/A on Sliding Door

Push to Open Standard:
Optional Hardward Below
N/A on Sliding Door



Chameleon

Freestanding Credenza
Sliding Door/Open Storage

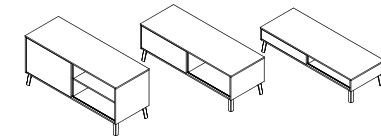

[Click here to view statement of line](#)

1 Select Model

w" x d" x h"
21" Height Case
60 x 22 x 28
14" Height Case
60 x 22 x 21
7" Height Case
60 x 22 x 14

Weight	Standard Veneer Chassis Solid Wood Legs		Premium Veneer Chassis Solid Wood Legs		High Pressure Laminate Chassis Solid Wood Legs		Thermally Fused Laminate Chassis Solid Wood Legs	
	Model	Weight	Model	Weight	Model	Weight	Model	Weight

CHM6028CA460W	4044	CHM6028CA460P	4442	CHM6028CA460G	3843	CHM6028CA460M	2867
CHM6021CA460W	3701	CHM6021CA460P	4066	CHM6021CA460G	3516	CHM6021CA460M	2622
CHM6014CA460W	2867	CHM6014CA460P	3151	CHM6014CA460G	2725	CHM6014CA460M	2033

Product Features

- 4" cavity for wire management
- One Adjustable Shelf behind each door.(On 28" Height Only)
- Solid Wood Legs, Field installed.
- Dividers and shelves are finished to match case

Notes

- Unit designed for open plan use.

Options

Top Grommets(Over Belt Line Cavity Wire Management)

- Specify Color and Left/Right/Center- \$50 ea.
- Black: TM30-R(Right), TM30-L(Left), TM30-C(Center)
 - Silver: TM31-R(Right),TM31-L(Left),TM31-C(Center)
 - White: TM34-R(Right),TM34-L(Left),TM34-C(Center)

Grommets (For Ganging)

- Vertical sleeve grommet, template provided for field installation
- TM60: Vertical Grommet Sleeve - \$50

Ganging Option(Use this option when ganging more than 2 units)

- DL60- Deduct 4 Legs - \$350 (On 14" Height Only)

Cushion

- BC30: Bench Cushion - \$354 com
- Specify fabric grade (1 yd. required) Recommended on 14" credenza to achieve 17" Seat Height

BC30 Cushion fabric grades.

COM	COL	1	2	3
354	373	426	444	462
4	5	6	7	8
480	498	516	534	552
9	10	11/ L1	12	13/ L2
570	588	606	624	660

2 Select Finish

[Click to view finishes](#)

Case Finishes	Leg Finishes
WNF	PO02 WOW PO09
WSF	PO03 WNO
WWP	PO07 WSO
WEC	PO08 WLA
PM01	PO09 WWP
PM02	WEC
PM03	PO01
PM07	PO02
PM08	PO03
PM10	PO07
PO01	PO08

Case Finishes	Leg Finishes
WOW	WOW PO08
WNO	WNO PO09
WSO	WSO
WLA	WLA
	WWP
	WEC
	PO01
	PO02
	PO03
	PO07

Case Finishes	Leg Finishes
GWL LW05	WWP
GEC LW06	WOW
LP01	WLA
LF02	WNO
LF03	WSO
LN01	WEC
LA02	PO01
LW01	PO02
LW02	PO03
LW04	PO07
	PO08
	PO09

Case Finishes	Leg Finishes
MAC	WOW PO08
MEC	WNO PO09
MOC	WSO
MGW	WLA
MNA	WWP
MSW	WEC
MTW	PO01
MWL	PO02
	PO03
	PO07

3 Select Edge

[Click to view edges](#)

Edge
N/A

Edge
N/A

Edge
N/A

Edge
N/A

4 Select Hardware

[Click to view details](#)

Push to Open Standard:
Optional Hardward Below
N/A on Sliding Door

Push to Open Standard:
Optional Hardward Below
N/A on Sliding Door

Push to Open Standard:
Optional Hardward Below
N/A on Sliding Door

Push to Open Standard:
Optional Hardward Below
N/A on Sliding Door



Chameleon

Freestanding Credenza Sliding Door Storage x2

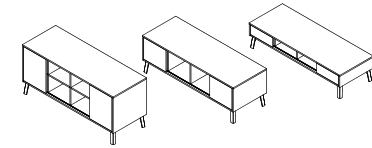

[Click here to view statement of line](#)

1 Select Model

w" x d" x h"
21" Height Case
60 x 22 x 28
14" Height Case
60 x 22 x 21
7" Height Case
60 x 22 x 14

Weight

Standard Veneer Chassis Solid Wood Legs	Premium Veneer Chassis Solid Wood Legs	High Pressure Laminate Chassis Solid Wood Legs	Thermally Fused Laminate Chassis Solid Wood Legs
--	---	---	---

CHM6028CA461W 4044	CHM6028CA461P 4442	CHM6028CA461G 3843	CHM6028CA461M 2867
CHM6021CA461W 3701	CHM6021CA461P 4066	CHM6021CA461G 3516	CHM6021CA461M 2622
CHM6014CA461W 2965	CHM6014CA461P 3260	CHM6014CA461G 2818	CHM6014CA461M 2104

Product Features

- 4" cavity for wire management
- One Adjustable Shelf behind each door.(On 28" Height Only)
- Solid Wood Legs, Field installed.
- Dividers and shelves are finished to match case

Notes

- Unit designed for open plan use.

Options

Top Grommets(Over Belt Line Cavity Wire Management)

- Specify Color and Left/Right/Center- \$50 ea.
- Black: TM30-R(Right), TM30-L(Left), TM30-C(Center)
 - Silver: TM31-R(Right),TM31-L(Left),TM31-C(Center)
 - White: TM34-R(Right),TM34-L(Left),TM34-C(Center)

Grommets (For Ganging)

- Vertical sleeve grommet, template provided for field installation
- TM60: Vertical Grommet Sleeve - \$50

Ganging Option(Use this option when ganging more than 2 units)

- DL60- Deduct 4 Legs - \$350 (On 14" Height Only)

Cushion

- BC30: Bench Cushion - \$354 com
- Specify fabric grade (1 yd. required) Recommended on 14" credenza to achieve 17" Seat Height

BC30 Cushion fabric grades.

COM	COL	1	2	3
354	373	426	444	462
4	5	6	7	8
480	498	516	534	552
9	10	11/ L1	12	13/ L2
570	588	606	624	660

2 Select Finish

[Click to view finishes](#)

Case Finishes	Leg Finishes
WNF	PO02 WOW PO09
WSF	PO03 WNO
WWP	PO07 WSO
WEC	PO08 WLA
PM01	PO09 WWP
PM02	WEC
PM03	PO01
PM07	PO02
PM08	PO03
PM10	PO07
PO01	PO08

Case Finishes	Leg Finishes
WOW	WOW PO08
WNO	WNO PO09
WSO	WLA
WLA	WLA
	WWP
	WEC
	PO01
	PO02
	PO03
	PO07

Case Finishes	Leg Finishes
GWL LW05	WWP
GEC LW06	WOW
LP01	WLA
LF02	WNO
LF03	WSO
LN01	WEC
LA02	PO01
LW01	PO02
LW02	PO03
LW04	PO07
	PO08
	PO09

Case Finishes	Leg Finishes
MAC	WOW PO08
MEC	WNO PO09
MOC	WSO
MGW	WLA
MNA	WWP
MSW	WEC
MTW	PO01
MWL	PO02
	PO03
	PO07

3 Select Edge

[Click to view edges](#)

Edge
N/A

Edge
N/A

Edge
N/A

Edge
N/A

4 Select Hardware

[Click to view details](#)

Push to Open Standard:
Optional Hardward Below
N/A on Sliding Door

Push to Open Standard:
Optional Hardward Below
N/A on Sliding Door

Push to Open Standard:
Optional Hardward Below
N/A on Sliding Door

Push to Open Standard:
Optional Hardward Below
N/A on Sliding Door



Chameleon

Freestanding Credenza
Box Lateral/Door/Open/Sliding Door

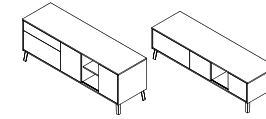

[Click here to view statement of line](#)

1 Select Model

w" x d" x h"

Weight

	Standard Veneer Chassis Solid Wood Legs	Premium Veneer Chassis Solid Wood Legs	High Pressure Laminate Chassis Solid Wood Legs	Thermally Fused Laminate Chassis Solid Wood Legs
Box Lateral/Door Storage/Open/Sliding Door 75 x 22 x 28	CHM7528CA462W 4933	CHM7528CA462P 5423	CHM7528CA462G 4687	CHM7528CA462M 3499
Lateral/Door Storage/Open/Sliding Door 75 x 22 x 21	CHM7521CA462W 4251	CHM7521CA462P 4671	CHM7521CA462G 4039	CHM7521CA462M 3014

Product Features

- 4" cavity for wire management
- One Adjustable Shelf behind each door.(On 28" Height Only)
- Solid Wood Legs, Field installed.
- Dividers and shelves are finished to match case

Notes

- Unit designed for open plan use.

Options

Top Grommets(Over Belt Line Cavity Wire Management)

- Specify Color and Left/Right/Center- \$50 ea.
- Black: TM30-R(Right), TM30-L(Left), TM30-C(Center)
 - Silver: TM31-R(Right),TM31-L(Left),TM31-C(Center)
 - White: TM34-R(Right),TM34-L(Left),TM34-C(Center)

Grommets (For Ganging)

- Vertical sleeve grommet, template provided for field installation
- TM60: Vertical Grommet Sleeve - \$50

Door lock

- D2: Door/ Lock (locks 1 door or 1 pedestal) - \$100 each

2 Select Finish

[Click to view finishes](#)

Case Finishes	Leg Finishes
WNF	PO02 WOW PO09
WSF	PO03 WNO
WWP	PO07 WSO
WEC	PO08 WLA
PM01	PO09 WWP
PM02	WEC
PM03	PO01
PM07	PO02
PM08	PO03
PM10	PO07
PO01	PO08

Case Finishes	Leg Finishes
WOW	WOW PO08
WNO	WNO PO09
WSO	WLA
WLA	WLA
	WWP
	WEC
	PO01
	PO02
	PO03
	PO07

Case Finishes	Leg Finishes
GWL LW05	WWP
GEC LW06	WOW
LP01	WLA
LF02	WNO
LF03	WSO
LN01	WEC
LA02	PO01
LW01	PO02
LW02	PO03
LW04	PO07
	PO08
	PO09

Case Finishes	Leg Finishes
MAC	WOW PO08
MEC	WNO PO09
MOC	WSO
MGW	WLA
MNA	WWP
MSW	WEC
MTW	PO01
MWL	PO02
	PO03
	PO07

3 Select Edge

[Click to view edges](#)

Edge
N/A

Edge
N/A

Edge
N/A

Edge
N/A

4 Select Hardware

[Click to view details](#)

Push to Open Standard:
Optional Hardward Below
N/A on Sliding Door

Push to Open Standard:
Optional Hardward Below
N/A on Sliding Door

Push to Open Standard:
Optional Hardward Below
N/A on Sliding Door

Push to Open Standard:
Optional Hardward Below
N/A on Sliding Door



Chameleon

Freestanding Credenza
Sliding Door/Open/Door/Box Lateral

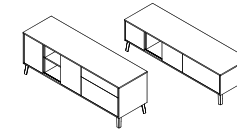

[Click here to view statement of line](#)

1 Select Model

w" x d" x h"

Weight

	Standard Veneer Top Solid Wood Legs	Premium Veneer Chassis Solid Wood Legs	High Pressure Laminate Top Solid Wood Legs	Thermally Fused Laminate Chassis Solid Wood Legs
Sliding Door/Open/Door/Box Lateral 75 x 22 x 28	CHM7528CA463W 4933	CHM7528CA463P 5423	CHM7528CA463G 4687	CHM7528CA463M 3499
Sliding Door/Open/Door/Lateral 75 x 22 x 21	CHM7521CA463W 4251	CHM7521CA463P 4671	CHM7521CA463G 4039	CHM7521CA463M 3014

Product Features

- 4" cavity for wire management
- One Adjustable Shelf behind each door.(On 28" Height Only)
- Solid Wood Legs, Field installed.
- Dividers and shelves are finished to match case

Notes

- Unit designed for open plan use.

Options

Top Grommets(Over Belt Line Cavity Wire Management)

Specify Color and Left/Right/Center- \$50 ea.

- Black: TM30-R(Right), TM30-L(Left), TM30-C(Center)
- Silver: TM31-R(Right),TM31-L(Left),TM31-C(Center)
- White: TM34-R(Right),TM34-L(Left),TM34-C(Center)

Grommets (For Ganging)

Vertical sleeve grommet, template provided for field installation

- TM60: Vertical Grommet Sleeve - \$50

Door Lock

- D2: Door/ Lock (locks 1 door or 1 pedestal) - \$100 each

2 Select Finish

[Click to view finishes](#)

Case Finishes	Leg Finishes
WNF	PO02 WOW PO09
WSF	PO03 WNO
WWP	PO07 WSO
WEC	PO08 WLA
PM01	PO09 WWP
PM02	WEC
PM03	PO01
PM07	PO02
PM08	PO03
PM10	PO07
PO01	PO08

Case Finishes	Leg Finishes
WOW	WOW PO08
WNO	WNO PO09
WSO	WLA
WLA	WLA
	WWP
	WEC
	PO01
	PO02
	PO03
	PO07

Case Finishes	Leg Finishes
GWL LW05	WWP
GEC LW06	WOW
LP01	WLA
LF02	WNO
LF03	WSO
LN01	WEC
LA02	PO01
LW01	PO02
LW02	PO03
LW04	PO07
	PO08
	PO09

Case Finishes	Leg Finishes
MAC	WOW PO08
MEC	WNO PO09
MOC	WSO
MGW	WLA
MNA	WWP
MSW	WEC
MTW	PO01
MWL	PO02
	PO03
	PO07

3 Select Edge

[Click to view edges](#)

Edge
N/A

Edge
N/A

Edge
N/A

Edge
N/A

4 Select Hardware

[Click to view details](#)

Push to Open Standard:
Optional Hardward Below
N/A on Sliding Door

Push to Open Standard:
Optional Hardward Below
N/A on Sliding Door

Push to Open Standard:
Optional Hardward Below
N/A on Sliding Door

Push to Open Standard:
Optional Hardward Below
N/A on Sliding Door



Chameleon

Freestanding Credenza
Box Drawer/ Sliding Door

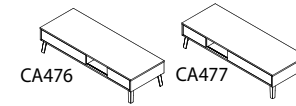

[Click here to view statement of line](#)

1 Select Model

w" x d" x h"
Box Drawer/Sliding Door
60 x 22 x 14
Sliding Door/Box Drawer
60 x 22 x 14

Weight

Standard Veneer Top Solid Wood Legs	Premium Veneer Chassis Solid Wood Legs	High Pressure Laminate Top Solid Wood Legs	Thermally Fused Laminate Chassis Solid Wood Legs
--	---	---	---

CHM6014CA476W 3129	CHM6014CA476P 3439	CHM6014CA476G 2971	CHM6014CA476M 2219
CHM6014CA477W 3129	CHM6014CA477P 3439	CHM6014CA477G 2971	CHM6014CA477M 2219

Product Features

- 4" cavity for wire management
- Solid Wood Legs, Field installed.
- Dividers and shelves are finished to match case

Notes

- Unit designed for open plan use.

Options

Top Grommets(Over Belt Line Cavity Wire Management)

- Specify Color and Left/Right/Center- \$50 ea.
- Black: TM30-R(Right), TM30-L(Left), TM30-C(Center)
 - Silver: TM31-R(Right),TM31-L(Left),TM31-C(Center)
 - White: TM34-R(Right),TM34-L(Left),TM34-C(Center)

Grommets (For Ganging)

- Vertical sleeve grommet, template provided for field installation
- TM60: Vertical Grommet Sleeve - \$50

Door Lock

- D2: Door/ Lock (locks 1 door or 1 pedestal) - \$100 each

Ganging Option(Use this option when ganging more than 2 units)

- DL60- Deduct 4 Legs - \$350 (On 14" Height Only)

Cushion

- BC30: Bench Cushion - \$354 com
- Specify fabric grade (1 yd. required) Recommended on 14" credenza to achieve 17" Seat Height

BC30 Cushion fabric grades.

COM	COL	1	2	3
354	373	426	444	462
4	5	6	7	8
480	498	516	534	552
9	10	11/ L1	12	13/ L2
570	588	606	624	660

2 Select Finish

[Click to view finishes](#)

Case Finishes	Leg Finishes
WNF	PO02 WOW PO09
WSF	PO03 WNO
WWP	PO07 WSO
WEC	PO08 WLA
PM01	PO09 WWP
PM02	WEC
PM03	PO01
PM07	PO02
PM08	PO03
PM10	PO07
PO01	PO08

Case Finishes	Leg Finishes
WOW	WOW PO08
WNO	WNO PO09
WSO	WLA
WLA	WLA
	WWP
	WEC
	PO01
	PO02
	PO03
	PO07

Case Finishes	Leg Finishes
GWL LW05	WWP
GEC LW06	WOW
LP01	WLA
LF02	WNO
LF03	WSO
LN01	WEC
LA02	PO01
LW01	PO02
LW02	PO03
LW04	PO07
	PO08
	PO09

Case Finishes	Leg Finishes
MAC	WOW PO08
MEC	WNO PO09
MOC	WSO
MGW	WLA
MNA	WWP
MSW	WEC
MTW	PO01
MWL	PO02
	PO03
	PO07

3 Select Edge

[Click to view edges](#)

Edge
N/A

Edge
N/A

Edge
N/A

Edge
N/A

4 Select Hardware

[Click to view details](#)

Push to Open Standard:
Optional Hardward Below
N/A on Sliding Door

Push to Open Standard:
Optional Hardward Below
N/A on Sliding Door

Push to Open Standard:
Optional Hardward Below
N/A on Sliding Door

Push to Open Standard:
Optional Hardward Below
N/A on Sliding Door



PL - 406 Gloss White
PL - 407 Matte Chrome
PL - 506 Gloss White
PL - 507 Matte Chrome



PL - 406 Gloss White
PL - 407 Matte Chrome
PL - 506 Gloss White
PL - 507 Matte Chrome



PL - 406 Gloss White
PL - 407 Matte Chrome
PL - 506 Gloss White
PL - 507 Matte Chrome



PL - 406 Gloss White
PL - 407 Matte Chrome
PL - 506 Gloss White
PL - 507 Matte Chrome

Chameleon

Freestanding Credenza
Box Lateral/Open/ Sliding Door

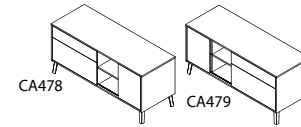

[Click here to view statement of line](#)

1 Select Model

w" x d" x h"
Box Lateral/Sliding Door
60 x 22 x 28
Sliding Door/ Box Lateral
60 x 22 x 28

Weight

Standard Veneer Top Solid Wood Legs	Premium Veneer Chassis Solid Wood Legs	High Pressure Laminate Top Solid Wood Legs	Thermally Fused Laminate Chassis Solid Wood Legs
--	---	---	---

CHM6028CA478W 4513	CHM6028CA478P 4960	CHM6028CA478G 4290	CHM6028CA478M 3200
CHM6028CA479W 4513	CHM6028CA479P 4960	CHM6028CA479G 4290	CHM6028CA479M 3200

Product Features

- 4" cavity for wire management
- One Adjustable Shelf behind each door.
- Solid Wood Legs, Field installed.
- Dividers and shelves are finished to match case

Notes

- Unit designed for open plan use.

Options

Top Grommets(Over Belt Line Cavity Wire Management)

- Specify Color and Left/Right/Center- \$50 ea.
- Black: TM30-R(Right), TM30-L(Left), TM30-C(Center)
 - Silver: TM31-R(Right),TM31-L(Left),TM31-C(Center)
 - White: TM34-R(Right),TM34-L(Left),TM34-C(Center)

Grommets (For Ganging)

- Vertical sleeve grommet, template provided for field installation
- TM60: Vertical Grommet Sleeve - \$50

Door Lock

- D2: Door/ Lock (locks 1 door or 1 pedestal) - \$100 each

2 Select Finish

[Click to view finishes](#)

Case Finishes	Leg Finishes
WNF	PO02 WOW PO09
WSF	PO03 WNO
WWP	PO07 WSO
WEC	PO08 WLA
PM01	PO09 WWP
PM02	WEC
PM03	PO01
PM07	PO02
PM08	PO03
PM10	PO07
PO01	PO08

Case Finishes	Leg Finishes
WOW	WOW PO08
WNO	WNO PO09
WSO	WLA
WLA	WLA
	WWP
	WEC
	PO01
	PO02
	PO03
	PO07

Case Finishes	Leg Finishes
GWL LW05	WWP
GEC LW06	WOW
LP01	WLA
LF02	WNO
LF03	WSO
LN01	WEC
LA02	PO01
LW01	PO02
LW02	PO03
LW04	PO07
	PO08
	PO09

Case Finishes	Leg Finishes
MAC	WOW PO08
MEC	WNO PO09
MOC	WSO
MGW	WLA
MNA	WWP
MSW	WEC
MTW	PO01
MWL	PO02
	PO03
	PO07

3 Select Edge

[Click to view edges](#)

Edge
N/A

Edge
N/A

Edge
N/A

Edge
N/A

4 Select Hardware

[Click to view details](#)

Push to Open Standard:
Optional Hardward Below
N/A on Sliding Door

Push to Open Standard:
Optional Hardward Below
N/A on Sliding Door

Push to Open Standard:
Optional Hardward Below
N/A on Sliding Door

Push to Open Standard:
Optional Hardward Below
N/A on Sliding Door



Chameleon

Freestanding Credenza
Lateral File/Sliding Door

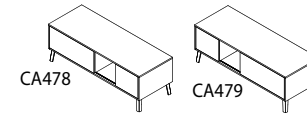

[Click here to view statement of line](#)

1 Select Model

w" x d" x h"
Lateral File/Sliding Door
60 x 22 x 21
Sliding Door/Lateral File
60 x 22 x 21

Weight

Standard Veneer Top Solid Wood Legs	Premium Veneer Chassis Solid Wood Legs	High Pressure Laminate Top Solid Wood Legs	Thermally Fused Laminate Chassis Solid Wood Legs
--	---	---	---

CHM6021CA478W 3974	CHM6021CA478P 4366	CHM6021CA478G 3777	CHM6021CA478M 2818
CHM6021CA479W 3974	CHM6021CA479P 4366	CHM6021CA479G 3777	CHM6021CA479M 2818

Product Features

- 4" cavity for wire management
- Solid Wood Legs, Field installed.
- Dividers and shelves are finished to match case

Notes

- Unit designed for open plan use.

Options

Top Grommets(Over Belt Line Cavity Wire Management)

- Specify Color and Left/Right/Center- \$50 ea.
- Black: TM30-R(Right), TM30-L(Left), TM30-C(Center)
 - Silver: TM31-R(Right),TM31-L(Left),TM31-C(Center)
 - White: TM34-R(Right),TM34-L(Left),TM34-C(Center)

Grommets (For Ganging)

- Vertical sleeve grommet, template provided for field installation
- TM60: Vertical Grommet Sleeve - \$50

Door Lock

- D2: Door/ Lock (locks 1 door or 1 pedestal) - \$100 each

2 Select Finish

[Click to view finishes](#)

Case Finishes	Leg Finishes
WNF	PO02 WOW PO09
WSF	PO03 WNO
WWP	PO07 WSO
WEC	PO08 WLA
PM01	PO09 WWP
PM02	WEC
PM03	PO01
PM07	PO02
PM08	PO03
PM10	PO07
PO01	PO08

Case Finishes	Leg Finishes
WOW	WOW PO08
WNO	WNO PO09
WSO	WLA
WLA	WLA
	WWP
	WEC
	PO01
	PO02
	PO03
	PO07

Case Finishes	Leg Finishes
GWL LW05	WWP
GEC LW06	WOW
LP01	WLA
LF02	WNO
LF03	WSO
LN01	WEC
LA02	PO01
LW01	PO02
LW02	PO03
LW04	PO07
	PO08
	PO09

Case Finishes	Leg Finishes
MAC	WOW PO08
MEC	WNO PO09
MOC	WSO
MGW	WLA
MNA	WWP
MSW	WEC
MTW	PO01
MWL	PO02
	PO03
	PO07

3 Select Edge

[Click to view edges](#)

Edge
N/A

Edge
N/A

Edge
N/A

Edge
N/A

4 Select Hardware

[Click to view details](#)

Push to Open Standard:
Optional Hardward Below
N/A on Sliding Door

Push to Open Standard:
Optional Hardward Below
N/A on Sliding Door

Push to Open Standard:
Optional Hardward Below
N/A on Sliding Door

Push to Open Standard:
Optional Hardward Below
N/A on Sliding Door



Chameleon

Freestanding Credenza
Box Lateral/Open/Box Lateral

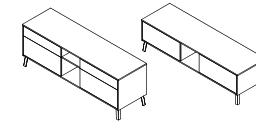

[Click here to view statement of line](#)

1 Select Model

w" x d" x h"
Box Lateral/Open/Box Lateral
75 x 22 x 28
Lateral File/Open/Lateral File
75 x 22 x 21

Weight

Standard Veneer Top Solid Wood Legs	Premium Veneer Chassis Solid Wood Legs	High Pressure Laminate Top Solid Wood Legs	Thermally Fused Laminate Chassis Solid Wood Legs
--	---	---	---

CHM7528CA480W 5091	CHM7528CA480P 5592	CHM7528CA480G 4435	CHM7528CA480G 3608
CHM7521CA480W 4366	CHM7521CA480P 4796	CHM7521CA480G 4148	CHM7521CA480M 3096

Product Features

- 4" cavity for wire management
- One Adjustable Shelf behind each door.(On 28" Height Only)
- Solid Wood Legs, Field installed.
- Dividers and shelves are finished to match case

Notes

- Unit designed for open plan use.

Options

Top Grommets(Over Belt Line Cavity Wire Management)

- Specify Color and Left/Right/Center- \$50 ea.
- Black: TM30-R(Right), TM30-L(Left), TM30-C(Center)
 - Silver: TM31-R(Right),TM31-L(Left),TM31-C(Center)
 - White: TM34-R(Right),TM34-L(Left),TM34-C(Center)

Grommets (For Ganging)

- Vertical sleeve grommet, template provided for field installation
- TM60: Vertical Grommet Sleeve - \$50

Door Lock

- D2: Door/ Lock (locks 1 door or 1 pedestal) - \$100 each

2 Select Finish

[Click to view finishes](#)

Case Finishes	Leg Finishes
WNF	PO02 WOW PO09
WSF	PO03 WNO
WWP	PO07 WSO
WEC	PO08 WLA
PM01	PO09 WWP
PM02	WEC
PM03	PO01
PM07	PO02
PM08	PO03
PM10	PO07
PO01	PO08

Case Finishes	Leg Finishes
WOW	WOW PO08
WNO	WNO PO09
WSO	WSO
WLA	WLA
	WWP
	WEC
	PO01
	PO02
	PO03
	PO07

Case Finishes	Leg Finishes
GWL LW05	WWP
GEC LW06	WOW
LP01	WLA
LF02	WNO
LF03	WSO
LN01	WEC
LA02	PO01
LW01	PO02
LW02	PO03
LW04	PO07
	PO08
	PO09

Case Finishes	Leg Finishes
MAC	WOW PO08
MEC	WNO PO09
MOC	WSO
MGW	WLA
MNA	WWP
MSW	WEC
MTW	PO01
MWL	PO02
	PO03
	PO07

3 Select Edge

[Click to view edges](#)

Edge
N/A

Edge
N/A

Edge
N/A

Edge
N/A

4 Select Hardware

[Click to view details](#)

Push to Open Standard:
Optional Hardware Below

Push to Open Standard:
Optional Hardware Below

Push to Open Standard:
Optional Hardware Below

Push to Open Standard:
Optional Hardware Below



Chameleon

Freestanding Screen
Box Lateral/Open Storage

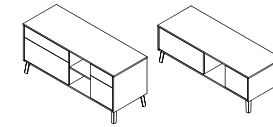

[Click here to view statement of line](#)

1 Select Model

w" x d" x h"
Box Lateral/Open/Box/File
60 x 22 x 28
Lateral File/Open/File
60 x 22 x 21

Weight

Standard Veneer Top Solid Wood Legs	Premium Veneer Chassis Solid Wood Legs	High Pressure Laminate Top Solid Wood Legs	Thermally Fused Laminate Chassis Solid Wood Legs
--	---	---	---

CHM6028CA481W 4600	CHM6028CA481P 5058	CHM6028CA481G 4371	CHM6028CA481M 3265
CHM6021CA481W 4039	CHM6021CA481P 4437	CHM6021CA481G 3837	CHM6021CA481M 2862

Product Features

- 4" cavity for wire management
- One Adjustable Shelf behind each door.(On 28" Height Only)
- Solid Wood Legs, Field installed.
- Dividers and shelves are finished to match case

Notes

- Unit designed for open plan use.

Options

Top Grommets(Over Belt Line Cavity Wire Management)

- Specify Color and Left/Right/Center- \$50 ea.
- Black: TM30-R(Right), TM30-L(Left), TM30-C(Center)
 - Silver: TM31-R(Right),TM31-L(Left),TM31-C(Center)
 - White: TM34-R(Right),TM34-L(Left),TM34-C(Center)

Grommets (For Ganging)

- Vertical sleeve grommet, template provided for field installation
- TM60: Vertical Grommet Sleeve - \$50

Door Lock

- D2: Door/ Lock (locks 1 door or 1 pedestal) - \$100 each

2 Select Finish

[Click to view finishes](#)

Case Finishes	Leg Finishes
WNF	PO02 WOW PO09
WSF	PO03 WNO
WWP	PO07 WSO
WEC	PO08 WLA
PM01	PO09 WWP
PM02	WEC
PM03	PO01
PM07	PO02
PM08	PO03
PM10	PO07
PO01	PO08

Case Finishes	Leg Finishes
WOW	WOW PO08
WNO	WNO PO09
WSO	WSO
WLA	WLA
	WWP
	WEC
	PO01
	PO02
	PO03
	PO07

Case Finishes	Leg Finishes
GWL LW05	WWP
GEC LW06	WOW
LP02	WLA
LF02	WNO
LF03	WSO
LN02	WEC
LA03	PO01
LW01	PO02
LW02	PO03
LW04	PO07
	PO08
	PO09

Case Finishes	Leg Finishes
MAC	WOW PO08
MEC	WNO PO09
MOC	WSO
MGW	WLA
MNA	WWP
MSW	WEC
MTW	PO01
MWL	PO02
	PO03
	PO07

3 Select Edge

[Click to view edges](#)

Edge
N/A

Edge
N/A

Edge
N/A

Edge
N/A

4 Select Hardware

[Click to view details](#)

Push to Open Standard:
Optional Hardware Below

Push to Open Standard:
Optional Hardware Below

Push to Open Standard:
Optional Hardware Below

Push to Open Standard:
Optional Hardware Below



Chameleon

Freestanding
Box Lateral/Open Storage

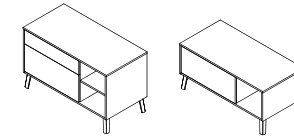

[Click here to view statement of line](#)

1 Select Model

w" x d" x h"
Box Lateral/Open Storage
45 x 22 x 28
Lateral File/Open Storage
45 x 22 x 21

Weight

Standard Veneer Top Solid Wood Legs	Premium Veneer Chassis Solid Wood Legs	High Pressure Laminate Top Solid Wood Legs	Thermally Fused Laminate Chassis Solid Wood Legs
--	---	---	---

CHM4528CA482W 4104	CHM4528CA482P 4513	CHM4528CA482G 3897	CHM4528CA482M 2911
CHM4521CA482W 3647	CHM4521CA482P 4006	CHM4521CA482G 3467	CHM4521CA482M 2584

Product Features

- 4" cavity for wire management
- One Adjustable Shelf behind each door.(On 28" Height Only)
- Solid Wood Legs, Field installed.
- Dividers and shelves are finished to match case

Notes

- Unit designed for open plan use.

Options

Top Grommets(Over Belt Line Cavity Wire Management)

- Specify Color and Left/Right/Center- \$50 ea.
- Black: TM30-R(Right), TM30-L(Left), TM30-C(Center)
 - Silver: TM31-R(Right),TM31-L(Left),TM31-C(Center)
 - White: TM34-R(Right),TM34-L(Left),TM34-C(Center)

Grommets (For Ganging)

- Vertical sleeve grommet, template provided for field installation
- TM60: Vertical Grommet Sleeve - \$50

Door Lock

- D2: Door/ Lock (locks 1 door or 1 pedestal) - \$100 each

2 Select Finish

[Click to view finishes](#)

Case Finishes	Leg Finishes
WNF	PO02 WOW PO09
WSF	PO03 WNO
WWP	PO07 WSO
WEC	PO08 WLA
PM01	PO09 WWP
PM02	WEC
PM03	PO01
PM07	PO02
PM08	PO03
PM10	PO07
PO01	PO08

Case Finishes	Leg Finishes
WOW	WOW PO08
WNO	WNO PO09
WSO	WLA
WLA	WLA
	WWP
	WEC
	PO01
	PO02
	PO03
	PO07

Case Finishes	Leg Finishes
GWL LW05	WWP
GEC LW06	WOW
LP03	WLA
LF02	WNO
LF03	WSO
LN03	WEC
LA04	PO01
LW01	PO02
LW02	PO03
LW04	PO07
	PO08
	PO09

Case Finishes	Leg Finishes
MAC	WOW PO08
MEC	WNO PO09
MOC	WSO
MGW	WLA
MNA	WWP
MSW	WEC
MTW	PO01
MWL	PO02
	PO03
	PO07

3 Select Edge

[Click to view edges](#)

Edge
N/A

Edge
N/A

Edge
N/A

Edge
N/A

4 Select Hardware

[Click to view details](#)

Push to Open Standard:
Optional Hardware Below

Push to Open Standard:
Optional Hardware Below

Push to Open Standard:
Optional Hardware Below

Push to Open Standard:
Optional Hardware Below



Chameleon

Freestanding
30" Open Credenza

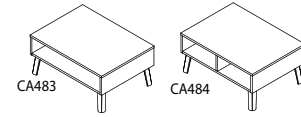

[Click here to view statement of line](#)

1 Select Model

w" x d" x h"
1 Section No Partition
30 x 22 x 14
30" Wide 2 Section w/Partition
30 x 22 x 14

Weight

Standard Veneer Top Solid Wood Legs	Premium Veneer Chassis Solid Wood Legs	High Pressure Laminate Top Solid Wood Legs	Thermally Fused Laminate Chassis Solid Wood Legs
--	---	---	---

CHM3014CA483W 2055	CHM3014CA483P 2257	CHM3014CA483G 1952	CHM3014CA483M 1456
CHM3014CA484W 2093	CHM3014CA484P 2300	CHM3014CA484G 1990	CHM3014CA484M 1483

Product Features

- 4" cavity for wire management
- Solid Wood Legs, Field installed.

Notes

- Unit designed for open plan use.

Options

Top Grommets(Over Belt Line Cavity Wire Management)

- Specify Color and Left/Right/Center- \$50 ea.
- Black: TM30-R(Right), TM30-L(Left), TM30-C(Center)
 - Silver: TM31-R(Right),TM31-L(Left),TM31-C(Center)
 - White: TM34-R(Right),TM34-L(Left),TM34-C(Center)

Grommets (For Ganging)

- Vertical sleeve grommet, template provided for field installation
- TM60: Vertical Grommet Sleeve - \$50

Ganging Option(Use this option when ganging more than 2 units)

- DL60- Deduct 4 Legs - \$350 (On 14" Height Only)

Cushion

- BC30: Bench Cushion - \$354 com
- Specify fabric grade (1 yd. required) Recommended on 14" credenza to achieve 17" Seat Height

BC30 Cushion fabric grades.

COM	COL	1	2	3
354	373	426	444	462
4	5	6	7	8
480	498	516	534	552
9	10	11/ L1	12	13/ L2
570	588	606	624	660

2 Select Finish

[Click to view finishes](#)

Case Finishes	Leg Finishes
WNF	PO02 WOW PO09
WSF	PO03 WNO
WWP	PO07 WSO
WEC	PO08 WLA
PM01	PO09 WWP
PM02	WEC
PM03	PO01
PM07	PO02
PM08	PO03
PM10	PO07
PO01	PO08

Case Finishes	Leg Finishes
WOW	PO08
WNO	PO09
WSO	
WLA	

Case Finishes	Leg Finishes
GWL LW05	WWP
GEC LW06	WOW
LP03	WLA
LF02	WNO
LF03	WSO
LN03	WEC
LA04	PO01
LW01	PO02
LW02	PO03
LW04	PO07
	PO08
	PO09

Case Finishes	Leg Finishes
MAC	WOW PO08
MEC	WNO PO09
MOC	WSO
MGW	WLA
MNA	WWP
MSW	WEC
MTW	PO01
MWL	PO02
	PO03
	PO07

3 Select Edge

[Click to view edges](#)

Edge
N/A

Edge
N/A

Edge
N/A

Edge
N/A

4 Select Hardware

[Click to view details](#)

Push to Open Standard:
Optional Hardware Below

Push to Open Standard:
Optional Hardware Below

Push to Open Standard:
Optional Hardware Below

Push to Open Standard:
Optional Hardware Below



PL - 406 Gloss White
PL - 407 Matte Chrome
PL - 506 Gloss White
PL - 507 Matte Chrome



PL - 406 Gloss White
PL - 407 Matte Chrome
PL - 506 Gloss White
PL - 507 Matte Chrome



PL - 406 Gloss White
PL - 407 Matte Chrome
PL - 506 Gloss White
PL - 507 Matte Chrome



PL - 406 Gloss White
PL - 407 Matte Chrome
PL - 506 Gloss White
PL - 507 Matte Chrome

Chameleon

Freestanding

30" Drop Door/Sliding Door/Box Drawer

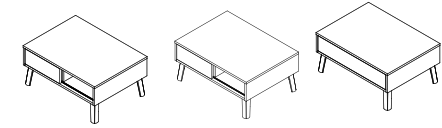

[Click here to view statement of line](#)

1 Select Model

w" x d" x h"
 1 Section w/Drop Door
 30 x 22 x 14
 30" Wide 2 Section Sliding Door
 30 x 22 x 14
 30" Wide Unit w/Box Drawer
 30 x 22 x 14

Weight

Standard Veneer Chassis Solid Wood Legs	Premium Veneer Chassis Solid Wood Legs	High Pressure Laminate Chassis Solid Wood Legs	Thermally Fused Laminate Chassis Solid Wood Legs
--	---	---	---

CHM3014CA485W 2557	CHM3014CA485P 2807	CHM3014CA485G 2431	CHM3014CA485M 1810
CHM3014CA486W 2279	CHM3014CA486P 2502	CHM3014CA486G 2164	CHM3014CA486M 1614
CHM3014CA488W 2317	CHM3014CA488P 2546	CHM3014CA488G 2202	CHM3014CA488M 1641

Product Features

- 4" cavity for wire management
- Solid Wood Legs, Field installed.

Notes

- Unit designed for open plan use.

Options

Top Grommets(Over Belt Line Cavity Wire Management)

- Specify Color and Left/Right/Center- \$50 ea.
- Black: TM30-R(Right), TM30-L(Left), TM30-C(Center)
- Silver: TM31-R(Right),TM31-L(Left),TM31-C(Center)
- White: TM34-R(Right),TM34-L(Left),TM34-C(Center)

Grommets (For Ganging)

- Vertical sleeve grommet, template provided for field installation
- TM60: Vertical Grommet Sleeve - \$50

Door Lock

- D2: Door/ Lock (locks 1 door or 1 pedestal) - \$100 each

Ganging Option(Use this option when ganging more than 2 units)

- DL60- Deduct 4 Legs - \$350 (On 14" Height Only)

Cushion

- BC30: Bench Cushion - \$354 com
- Specify fabric grade (1 yd. required) Recommended on 14" credenza to achieve 17" Seat Height

BC30 Cushion fabric grades.

COM	COL	1	2	3
354	373	426	444	462
4	5	6	7	8
480	498	516	534	552
9	10	11/ L1	12	13/ L2
570	588	606	624	660

2 Select Finish

[Click to view finishes](#)

Case Finishes	Leg Finishes
WNF	PO02 WOW PO09
WSF	PO03 WNO
WWP	PO07 WSO
WEC	PO08 WLA
PM01	PO09 WWP
PM02	WEC
PM03	PO01
PM07	PO02
PM08	PO03
PM10	PO07
PO01	PO08

Case Finishes	Leg Finishes
WOW	WOW PO08
WNO	WNO PO09
WSO	WLA
WLA	WLA
	WWP
	WEC
	PO01
	PO02
	PO03
	PO07

Case Finishes	Leg Finishes
GWL LW05	WWP
GEC LW06	WOW
LP04	WLA
LF02	WNO
LF03	WSO
LN04	WEC
LA05	PO01
LW01	PO02
LW02	PO03
LW04	PO07
	PO08
	PO09

Case Finishes	Leg Finishes
MAC	WOW PO08
MEC	WNO PO09
MOC	WSO
MGW	WLA
MNA	WWP
MSW	WEC
MTW	PO01
MWL	PO02
	PO03
	PO07

3 Select Edge

[Click to view edges](#)

Edge
N/A

Edge
N/A

Edge
N/A

Edge
N/A

4 Select Hardware

[Click to view details](#)

Push to Open Standard:
Optional Hardward Below
N/A on Sliding Door

Push to Open Standard:
Optional Hardward Below
N/A on Sliding Door

Push to Open Standard:
Optional Hardward Below
N/A on Sliding Door

Push to Open Standard:
Optional Hardward Below
N/A on Sliding Door



Chameleon

Sit-On Door Storage
30"/45"/60" Sit On Storage

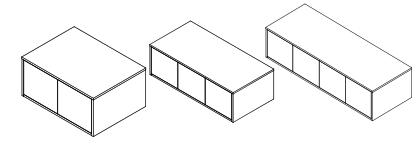

[Click here to view statement of line](#)

1 Select Model

w" x d" x h"
1 Section No Partition
30 x 14 x 14
2 Section w/Partition
45 x 14 x 14
2 Section w/Center Partition
60 x 14 x 14

Weight

Standard Veneer Chassis	Premium Veneer Chassis	High Pressure Laminate Chassis	Thermally Fused Laminate Chassis
-------------------------	------------------------	--------------------------------	----------------------------------

CHM3014SO489W 1325	CHM3014SO489P 1456	CHM3014SO489G 1259	CHM3014SO489M 938
CHM4514SO489W 1635	CHM4514OS489P 1799	CHM4514OS489G 1554	CHM4514OS489M 1161
CHM6014SO489W 1957	CHM6014SO489P 2148	CHM6014SO489G 1859	CHM6014SO489M 1385

Product Features

- Interior Cabinet Depth 13"
- Product ships assembled

Notes

- Unit designed for open plan use.
- Unit is not connected with fasteners unless specified.

Options

Top Grommets(Over Belt Line Cavity Wire Management)

- Specify Color and Left/Right/Center- \$50 ea.
- Black: TM30-R(Right), TM30-L(Left), TM30-C(Center)
- Silver: TM31-R(Right),TM31-L(Left),TM31-C(Center)
- White: TM34-R(Right),TM34-L(Left),TM34-C(Center)

Grommets (For Ganging)

- Vertical sleeve grommet, template provided for field installation
- TM60: Vertical Grommet Sleeve - \$50

Door Lock

- D2: Door/ Lock (locks 1 door or 1 pedestal) - \$100 each

2 Select Finish

[Click to view finishes](#)

Case Finishes

- WNF PO02
- WSF PO03
- WWP PO07
- WEC PO08
- PM01 PO09
- PM02
- PM03
- PM07
- PM08
- PM10
- PO01

Case Finishes

- WOW
- WNO
- WSO
- WLA

Case Finishes

- GWL LW05
- GEC LW06
- LP04
- LF02
- LF03
- LN04
- LA05
- LW01
- LW02
- LW04

Case Finishes

- MAC
- MEC
- MOC
- MGW
- MNA
- MSW
- MTW
- MWL

3 Select Edge

[Click to view edges](#)

Edge
N/A

Edge
N/A

Edge
N/A

Edge
N/A

4 Select Hardware

[Click to view details](#)

Push to Open Standard:
Optional Hardware Below

Push to Open Standard:
Optional Hardware Below

Push to Open Standard:
Optional Hardware Below

Push to Open Standard:
Optional Hardware Below



PL - 406 Gloss White
PL - 407 Matte Chrome
PL - 506 Gloss White
PL - 507 Matte Chrome



PL - 406 Gloss White
PL - 407 Matte Chrome
PL - 506 Gloss White
PL - 507 Matte Chrome



PL - 406 Gloss White
PL - 407 Matte Chrome
PL - 506 Gloss White
PL - 507 Matte Chrome



PL - 406 Gloss White
PL - 407 Matte Chrome
PL - 506 Gloss White
PL - 507 Matte Chrome

Chameleon

Sit-On Door Storage
30"/45"/60" Sit On Sliding Door Cabinet

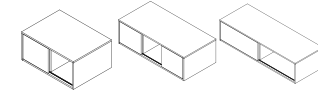

[Click here to view statement of line](#)

1 Select Model

w" x d" x h"
2 Section/1 Door/Center Partition
30 x 14 x 14
3 Section/2 Partitions/2 Doors
45 x 14 x 14
2 Section/1 Door/Center Partition
60 x 14 x 14

Weight

Standard Veneer Chassis	Premium Veneer Chassis	High Pressure Laminate Chassis	Thermally Fused Laminate Chassis
CHM3014SO490W 1412	CHM3014SO490P 1554	CHM3014SO490G 1341	CHM3014SO490M 1003
CHM4514SO490W 1815	CHM4514SO490P 1995	CHM4514SO490G 1723	CHM4514SO490M 1287
CHM6014SO490W 2213	CHM6014SO490P 2431	CHM6014SO490G 2104	CHM6014SO490M 1570

Product Features

- Interior Cabinet Depth 13"
- Product ships assembled

Notes

- Unit designed for open plan use.
- Unit is not connected with fasteners unless specified.

Options

Top Grommets(Over Belt Line Cavity Wire Management)

- Specify Color and Left/Right/Center- \$50 ea.
- Black: TM30-R(Right), TM30-L(Left), TM30-C(Center)
 - Silver: TM31-R(Right),TM31-L(Left),TM31-C(Center)
 - White: TM34-R(Right),TM34-L(Left),TM34-C(Center)

Grommets (For Ganging)

- Vertical sleeve grommet, template provided for field installation
- TM60: Vertical Grommet Sleeve - \$50

2 Select Finish

[Click to view finishes](#)

Case Finishes

WNF PO02
WSF PO03
WWP PO07
WEC PO08
PM01 PO09
PM02
PM03
PM07
PM08
PM10
PO01

Case Finishes

WOW
WNO
WSO
WLA

Case Finishes

GWL LW05
GEC LW06
LP04
LF02
LF03
LN04
LA05
LW01
LW02
LW04

Case Finishes

MAC
MEC
MOC
MGW
MNA
MSW
MTW
MWL

3 Select Edge

[Click to view edges](#)

Edge
N/A

Edge
N/A

Edge
N/A

Edge
N/A

4 Select Hardware

[Click to view details](#)

Hardware
N/A

Hardware
N/A

Hardware
N/A

Hardware
N/A

Chameleon

Sit-On Door Storage
30"/45"/60" Sit On Drop Door Cabinet

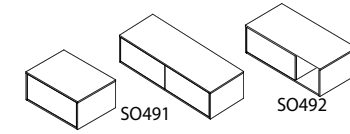

[Click here to view statement of line](#)

1 Select Model

w" x d" x h"

2 Section/1 Door/Center Partition

30 x 14 x 14

2 Section/2 Doors/Center Partition

60 x 14 x 14

45 x 14 x 14

Weight

Standard Veneer Chassis	Premium Veneer Chassis	High Pressure Laminate Chassis	Thermally Fused Laminate Chassis
-------------------------	------------------------	--------------------------------	----------------------------------

CHM3014SO491W 1652	CHM3014SO491P 1815	CHM3014SO491G 1570	CHM3014SO491M 1172
CHM6014SO491W 2600	CHM6014SO491P 2856	CHM6014SO491G 2469	CHM6014SO491M 1843
CHM4514SO492W 1984	CHM4514SO492P 2180	CHM4514SO492G 1886	CHM4514SO492M 1407

Product Features

- Interior Cabinet Depth 13"
- Product ships assembled

Notes

- Unit designed for open plan use.
- Unit is not connected with fasteners unless specified.

Options

Top Grommets(Over Belt Line Cavity Wire Management)

Specify Color and Left/Right/Center- \$50 ea.

- Black: TM30-R(Right), TM30-L(Left), TM30-C(Center)

- Silver: TM31-R(Right),TM31-L(Left),TM31-C(Center)

- White: TM34-R(Right),TM34-L(Left),TM34-C(Center)

Grommets (For Ganging)

Vertical sleeve grommet, template provided for field installation

- TM60: Vertical Grommet Sleeve - \$50

Door Lock

- D2: Door/ Lock (locks 1 door or 1 pedestal) - \$100 each

2 Select Finish

[Click to view finishes](#)

Case Finishes

WNF	PO02
WSF	PO03
WWP	PO07
WEC	PO08
PM01	PO09
PM02	
PM03	
PM07	
PM08	
PM10	
PO01	

Case Finishes

WOW
WNO
WSO
WLA

Case Finishes

GWL LW05
GEC LW06
LP04
LF02
LF03
LN04
LA05
LW01
LW02
LW04

Case Finishes

MAC
MEC
MOC
MGW
MNA
MSW
MTW
MWL

3 Select Edge

[Click to view edges](#)

Edge
N/A

Edge
N/A

Edge
N/A

Edge
N/A

4 Select Hardware

[Click to view details](#)

Push to Open Standard:
Optional Hardware Below

Push to Open Standard:
Optional Hardware Below

Push to Open Standard:
Optional Hardware Below

Push to Open Standard:
Optional Hardware Below



Chameleon

Single Height Wall Hung Cabinet
30"/45"/60" Open Cabinet

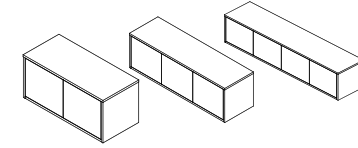

[Click here to view statement of line](#)

1 Select Model

w" x d" x h"
1 Section No Partition
30 x 14 x 14
2 Section w/Partition
45 x 14 x 14
2 Section/Center Partion
60 x 14 x 14

Weight

Standard Veneer Chassis	Premium Veneer Chassis	High Pressure Laminate Chassis	Thermally Fused Laminate Chassis
CHM3014WH330W 1325	CHM3014WH330P 1456	CHM3014WH330G 1259	CHM3014WH330M 938
CHM4514WH330W 1635	CHM4514WH330P 1799	CHM4514WH330G 1554	CHM4514WH330M 1161
CHM6014WH330W 1957	CHM6014WH330P 2148	CHM6014WH330G 1859	CHM6014WH330M 1385

Product Features

- Interior Cabinet Depth 12"
- Product ships assembled
- Metal wall mounting rail included

Notes

- The DARRAN wall mounted cabinet(or shelf) must be hung on a weight-bearing wall. The suitability of the wall supporting the wall mounted cabinet, and the installation and maintenance of the wall-mounted cabinet, is the sole responsibility of the customer. Failure to correctly install and/or exceed the loaded weight capacity of this product may cause it to fall, resulting in damage to the product, or adjacent property and/or bodily injury.

Options

Task Lighting

- LT-LED24: 24" LED Task light - \$215
- LT-LED48: 48" LED Task light - \$270
- LT-LED60: 60" LED Task light - \$335

2 Select Finish

[Click to view finishes](#)

Case Finishes

WNF PO02
WSF PO03
WWP PO07
WEC PO08
PM01 PO09
PM02
PM03
PM07
PM08
PM10
PO01

Case Finishes

WOW
WNO
WSO
WLA

Case Finishes

GWL LW05
GEC LW06
LP04
LF02
LF03
LN04
LA05
LW01
LW02
LW04

Case Finishes

MAC
MEC
MOC
MGW
MNA
MSW
MTW
MWL

3 Select Edge

[Click to view edges](#)

Edge
N/A

Edge
N/A

Edge
N/A

Edge
N/A

4 Select Hardware

[Click to view details](#)

Hardware
N/A

Hardware
N/A

Hardware
N/A

Hardware
N/A

Chameleon

Single Height Wall Hung Cabinet
30"/45"/60" Sliding Door

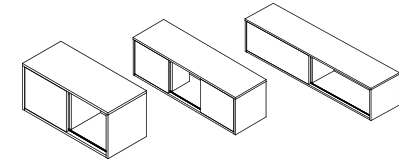

[Click here to view statement of line](#)

1 Select Model

w" x d" x h"

- 2 Section/1 Door/Center Partition
30 x 14 x 14
- 3 Section/2 Doors/2 Partitions
45 x 14 x 14
- 2 Section/1 Door/Center Partion
60 x 14 x 14

Weight

Standard Veneer Chassis	Premium Veneer Chassis	High Pressure Laminate Chassis	Thermally Fused Laminate Chassis
CHM3014WH302W 1412	CHM3014WH302P 1425	CHM3014WH302G 1230	CHM3014WH302M 920
CHM4514WH302W 1815	CHM4514WH302P 1830	CHM4514WH302P 1723	CHM4514WH302M 1287
CHM6014WH302W 2213	CHM6014WH302P 2431	CHM6014WH302G 2104	CHM6014WH302M 1570

Product Features

- Interior Cabinet Depth 12"
- Product ships assembled
- Metal wall mounting rail included

Notes

- The DARRAN wall mounted cabinet(or shelf) must be hung on a weight-bearing wall. The suitability of the wall supporting the wall mounted cabinet, and the installation and maintenance of the wall-mounted cabinet, is the sole responsibility of the customer. Failure to correctly install and/or exceed the loaded weight capacity of this product may cause it to fall, resulting in damage to the product, or adjacent property and/or bodily injury.

Options

Task Lighting

- LT-LED24: 24" LED Task light - \$215
- LT-LED48: 48" LED Task light - \$270
- LT-LED60: 60" LED Task light - \$335

2 Select Finish

[Click to view finishes](#)

Case Finishes

- WNF PO02
- WSF PO03
- WWP PO07
- WEC PO08
- PM01 PO09
- PM02
- PM03
- PM07
- PM08
- PM10
- PO01

Case Finishes

- WOW
- WNO
- WSO
- WLA

Case Finishes

- GWL LW05
- GEC LW06
- LP04
- LF02
- LF03
- LN04
- LA05
- LW01
- LW02
- LW04

Case Finishes

- MAC
- MEC
- MOC
- MGW
- MNA
- MSW
- MTW
- MWL

3 Select Edge

[Click to view edges](#)

Edge
N/A

Edge
N/A

Edge
N/A

Edge
N/A

4 Select Hardware

[Click to view details](#)

Hardware
N/A

Hardware
N/A

Hardware
N/A

Hardware
N/A

Chameleon

Single Height Wall Hung Cabinet
 30"/45"/60" Lift-Up Door Cabinet

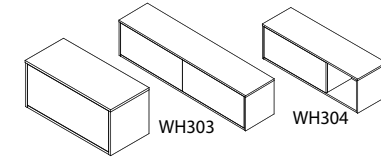

[Click here to view statement of line](#)

1 Select Model

Weight

w" x d" x h"

- 2 Section/1 Door/Center Partition
30 x 14 x 14
- 2 Section/2 Doors/1 Partitions
60 x 14 x 14
- 45 x 14 x 14

Standard Veneer Chassis	Premium Veneer Chassis	High Pressure Laminate Chassis	Thermally Fused Laminate Chassis
-------------------------	------------------------	--------------------------------	----------------------------------

CHM3014WH303W 1652	CHM3014WH302P 1815	CHM3014WH302G 1570	CHM3014WH302M 1172
CHM6014WH303W 2600	CHM6014WH303P 2856	CHM6014WH303G 2469	CHM6014WH303M 1843
CHM4514WH304W 1984	CHM4514WH304P 2180	CHM4514WH304G 1886	CHM4514WH304M 1407

Product Features

- Interior Cabinet Depth 12"
- Product ships assembled
- Metal wall mounting rail included

Notes

- The DARRAN wall mounted cabinet(or shelf) must be hung on a weight-bearing wall. The suitability of the wall supporting the wall mounted cabinet, and the installation and maintenance of the wall-mounted cabinet, is the sole responsibility of the customer. Failure to correctly install and/or exceed the loaded weight capacity of this product may cause it to fall, resulting in damage to the product, or adjacent property and/or bodily injury.

Options

Task Lighting

- LT-LED24: 24" LED Task light - \$215
- LT-LED48: 48" LED Task light - \$270
- LT-LED60: 60" LED Task light - \$335

2 Select Finish

[Click to view finishes](#)

Case Finishes

- WNF PO02
- WSF PO03
- WWP PO07
- WEC PO08
- PM01 PO09
- PM02
- PM03
- PM07
- PM08
- PM10
- PO01

Case Finishes

- WOW
- WNO
- WSO
- WLA

Case Finishes

- GWL LW05
- GEC LW06
- LP04
- LF02
- LF03
- LN04
- LA05
- LW01
- LW02
- LW04

Case Finishes

- MAC
- MEC
- MOC
- MGW
- MNA
- MSW
- MTW
- MWL

3 Select Edge

[Click to view edges](#)

Edge
N/A

Edge
N/A

Edge
N/A

Edge
N/A

4 Select Hardware

[Click to view details](#)

Hardware
N/A

Hardware
N/A

Hardware
N/A

Hardware
N/A

Chameleon

Mobile Pedestals
Open Plan Mobile Desk Pedestal With Casters

optional top organizer



[Click here to view statement of line](#)

1 Select Model

w" x d" x h"
Box/File
16 x 20 x 21
Box/Drop Down Door
20 x 20 x 21
30 x 20 x 21

Weight

Standard Veneer Pedestal	Premium Veneer Pedestal	High Pressure Laminate Pedestal	Thermally Fused Laminate Chassis
--------------------------	-------------------------	---------------------------------	----------------------------------

CHM1620PD423W 1925	CHM1620PD423P 2118	CHM1620PD423G 1779	CHM1620PD423M 1243
CHM2020PD422W 2000	CHM2020PD422P 2200	CHM2020PD422G 1846	CHM2020PD422M 1292
CHM3020PD421W 2226	CHM3020PD421P 2450	CHM3020PD421G 2060	CHM3020PD421M 1439

Product Features

- Anti-tilt safety feature
- Finished all sides and top - open plan
- Standard Gray Caster with Black Ring

Options

Top Accessory Tray

- SOWT1: Wood Tray Accessory - \$240
- SOLT1: High Pressure Laminate Tray Accessory - \$195

Cushion

- BC16: Bench Cushion
- Specify fabric grade (1 yd. required)

Door lock

- D2: Door/ Lock (locks 1 door or 1 pedestal) - \$100 each

BC16 Cushion fabric grades

COM	COL	1	2	3
224	243	261	279	297
4	5	6	7	8
315	333	351	369	387
9	10	11/ L1	12	13/ L2
405	423	441	459	495

2 Select Finish

[Click to view finishes](#)

Case Finishes

WNF	PO02
WSF	PO03
WWP	PO07
WEC	PO08
PM01	PO09
PM02	
PM03	
PM07	
PM08	
PM10	
PO01	

Case Finishes

WOW
WNO
WSO
WLA

Case Finishes

GWL	LW05
GEC	LW06
LP04	
LF02	
LF03	
LN04	
LA05	
LW01	
LW02	
LW04	

Case Finishes

MAC
MEC
MOC
MGW
MNA
MSW
MTW
MWL

3 Select Edge

[Click to view edges](#)

Edge
N/A

Edge
N/A

Edge
N/A

Edge
N/A

4 Select Hardware

[Click to view details](#)

Push to Open Standard:
Optional Hardware Below

Push to Open Standard:
Optional Hardware Below

Push to Open Standard:
Optional Hardware Below

Push to Open Standard:
Optional Hardware Below



Chameleon

Vertical Half Tower
Storage - Panel Door

[Click here to view statement of line](#)

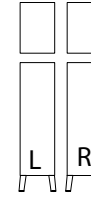

1 Select Model

w" x d" x h"
Door Hinged Left
15 x 22 x 55
15 x 22 x 70
Door Hinged Right
15 x 22 x 55
15 x 22 x 70

Weight

Standard Veneer Chassis Solid Wood Legs	Premium Veneer Chassis Solid Wood Legs	High Pressure Laminate Chassis Solid Wood Legs	Thermally Fused Laminate Chassis Solid Wood Legs
--	---	---	---

CHM1555TW610W 3091	CHM1555TW610P 3396	CHM1555TW610G 2938	CHM1555TW610M 2191
CHM1570TW610W 3358	CHM1570TW610P 3690	CHM1570TW610G 3189	CHM1570TW610M 2382
CHM1555TW611W 3091	CHM1555TW611P 3396	CHM1555TW611G 2938	CHM1555TW611M 2191
CHM1570TW611W 3358	CHM1570TW611P 3690	CHM1570TW611G 3189	CHM1570TW611M 2382

Product Features

- 55" has 3 finished adjustable shelves
- 70" has 1 fixed and 3 adjustable finished shelves
- Product ships assembled
- Solid wood legs

Notes

- Unit designed for open plan use.
- 55"H Interior Measurements for: 16-5/8" W x 20-5/8"D x 47-5/8"H
- 70"H Interior Measurements for: 16-5/8" W x 20-5/8"D x 61-5/8"H

Options

Door

- D2: Door/ Lock (locks 1 door or 1 pedestal) - \$100 each
- D6: Delete doors - n/c
- D9SC: Soft Close Door Hinges - \$20 per door

Grommets (For Ganging)

- Vertical sleeve grommet, template provided for field installation
- TM60: Vertical Grommet Sleeve - \$50

2 Select Finish

[Click to view finishes](#)

Case Finishes	Leg Finishes
WNF	PO02 WOW PO09
WSF	PO03 WNO
WWP	PO07 WSO
WEC	PO08 WLA
PM01	PO09 WWP
PM02	WEC
PM03	PO01
PM07	PO02
PM08	PO03
PM10	PO07
PO01	PO08

Case Finishes	Leg Finishes
WOW	WOW PO08
WNO	WNO PO09
WSO	WLA
WLA	WLA
	WWP
	WEC
	PO01
	PO02
	PO03
	PO07

Case Finishes	Leg Finishes
GWL LW05	WWP
GEC LW06	WOW
LP04	WLA
LF02	WNO
LF03	WSO
LN04	WEC
LA05	PO01
LW01	PO02
LW02	PO03
LW04	PO07
	PO08
	PO09

Case Finishes	Leg Finishes
MAC	WOW PO08
MEC	WNO PO09
MOC	WSO
MGW	WLA
MNA	WWP
MSW	WEC
MTW	PO01
MWL	PO02
	PO03
	PO07

3 Select Edge

[Click to view edges](#)

Edge
N/A

Edge
N/A

Edge
N/A

Edge
N/A

4 Select Hardware

[Click to view details](#)

Push to Open Standard:
Optional Hardware Below

Push to Open Standard:
Optional Hardware Below

Push to Open Standard:
Optional Hardware Below

Hardware
N/A



Chameleon

Vertical Half Tower
Storage Wardrobe - Panel Door

[Click here to view statement of line](#)

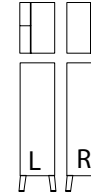

1 Select Model

w" x d" x h"
Door Hinged Left
15 x 22 x 55
15 x 22 x 70
Door Hinged Right
15 x 22 x 55
15 x 22 x 70

Weight

Standard Veneer Chassis Solid Wood Legs	Premium Veneer Chassis Solid Wood Legs	High Pressure Laminate Chassis Solid Wood Legs	Thermally Fused Laminate Chassis Solid Wood Legs
--	---	---	---

CHM1555TW612W 3352	CHM1555TW612P 3685	CHM1555TW612G 3183	CHM1555TW612M 2377
CHM1570TW612W 3581	CHM1570TW612P 3935	CHM1570TW612G 3401	CHM1570TW612M 2540
CHM1555TW613W 3352	CHM1555TW613P 4142	CHM1555TW613G 3183	CHM1555TW613M 2377
CHM1570TW613W 3772	CHM1570TW613P 4142	CHM1570TW613G 3401	CHM1570TW613M 2540

Product Features

- 55" has 3 finished fixed shelves
- 70" has 1 fixed and 3 adjustable finished shelves
- Product ships assembled
- Wardrobe w/ hook

Notes

- Unit designed for open plan use.
- 55"H Interior Measurements
- Wardrobe: 4-1/2" x 20-5/8" x 47-5/8". Storage: 9-1/8" x 20-5/8" x 47-5/8"
- 70"H Interior Measurements
- Wardrobe: 4-1/2" x 20-5/8" x 61-5/8". Storage: 9-1/8" x 20-5/8" x 61-5/8"

Options

Door

- D2: Door/ Lock (locks 1 door or 1 pedestal) - \$100 each
- D6: Delete doors - n/c
- D9SC: Soft Close Door Hinges - \$20 per door

Grommets (For Ganging)

- Vertical sleeve grommet, template provided for field installation
- TM60: Vertical Grommet Sleeve - \$50

2 Select Finish

[Click to view finishes](#)

Case Finishes	Leg Finishes
WNF	PO03 WOW PO09
WSF	PO07 WNO
WWP	PO08 WSO
PM01	PO09 WLA
PM02	WWP
PM03	WEC
PM07	PO01
PM08	PO02
PM10	PO03
PO01	PO07
PO02	PO08

Case Finishes	Leg Finishes
WOW	PO08
WNO	PO09
WSO	
WLA	

Case Finishes	Leg Finishes
GWL LW06	WWP
LP01	WOW
LF02	WLA
LF03	WNO
LN01	WSO
LA02	PO01
LW01	PO02
LW02	PO03
LW04	PO07
LW05	PO08
	PO09

Case Finishes	Leg Finishes
MAC	PO08
MEC	PO09
MOC	WSO
MGW	WLA
MNA	WWP
MSW	WEC
MTW	PO01
MWL	PO02
	PO03
	PO07
	PO08
	PO09

3 Select Edge

[Click to view edges](#)

Edge
N/A

Edge
N/A

Edge
N/A

Edge
N/A

4 Select Hardware

[Click to view details](#)

Push to Open Standard:
Optional Hardware Below

Push to Open Standard:
Optional Hardware Below

Push to Open Standard:
Optional Hardware Below



Chameleon

Vertical Full Tower
Storage Wardrobe - Panel Door

[Click here to view statement of line](#)

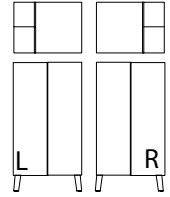
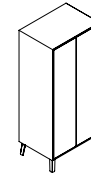

1 Select Model

w" x d" x h"
Left Wardrobe
30 x 22 x 55
30 x 22 x 70
Right Wardrobe
30 x 22 x 55
30 x 22 x 70

Weight

Standard Veneer Chassis Solid Wood Legs	Premium Veneer Chassis Solid Wood Legs	High Pressure Laminate Chassis Solid Wood Legs	Thermally Fused Laminate Chassis Solid Wood Legs
--	---	---	---

CHM3055TW615W 3772	CHM3055TW615P 4142	CHM3055TW615G 3581	CHM3055TW615M 2671
CHM3070TW615W 3974	CHM3070TW615P 4366	CHM3070TW615G 3777	CHM3070TW615M 2818
CHM3055TW616W 3772	CHM3055TW616P 4142	CHM3055TW616G 3581	CHM3055TW616M 2671
CHM3070TW616W 3974	CHM3070TW616P 4366	CHM3070TW616G 3777	CHM3070TW616M 2818

Product Features

- 55" has 3 finished fixed shelves
- 70" has 1 fixed and 3 adjustable finished shelves
- Product ships assembled
- Wardrobe w/ coat rod & hook

Notes

- Unit designed for open plan use.
- 55"H Interior Measurements
- Wardrobe: 9-3/8" x 20-5/8" x 47-5/8". Storage: 18-5/8" x 20-5/8" x 47-5/8"
- 70"H Interior Measurements
- Wardrobe: 9-3/8" x 20-3/8" x 61-5/8". Storage: 18-5/8" x 20-5/8" x 61-5/8"

Options

Door

- D2: Door/ Lock (locks 1 door or 1 pedestal) - \$100 each
- D6: Delete doors - n/c
- D9SC: Soft Close Door Hinges - \$20 per door

Grommets (For Ganging)

- Vertical sleeve grommet, template provided for field installation
- TM60: Vertical Grommet Sleeve - \$50

2 Select Finish

[Click to view finishes](#)

Case Finishes	Leg Finishes
WNF	PO03 WOW PO09
WSF	PO07 WNO
WWP	PO08 WSO
PM01	PO09 WLA
PM02	WWP
PM03	WEC
PM07	PO01
PM08	PO02
PM10	PO03
PO01	PO07
PO02	PO08

Case Finishes	Leg Finishes
WOW	PO08
WNO	PO09
WSO	
WLA	

Case Finishes	Leg Finishes
GWL LW06	WWP
LP01	WOW
LF02	WLA
LF03	WNO
LN01	WSO
LA02	PO01
LW01	PO02
LW02	PO03
LW04	PO07
LW05	PO08
	PO09

Case Finishes	Leg Finishes
MAC	PO08
MEC	PO09
MOC	WSO
MGW	WLA
MNA	WWP
MSW	WEC
MTW	PO01
MWL	PO02
	PO03
	PO07

3 Select Edge

[Click to view edges](#)

Edge
N/A

Edge
N/A

Edge
N/A

Edge
N/A

4 Select Hardware

[Click to view details](#)

Push to Open Standard:
Optional Hardware Below

Push to Open Standard:
Optional Hardware Below

Push to Open Standard:
Optional Hardware Below



Chameleon

Vertical Full Tower
Storage Side Access Wardrobe - Panel Door

[Click here to view statement of line](#)

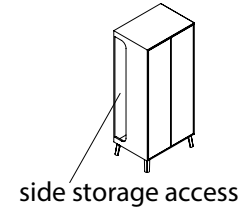

1 Select Model

w" x d" x h"
Left Wardrobe
30 x 22 x 55
30 x 22 x 70
Right Wardrobe
30 x 22 x 55
30 x 22 x 70

Weight

Standard Veneer Chassis Solid Wood Legs	Premium Veneer Chassis Solid Wood Legs	High Pressure Laminate Chassis Solid Wood Legs	Thermally Fused Laminate Chassis Solid Wood Legs
CHM3055TW617W 3772	CHM3055TW617P 4142	CHM3055TW617G 3581	CHM3055TW617M 2671
CHM3070TW617W 3974	CHM3070TW617P 4366	CHM3070TW617G 3777	CHM3070TW617M 2818
CHM3055TW618W 3772	CHM3055TW618P 4142	CHM3055TW618G 3581	CHM3055TW618M 2671
CHM3070TW618W 3974	CHM3070TW618P 4366	CHM3070TW618G 3777	CHM3070TW618M 2818

Product Features

- 55" has 3 finished adjustable shelves
- 70" has 4 finished fixed shelves
- Product ships assembled
- Side Access Wardrobe w/ coat rod & hook

Notes

- Unit designed for open plan use.
- 55"H Interior Measurements
- Wardrobe: 28-5/8" x 7-1/4" x 47-5/8". Storage: 28-5/8" x 12-3/4" x 47-5/8"
- 70"H Interior Measurements
- Wardrobe: 28-5/8" x 7-1/4" x 61-5/8". Storage: 28-5/8" x 12-3/4" x 61-5/8"

Options

Door

- D2: Door/ Lock (locks 1 door or 1 pedestal) - \$100 each
- D6: Delete doors - n/c
- D9SC: Soft Close Door Hinges - \$20 per door

Grommets (For Ganging)

- Vertical sleeve grommet, template provided for field installation
- TM60: Vertical Grommet Sleeve - \$50

2 Select Finish

[Click to view finishes](#)

Case Finishes	Leg Finishes
WNF	PO02 WOW PO09
WSF	PO03 WNO
WWP	PO07 WSO
WEC	PO08 WLA
PM01	PO09 WWP
PM02	WEC
PM03	PO01
PM07	PO02
PM08	PO03
PM10	PO07
PO01	PO08

Case Finishes	Leg Finishes
WOW	WOW PO08
WNO	WNO PO09
WSO	
WLA	

Case Finishes	Leg Finishes
GWL LW06	WWP
LP01	WOW
LF02	WLA
LF03	WNO
LN01	WSO
LA02	PO01
LW01	PO02
LW02	PO03
LW04	PO07
LW05	PO08
	PO09

Case Finishes	Leg Finishes
MAC	WOW PO08
MEC	WNO PO09
MOC	WSO
MGW	WLA
MNA	WWP
MSW	WEC
MTW	PO01
MWL	PO02
	PO03
	PO07
	PO08
	PO09

3 Select Edge

[Click to view edges](#)

Edge
N/A

Edge
N/A

Edge
N/A

Edge
N/A

4 Select Hardware

[Click to view details](#)

Push to Open Standard:
Optional Hardware Below

Push to Open Standard:
Optional Hardware Below

Push to Open Standard:
Optional Hardware Below



Chameleon

Vertical Full Tower
Storage - Panel Door

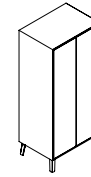

[Click here to view statement of line](#)

1 Select Model

w" x d" x h"
30 x 22 x 55
30 x 22 x 70

Weight

Standard Veneer Chassis Solid Wood Legs		Premium Veneer Chassis Solid Wood Legs		High Pressure Laminate Chassis Solid Wood Legs		Thermally Fused Laminate Chassis Solid Wood Legs	
--	--	---	--	---	--	---	--

CHM3055TW614W	3663	CHM3055TW614P	4023	CHM3055TW614G	3478	CHM3055TW614M	2595
CHM3070TW614W	3941	CHM3070TW614P	4328	CHM3070TW614G	3745	CHM3070TW614M	2791

Product Features

- 55" has 3 finished adjustable shelves
- 70" has 4 finished fixed shelves
- Product ships assembled
- Solid wood legs

Notes

- Unit designed for open plan use.
- 55"H Interior Measurements
- Wardrobe: 28-5/8" x 20-5-8" x 47-5/8". Storage: 28-5/8" x 20-5/8" x 47-5/8"
- 70"H Interior Measurements
- Wardrobe: 28-5/8" x 20-5/8" x 47-5/8" Storage: 28-5/8"W x 20-5/8"D x 61-5/8"H

Options

Door

- D2: Door/ Lock (locks 1 door or 1 pedestal) - \$100 each
- D6: Delete doors - n/c
- D9SC: Soft Close Door Hinges - \$20 per door

Grommets (For Ganging)

- Vertical sleeve grommet, template provided for field installation
- TM60: Vertical Grommet Sleeve - \$50

2 Select Finish

[Click to view finishes](#)

Case Finishes	Leg Finishes
WNF	PO03 WOW PO09
WSF	PO07 WNO
WWP	PO08 WSO
PM01	PO09 WLA
PM02	WWP
PM03	WEC
PM07	PO01
PM08	PO02
PM10	PO03
PO01	PO07
PO02	PO08

Case Finishes	Leg Finishes
WOW	WOW PO08
WNO	WNO PO09
WSO	WSO
WLA	WLA
	WWP
	WEC
	PO01
	PO02
	PO03
	PO07

Case Finishes	Leg Finishes
GWL LW06	WWP
LP01	WOW
LF02	WLA
LF03	WNO
LN01	WSO
LA02	PO01
LW01	PO02
LW02	PO03
LW04	PO07
LW05	PO08
	PO09

Case Finishes	Leg Finishes
MAC	WOW PO08
MEC	WNO PO09
MOC	WSO
MGW	WLA
MNA	WWP
MSW	WEC
MTW	PO01
MWL	PO02
	PO03
	PO07

3 Select Edge

[Click to view edges](#)

Edge
N/A

Edge
N/A

Edge
N/A

Edge
N/A

4 Select Hardware

[Click to view details](#)

Push to Open Standard:
Optional Hardware Below

Push to Open Standard:
Optional Hardware Below

Push to Open Standard:
Optional Hardware Below



Chameleon

Open Plan Bookcase
Fixed Type A Insert Placement

[Click here to view statement of line](#)

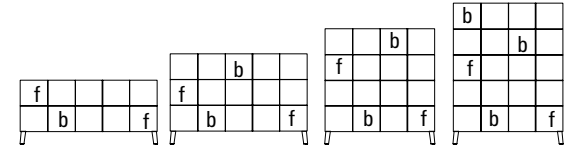

1 Select Model

w" x d" x h"
75.5 x 15 x 35
75.5 x 15 x 50
61 x 15 x 63
61 x 15 x 77

Weight

Standard Veneer Chassis Solid Wood Legs	Premium Veneer Chassis Solid Wood Legs	High Pressure Laminate Chassis Solid Wood Legs	Thermally Fused Laminate Chassis Solid Wood Legs
CHM7635BK244W 2985	CHM7635BK244W 3576	CHM7635BK244G 3091	CHM7635BK244M 2306
CHM7650BK244W 3663	CHM7650BK244P 4028	CHM7650BK244G 3478	CHM7650BK244M 2600
CHM6163BK244W 3745	CHM6163BK244P 4115	CHM6163BK244G 3559	CHM6163BK244M 2655
CHM6177BK244W 3990	CHM6177BK244P 4382	CHM6177BK244G 3788	CHM6177BK244M 2829

Product Features

- Fixed veneer insert panels are placed to the front "f" or back "b" of the case
- Product ships assembled
- Solid wood legs
- Fixed Inserts match bookcase finish. For contrasting panels order removable inserts
- Solid wood legs

Notes

- Unit designed for open plan use.
- 75" x 35" bookcase has 3 fixed back inserts and 10 total cubbies
- 75" x 50" bookcase has 4 fixed back inserts and 15 total cubbies
- 61" x 63" bookcase has 4 fixed back inserts and 16 total cubbies
- 61" x 77" bookcase has 5 fixed back inserts and 20 total cubbies

Options

Bookcase Panel Inserts (Removable)

- RV1: Removable Veneer or Painted Insert - \$180 ea.
- Specify Finish: PO01, PO02, PO03, PO07, PO08, PO09, PM01, PM02, PM03, PM07, PM08, PM10, WNO, WOW, WSO, WLA, WWP
- RL1: Removable Laminate Insert - \$125 ea.
- Specify laminate: GWL, LP01, LF02, LF03, LN01, LA02, LW01, LW02, LW04, LW05, LW06
- RF1: Removable Felt Insert - \$215 ea.
- Specify Felt: FL01, FL02, FL03, FL04, FL05, FL06, FL07, FL08, FL09, FL10, FL11, FL12

2 Select Finish

[Click to view finishes](#)

Case Finishes	Leg Finishes
WNF	PO03 WOW PO09
WSF	PO07 WNO
WWP	PO08 WSO
PM01	PO09 WLA
PM02	WWP
PM03	WEC
PM07	PO01
PM08	PO02
PM10	PO03
PO01	PO07
PO02	PO08

Case Finishes	Leg Finishes
WOW	PO08
WNO	PO09
WSO	
WLA	

Case Finishes	Leg Finishes
GWL LW06	WWP
LP01	WOW
LF02	WLA
LF03	WNO
LN01	WSO
LA02	PO01
LW01	PO02
LW02	PO03
LW04	PO07
LW05	PO08
	PO09

Case Finishes	Leg Finishes
MAC	PO08
MEC	PO09
MOC	WSO
MGW	WLA
MNA	WWP
MSW	WEC
MTW	PO01
MWL	PO02
	PO03
	PO07

3 Select Edge

[Click to view edges](#)

Edge
N/A

Edge
N/A

Edge
N/A

Edge
N/A

4 Select Hardware

[Click to view details](#)

Hardware
N/A

Chameleon

Open Plan Bookcase
Fixed Type B Insert Placement

[Click here to view statement of line](#)

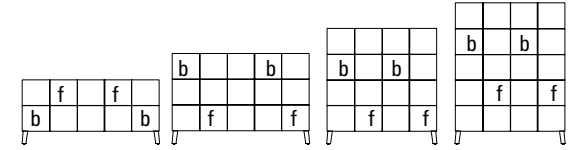

1 Select Model

w" x d" x h"
75.5 x 15 x 35
75.5 x 15 x 50
61 x 15 x 63
61 x 15 x 77

Weight

Standard Veneer Chassis Solid Wood Legs		Premium Veneer Chassis Solid Wood Legs		High Pressure Laminate Chassis Solid Wood Legs		Thermally Fused Laminate Chassis Solid Wood Legs	
CHM7635BK245W	3254	CHM7635BK245P	3576	CHM7635BK245G	3091	CHM7635BK245M	2306
CHM7650BK245W	3663	CHM7650BK245P	4028	CHM7650BK245G	3478	CHM7650BK245M	2600
CHM6163BK245W	3745	CHM6163BK245P	4115	CHM6163BK245G	3559	CHM6163BK245M	2655
CHM6177BK245W	3990	CHM6177BK245P	4382	CHM6177BK245G	3788	CHM6177BK245M	2829

Product Features

- Fixed insert panels are placed to the front "f" or back "b" of the case
- Product ships assembled
- Solid wood legs
- Fixed Inserts match bookcase finish. For contrasting panels order removable inserts

Notes

- Unit designed for open plan use.
- 75" x 35" bookcase has 4 fixed back inserts and 10 total cubbies
- 75" x 50" bookcase has 4 fixed back inserts and 15 total cubbies
- 61" x 63" bookcase has 4 fixed back inserts and 16 total cubbies
- 61" x 77" bookcase has 4 fixed back inserts and 20 total cubbies

Options

Bookcase Panel Inserts (Removable)

- RV1: Removable Veneer or Painted Insert - \$180 ea.
- Specify Finish: PO01, PO02, PO03, PO07, PO08, PO09, PM01, PM02, PM03, PM07, PM08, PM10, WNO, WOW, WSO, WLA, WWP
- RL1: Removable Laminate Insert - \$125 ea.
- Specify laminate: GWL, LP01, LF02, LF03, LN01, LA02, LW01, LW02, LW04, LW05, LW06
- RF1: Removable Felt Insert - \$215 ea.
- Specify Felt: FL01, FL02, FL03, FL04, FL05, FL06, FL07, FL08, FL09, FL10, FL11, FL12

2 Select Finish

[Click to view finishes](#)

Case Finishes	Leg Finishes
WNF	PO03 WOW PO09
WSF	PO07 WNO
WWP	PO08 WSO
PM01	PO09 WLA
PM02	WWP
PM03	WEC
PM07	PO01
PM08	PO02
PM10	PO03
PO01	PO07
PO02	PO08

Case Finishes	Leg Finishes
WOW	WOW PO08
WNO	WNO PO09
WSO	WSO
WLA	WLA
	WWP
	WEC
	PO01
	PO02
	PO03
	PO07

Case Finishes	Leg Finishes
GWL LW06	WWP
LP01	WOW
LF02	WLA
LF03	WNO
LN01	WSO
LA02	PO01
LW01	PO02
LW02	PO03
LW04	PO07
LW05	PO08
	PO09

Case Finishes	Leg Finishes
MAC	WOW PO08
MEC	WNO PO09
MOC	WSO
MGW	WLA
MNA	WWP
MSW	WEC
MTW	PO01
MWL	PO02
	PO03
	PO07

3 Select Edge

[Click to view edges](#)

Edge
N/A

Edge
N/A

Edge
N/A

Edge
N/A

4 Select Hardware

[Click to view details](#)

Hardware
N/A

Chameleon

Interpersonal Screen
Acoustic Interpersonal Screen

[Click here to view statement of line](#)

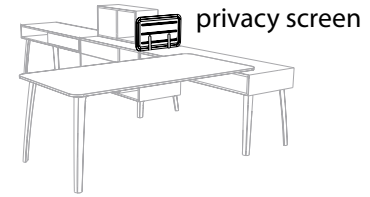

1 Select Model

w" x d" x h"
23" x 13.5"

Weight

Acoustic Interpersonal Screen				
SAPS14	511			

Product Features

- Acoustic panels are double sided with rounded corners
- Specify only one between two inline units
- Mounting brackets are standard white Metal Finish. See Premium Metal Finishes for options

Options

Premium Metal Finishes

- Specify Screen Brackets Metal Finish Color: \$50
- MFS: Silver, MFMB: Matte Black, MFGG: Graphite Gray, MFSS: Salmon Sienna, MFSA: Surfin Aquavert, MFPS: Pistachio, MFOS: Oyster, MFNA: Navy, MFOL: Olive, MFGB: Grey Beige

Premium Acoustic Material

- Specify Premium Acoustic Material Color
- 17, 3, 2, 18, 21, 29, 24, 35, 39
- Contact customer service for premium acoustic screen pricing. When specifying a quantity of ten or less acoustic screens in a premium material, an upcharge will apply - \$250

2 Select Finish

[Click to view finishes](#)

Metal Finish
MFW White (standard).
Additional Metal
Finishes are available,
options

3 Select Edge

[Click to view edges](#)

Edge
N/A

4 Select Acoustic Material

[Click to view details](#)

Chameleon

Privacy Screen
Acoustic Modesty

[Click here to view statement of line](#)

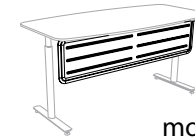

modesty

1 Select Model

w" x d" x h"
38.5" x 13.5
46.5 x 13.5
54.25 x 13.5

Weight

Acoustic Modesty White Mounting Bracket				
HMAP3814	552			
HMAP4614	575			
HMAP5414	575			

2 Select Finish

[Click to view finishes](#)

Metal Finish
MFW White (standard).
Additional Metal
Finishes are available,
options

3 Select Edge

[Click to view edges](#)

Edge
N/A

4 Select Acoustic Material

[Click to view details](#)

Product Features

- Acoustic panels are double sided with rounded corners
- Half modesty is mounted under worksurface and gives 13.5" of privacy below worksurface
- Mounting brackets are standard white Metal Finish. See Premium Metal Finishes for options
- Specify panel that fits work surface top size

Options

Premium Metal Finishes

- Specify Screen Brackets Metal Finish Color: \$50
- MFS: Silver, MFMB: Matte Black, MFGG: Graphite Gray, MFSS: Salmon Sienna, MFSA: Surfin Aquavert, MFPS: Pistachio, MFOS: Oyster, MFNA: Navy, MFOL: Olive, MFGB: Grey Beige

Premium Acoustic Material

- Specify Premium Acoustic Material Color
- 17, 3, 2, 18, 21, 29, 24, 35, 39
- Contact customer service for premium acoustic screen pricing. When specifying a quantity of ten or less acoustic screens in a premium material, an upcharge will apply - \$250

Chameleon

Freestanding Screen - 40"W x 56"H
Screen with Solid Wood Legs

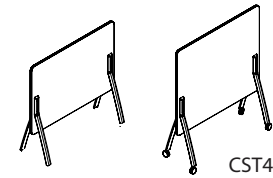

CST4 optional caster

[Click here to view statement of line](#)

1 Select Model

w" x d" x h"
40 x 18.5 x 56

Weight
60

Fabric Tack Board Solid Wood Legs		Magnetic Marker Board Solid Wood Legs		White Acrylic Board Solid Wood Legs	
CHM4056FT539	2256	CHM4056MB539	2559	CHM4056AB539	2363

Product Features

- Freestanding screen with the option of a fabric tack board, fabric magnetic board and magnetic marker board
- Solid steam bent leg with insert detail
- Inserts are standard veneer finished to match legs
- Legs are solid ash or walnut based on finish selection

Notes

- Fabric board: 2.5 yds

Options

Mobile Screen /Add Caster

- CST4: Add casters to screen Legs - \$200

Contrasting Leg Inserts

- Specify contrasting leg insert. Select any leg finish - \$120
- FLI01: Felt Leg Insert (specify color) - \$120

Magnetic Metal Tray

- MUT18: 18" White Magnetic Metal Tray - \$250
- Available on Fabric Magnetic and Magnetic Boards
- Specify Premium Metal Finish Color on Tray: \$60
- MFS: Silver, MFMB: Matte Black, MFGG: Graphite Gray, MFSS: Salmon Sienna, MFSA: Surfin Aquavert, MFPS: Pistachio, MFOS: Oyster, MFNA: Navy, MFOL: Olive, MFGB: Grey Beige. MFGM: Matte Gold, MFDB: Dark Bronze

Fabric Grades

COM	COL	1	2	3
1898	N/A	1998	2044	2090
4	5	6	7	8
2136	2182	2228	2274	2320
9	10	11	12	13
2366	2412	2458	2504	2596

2 Select Finish

[Click to view finishes](#)

Leg Finishes

WWP	PO07
WEC	PO08
WNF	PO09
WSF	
WOW	
WNO	
WSO	
WLA	
PO01	
PO02	
PO03	

Leg Finishes

WWP	PO08
WEC	PO09
WOW	
WLA	
WNO	
WSO	
PO01	
PO02	
PO03	
PO07	

Leg Finishes

WWP	PO08
WEC	PO09
WOW	
WLA	
WNO	
WSO	
PO01	
PO02	
PO03	
PO07	

3 Select Edge

[Click to view edges](#)

Edge
N/A

Edge
N/A

Edge
N/A

4 Select Hardware

[Click to view details](#)

Hardware
N/A

N/A

N/A

Chameleon

Freestanding Screen - 54"W x 56"H
Screen with Solid Wood Legs

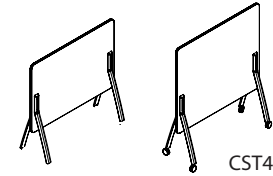

CST4 optional caster

[Click here to view statement of line](#)

1 Select Model

w" x d" x h"
54 x 18.5 x 56

Weight
80

Fabric Tack Board Solid Wood Legs		Magnetic Marker Board Solid Wood Legs		White Acrylic Board Solid Wood Legs	
CHM5456FT539	2375	CHM5456MB539	2840	CHM5456AB539	2528

Product Features

- Freestanding screen with the option of a fabric tack board, fabric magnetic board and magnetic marker board
- Solid steam bent leg with insert detail
- Inserts are standard veneer finished to match legs
- Legs are solid ash or walnut based on finish selection

Notes

- Fabric board: 3.25 yds

Options

Mobile Screen /Add Caster

- CST4: Add casters to screen Legs - \$200

Contrasting Leg Inserts

- Specify contrasting leg insert. Select any leg finish - \$120
- FLI01: Felt Leg Insert (specify color) - \$120

Magnetic Metal Tray

- MUT18: 18" White Magnetic Metal Tray - \$250
- Available on Fabric Magnetic and Magnetic Boards
- Specify Premium Metal Finish Color on Tray: \$60
- MFS: Silver, MFMB: Matte Black, MFGG: Graphite Gray, MFSS: Salmon Sienna, MFSA: Surfin Aquavert, MFPS: Pistachio, MFOS: Oyster, MFNA: Navy, MFOL: Olive, MFGB: Grey Beige. MFGM: Matte Gold, MFDB: Dark Bronze

Fabric Grades

COM	COL	1	2	3
1998	N/A	2125	2184	2243
4	5	6	7	8
2302	2361	2420	2479	2538
9	10	11	12	13
2597	2656	2715	2774	2892

2 Select Finish

[Click to view finishes](#)

Leg Finishes

WWP	PO07
WEC	PO08
WNF	PO09
WSF	
WOW	
WNO	
WSO	
WLA	
PO01	
PO02	
PO03	

Leg Finishes

WWP	PO08
WEC	PO09
WOW	
WLA	
WNO	
WSO	
PO01	
PO02	
PO03	
PO07	

Leg Finishes

WWP	PO08
WEC	PO09
WOW	
WLA	
WNO	
WSO	
PO01	
PO02	
PO03	
PO07	

3 Select Edge

[Click to view edges](#)

Edge
N/A

Edge
N/A

Edge
N/A

4 Select Hardware

[Click to view details](#)

Hardware
N/A

N/A

N/A

Chameleon

Freestanding Screen - 40"W x 66"H
Screen with Solid Wood Legs

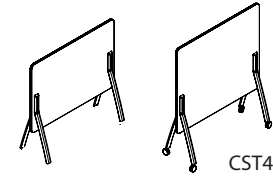

CST4 optional caster

[Click here to view statement of line](#)

1 Select Model

w" x d" x h"
40 x 18.5 x 66

Weight
70

Fabric Tack Board Solid Wood Legs		Magnetic Marker Board Solid Wood Legs		White Acrylic Board Solid Wood Legs	
CHM4066FT539	2333	CHM4066MB539	2591	CHM4066AB539	2449

Product Features

- Freestanding screen with the option of a fabric tack board, fabric magnetic board and magnetic marker board
- Solid steam bent leg with insert detail
- Inserts are standard veneer finished to match legs
- Legs are solid ash or walnut based on finish selection

Notes

- Fabric board: 2.5 yds

Options

Mobile Screen /Add Caster

- CST4: Add casters to screen Legs - \$200

Contrasting Leg Inserts

- Specify contrasting leg insert. Select any leg finish - \$120
- FLI01: Felt Leg Insert (specify color) - \$120

Magnetic Metal Tray

- MUT18: 18" White Magnetic Metal Tray - \$250
- Available on Fabric Magnetic and Magnetic Boards
- Specify Premium Metal Finish Color on Tray: \$60
- MFS: Silver, MFMB: Matte Black, MFGG: Graphite Gray, MFSS: Salmon Sienna, MFSA: Surfin Aquavert, MFPS: Pistachio, MFOS: Oyster, MFNA: Navy, MFOL: Olive, MFGB: Grey Beige. MFGM: Matte Gold, MFDB: Dark Bronze

Fabric Grades

COM	COL	1	2	3
1963	N/A	2062	2108	2154
4	5	6	7	8
2200	2246	2292	2338	2384
9	10	11	12	13
2430	2476	2522	2568	2660

2 Select Finish

[Click to view finishes](#)

Leg Finishes

- WWP PO07
- WEC PO08
- WNF PO09
- WSF
- WOW
- WNO
- WSO
- WLA
- PO01
- PO02
- PO03

Leg Finishes

- WWP PO08
- WEC PO09
- WOW
- WLA
- WNO
- WSO
- PO01
- PO02
- PO03
- PO07

Leg Finishes

- WWP PO08
- WEC PO09
- WOW
- WLA
- WNO
- WSO
- PO01
- PO02
- PO03
- PO07

3 Select Edge

[Click to view edges](#)

Edge
N/A

Edge
N/A

Edge
N/A

4 Select Hardware

[Click to view details](#)

Hardware
N/A

N/A

N/A

Chameleon

Freestanding Screen - - 54"W x 66"H
Screen with Solid Wood Legs

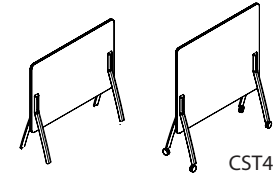

CST4 optional caster

[Click here to view statement of line](#)

1 Select Model

w" x d" x h"
54 x 18.5 x 66

Weight
90

Fabric Tack Board Solid Wood Legs		Magnetic Marker Board Solid Wood Legs		White Acrylic Board Solid Wood Legs	
CHM5466FT539	2461	CHM5466MB539	2877	CHM5466AB539	2625

Product Features

- Freestanding screen with the option of a fabric tack board, fabric magnetic board and magnetic marker board
- Solid steam bent leg with insert detail
- Inserts are standard veneer finished to match legs
- Legs are solid ash or walnut based on finish selection

Notes

- Fabric board: 3.25 yds

Options

Mobile Screen /Add Caster

- CST4: Add casters to screen Legs - \$200

Contrasting Leg Inserts

- Specify contrasting leg insert. Select any leg finish - \$120
- FLI01: Felt Leg Insert (specify color) - \$120

Magnetic Metal Tray

- MUT18: 18" White Magnetic Metal Tray - \$250
- Available on Fabric Magnetic and Magnetic Boards
- Specify Premium Metal Finish Color on Tray: \$60
- MFS: Silver, MFMB: Matte Black, MFGG: Graphite Gray, MFSS: Salmon Sienna, MFSA: Surfin Aquavert, MFPS: Pistachio, MFOS: Oyster, MFNA: Navy, MFOL: Olive, MFGB: Grey Beige. MFGM: Matte Gold, MFDB: Dark Bronze

Fabric Grades

COM	COL	1	2	3
2070	N/A	2199	2258	2317
4	5	6	7	8
2376	2435	2494	2553	2612
9	10	11	12	13
2671	2730	2789	2848	2966

2 Select Finish

[Click to view finishes](#)

Leg Finishes

WWP	PO07
WEC	PO08
WNF	PO09
WSF	
WOW	
WNO	
WSO	
WLA	
PO01	
PO02	
PO03	

Leg Finishes

WWP	PO08
WEC	PO09
WOW	
WLA	
WNO	
WSO	
PO01	
PO02	
PO03	
PO07	

Leg Finishes

WWP	PO08
WEC	PO09
WOW	
WLA	
WNO	
WSO	
PO01	
PO02	
PO03	
PO07	

3 Select Edge

[Click to view edges](#)

Edge
N/A

Edge
N/A

Edge
N/A

4 Select Hardware

[Click to view details](#)

Hardware
N/A

N/A

N/A

Chameleon

Privacy Screen
Acoustic Worksurface Interpersonal Screen

[Click here to view statement of line](#)

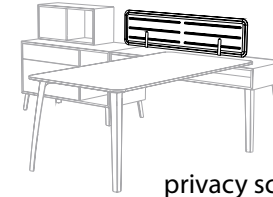

privacy screen

1 Select Model

w" x d" x h"
38.5" x 13.5
46.51 x 13.5
54.25 x 13.5

Weight

Acoustic Worksurface Interpersonal Screen	
FAPS3814	575
FAPS4614	575
FAPS5414	575

2 Select Finish

[Click to view finishes](#)

WNF
WSF

Metal Finish
MFW White (standard).
Additional Metal
Finishes are available,
options

3 Select Edge

[Click to view edges](#)

Edge
N/A

4 Select Acoustic Material

[Click to view details](#)

Product Features

- Acoustic panels are double sided with rounded corners
- Front Acoustic Screens are mounted on top of worksurface and gives 13.5" of privacy above worksurface
- Mounting brackets are standard white Metal Finish. See Premium Metal Finishes for options
- Specify panel that fits work surface top size

Options

Premium Metal Finishes

- Specify Screen Brackets Metal Finish Color: \$50
- MFS: Silver, MFMB: Matte Black, MFGG: Graphite Gray, MFSS: Salmon Sienna, MFSA: Surfin Aquavert, MFPS: Pistachio, MFOS: Oyster, MFNA: Navy, MFOL: Olive, MFGB: Grey Beige

Premium Acoustic Material

- Specify Premium Acoustic Material Color
- 17, 3, 2, 18, 21, 29, 24, 35, 39
- Contact customer service for premium acoustic screens. when specifying a quantity of ten or less screens acoustic screens an upcharge will apply - \$250



COMPUTER SUPPORT
single monitor arm

COMPUTER SUPPORT
double monitor arm

COMPUTER SUPPORT
triple monitor arm

COMPUTER SUPPORT
quadruple monitor arm

Style Number	List Price
MA1	280

Style Number	List Price
MA2	450

Style Number	List Price
MA3	530

Style Number	List Price
MA4	705

Specifications

- Available in black or silver
- Desk clamp and grommet mounting included
- Easy assembly and flexibility
- Elastic painting process for a durable and beautiful finish
- Gas spring tension adjustment for counter-balance height adjustment for monitors 1-8 KG
- Gas spring tested to 50,000 repetitions
- Hidden cable management

Specifications

- Available in black or silver
- Desk clamp and grommet mounting included
- Easy assembly and flexibility
- Elastic painting process for a durable and beautiful finish
- Gas spring tension adjustment for counter-balance height adjustment for monitors 1-8 KG
- Gas spring tested to 50,000 repetitions
- Hidden cable management

Specifications

- Available in black or silver
- Desk clamp and grommet mounting included
- Easy assembly and flexibility
- Elastic painting process for a durable and beautiful finish
- Gas spring tension adjustment for counter-balance height adjustment for monitors 1-8 KG
- Gas spring tested to 50,000 repetitions
- Hidden cable management

Specifications

- Available in black
- Desk clamp and grommet mounting included
- Easy assembly and flexibility
- Elastic painting process for a durable and beautiful finish
- Gas spring tension adjustment for counter-balance height adjustment for monitors 1-8 KG
- Gas spring tested to 50,000 repetitions
- Hidden cable management

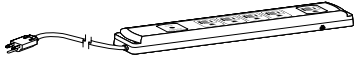

POWER / DATA
power supply cordset

Style Number	List Price
PD717	100

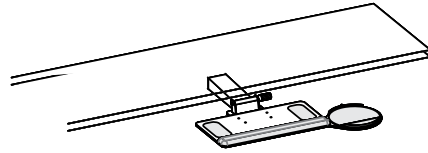

COMPUTER SUPPORT
articulating keyboard tray

Style Number	List Price
Factory Installed	
K28	390
Field Installed	
K28F	415



DOOR MODIFICATIONS
soft close door hinge

Style Number	List Price
D9SC	20 Per door

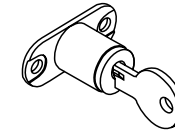

DOOR MODIFICATIONS
panel door lock

Style Number	List Price
D2-CHM	100 Per

Specifications

- SIZE: 10.75"L x 2.0"W x 1.06"H
- (5) Outlets w/ 10' cord
- Surge suppression (720 Joules)
- 15 Amp breaker
- Available on: Vertical Panels, Cabinet Interiors, and under tops

Specifications

- Adjusts effortlessly - A simple one-handed motion allows the keyboard to be repositioned instantly, without the use of locks or levers
- Encourages low-risk postures - Maximizes adjustability within a safe operating range.
- Will last a lifetime - Exceeds all applicable BIFMA Standards and comes with a lifetime guarantee.

- Notes
- Available on: Freestanding Desk
 - Factory Installed (standard)
 - Field Installed - \$415

Specifications

- Snap onto standard door hinge
- Requires (2) per door
- Max door height 43"
- Factory installed where specified
- Individually shipped for field installation

- Notes
- Specify Each Item To Have Slow Close Feature

Specifications

- Door Locks - 1 Door w/ Lock or Pedestal
- Contact Customer Service regarding limited lock locations and keying.

- Notes
- Available on: Panel Doors and Drawers

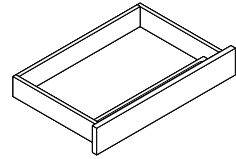
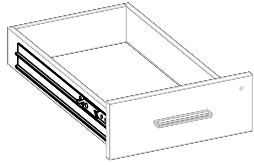

DRAWER OPTIONS
soft close suspension

DRAWER OPTIONS
finished center drawer

TASK LIGHTING
lt-led task light

GLASSBOARD ACCESSORIES
glassboard accessory kit

Style Number	List Price
SCS1	25 Per drawer

Style Number	List Price
K31	205
Add Skirt Option K31-SK	310

Style Number	List Price
24" Task light LT-LED24	215
48" Task light LT-LED48	260
60" Task light LT-LED60	335
72" Task light LT-LED72	360

Style Number	List Price
GBKIT	275

Specifications

- Factory installed where specified

Notes
- Not recommended for field installation

Specifications

- Veneer drawer front finished to match unit W or G style veneer.
- Ball bearing smooth operation
- Drawer has lifetime guarantee
- Standard with matching wood grain pencil tray
- Laminate drawer front to match laminate unit (M style)

Specifications

- 6.5' Power cord. Switch with touch dimmer
- 36 LEDs per foot
- 4.6 Watts per foot
- 91 Lumens per watt
- Please note when ganging.
- Overhead tasklight cord is located on the right facing side. If the opposite location is required please contact customer service.

Specifications

- 8 Earth magnets, 1 magnetic marker cup holder and 1 magnetic dry eraser

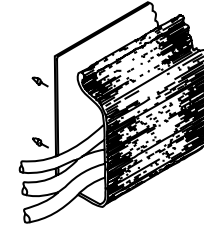
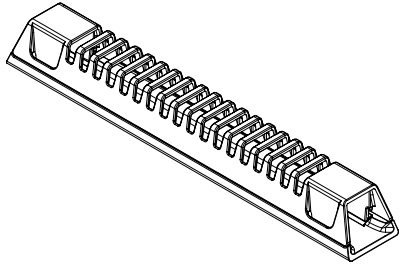

WIRE MANAGEMENT
horizontal wire management raceway

WIRE MANAGEMENT
horizontal u-channel wire management raceway

WIRE MANAGEMENT
coil wire manager

WIRE MANAGEMENT
horizontal j-channel wire management raceway

Style Number	List Price
W21	35

Style Number	List Price
W2A	80 Per 4' section

Style Number	List Price
W18	160

Style Number	List Price
W1	80 Per 4' section

Specifications

- 10"W x 1.5"D x 1.25"H
- Grey Wire Manager (10.5")
- Power and data cables can be discretely housed and managed with the W21 Gray Wire Manager. This can be mounted in any location to metal frame or underside of conference tables and runs cables through a 1" channel from power module to hollow steel legs. This keeps cables organized under the table top. Release clips make it simple to snap on and off the Wire Manager for easy organization and access after attached to the table

Notes
- Field installed

Specifications

- 4' section for field installation.
- Notes
- Units w/ Wire Channel Standard.
 - Field Installation

Specifications

- Weighted Base, Table attachment plate
- 39- 1/2" Length
- Black

Notes
- Location

Specifications

- 4' section for field installation.
- The "J" shape black thermoplastic wire raceway may be added to specified worksurface tops to provide concealed channeling of wires to and from worksurface grommets. For use in open kneespace areas, raceway is attachable to top of back panel with pan head screws. Interior dimensions are 1" x 1- 1/2" providing ample storage for multiple wires and excess cable. Front of raceway flexes out for easy cord insertion.

Notes
- Units w/ Wire Channel Standard.
- Field Installation

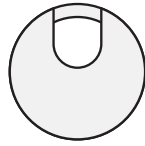
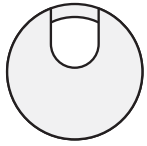

WIRE MANAGEMENT

standard location grommets - factory installed

Style Number	List Price
Standard Location Grommet	
Black	
TM30	50
Silver	
TM31	50
Antique Brass	
TM33	50
White	
TM34	50

WIRE MANAGEMENT

non-standard location grommets - factory installed

Style Number	List Price
Non-Standard Location Grommet	
Black	
TM30 -NS	95
Silver	
TM31 -NS	95
Antique Brass	
TM33 -NS	95
White	
TM34 -NS	95

WIRE MANAGEMENT

black plastic vertical surface grommets - factory installed

Style Number	List Price
Standard Location Grommet	
TM50-C	50
Non-Standard Location Grommet	
TM50-NS	95

Specifications

- 1 -5/8" Metal Grommet

Notes

- *Units w/ Grommets Standard Are Noted Under Standard Features. Grommets Match Pull Finish - Standard (Unless Specified Otherwise)

Specifications

- 1 -5/8" Metal Grommet

Notes

- *Units w/ Grommets Standard Are Noted Under Standard Features. Grommets Match Pull Finish - Standard (Unless Specified Otherwise)

Specifications

- 2 " Black Plastic Grommet

Notes

- Standard Location is Bottom Center

Aircharge wireless charging grommet

Style Number	List Price
ACWG WIRELESS GROMMET	\$213

Specifications

- > When used with GROVE Tables an additional \$350 LIST will apply for the special cutout required.
- > AirCharge offers a convenient way to charge any Qi compatible smartphone or device without the need to carry charging cables or find an available power outlet.
- > The Aircharge is powered by the latest Qi compliant IC offering reliable and efficient wireless charging in a convenient 3" grommet hub. Simply place your phone on the Aircharge and an LED will confirm pairing and begin wireless charging.
- > Recess: Efficient space conservation and quick access
- > Input: DC 5V (with included AC power adapter), DC 9V, 1.67A (with optional QC 2.0 power adapter)
- > Output: 5 watts Max. with DC 5V, 2A power adapter, 10 watts Max. with QC 2.0 power adapter
- > Qi V1.2 compliant IC
- > Charging distance: 6mm Max.

Available: All DARRAN collections



Cove power unit with daisylink

Style Number	List Price
--------------	------------

STARTER UNITS



COV-DCH HARDWIRED	\$744
-------------------	-------

Includes (1) Cove unit with Hardwire Infeed - 120"



COV-DCP PLUG	\$872
--------------	-------

Includes (1) Cove unit with Plug infeed - Includes 72" Cord and 32" Infeed Jumper for 104" total cord infeed

ADDITIONAL LINKING UNITS

COV-DCL	\$627 EACH
---------	------------

Includes Linking Cove unit and Jumper up to 96", cable length determined by the top size

Specifications

- > Size: 5.75"L x 2.5"W
- > (2) 15 Amp Receptacles and (2) 2.1 Amp USB charging ports
- > Surface Mount
- > Max Daisy Chain - Hardwire - (9) units; Plug/Corded - (4) units
- > Standard Silver Finish, Available in White or Black Finish upon request
- > ETL Listed



Available: All DARRAN collections



DARRAN®

Power & Data Options

Cove power unit with daisylink

Style Number	List Price
STARTER UNITS	
 COV-DCH HARDWIRED	\$744
Includes (1) Cove unit with Hardwire Infeed - 120"	
 COV-DCP PLUG	\$872
Includes (1) Cove unit with Plug infeed - Includes 72" Cord and 32" Infeed Jumper for 104" total cord infeed	
ADDITIONAL LINKING UNITS	
COV-DCL	\$627 EACH
Includes Linking Cove unit and Jumper up to 96", cable length determined by the top size	





Specifications

- > Size: 5.75"L x 2.5"W
- > (2) 15 Amp Receptacles and (2) 2.1 Amp USB charging ports
- > Surface Mount
- > Max Daisy Chain - Hardwire - (9) units; Plug/Corded - (4) units
- > Standard Silver Finish, Available in White or Black Finish upon request
- > ETL Listed

Available: All DARRAN collections

VILLA Power unit with daisylink

Style Number	List Price
STARTER UNITS	
 VIL-DCH HARDWIRED	\$975
Includes (1) Villa unit with 120" Hardwire Infeed	
 VIL-DCP PLUG	\$975
Includes (1) Villa with Plug Infeed - Includes 72" Cord and 32" Infeed Jumper for 104" total cord infeed	
ADDITIONAL LINKING UNITS	
VIL-DCL ADDITIONAL	\$950
(Includes linking Villa and Jumper cable up to 96")	

Specifications

- > Size: Top Grommet 5.68"L X 3.39"W; Under Top 12"L x 3.13"W x 3.08"D
- > (4) Power receptacles; (2) surface and (2) undersurface, (2) 2.1A USB charging ports and (1) Knockout for RJ45 Data Port
- > Surface Mount
- > Daisy Chain - Hardwire Max (10) Units, Plug/Corded Max (5) Units
- > Standard Silver Finish, Black Finish available upon request
- > UL or ETL Certified

Available: All DARRAN collections, excludes grove

RJ45 Knockout	
RJ45 (1)	\$55





Not So Square Open Price List

Effective November 1, 2022

Date	Page	Modification	Description
9.14.22			Removed power block options
11.10.22		Price Increase	9% price increase applied to all item except for options

Statement of Line
Fabric seat & leather program.....1
Features & Advantages4
Finishes | Specifications6
Edges | Pulls7
Grommets | Grommet Reference.....8
Modesty Reference | Doors | Grain Direction9
Drawer Dimensions | Filing Reference10
Wire Management11
Workstation Typical.....12
Worksurface Tops13
Legs15
Adjustable Height Desk and Units17
Storage Tower Kits.....21
End Cabinets25
Benches and Mobile Peds.....27
Shared Storage.....30
Not SO square Stools31
Bar Height Table and Bar Stools.....32
Fabric Privacy and Modesty Tack Panels.....34
Acrylic End Privacy Panels37
Glass Privacy Modesty Panels.....40
Options42
Power & Data.....49

Statement of Line

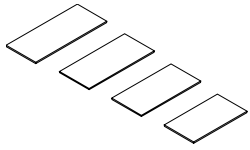

Page 13
Worksurface Tops
Worksurface Tops

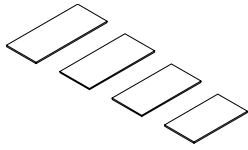

Page 14
Worksurface Tops
Worksurface Tops With Exposed
Plywood Edge

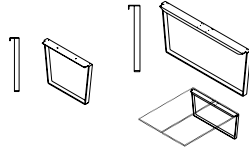

Page 15
Legs
End Leg

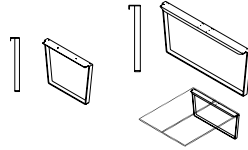

Page 16
Legs
Connecting Leg

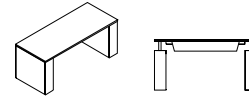

Page 17
Adjustable Height Desk And Units
Adjustable Height Desk - With
Acrylic Half Modesty Panel

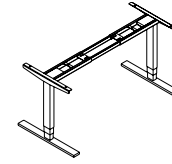

Page 18
Adjustable Height Desk And Units
Adjustable Height Mechanism



Page 19
Adjustable Height Desk And Units
Single Leg Pedestal

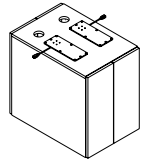

Page 20
Adjustable Height Desk And Units
Double Leg Pedestal

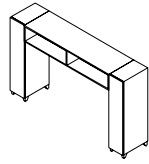

Page 21
Storage Tower Kits - Kit #1
48" H Bridge Unit, Open Unit,
Overhead W/ 2 Sided Access

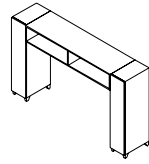

Page 22
Storage Tower Kits - Kit #2
48" H Bridge Unit, Open Unit,
Overhead W/ 1 Sided Access

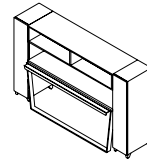

Page 23
Storage Tower Kits - Kit #3
48" H Bridge Unit, Connecting
Surface, Overhead W/ 2 Sided
Access

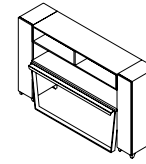

Page 24
Storage Tower Kits - Kit #4
48" H Bridge Unit, Connecting
Surface, Overhead W/ 1 Sided
Access

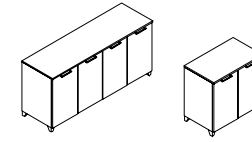

Page 25
End Cabinets
End Cabinet / Door Storage

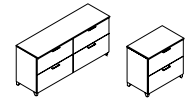

Page 26
End Cabinets
End Cabinet / 2 Drawer Lateral
File

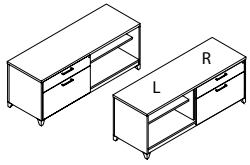

Page 27
Benches And Mobile Peds
Benches - Box/File Storage Right
And Left

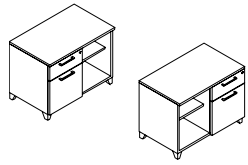

Page 28
Benches And Mobile Peds
Benches - Box File/Storage Right
And Left

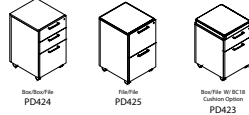

Page 29
Benches And Mobile Peds
Mobile Peds - Box Box File Lock,
Casters

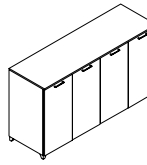

Page 30
Shared Storage
Shared Door Storage

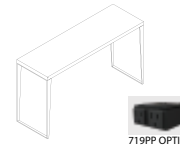

Page 31
Bar Height Table



Page 32
Bar Height Table And Bar Stools
Short Back Bar Stool

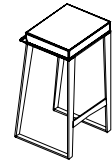

Page 33
Bar Height Table And Bar Stools
Backless Bar Stool

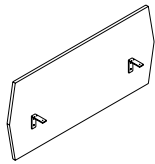

Page 34
Fabric Privacy And Modesty Tack
Panels
24" High Fabric Panels

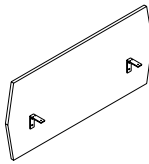

Page 35
Fabric Privacy And Modesty Tack
Panels
24" High Fabric Panels

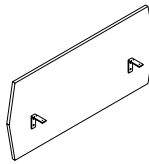

Page 36
Fabric Privacy And Modesty Tack
Panels
24" High Fabric Panels

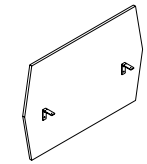

Page 37
Acrylic Privacy/Modesty Panels
Acrylic Privacy/Modesty Panels

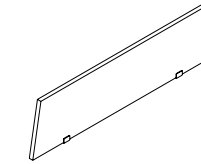

Page 38
Acrylic Privacy/Modesty Panels
Half Acrylic Privacy Panel

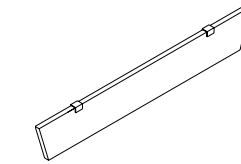

Page 39
Acrylic Privacy/Modesty Panels
Overhead Privacy Panel

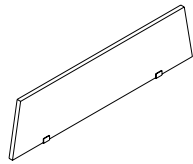

Page 40
Ultraclear Glass Privacy/Modesty
Panels
12" High Glass Panels

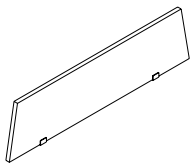

Page 41
Ultraclear Glass Privacy/Modesty
Panels
18" High Glass Panels

DARRAN®

Seating & fabric leather program

DARRAN has partnered with some of the most prestigious fabric suppliers of the office furniture industry to bring you quality fabrics that are engaging designs, environmentally friendly and durable for years to come. The majority of fabrics we have graded-in are in heavy supply making it most likely available on our Quickship however, we cannot guarantee stock. If you do not see the fabric you wish to include in a project, please contact our Factory to see if this pattern can be graded in at 800.334.7891.

Fabrics & Leathers

Please visit our Seating Fabrics page at darran.com/textilesleather

Camira
www.camirafabrics.com
800.334.789

Wollsdorf
www.wollsdorf.com
336.884.5005

CFStinson
www.cfstinson.com
800.841.6279

Green Hides
www.greenhides.com
336.315.9720

DesignTex
www.designtex.com
800.797.4949

Maharam
www.maharam.com
800.645.3943

Momentum Textiles
www.momentumtextiles.com
800.366.6839

Ultrafabrics
www.ultrafabricsinc.com
800.334.7891

Application instructions must be specified on the purchase order or COM / COL submission form. In the absence of application instructions, DARRAN will apply materials accordingly.

Not So Square Open Seating Fabric & Leather Program

CAL117

All DARRAN seating products conform to California Technical Bulletin 117 as a minimum standard.

CAL133

To meet the California Technical Bulletin 133 flammability regulation, a combination of proper materials must be used to pass, as it tests the fire resistance of a finished product. Flame resistant fabric, a fire blocker material and special foam must be used to pass CAL133 fire codes.

Testing is available for all seating products with the following fees and considerations:

- If laboratory certification is not required, any style can be manufactured to comply with California Technical Bulletin 133 for \$75 list per yard required. (Customer's Own Materials must factor in additional yardage requirements based on repeat.)
- The purchase order must clearly indicate the requirement of California Technical Bulletin 133
- If laboratory California Technical Bulletin 133 certification is required, the cost of testing a chair is \$820 NET, plus the cost of the chair and covering material.
- An additional lead time of 4 to 6 weeks is required for testing for CAL133.
- Once testing is completed, we will provide a certification letter specific to the sample tested for CAL133.
- DARRAN's manufacturing procedures for California TB 133 compliance are based on the testing of representative style with specific fabrics. Please contact Customer Service for an updated list of tested models.
- A copy of test certification is available upon request.

Combination fabrics

DARRAN is pleased to offer customers the design freedom of combination fabrics. When using fabric, vinyl or leather combinations, pricing will be as follows:

- When combining two materials of the same grade, pricing will be specified grade + 5%.
- If combining two materials of different grades or leather/ fabric combination, use the highest grade/price + 5%.
- If using COM or COL, pricing will be COM or COL + 5%. If both COM + COL are used in combination, use COL + 5%

COM/COL ordering instructions

Please complete the COM Submission Form prior to ordering the fabric from the supplier. All COM fabrics must be approved prior to order submission. Please refer to our website or contact DARRAN Seating Customer Service for an updated list of preapproved COM fabrics. Application instructions must be specified on the purchase order or COM/COL submission form. In the absence of application instructions, DARRAN will apply materials in the best manner and cannot be held responsible for tailoring or application objections after upholstery. COM orders will be scheduled for production after receipt of the material. Packages must be clearly marked and the fabric must be first quality, continuous yardage.

COM/COL yardage requirements

The yardage requirements stated in this price list for each style are calculated using 54" wide, non-directional fabrics. For fabrics with a different width or for patterns with repeats, please refer to the below chart to calculate the additional percent of fabric required:

Fabric Width	Plain Fabric	2"- 14" Repeat	15"- 19" Repeat	20"- 27" Repeat	28"- 36" Repeat
54"	0	15%	20%	25%	30%
53"	6%	19%	24%	28%	36%
52"	13%	23%	28%	33%	38%
51"	19%	26%	31%	36%	41%
50"	25%	30%	35%	40%	45%
49"	30%	35%	40%	45%	50%
48"	35%	40%	45%	50%	55%
47"	45%	50%	55%	58%	65%

DARRAN®

NOTE: Prior To Completion Of This Form, Please Refer To Our Graded In Materials Program For Preapproved Fabrics/Leathers.

COM/COL Approval

DARRAN Furniture Industries
2402 Shore Street, High Point, NC 27263
ATTN: Seating Division / COM/COL Approval
TAG: DARRAN Purchase Order Number

Shipping approved COM/COL materials

DARRAN Furniture Industries
2402 Shore Street, High Point, NC 27263
ATTN: Seating Division / COM/COL Approval
TAG: DARRAN Purchase Order Number

Please complete this form, attach a 6"x 6" sample and mail to the COM/COL APPROVAL address shown above.
This form can also be downloaded from our website at www.darran.com/leathers OR www.darran.com/fabrics

Purchase Order # _____

Dealer's Name _____

Contact _____

Address _____

Telephone _____

Email _____

Chair Stlye _____

Manufacturer _____

Pattern Name _____

Pattern Color _____

Content _____

Repeat _____

Please specify any special requirements and check the application above.

Not So Square Open Seating Fabric & Leather Program

ATTACH 6" X 6" FABRIC/LEATHER SAMPLE HERE

NOTE
Actual Fabric/Leather samples needed instead of digital images. If digital images are sent in lieu of samples, DARRAN will only verify the pattern and will not take responsibility for color variances that cannot be verified due to printing restrictions

In the absence of application instructions, DARRAN will apply the material in the best manner and cannot be held responsible for tailoring or application objections after upholstering.

Unless otherwise instructed on the purchase order, excess COM materials will be recycled at the discretion of DARRAN after six months of the original product ship date.

The COM approval solely pertains to the application of the fabric onto the specified DARRAN seating product. DARRAN's approval or acceptance does not constitute any responsibility or warranty to the overall appearance, durability, flammability, defects, dye lot variations or colorfastness of the COM. It is the customer's responsibility to ensure the COM meets CAL 117 compliance and are first quality continuous goods.

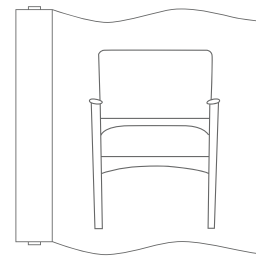

RAILROAD

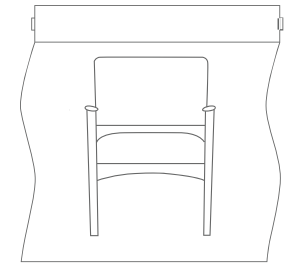

SETUP

TFL tops

Thermally Fused Laminate tops feature a 45-pound density substrate with balanced 3-ply construction. Tops are 1-1/8" thick on MDF core that is comprised of 100% recycled and recovered wood fibers. All Thermally Fused Laminate tops are available with a 2mm flat PVC band. Laminates in wood grain patterns feature Timberline Texture providing the grain pattern of wood.

Chassis & pedestal

Chassis components are 3/4" thick core of particle board or MDF rated EPP/SCS/CARB-II material with 3-ply balanced construction. Pedestal and Cabinets feature dowel construction reinforced with steel bracket plates, wood cleats, screws and glue. All units are standard with 1" adjustable glides that allow for leveling of units that are secured in solid wood glide blocks to prevent tearout.

Overhead cabinet construction

Freestanding & wall mount

Freestanding Overhead storage cabinets are constructed of 1" and 3/4" thick core of particle board or MDF rated EPP/SCS/CARB-II material with 3-ply balanced construction. Panels are attached with cam fasteners in conjunction with dowels securely adhered with PVAc glue. All surface mount cabinets connect to work surface with anti-slip tape. Wall mount cabinets are mounted to the wall with steel "z" bracket attachment method using 5mm euro screws to attach to the back of the cabinet. All units ship with a steel "z" bracket. This bracket is mounted to the wall by field installers. Installers are responsible for selecting and supplying appropriate fasteners for wall conditions.

Bookcase Construction

All chassis (sides, back, top and bottom panels) are constructed with 3/4" thick core of particle board or MDF rated EPP/SCS/CARB-II material with 3-ply balanced construction. Panels are attached with cam-lock fasteners in conjunction with dowels securely adhered with glue. Shelves on all units are 3/4" thick balance 3 ply panels. Optional heavy duty shelves are 1" thick lumber core balanced 5 ply construction.

Tackboards

Wall mount tackboards are constructed of .75" thick fiberboard. The fabric is precisely aligned and fitted to the tackboard with a sock on cover. Overhead storage tackboards are constructed of .75" thick fiberboard. The fabric is precisely aligned and fitted to the tackboard and adhered to the rigid hardboard with staples. Wall mount cabinets are mounted to the wall with steel "z" bracket attachment method using 5mm euro screws to attach to the back of the cabinet. All units ship with a steel "z" bracket. This bracket is mounted to the wall by field installers. Installers are responsible for selecting and supplying appropriate fasteners for wall conditions.

Adjustable glides

Glides provide 1" of vertical leveling adjustment. Glide bottom is durable metal. Glides are secured in solid wood blocks that are screwed and glued for durability.

Drawers

All drawers are constructed with mitre joint/dowel construction in a natural maple finish with four sides and a bottom, which are attached to a drawer front with screws for easy removal. Drawer fronts are vertically matched in balanced sets. Pencil trays are standard in all box drawers. Drawers are constructed of 1/2" thick wood grained wrapped 5 sided miter-folded construction with 1/4" thick hardboard bottoms reinforced for heavy weight capacity. Drawers have been tested and pass BIFMA 50,000 cycle test. All drawers are guaranteed lifetime with free replacement warranty. Optional veneered plywood drawers feature banded top and bottom edges for smoothness. Drawers are dowel joint constructed with a UV cured finish over maple veneers. Lifetime free replacement warranty. Optional wood drawer (any size) Option code P33 \$40 List per drawer

Drawer fronts

Drawer fronts are vertically matched in balanced sets. Doors feature vertical veneer bookmatched horizontally in sets of 2 / 4 and 6 doors. All tower fronts matched in vertical sets.

Suspensions

All casegoods utilize cold rolled steel zinc plated high-grade drawer suspensions. All suspensions are warranted for the lifetime of the product. Box and File drawers are full extension, featuring steel ball bearings for a smoother quieter range of motion and are rated 100lbs. Lateral file drawers are a progressive action full extension suspension and is rated at 150lbs. Veneer and High Pressure laminate casegoods feature soft close suspension. Thermally Fused Laminate casegoods feature standard suspensions. Lateral files include anti tip mechanism that allow only one drawer to be opened at a time.

Hinges

Units with doors include 95 degree swing hinges.

Filing

Not SO square open features a highly durable black plastic extrusion that is securely fastened into a route on top of the drawer to support hanging files. An adjustable crossbar is provided for all file drawers that enables legal/letter filing front to back or side-to-side based on the drawer size.

STANDARD VENEER	PREMIUM VENEER	HIGH PRESSURE LAMINATE	THERMALLY FUSED LAMINATE
N/A	N/A	N/A.....	MEC Ebony
N/A	N/A	N/A.....	MAC Amber Cherry
N/A	N/A	N/A.....	MOC KoKo Cherry
N/A	N/A	N/A.....	MGW Gunstock Walnut
N/A	N/A	N/A.....	MTW Studio Teak Walnut
N/A	N/A	N/A.....	MSW Skyline
N/A	N/A	N/A	MWL Designer White

HPL TOPS ON TFL PRODUCTS Add 10% - Available with flat edge only

Standard Profile

Flat Edge

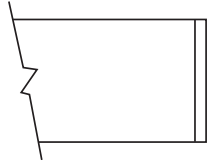

Flat

2mm PVC Edge

Pulls

Factory Installed

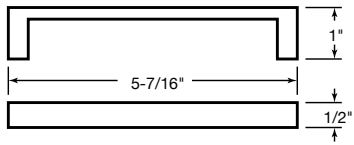

PL-115 Matte Black
PL-116 Matte Nickel

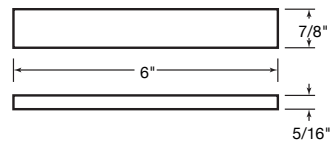

PL-210 Anodized Aluminum

DARRAN®

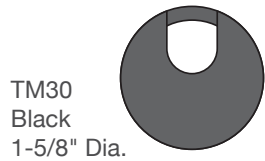

TM30
Black
1-5/8" Dia.



TM31
Silver
1-5/8" Dia.



TM34
White
1-5/8" Dia.

Optional grommets

Factory Installed

Grommets (Standard Location)

Specify Color and Left/Right/Center - \$50 ea.
- Black: TM30-R (Right), TM30-L (Left), TM30-C (Center)

- Silver: TM31-R (Right), TM31-L (Left), TM31-C (Center)

- White: TM33-R (Right), TM33-L (Left), TM33-C (Center)

Grommets (Non-Standard Location)

Provide drawing w/ Grommet Location and Specify Color - \$95 ea.

- Black: TM30-NS

- Silver: TM31-NS

- White: TM34-NS

Not So Square Open Grommets | Grommet Reference

TM50
Black
1-5/8" Dia.



Grommets (vertical surface)

Standard Location - \$50 ea.

- Black Plastic Vertical Surface: TM50-C (Bottom Center)

Non-Standard Location - \$95 ea.

- Black Plastic Vertical Surface: TM50-NS



W1

Horizontal J-channel

Horizontal J-Channel wire management (Sku: W-1) is sold separately to conceal wire under worksurfaces.

Standard grommet location reference



Worksurface

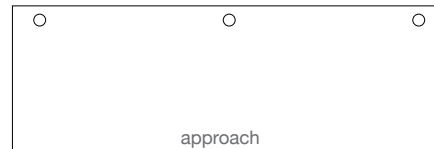

Shared Door Storage

Specify Right, Left or Center Grommet

Overhead door detail

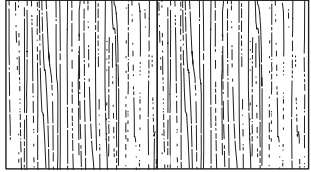

Panel Door

Grain direction



Workspace



Shared Storage / End Cabinets



Connecting Surface

Interior Drawer Dimensions

UNIT DEPTH	DRAWER TYPE	OVERALL DIMENSIONS			INTERIOR DRAWER DIMENSIONS			NOTES
		W	D	H	W	D	H	
15-5/8" Letter	36" Box	13-1/8	19-11/16	4	12-1/8	18-11/16	3-7/16	Units less than 72"
	36" File	13-1/8	19-11/16	9-13/16	12-1/8	18-11/16	9-5/16	Units less than 72"
	30" Box	13-1/8	19-11/16	4	12-1/8	18-11/16	3-7/16	Units less than 72"
	30" File	13-1/8	19-11/16	9-13/16	12-1/8	18-11/16	9-5/16	Units less than 72"
	24" Box	13-1/8	16-1/16	4	12-1/8	15-1/16	3-7/16	Units less than 72"
	24" File	13-1/8	16-1/16	9-13/16	12-1/8	15-1/16	9-5/16	Units less than 72"
29" Lateral	24" Box	26-1/2	16-1/16	4	25-1/2	15-1/16	3-7/16	Workstation Credenzas less than 82"
	24" File	26-1/2	16-1/16	9-13/16	25-1/2	15-1/16	9-5/16	Workstation Credenzas less than 82"
31" Lateral	24" File	28-9/16	16-1/16	9-13/16	27-9/16	15-1/16	9-5/16	Multi-File Lateral File
35" Lateral	24" Box	32-1/2	16-1/16	4	31-1/2	15-1/16	3-7/16	Workstation Credenzas over 83"
	24" File	32-1/2	16-1/16	9-13/16	31-1/2	15-1/16	9-5/16	Workstation Credenzas over 83"

Filing for 24" Depth Units

13" Wide File Drawer - 16" Deep

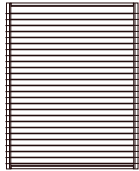

Letter Front to Back

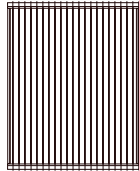

Legal Side to Side with File Rail

29" Lateral File Drawer

26-1/2" Wide File Drawer - 16-1/16" Deep

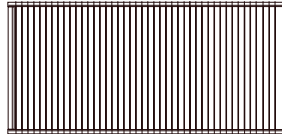

Legal Side to Side

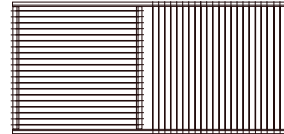

Legal Side to Side Letter Front to Back with File Rail

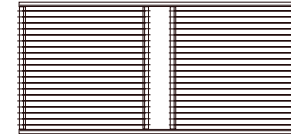

Letter Front to Back with File Rail

Filing for 30" & 36" Depth Units

13" Wide File Drawer - 20" Deep

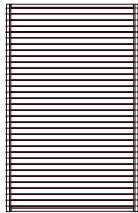

Letter Front to Back



Legal Side to Side with File Rail

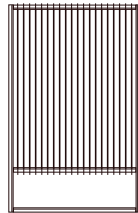

Letter Side to Side with File Rail

35" Lateral File Drawer

32-1/2" Wide File Drawer - 16-1/16" Deep

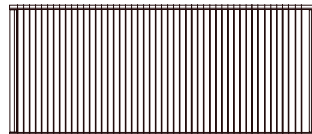

Legal Side to Side

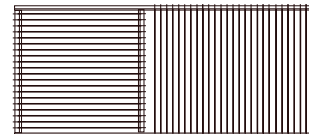

Legal Side to Side Letter Front to Back with File Rail

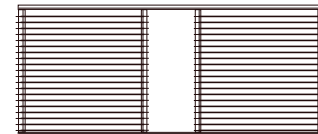

Letter Front to Back with File Rail



W17 - Wire management cover

NOT SO square has special metal covers that attach to legs to handle wires to the floor. The cover may be attached to the inside of any leg with magnets for each removal.

All metal legs and supports have wire management covers available in silver, white or black.

Metal Leg Offering

All metal is standard silver.

Cabinet Angular Foot
Cast Metal Leg

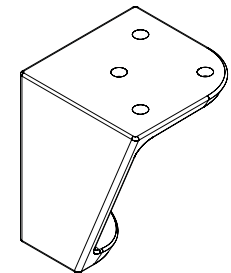
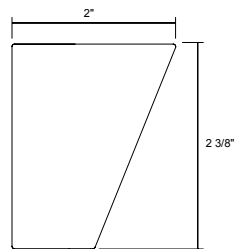

Angular Base
30" and 61"

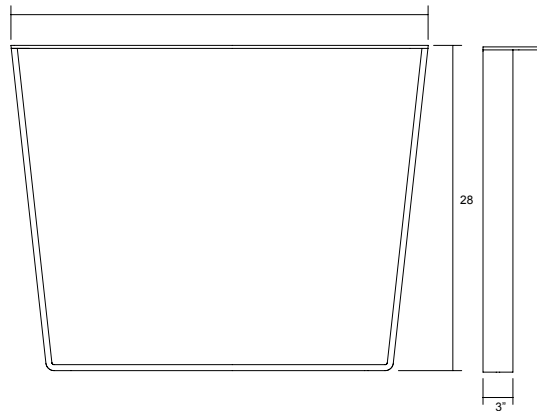

Overhead Support

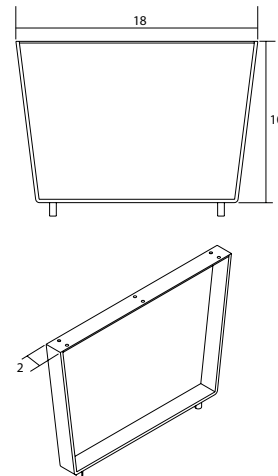

Use pre-assembled electrical packages or specify your own available plug or hardware.

Double sided overheads give each person personal storage



End leg for single top connection.

Connecting leg for double top connection.

End leg for single top connection.

NOT SO Square Open

Worksurface Tops

Worksurface Tops

[Click here to view statement of line](#)

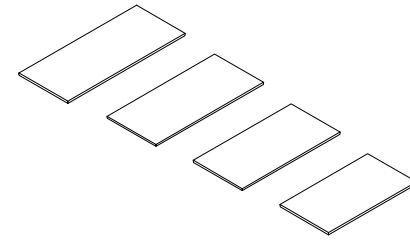

1 Select Model

w" x d" x h"	Weight
72 x 30 x 1.125	75
66 x 30 x 1.125	70
60 x 30 x 1.125	60
54 x 30 x 1.125	55

Standard Veneer Top Standard Veneer Chassis	Premium Veneer Top Premium Veneer Chassis	High Pressure Laminate Top Veneer Chassis	Thermally Fused Laminate Top Thermally Fused Laminate Chassis
"W" option N/A	"P" Option N/A	"G" Option N/A	NSS7230OP700M 681
"W" option N/A	"P" Option N/A	"G" Option N/A	NSS6630OP700M 668
"W" option N/A	"P" Option N/A	"G" Option N/A	NSS6030OP700M 580
"W" option N/A	"P" Option N/A	"G" Option N/A	NSS5430OP700M 566
			MAC MOC MEC MGW MTW MSW MWL
			 Flat
			Hardware N/A

Product Features

- 1.125 Inches thick melamine with PVC edge
- Surfaces 66" and over have two horizontal support rods
- Wire trough will be cut into top surface if specified
- Work surface may be connected to end leg, middle leg, case and privacy end panel

Options

Grommets (Standard Location)

- Specify Color and Location (Right/Left/Center) - \$50 ea.
- Black: TM30-R (Right), TM30-L (Left), TM30-C (Center)
 - Silver: TM31-R (Right), TM31-L (Left), TM31-C (Center)
 - White: TM34-R (Right), TM34-L (Left), TM34-C (Center)

Grommets (Non-Standard Location)

- Provide drawing w/ Grommet Location and Specify Color - \$95 ea.
- Black: TM30-NS
 - Silver: TM31-NS
 - White: TM34-NS

2 Select Finish

[Click to view finishes](#)

3 Select Edge

[Click to view edges](#)

4 Select Hardware

[Click to view details](#)

NOT SO Square Open

Worksurface Tops

Worksurface Tops With Exposed Plywood Edge

[Click here to view statement of line](#)

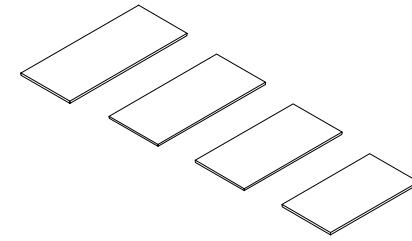

1 Select Model

w" x d" x h"	Weight
72 x 30 x 1.5	75
66 x 30 x 1.5	70
60 x 30 x 1.5	60
54 x 30 x 1.5	55

Standard Veneer Top Standard Veneer Chassis		Premium Veneer Top Premium Veneer Chassis	High Pressure Laminate Top Veneer Chassis	Thermally Fused Laminate Top Thermally Fused Laminate Chassis
NSS7230OP800W	1647	"P" Option N/A	"G" Option N/A	"M" Option N/A
NSS6630OP800W	1632	"P" Option N/A	"G" Option N/A	"M" Option N/A
NSS6030OP800W	1620	"P" Option N/A	"G" Option N/A	"M" Option N/A
NSS5430OP800W	1605	"P" Option N/A	"G" Option N/A	"M" Option N/A

Product Features

- 1.125" Tops w/ exposed plywood edge
- Surfaces 66" and over have two horizontal support rods
- Wire trough will be cut into top surface if specified
- Work surface may be connected to end leg, middle leg, case and privacy end panel

Options

Grommets (Standard Location)

- Specify Color and Location (Right/Left/Center) - \$50 ea.
- Black: TM30-R (Right), TM30-L (Left), TM30-C (Center)
 - Silver: TM31-R (Right), TM31-L (Left), TM31-C (Center)
 - White: TM34-R (Right), TM34-L (Left), TM34-C (Center)

Grommets (Non-Standard Location)

- Provide drawing w/ Grommet Location and Specify Color - \$95 ea.
- Black: TM30-NS
 - Silver: TM31-NS
 - White: TM34-NS

Top

- MMB: Markerboard top - \$60

Exposed Plywood Edge

- WEPB: Exposed Plywood Edge w/ Baltic Birch Veneer - n/c
- Only available with WCF - Clear Coat Finish

Plank Match Veneer

Prices below are in addition to "M" product pricing

- RPMV72: 72 x 30 Top: \$ 1,255
- RPMV66: 66 x 30 Top: \$1,225
- RPMV60: 60 x 30 Top: \$1,195
- RPMV54: 54 x 30 Top: \$1,195

2 Select Finish

[Click to view finishes](#)

WEPB

3 Select Edge

[Click to view edges](#)



Exposed Plywood

4 Select Hardware

[Click to view details](#)

Hardware
N/A

NOT SO Square Open

Legs
End Leg

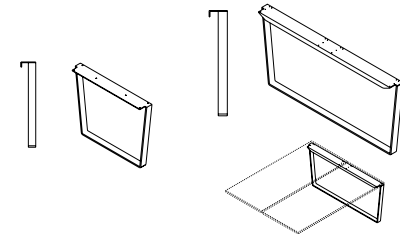

[Click here to view statement of line](#)

1 Select Model

w" x d" x h"
Double leg
61 x 3 x 27.75
Single leg
30 x 3 x 27.75

Weight

Metal Leg			
80	ASB61	1108	
40	ASB30	810	

Product Features

- One half inch thick steel legs have been laser cut and bent to create unique not so square shape
- Specify end legs with single connection and center legs to connect two tops together
- Standard Silver Leg (optional White, Black)
- Top connection of leg is reinforced with turn downs that will keep tops from warping

Options

Cover

- W17: Wire Management cover - \$80 (Attaches to the leg by magnets)

Premium Finish Option

- Specify leg Metal Finish color - \$100 per leg
- MFW: White, MFB: Black

2 Select Finish

[Click to view finishes](#)

Metal Finish
MFS Silver. Additional
Metal Finishes are
available, options

3 Select Edge

[Click to view edges](#)

Edge
N/A

4 Select Hardware

[Click to view details](#)

Hardware
N/A

NOT SO Square Open

Legs
Connecting Leg

[Click here to view statement of line](#)

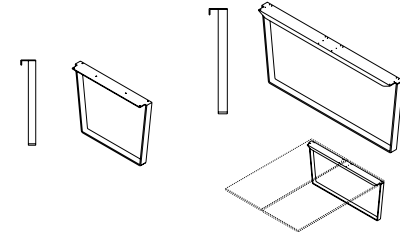

1 Select Model

w" x d" x h"
Double leg
61 x 3 x 27.75

Weight

90

Metal Leg	
ASB61DT	1122

2 Select Finish

[Click to view finishes](#)

Metal Finish
MFS Silver. Additional
Metal Finishes are
available, options

3 Select Edge

[Click to view edges](#)

Edge
N/A

4 Select Hardware

[Click to view details](#)

Hardware
N/A

Product Features

- One half inch thick steel legs have been laser cut and bent to create unique not so square shape
- Specify end legs with single connection and center legs to connect two tops together
- Standard Silver Leg (optional White, Black)
- Top connection of leg is reinforced with turn downs that will keep tops from warping

Options

Cover

- W17: Wire Management cover - \$80 (Attaches to the leg by magnets)

Premium Finish Option

- Specify leg Metal Finish color - \$100 per leg
- MFW: White, MFB: Black

NOT SO Square Open

Adjustable Height Desk And Units
Adjustable Height Desk - With Acrylic Half Modesty Panel

[Click here to view statement of line](#)

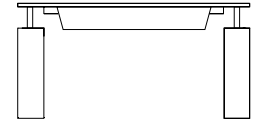
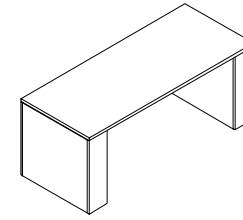

1 Select Model

w" x d" x h"
72 x 30 x 29-48

Weight
340

Standard Veneer Top Standard Veneer Chassis	Premium Veneer Top Premium Veneer Chassis	High Pressure Laminate Top Veneer Chassis	Thermally Fused Laminate Top Thermally Fused Laminate Chassis
"W" option N/A	"P" Option N/A	"G" Option N/A	NSS7230OP730M 6823

2 Select Finish

[Click to view finishes](#)

MAC
MOC
MEC
MGW
MTW
MSW
MWL

3 Select Edge

[Click to view edges](#)



4 Select Hardware

[Click to view details](#)

Hardware
N/A

Product Features

- Acrylic half modesty panel (White)
- Door storage pedestals
- Electronic mechanism with programmable lift
- Max load on frame is 220 lbs
- Metal parts include 5 year warranty
- Motor includes 2 year warranty

Notes

- *Grommets and power pods locations need to be specified on drawings when ordering
- Shipped KD

Options

Accessories

- K28: Articulating Keyboard w/ Mouse Pad - \$390

Desk Light

- LT-BEND: Bend Light - specify location - \$155

Grommets (Standard Location)

- Specify Color and Location Right/Left - \$50 ea.
- Black: TM30-R (Right), TM30-L (Left)
- Silver: TM31-R (Right), TM31-L (Left)
- White: TM34-R (Right), TM34-L (Left)

Grommets (Non-Standard Location)

- Provide drawing w/ Grommet Location and Specify Color - \$95 ea.
- Black: TM30-NS
- Silver: TM31-NS
- White: TM34-NS

Modesty

- DM: Delete Modesty Option - Deduct \$350

NOT SO Square Open

Adjustable Height Desk And Units
Adjustable Height Mechanism

[Click here to view statement of line](#)

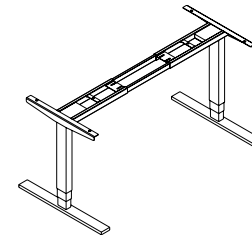

1 Select Model

w" x d" x h"
54-72 x 30 x 30-48

Weight

160

Component

NSS5430OP702 3752

Product Features

- Electronic mechanism with programmable lift
- Max load on frame is 220 lbs
- Metal parts include 5 year warranty
- Motor includes 2 year warranty

Options

Base

- MFB: Black Metal Finish - n/c
- MFW: White Metal Finish - n/c

2 Select Finish

[Click to view finishes](#)

Metal Finish
MFS Silver, MFW White,
MFB White

3 Select Edge

[Click to view edges](#)

Edge
N/A

4 Select Hardware

[Click to view details](#)

Hardware
N/A

NOT SO Square Open

Adjustable Height Desk And Units
Single Leg Pedestal

[Click here to view statement of line](#)

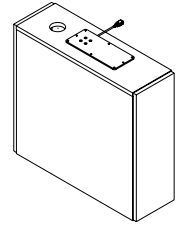
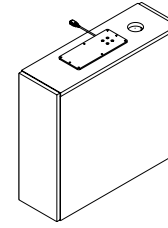

1 Select Model

w" x d" x h"
Left Hinge Storage
8 x 30 x 28.875
Right Hinge Storage
8 x 30 x 28.875

Weight

	Standard Veneer Top Standard Veneer Chassis	Premium Veneer Top Premium Veneer Chassis	High Pressure Laminate Top Veneer Chassis	Thermally Fused Laminate Top Thermally Fused Laminate Chassis
50	"W" option N/A	"P" Option N/A	"G" Option N/A	NSS3009OP603M 2845
50	"W" option N/A	"P" Option N/A	"G" Option N/A	NSS3009OP604M 2845
				MAC MOC MEC MGW MTW MSW MWL
				Edge N/A
				Hardware N/A

Product Features

- Electronic mechanism with programmable lift
- Max load on frame is 175 lbs per leg
- Metal parts include 5 year warranty
- Motor includes 2 year warranty
- Single leg features left and right hinge cabinet
- Cabinet door is touch latch

Notes

- Interior dimensions of storage area: 22" H, 12.75" D, 7.75" W

2 Select Finish

[Click to view finishes](#)

3 Select Edge

[Click to view edges](#)

4 Select Hardware

[Click to view details](#)

NOT SO Square Open

Adjustable Height Desk And Units
Double Leg Pedestal

[Click here to view statement of line](#)

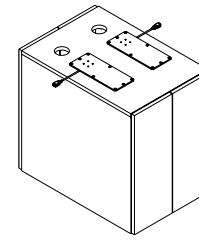

1 Select Model

w" x d" x h"
18 30 x 28.875 85

Weight

Standard Veneer Top Standard Veneer Chassis	Premium Veneer Top Premium Veneer Chassis	High Pressure Laminate Top Veneer Chassis	Thermally Fused Laminate Top Thermally Fused Laminate Chassis
"W" option N/A	"P" Option N/A	"G" Option N/A	NSS3018OP703M 4341
			MAC MOC MEC MGW MTW MSW MWL
			Edge N/A
			Hardware N/A

Product Features

- Electronic mechanism with programmable lift
- Max load on frame is 175 lbs per leg
- Metal parts include 5 year warranty
- Motor includes 2 year warranty
- Single leg features left and right hinge cabinet
- Cabinet door is touch latch

2 Select Finish

[Click to view finishes](#)

3 Select Edge

[Click to view edges](#)

4 Select Hardware

[Click to view details](#)

NOT SO Square Open

Storage Tower Kits - Kit #1
 48" H Bridge Unit, Open Unit, Overhead W/ 2 Sided Access

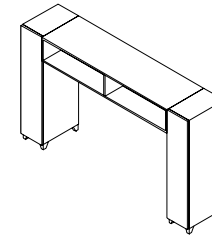

[Click here to view statement of line](#)

1 Select Model

w" x d" x h"	Weight
Storage Left Hinge (1) 10 x 18 x 48	75
Storage Right Hinge (1) 10 x 18 x 48	75
Overhead Open Storage - 2 Sided Access (1) 61 x 18 x 10	90

Standard Veneer Top Standard Veneer Chassis	Premium Veneer Top Premium Veneer Chassis	High Pressure Laminate Top Veneer Chassis	Thermally Fused Laminate Top Thermally Fused Laminate Chassis
"W" option N/A	"P" Option N/A	"G" Option N/A	NSS1018OP709M 1065
"W" option N/A	"P" Option N/A	"G" Option N/A	NSS1018OP710M 1065
"W" option N/A	"P" Option N/A	"G" Option N/A	NSS6118OP711M 863

Product Features

- Kit Consists of:
- NSS1018OP709 Storage left hinge (1)
 - NSS1018OP710 Storage right hinge (1)
 - NSS6118OP711 Overhead open storage - 2 sided access (1)
 - Standard Silver Feet and Leg (optional White, Black)
 - Touch latch

Options

- Legs**
- D8: Delete Legs (extended fronts to the floor) - n/c
- Premium Finish Option**
- Specify foot Metal Finish color - \$30 per foot
 - MFB: Black, MFW: White

2 Select Finish

[Click to view finishes](#)

Metal Finish
 MFS Silver. Additional
 Metal Finishes are
 available, options

MAC
 MOC
 MEC
 MGW
 MTW
 MSW
 MWL

3 Select Edge

[Click to view edges](#)

Edge
 N/A

4 Select Hardware

[Click to view details](#)

Hardware
 N/A

NOT SO Square Open

Storage Tower Kits - Kit #2

48" H Bridge Unit, Open Unit, Overhead W/ 1 Sided Access

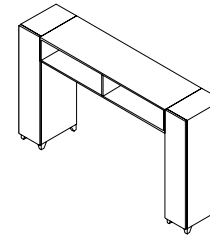

[Click here to view statement of line](#)

1 Select Model

w" x d" x h"

Storage Left Hinge (1)

10 x 18 x 48

Weight

75

"W" option N/A

Storage Right Hinge (1)

10 x 18 x 48

75

"W" option N/A

Overhead Open Storage - 1 Sided Access (1)

61 x 18 x 10

90

"W" option N/A

Standard Veneer Top Standard Veneer Chassis	Premium Veneer Top Premium Veneer Chassis	High Pressure Laminate Top Veneer Chassis	Thermally Fused Laminate Top Thermally Fused Laminate Chassis
--	--	--	--

"P" Option N/A

"G" Option N/A

NSS1018OP709M 1065

"P" Option N/A

"G" Option N/A

NSS1018OP710M 1065

"P" Option N/A

"G" Option N/A

NSS6118OP731M 863

Product Features

Kit Consists of:

- NSS1018OP709 Storage left hinge (1)
- NSS1018OP710 Storage right hinge (1)
- NSS6118OP731 Overhead open storage - 1 sided access (1)
- Standard Silver Feet and Leg (optional White, Black)
- Touch latch

2 Select Finish

[Click to view finishes](#)

Metal Finish

MFS Silver. Additional

Metal Finishes are available, options

MAC
MOC
MEC
MGW
MTW
MSW
MWL

3 Select Edge

[Click to view edges](#)

Edge
N/A

4 Select Hardware

[Click to view details](#)

Hardware
N/A

Options

Legs

- D8: Delete Legs (extended fronts to the floor) - n/c

Premium Finish Option

- Specify foot Metal Finish color - \$30 per foot
- MFB: Black, MFW: White

NOT SO Square Open

Storage Tower Kits - Kit #3

48" H Bridge Unit, Connecting Surface, Overhead W/ 2 Sided Access

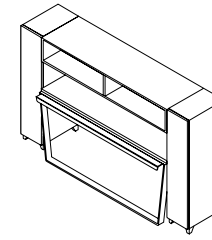

[Click here to view statement of line](#)

1 Select Model

w" x d" x h"

	Weight	Standard Veneer Top Standard Veneer Chassis	Premium Veneer Top Premium Veneer Chassis	High Pressure Laminate Top Veneer Chassis	Thermally Fused Laminate Top Thermally Fused Laminate Chassis
Storage Left Hinge (1) 10 x 18 x 48	75	"W" option N/A	"P" Option N/A	"G" Option N/A	NSS1018OP709M 1065
Storage Right Hinge (1) 10 x 18 x 48	75	"W" option N/A	"P" Option N/A	"G" Option N/A	NSS1018OP710M 1065
Overhead Open Storage - 2 Sided Access (1) 61 x 18 x 10	90	"W" option N/A	"P" Option N/A	"G" Option N/A	NSS6118OP711M 863
Connection Surface (1) 61 x 18 x 1.125	45	"W" option N/A		"G" Option N/A	NSS6118OP701M 530
Connecting Leg 61 x 3 x .5	90	"W" Option N/A		"G" Option N/A	ASB61DT 1122

2 Select Finish

[Click to view finishes](#)

Metal Finish
MFS Silver. Additional
Metal Finishes are
available, options

3 Select Edge

[Click to view edges](#)

4 Select Hardware

[Click to view details](#)

Product Features

Kit Consists of:

- NSS1018OP709 Storage left hinge (1)
- NSS1018OP710 Storage right hinge (1)
- NSS6118OP701 Connecting surface (1)
- NSS6118OP711 Overhead open storage - 2 sided access (1)
- ASB61DT Connecting Leg (2)
- Standard Silver Feet (optional White, Black)
- Touch latch

Notes

- Clearance from connecting surface to bottom of overhead equals 9.25" height

Options

Legs

- D8: Delete Legs (extended fronts to the floor) - n/c

Premium Finish Option

- Specify foot/leg Metal Finish color - \$30 per foot, \$100 per leg
- MFB: Black, MFW: White

MAC
MOC
MEC
MGW
MTW
MSW
MWL

Edge
N/A

Hardware
N/A

NOT SO Square Open

Storage Tower Kits - Kit #4

48" H Bridge Unit, Connecting Surface, Overhead W/ 1 Sided Access

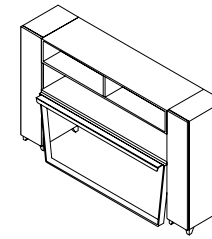

[Click here to view statement of line](#)

1 Select Model

w" x d" x h"

	Weight	Standard Veneer Top Standard Veneer Chassis	Premium Veneer Top Premium Veneer Chassis	High Pressure Laminate Top Veneer Chassis	Thermally Fused Laminate Top Thermally Fused Laminate Chassis
Storage Left Hinge (1) 10 x 18 x 48	75	"W" option N/A	"P" Option N/A	"G" Option N/A	NSS1018OP709M 1065
Storage Right Hinge (1) 10 x 18 x 48	75	"W" option N/A	"P" Option N/A	"G" Option N/A	NSS1018OP710M 1065
Overhead Open Storage - 1 Sided Access (1) 61 x 18 x 10	90	"W" option N/A	"P" Option N/A	"G" Option N/A	NSS6118OP731M 863
Connection Surface (1) 61 x 18 x 1.125	45	"W" option N/A		"G" Option N/A	NSS6118OP701M 530
Connecting Leg 61 x 3 x .5	90	"W" Option N/A		"G" Option N/A	ASB61DT 1122

2 Select Finish

[Click to view finishes](#)

Metal Finish
MFS Silver. Additional
Metal Finishes are
available, options

MAC
MOC
MEC
MGW
MTW
MSW
MWL

3 Select Edge

[Click to view edges](#)

Edge
N/A

4 Select Hardware

[Click to view details](#)

Hardware
N/A

Product Features

Kit Consists of:

- NSS1018OP709 Storage left hinge (1)
- NSS1018OP710 Storage right hinge (1)
- NSS6118OP701 Connecting surface (1)
- NSS6118OP731 Overhead open storage - 1 sided access (1)
- ASB61DT Connecting Leg (1)
- Standard Silver Feet (optional White, Black)
- Touch latch

Notes

- Clearance from connecting surface to bottom of overhead equals 9.25" height

Options

Legs

- D8: Delete Legs (extended fronts to the floor) - n/c

Premium Finish Option

- Specify foot/leg Metal Finish color - \$30 per foot, \$100 per leg
- MFB: Black, MFW: White

NOT SO Square Open

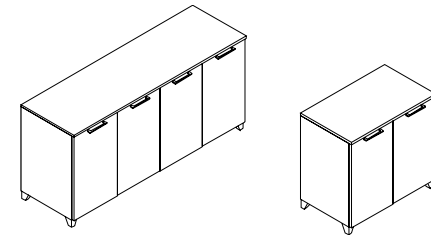

End Cabinets
End Cabinet / Door Storage

[Click here to view statement of line](#)



1 Select Model

w" x d" x h"	Weight
4 Door 61 x 18 x 28.875	210
2 Door 30 x 18 x 28.875	105

Standard Veneer Top Standard Veneer Chassis	Premium Veneer Top Premium Veneer Chassis	High Pressure Laminate Top Veneer Chassis	Thermally Fused Laminate Top Thermally Fused Laminate Chassis
"W" option N/A	"P" Option N/A	"G" Option N/A	NSS6118OP712M 2031
"W" option N/A	"P" Option N/A	"G" Option N/A	NSS3018OP712M 1210
			MAC MOC MEC MGW MTW MSW MWL
			Edge N/A
			 

Product Features

- Adjustable laminate shelf per door section
- Standard Silver Feet (optional White, Black)
- Flat on ends

Options

Door

- D7: Delete storage doors (pair) - Deduct \$100
- D9SC: Soft Close Door Hinges - \$20 per door

Legs

- D8: Delete Legs (extended fronts to the floor) - n/c

Premium Finish Option

- Specify foot Metal Finish color - \$30 per foot
- MFB: Black, MFW: White

2 Select Finish

[Click to view finishes](#)

Metal Finish
MFS Silver. Additional
Metal Finishes are
available, options

3 Select Edge

[Click to view edges](#)

4 Select Hardware

[Click to view details](#)

NOT SO Square Open

End Cabinets

End Cabinet / 2 Drawer Lateral File

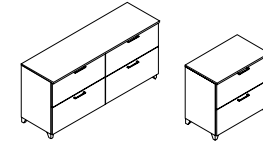

[Click here to view statement of line](#)

1 Select Model

w" x d" x h"	Weight
4 Drawer 61 x 18 x 28.875	240
2 Drawer 30 x 18 x 28.875	120

Standard Veneer Top Standard Veneer Chassis	Premium Veneer Top Premium Veneer Chassis	High Pressure Laminate Top Veneer Chassis	Thermally Fused Laminate Top Thermally Fused Laminate Chassis
"W" option N/A	"P" Option N/A	"G" Option N/A	NSS6118OP714M 2795
"W" option N/A	"P" Option N/A	"G" Option N/A	NSS3018OP714M 1529

Product Features

- File drawers extend 100% with cushion in-out stops - full access
- File drawers reinforced for heavy storage capacity
- Features ball bearing suspensions, suspensions are full extension
- Standard Silver Feet (optional White, Black)

Options

Drawer

- P33: Wood Drawer Upgrade - \$45 per drawer

Legs

- D8: Delete Legs (extended fronts to the floor) - n/c

Premium Finish Option

- Specify foot Metal Finish color - \$30 per foot
- MFB: Black, MFW: White

2 Select Finish

[Click to view finishes](#)

Metal Finish

MFS Silver. Additional Metal Finishes are available, options

MAC
MOC
MEC
MGW
MTW
MSW
MWL

3 Select Edge

[Click to view edges](#)

Edge
N/A

4 Select Hardware

[Click to view details](#)



PL-115 Matte Black
PL-116 Matte Nickel



PL-210 Anodized
Aluminum

NOT SO Square Open

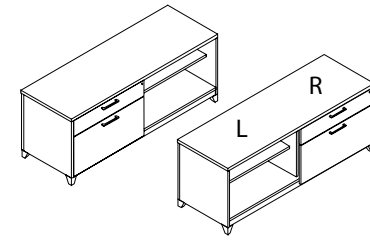

Benches And Mobile Peds
Benches - Box/File Storage Right And Left



[Click here to view statement of line](#)

1 Select Model

w" x d" x h"	Weight
Left Box/File	
70.5 x 18 x 23	236
58.5 x 18 x 23	210
Right Box/File	
70.5 x 18 x 23	225
58.5 x 18 x 23	210

	Standard Veneer Top Standard Veneer Chassis	Premium Veneer Top Premium Veneer Chassis	High Pressure Laminate Top Veneer Chassis	Thermally Fused Laminate Top Thermally Fused Laminate Chassis
	"W" option N/A	"P" Option N/A	"G" Option N/A	NSS7018CA064M 2509
	"W" option N/A	"P" Option N/A	"G" Option N/A	NSS5818CA064M 2356
	"W" option N/A	"P" Option N/A	"G" Option N/A	NSS7018CA065M 2509
	"W" option N/A	"P" Option N/A	"G" Option N/A	NSS5818CA065M 2356
				MAC
				MOC
				MEC
				MGW
				MTW
				MSW
				MWL
				Edge N/A
				 

Product Features

- File drawers extend 100% with cushion in-out stops - full access
- File drawers reinforced for heavy storage capacity
- Full extension drawers - locking
- Standard Silver Feet (optional White, Black)

Notes

- Specify bench runoff support when using w/ work surface top - end leg must be specified
- 58.5" W unit will receive a 29" W cushion and a 70.5" W unit will receive a 35" W cushion.

Options

Cushion

- BC18: Bench Cushion
- Specify location, number of cushions and fabric grade.
- Cushions sold individually w/a max width 35" (to match storage section depth). 29" W requires .75 yd, 35" W requires 1 yd.

Drawer

- P33: Wood Drawer Upgrade - \$45 per drawer

Legs

- D8: Delete Legs (extended fronts to the floor) - n/c

Support

- 23BRT30: Bench Runoff Support - \$205

Premium Finish Option

- MFB: Black Metal Finish - \$30 per foot
- MFW: White Metal Finish - \$30 per foot

BC18 Cushion fabric grades.

COM	COL	1	2	3
261	280	298	316	334
4	5	6	7	8
352	370	388	406	424
9	10	11/ L1	12	13/ L2
442	460	478	496	532

2 Select Finish

[Click to view finishes](#)

Metal Finish

MFS Silver: Additional
Metal Finishes are
available, options

3 Select Edge

[Click to view edges](#)

4 Select Hardware

[Click to view details](#)

NOT SO Square Open

Benches And Mobile Peds
 Benches - Box File/Storage Right And Left

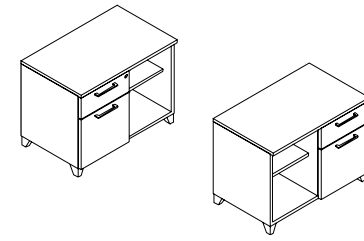

[Click here to view statement of line](#)

1 Select Model

w" x d" x h"
 Left Box/File 29 x 18 x 22
 Right Box/File 29 x 18 x 22

Weight	Standard Veneer Top Standard Veneer Chassis	Premium Veneer Top Premium Veneer Chassis	High Pressure Laminate Top Veneer Chassis	Thermally Fused Laminate Top Thermally Fused Laminate Chassis
110	"W" option N/A	"P" Option N/A	"G" Option N/A	NSS2918OP707M 1441
110	"W" option N/A	"P" Option N/A	"G" Option N/A	NSS2918OP706M 1441

2 Select Finish

[Click to view finishes](#)

Metal Finish
 MFS Silver. Additional
 Metal Finishes are
 available, options

MAC
 MOC
 MEC
 MGW
 MTW
 MSW
 MWL

3 Select Edge

[Click to view edges](#)

Edge
 N/A

4 Select Hardware

[Click to view details](#)

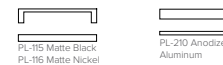

Product Features

- File drawers extend 100% with cushion in-out stops - full access
- File drawers reinforced for heavy storage capacity
- Full extension drawers - locking
- Standard Silver Feet (optional White, Black)

Notes

- Specify bench runoff support when using w/ work surface top - end leg must be specified

Options

Cushion

- BC18: Bench Cushion
- Specify location, number of cushions and fabric grade.
- Cushions sold individually w/a max width 35" (to match storage section depth). 29" W requires .75 yd, 35" W requires 1 yd.

Drawer

- P33: Wood Drawer Upgrade - \$45 per drawer

Support

- 23BRT30: Bench Runoff Support - \$205

Premium Finish Option

- MFB: Black Metal Finish - \$30 per foot
- MFW: White Metal Finish - \$30 per foot

BC18 Cushion fabric grades.

COM	COL	1	2	3
270	289	298	312	326
4	5	6	7	8
340	354	368	382	396
9	10	11/ L1	12	13/ L2
410	424	438	452	480

NOT SO Square Open

Benches And Mobile Peds
Mobile Peds - Box Box File Lock, Casters

[Click here to view statement of line](#)

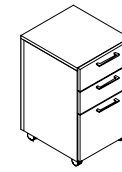

Box/Box/File
PD424

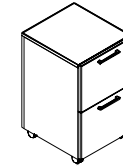

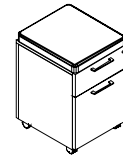

File/File
PD425



Box/File W/ BC18
Cushion Option
PD423

1 Select Model

w" x d" x h"	Weight
16 x 18 x 27	90
16 x 18 x 27	90
16 x 18 x 23	80

Standard Veneer Top Standard Veneer Chassis	Premium Veneer Top Premium Veneer Chassis	High Pressure Laminate Top Veneer Chassis	Thermally Fused Laminate Top Thermally Fused Laminate Chassis
"W" option N/A	"P" Option N/A	"G" Option N/A	NSS1618PD424M 1089
"W" option N/A	"P" Option N/A	"G" Option N/A	NSS1618PD425M 1089
"W" option N/A	"P" Option N/A	"G" Option N/A	NSS1618PD423M 979
			MAC
			MOC
			MEC
			MGW
			MTW
			MSW
			MWL
			Edge N/A
			 

Product Features

- File drawers extend 100% with cushion in-out stops - full access
- File drawers reinforced for heavy storage capacity
- Full extension drawers - locking
- Locking black casters are standard

Options

Caster

- CST10: Silver caster upgrade - \$100

Cushion

- BC16: Bench Cushion
- Specify fabric grade (1 yd. required)
- Cushion can only be added to PD423

Drawer

- P33: Wood Drawer Upgrade - \$45 per drawer

Premium Finish Option

- MFB: Black Metal Finish - \$30 per foot
 - MFW: White Metal Finish - \$30 per foot
- BC16 Cushion fabric grades for PD423.

COM	COL	1	2	3
249	N/A	285	303	321
4	5	6	7	8
339	357	375	393	411
9	10	11/ L1	12	13/ L2
429	447	465	483	519

2 Select Finish

[Click to view finishes](#)

Metal Finish
MFS Silver: Additional
Metal Finishes are
available, options

3 Select Edge

[Click to view edges](#)

4 Select Hardware

[Click to view details](#)

NOT SO Square Open

Shared Storage
Shared Door Storage

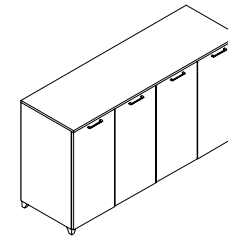

[Click here to view statement of line](#)



1 Select Model

w" x d" x h"
75.5 x 24 x 42

Weight
320

Standard Veneer Top Standard Veneer Chassis	Premium Veneer Top Premium Veneer Chassis	High Pressure Laminate Top Veneer Chassis	Thermally Fused Laminate Top Thermally Fused Laminate Chassis
"W" option N/A	"P" Option N/A	"G" Option N/A	NSS7524OP724M 3317
			MAC MOC MEC MGW MTW MSW MWL  Flat  PL-115 Matte Black PL-116 Matte Nickel  PL-210 Anodized Aluminum

Product Features

- Sections standard w/ adjustable shelf
- Standard Silver Feet (optional White, Black)

Options

- Door**
- D9SC: Soft Close Door Hinges - \$20 per door
- Refrigerator**
- REF-02: Refrigerator Insert Kit - \$220
 - Specify left or right location
- Trash Can**
- TRC230: Trash Can Insert - (2) 30 gal containers - \$495
 - Specify left or right location
- Premium Finish Option**
- MFB: Black Metal Finish - \$30 per foot
 - MFW: White Metal Finish - \$30 per foot

2 Select Finish

[Click to view finishes](#)

Metal Finish
MFS Silver: Additional
Metal Finishes are
available, options

3 Select Edge

[Click to view edges](#)

4 Select Hardware

[Click to view details](#)

NOT SO Square Open

Bar Height Table

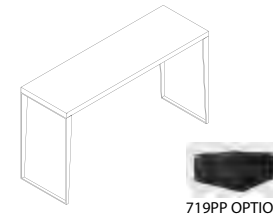

[Click here to view statement of line](#)

1 Select Model

w" x d" x h"
75.5 x 24 x 42
50.5 x 24 x 42

Weight

Standard Veneer Top Standard Veneer Chassis	Premium Veneer Top Premium Veneer Chassis	High Pressure Laminate Top Veneer Chassis	Thermally Fused Laminate Top Thermally Fused Laminate Chassis
"W" option N/A "W" option N/A	"P" Option N/A "P" Option N/A	NSS7624OP719 3340 NSS5124OP719 3082	"M" Option N/A "M" Option N/A
		GHC GOC GCM GEW GWL GSTV +10% GSLV +10%	
		Edge N/A	
		Hardware N/A	

Product Features

- No shiny laminates can be used
- Standard Silver Base (optional White, Black)
- Tops are only available in DARRAN standard HPL
- Tops may be ganged lengthwise together
- Two standard lengths and one standard width offered

Options

Accessories

- 719WM: Wire Manager for Stand Up Table - \$70
- 719PP: Power Pod - 2 Plug (Black) - \$120

Premium Finish Option

- Specify base Metal Finish color - \$160 per base
- MFB: Black, MFW: White

2 Select Finish

[Click to view finishes](#)

Metal Finish
MFS Silver. Additional
Metal Finishes are
available, options

3 Select Edge

[Click to view edges](#)

4 Select Hardware

[Click to view details](#)

NOT SO Square Open

Bar Height Table And Bar Stools
Short Back Bar Stool

[Click here to view statement of line](#)

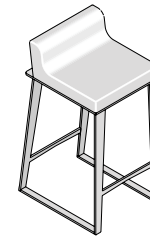

1 Model NSS3016OP720

w" x d" x h"
16 x 16 x 30
Arm Height -
Seat Height 30
Inside Seat Depth 14
Inside Seat Width 16

COM	COL	1	2	3	4	5	6	7	8	9	10	11/L1	12	13/L2
1542	1565	1588	1611	1634	1657	1680	1703	1726	1749	1772	1795	1818	1841	1887

Upholstery Requirements
Fabric yds: 1.25 Leather Sq. Ft.: 20
Carton Weight: 30

2 Select Finish

[Click to view finishes](#)

Metal Finish
MFS Silver. Additional Metal Finishes are available, options

3 Combination Fabrics

[Click to view finishes](#)

Combination
Fabric Option
Not Available

Product Features

- A special sewing technique is available "rail" tufting at an upcharge with a longer lead time
- Bar Stools have nylon protectors on foot rails and glides
- Standard Silver Base (optional White, Black)

Options

Tufting

- RT01: Rail Tuft - \$215
Yardage required will increase to 1.75 yards

Premium Finish Option

- Specify base Metal Finish color - \$160 per base
- MFB: Black, MFW: White

NOT SO Square Open

Bar Height Table And Bar Stools
Backless Bar Stool

[Click here to view statement of line](#)

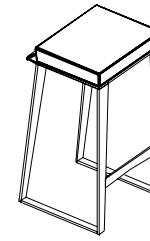

1 Model NSS30160P721

w" x d" x h"
16 x 16 x 30
Arm Height -
Seat Height 30
Inside Seat Depth 16
Inside Seat Width 16

COM	COL	1	2	3	4	5	6	7	8	9	10	11/L1	12	13/L2
1390	1409	1427	1446	1465	1484	1503	1522	1541	1560	1579	1598	1617	1639	1674

Upholstery Requirements
Fabric yds: 1 Leather Sq. Ft.: 18
Carton Weight: 30

2 Select Finish

[Click to view finishes](#)

Metal Finish
MFS Silver. Additional Metal Finishes are available, options

3 Combination Fabrics

[Click to view finishes](#)

Combination
Fabric Option
Not Available

Product Features

- A special sewing technique is available "rail" tufting at an upcharge with a longer lead time
- Bar Stools have nylon protectors on foot rails and glides
- Standard Silver Base (optional White, Black)

Options

Tufting

- RT01: Rail Tuft - \$160
Yardage required will increase to 1.75 yards

Premium Finish Option

- Specify base Metal Finish color - \$160 per base
- MFB: Black, MFW: White

NOT SO Square Open

Fabric Privacy And Modesty Tack Panels
24" High Fabric Panels

[Click here to view statement of line](#)

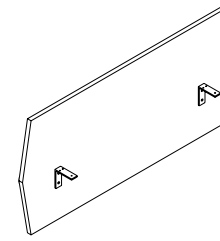

1 Select Model

w" x d" x h"
For 72" Work surfaces
48 x .875 x 24
1.5 yd required
27 Square Feet

Weight

14

Component			
NSS4824OP718			

Product Features

- Fabric tack panels are double sided with angled sides
- Panels are mounted between desks
- Specify one for each adjustable table top
- Specify only one between two stationary desks
- Specify panel that fits work surface top size

Notes

- Gives Privacy Approximately 12" Above And 12" Below Work surface
- Tackboards are not available in COL, Leather or Vinyl materials. FABRIC ONLY

NSS4824OP718 Fabric grades.

COM	COL	1	2	3
477	N/A	533	560	587
4	5	6	7	8
614	641	668	695	722
9	10	11/ L1	12	13/ L2
749	776	803	830	884

2 Select Finish

[Click to view finishes](#)

Finish N/A

3 Select Edge

[Click to view edges](#)

Edge
N/A

4 Select Hardware

[Click to view details](#)

Hardware
N/A

NOT SO Square Open

Fabric Privacy And Modesty Tack Panels
24" High Fabric Panels

[Click here to view statement of line](#)

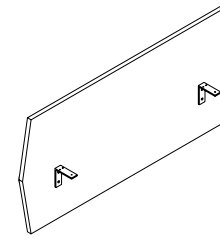

1 Select Model

w" x d" x h"
For 60" or 66" Work surfaces
41 x .875 x 24
1.25 yd required
22.5 Square Feet

Weight

12

Component			
NSS4124OP718			

Product Features

- Fabric tack panels are double sided with angled sides
- Panels are mounted between desks
- Specify one for each adjustable table top
- Specify only one between two stationary desks
- Specify panel that fits work surface top size

Notes

- Gives Privacy Approximately 12" Above And 12" Below Work surface
- Tackboards are not available in COL, Leather or Vinyl materials. FABRIC ONLY

NSS4124OP718 Fabric grades.

COM	COL	1	2	3
449	N/A	495	518	541
4	5	6	7	8
564	587	610	633	656
9	10	11/ L1	12	13/ L2
679	702	725	748	794

2 Select Finish

[Click to view finishes](#)

Finish N/A

3 Select Edge

[Click to view edges](#)

Edge
N/A

4 Select Hardware

[Click to view details](#)

Hardware
N/A

NOT SO Square Open

Fabric Privacy And Modesty Tack Panels
24" High Fabric Panels

[Click here to view statement of line](#)

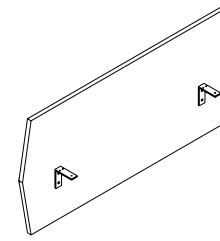

1 Select Model

w" x d" x h"
For 54" Work surfaces
30 x .875 x 24
1 yd required
18 Square Feet

Weight

Component	
8	NSS3024OP718

2 Select Finish

[Click to view finishes](#)

Finish N/A

3 Select Edge

[Click to view edges](#)

Edge
N/A

4 Select Hardware

[Click to view details](#)

Hardware
N/A

Product Features

- Fabric tack panels are double sided with angled sides
- Panels are mounted between desks
- Specify one for each adjustable table top
- Specify only one between two stationary desks
- Specify panel that fits work surface top size

Notes

- Gives Privacy Approximately 12" Above And 12" Below Work surface
- Tackboards are not available in COL, Leather or Vinyl materials. FABRIC ONLY

NSS3024OP718 Fabric grades.

COM	COL	1	2	3
440	N/A	476	494	512
4	5	6	7	8
530	548	566	584	602
9	10	11/ L1	12	13/ L2
620	638	656	674	710

NOT SO Square Open

Acrylic Privacy/Modesty Panels
Acrylic Privacy/Modesty Panels

[Click here to view statement of line](#)

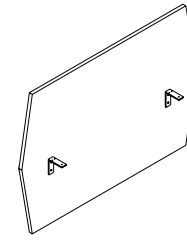

1 Select Model

w" x d" x h"	Weight	Component
For 72" Work surfaces 48 x .5 x 36	30	NSS4836OP717 1173
For 60" or 66" Work surfaces 41 x .5 x 36	26	NSS4136OP717 1028
For 54" Work surfaces 30 x .5 x 36	19	NSS3036OP717 742
For 72" Work surfaces 48 x .5 x 24	20	NSS4824OP717 784
For 60" or 66" Work surfaces 41 x .5 x 24	17	NSS4124OP717 711
For 54" Work surfaces 30 x .5 x 24	11	NSS3024OP717 566

2 Select Finish

[Click to view finishes](#) Finish N/A

3 Select Edge

[Click to view edges](#) Edge N/A

4 Select Hardware

[Click to view details](#) Hardware N/A

Product Features

- 24" High panel enables approx. 12" of privacy above the work surface and 12" below
- 36" High panel enables approx. 18" of privacy above the work surface and 18" below
- Acrylic panels are opaque white
- Specify one for each adjustable table top
- Specify only one between two stationary desks
- Specify panel that fits top size noted

NOT SO Square Open

Acrylic Privacy/Modesty Panels
Half Acrylic Privacy Panel

[Click here to view statement of line](#)

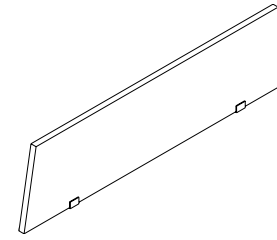

1 Select Model

w" x d" x h"	Weight	Component
For 72" Work surfaces		
48 x .5 x 18	30	NSS4818OP717 645
For 60" or 66" Work surfaces		
41 x .5 x 18	26	NSS4118OP717 580
For 54" Work surfaces		
30 x .5 x 18	19	NSS3018OP717 452
For 72" Work surfaces		
48 x .5 x 12	10	NSS4812OP717 501
For 60" or 66" Work surfaces		
41 x .5 x 12	9	NSS4112OP717 443
For 54" Work surfaces		
30 x .5 x 12	7	NSS3012OP717 326

2 Select Finish

[Click to view finishes](#) Finish N/A

3 Select Edge

[Click to view edges](#) Edge N/A

4 Select Hardware

[Click to view details](#) Hardware N/A

Product Features

- 12" High panel only provides above surface privacy
- 18" High panel only provides above surface privacy
- Acrylic panels are opaque white
- End panel attaches to end of table with end leg
- End panels used to end run of units for privacy
- Panels are mounted between desks
- Specify one for each adjustable table top
- Specify only one between two stationary desks
- Specify panel that fits top size noted

NOT SO Square Open

Acrylic Privacy/Modesty Panels
Overhead Privacy Panel

[Click here to view statement of line](#)

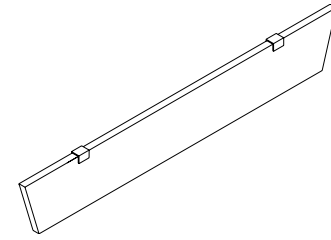

1 Select Model

w" x d" x h"
Mounted to Overhead
48 x .5 x 7

Weight

5

Component

NSS4807OP717 363

Product Features

- Provides privacy on each side of the overhead

2 Select Finish

[Click to view finishes](#)

Finish N/A

3 Select Edge

[Click to view edges](#)

Edge
N/A

4 Select Hardware

[Click to view details](#)

Hardware
N/A

NOT SO Square Open

Ultraclear Glass Privacy/Modesty Panels
12" High Glass Panels

[Click here to view statement of line](#)

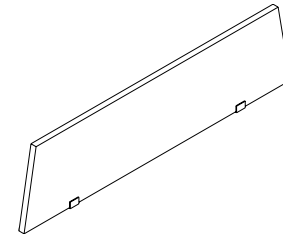

1 Select Model

w" x d" x h"

	Weight	Component	
30 x 12	20	NSS3012OP729	1483
36 x 12	22	NSS3612OP729	1654
41 x 12	24	NSS4112OP729	1833
48 x 12	26	NSS4812OP729	2027

Product Features

- 1/2" Thick clear glass top with flat polished edges

2 Select Finish

[Click to view finishes](#)

Finish N/A

3 Select Edge

[Click to view edges](#)

Edge
N/A

4 Select Hardware

[Click to view details](#)

Hardware
N/A

NOT SO Square Open

Ultraclear Glass Privacy/Modesty Panels
18" High Glass Panels

[Click here to view statement of line](#)

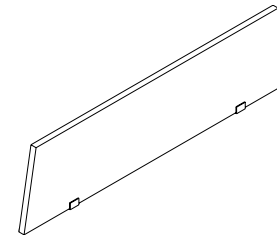

1 Select Model

w" x d" x h"

Weight	Component
30 x 18	24 NSS3018OP729 1750
36 X 18	29 NSS3618OP729 2089
41 X 18	34 NSS4118OP729 2254
48 X 18	39 NSS4818OP729 2418

Product Features

- 1/2" Thick clear glass top with flat polished edges

2 Select Finish

[Click to view finishes](#)

Finish N/A

3 Select Edge

[Click to view edges](#)

Edge
N/A

4 Select Hardware

[Click to view details](#)

Hardware
N/A



COMPUTER SUPPORT
single monitor arm

COMPUTER SUPPORT
double monitor arm

COMPUTER SUPPORT
triple monitor arm

COMPUTER SUPPORT
quadruple monitor arm

Style Number	List Price
MA1	280

Style Number	List Price
MA2	450

Style Number	List Price
MA3	530

Style Number	List Price
MA4	705

Specifications

- Available in black or silver
- Desk clamp and mounting included
- Easy assembly and flexibility
- Elastic painting process for a durable and beautiful finish
- Gas spring tension adjustment for counter-balance height adjustment for monitors 1-8 KG
- Gas spring tested to 50,000 repetitions
- Hidden cable management

Specifications

- Available in black or silver
- Desk clamp and mounting included
- Easy assembly and flexibility
- Elastic painting process for a durable and beautiful finish
- Gas spring tension adjustment for counter-balance height adjustment for monitors 1-8 KG
- Gas spring tested to 50,000 repetitions
- Hidden cable management

Specifications

- Available in black or silver
- Desk clamp and mounting included
- Easy assembly and flexibility
- Elastic painting process for a durable and beautiful finish
- Gas spring tension adjustment for counter-balance height adjustment for monitors 1-8 KG
- Gas spring tested to 50,000 repetitions
- Hidden cable management

Specifications

- Available in black
- Desk clamp and mounting included
- Easy assembly and flexibility
- Elastic painting process for a durable and beautiful finish
- Gas spring tension adjustment for counter-balance height adjustment for monitors 1-8 KG
- Gas spring tested to 50,000 repetitions
- Hidden cable management

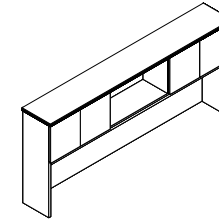
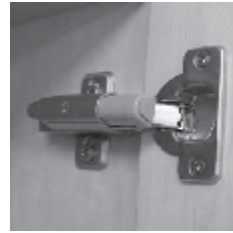
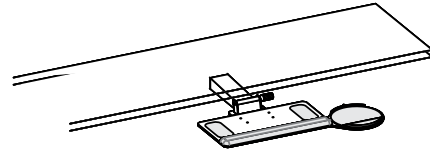
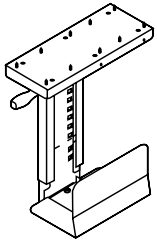

COMPUTER SUPPORT
cpu retractable cradle

COMPUTER SUPPORT
articulating keyboard tray

DOOR MODIFICATIONS
soft close door hinge

DOOR MODIFICATIONS
delete doors

Style Number	List Price
K18	205

Style Number	List Price
Factory Installed	
K28	390
Field Installed	
K28F	415

Style Number	List Price
D9SC	20 Per door

Style Number	List Price
D6	N/C

Specifications

- Black Metal CPU Carriage
- Full 360° swivel capability allows easy access to rear of CPU for cables / wires
- Track allows 8- 1/2" extension
- Width Adjustment 5-1/2" to 9-1/4"
- Height adjustment 14- 5/8" to 20- 1/2"
- Black epoxy finish

Notes
- Factory Installed

Specifications

- Adjusts effortlessly - A simple one-handed motion allows the keyboard to be repositioned instantly, without the use of locks or levers
- Encourages low-risk postures - Maximizes adjustability within a safe operating range.
- Will last a lifetime - Exceeds all applicable BIFMA Standards and comes with a lifetime guarantee.

Notes
- Available on: Freestanding Desk
- Factory Installed (standard)
- FIELD INSTALL - \$395

Specifications

- Snap onto standard door hinge
- Requires (2) per door
- Max door height 43"
- Factory installed where specified
- Individually shipped for field installation

Notes
- Specify Each Item To Have Slow Close Feature

Specifications

- Standard Door overheads and cabinets can have door deleted for open access. Modification of hinge rails and structural components are made face ready.

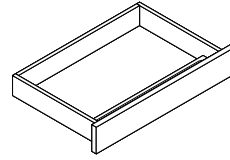
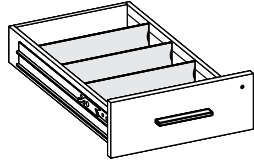
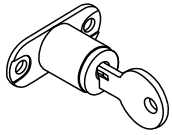

DOOR MODIFICATIONS
panel door lock

Style Number	List Price
D2	100 Per door set

DRAWER OPTIONS
box drawer accessories

Style Number	List Price
Wood Drawer Dividers w/ Clips K-DIV	SET OF 3 - 30
Single Tray - Utility Tray K-SUT	35 ea.

DRAWER OPTIONS
finished center drawer

Style Number	List Price
K31	205
Add Skirt Option K31-SK	310

TASK LIGHTING
It-led task light

Style Number	List Price
24" Task light LT-LED24	215
48" Task light LT-LED48	270
60" Task light LT-LED60	335
72" Task light LT-LED72	335

Specifications

- Door Locks - 1 Door w/ Lock, Other Door w/ Catch Latch
- Contact Customer Service regarding limited lock locations and keying.

Notes

- Available on: Panel Doors, Wood Frame Doors, and Silverluma doors

Specifications

- K-DIV Extra Wood Drawer Dividers with Clips, Top Box drawers standard with 1 divider
- K-SUT Single Tray - Utility Tray, Specify Legal or Letter drawer width

Specifications

- Veneer drawer front finished to match unit W or G style veneer.
- Ball bearing smooth operation
- Drawer has lifetime guarantee
- Standard with matching wood grain pencil tray
- Laminate drawer front to match laminate unit (M style)

Specifications

- 6.5' Power cord. Switch with touch dimmer
- 36 LEDs per foot
- 4.6 Watts per foot
- 91 Lumens per watt

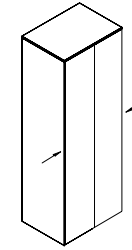
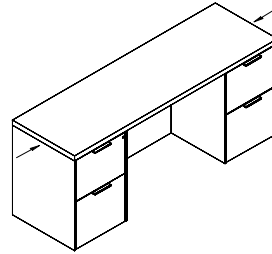
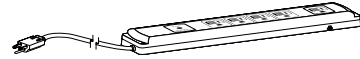
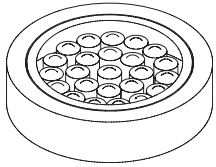

LIGHTING
led interior cabinet puck light

POWER / DATA
power supply cordset

PRODUCT MODIFICATIONS
modify width - open kneespace

PRODUCT MODIFICATIONS
modify width - open/closed storage

Style Number	List Price
Starter Kit LEDPK	310
1 LED Interior Puck Light PK	135

Style Number	List Price
PD717	95

Style Number	List Price
MOD-1	125

Style Number	List Price
MOD-2	250

Specifications

- Starter kit includes Infeed, 1 Puck Interior Light and the ability to daisy chain up to 6 total Puck Lights
- (1) LED Puck Light with 30W power drive and switch
- Recessed fixture
- 12V linking cord 98"L
- Silver finish
- 50,000 hour life
- 2 watt per light

Notes

- Available on: Overhead/Tower Units with glass doors or no doors
- Power drive included, Light only

Specifications

- SIZE: 10.75"L x 2.0"W x 1.06"H
- (5) Outlets w/ 10' cord
- Surge suppression (720 Joules)
- 15 Amp breaker
- Available on: Vertical Panels, Cabinet Interiors, and under tops

Specifications

- Modify width down on any unit with an open kneespace: desk, workstation credenza, bridge, return

Specifications

- Modify width down on any unit with open or closed storage section: overheads, wall hung units, storage credenzas, towers

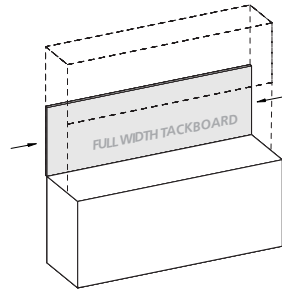

PRODUCT MODIFICATIONS
 modify width - tackboard, slat wall,
 veneer panel, or a glassboard

Style Number	List Price
MOD-4	50

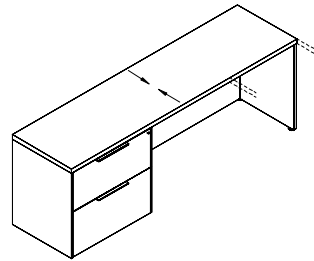

PRODUCT MODIFICATIONS
 modify depth - decrease depth

Style Number	List Price
MOD-5	125

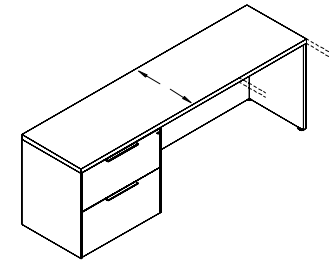

PRODUCT MODIFICATIONS
 modify depth - increase depth

Style Number	List Price
MOD-6	Add 10%

PRODUCT MODIFICATIONS
 modify width - outside of mod-1,
 mod-2

Style Number	List Price
MOD-3	Contact for pricing

Specifications

- Width modification outside of MOD-1 & MOD-2

Specifications

- Modify width down on tackboard, slat wall, veneer panel, or a overhead glassboard

Specifications

- Modify depth down (minimum depth for a unit with drawers is 21"D)

Notes
 - Ex. 24" to 21", 30" to 24", and 36" to 30"

Specifications

- Increase depth by no more than 6"

Notes
 - Ex. 24" to 30", 30" to 36", and 36" to 42"
 - Add 10% to the unit you want to increase the depth of by no more than 6"

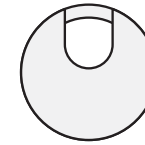
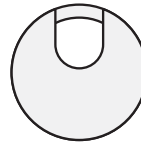
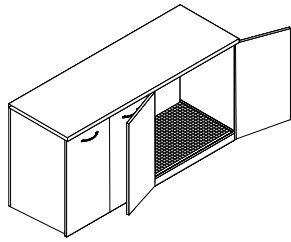

PRODUCT MODIFICATIONS
modify height

Style Number	List Price
MOD-7	Contact for pricing

REFRIGERATOR MODIFICATION
refrigerator cabinet modification

Style Number	List Price
REF01	205

WIRE MANAGEMENT
standard location grommets -
factory installed

Style Number	List Price
Standard Location Grommet	
Black TM30	50
Silver TM31	50
Antique Brass TM33	50
White TM34	50

WIRE MANAGEMENT
non-standard location grommets -
factory installed

Style Number	List Price
Non-Standard Location Grommet	
Black TM30 -NS	95
Silver TM31 -NS	95
Antique Brass TM33 -NS	95
White TM34 -NS	95

Specifications

- Modify height of a unit

Specifications

- Open back cutout for venting
- Moisture sponge mat
- Contaminate ledge
- Contact customer service for maximum refrigerator size (Changes based on unit).

Notes

- Available on: 36" and 42" Storage Credenzas

Specifications

- 1 -5/8" Metal Grommet

Notes

- *Units w/ Grommets Standard Are Noted Under Standard Features. Grommets Match Pull Finish - Standard (Unless Specified Otherwise)

Specifications

- 1 -5/8" Metal Grommet

Notes

- *Units w/ Grommets Standard Are Noted Under Standard Features. Grommets Match Pull Finish - Standard (Unless Specified Otherwise)



WIRE MANAGEMENT
coil wire manager

Style Number	List Price
W18	160

Specifications

- Weighted Base, Table attachment plate
- 39- 1/2" Length
- Black

Notes
- Location

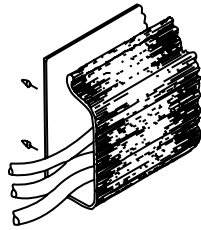

WIRE MANAGEMENT
horizontal j-channel wire
management raceway

Style Number	List Price
W1	80 Per 4' section

Specifications

- 4' section for field installation.
- The "J" shape black thermoplastic wire raceway may be added to specified worksurface tops to provide concealed channeling of wires to and from worksurface grommets. For use in open kneespace areas, raceway is attachable to top of back panel with pan head screws. Interior dimensions are 1" x 1- 1/2" providing ample storage for multiple wires and excess cable. Front of raceway flexes out for easy cord insertion.

Notes
- Units w/ Wire Channel Standard.
- Field Installation

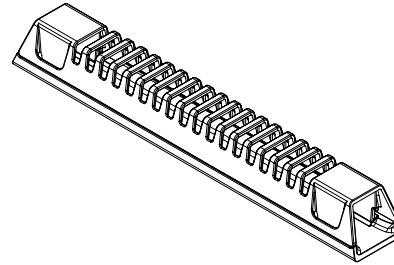

WIRE MANAGEMENT
horizontal wire management
raceway

Style Number	List Price
W21	35

Specifications

- 10"W x 1.5"D x 1.25"H
- Grey Wire Manager (10.5")
- Power and data cables can be discretely housed and managed with the W21 Gray Wire Manager. This can be mounted in any location to metal frame or underside of conference tables and runs cables through a 1" channel from power module to hollow steel legs. This keeps cables organized under the table top. Release clips make it simple to snap on and off the Wire Manager for easy organization and access after attached to the table

Notes
- Field installed



WIRE MANAGEMENT
horizontal u-channel wire
management raceway

Style Number	List Price
W2A	80 Per 4' section

Specifications

- 4' section for field installation.

Notes
- Units w/ Wire Channel Standard.
- Field Installation

Aircharge wireless charging grommet

Style Number	List Price
ACWG WIRELESS GROMMET	\$213

Specifications

- > When used with GROVE Tables an additional \$350 LIST will apply for the special cutout required.
- > AirCharge offers a convenient way to charge any Qi compatible smartphone or device without the need to carry charging cables or find an available power outlet.
- > The Aircharge is powered by the latest Qi compliant IC offering reliable and efficient wireless charging in a convenient 3" grommet hub. Simply place your phone on the Aircharge and an LED will confirm pairing and begin wireless charging.
- > Recess: Efficient space conservation and quick access
- > Input: DC 5V (with included AC power adapter), DC 9V, 1.67A (with optional QC 2.0 power adapter)
- > Output: 5 watts Max. with DC 5V, 2A power adapter, 10 watts Max. with QC 2.0 power adapter
- > Qi V1.2 compliant IC
- > Charging distance: 6mm Max.

Available: All DARRAN collections



Cove power unit with daisylink

Style Number	List Price
--------------	------------

STARTER UNITS

 COV-DCH HARDWIRED	\$774
---	-------

Includes (1) Cove unit with Hardwire Infeed - 120"

 COV-DCP PLUG	\$872
--	-------

Includes (1) Cove unit with Plug infeed - Includes 72" Cord and 32" Infeed Jumper for 104" total cord infeed

ADDITIONAL LINKING UNITS

COV-DCL	\$627 EACH
---------	------------

Includes Linking Cove unit and Jumper up to 96", cable length determined by the top size



Specifications

- > Size: 5.75"L x 2.5"W
- > (2) 15 Amp Receptacles and (2) 2.1 Amp USB charging ports
- > Surface Mount
- > Max Daisy Chain - Hardwire - (9) units; Plug/Corded - (4) units
- > Standard Silver Finish, Available in White or Black Finish upon request
- > ETL Listed

Available: All DARRAN collections

Keno power unit

Style Number	List Price
 PD-KENO	\$311

Specifications

- › Size 5.5"L x 2.125"W x 2.5"H
- › 2 TR AC Outlets
- › 1 4.2A USB module w/ 2 charging ports
- › 10' Power cord

Available: EdgeWorks, NSS Open, ThinkingQuietly



White



Black

DARRAN®

Seclusion corded power unit non-linking

Style Number  List Price

P2SECL \$436

Choose from plate mount or clamp mount
(seen in photo)

Specifications

- › Size: 3.5"L x 2.2"D x 2.5"H
- › (2) Power Receptacles
- › Worksurface Clamp Mount or Plate Under Surface Mount
- › Clamp Accessory accommodates table thickness up to 2"
- › 72" Cord
- › Standard Silver Finish, Black Finish available upon request
- › UL/UCL Listed

Available: All DARRAN collections

Power & Data Options



Clamp Mount

DARRAN®

Soba wire manager

Style Number	List Price
STARTER UNITS	
SCDW	\$218
White wire manager	
SCDB	\$218
Black wire manager	

Specifications

- › Dimensions: 9ft x 9in x 3.15in
- › Zips up, bundles and routes loose, messy cables into a single tube
- › Routes and guides cables behind desks, TVs, and anywhere cables tend to get messy
- › Accommodates large or small cables, up to three cables at once
- › Support channels, used to route cables, include powerful adhesive backing which allows easy attachment to surfaces.

Available: All DARRAN collections

Power & Data Options



DARRAN®

Tully power unit

Style Number	List Price
PD-TULLY	\$436



Specifications



- > 5.5" W x 3.2" H x 1.81" D
- > Finish: Smooth molded plastic integrated within a single piece cover
- > Mounts to the edge of your work surface, with no table cut outs or installation required.
- > (2) Power receptacles, (2) USB 2.1 Amp ports
- > 72" Cord (10' cord available, contact customer service).
- > Standard in White. Available in gray, black, neon red, harvest pumpkin, light green, daisy blue.
- > UL310, Class 2, FCC Part 15A approved
- > Clamp accessory accomodates table thickness from .75"-1.5"

Available: EdgeWorks, NSS Open, ThinkingQuietly.

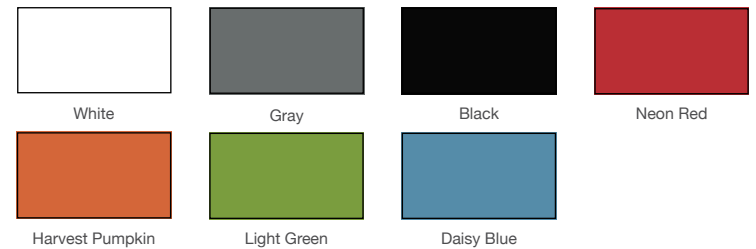
Power & Data Options



VILLA Power unit with daisylink

Style Number	List Price
STARTER UNITS	
 VIL-DCH HARDWIRED	\$975
Includes (1) Villa unit with 120" Hardwire Infeed	
 VIL-DCP PLUG	\$975
Includes (1) Villa with Plug Infeed - Includes 72" Cord and 32" Infeed Jumper for 104" total cord infeed	
ADDITIONAL LINKING UNITS	
VIL-DCL ADDITIONAL	\$950
(Includes linking Villa and Jumper cable up to 96")	

Specifications

- > Size: Top Grommet 5.68"L X 3.39"W; Under Top 12"L x 3.13"W x 3.08"D
- > (4) Power receptacles; (2) surface and (2) undersurface, (2) 2.1A USB charging ports and (1) Knockout for RJ45 Data Port
- > Surface Mount
- > Daisy Chain - Hardwire Max (10) Units, Plug/Corded Max (5) Units
- > Standard Silver Finish, Black Finish available upon request
- > UL or ETL Certified

Available: All DARRAN collections, excludes grove

RJ45 Knockout	
RJ45 (1)	\$55





Grove Price List

Effective November 1, 2022

Date	Page	Modification	Description
11.07.22	3	Metal Finish	Added Dark Bronze and Matte Gold Metal Finish
11.10.22		Price Increase	9% price increase applied to all items except for options

Statement of Line
Features & Advantages1
Live Edge Warranty & Care.....2
Live Edge tables.....3
Stools4
Power & Data.....7

Statement of Line

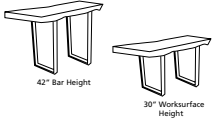

Page 3
Live Edge
Live Edge Conference Table



Page 4
Round Tables
Round Acacia Stool Or Table



Page 5
Square Table
Square Acacia Stool Or Table

DARRAN®

Grove Features & Advantages

From Table edge to the leg:
120" = 17" Inset
96" = 12" Inset
76" = 10" Inset

Butterflies are hand placed based on the tables natural cracks. Natural cracks in the wood are considered normal and enhance the beauty of the tables.

Every table is unique with live edge detailing

Metal legs standard in black. Optional in matte black and silver.

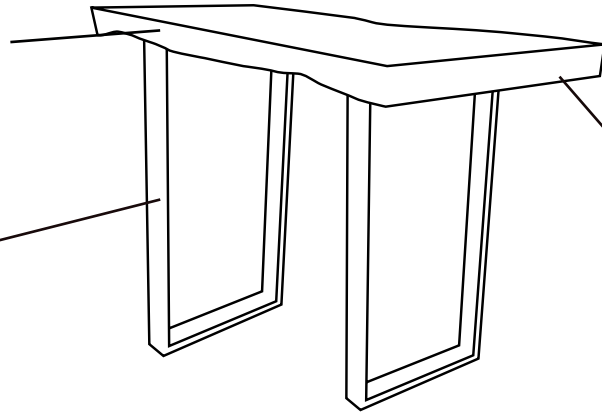

The Acacia tree is fast growing and known for its beautifully figured grain and distinct sap lines.

Solid slabs can vary from 2" - 3" thick.



Finish

Each Grove slab features a protective clear coat to enhance the natural cracks of the solid wood.

Welltech Finish delivers a superior furniture coating with exceptional performance that can withstand stringent cleaning agents and possesses unparalleled durability, allowing DARRAN to provide lasting, sustainable products to our customers.

Every stool or table is unique with live edge detailing

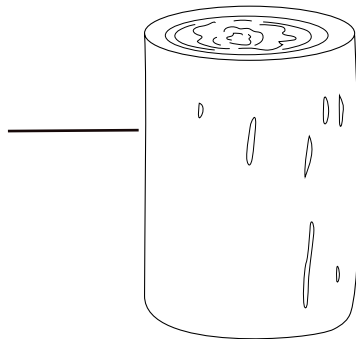

Butterflies are hand placed based on the stools natural cracks. Natural cracks in the wood are considered normal and enhance the beauty of the stools.

Stool depth varies

Powerports

Choose Byrne's Salt power port. Salt includes two powered USB ports. Salt power ports can be added to square stools only.

DARRAN®

The DARRAN Grove Collection features natural live edge solid wood slab tables. The Grove slabs are all individually unique with different grain variations, knots, variations in color, splits, and holes that all add to the natural beauty of each table. The natural characteristics are further enhanced by a protective varnish top coat that provides superior resistance to water marks, heat damage, chemical contact, and scratch resistance.

Warranty

All tables and bases have a one-year warranty. We will repair or replace (at our option) any faulty product deemed to have been caused by manufacturing defects. Live edge materials have inherent inconsistencies, natural defects and irregularities that are part of their unique nature. These are considered to be desired effects. Solid wood adjusts different times of the year to the moisture content of the air. In a sense the wood breathes. Wood will also adjust to the moisture content of your office and its surroundings. You may notice your slab furniture piece move and develop small cracks or dips. This is normal. Slab furniture cannot be compared to other solid wood furniture pieces. This product will have movement during its life and this is just the nature of natural wood slab furniture.

Care

In order to maintain the natural beauty of your Grove table, DARRAN recommends the following:

- › Clean your Grove Table using a soft, damp cloth with a mild soap and wipe dry.
- › DARRAN's protective varnish top coat uses the latest advanced finishing technology to preserve the beauty of each Grove Table. Even with this protection, DARRAN recommends the use of coasters with drinks and to clean up any spilled liquids immediately. Avoid direct contact with hot items, harsh chemicals, and some plastic feet on desk accessories as they could damage the finish.
- › Take into account the humidity levels. This natural solid wood will continually contract and expand throughout its life and it will remain very sensitive to abrupt environment change, such as humidity, long after it has been harvested. Humidity levels should always remain between 30-50% to preserve your Grove table. Exposure to extreme fluxuations can cause additional cracking in the slab and would not be considered a manufacturer defect. A furniture repair expert can secure a new crack with a wood butterfly and then recoat the top.
- › Avoid placing your table in direct sunlight to prevent wood bleaching and color changes associated with UV exposure.

Grove Live Edge Warranty & Care



Grove

Live Edge
Live Edge Conference Table

[Click here to view statement of line](#)

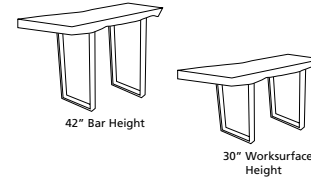

1 Select Model

Weight

w" x d" x h"

	Weight	Standard Veneer Top Standard Veneer Chassis	Premium Veneer Top Premium Veneer Chassis	High Pressure Laminate Top Veneer Chassis	Thermally Fused Laminate Top Thermally Fused Laminate Chassis
42" Bar Height					
120 Width	775	GRO12042RE400W 19218	"P" Option N/A	"G" Option N/A	"M" Option N/A
96 Width	575	GRO9642RE400W 12271	"P" Option N/A	"G" Option N/A	"M" Option N/A
76 Width	375	GRO7642RE400W 9152	"P" Option N/A	"G" Option N/A	"M" Option N/A
30" Worksurface Height					
120 Width	750	GRO12030RE400W 18735	"P" Option N/A	"G" Option N/A	"M" Option N/A
96 Width	550	GRO9630RE400W 11951	"P" Option N/A	"G" Option N/A	"M" Option N/A
76 Width	350	GRO7630RE400W 8847	"P" Option N/A	"G" Option N/A	"M" Option N/A

*Table depth and thickness varies. Images of inventory and slab dimensions can be viewed at darran.com under the Grove collection.

2 Select Finish

WLE

[Click to view finishes](#)

3 Select Edge

[Click to view edges](#)

Edge
N/A

4 Select Hardware

[Click to view details](#)

Hardware
N/A

Product Features

- Black Metal Legs are standard
- Tops are 2" - 3" thick
- Bases have adjustable glides for leveling

Notes

- Butterflies are hand placed based on the tables natural characteristic
- Natural cracks in the wood are considered normal and enhance the beauty of the table
- Slabs are cut from the Acacia Tree and has figured grain with distinct sap line edges

Options

Premium Finish Option

- Specify base in premium Metal Finish (MFS: Silver, MFMB: Matte Black, MFDB: Dark Bronze, MFGM: Matte Gold) - \$160 per base
- Specify W17 wire management in premium Metal Finish - (MFS: Silver, MFMB: Matte Black, MFDB: Dark Bronze, MFGM: Matte Gold) - \$55
- Specify W20 wire management in premium Metal Finish - (MFS: Silver, MFMB: Matte Black, MFDB: Dark Bronze, MFGM: Matte Gold) - \$80

Wire Management

- W17: Wire management cover - \$80 For 30" worksurface height
- W20: Wire management cover - \$105 For 42" worksurface height

Grove

Round Tables

Round Acacia Stool Or Table



[Click here to view statement of line](#)

1 Select Model

w" x d" x h"
 12 dia x 17 50
 16 dia x 21 60
 * Stool or Table depth varies

Weight

Standard Veneer Top Standard Veneer Chassis	Premium Veneer Top Premium Veneer Chassis	High Pressure Laminate Top Veneer Chassis	Thermally Fused Laminate Top Thermally Fused Laminate Chassis
GRO1217AS372W 564	"P" Option N/A	"G" Option N/A	"M" Option N/A
GRO1621AS372W 1140	"P" Option N/A	"G" Option N/A	"M" Option N/A

Product Features

Notes

- Butterflies are hand placed based on the tables natural characteristic
- Natural cracks in the wood are considered normal and enhance the beauty of the table
- Stools are cut from the Acacia tree and has figured grain with distinct sap line edges

2 Select Finish

Click to view finishes WLE

3 Select Edge

Click to view edges Edge
N/A

4 Select Hardware

Click to view details Hardware
N/A

Grove

Square Table

Square Acacia Stool Or Table



[Click here to view statement of line](#)

1 Select Model

w" x d" x h"
12 x 12 x 18
* Stool or Table depth varies

Weight

60

Standard Veneer Top Standard Veneer Chassis	Premium Veneer Top Premium Veneer Chassis	High Pressure Laminate Top Veneer Chassis	Thermally Fused Laminate Top Thermally Fused Laminate Chassis
GRO1212CM373W 813	"P" Option N/A	"G" Option N/A	"M" Option N/A

Product Features

Notes

- Butterflies are hand placed based on the tables natural characteristic
- Natural cracks in the wood are considered normal and enhance the beauty of the table
- Stools are cut from the Acacia tree and has figured grain with distinct sap line edges

Options

Power

- PDS01-G: Salt (Powered USB) - \$464
- See power page for color options

2 Select Finish

[Click to view finishes](#)

WLE

3 Select Edge

[Click to view edges](#)

Edge
N/A

4 Select Hardware

[Click to view details](#)

Hardware
N/A

Cove power unit - non-linking for Grove

Style Number List Price



PD-COVE-G PLUG \$918

Non-linking version

When used with GROVE Tables an additional \$350 LIST applies for the special cutout required. List price above is reflective of the additional \$350 charge.



Specifications

- > Size 5.75"L x 2.5"W
- > 2) 15 Amp Receptacles and (2) USB charging ports
- > Surface Mount
- > 108" Cord
- > Standard Silver Finish, Available in White or Black Finish upon request
- > ETL Listed

Available: All DARRAN collections



Cove power unit with daisylink for Grove

Style Number	List Price
STARTER UNITS	
 COV-DCH-G HARDWIRED Includes (1) Cove unit with Hardwire Infeed - 120"	\$1156
 COV-DCP-G PLUG Includes (1) Cove unit with Plug infeed - Includes 72" Cord and 32" Infeed Jumper for 104" total cord infeed	\$1254
ADDITIONAL LINKING UNITS	
COV-DCL-G	\$1009 EACH

Includes Linking Cove unit and Jumper up to 96", cable length determined by the top size
 When used with GROVE Tables an additional \$350 LIST applies for the special cutout required. List price above is reflective of the additional \$350 charge.

Specifications

- > Size: 5.75"L x 2.5"W
- > (2) 15 Amp Receptacles and (2) 2.1 Amp USB charging ports
- > Surface Mount
- > Max Daisy Chain - Hardwire - (9) units; Plug/Corded - (4) units
- > Standard Silver Finish, Available in White or Black Finish upon request
- > ETL Listed

Available: Grove



Cove corded series for Grove

Style Number List Price

 PD-COVE-PKO-G \$1254

When used with GROVE Tables an additional \$350 LIST applies for the special cutout required. List price above is reflective of the additional \$350 charge.

Specifications

- > Size 9.5"L x 2.5"W x 3.18"D
- > (2) Power Receptacles, (2) 2.1 Amp USB charging ports and (1) Telecom Plate Knockout
- > Surface Mount
- > 108" Cord
- > Standard Silver Finish, Available in White or Black Finish upon request
- > ETL Listed

Available: Grove

Telecom Plates

RJ45 (1)	\$55
RJ45 (2)	\$110
RJ45 (3)	\$165
USB (1)	\$70
USB (2)	\$140
RJ11/RJ45	\$110
RJ45/USB	\$125
RJ45/HDMI	\$210
HDMI/DVI	\$325
HDMI/USB	\$205
HDMI/VGA	\$240
VGA/MINI-STEREO	\$155
VGA/USB	\$175

This pod can have up to 1 total plates.
 *All telecom connectors sold separately.



Dual

Style Number	List Price
STARTER UNITS	
PD-DUAL3P3J	\$1,276
3 modules: 3' jumpers	
PD-DUAL3P6J	\$1,292
3 modules: 6' jumpers	
PD-DUAL3P12J	\$1,308
3 modules: 12' jumpers	
PD-DUAL4P3J	\$1,581
4 modules: 3' jumpers	
PD-DUAL4P6J	\$1,603
4 modules: 6' jumpers	
PD-DUAL4P12J	\$1,625
4 modules: 12' jumpers	
PD-DUAL8P3J	\$3,080
8 modules: 3' jumpers	
PD-DUAL8P6J	\$3,123
8 modules: 6' jumpers	
PD-DUAL8P12J	\$3,167
8 modules: 12' jumpers	



Specifications

- > Size: 3" x 1.75" x 1.25"
- > (2) 2.4 Amp USB charging ports per module
- > Undersurface mount
- > 72" cord
- > Standard black finish, available in white upon request
- > UL certified

Available: Conference, Milner, ThinkingQuietly

Salt power port for Grove stool

Style Number List Price



GROVE

PDS01-G Salt (powered USB) \$464

Available on Grove square stool only. When used on Grove stool an additional \$200 list applies for the special cutout. List price above is reflective of the additional \$200 charge.

Specifications

- > Salt port includes 2 power USB
- > Cord is 48" long
- > Spill-proof technology

Available: Grove square stool



Salt powered USB



Reef power unit with daisylink for Grove

Style Number List Price



REF310-G PLUG \$1581

When used with Grove tables an additional \$350 list applies for the special cutout required. List price above is reflective of the additional \$350 charge.

Specifications

- > Size 16.1"L x 6.25"W x 4.89"
- > (3) 120V Receptacles, (2) USB charging ports, 1 Data Plate Knockout, (2) Knockouts for RJ45 Data Ports
- > Surface Mount
- > 108" Cord
- > Features Convenience Plug on bottom of unit that allows for max (3) Daisy Chain
- > Standard Black Finish, Available in White or Silver Finish upon request
- > Additional Telecom Plate Knockout
- > RJ45 for Knockouts not required. If not ordered a small hole will be present in the pod in this this location
- > ETL Listed

Available: Grove

Telecom Plates

RJ45 (1)	\$55
RJ45 (2)	\$110
RJ45 (3)	\$165
USB (1)	\$70
USB (2)	\$140
RJ11/RJ45	\$110
RJ45/USB	\$125
RJ45/HDMI	\$210
HDMI/DVI	\$325
HDMI/USB	\$205
HDMI/VGA	\$240
VGA/MINI-STEREO	\$155
VGA/USB	\$175

This pod can have up to 1 total plates.
*All telecom connectors sold separately.



VILLA Power unit with daisylink for Grove

Style Number	List Price
--------------	------------

STARTER UNITS

 VIL-DCH-G HARDWIRED	\$1254
---	--------

Includes (1) Villa unit with 120" Hardwire Infeed

 VIL-DCP-G PLUG	\$1045
--	--------

Includes (1) Villa with Plug Infeed - Includes 72" Cord and 32" Infeed Jumper for 104" total cord infeed

ADDITIONAL LINKING UNITS

VIL-DCL-G ADDITIONAL	\$940
----------------------	-------

(Includes linking Villa and Jumper cable up to 96")

Specifications

- > Size: Top Grommet 5.68"L X 3.39"W; Under Top 12"L x 3.13"W x 3.08"D
- > (4) Power receptacles; (2) surface and (2) undersurface, (2) 2.1A USB charging ports and (1) Knockout for RJ45 Data Port
- > Surface Mount
- > Daisy Chain - Hardwire Max (10) Units, Plug/Corded Max (5) Units
- > Standard Silver Finish, Black Finish available upon request
- > UL or ETL Certified

Available: Grove

RJ45 Knockout RJ45 (1)	\$55
---------------------------	------

