

DARRAN®



## Richmond Park Price List

Effective April 1, 2024

Date	Page	Modification	Description
04.02.24		Updated Pricing	

Statement of Line  
Features & Advantages .....1  
Finishes | Specifications .....3  
Edges | Pulls | Knobs.....4  
Grommets | Grommet Reference.....5  
Ganging | Height Reference .....6  
Modesty Reference | Grain Direction.....7  
Drawer Dimensions | Filing Reference .....8  
Double Pedestal Desk.....9  
Single Pedestal Desk.....12  
Workstation Desk .....14  
Returns.....15  
Bridges .....17  
Freestanding Credenzas .....18  
Workstation Credenzas .....23  
Single Height Freestanding Overheads.....25  
Overhead Accessories.....26  
Single Height Wall Hung Overheads.....30  
Wall Hung Accessories .....31  
Overhead Bookcases .....36  
Vertical Half Towers.....38  
Vertical Full Towers.....40  
Bookcases .....42  
Options .....43  
Power & Data.....57

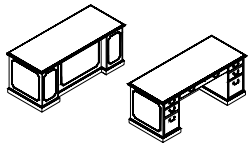

Page 9  
Double Pedestal Desks  
Executive Chassis Breakfront

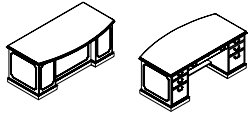

Page 10  
Double Pedestal Desks  
Bowfront / Breakfront Executive  
Chassis

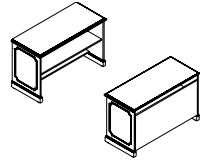

Page 11  
Desks  
Crt Desk / Printer

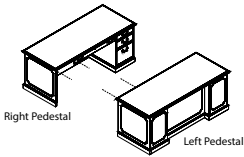

Page 12  
Workstation Desks  
Executive Breakfront Chassis  
Single Pedestal Desk

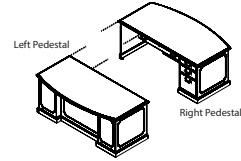

Page 13  
Workstation Desks  
Bowfront / Breakfront Executive  
Chassis Single Pedestal Desk

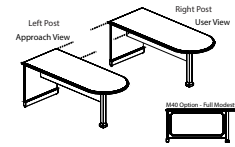

Page 14  
Workstation Desks  
Bullet Conference Desk

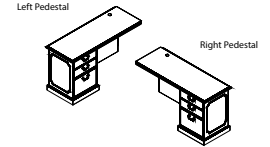

Page 15  
Workstation Returns  
Box / Box / File

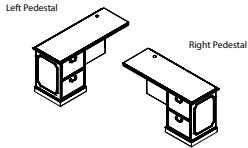

Page 16  
Workstation Returns  
File / File

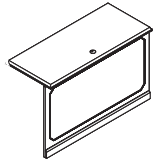

Page 17  
Workstation Units  
Bridge W/ Fixed Full Modesty

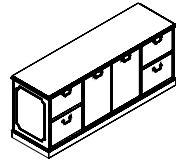

Page 18  
Credenzas / Files  
Storage Credenza

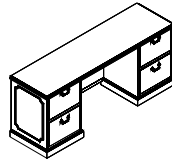

Page 19  
Credenzas / Files  
Kneespace Credenza

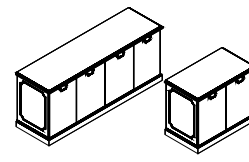

Page 20  
Credenzas  
Storage Credenza



Page 21  
Lateral File Credenzas  
Horizontal Lateral File



Page 22  
Credenzas / Files  
Vertical Lateral File

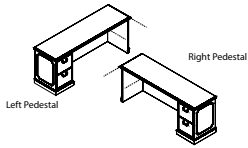

Page 23  
Workstation Credenza  
File / File

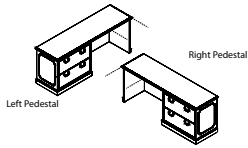

Page 24  
Workstation Credenza  
Lateral File

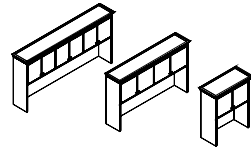

Page 25  
Overhead Consoles  
Freestanding - Panel Door

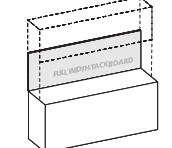

Page 26  
Overhead Tackboards

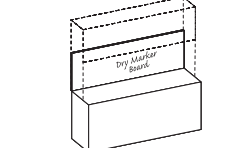

Page 27  
Overhead Dry Marker Boards

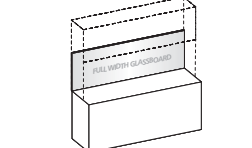

Page 28  
Overhead Glassboards

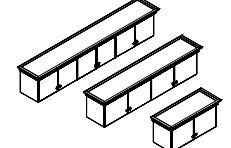

Page 29  
Wall Hung Overheads  
Panel Doors

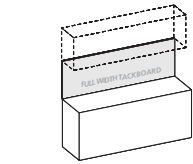

Page 30  
Wall Hung Tackboards

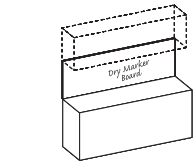

Page 31  
Wall Hung Dry Marker Boards

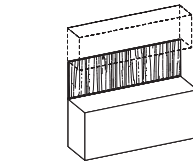

Page 32  
Wall Hung Veneer Panels

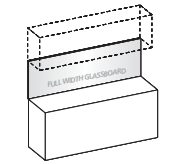

Page 33  
Wall Hung Glassboards

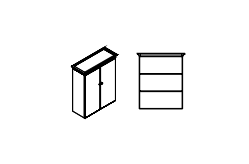

Page 34  
Assembled Overhead Bookcase  
/ Hutch  
Panel Door

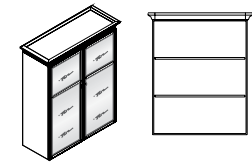

Page 35  
Assembled Overhead Bookcase  
/ Hutch  
Wood Frame Door W/ beveled  
glass Insert

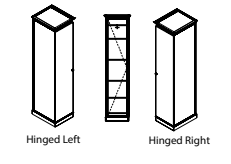

Page 36  
Vertical Half Towers  
Wardrobe / Storage

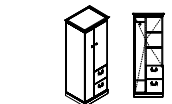

Page 37  
Vertical Half Towers  
Storage / File/File With Mini-Ward-  
robe

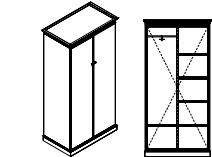

Page 38  
Vertical Full Towers  
Freestanding Wardrobe / Storage

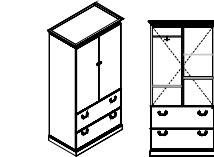

Page 39  
Vertical Full Towers  
Freestanding Lateral File /  
Storage

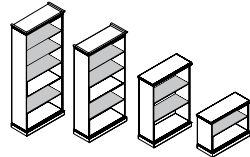

Page 40  
Assembled Bookcases  
Open Bookcase

## Veneer

DARRAN only uses HPVA AA Grade Flat Cut Cherry and Walnut Veneers. All veneers are selected and matched for balance and consistency.

## Veneer tops

Richmond park veneer tops feature a 45-pound density substrate with balanced 3-ply construction. Tops are 1-1/8" thick on MDF core comprised of 100% recycled and recovered wood fibers. All veneer tops are slipmatched and feature a 3mm external solid hardwood band or profile edge.

## Laminate tops

Richmond park high-pressure laminate tops feature a 45-pound density substrate with balanced 3-ply construction. Tops are 1-1/8" thick on MDF core comprised of 100% recycled and recovered wood fibers. All high pressure laminate tops are available with a profile edge, laminate self-edge or 2mm PVC edge band. Laminates in wood grain patterns feature a fine grain texture that features the polish and luxe of a real wood veneer with a subtle narrow grain structure.

## Cleaning wood & laminate

In addition to regular dusting, give your furniture an occasional cleaning in accordance with our cleaning instructions. DARRAN wood and laminate products can be cleaned with a soft cloth and a mild soap and water mixture. Use approximately 32 oz of water mixed with one tablespoon of dish soap, always wiping with the grain. Dry with a soft cloth, going with the grain, to avoid spotting or streaking.

Wood products should be waxed periodically using a non-wax liquid; please do not use any waxy polish or cleaner. Interior of drawers may also be cleaned with mild soap and water mixture, or any household cleaner that is not petroleum or thinner-based.

## Chassis & pedestal

Chassis components are 3/4" thick core of particle board or MDF rated EPP/SCS/CARB-II material with 3-ply balanced construction. Pedestal and Cabinets feature dowel construction reinforced with steel bracket plates, wood cleats, screws and glue. All units are standard with 1" adjustable glides that allow for leveling of units that are secured in solid wood glide blocks to prevent tearout.

## Overhead cabinet construction Freestanding & wall mount

Freestanding Overhead storage cabinets are constructed of 1" and 3/4" thick core of particle board or MDF rated EPP/SCS/CARB-II material with 3-ply balanced construction. Panels are attached with cam fasteners in conjunction with dowels securely adhered with glue. All surface mount cabinets connect to work surface with anti-slip tape. Wall mount cabinets are mounted to the wall with steel "z" bracket attachment method using 5mm euro screws to attach to the back of the cabinet. All units ship with a steel "z" bracket. This bracket is mounted to the wall by field

## Richmond Park Features & Advantages

installers. Installers are responsible for selecting and supplying appropriate fasteners for wall conditions.

## Bookcase Construction

All chassis (sides, back, top and bottom panels) are constructed with 3/4" thick core of particle board or MDF rated EPP/SCS/CARB-II material with 3-ply balanced construction. Panels are attached with cam-lock fasteners in conjunction with dowels securely adhered with glue. Shelves on all units are 3/4" thick balance 3 ply panels. Optional heavy duty shelves are 1" thick lumber core balanced 5 ply construction.

## Tackboards

Wall mount tackboards are constructed of .75" thick fiberboard. The fabric is precisely aligned and fitted to the tackboard with a sock on cover. Overhead storage tackboards are constructed of .75" thick fiberboard. The fabric is precisely aligned and fitted to the tackboard and adhered to the rigid hardboard with staples. Wall mount cabinets are mounted to the wall with steel "z" bracket attachment method using 5mm euro screws to attach to the back of the cabinet. All units ship with a steel "z" bracket. This bracket is mounted to the wall by field installers. Installers are responsible for selecting and supplying appropriate fasteners for wall conditions.

## Adjustable glides

Glides provide 1" of vertical leveling adjustment. Glide bottom is durable metal. Glides are secured in solid wood blocks that are screwed and glued for durability.

## Drawers

All drawers are constructed with mitre joint/dowel construction in a natural maple finish with four sides and a bottom, which are attached to a drawer front with screws for easy removal. Drawer fronts are vertically matched in balanced sets. Pencil trays are standard in all box drawers. Drawers are constructed of 1/2" thick wood grained wrapped 5 sided miter-folded construction with 1/4" thick hardboard bottoms reinforced for heavy weight capacity. Drawers have been tested and pass BIFMA 50,000 cycle test. All drawers are guaranteed lifetime with free replacement warranty.

## Drawer fronts

Drawer fronts are vertically matched in balanced sets. Doors feature vertical veneer bookmatched horizontally in sets of 2 / 4 and 6 doors. All tower fronts matched in vertical sets.

## Optional wood drawers

Optional hardwood veneer plywood drawers feature banded top and bottom edges for smoothness. Drawers are dowel joint construction with a UV cured finish over maple veneers, plus a lifetime free replacement guarantee.

Optional Wood Drawer (Any Size) – Option Code P33...\$45 List Price Per Drawer

## Suspensions

All caseloads utilize cold rolled steel zinc plated high-grade drawer suspensions. Box and File drawers are full extension, featuring steel ball bearings for a smoother quieter range of motion with soft close operation and are rated 100lbs. Lateral file drawers are a progressive action full extension suspension with the soft close operation and is rated at 150lbs. Lateral files include anti tip mechanism that will allow only one drawer at a time to be opened. All suspensions are soft close and are warranted for the lifetime of the product.

## Hinges

Units with doors include 95 degree swing hinges.

## Filing

Capitol park features a highly durable black plastic extrusion that is securely fastened into a route on top of the drawer to support hanging files. An adjustable crossbar is provided for all file drawers that enables legal/letter filing front to back or side-to-side based on the drawer size.

## Locks

Locks are Standard on all drawers below the worksurface. Random lock cores are installed at the factory. Some units may be shipped with the same key number. Locks are Silver, Black or Bronze and match pull finish unless otherwise specified.

DARRAN will also send lock cores separately to the dealer at your request. These units will be send with an empty lock core and the Dealer will receive a shipment of the requested lock core/keys.

## Keying

Keying is available either factory or field installed. Factory installed keying is random.

## Wire management

Wire management capabilities include standard and optional worksurface grommets. Specify W-1 under surface wire channels for organization and management of all communication wires and cords. Horizontal J-Channel wire management (Sku: W-1) is sold separately to conceal wire under worksurfaces.

## Grommets

Metal grommets are provided to match the drawer pull selection. Grommet is available in black, silver, white or antique brass. Must specify standard or non-standard location. Black plastic grommets are available as an option for vertical applications.

## Powerports

A large selection of power pods are available and handle power, data, docking stations and communication. See options section for selection.

## LED tasklights

LED task lighting provides high efficiency, low energy lighting with a long life. Surface mounted light is encased in silver aluminum channel with milk lense and rounded end caps. Lights are field installed. Product specifications listed below:

- Diffuser creates a softer light and eliminates hot spots
- Touch dimmer switch
- Can be "daisy chained" up to 90W
- 4.6 watts per foot
- 120 LEDs per meter
- Certification: UL Listed
- 50,000 hour life span.

Color Temp is 4000K

WOOD FINISHES



WGW Gunstock Walnut



WHC Honey Cherry



WAC Amber Cherry



WNW Natural Walnut



WSW Smokey Walnut



WBW Henna Walnut



WEW Executive Walnut



WIC Crimson Cherry

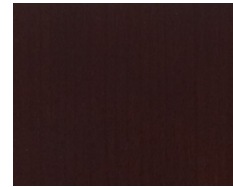

WOC KoKo Cherry

HIGH PRESSURE LAMINATES



GHC Honey Cherry



GAC Amber Cherry



GNW Natural Walnut



GEW Executive Walnut



GIC Crimson Cherry

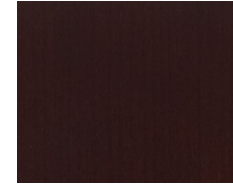

GOC KoKo Cherry



Finish

Welltech Finish delivers a superior furniture coating with exceptional performance that can withstand stringent cleaning agents and possesses unparalleled durability, allowing DARRAN to provide lasting, sustainable products to our customers.

**DARRAN®**

**Standard profile**

Richmond Park Edge  
Hardwood Rim Band Species Same As  
Surface Veneer

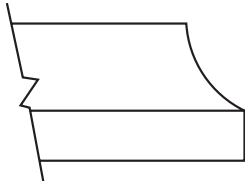

**Optional profile**

Classic Edge - No additional  
upcharge  
Hardwood Rim Band Species Same  
As Surface Veneer

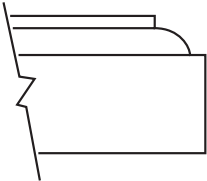

3mm solid  
hardwood band

**Richmond Park Edges | Pulls | Knobs**

**Hookup edge profile**

Coped Edge

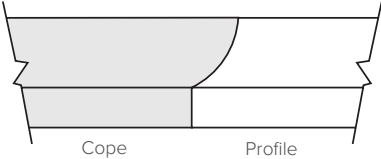

**Cornice top profile**

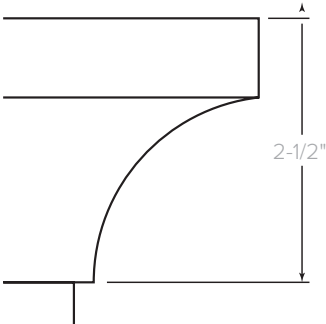

**Base profile**

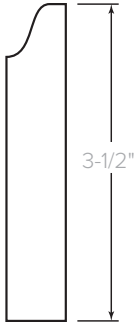

**Drawer/door  
edge profile**



**Pulls/knobs**

Factory Installed



PL-5 Antique Brass  
PL-50 Brushed Pewter



PL-4 Antique Brass



DK-114  
Brushed Pewter

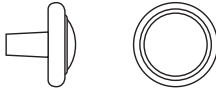

DK-4  
Antique Brass



# DARRAN®

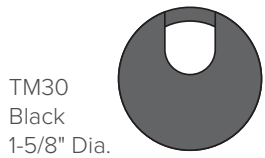

TM30  
Black  
1-5/8" Dia.



TM31  
Silver  
1-5/8" Dia.

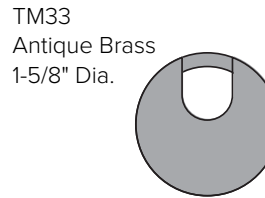

TM33  
Antique Brass  
1-5/8" Dia.

## Optional grommets

Factory Installed

Grommets (Standard Location)

Specify Color and Left/Right/Center - \$50 ea.

- Black: TM30-R (Right), TM30-L (Left), TM30-C (Center)
- Silver: TM31-R (Right), TM31-L (Left), TM31-C (Center)
- Antique Brass: TM33-R (Right), TM33-L (Left), TM33-C (Center)

Grommets (Non-Standard Location)

Provide drawing w/ Grommet Location and Specify Color - \$95 ea.

- Black: TM30-NS
- Silver: TM31-NS
- Antique Brass: TM33-NS

## Richmond Park Grommets | Grommet Reference

TM50  
Black  
1-5/8" Dia.

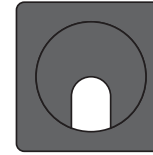

## Grommets (vertical surface)

Standard Location - \$50 ea.

- Black Plastic Vertical Surface: TM50-C (Bottom Center)

Non-Standard Location - \$95 ea.

- Black Plastic Vertical Surface: TM50-NS

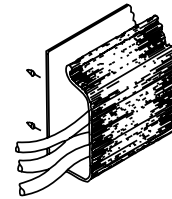

W1

## Horizontal J-channel

Horizontal J-Channel wire management (Sku: W-1) is sold separately to conceal wire under worksurfaces.

## Standard grommet location reference

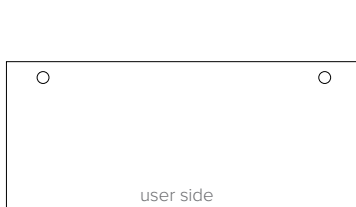

Desk  
Specify Right or Left Grommet



6" Overhang Desk  
Specify Right or Left Grommet

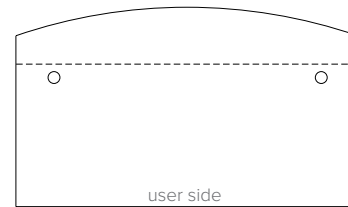

6"/12" Bow Front Desk  
Specify Right or Left Grommet



Bullet Conference Desk (Right Post)  
Center Grommet

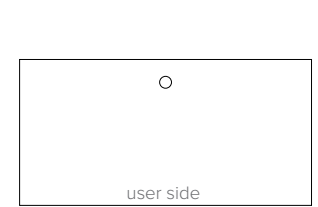

Bridge  
Center Grommet

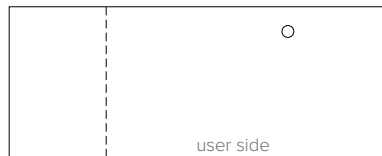

Return (Left Pedestal Shown)  
Right Pedestal - Left Grommet  
Left Pedestal - Right Grommet



Workstation Credenza  
Center Kneespace Grommet

**Ganging – Flush Cut Modification**

30”H Casework Worksurface & Base Ganging Modifications

To gang two casework units, each unit end to be ganged must be flush cut modified for gapless surfaces and cabinet chassis.

Order Option:

- FC-B: Flush Unit Both Sides(Facing) for Ganging - \$100
- FC-L: Flush Unit Left (Facing) for Ganging - \$100
- FC-R: Flush Unit Right (Facing) for Ganging - \$100

Flush cut modification per unit includes all modifications to gang to one end or both ends when units are ganged. Modification includes tops, base and molding. Modification reduces width size approximately 1” per end.

Overhead consoles and towers are offered freestanding and ganging – inclusive of flush cut modifications.

Example:

RPC3121100W Two Drawer Lateral File (Left) Flush Cut Right – FC-R...\$100

RPC7221054 Kneespace Credenza (Right) Flush Cut Left – FC-L...\$100



**Height reference**

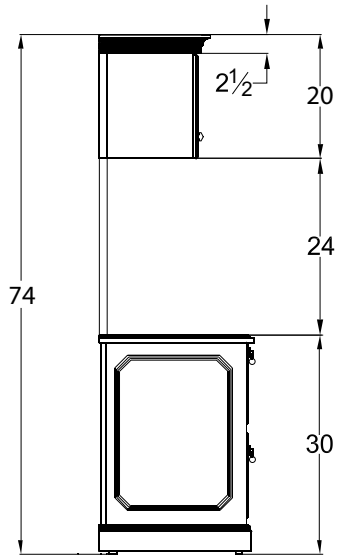

Typical Single Height Side Profile Wall Hung Overhead

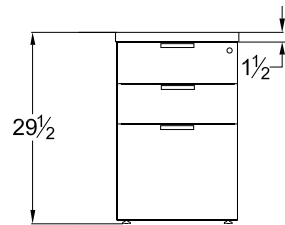

Pedestal Front Profile Box/Box/File

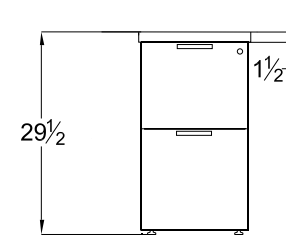

Pedestal Front Profile File/File

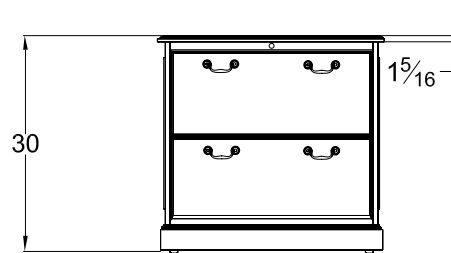

Pedestal Front Profile Lateral File

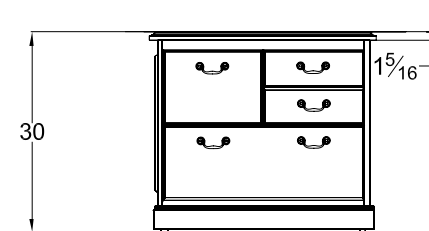

Pedestal Front Profile Multi-File

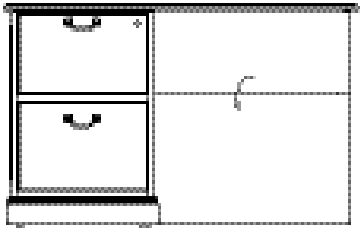

**M34**  
Drop Door Tech Modesty

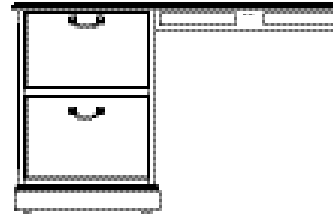
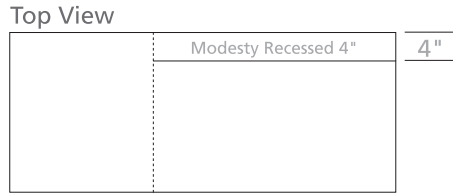

**M51**  
Open Back Modesty with 4" Wire Management Rail

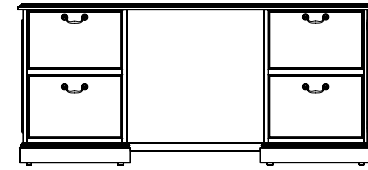

**M37**  
Fixed Full Modesty

## Grain direction

Veneer chassis parts are vertical grain. Doors feature vertical veneer bookmatched horizontally in sets of 2, 4, and 6 doors. Tower fronts are matched in vertical sets.



Desk

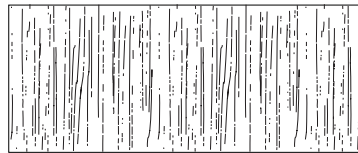

Runoff Desk  
Grain Direction on TFL  
Units Above 66" runs end to end

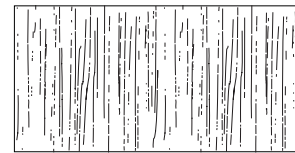

Bridge  
Grain Direction on TFL  
Units Above 66" runs end to end

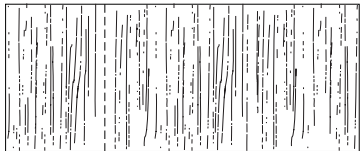

Return  
Grain Direction on TFL Units  
Above 66" runs end to end

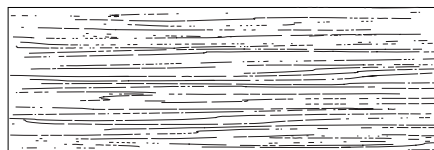

Credenza

### Interior drawer dimensions

UNIT DEPTH	DRAWER TYPE	OVERALL DIMENSIONS			INTERIOR DRAWER DIMENSIONS			NOTES
		W	D	H	W	D	H	
15-5/8" Letter	36" Box	13-1/8	19-11/16	4	12-1/8	18-11/16	3-7/16	Units less than 72"
	36" File	13-1/8	19-11/16	9-13/16	12-1/8	18-11/16	9-5/16	Units less than 72"
	30" Box	13-1/8	19-11/16	4	12-1/8	18-11/16	3-7/16	Units less than 72"
	30" File	13-1/8	19-11/16	9-13/16	12-1/8	18-11/16	9-5/16	Units less than 72"
	24" Box	13-1/8	16-1/16	4	12-1/8	15-1/16	3-7/16	Units less than 72"
	24" File	13-1/8	16-1/16	9-13/16	12-1/8	15-1/16	9-5/16	Units less than 72"
29" Lateral	24" Box	26-1/2	16-1/16	4	25-1/2	15-1/16	3-7/16	Workstation Credenzas less than 82"
	24" File	26-1/2	16-1/16	9-13/16	25-1/2	15-1/16	9-5/16	Workstation Credenzas less than 82"
35" Lateral	24" Box	32-1/2	16-1/16	4	31-1/2	15-1/16	3-7/16	Workstation Credenzas over 83"
	24" File	32-1/2	16-1/16	9-13/16	31-1/2	15-1/16	9-5/16	Workstation Credenzas over 83"
41" Lateral	24" File	38-1/2	16-1/16	9-13/16	37-1/2	15-1/16	9-5/16	Wood Drawer Only

### Filing reference

#### Filing for 24" depth units

13 1/8" Wide File Drawer - 16 1/16" Deep

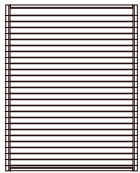

Letter Front to Back

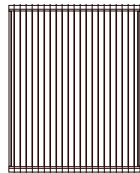

Legal Side to Side with File Rail

#### 29" Lateral file drawer

26-1/2" Wide File Drawer - 16-1/16" Deep

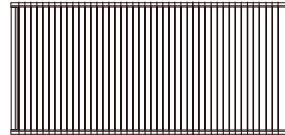

Legal Side to Side

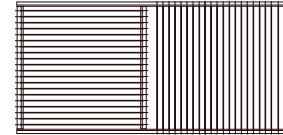

Legal Side to Side Letter Front to Back with File Rail

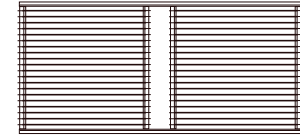

Letter Front to Back with File Rail

#### Filing for 30" & 36" depth units

13 1/8" Wide File Drawer - 19 11/16" Deep



Letter Front to Back

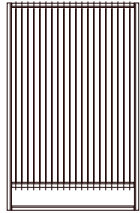

Legal Side to Side with File Rail

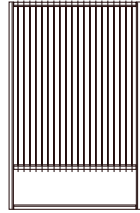

Letter Side to Side with File Rail

#### 35" Lateral File Drawer

32-1/2" Wide File Drawer - 16-1/16" Deep

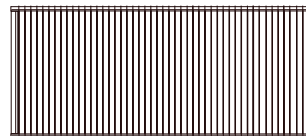

Legal Side to Side

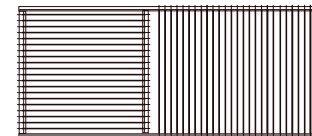

Legal Side to Side Letter Front to Back with File Rail

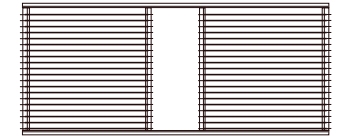

Letter Front to Back with File Rail

# Richmond Park

Double Pedestal Desks  
Executive Chassis Breakfront

[Click here to view statement of line](#)

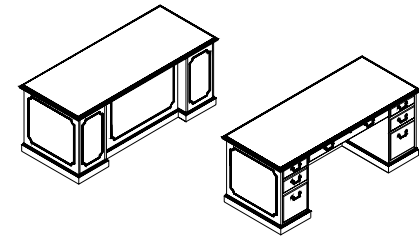

## 1 Select Model

w" x d" x h"	Weight
84 x 36 x 30	350
72 x 36 x 30	335
72 x 30 x 30	320
66 x 36 x 30	315
66 x 30 x 30	275
60 x 30 x 30	230

Standard Veneer Top Standard Veneer Chassis		Premium Veneer Top Premium Veneer Chassis		High Pressure Laminate Top Veneer Chassis		Thermally Fused Laminate Top Thermally Fused Laminate Chassis	
RPC8436DD000W	5542	"P" Option N/A		RPC8436DD000G	5542	"M" Option N/A	
RPC7236DD000W	4993	"P" Option N/A		RPC7236DD000G	4993	"M" Option N/A	
RPC7230DD000W	4896	"P" Option N/A		RPC7230DD000G	4896	"M" Option N/A	
RPC6636DD000W	4896	"P" Option N/A		RPC6636DD000G	4896	"M" Option N/A	
RPC6630DD000W	4776	"P" Option N/A		RPC6630DD000G	4776	"M" Option N/A	
RPC6030DD000W	4426	"P" Option N/A		RPC6030DD000G	4426	"M" Option N/A	

## Product Features

- Box/Box/File
- Full extension drawers - locking
- Drawer fronts w/ profile edges
- Full modesty w/ base
- Laminate pull out writing shelf
- Soft close suspension drawer(s)
- Center Drawer Standard

## Options

### Accessories

- K28: Articulating Keyboard w/ Mouse pad (removes center drawer) - \$390

### Drawer

- P6: Modify Box/Box/File to File/File - \$55 per pedestal
- P33: Wood Drawer Upgrade - \$45 per drawer

### Grommets (Standard Location)

Specify Color and Location Right/Left - \$50 ea.

- Black: TM30-R (Right), TM30-L (Left)
- Silver: TM31-R (Right), TM31-L (Left)
- Antique Brass: TM33-R (Right), TM33-L (Left)

### Grommets (Non-Standard Location)

Provide drawing w/ Grommet Location and Specify Color - \$95 ea.

- Black: TM30-NS
- Silver: TM31-NS
- Antique Brass: TM33-NS

### Molding

- DSM1: Delete molding - Deduct \$95

## 2 Select Finish

[Click to view finishes](#)

## 3 Select Edge

[Click to view edges](#)



## 4 Select Hardware

[Click to view details](#)



# Richmond Park

Double Pedestal Desks  
Bowfront / Breakfront Executive Chassis

[Click here to view statement of line](#)

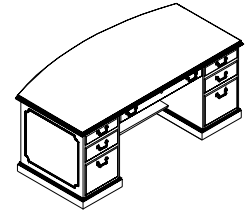
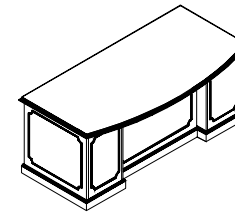

## 1 Select Model

w" x d" x h"	Weight
84 x 36/42 x 30	370
72 x 36/42 x 30	350
72 x 30/36 x 30	340
66 x 30/36 x 30	325

Standard Veneer Top Standard Veneer Chassis	Premium Veneer Top Premium Veneer Chassis	High Pressure Laminate Top Veneer Chassis	Thermally Fused Laminate Top Thermally Fused Laminate Chassis
RPC8442DD006W 6083 RPC7242DD006W 5534 RPC7236DD006W 5324 RPC6636DD006W 5229	"P" Option N/A "P" Option N/A "P" Option N/A "P" Option N/A	RPC8442DD006G 6083 RPC7242DD006G 5534 RPC7236DD006G 5324 RPC6636DD006G 5229	"M" Option N/A "M" Option N/A "M" Option N/A "M" Option N/A

## Product Features

- Box/Box/File
- Center Drawer standard
- Drawer fronts w/ profile edges
- Full extension drawers - locking
- Full fixed modesty w/ base
- Laminate pull out writing shelf
- Soft close suspension drawer(s)

## Notes

- 6" overhang on approach

## Options

### Accessories

- K28: Articulating Keyboard w/ Mouse pad (removes center drawer)
- \$390

### Drawer

- P6: Modify Box/Box/File to File/File - \$55 per pedestal
- P33: Wood Drawer Upgrade - \$45 per drawer

### Grommets (Standard Location)

- Specify Color and Location Right/Left - \$50 ea.
- Black: TM30-R (Right), TM30-L (Left)
  - Silver: TM31-R (Right), TM31-L (Left)
  - Antique Brass: TM33-R (Right), TM33-L (Left)

### Grommets (Non-Standard Location)

- Provide drawing w/ Grommet Location and Specify Color - \$95 ea.
- Black: TM30-NS
  - Silver: TM31-NS
  - Antique Brass: TM33-NS

### Molding

- DSM1: Delete molding - Deduct \$95

## 2 Select Finish

[Click to view finishes](#)

## 3 Select Edge

[Click to view edges](#)



## 4 Select Hardware

[Click to view details](#)



# Richmond Park

Desks  
Crt Desk / Printer

[Click here to view statement of line](#)

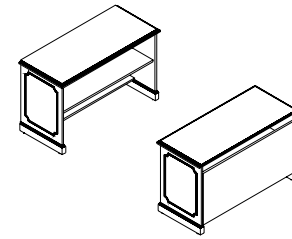

### 1 Select Model

w" x d" x h"	Weight
48 x 24 x 30	130
42 x 24 x 30	120
36 x 24 x 30	110

Standard Veneer Top Standard Veneer Chassis		Premium Veneer Top Premium Veneer Chassis		High Pressure Laminate Top Veneer Chassis		Thermally Fused Laminate Top Thermally Fused Laminate Chassis	
RPC4824AU225W	2541	"P" Option N/A		RPC4824AU225G	2541	"M" Option N/A	
RPC4224AU225W	2453	"P" Option N/A		RPC4224AU225G	2453	"M" Option N/A	
RPC3624AU225W	2393	"P" Option N/A		RPC3624AU225G	2393	"M" Option N/A	

### Product Features

- 6" Storage foot shelf
- Adjustable shelf
- Wire/Paper access back

### Options

#### Grommets (Standard Location)

- Specify Color - \$50 ea.
- Black: TM30-C (Center)
  - Silver: TM31-C (Center)
  - Antique Brass: TM33-C (Center)

#### Grommets (Non-Standard Location)

- Provide drawing w/ Grommet Location and Specify Color - \$95 ea.
- Black: TM30-NS
  - Silver: TM31-NS
  - Antique Brass: TM33-NS

#### Grommets (Vertical Surface)

- Standard Location - \$50 ea.
- Black Plastic Vertical Surface: TM50-C (Bottom Center)
- Non-Standard Location - \$95 ea.
- Black Plastic Vertical Surface: TM50-NS

#### Molding

- DSM2: Delete molding - Deduct \$50

[Click to view finishes](#)

### 3 Select Edge

[Click to view edges](#)



### 4 Select Hardware

[Click to view details](#)

Hardware  
N/A

Hardware  
N/A

# Richmond Park

Workstation Desks  
Executive Breakfront Chassis Single Pedestal Desk

[Click here to view statement of line](#)

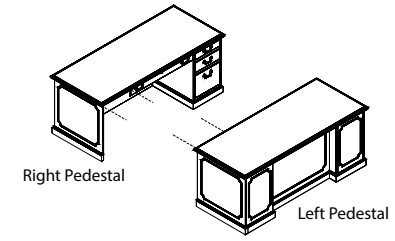

## 1 Select Model

w" x d" x h"	Weight
Left Pedestal	
72 x 36 x 30	290
72 x 30 x 30	255
66 x 36 x 30	275
66 x 30 x 30	250
Right Pedestal	
72 x 36 x 30	290
72 x 30 x 30	255
66 x 36 x 30	275
66 x 30 x 30	250

Standard Veneer Top Standard Veneer Chassis	Premium Veneer Top Premium Veneer Chassis	High Pressure Laminate Top Veneer Chassis	Thermally Fused Laminate Top Thermally Fused Laminate Chassis
RPC7236DS009W 4303	"P" Option N/A	RPC7236DS009G 4303	"M" Option N/A
RPC7230DS009W 4260	"P" Option N/A	RPC7230DS009G 4260	"M" Option N/A
RPC6636DS009W 4198	"P" Option N/A	RPC6636DS009G 4198	"M" Option N/A
RPC6630DS009W 4086	"P" Option N/A	RPC6630DS009G 4086	"M" Option N/A
RPC7236DS010W 4303	"P" Option N/A	RPC7236DS010G 4303	"M" Option N/A
RPC7230DS010W 4260	"P" Option N/A	RPC7230DS010G 4260	"M" Option N/A
RPC6636DS010W 4198	"P" Option N/A	RPC6636DS010G 4198	"M" Option N/A
RPC6630DS010W 4086	"P" Option N/A	RPC6630DS010G 4086	"M" Option N/A

## Product Features

- Box/Box/File
- Drawer fronts w/ profile edges
- Full extension drawers - locking
- Full fixed modesty w/ base
- Hookup hardware
- Laminate pull out writing shelf
- Soft close suspension drawer(s)
- Center Drawer Standard

## Options

### Drawer

- P33: Wood Drawer Upgrade - \$45 per drawer
- P6: Modify Box/Box/File to File/File - \$55 per pedestal
- K28: Articulating Keyboard w/ Mouse pad (removes center drawer) - \$390

### Grommets (Standard Location)

- Specify Color and Location Right/Left - \$50 ea.
- Black: TM30-R (Right), TM30-L (Left)
  - Silver: TM31-R (Right), TM31-L (Left)
  - Antique Brass: TM33-R (Right), TM33-L (Left)

### Grommets (Non-Standard Location)

- Provide drawing w/ Grommet Location and Specify Color - \$95 ea.
- Black: TM30-NS
  - Silver: TM31-NS
  - Antique Brass: TM33-NS

### Molding

- DSM1: Delete molding - Deduct \$95

## 2 Select Finish

[Click to view finishes](#)

## 3 Select Edge

[Click to view edges](#)



## 4 Select Hardware

[Click to view details](#)





# Richmond Park

Workstation Desks

Bowfront / Breakfront Executive Chassis Single Pedestal Desk

[Click here to view statement of line](#)

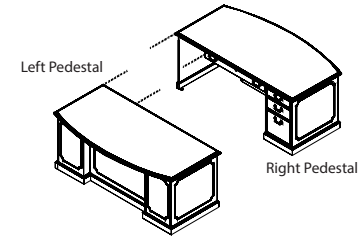

## 1 Select Model

w" x d" x h"

	Weight
<b>Left Pedestal</b>	
84 x 36/42 x 30	350
72 x 36/42 x 30	315
72 x 30/36 x 30	295
66 x 36/42 x 30	285
66 x 30/36 x 30	275
<b>Right Pedestal</b>	
84 x 36/42 x 30	350
72 x 36/42 x 30	315
72 x 30/36 x 30	295
66 x 36/42 x 30	285
66 x 30/36 x 30	275

	Standard Veneer Top Standard Veneer Chassis	Premium Veneer Top Premium Veneer Chassis	High Pressure Laminate Top Veneer Chassis	Thermally Fused Laminate Top Thermally Fused Laminate Chassis
		"P" Option N/A	RPC8442DS017G 5071	"M" Option N/A
	RPC8442DS017W 5071	"P" Option N/A	RPC7242DS017G 4767	"M" Option N/A
	RPC7242DS017W 4767	"P" Option N/A	RPC7236DS017G 4705	"M" Option N/A
	RPC7236DS017W 4705	"P" Option N/A	RPC6642DS017G 4661	"M" Option N/A
	RPC6642DS017W 4661	"P" Option N/A	RPC6636DS017G 4532	"M" Option N/A
	RPC6636DS017W 4532			
		"P" Option N/A	RPC8442DS018G 5071	"M" Option N/A
	RPC8442DS018W 5071	"P" Option N/A	RPC7242DS018G 4767	"M" Option N/A
	RPC7242DS018W 4767	"P" Option N/A	RPC7236DS018G 4705	"M" Option N/A
	RPC7236DS018W 4705	"P" Option N/A	RPC6642DS018G 4661	"M" Option N/A
	RPC6642DS018W 4661	"P" Option N/A	RPC6636DS018G 4532	"M" Option N/A
	RPC6636DS018W 4532			

## Product Features

- 6" Overhang on approach
- Box/Box/File
- Drawer fronts w/ profile edges
- Full extension drawers - locking
- Full fixed modesty w/ base
- Hookup hardware
- Laminate pull out writing shelf
- Soft close suspension drawer(s)
- Center Drawer Standard

## Options

### Drawer

- K28: Articulating Keyboard w/ Mouse pad (removes center drawer) - \$390
- P6: Modify Box/Box/File to File/File - \$55 per pedestal
- P33: Wood Drawer Upgrade - \$45 per drawer

### Grommets (Standard Location)

- Specify Color and Location Right/Left - \$50 ea.
- Black: TM30-R (Right), TM30-L (Left)
  - Silver: TM31-R (Right), TM31-L (Left)
  - Antique Brass: TM33-R (Right), TM33-L (Left)

### Grommets (Non-Standard Location)

- Provide drawing w/ Grommet Location and Specify Color - \$95 ea.
- Black: TM30-NS
  - Silver: TM31-NS
  - Antique Brass: TM33-NS

### Molding

- DSM1: Delete molding - Deduct \$95

## 2 Select Finish

[Click to view finishes](#)

## 3 Select Edge

[Click to view edges](#)



## 4 Select Hardware

[Click to view details](#)



# Richmond Park

Workstation Desks  
Bullet Conference Desk

[Click here to view statement of line](#)

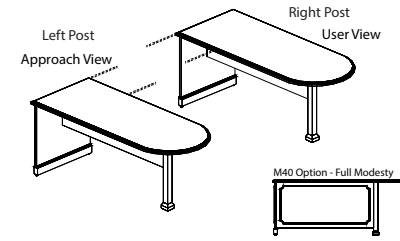

## 1 Select Model

w" x d" x h"

	Weight
Left Post	
72 x 36 x 30	160
72 x 30 x 30	150
66 x 30 x 30	140
60 x 30 x 30	125
Right Post	
72 x 36 x 30	160
72 x 30 x 30	150
66 x 30 x 30	140
60 x 30 x 30	125

	Standard Veneer Top Standard Veneer Chassis	Premium Veneer Top Premium Veneer Chassis	High Pressure Laminate Top Veneer Chassis	Thermally Fused Laminate Top Thermally Fused Laminate Chassis
		"P" Option N/A	RPC7236DC716G 3388	"M" Option N/A
	RPC7236DC716W 3388		RPC7230DC716G 3283	"M" Option N/A
	RPC7230DC716W 3283	"P" Option N/A	RPC6636DC716G 3161	"M" Option N/A
	RPC6630DC716W 3161		RPC6030DC716G 3065	"M" Option N/A
	RPC6030DC716W 3065	"P" Option N/A		
		"P" Option N/A	RPC7236DC715G 3388	"M" Option N/A
	RPC7236DC715W 3388		RPC7230DC715G 3283	"M" Option N/A
	RPC7230DC715W 3283	"P" Option N/A	RPC6630DC715G 3161	"M" Option N/A
	RPC6630DC715W 3161		RPC6030DC715G 3065	"M" Option N/A
	RPC6030DC715W 3065	"P" Option N/A		

## 2 Select Finish

[Click to view finishes](#)

## 3 Select Edge

[Click to view edges](#)



## 4 Select Hardware

[Click to view details](#)

Hardware  
N/A

Hardware  
N/A

## Product Features

- 12" Modesty panel standard
- End panel w/ solid hardwood base
- Solid hardwood square post

## Notes

- "P" Tops and Bullets are not intended to be freestanding

## Options

### Accessories

- K28: Articulating Keyboard w/ Mouse pad - \$390
- K30: Traditional Center Drawer - \$205

### Grommets (Standard Location)

- Specify Color - \$50 ea.
- Black: TM30-C (Center)
  - Silver: TM31-C (Center)
  - Antique Brass: TM33-C (Center)

### Grommets (Non-Standard Location)

Provide drawing w/ Grommet Location and Specify Color - \$95 ea.

- Black: TM30-NS
- Silver: TM31-NS
- Antique Brass: TM33-NS

### Modesty

- M40: Fixed Full Modesty - \$205

# Richmond Park

Workstation Returns  
Box / Box / File

[Click here to view statement of line](#)

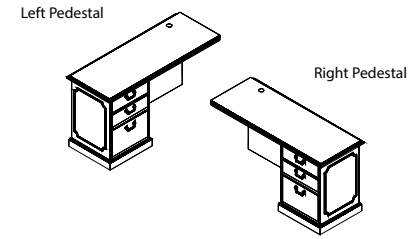

## 1 Select Model

w" x d" x h"	Weight
60 x 24 x 30	165
54 x 24 x 30	155
48 x 24 x 30	145
42 x 24 x 30	135
Right Pedestal	
60 x 24 x 30	165
54 x 24 x 30	155
48 x 24 x 30	145
42 x 24 x 30	135

Standard Veneer Top Standard Veneer Chassis		Premium Veneer Top Premium Veneer Chassis		High Pressure Laminate Top Veneer Chassis		Thermally Fused Laminate Top Thermally Fused Laminate Chassis	
"P" Option N/A		"P" Option N/A		"M" Option N/A		"M" Option N/A	
"P" Option N/A		"P" Option N/A		"M" Option N/A		"M" Option N/A	
"P" Option N/A		"P" Option N/A		"M" Option N/A		"M" Option N/A	
"P" Option N/A		"P" Option N/A		"M" Option N/A		"M" Option N/A	
"P" Option N/A		"P" Option N/A		"M" Option N/A		"M" Option N/A	
"P" Option N/A		"P" Option N/A		"M" Option N/A		"M" Option N/A	
"P" Option N/A		"P" Option N/A		"M" Option N/A		"M" Option N/A	

## Product Features

- 1 Standard grommet - matches pull finish or specify black TM30, silver TM31 or antique brass TM33
- Drawer fronts w/ profile edges
- Full extension drawers - locking
- Full fixed modesty
- Soft close suspension drawer(s)

## Options

### Accessories

- K28: Articulating Keyboard w/ Mouse pad - \$390

### Drawer

- P33: Wood Drawer Upgrade - \$45 per drawer
- P40B: extra Box/Box/File or File/File to Kneespace - \$1,025

### Flush Cut

- FC-L: Flush Unit Left (Facing) for Ganging - \$100
- FC-R: Flush Unit Right(Facing) for Ganging - \$100

### Grommets (Non-Standard Location)

- Provide drawing w/ Grommet Location and Specify Color - \$95 ea.
- Black: TM30-NS
- Silver: TM31-NS
- Antique Brass: TM33-NS

### Modesty

- M34T: Drop Door Tech Modesty - \$130
- M51: Open Back Modesty with Wire Mgmt Rail - Deduct \$95

### Molding

- DSM2: Delete molding - Deduct \$50

## 2 Select Finish

[Click to view finishes](#)

## 3 Select Edge

[Click to view edges](#)



## 4 Select Hardware

[Click to view details](#)



# Richmond Park

Workstation Returns  
File / File

[Click here to view statement of line](#)

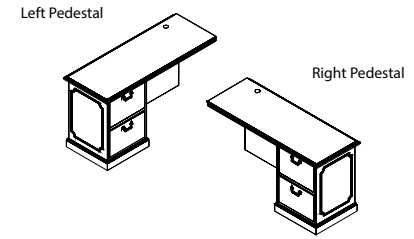

## 1 Select Model

w" x d" x h"	Weight
60 x 24 x 30	165
54 x 24 x 30	155
48 x 24 x 30	145
42 x 24 x 30	135
Right Pedestal	
60 x 24 x 30	165
54 x 24 x 30	155
48 x 24 x 30	145
42 x 24 x 30	135

	Standard Veneer Top Standard Veneer Chassis	Premium Veneer Top Premium Veneer Chassis	High Pressure Laminate Top Veneer Chassis	Thermally Fused Laminate Top Thermally Fused Laminate Chassis
Left Pedestal				
60 x 24 x 30	RPC6024RE195W 3256	"P" Option N/A	RPC6024RE195G 3256	"M" Option N/A
54 x 24 x 30	RPC5424RE195W 3125	"P" Option N/A	RPC5424RE195G 3125	"M" Option N/A
48 x 24 x 30	RPC4824RE195W 3001	"P" Option N/A	RPC4824RE195G 3001	"M" Option N/A
42 x 24 x 30	RPC4224RE195W 2934	"P" Option N/A	RPC4224RE195G 2934	"M" Option N/A
Right Pedestal				
60 x 24 x 30	RPC6024RE196W 3256	"P" Option N/A	RPC6024RE196G 3256	"M" Option N/A
54 x 24 x 30	RPC5424RE196W 3125	"P" Option N/A	RPC5424RE196G 3125	"M" Option N/A
48 x 24 x 30	RPC4824RE196W 3001	"P" Option N/A	RPC4824RE196G 3001	"M" Option N/A
42 x 24 x 30	RPC4224RE196W 2934	"P" Option N/A	RPC4224RE196G 2934	"M" Option N/A

## Product Features

- 1 Standard grommet - matches pull finish or specify black TM30, silver TM31 or antique brass TM33
- Drawer fronts w/ profile edges
- Full extension drawers - locking
- Full fixed modesty
- Soft close suspension drawer(s)

## Options

### Accessories

- K28: Articulating Keyboard w/ Mouse pad - \$390

### Drawer

- P33: Wood Drawer Upgrade - \$45 per drawer
- P40B: extra Box/Box/File or File/File to Kneespace - \$1,025

### Flush Cut

- FC-L: Flush Unit Left (Facing) for Ganging - \$100
- FC-R: Flush Unit Right(Facing) for Ganging - \$100

### Grommets (Non-Standard Location)

Provide drawing w/ Grommet Location and Specify Color - \$95 ea.

- Black: TM30-NS
- Silver: TM31-NS
- Antique Brass: TM33-NS

### Modesty

- M34T: Drop Door Tech Modesty - \$130
- M51: Open Back Modesty with Wire Mgmt Rail - Deduct \$95

### Molding

- DSM2: Delete molding - Deduct \$50

## 2 Select Finish

[Click to view finishes](#)

## 3 Select Edge

[Click to view edges](#)



## 4 Select Hardware

[Click to view details](#)



# Richmond Park

Workstation Units  
 Bridge W/ Fixed Full Modesty

[Click here to view statement of line](#)

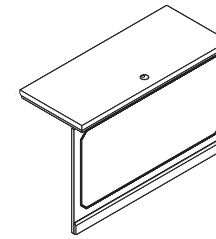

## 1 Select Model

w" x d" x h"	Weight
24" Deep Bridge	
54 x 24 x 30	95
48 x 24 x 30	90
42 x 24 x 30	85

Standard Veneer Top Standard Veneer Chassis		Premium Veneer Top Premium Veneer Chassis		High Pressure Laminate Top Veneer Chassis		Thermally Fused Laminate Top Thermally Fused Laminate Chassis	
RPC5424BR150W	1530	"P" Option N/A		RPC5424BR150G	1530	"M" Option N/A	
RPC4824BR150W	1424	"P" Option N/A		RPC4824BR150G	1424	"M" Option N/A	
RPC4224BR150W	1391	"P" Option N/A		RPC4224BR150G	1390	"M" Option N/A	

## Product Features

- Full modesty panel with base
- Top cope shaped for flush surface
- Top grommet

## Options

### Accessories

- K28: Articulating Keyboard w/ Mouse pad - \$390

### Grommets (Non-Standard Location)

Provide drawing w/ Grommet Location and Specify Color - \$95 ea.

- Black: TM30-NS
- Silver: TM31-NS
- Antique Brass: TM33-NS

### Molding

- DSM2: Delete molding - Deduct \$50

## 2 Select Finish

[Click to view finishes](#)

## 3 Select Edge

[Click to view edges](#)



## 4 Select Hardware

[Click to view details](#)

Hardware  
N/A

Hardware  
N/A

# Richmond Park

Credenzas / Files  
Storage Credenza

[Click here to view statement of line](#)

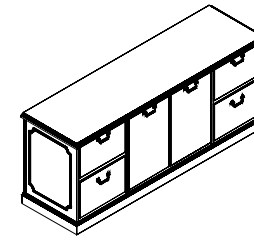

## 1 Select Model

w" x d" x h"  
File/ File  
72 x 24 x 30  
66 x 24 x 30  
Lateral File  
95 x 24 x 30  
89 x 24 x 30

Weight	Standard Veneer Top Standard Veneer Chassis	Premium Veneer Top Premium Veneer Chassis	High Pressure Laminate Top Veneer Chassis	Thermally Fused Laminate Top Thermally Fused Laminate Chassis
280	RPC7224CA050W 4260	"P" Option N/A	RPC7224CA050G 4260	"M" Option N/A
265	RPC6624CA050W 4086	"P" Option N/A	RPC6624CA050G 4086	"M" Option N/A
350	RPC9524CA651W 7601	"P" Option N/A	RPC9524CA651G 7601	"M" Option N/A
325	RPC8924CA651W 7234	"P" Option N/A	RPC8924CA651G 7234	"M" Option N/A

## Product Features

- Black adjustable shelf behind door set
- Drawer fronts w/ profile edges
- File/File
- Full continuous base under cabinets
- "W" & "G" SKUs feature soft close suspensions, "M" SKUs feature ball bearing suspensions. Both suspensions are full extension.

## Notes

- Unit has black back panel and is not designed for Open Plan use. Select OPB Option for Open Plan application

## Options

### Door

- D2: Door Lock - \$100 per door set
- D6A: "W" "G" Styles - Delete Doors and replace black laminate shelf with finished shelf - n/c
- D9SC: Soft Close Door Hinges - \$20 per door

### Drawer

- P6: Modify File/File to Box/Box/File - \$55 per pedestal
- P33: Wood Drawer Upgrade - \$45 per drawer

### Flush Cut

- FC-B: Flush Unit Both Sides(Facing) for Ganging - \$100
- FC-L: Flush Unit Left (Facing) for Ganging - \$100
- FC-R: Flush Unit Right(Facing) for Ganging - \$100

### Grommets (Standard Location)

- Specify Color and Location (Right/Left/Center) - \$50 ea.
- Black: TM30-R (Right), TM30-L (Left), TM30-C (Center)
- Silver: TM31-R (Right), TM31-L (Left), TM31-C (Center)
- Antique Brass: TM33-R (Right), TM33-L (Left), TM33-C (Center)

### Grommets (Non-Standard Location)

- Provide drawing w/ Grommet Location and Specify Color - \$95 ea.
- Black: TM30-NS
- Silver: TM31-NS
- Antique Brass: TM33-NS

### Molding

- DSM2: Delete molding - Deduct \$50

### Open Plan \_ Finished Back

- OPB: "W" "G" Style - Modify Unit for Open Plan Application - \$295

### Shelves

- S25: Replace Black Laminate Shelf with Finished Shelf - \$80 per shelf

## 2 Select Finish

[Click to view finishes](#)

WAC  
WIC  
WHC  
WOC  
WEW  
WGW  
WBW  
WSW  
WNW  
WWW

GAC  
GIC  
GHC  
GOC  
GEW  
GNW

## 3 Select Edge

[Click to view edges](#)



Richmond Classic



Richmond Classic

## 4 Select Hardware

[Click to view details](#)



PL-4 Antique Brass



PL-5 Antique Brass  
PL-50 Brushed Pewter



PL-4 Antique Brass



PL-5 Antique Brass  
PL-50 Brushed Pewter

# Richmond Park

Credenzas / Files  
Kneespace Credenza

[Click here to view statement of line](#)

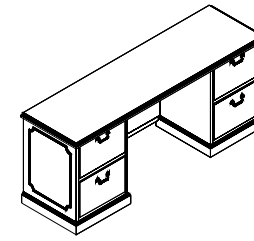

## 1 Select Model

w" x d" x h"	Weight
72 x 24 x 30	250
66 x 24 x 30	235
60 x 24 x 30	225

Standard Veneer Top Standard Veneer Chassis	Premium Veneer Top Premium Veneer Chassis	High Pressure Laminate Top Veneer Chassis	Thermally Fused Laminate Top Thermally Fused Laminate Chassis												
<table border="1"> <tr> <td>RPC7224CA054W</td> <td>3754</td> </tr> <tr> <td>RPC6624CA054W</td> <td>3528</td> </tr> <tr> <td>RPC6024CA054W</td> <td>3283</td> </tr> </table>	RPC7224CA054W	3754	RPC6624CA054W	3528	RPC6024CA054W	3283	<p>"P" Option N/A "P" Option N/A "P" Option N/A</p>	<table border="1"> <tr> <td>RPC7224CA054G</td> <td>3754</td> </tr> <tr> <td>RPC6624CA054G</td> <td>3528</td> </tr> <tr> <td>RPC6024CA054G</td> <td>3283</td> </tr> </table>	RPC7224CA054G	3754	RPC6624CA054G	3528	RPC6024CA054G	3283	<p>"M" Option N/A "M" Option N/A "M" Option N/A</p>
RPC7224CA054W	3754														
RPC6624CA054W	3528														
RPC6024CA054W	3283														
RPC7224CA054G	3754														
RPC6624CA054G	3528														
RPC6024CA054G	3283														

## 2 Select Finish

[Click to view finishes](#)

## 3 Select Edge

[Click to view edges](#)



## 4 Select Hardware

[Click to view details](#)

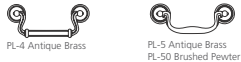

## Product Features

- Drawer fronts w/ profile edges
- File/File
- Full fixed modesty
- "W" & "G" SKUs feature soft close suspensions, "M" SKUs feature ball bearing suspensions. Both suspensions are full extension.

## Notes

- Unit has black back panel and is not designed for Open Plan use. Select OPB Option for Open Plan application

## Options

### Accessories

- K28: Articulating Keyboard w/ Mouse pad - \$390

### Drawer

- P6: Modify File/File to Box/Box/File - \$55 per pedestal
- P33: Wood Drawer Upgrade - \$45 per drawer

### Flush Cut

- FC-B: Flush Unit Both Sides(Facing) for Ganging - \$100
- FC-L: Flush Unit Left (Facing) for Ganging - \$100
- FC-R: Flush Unit Right(Facing) for Ganging - \$100

### Grommets (Standard Location)

Specify Color - \$50 ea.

- Black: TM30-C (Center)
- Silver: TM31-C (Center)
- Antique Brass: TM33-C (Center)

### Grommets (Non-Standard Location)

Provide drawing w/ Grommet Location and Specify Color - \$95 ea.

- Black: TM30-NS
- Silver: TM31-NS
- Antique Brass: TM33-NS

### Modesty

- M34T: Drop Door Tech Modesty - \$130
- M51: Open Back Modesty with Wire Mgmt Rail - Deduct \$95

### Open Plan \_ Finished Back

- OPB: "W" "G" Style - Modify Unit for Open Plan Application - \$295

### Molding

- DSM2: Delete molding - Deduct \$50

# Richmond Park

Credenzas

Storage Credenza

[Click here to view statement of line](#)

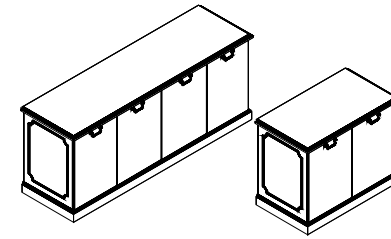

## 1 Select Model

w" x d" x h"	Weight
72 x 24 x 30	260
60 x 24 x 30	230
37 x 24 x 30	160
31 x 24 x 30	150

Standard Veneer Top Standard Veneer Chassis		Premium Veneer Top Premium Veneer Chassis		High Pressure Laminate Top Veneer Chassis		Thermally Fused Laminate Top Thermally Fused Laminate Chassis	
RPC7224CA125W	4173	"P" Option N/A		RPC7224CA125G	4173	"M" Option N/A	
RPC6024CA125W	3981	"P" Option N/A		RPC6024CA125G	3981	"M" Option N/A	
RPC3724CA125W	2382	"P" Option N/A		RPC3724CA125G	2382	"M" Option N/A	
RPC3124CA125W	2305	"P" Option N/A		RPC3124CA125G	2305	"M" Option N/A	

## Product Features

- Black adjustable shelf behind door set
- Door fronts w/ profile edges
- Full continuous base under cabinets

## Notes

- Unit has black back panel and is not designed for Open Plan use. Select OPB Option for Open Plan application

## Options

### Door

- D2: Door Lock - \$100 per door set
- D6A: "W" "G" Styles - Delete Doors and replace black laminate shelf with finished shelf - n/c
- D9SC: Soft Close Door Hinges - \$20 per door

### Flush Cut

- FC-B: Flush Unit Both Sides(Facing) for Ganging - \$100
- FC-L: Flush Unit Left (Facing) for Ganging - \$100
- FC-R: Flush Unit Right(Facing) for Ganging - \$100

### Grommets (Standard Location)

- Specify Color and Location (Right/Left/Center) - \$50 ea.
- Black: TM30-R (Right), TM30-L (Left), TM30-C (Center)
  - Silver: TM31-R (Right), TM31-L (Left), TM31-C (Center)
  - Antique Brass: TM33-R (Right), TM33-L (Left), TM33-C (Center)

### Grommets (Non-Standard Location)

- Provide drawing w/ Grommet Location and Specify Color - \$95 ea.
- Black: TM30-NS
  - Silver: TM31-NS
  - Antique Brass: TM33-NS

### Open Plan \_ Finished Back

- OPB: "W" "G" Style - Modify Unit for Open Plan Application - \$295

### Molding

- DSM2: Delete molding - Deduct \$50

### Shelves

- S25: Replace Black Laminate Shelf with Finished Shelf - \$80 per shelf

## 2 Select Finish

[Click to view finishes](#)

## 3 Select Edge

[Click to view edges](#)



## 4 Select Hardware

[Click to view details](#)





# Richmond Park

Lateral File Credenzas  
Horizontal Lateral File

[Click here to view statement of line](#)

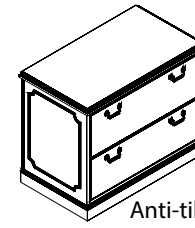

Anti-tilt Safety Drawer Lock

## 1 Select Model

w" x d" x h"

Weight	Standard Veneer Top Standard Veneer Chassis	Premium Veneer Top Premium Veneer Chassis	High Pressure Laminate Top Veneer Chassis	Thermally Fused Laminate Top Thermally Fused Laminate Chassis
4 Drawer				
72 x 24 x 30	300	RPC7224CA104W 4608	RPC7224CA104G 4608	"M" Option N/A
60 x 24 x 30	275	RPC6024CA104W 4314	RPC6024CA104G 4314	"M" Option N/A
2 Drawer				
43 x 24 x 30	175	RPC4324CA104W 2797	RPC4324CA104G 2797	"M" Option N/A
37 x 24 x 30	165	RPC3724CA104W 2514	RPC3724CA104G 2514	"M" Option N/A
31 x 24 x 30	155	RPC3124CA104W 2429	RPC3124CA104G 2429	"M" Option N/A

## 2 Select Finish

[Click to view finishes](#)

## 3 Select Edge

[Click to view edges](#)



Richmond Classic



Richmond Classic

## 4 Select Hardware

[Click to view details](#)



PL-4 Antique Brass



PL-5 Antique Brass  
PL-50 Brushed Pewter



PL-4 Antique Brass



PL-5 Antique Brass  
PL-50 Brushed Pewter

## Product Features

- Anti-tilt safety drawer lock
- Drawer fronts w/ profile edges
- Legal/Double letter filing
- Features ball bearing suspensions, suspensions are full extension

## Notes

- Unit has black back panel and is not designed for Open Plan use. Select OPB Option for Open Plan application

## Options

### Drawer

- P33: Wood Drawer Upgrade - \$45 per drawer

### Flush Cut

- FC-B: Flush Unit Both Sides(Facing) for Ganging - \$100
- FC-L: Flush Unit Left (Facing) for Ganging - \$100
- FC-R: Flush Unit Right(Facing) for Ganging - \$100

### Grommets (Standard Location)

Specify Color and Location (Right/Left/Center) - \$50 ea.

- Black: TM30-R (Right), TM30-L (Left), TM30-C (Center)
- Silver: TM31-R (Right), TM31-L (Left), TM31-C (Center)
- Antique Brass: TM33-R (Right), TM33-L (Left), TM33-C (Center)

### Grommets (Non-Standard Location)

Provide drawing w/ Grommet Location and Specify Color - \$95 ea.

- Black: TM30-NS
- Silver: TM31-NS
- Antique Brass: TM33-NS

### Open Plan \_ Finished Back

- OPB: "W" "G" Style - Modify Unit for Open Plan Application - \$295

### Molding

- DSM2: Delete molding - Deduct \$50

# Richmond Park

Credenzas / Files  
Vertical Lateral File

[Click here to view statement of line](#)

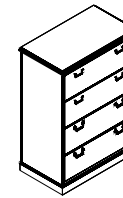

Anti-tilt Safety Drawer Lock

## 1 Select Model

w" x d" x h"	Weight
43 x 24 x 52	300
37 x 24 x 52	275
31 x 24 x 52	245

Standard Veneer Top Standard Veneer Chassis		Premium Veneer Top Premium Veneer Chassis		High Pressure Laminate Top Veneer Chassis		Thermally Fused Laminate Top Thermally Fused Laminate Chassis	
--	--	--	--	--	--	--	--

RPC4324FI111W	5529	"P" Option N/A		RPC4324FI111G	5529	"M" Option N/A	
RPC3724FI111W	4712	"P" Option N/A		RPC3724FI111G	4712	"M" Option N/A	
RPC3124FI111W	4601	"P" Option N/A		RPC3124FI111G	4601	"M" Option N/A	

## Product Features

- Anti-tilt safety drawer lock
- Legal/Double letter filing
- Features ball bearing suspensions, suspensions are full extension

## Notes

- Unit has black back panel and is not designed for Open Plan use. Select OPB Option for Open Plan application

## Options

### Drawer

- P33: Wood Drawer Upgrade - \$45 per drawer

### Flush Cut

- FC-B: Flush Unit Both Sides(Facing) for Ganging - \$100
- FC-L: Flush Unit Left (Facing) for Ganging - \$100
- FC-R: Flush Unit Right(Facing) for Ganging - \$100

### Open Plan \_ Finished Back

- OPB: "W" "G" Style - Modify Unit for Open Plan Application - \$295

## 2 Select Finish

[Click to view finishes](#)

## 3 Select Edge

[Click to view edges](#)



Richmond Classic



Richmond Classic

## 4 Select Hardware

[Click to view details](#)



PL-4 Antique Brass



PL-5 Antique Brass  
PL-50 Brushed Pewter



PL-4 Antique Brass



PL-5 Antique Brass  
PL-50 Brushed Pewter



# Richmond Park

Workstation Credenza  
Lateral File

[Click here to view statement of line](#)

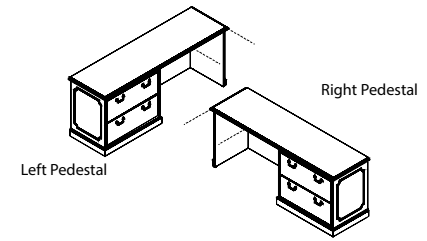

## 1 Select Model

w" x d" x h"	Weight
95 x 24 x 30	250
89 x 24 x 30	240
72 x 24 x 30	220
66 x 24 x 30	210
95 x 24 x 30	250
89 x 24 x 30	240
72 x 24 x 30	220
66 x 24 x 30	210

	Standard Veneer Top Standard Veneer Chassis	Premium Veneer Top Premium Veneer Chassis	High Pressure Laminate Top Veneer Chassis	Thermally Fused Laminate Top Thermally Fused Laminate Chassis
Left Pedestal	RPC9524CA066W 4232	"P" Option N/A	RPC9524CA066G 4232	"M" Option N/A
95 x 24 x 30	RPC8924CA066W 3869	"P" Option N/A	RPC8924CA066G 3869	"M" Option N/A
89 x 24 x 30	RPC7224CA066W 3500	"P" Option N/A	RPC7224CA066G 3500	"M" Option N/A
72 x 24 x 30	RPC6624CA066W 3395	"P" Option N/A	RPC6624CA066G 3395	"M" Option N/A
66 x 24 x 30	RPC9524CA067W 4232	"P" Option N/A	RPC9524CA067G 4232	"M" Option N/A
Right Pedestal	RPC8924CA067W 3869	"P" Option N/A	RPC8924CA067G 3869	"M" Option N/A
95 x 24 x 30	RPC7224CA067W 3500	"P" Option N/A	RPC7224CA067G 3500	"M" Option N/A
89 x 24 x 30	RPC6624CA067W 3395	"P" Option N/A	RPC6624CA067G 3395	"M" Option N/A
72 x 24 x 30				
66 x 24 x 30				

## Product Features

- Drawer fronts w/ profile edges
- Full fixed modesty
- Features ball bearing suspensions, suspensions are full extension.

## Notes

- Keyboard not available on 66" and 72"
- Unit has black back panel and is not designed for Open Plan use. Select OPB Option for Open Plan application

## Options

### Accessories

- K28: Articulating Keyboard w/ Mouse pad - \$390

### Drawer

- P33: Wood Drawer Upgrade - \$45 per drawer
- P40B: extra Box/Box/File or File/File to Kneespace - \$1,025

### Flush Cut

- FC-B: Flush Unit Both Sides(Facing) for Ganging - \$100
- FC-L: Flush Unit Left (Facing) for Ganging - \$100
- FC-R: Flush Unit Right(Facing) for Ganging - \$100

### Grommets (Standard Location)

- Specify Color - \$50 ea.
- Black: TM30-C (Center)
- Silver: TM31-C (Center)
- Antique Brass: TM33-C (Center)

### Grommets (Non-Standard Location)

- Provide drawing w/ Grommet Location and Specify Color - \$95 ea.
- Black: TM30-NS
- Silver: TM31-NS
- Antique Brass: TM33-NS

### Modesty

- M34T: Drop Door Tech Modesty - \$130
- M51: Open Back Modesty with Wire Mgmt Rail - Deduct \$95

### Open Plan \_ Finished Back

- OPB: "W" "G" Style - Modify Unit for Open Plan Application - \$295

### Molding

- DSM2: Delete molding - Deduct \$50

## 2 Select Finish

[Click to view finishes](#)

## 3 Select Edge

[Click to view edges](#)



## 4 Select Hardware

[Click to view details](#)



# Richmond Park

Overhead Consoles  
Freestanding - Panel Door

[Click here to view statement of line](#)

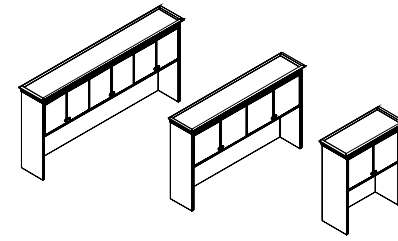

## 1 Select Model

w" x d" x h"	Weight
6 Door / 3 Section	
95 x 15 x 44	315
89 x 15 x 44	285
4 Door / 2 Section	
85 x 15 x 44	275
78 x 15 x 44	255
72 x 15 x 44	240
66 x 15 x 44	225
60 x 15 x 44	210
2 Door / 1 Section	
37 x 15 x 44	120
31 x 15 x 44	105

	Standard Veneer Top Standard Veneer Chassis	Premium Veneer Top Premium Veneer Chassis	High Pressure Laminate Top Veneer Chassis	Thermally Fused Laminate Top Thermally Fused Laminate Chassis
	RPC9544OH325W 5135	"P" Option N/A	"G" Option N/A	"M" Option N/A
	RPC8944OH325W 4609	"P" Option N/A	"G" Option N/A	"M" Option N/A
	RPC8544OH325W 4433	"P" Option N/A	"G" Option N/A	"M" Option N/A
	RPC7844OH325W 4259	"P" Option N/A	"G" Option N/A	"M" Option N/A
	RPC7244OH325W 3909	"P" Option N/A	"G" Option N/A	"M" Option N/A
	RPC6644OH325W 3457	"P" Option N/A	"G" Option N/A	"M" Option N/A
	RPC6044OH325W 3716	"P" Option N/A	"G" Option N/A	"M" Option N/A
	RPC3744OH325W 2506	"P" Option N/A	"G" Option N/A	"M" Option N/A
	RPC3144OH325W 2474	"P" Option N/A	"G" Option N/A	"M" Option N/A

## Product Features

- 2.5" Cornice top
- Door fronts w/ profile edges
- Interior cabinet depth 12.5"
- Top profile shaped 3 sides
- 5/8" grommet(s) included for task light wire management

## Notes

- Unit has black back panel and is not designed for Open Plan use. Select OPB Option for Open Plan application

## Options

### Door

- D2: Door Lock - \$100 per door
- D6: Delete Doors - n/c
- D9SC: Soft Close Door Hinges - \$20 per door

### Flush Cut

- FC-B: Flush Unit Both Sides(Facing) for Ganging - \$100
- FC-L: Flush Unit Left (Facing) for Ganging - \$100
- FC-R: Flush Unit Right(Facing) for Ganging - \$100

### Grommets (Vertical Surface)

- Standard Location - \$50 ea.
- Black Plastic Vertical Surface: TM50-C (Bottom Center)
- Non-Standard Location - \$95 ea.
- Black Plastic Vertical Surface: TM50-NS

### Open Plan \_ Finished Back

- OPB: "W" "G" Style - Modify Unit for Open Plan Application - \$395

### Task Lighting

Overhead task light cord is located on the right facing side. If the opposite location is required please contact customer service.

- LT-LED24: 24" LED Task light - \$215
- LT-LED48: 48" LED Task light - \$270
- LT-LED60: 60" LED Task light - \$335
- LT-LED72: 72" LED Task light - \$360

## 2 Select Finish

[Click to view finishes](#)

## 3 Select Edge

[Click to view edges](#)

Edge  
N/A

## 4 Select Hardware

[Click to view details](#)



Overhead tackboard  
Full width tackboards

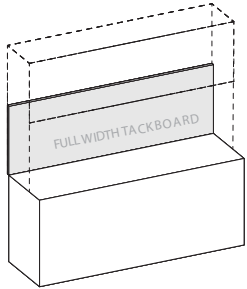

Product Width	Panel Dimension	SKU	COM	1	2	3	4	5	6	7	8	9	10	11/L1	12	13/L2
95	91 x .75 x 21	FTOC9121	379	480	531	582	633	684	735	786	837	888	939	990	1041	1143
89	85 x .75 x 21	FTOC8521	358	449	497	545	593	641	689	737	785	833	881	929	977	1073
85	81 x .75 x 21	FTOC8121	336	428	474	520	566	612	658	704	750	796	842	888	934	1026
78	74 x .75 x 21	FTOC7421	309	392	435	478	521	564	607	650	693	736	779	822	865	951
72	68 x .75 x 21	FTOC6821	282	361	401	441	481	521	561	601	641	681	721	761	801	881
66	62 x .75 x 21	FTOC6221	256	330	366	402	438	474	510	546	582	618	654	690	726	798
60	56 x .75 x 21	FTOC5621	234	299	331	363	395	427	459	491	523	555	587	619	651	715
49	45 x .75 x 21	FTOC4521	187	242	269	296	323	350	377	404	431	458	485	512	539	593
37	33 x .75 x 21	FTOC3321	141	180	200	220	240	260	280	300	320	340	360	380	400	440
31	27 x .75 x 21	FTOC2721	112	149	166	183	200	217	234	251	268	285	302	319	336	370

**Standard Features**

- Constructed of .5" thick fiberboard
- Fabric is precisely aligned and fitted to the tackboard
- Adhered to the rigid hardboard with staples
- Hung with Z-Strip mounting system

**Notes**

- Fabric Tack Panels are raised 3" from bottom edge when TM50 grommet is ordered

Overhead tackboard  
Half width tackboards

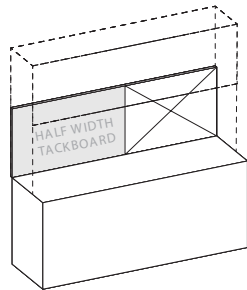

95 Half Width	45.5 x .75 x 21	FTOC4521	189	240	266	292	318	344	370	396	422	448	474	500	526	578
89 Half Width	42.5 x .75 x 21	FTOC4221	179	225	249	273	297	321	345	369	393	417	441	465	489	537
85 Half Width	40.5 x .75 x 21	FTOC4021	168	214	237	260	283	306	329	352	375	398	421	444	467	513
78 Half Width	37 x .75 x 21	FTOC3721	155	196	217	238	259	280	301	322	343	364	385	406	427	469
72 Half Width	34 x .75 x 21	FTOC3421	141	180	200	220	240	260	280	300	320	340	360	380	400	440
66 Half Width	31 x .75 x 21	FTOC3121	128	165	183	201	219	237	255	273	291	309	327	345	363	399

**Standard Features**

- Constructed of .5" thick fiberboard
- Fabric is precisely aligned and fitted to the tackboard
- Adhered to the rigid hardboard with staples
- Hung with Z-Strip mounting system

**Notes**

- Half width tackboards can be specified and combined with a Veneer Panel, Marker Board, or Glass Board. See "Half Width" items under product width.
- Specify right or left facing tackboard
- Fabric Tack Panels are raised 3" from bottom edge when TM50 grommet is ordered.

Overhead dry marker board  
Full width dry marker board

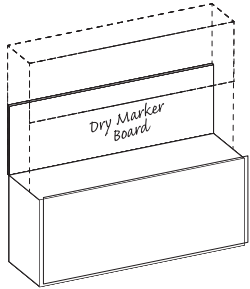

Product Width	Panel Dimension	SKU	List
95	91 x .5 x 21	DMOC9121	1136
89	85 x .5 x 21	DMOC8521	1061
85	81 x .5 x 21	DMOC8121	1011
78	74 x .5 x 21	DMOC7421	924
72	68 x .5 x 21	DMOC6821	849
66	62 x .5 x 21	DMOC6221	774
60	56 x .5 x 21	DMOC5621	699
49	45 x .5 x 21	DMOC4521	587
37	33 x .5 x 21	DMOC3321	437
31	27 x .5 x 21	DMOC2721	337

**Standard Features**

- Dry marker panel has edge trim molding
- Standard magnetic surface
- Hung with Z-Strip mounting system

Overhead dry marker board  
Half width dry marker board

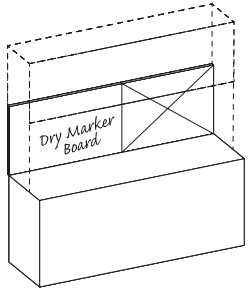

Product Width	Panel Dimension	SKU	List
95 Half Width	45.5 x .5 x 21	DMOC4521	555
89 Half Width	42.5 x .5 x 21	DMOC4221	518
85 Half Width	40.5 x .5 x 21	DMOC4021	493
78 Half Width	37 x .5 x 21	DMOC3721	449
72 Half Width	34 x .5 x 21	DMOC3421	437
66 Half Width	31 x .5 x 21	DMOC3121	374

**Standard Features**

- Dry marker panel has edge trim molding
- Standard magnetic surface
- Hung with Z-Strip mounting system

**Notes**

- Half width dry marker boards can be specified and combined with a Tackboard, Veneer Panel, or Glass Board. See "Half Width" items under product width.
- Specify right or left facing dry marker board

Overhead glassboard  
Full width glassboards

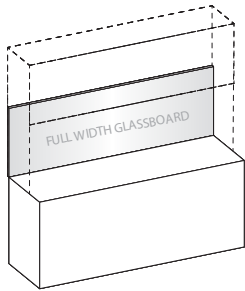

Product Width	Panel Dimension	SKU	List
95	91 x .5 x 21	GBOC9121	2382
89	85 x .5 x 21	GBOC8521	2236
85	81 x .5 x 21	GBOC8121	2138
78	74 x .5 x 21	GBOC7421	1969
72	68 x .5 x 21	GBOC6821	1822
66	62 x .5 x 21	GBOC6221	1676
60	56 x .5 x 21	GBOC5621	1531
49	45 x .5 x 21	GBOC4521	1264
37	33 x .5 x 21	GBOC3321	972
31	27 x .5 x 21	GBOC2721	826

**Standard Features**

- 4 mm tempered glass

**Notes**

- Earth magnets are required to hold items securely in place
- Hung with Z-Strip mounting system
- Use glass cleaner or alcohol to clean
- Standard dry erase markers may be used

Overhead glassboard  
Half width glassboards

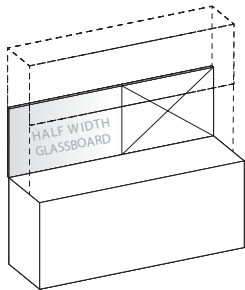

Product Width	Panel Dimension	SKU	List
95 Half Width	45.5 x .5 x 21	GBOC4521	1251
89 Half Width	42.5 x .5 x 21	GBOC4221	1178
85 Half Width	40.5 x .5 x 21	GBOC4021	1129
78 Half Width	37 x .5 x 21	GBOC3721	985
72 Half Width	34 x .5 x 21	GBOC3421	972
66 Half Width	31 x .5 x 21	GBOC3121	899

**Standard Features**

- 4 mm tempered glass
- Hung with Z-Strip mounting system

**Notes**

- Half width glassboards can be specified and combined with a Tackboard, Veneer panel, Marker Board. See "Half Width" items under product width.
- Must specify Right or left facing glassboard
- Use glass cleaner or alcohol to clean
- Standard dry erase markers may be used
- Earth magnets are required to hold items securely in place



# Richmond Park

Wall Hung Overheads  
Panel Doors

[Click here to view statement of line](#)

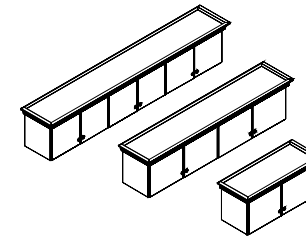

## 1 Select Model

w" x d" x h"	Weight
6 Door / 3 Section	
95 x 15 x 20	200
89 x 15 x 20	185
4 Door / 2 Section	
85 x 15 x 20	175
78 x 15 x 20	165
72 x 15 x 20	155
66 x 15 x 20	140
60 x 15 x 20	130
49 x 15 x 20	115
2 Door	
37 x 15 x 20	75
31 x 15 x 20	65

	Standard Veneer Top Standard Veneer Chassis	Premium Veneer Top Premium Veneer Chassis	High Pressure Laminate Top Veneer Chassis	Thermally Fused Laminate Top Thermally Fused Laminate Chassis
RPC9520WH330W 5048		"P" Option N/A	"G" Option N/A	"M" Option N/A
RPC8920WH330W 4872		"P" Option N/A	"G" Option N/A	"M" Option N/A
RPC8520WH330W 4305		"P" Option N/A	"G" Option N/A	"M" Option N/A
RPC7820WH330W 4126		"P" Option N/A	"G" Option N/A	"M" Option N/A
RPC7220WH330W 3952		"P" Option N/A	"G" Option N/A	"M" Option N/A
RPC6620WH330W 3703		"P" Option N/A	"G" Option N/A	"M" Option N/A
RPC6020WH330W 3377		"P" Option N/A	"G" Option N/A	"M" Option N/A
RPC4920WH330W 2993		"P" Option N/A	"G" Option N/A	"M" Option N/A
RPC3720WH330W 2310		"P" Option N/A	"G" Option N/A	"M" Option N/A
RPC3120WH330W 2267		"P" Option N/A	"G" Option N/A	"M" Option N/A

## 2 Select Finish

[Click to view finishes](#)

## 3 Select Edge

[Click to view edges](#)

Edge  
N/A

## 4 Select Hardware

[Click to view details](#)



## Product Features

- 2.5" Cornice top
- Door fronts w/ profile edges
- Interior cabinet depth 12"
- Mounting wall rail included
- Top profile shaped 3 sides

## Notes

- The DARRAN wall mounted cabinet(or shelf) must be hung on a weight-bearing wall. The suitability of the wall supporting the wall mounted cabinet, and the installation and maintenance of the wall-mounted cabinet, is the sole responsibility of the customer. Failure to correctly install and/or exceed the loaded weight capacity of this product may cause it to fall, resulting in damage to the product, adjacent property and/or bodily injury.

## Options

### Door

- D2: Door Lock - \$100 per door
- D6: Delete Doors - n/c
- D9SC: Soft Close Door Hinges - \$20 per door

### Flush Cut

- FC-B: Flush Unit Both Sides(Facing) for Ganging - \$100
- FC-L: Flush Unit Left (Facing) for Ganging - \$100
- FC-R: Flush Unit Right(Facing) for Ganging - \$100

### Task Lighting

Overhead task light cord is located on the right facing side. If the opposite location is required please contact customer service.

- LT-LED24: 24" LED Task light - \$215
- LT-LED48: 48" LED Task light - \$270
- LT-LED60: 60" LED Task light - \$335
- LT-LED72: 72" LED Task light - \$360

Wall hung tackboards  
Full width tackboards

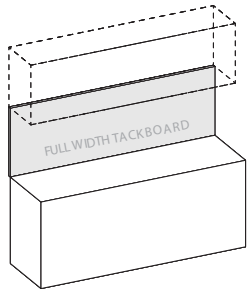

Product Width	Panel Dimension	SKU	COM	1	2	3	4	5	6	7	8	9	10	11/L1	12	13/L2
95	93 x .75 x 24	FTWH9324	465	576	627	678	729	780	831	882	933	984	1035	1086	1137	1239
89	87 x .75 x 24	FTWH8724	448	539	587	635	683	731	779	827	875	923	971	1019	1067	1163
85	83 x .75 x 24	FTWH8324	422	514	560	606	652	698	744	790	836	882	928	974	1020	1112
78	76 x .75 x 24	FTWH7624	388	471	514	557	600	643	686	729	772	815	858	901	944	1030
72	70 x .75 x 24	FTWH7024	355	434	474	514	554	594	634	674	714	754	794	834	874	954
66	64 x .75 x 24	FTWH6424	322	396	432	468	504	540	576	612	648	684	720	756	792	864
60	58 x .75 x 24	FTWH5824	294	359	391	423	455	487	519	551	583	615	647	679	711	775
49	47 x .75 x 24	FTWH4724	236	291	318	345	372	399	426	453	480	507	534	561	588	642
37	35 x .75 x 24	FTWH3524	176	217	237	257	277	297	317	337	357	377	397	417	437	477
31	29 x .75 x 24	FTWH2924	142	179	196	213	230	247	264	281	298	315	332	349	366	400

**Standard Features**

- Constructed of .5" thick fiberboard
- Fabric is precisely aligned and fitted to the tackboard
- Adhered to the rigid hardboard with staples

- Hung with Z-Strip mounting system

Wall hung tackboards  
Half width tackboards

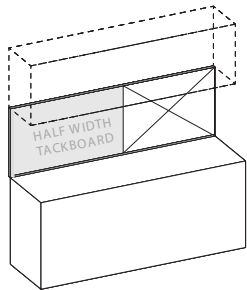

Product Width	Panel Dimension	SKU	COM	1	2	3	4	5	6	7	8	9	10	11/L1	12	13/L2
95 Half Width	46.5 x .75 x 24	FTWH4624	233	288	313	338	363	388	413	438	463	488	513	538	563	613
89 Half Width	43.5 x .75 x 24	FTWH4324	225	270	294	318	342	366	390	414	438	462	486	510	534	582
85 Half Width	41.5 x .75 x 24	FTWH4124	211	257	280	303	326	349	372	395	418	441	464	487	510	556
78 Half Width	38 x .75 x 24	FTWH3824	194	235	256	277	298	319	340	361	382	403	424	445	466	508
72 Half Width	35 x .75 x 24	FTWH3524	178	217	237	257	277	297	317	337	357	377	397	417	437	477
66 Half Width	32 x .75 x 24	FTWH3224	161	198	216	234	252	270	288	306	324	342	360	378	396	432

**Standard Features**

- Constructed of .5" thick fiberboard
- Fabric is precisely aligned and fitted to the tackboard
- Adhered to the rigid hardboard with staples
- Hung with Z-Strip mounting system

**Notes**

- Half width tackboards can be specified and combined with a Veneer Panel, Marker Board, or Glass Board. See "Half Width" items under product width.
- Specify right or left facing tackboard

Wall hung dry marker board  
Full width dry marker board

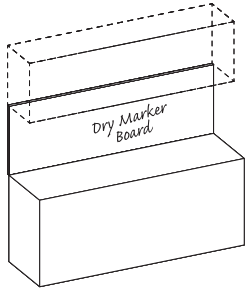

Product Width	Panel Dimension	SKU	List
95	93 x .75 x 24	DMWH9324	1161
89	87 x .75 x 24	DMWH8724	1086
85	83 x .75 x 24	DMWH8324	1023
78	76 x .5 x 24	DMWH7624	948
72	70 x .75 x 24	DMWH7024	874
66	64 x .75 x 24	DMWH6424	799
60	58 x .75 x 24	DMWH5824	724
49	47 x .75 x 24	DMWH4724	587
37	35 x .75 x 24	DMWH3524	437
31	29 x .75 x 24	DMWH2924	362

**Standard Features**

- Dry marker panel has edge trim molding
- Standard magnetic surface
- Hung with Z-Strip mounting system

Wall hung dry marker board  
Half width dry marker board

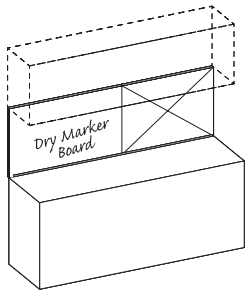

Product Width	Panel Dimension	SKU	List
95 Half Width	46.5 x .75 x 24	DMWH4624	580
89 Half Width	43.5 x .75 x 24	DMWH4324	543
85 Half Width	41.5 x .75 x 24	DMWH4124	518
78 Half Width	38 x .75 x 24	DMWH3824	474
72 Half Width	35 x .75 x 24	DMWH3524	437
66 Half Width	32 x .75 x 24	DMWH3224	399

**Standard Features**

- Dry marker panel has edge trim molding
- Standard magnetic surface
- Hung with Z-Strip mounting system

**Notes**

- Half width dry marker boards can be specified and combined with a Tackboard, Veneer Panel, or Glass Board. See "Half Width" items under product width.
- Specify right or left facing dry marker board

Wall hung veneer panel  
Full width veneer panel

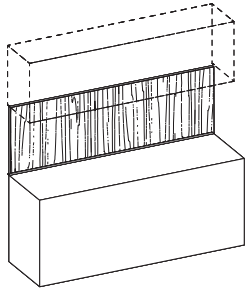

Product Width	Panel Dimension	SKU	List
95	93 x .75 x 24	VPWH9324	967
89	87 x .75 x 24	VPWH8724	905
85	83 x .75 x 24	VPWH8324	853
78	76 x .75 x 24	VPWH7624	790
72	70 x .75 x 24	VPWH7024	728
66	64 x .75 x 24	VPWH6424	666
60	58 x .75 x 24	VPWH5824	603
49	47 x .75 x 24	VPWH4724	489
37	35 x .75 x 24	VPWH3524	364
31	29 x .75 x 24	VPWH2924	302

**Standard Features**

- Veneer edges

**Notes**

- Vertical wire channels on back for task light cords
- Steel mounting wall channel is recessed for flush mounting
- Hung with Z-Strip mounting system
- Can be used with or without overhead cabinet
- Required for other accessory panels

Wall hung veneer panel  
Half width veneer panel

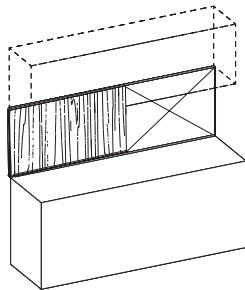

Product Width	Panel Dimension	SKU	List
95 Half Width	46.5 x .75 x 24	VPWH4624	484
89 Half Width	43.5 x .75 x 24	VPWH4324	452
85 Half Width	41.5 x .75 x 24	VPWH4124	432
78 Half Width	38 x .75 x 24	VPWH3824	395
72 Half Width	35 x .75 x 24	VPWH3524	364
66 Half Width	32 x .75 x 24	VPWH3224	333

**Standard Features**

- Veneer edges
- Vertical wire channels on back for task light cords
- Steel mounting wall channel is recessed for flush mounting
- Hung with Z-Strip mounting system

**Notes**

- Half width veneer panels can be specified and combined with a Tackboard, Marker Board, or Glass Board. See "Half Width" items under product width.
- Specify right or left facing veneer panel
- Can be used with or without overhead cabinet
- Required for other accessory panels

Wall hung glassboard  
Full width glassboards

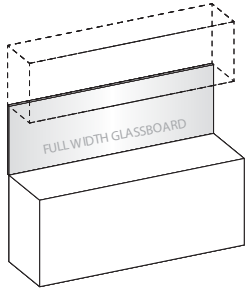

Product Width	Panel Dimension	SKU	List
95	93 x .75 x 24	GBWH9324	2753
89	87 x .75 x 24	GBWH8724	2586
85	83 x .75 x 24	GBWH8324	2475
78	76 x .75 x 24	GBWH7624	2281
72	70 x .75 x 24	GBWH7024	2114
66	64 x .75 x 24	GBWH6424	1948
60	58 x .75 x 24	GBWH5824	1780
49	47 x .75 x 24	GBWH4724	1476
37	35 x .75 x 24	GBWH3524	1142
31	29 x .75 x 24	GBWH2924	976

**Standard Features**

- 4 mm tempered glass

**Notes**

- Use glass cleaner or alcohol to clean
- Standard dry erase markers may be used
- Earth magnets are required to hold items securely in place
- Hung with Z-Strip mounting system

Wall hung glassboard  
Half width glassboards

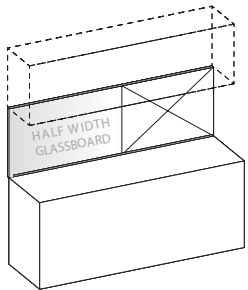

Product Width	Panel Dimension	SKU	List
95 Half Width	46.5 x .75 x 24	GBWH4624	1461
89 Half Width	43.5 x .75 x 24	GBWH4324	1378
85 Half Width	41.5 x .75 x 24	GBWH4124	1323
78 Half Width	38 x .75 x 24	GBWH3824	1232
72 Half Width	35 x .75 x 24	GBWH3524	1142
66 Half Width	32 x .75 x 24	GBWH3224	1059

**Standard Features**

- 4 mm tempered glass
- Hung with Z-Strip mounting system

**Notes**

- Half width glassboards can be specified and combined with a Tackboard, Veneer panel, Marker Board. See "Half Width" items under product width.
- Specify right or left facing glassboard
- Use glass cleaner or alcohol to clean
- Standard dry erase markers may be used
- Earth magnets are required to hold items securely in place

# Richmond Park

Assembled Overhead Bookcase / Hutch  
Panel Door

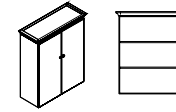

[Click here to view statement of line](#)

## 1 Select Model

w" x d" x h"	Weight
37 x 15 x 44.5	140
31 x 15 x 44.5	130

Standard Veneer Top Standard Veneer Chassis		Premium Veneer Top Premium Veneer Chassis	High Pressure Laminate Top Veneer Chassis	Thermally Fused Laminate Top Thermally Fused Laminate Chassis
RPC3744OH383W	2814	"P" Option N/A	"G" Option N/A	"M" Option N/A
RPC3144OH383W	2688	"P" Option N/A	"G" Option N/A	"M" Option N/A

## Product Features

- 2 Adjustable shelves
- 2.5" Cornice top
- Doors w/ profile edges
- Interior shelf depth 12"
- Top profile shaped 3 sides

## Notes

- Unit has black back panel and is not designed for Open Plan use. Select OPB Option for Open Plan application

## Options

### Door

- D2: Door Lock - \$100 per door
- D6: Delete Doors - n/c
- D9SC: Soft Close Door Hinges - \$20 per door

### Flush Cut

- FC-B: Flush Unit Both Sides(Facing) for Ganging - \$100
- FC-L: Flush Unit Left (Facing) for Ganging - \$100
- FC-R: Flush Unit Right(Facing) for Ganging - \$100

### Open Plan \_ Finished Back

- OPB: "W" "G" Style - Modify Unit for Open Plan Application - \$395

### Shelf

- GS14F: Replace Standard Shelves with Glass Shelves - \$90 per shelf
- S714F: Heavy Duty Lumber 1" Shelves - \$80 per shelf

## 2 Select Finish

[Click to view finishes](#)

- WAC
- WIC
- WHC
- WOC
- WEW
- WGW
- WBW
- WSW
- WNW
- WWW

## 3 Select Edge

[Click to view edges](#)

Edge  
N/A

## 4 Select Hardware

[Click to view details](#)



# Richmond Park

Assembled Overhead Bookcase / Hutch  
Wood Frame Door W/ beveled glass Insert

[Click here to view statement of line](#)

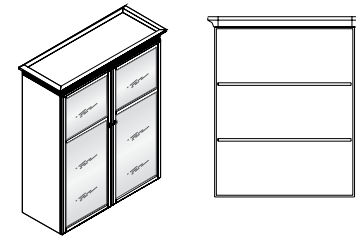

## 1 Select Model

w" x d" x h"	Weight
37 x 15 x 44.5	140
31 x 15 x 44.5	130

Standard Veneer Top Standard Veneer Chassis		Premium Veneer Top Premium Veneer Chassis	High Pressure Laminate Top Veneer Chassis	Thermally Fused Laminate Top Thermally Fused Laminate Chassis
RPC3744OH381W	3350	"P" Option N/A	"G" Option N/A	"M" Option N/A
RPC3144OH381W	3223	"P" Option N/A	"G" Option N/A	"M" Option N/A

## Product Features

- 2 Adjustable shelves
- 2.5" Cornice top
- Doors w/ profile edges
- Interior shelf depth 12"
- Top profile shaped 3 sides
- Wood frame doors w/ beveled glass inserts

## Notes

- Unit has black back panel and is not designed for Open Plan use. Select OPB Option for Open Plan application

## Options

### Door

- D2-G: Door Lock for Glass doors - \$205 per door
- D9SC: Soft Close Door Hinges - \$20 per door

### Flush Cut

- FC-B: Flush Unit Both Sides(Facing) for Ganging - \$100
- FC-L: Flush Unit Left (Facing) for Ganging - \$100
- FC-R: Flush Unit Right(Facing) for Ganging - \$100

### Interior Cabinet Lighting

- LEDPK starter kit includes Infeed, 1 Puck Interior Light and the ability to daisy chain up to 6 total Puck Lights
- LEDPK: LED Puck Starter Kit - \$310
- PK: 1 LED Interior Light - \$130

### Open Plan \_ Finished Back

- OPB: "W" "G" Style - Modify Unit for Open Plan Application - \$395

### Shelf

- GS14F: Replace Standard Shelves with Glass Shelves - \$90 per shelf
- S714F: Heavy Duty Lumber 1" Shelves - \$80 per shelf

## 2 Select Finish

[Click to view finishes](#)

## 3 Select Edge

[Click to view edges](#)

Edge  
N/A

## 4 Select Hardware

[Click to view details](#)



# Richmond Park

Vertical Half Towers  
Wardrobe / Storage

[Click here to view statement of line](#)

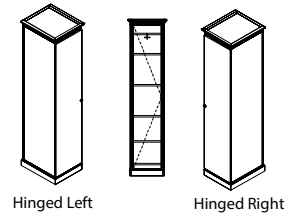

## 1 Select Model

w" x d" x h"  
Hinged Left  
17.75 x 24 x 77  
Hinged Right  
17.75 x 24 x 77

Weight	Standard Veneer Top Standard Veneer Chassis	Premium Veneer Top Premium Veneer Chassis	High Pressure Laminate Top Veneer Chassis	Thermally Fused Laminate Top Thermally Fused Laminate Chassis
160	RPC1777TW283W 3808	"P" Option N/A	"G" Option N/A	"M" Option N/A
160	RPC1777TW284W 3808	"P" Option N/A	"G" Option N/A	"M" Option N/A

## Product Features

- 2.5" Cornice top
- 3 Adjustable shelves / 1 Fixed
- 3.5" Traditional base
- Door fronts w/ profile edges
- Top profile shaped 3 sides
- Wardrobe w/ coat rod & hook

## Notes

- Unit has black back panel and is not designed for Open Plan use. Select OPB Option for Open Plan application

## Options

### Door

- D2: Door Lock - \$100 per door
- D9SC: Soft Close Door Hinges - \$20 per door

### Flush Cut

- FC-B: Flush Unit Both Sides(Facing) for Ganging - \$100
- FC-L: Flush Unit Left (Facing) for Ganging - \$100
- FC-R: Flush Unit Right(Facing) for Ganging - \$100

### Open Plan \_ Finished Back

- OPB: "W" "G" Style - Modify Unit for Open Plan Application - \$395

## 2 Select Finish

[Click to view finishes](#)

## 3 Select Edge

[Click to view edges](#)

Edge  
N/A

## 4 Select Hardware

[Click to view details](#)





# Richmond Park

Vertical Half Towers  
Storage / File/File With Mini-Wardrobe

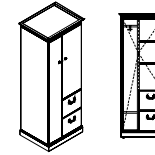

[Click here to view statement of line](#)

## 1 Select Model

w" x d" x h"  
Left Wardrobe  
28 x 24 x 77  
Right Wardrobe  
28 x 24 x 77

Weight	Standard Veneer Top Standard Veneer Chassis	Premium Veneer Top Premium Veneer Chassis	High Pressure Laminate Top Veneer Chassis	Thermally Fused Laminate Top Thermally Fused Laminate Chassis
220	RPC2877TW293W 5911	"P" Option N/A	"G" Option N/A	"M" Option N/A
220	RPC2877TW294W 5911	"P" Option N/A	"G" Option N/A	"M" Option N/A

## 2 Select Finish

[Click to view finishes](#)

## 3 Select Edge

[Click to view edges](#)

Edge  
N/A

## 4 Select Hardware

[Click to view details](#)



PL-4 Antique Brass



PL-5 Antique Brass  
PL-50 Brushed Pewter



DK-114 Brushed Pewter



DK-4 Antique Brass

## Product Features

- 2 Adjustable shelves
- 2.5" Cornice top
- 3.5" Traditional base
- Door/Drawer fronts w/ profile edges
- Full extension drawers - locking
- Soft close suspension drawer(s)
- Top profile shaped 3 sides

## Notes

- Unit has black back panel and is not designed for Open Plan use. Select OPB Option for Open Plan application

## Options

### Door

- D2: Door Lock - \$100 per door
- D9SC: Soft Close Door Hinges - \$20 per door

### Drawer

- P6: Modify File/File to Box/Box/File - \$55 per pedestal
- P33: Wood Drawer Upgrade - \$45 per drawer

### Flush Cut

- FC-B: Flush Unit Both Sides(Facing) for Ganging - \$100
- FC-L: Flush Unit Left (Facing) for Ganging - \$100
- FC-R: Flush Unit Right(Facing) for Ganging - \$100

### Open Plan \_ Finished Back

- OPB: "W" "G" Style - Modify Unit for Open Plan Application - \$395

# Richmond Park

Vertical Full Towers  
Freestanding Wardrobe / Storage

[Click here to view statement of line](#)

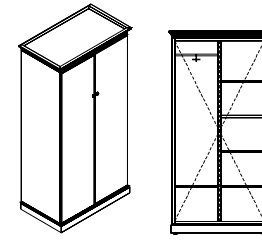

## 1 Select Model

w" x d" x h"	Weight
38.5 x 24 x 77	260
32.5 x 24 x 77	210

Standard Veneer Top Standard Veneer Chassis		Premium Veneer Top Premium Veneer Chassis	High Pressure Laminate Top Veneer Chassis	Thermally Fused Laminate Top Thermally Fused Laminate Chassis
RPC3877TW275W	5653	"P" Option N/A	"G" Option N/A	"M" Option N/A
RPC3277TW275W	5300	"P" Option N/A	"G" Option N/A	"M" Option N/A

## Product Features

- 2.5" Cornice top
- 3 Adjustable shelves
- 3.5" Traditional base
- Doors w/ profile edges
- Top profile shaped 3 sides
- Wardrobe w/ coat rod & hook

## Notes

- Pulls are located 26" from the top of the door and 1-5/8" from the edge.
- Unit has black back panel and is not designed for Open Plan use. Select OPB Option for Open Plan application

## Options

### Delete Center Partition

- MOD31OP: Delete Center Partition / Add (3) Full Width Adj. Shelves & (1) Fixed - \$295

### Door

- D2: Door Lock - \$100 per door
- D9SC: Soft Close Door Hinges - \$20 per door

### Flush Cut

- FC-B: Flush Unit Both Sides(Facing) for Ganging - \$100
- FC-L: Flush Unit Left (Facing) for Ganging - \$100
- FC-R: Flush Unit Right(Facing) for Ganging - \$100

### Open Plan \_ Finished Back

- OPB: "W" "G" Style - Modify Unit for Open Plan Application - \$395

## 2 Select Finish

[Click to view finishes](#)

## 3 Select Edge

[Click to view edges](#)

Edge  
N/A

## 4 Select Hardware

[Click to view details](#)



# Richmond Park

Vertical Full Towers  
Freestanding Lateral File / Storage

[Click here to view statement of line](#)

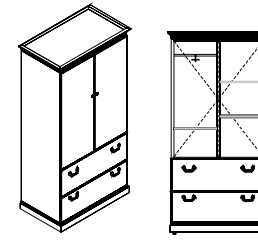

## 1 Select Model

w" x d" x h"	Weight
38.5 x 24 x 77	280
32.5 x 24 x 77	220

Standard Veneer Top Standard Veneer Chassis		Premium Veneer Top Premium Veneer Chassis	High Pressure Laminate Top Veneer Chassis	Thermally Fused Laminate Top Thermally Fused Laminate Chassis
RPC3877TW281W	6004	"P" Option N/A	"G" Option N/A	"M" Option N/A
RPC3277TW281W	5653	"P" Option N/A	"G" Option N/A	"M" Option N/A

## Product Features

- 2.5" Cornice top
- 3 Adjustable shelves
- 3.5" Traditional base
- Door/Drawer fronts w/ profile edges
- Legal/Double letter filing
- Features ball bearing suspensions, suspensions are full extension
- Top profile shaped 3 sides
- Wardrobe w/ coat rod & hook

## Notes

- Unit has black back panel and is not designed for Open Plan use. Select OPB Option for Open Plan application

## Options

### Delete Center Partition

- MOD30OP: Delete Center Partition / Add 3 Full Width Adj. Shelves & Fixed - \$295

### Door

- D2: Door Lock - \$100 per door
- D9SC: Soft Close Door Hinges - \$20 per door

### Drawer

- P33: Wood Drawer Upgrade - \$45 per drawer

### Flush Cut

- FC-B: Flush Unit Both Sides(Facing) for Ganging - \$100
- FC-L: Flush Unit Left (Facing) for Ganging - \$100
- FC-R: Flush Unit Right(Facing) for Ganging - \$100

### Open Plan \_ Finished Back

- OPB: "W" "G" Style - Modify Unit for Open Plan Application - \$395

## 2 Select Finish

[Click to view finishes](#)

## 3 Select Edge

[Click to view edges](#)

Edge  
N/A

## 4 Select Hardware

[Click to view details](#)



PL-4 Antique Brass



PL-5 Antique Brass  
PL-50 Brushed Pewter



DK-114 Brushed Pewter



DK-4 Antique Brass

# Richmond Park

Assembled Bookcases  
Open Bookcase

[Click here to view statement of line](#)

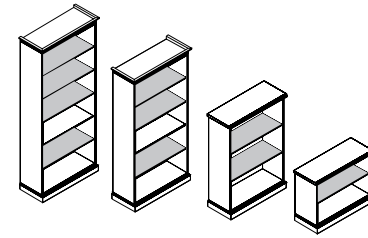

## 1 Select Model

w" x d" x h"	Weight
<b>Cornice Top and Base</b>	
37 x 16 x 86	205
37 x 16 x 74	185
31 x 16 x 86	200
31 x 16 x 74	180
<b>Veneer Top and Base</b>	
37 x 15 x 53	205
37 x 15 x 31.75	185
31 x 15 x 53	200
31 x 15 x 31.75	180

	Standard Veneer Top Standard Veneer Chassis		Premium Veneer Top Premium Veneer Chassis		High Pressure Laminate Top Veneer Chassis		Thermally Fused Laminate Top Thermally Fused Laminate Chassis	
	RPC3786BK250W	3650	"P" Option N/A		"G" Option N/A		"M" Option N/A	
	RPC3774BK250W	3292	"P" Option N/A		"G" Option N/A		"M" Option N/A	
	RPC3186BK250W	3388	"P" Option N/A		"G" Option N/A		"M" Option N/A	
	RPC3174BK250W	3029	"P" Option N/A		"G" Option N/A		"M" Option N/A	
	RPC3753BK250W	3055	"P" Option N/A		RPC3753BK250G	3055	"M" Option N/A	
	RPC3731BK250W	2759	"P" Option N/A		RPC3731BK250G	2759	"M" Option N/A	
	RPC3153BK250W	2805	"P" Option N/A		RPC3153BK250G	2805	"M" Option N/A	
	RPC3131BK250W	2619	"P" Option N/A		RPC3131BK250G	2619	"M" Option N/A	

## Product Features

- .75" Thick veneer back w/ dowel joint
- 2.5" Cornice top
- Adjustable glides
- Interior shelf depth 12"
- Veneer Top for 53" and 30" height
- Top profile shaped 3 sides
- "W" styles - 30", 53" H units finished top, 74", 86" H units black painted top

## Notes

- Base Height 3.5"
- Glides adjust 1"
- Unit has black back panel and is not designed for Open Plan use. Select OPB Option for Open Plan application
- 31.75"H Open Bookcases are NOT meant to gang with desks, returns and credenzas. Unit is higher than regular worksurfaces to allow double binder storage. If matching height is desired, choose RPC-3724CA125W or RPC3124CA125W with D6A option

## Options

### Flush Cut

- FC-B: Flush Unit Both Sides(Facing) for Ganging - \$100
- FC-R: Flush Unit Right(Facing) for Ganging - \$100
- FC-L: Flush Unit Left (Facing) for Ganging - \$100

### Interior Cabinet Lighting

- LEDPK starter kit includes Infeed, 1 Puck Interior Light and the ability to daisy chain up to 6 total Puck Lights
- LEDPK: LED Puck Starter Kit - \$310
- PK: 1 LED Interior Light - \$130

### Open Plan \_ Finished Back

- OPB: "W" "G" Style - Modify Unit for Open Plan Application - \$395

### Shelf

- GS14F: Replace Standard Shelves with Glass Shelves - \$90 per shelf
- S714F: Heavy Duty Lumber 1" Shelves - \$80 per shelf

## 2 Select Finish

[Click to view finishes](#)

## 3 Select Edge

[Click to view edges](#)



## 4 Select Hardware

[Click to view details](#)

Hardware  
N/A

Hardware  
N/A

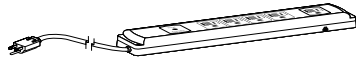

POWER / DATA  
power supply cordset

Style Number	List Price
PD717	95

### Specifications

- SIZE: 10.75"L x 2.0"W x 1.06"H
- (5) Outlets w/ 10' cord
- Surge suppression (720 Joules)
- 15 Amp breaker
- Available on: Vertical Panels, Cabinet Interiors, and under tops

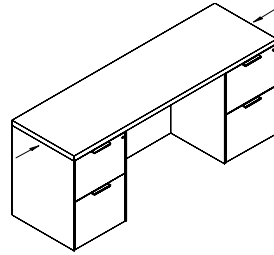

PRODUCT MODIFICATIONS  
modify width - open kneespace

Style Number	List Price
MOD-1	125

### Specifications

- Modify width down on any unit with an open kneespace: desk, workstation credenza, bridge, return

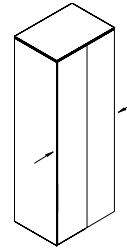

PRODUCT MODIFICATIONS  
modify width - open/closed storage

Style Number	List Price
MOD-2	250

### Specifications

- Modify width down on any unit with open or closed storage section: overheads, wall hung units, storage credenzas, towers

PRODUCT MODIFICATIONS  
modify width - outside of mod-1, mod-2

Style Number	List Price
MOD-3	Contact for pricing

### Specifications

- Width modification outside of MOD-1 & MOD-2

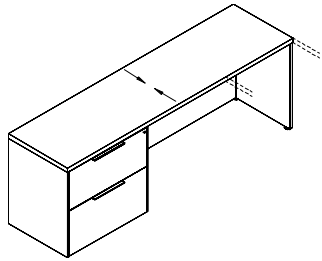

PRODUCT MODIFICATIONS  
modify depth - decrease depth

Style Number	List Price
MOD-5	125

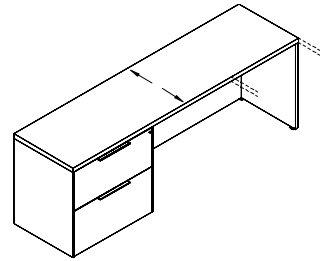

PRODUCT MODIFICATIONS  
modify depth - increase depth

Style Number	List Price
MOD-6	Add 10%

PRODUCT MODIFICATIONS  
modify height

Style Number	List Price
MOD-7	Contact for pricing

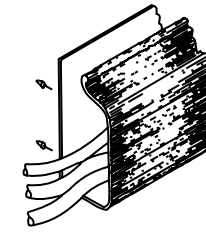

WIRE MANAGEMENT  
horizontal j-channel wire management raceway

Style Number	List Price
W1	75 Per 4' section

### Specifications

- Modify depth down (minimum depth for a unit with drawers is 21"D)

Notes  
- Ex. 24" to 21", 30" to 24", and 36" to 30"

### Specifications

- Increase depth by no more than 6"

Notes  
- Ex. 24" to 30", 30" to 36", and 36" to 42"  
- Add 10% to the unit you want to increase the depth of by no more than 6"

### Specifications

- Modify height of a unit

### Specifications

- 4' section for field installation.  
- The "J" shape black thermoplastic wire raceway may be added to specified worksurface tops to provide concealed channeling of wires to and from worksurface grommets. For use in open kneespace areas, raceway is attachable to top of back panel with pan head screws. Interior dimensions are 1" x 1- 1/2" providing ample storage for multiple wires and excess cable. Front of raceway flexes out for easy cord insertion.

Notes  
- Units w/ Wire Channel Standard.  
- Field Installation

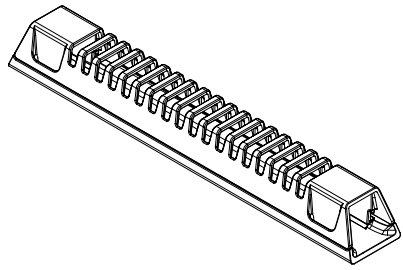

WIRE MANAGEMENT  
horizontal wire management raceway

Style Number	List Price
W21	30

### Specifications

- 10"W x 1.5"D x 1.25"H
- Grey Wire Manager (10.5")
- Power and data cables can be discretely housed and managed with the W21 Gray Wire Manager. This can be mounted in any location to metal frame or underside of conference tables and runs cables through a 1" channel from power module to hollow steel legs. This keeps cables organized under the table top. Release clips make it simple to snap on and off the Wire Manager for easy organization and access after attached to the table

Notes  
- Field installed



WIRE MANAGEMENT  
horizontal u-channel wire management raceway

Style Number	List Price
W2A	75 Per 4' section

### Specifications

- 4' section for field installation.
- Notes
- Units w/ Wire Channel Standard.
  - Field Installation



WIRE MANAGEMENT  
coil wire manager

Style Number	List Price
W18	150

### Specifications

- Weighted Base, Table attachment plate
  - 39- 1/2" Length
  - Black
- Notes
- Location

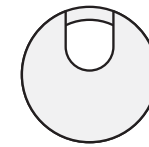

WIRE MANAGEMENT  
standard location grommets - factory installed

Style Number	List Price
Standard Location Grommet	
Black	
TM30	45
Silver	
TM31	45
Antique Brass	
TM33	45

### Specifications

- 1 -5/8" Metal Grommet
- Notes
- \*Units w/ Grommets Standard Are Noted Under Standard Features. Grommets Match Pull Finish - Standard (Unless Specified Otherwise)

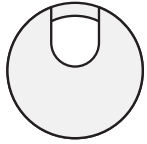

WIRE MANAGEMENT

non-standard location grommets - factory installed

Style Number	List Price
Non-Standard Location Grommet	
Black	
TM30 -NS	90
Silver	
TM31 -NS	90
Antique Brass	
TM33 -NS	90

Specifications

- 1 -5/8" Metal Grommet

Notes

- \*Units w/ Grommets Standard Are Noted Under Standard Features. Grommets Match Pull Finish - Standard (Unless Specified Otherwise)



WIRE MANAGEMENT

black plastic vertical surface grommets - factory installed

Style Number	List Price
Standard Location Grommet	
TM50-C	45
Non-Standard Location Grommet	
TM50-NS	90

Specifications

- 2 " Black Plastic Grommet

Notes

- Standard Location is Bottom Center



COMPUTER SUPPORT

single monitor arm

Style Number	List Price
MA1	265

Specifications

- Available in black or silver
- Desk clamp and mounting included
- Easy assembly and flexibility
- Elastic painting process for a durable and beautiful finish
- Gas spring tension adjustment for counter-balance height adjustment for monitors 1-8 KG
- Gas spring tested to 50,000 repetitions
- Hidden cable management

Richmond Park Options



COMPUTER SUPPORT

double monitor arm

Style Number	List Price
MA2	430

Specifications

- Available in black or silver
- Desk clamp and mounting included
- Easy assembly and flexibility
- Elastic painting process for a durable and beautiful finish
- Gas spring tension adjustment for counter-balance height adjustment for monitors 1-8 KG
- Gas spring tested to 50,000 repetitions
- Hidden cable management



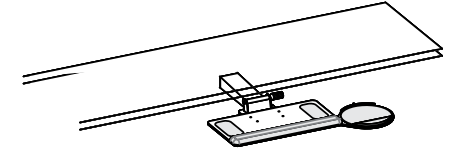
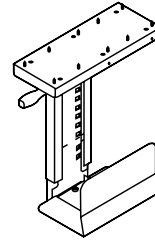

COMPUTER SUPPORT  
triple monitor arm

COMPUTER SUPPORT  
quadruple monitor arm

COMPUTER SUPPORT  
cpu retractable cradle

COMPUTER SUPPORT  
articulating keyboard tray

Style Number	List Price
MA3	505

Style Number	List Price
MA4	675

Style Number	List Price
K18	195

Style Number	List Price
Factory Installed K28	390
Field Installed K28F	415

### Specifications

- Available in black or silver
- Desk clamp and mounting included
- Easy assembly and flexibility
- Elastic painting process for a durable and beautiful finish
- Gas spring tension adjustment for counter-balance height adjustment for monitors 1-8 KG
- Gas spring tested to 50,000 repetitions
- Hidden cable management

### Specifications

- Available in black
- Desk clamp and mounting included
- Easy assembly and flexibility
- Elastic painting process for a durable and beautiful finish
- Gas spring tension adjustment for counter-balance height adjustment for monitors 1-8 KG
- Gas spring tested to 50,000 repetitions
- Hidden cable management

### Specifications

- Black Metal CPU Carriage
- Full 360° swivel capability allows easy access to rear of CPU for cables / wires
- Track allows 8- 1/2" extension
- Width Adjustment 5-1/2" to 9-1/4"
- Height adjustment 14- 5/8" to 20- 1/2"
- Black epoxy finish

- Notes
- Factory Installed

### Specifications

- Adjusts effortlessly - A simple one-handed motion allows the keyboard to be repositioned instantly, without the use of locks or levers
- Encourages low-risk postures - Maximizes adjustability within a safe operating range.
- Will last a lifetime - Exceeds all applicable BIFMA Standards and comes with a lifetime guarantee.

- Notes
- Available on: Freestanding Desk
  - Factory Installed (standard)
  - FIELD INSTALL - \$395

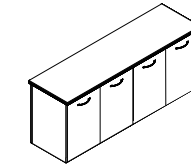
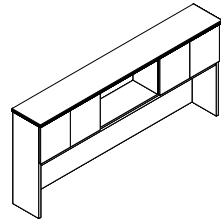

Richmond Park Options

DOOR MODIFICATIONS

soft close door hinge

Style Number	List Price
D9SC	15 Per door

DOOR MODIFICATIONS

delete doors

Style Number	List Price
D6	N/C

DOOR MODIFICATIONS

replace glass panel insert with veneer panel insert

Style Number	List Price
D35	30 per door

DOOR MODIFICATIONS

delete doors/replace black laminate shelf w/ finished shelf

Style Number	List Price
D6A	N/C

Specifications

- Snap onto standard door hinge
- Requires (2) per door
- Max door height 43"
- Factory installed where specified
- Individually shipped for field installation

Notes  
 - Specify Each Item To Have Slow Close Feature

Specifications

- Standard Door overheads and cabinets can have door deleted for open access. Modification of hinge rails and structural components are made face ready.

Specifications

- Replace glass panel insert with veneer panel insert

Notes  
 - Not Available on "M" skus  
 - Glass door has beveled glass  
 - Wood door w/ veneer insert - only available on "W" style

Specifications

- Delete doors and replace black laminate shelf with finished shelf

Notes  
 - Available on: All Storage "W"/"G" Style Credenzas.

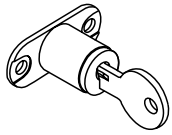

DOOR MODIFICATIONS  
panel door lock

Style Number	List Price
D2	95 Per door set

Specifications

- Door Locks - 1 Door w/ Lock, Other Door w/ Catch Latch
- Contact Customer Service regarding limited lock locations and keying.

Notes  
- Available on: Panel Doors, Wood Frame Doors, and Silverluma doors

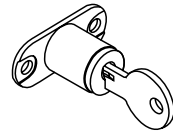

DOOR MODIFICATIONS  
glass door lock

Style Number	List Price
D2-G	195 Per door set

Specifications

- Door Locks - 1 Door w/ Lock, Other Door w/ Catch Latch
- Contact Customer Service regarding limited lock locations and keying.

Notes  
- Available on: Glass Doors

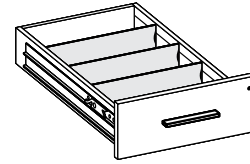

DRAWER OPTIONS  
box drawer accessories

Style Number	List Price
Wood Drawer Dividers w/ Clips	
K-DIV	SET OF 3 - 30
Single Tray - Utility Tray	
K-Sut	30 each

Specifications

- K-DIV Extra Wood Drawer Dividers with Clips, Top Box drawers standard with 1 divider
- K-SUT Single Tray - Utility Tray, Specify Legal or Letter drawer width

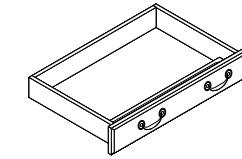

Richmond Park Options

DRAWER OPTIONS  
finished traditional center drawer

Style Number	List Price
K30	195
Add Skirt Option	
K30-SK	295

Specifications

- Veneer drawer front finished to match unit veneer. Edges are scalloped to match standard drawers.
- Standard with matching wood grain pencil tray
- Pulls selected to match unit installed

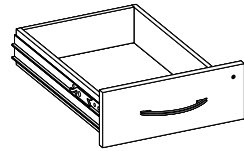
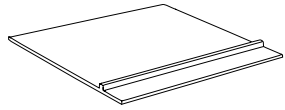

**DRAWER OPTIONS - BOTTOM COVER**  
felt bottom center drawer insert liner

Style Number	List Price
K3	95

**DRAWER OPTIONS - UPGRADE**  
wood drawer upgrade

Style Number	List Price
P33	40 Per Drawer

**GLASSBOARD ACCESSORIES**  
glassboard accessory kit

Style Number	List Price
GBKIT	275

**TASK LIGHTING**  
It-led task light

Style Number	List Price
24" Task light LT-LED24	215
48" Task light LT-LED48	270
60" Task light LT-LED60	335
72" Task light LT-LED72	360

**Specifications**

- Inserts into center drawer and features divider for open pen and pencil storage. Removable for easy cleaning.
- Adds a luxurious touch to center drawers.
- Color: Dark Brown Coal

**Specifications**

- Dowel joint construction
- Hardwood veneer multi-ply drawer
- UV finish
- 1/4" Wood veneer bottoms
- File drawer bottoms are five block reinforced for heavy weight capacity
- Lifetime guaranteed

**Specifications**

- 8 Earth magnets, 1 magnetic marker cup holder and 1 magnetic dry eraser

**Specifications**

- 6.5' Power cord. Switch with touch dimmer
- 36 LEDs per foot
- 4.6 Watts per foot
- 91 Lumens per watt
- Please note when ganging.
- Overhead tasklight cord is located on the right facing side. If the opposite location is required please contact customer service.

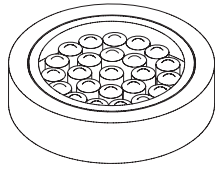

LIGHTING

led interior cabinet puck light

Style Number	List Price
Starter Kit LEDPK	310
1 LED Interior Puck Light PK	130

Specifications

- Starter kit includes Infeed, 1 Puck Interior Light and the ability to daisy chain up to 6 total Puck Lights
- (1) LED Puck Light with 30W power drive and switch
- Recessed fixture
- 12V linking cord 98"L
- Silver finish
- 50,000 hour life
- 2 watt per light

Notes

- Available on: Overhead/Tower Units with glass doors or no doors
- Power drive included, Light only

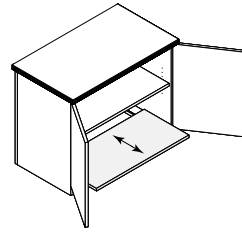

PEDESTAL MODIFICATIONS

black laminate printer pullout bottom shelf

Style Number	List Price
PPOS	214

Specifications

- Black Laminate pullout shelf on suspension
- Black grommet
- Adjustable Shelf

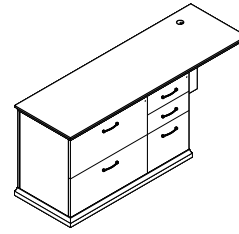

PEDESTAL MODIFICATIONS

add veneer kneespace cabinets - base

Style Number	List Price
Add Box/Box/File or File/File P40B	985
Add Lateral File 29" W P41B	1205
Add Multi-File - 31"W P42B	1205
Add Storage With Doors 29"W P43B	1095
Add CPU /Printer Cabinet - Open P44B	1095

Specifications

- Multi-file specify Box/Box Left or Right

Notes

- Add additional Standard Cabinets To Kneespace Area.

Richmond Park Options

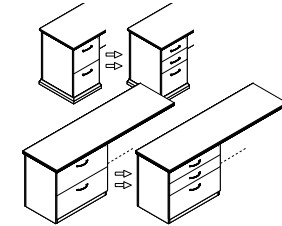

PEDESTAL MODIFICATIONS

modify drawer configurations

Style Number	List Price
P6	55 Per ped
P6	55 Per ped
P8	95 Per ped

Specifications

- Modify File/File To Box/Box/File - Any Unit

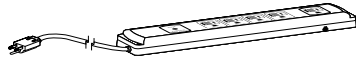

POWER / DATA  
power supply cordset

Style Number	List Price
PD717	100

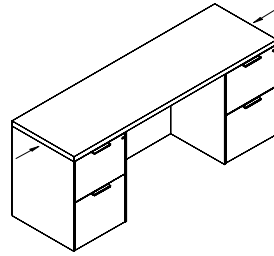

PRODUCT MODIFICATIONS  
modify width - open kneespace

Style Number	List Price
MOD-1	125

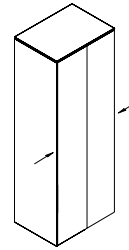

PRODUCT MODIFICATIONS  
modify width - open/closed storage

Style Number	List Price
MOD-2	250

PRODUCT MODIFICATIONS  
modify width - outside of mod-1, mod-2

Style Number	List Price
MOD-3	Contact for pricing

### Specifications

- SIZE: 10.75"L x 2.0"W x 1.06"H
- (5) Outlets w/ 10' cord
- Surge suppression (720 Joules)
- 15 Amp breaker
- Available on: Vertical Panels, Cabinet Interiors, and under tops

### Specifications

- Modify width down on any unit with an open kneespace: desk, workstation credenza, bridge, return

### Specifications

- Modify width down on any unit with open or closed storage section: overheads, wall hung units, storage credenzas, towers

### Specifications

- Width modification outside of MOD-1 & MOD-2

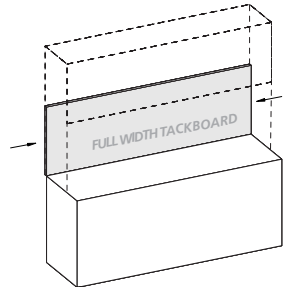

PRODUCT MODIFICATIONS  
modify width - tackboard, veneer panel, or a glassboard

Style Number	List Price
MOD-4	50

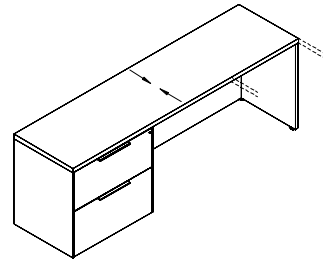

PRODUCT MODIFICATIONS  
modify depth - decrease depth

Style Number	List Price
MOD-5	125

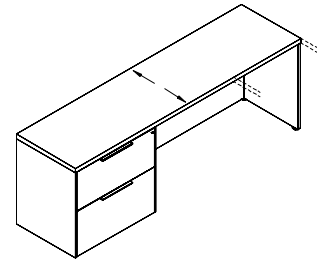

PRODUCT MODIFICATIONS  
modify depth - increase depth

Style Number	List Price
MOD-6	Add 10%

PRODUCT MODIFICATIONS  
modify height

Style Number	List Price
MOD-7	Contact for pricing

### Specifications

- Modify width down on tackboard, veneer panel, or a overhead glassboard

### Specifications

- Modify depth down (minimum depth for a unit with drawers is 21"D)

Notes  
- Ex. 24" to 21", 30" to 24", and 36" to 30"

### Specifications

- Increase depth by no more than 6"

Notes  
- Ex. 24" to 30", 30" to 36", and 36" to 42"  
- Add 10% to the unit you want to increase the depth of by no more than 6"

### Specifications

- Modify height of a unit

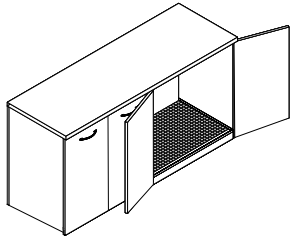

REFRIGERATOR MODIFICATION  
refrigerator cabinet modification

Style Number	List Price
REF01	195

Specifications

- Open back cutout for venting
- Moisture sponge mat
- Contaminate ledge
- Contact customer service for maximum refrigerator size (Changes based on unit).
- Available on: 36" and 42" Storage Credenzas

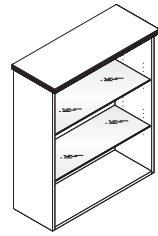

SHELF MODIFICATIONS  
glass shelves - tempered full width  
26" - 35"

Style Number	List Price
26"W - 35"W x 14"D Shelf GS14F	90 each

Specifications

- Glass Shelves Replace Wood Shelf In Open Or Glass Door Cabinet. Also Order Interior Cabinet Lighting.

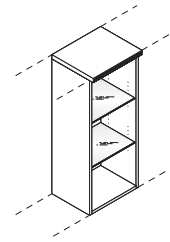

SHELF MODIFICATIONS  
tempered glass shelves for half  
cabinet 17- 1/2" widths

Style Number	List Price
14-1/2"W - 17- 1/2"W x 14"D Shelf GS14H	90 ea

Specifications

- Glass Shelves Replace Wood Shelf In Open Or Glass Door Cabinet. Also Order Interior Cabinet Lighting.

Notes

- Replace only adjustable shelves between cabinet light and fixed lower wood shelf.

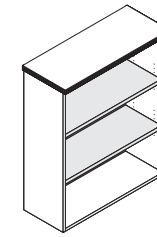

SHELF MODIFICATIONS  
heavy duty solid wood bookcase  
replacement shelves

Style Number	List Price
1" Wood Shelf 14" Deep S714F	80 each
1" Wood Shelf 24" Deep S714FX	150 each

Specifications

- 1" Solid Lumber Core Shelves Replace Standard 3/4" Plywood Adjustable And Fixed Shelves



Aircharge wireless charging grommet

Style Number                      List Price



ACWG WIRELESS GROMMET                      \$213

### Specifications

- > When used with GROVE Tables an additional \$350 LIST will apply for the special cutout required.
- > AirCharge offers a convenient way to charge any Qi compatible smartphone or device without the need to carry charging cables or find an available power outlet.
- > The Aircharge is powered by the latest Qi compliant IC offering reliable and efficient wireless charging in a convenient 3" grommet hub. Simply place your phone on the Aircharge and an LED will confirm pairing and begin wireless charging.
- > Recess: Efficient space conservation and quick access
- > Input: DC 5V (with included AC power adapter), DC 9V, 1.67A (with optional QC 2.0 power adapter)
- > Output: 5 watts Max. with DC 5V, 2A power adapter, 10 watts Max. with QC 2.0 power adapter
- > Qi V1.2 compliant IC
- > Charging distance: 6mm Max.

Available: All DARRAN collections



Cove power unit - non-linking

Style Number	List Price
 PD-COVE PLUG	\$600
Non-linking version	

### Specifications

- > Size 5.75"L x 2.5"W
- > (2) 15 Amp Receptacles and (2) USB charging ports
- > Surface Mount
- > 108" Cord
- > Standard Silver Finish, Available in White or Black Finish upon request
- > ETL Listed

Available: All DARRAN collections



Cove corded series

Style Number	List Price
 PD-COVE-PKO	\$872

### Specifications

- > Size 9.5"L x 2.5"W x 3.18"D
- > When used with GROVE Tables an additional \$350 LIST will apply for the special cutout required.
- > (2) Power Receptacles, (2) 2.1 Amp USB charging ports and (1) Telecom Plate Knockout
- > Surface Mount
- > 108" Cord
- > Standard Silver Finish, Available in White or Black Finish upon request
- > ETL Listed

Available: All DARRAN collections

**Telecom Plates**

RJ45 (1)	\$55
RJ45 (2)	\$110
RJ45 (3)	\$165
USB (1)	\$70
USB (2)	\$140
RJ11/RJ45	\$110
RJ45/USB	\$125
RJ45/HDMI	\$210
HDMI/DVI	\$325
HDMI/USB	\$205
HDMI/VGA	\$240
VGA/MINI-STEREO	\$155
VGA/USB	\$175

This pod can have up to 1 total plates.  
 \*All telecom connectors sold separately.



Soba wire manager

Style Number	List Price
STARTER UNITS	
SCDW	\$218
White wire manager	
SCDB	\$218
Black wire manager	

### Specifications

- › Dimensions: 9ft x 9in x 3.15in
- › Zips up, bundles and routes loose, messy cables into a single tube
- › Routes and guides cables behind desks, TVs, and anywhere cables tend to get messy
- › Accommodates large or small cables, up to three cables at once
- › Support channels, used to route cables, include powerful adhesive backing which allows easy attachment to surfaces.

Available: All DARRAN collections



VILLA Power unit - non-linking

Style Number	List Price
 VIL-C PLUG	\$562
Non-Linking	

### Specifications

- › Size: Top Grommet 5.68”L X 3.39”W; Under Top 12”L x 3.13”W x 3.08”D
- › (2) Power receptacles; (2) USB charging ports and (1) Knockouts for RJ45 Data Ports
- › Surface Mount
- › 72” Cord (Longer cord available, contact Customer Service)
- › Standard Silver Finish, Black Finish available upon request
- › UL or ETL Certified

Available: All DARRAN collections, excludes Grove

RJ45 Knockout	
RJ45 (1)	\$55

