



Seating price list



Bota Price List

Effective November 1, 2022

Designed by Keith Melbourne

Date	Page	Modification	Description
9.14.22		Removed power block options	
11.10.22	Price Increase	9% price increase applied to all items excluding options.	
11.16.22	Price Increase	9% price increase applied to Rear Tables and Tablets	
02.17.23	Ebony	Added Ebony to Bota Booth Table	
5.15.23		Removed WLA finish and added WLO	
5.18.23		Added TSLV to Bota freestanding table	
06.20.23		Added WWW & MWW Weathered Walnut finish	

Statement of Line
Bota seating & fabric program.....1
Seating Specification4
Rear Table Specification5
Grommet Placement7
Finishes8
Seating.....9
Ottoman54
Booths.....57
Freestanding Table.....59
Coat Stand.....62
Power and Data63

Statement of Line

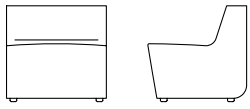

Page 9
Single Seat
Low Back

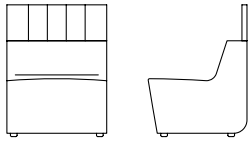

Page 10
Single Seat With Privacy Screen
Low Back - 10.5" Privacy Screen

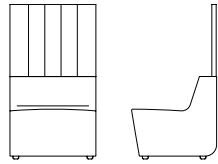

Page 11
Single Seat With Privacy Screen
Low Back - 24.75" Privacy Screen

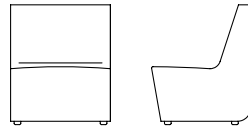

Page 12
Single Seat
High Back

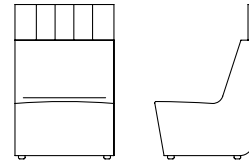

Page 13
Single Seat With Privacy Screen
High Back - 10.5" Privacy Screen

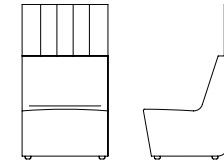

Page 14
Single Seat With Privacy Screen
High Back - 17.5" Privacy Screen

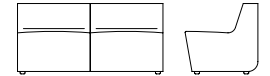

Page 15
Double Seat
Low Back

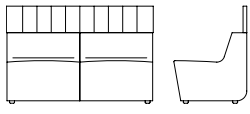

Page 16
Double Seat With Privacy Screen
Low Back - 10.5" Privacy Screen

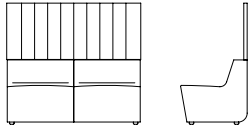

Page 17
Double Seat With Privacy Screen
Low Back - 24.75" Privacy Screen

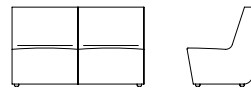

Page 18
Double Seat
High Back

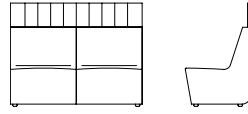

Page 19
Double Seat With Privacy Screen
High Back - 10.5" Privacy Screen

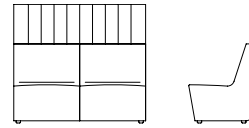

Page 20
Double Seat With Privacy Screen
High Back - 17.5" Privacy Screen

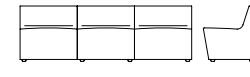

Page 21
Triple Seat
Low Back

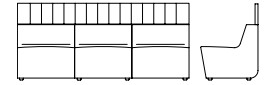

Page 22
Triple Seat With Privacy Screen
Low Back - 10.5" Privacy Screen

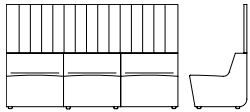

Page 23
Triple Seat With Privacy Screen
Low Back - 24.75" Privacy Screen

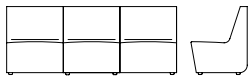

Page 24
Triple Seat
High Back

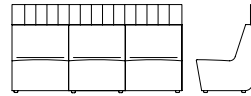

Page 25
Triple Seat With Privacy Screen
High Back - 10.5" Privacy Screen

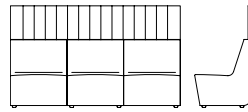

Page 26
Triple Seat With Privacy Screen
High Back - 17.5" Privacy Screen

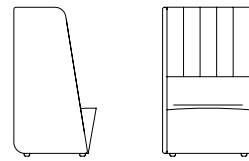

Page 27
Shell - Single Seat
Low Back - Side Screens &
Privacy Screen

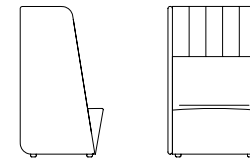

Page 28
Shell - Single Seat
High Back - Side Screens &
Privacy Screen

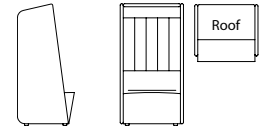

Page 29
Shell - Single Seat
Low Back - Side Screens, Privacy
Screen & Roof

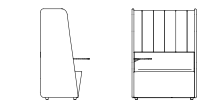

Page 30
Work Shell
Single - Seat

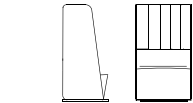

Page 31
Shell - Single Seat
Low Back - Swivel Base

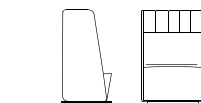

Page 32
Shell - Single Seat
High Back - Swivel Base

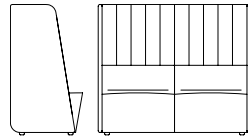

Page 33
Shell - Double Seat
Low Back - Side Screens &
Privacy Screen

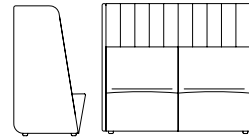

Page 34
Shell - Double Seat
High Back - Side Screens &
Privacy Screen

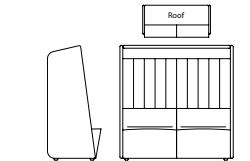

Page 35
Shell - Double Seat
Low Back - Side Screens, Privacy
Screen & Roof

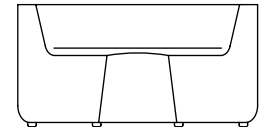

Page 36
90 Deg. Circlet - Single Seat
Low Back
90 Degree Back Inside Radius
- Low Back

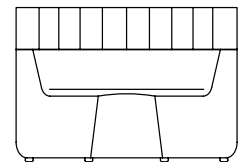

Page 37
90 Deg. Circlet - Single Seat Low
Back With Privacy Screen
90 Degree Back Inside Radius -
Low Back - 10.5" Privacy Screen

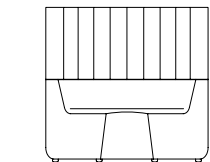

Page 38
90 Deg. Circlet - Single Seat Low
Back With Privacy Screen
90 Degree Back Inside Radius -
Low Back - 24.75" Privacy Screen

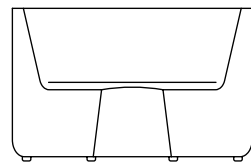

Page 39
90 Deg. Circlet - Single Seat
High Back
90 Degree Back Inside Radius
- High Back

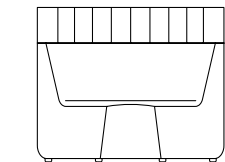

Page 40
90 Deg. Circlet - Single Seat High
Back With Privacy Screen
90 Degree Back Inside Radius -
High Back - 10.5" Privacy Screen

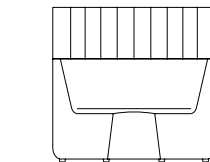

Page 41
90 Deg. Circlet - Single Seat High
Back With Privacy Screen
90 Degree Back Inside Radius -
High Back - 17.5" Privacy Screen

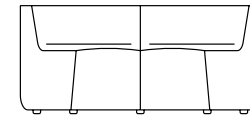

Page 42
60 Deg. Circlet - Double Seat
Low Back
60 Degree Back Inside Radius
- Low Back

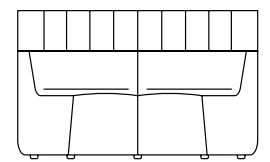

Page 43
60 Deg. Circlet - Double Seat
Low Back With Privacy Screen
60 Degree Back Inside Radius -
Low Back - 10.5" Privacy Screen

Statement of Line

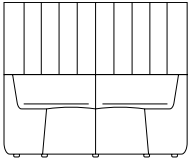

Page 44
60 Deg. Circllet - Double Seat
Low Back With Privacy Screen
60 Degree Back Inside Radius -
Low Back - 24.75" Privacy Screen

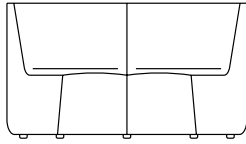

Page 45
60 Deg. Circllet - Double Seat
High Back
60 Degree Back Inside Radius
- High Back

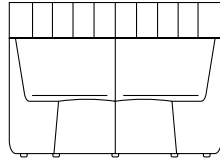

Page 46
60 Deg. Circllet - Double Seat
High Back With Privacy Screen
60 Degree Back Inside Radius -
High Back - 10.5" Privacy Screen

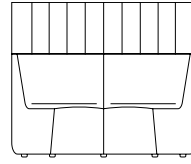

Page 47
60 Deg. Circllet - Double Seat
High Back With Privacy Screen
60 Degree Back Inside Radius -
High Back - 17.5" Privacy Screen

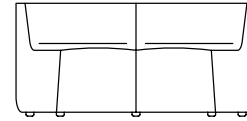

Page 48
45 Deg. Circllet - Double Seat
Low Back
45 Degree Back Inside Radius
- Low Back

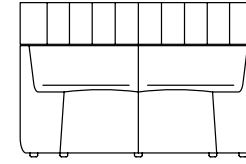

Page 49
45 Deg. Circllet - Double Seat
Low Back With Privacy Screen
45 Degree Back Inside Radius -
Low Back - 10.5" Privacy Screen

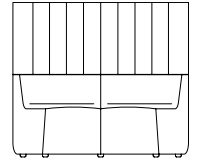

Page 50
45 Deg. Circllet - Double Seat
Low Back With Privacy Screen
45 Degree Back Inside Radius -
Low Back - 24.75" Privacy Screen

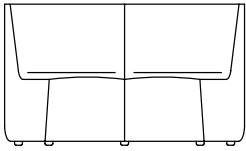

Page 51
45 Deg. Circllet - Double Seat
High Back
45 Degree Back Inside Radius
- High Back

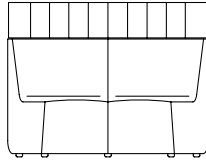

Page 52
45 Deg. Circllet - Double Seat
High Back With Privacy Screen
45 Degree Back Inside Radius -
High Back - 10.5" Privacy Screen

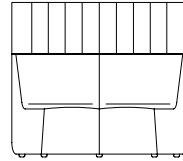

Page 53
45 Deg. Circllet - Double Seat
High Back With Privacy Screen
45 Degree Back Inside Radius -
High Back - 17.5" Privacy Screen



Page 54
Ottoman
19" Ottoman

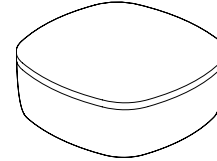

Page 55
Ottoman
48" Ottoman

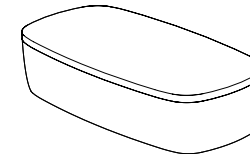

Page 56
Ottoman
70" Ottoman

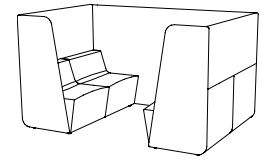

Page 57
Booth
4 Person Meeting Booth

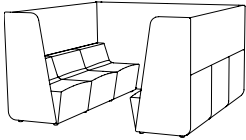

Page 58
Booth
6 Person Meeting Booth



Page 59
Booth Table
4 Person Meeting Booth Table



Page 60
Booth Table
6 Person Meeting Booth Table



Page 61
Freestanding Table
Freestanding Table



Page 62
Coat Stand
Wire Coat Stand

Seating & Fabric Leather Program

DARRAN has partnered with some of the most prestigious fabric suppliers of the office furniture industry to bring you quality fabrics that are engaging designs, environmentally friendly and durable for years to come. The majority of fabrics we have graded-in are in heavy supply making it most likely available on our Quickship however, we cannot guarantee stock. If you do not see the fabric you wish to include in a project, please contact our Factory to see if this pattern can be graded in at 800.334.7891.

Fabrics & Leathers

Please visit our Seating Fabrics page at darran.com/textilesleather

Camira
www.camirafabrics.com
 800.334.789

Wollsdorf
www.wollsdorf.com
 336.884.5005

CFStinson
www.cfstinson.com
 800.841.6279

Green Hides
www.greenhides.com
 336.315.9720

DesignTex
www.designtex.com
 800.797.4949

Maharam
www.maharam.com
 800.645.3943

Momentum Textiles
www.momentumtextiles.com
 800.366.6839

Ultrafabrics
www.ultrafabricsinc.com
 800.334.7891

Application instructions must be specified on the purchase order or COM / COL submission form. In the absence of application instructions, DARRAN will apply materials accordingly.

CAL117

All DARRAN seating products conform to California Technical Bulletin 117 as a minimum standard.

CAL133

To meet the California Technical Bulletin 133 flammability regulation, a combination of proper materials must be used to pass, as it tests the fire resistance of a finished product. Flame resistant fabric, a fire blocker material and special foam must be used to pass CAL133 fire codes.

Testing is available for all seating products with the following fees and considerations:

- If laboratory certification is not required, any style can be manufactured to comply with California Technical Bulletin 133 for \$75 list per yard required. (Customer's Own Materials must factor in additional yardage requirements based on repeat.)
- The purchase order must clearly indicate the requirement of California Technical Bulletin 133
- If laboratory California Technical Bulletin 133 certification is required, the cost of testing a chair is \$820 NET, plus the cost of the chair and covering material.
- An additional lead time of 4 to 6 weeks is required for testing for CAL133.
- Once testing is completed, we will provide a certification letter specific to the sample tested for CAL133.
- DARRAN's manufacturing procedures for California TB 133 compliance are based on the testing of representative style with specific fabrics. Please contact Customer Service for an updated list of tested models.
- A copy of test certification is available upon request.

Combination Fabrics

DARRAN is pleased to offer customers the design freedom of combination fabrics. When using fabric, vinyl or leather combinations, pricing will be as follows:

- When combining two materials of the same grade, pricing will be specified grade + 5%.
- If combining two materials of different grades or leather/ fabric combination, use the highest grade/price + 5%.
- If using COM or COL, pricing will be COM or COL + 5%. If both COM + COL are used in combination, use COL + 5%

COM/COL Ordering Instructions

Please complete the COM Submission Form prior to ordering the fabric from the supplier. All COM fabrics must be approved prior to order submission. Please refer to our website or contact DARRAN Seating Customer Service for an updated list of preapproved COM fabrics. Application instructions must be specified on the purchase order or COM/COL submission form. In the absence of application instructions, DARRAN will apply materials in the best manner and cannot be held responsible for tailoring or application objections after upholstery. COM orders will be scheduled for production after receipt of the material. Packages must be clearly marked and the fabric must be first quality, continuous yardage.

COM/COL yardage requirements

The yardage requirements stated in this price list for each style are calculated using 54" wide, non-directional fabrics. For fabrics with a different width or for patterns with repeats, please refer to the below chart to calculate the additional percent of fabric required:

Fabric Width	Plain Fabric	2"- 14" Repeat	15"- 19" Repeat	20"- 27" Repeat	28"- 36" Repeat
54"	0	15%	20%	25%	30%
53"	6%	19%	24%	28%	36%
52"	13%	23%	28%	33%	38%
51"	19%	26%	31%	36%	41%
50"	25%	30%	35%	40%	45%
49"	30%	35%	40%	45%	50%
48"	35%	40%	45%	50%	55%
47"	45%	50%	55%	58%	65%

DARRAN®

Bota Seating Fabric & Leather Program

NOTE: Prior To Completion Of This Form, Please Refer To Our Graded In Materials Program For Preapproved Fabrics/Leathers.

COM/COL Approval

DARRAN Furniture Industries
2402 Shore Street, High Point, NC 27263
ATTN: Seating Division / COM/COL Approval
TAG: DARRAN Purchase Order Number

Shipping Approved COM/COL Materials

DARRAN Furniture Industries
2402 Shore Street, High Point, NC 27263
ATTN: Seating Division / COM/COL Approval
TAG: DARRAN Purchase Order Number

Please complete this form, attach a 6"x 6" sample and mail to the COM/COL APPROVAL address shown above.
This form can also be downloaded from our website at www.darran.com/leathers OR www.darran.com/fabrics

Purchase Order # _____
 Dealer's Name _____
 Contact _____
 Address _____
 Telephone _____
 Email _____
 Chair Stlye _____
 Manufacturer _____
 Pattern Name _____
 Pattern Color _____
 Content _____
 Repeat _____

Please specify any special requirements and check the application above.

ATTACH 6" X 6" FABRIC/LEATHER SAMPLE HERE

NOTE
Actual Fabric/Leather samples needed instead of digital images. If digital images are sent in lieu of samples, DARRAN will only verify the pattern and will not take responsibility for color variances that cannot be verified due to printing restrictions

In the absence of application instructions, DARRAN will apply the material in the best manner and cannot be held responsible for tailoring or application objections after upholstering.

Unless otherwise instructed on the purchase order, excess COM materials will be recycled at the discretion of DARRAN after six months of the original product ship date.

The COM approval solely pertains to the application of the fabric onto the specified DARRAN seating product. DARRAN's approval or acceptance does not constitute any responsibility or warranty to the overall appearance, durability, flammability, defects, dye lot variations or colorfastness of the COM. It is the customer's responsibility to ensure the COM meets CAL 117 compliance and are first quality continuous goods.

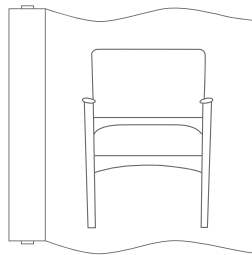

Railroad

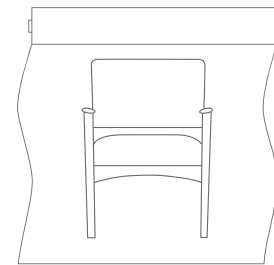

Setup

Joints are securely fastened with mortise and tenon joinery as well as well as corner block construction to ensure long-term use.

Ability to incorporate variety of options

Tablet mounts and combination fabrics.

Complete domestic production

Complete domestic production from frame through upholstery, controlled by one manufacturing facility. Less stress / damage to chair parts normally caused by overseas transit, providing consistent, reliable quality standards as a quick response to shorter lead times.

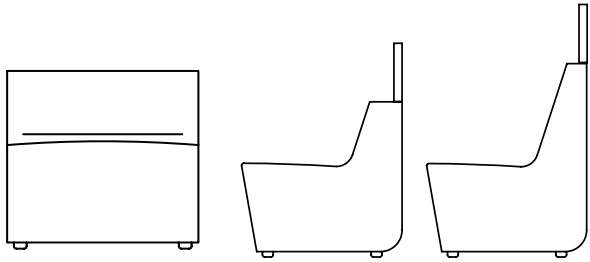

Offered in Low or high back. Seats and back are webbed to enhance comfort, sustainability and endurance. Frame constructed CNC cut engineered wood to maximize the strength, precise measurements and overall longevity. Soy-based, high resilient polyurethane foam consisting of multiple densities in seat and backs, achieving maximum comfort and durability.

Optional tablet or rear tables offered in 1/2" compact laminate featuring a black core. Tablets are center mounted between 2 seats. Horizontal back frame provides easy ganging capabilities for expansion and flexibility in various settings.

Rear tables are at 28.5" high on low back units, and 35.5" high on high back units.

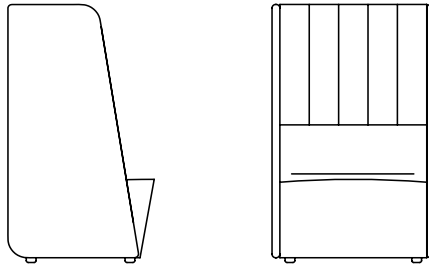

Side Screens and Back Privacy screens create private areas to focus or define a team.

Privacy Screens are available in 10.5", 17.5" & 24.75"

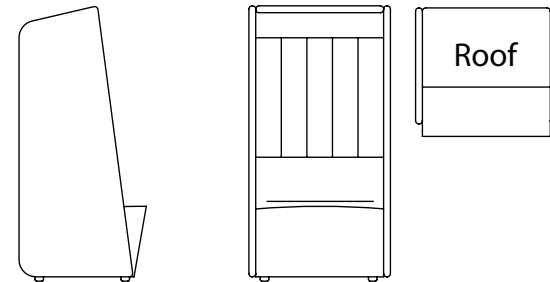

The Bota Roof allows for sound to be absorbed creating a focus nook.

Available in a single or double seat module.

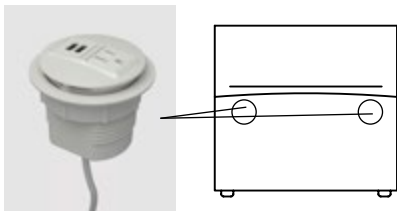

Specify power

Node features 1 power & 1 USB duplex, ideal for charging tablets and other USB-friendly electronics. Node is UL approved.

Specify location, see page 64 for additional details.

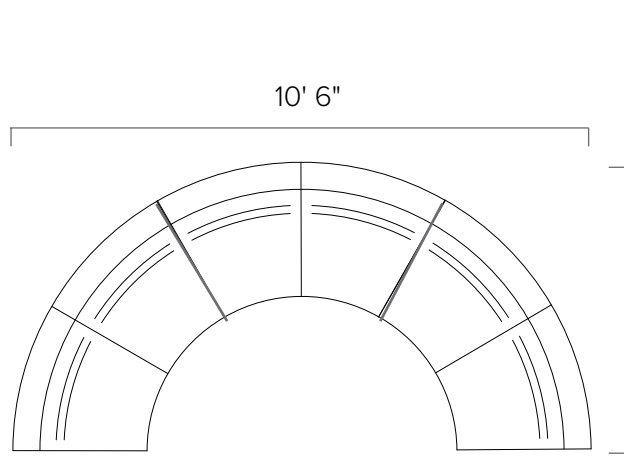

60 Degree
3 Units shown above
per half circle

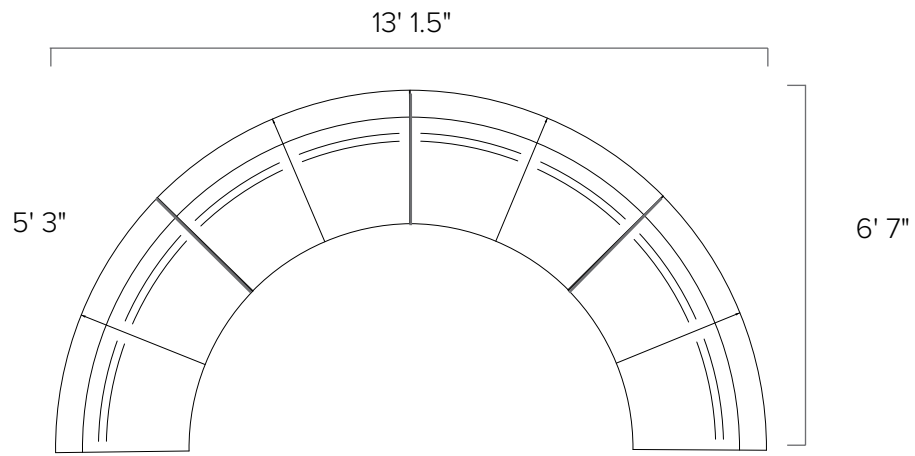

45 Degree
4 Units shown above
per half circle

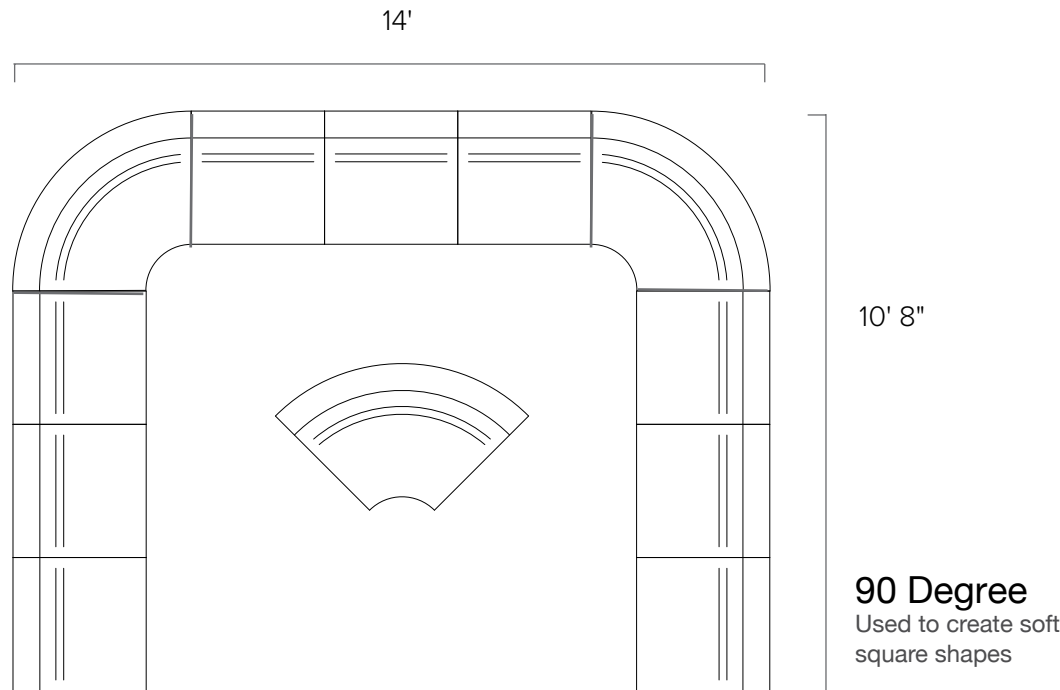

90 Degree
Used to create soft
square shapes

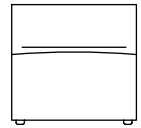

Single Seat Unit

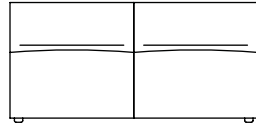
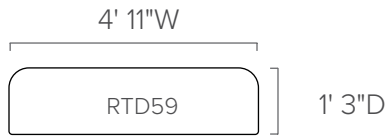

Double Seat Unit

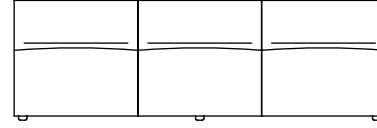
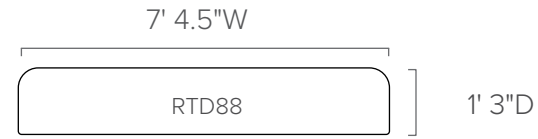

Triple Seat Unit

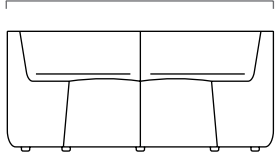
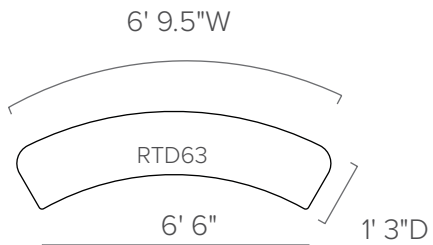

60 Degree Unit

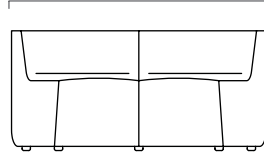
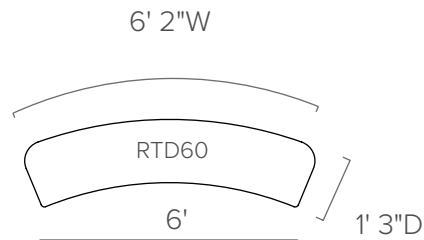

45 Degree Unit

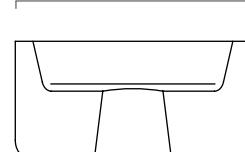
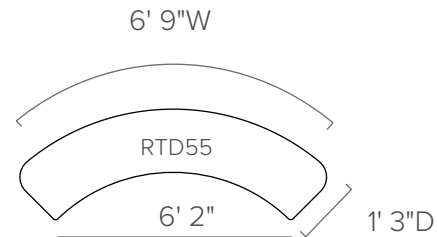

90 Degree Unit

Booth Wall Exterior

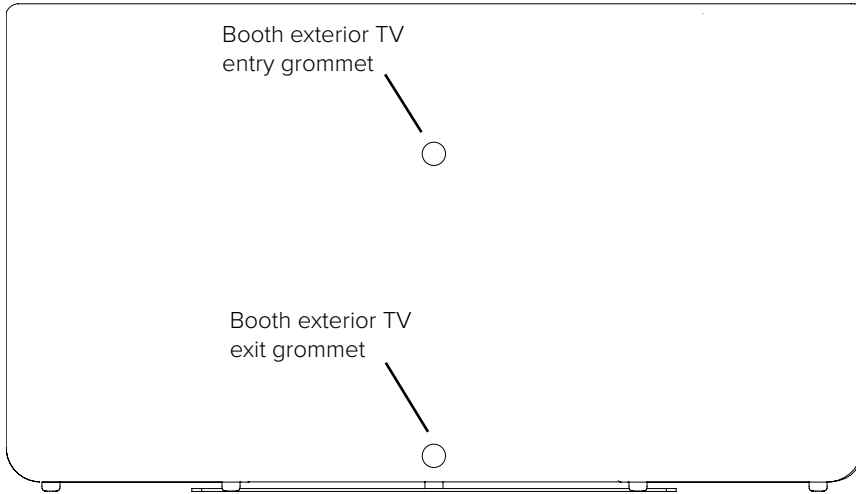

Booth Wall Interior

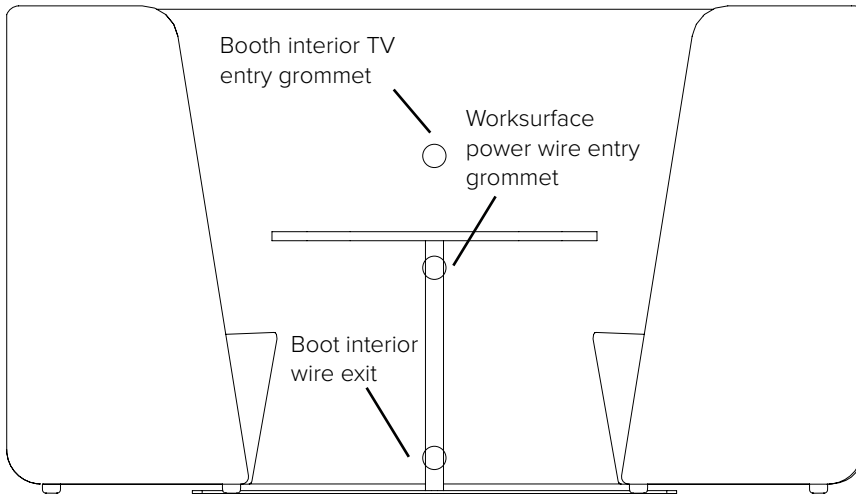

Bota Booth Grommet Placement

Bota booth walls have an integrated wire management channel built into the frame. Grommets are available in TM71 black or TM70 white. The channel runs through the center of the wall, allowing cables to enter and exit. Specify interior or exterior location.

STANDARD VENEER	PREMIUM VENEER	HIGH PRESSURE LAMINATE	THERMALLY FUSED LAMINATE
WEC Ebony	N/A.....	GEC Ebony.....	MEC Ebony
WAM Alabaster Maple.....	N/A.....	GAM Alabaster Maple.....	N/A
WCM Clear Maple.....	N/A.....	GCM Clear Maple.....	N/A
*WLO Lofty Oak	WLO Lofty Oak.....	N/A.....	N/A
N/A.....	WMO Mocha Oak.....	N/A.....	N/A
N/A.....	WNO Natural Oak.....	N/A.....	N/A
N/A.....	WSO Salted Oak.....	N/A.....	N/A
WGW Gunstock Walnut.....	N/A.....	N/A.....	MGW Gunstock Walnut
WBW Henna Walnut.....	N/A.....	N/A.....	N/A
WSW Smokey Walnut.....	N/A.....	N/A.....	N/A
WNW Natural Walnut.....	N/A.....	GNW Natural Walnut.....	N/A
N/A.....	TSTV Studio Teak Walnut.....	GSTV Studio Teak Walnut.....	MTW Studio Teak Walnut
N/A.....	TSMV Seattle Mist.....	N/A.....	N/A
N/A.....	TSLV Skyline Walnut.....	GSLV Skyline Walnut.....	MSW Skyline Walnut
WWP Designer White Paint.....	N/A.....	GWL Designer White.....	MWL Designer White
WWW Weathered Walnut.....	N/A.....	N/A.....	MWW Weathered Walnut

HPL TOPS ON TFL PRODUCTS ADD 10% - AVAILABLE WITH FLAT EDGE ONLY

Send 3x3 or larger finish chip for color match. Custom finish upcharge is 3% or \$250 Net (whichever is greater).

*WLO Lofty Oak is standard only on the Bota freestanding table.



Finish

Welltech Finish delivers a superior furniture coating with exceptional performance that can withstand stringent cleaning agents and possesses unparalleled durability, allowing DARRAN to provide lasting, sustainable products to our customers.

1/2" Compact Laminate Finishes

(Black Core)

LAW Alaska Matte

LNB Nero Matte

Compact laminate is a paper fiber-based solid surface material. Matte Compact Laminate has a soft-and silky texture that feels velvety to the touch, while resisting smears, smudges and fingerprints. Compact laminate is essentially very thick HPL. Extra layers of paper in the core gives it its thickness and strength, as well as its characteristic black core.

Bota

Single Seat
Low Back

[Click here to view statement of line](#)

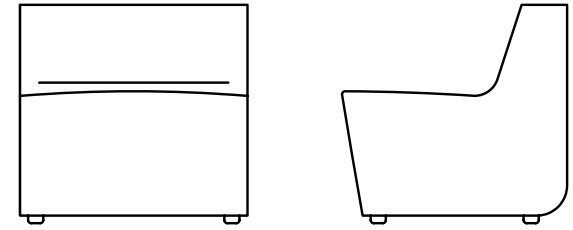

1 Model BOT0160SLC01

w" x d" x h"
29.5 x 29.25 x 28.5
Arm Height -
Seat Height 17.5
Inside Seat Depth 17
Inside Seat Width 29.5

COM	COL	1	2	3	4	5	6	7	8	9	10	11/L1	12	13/L2
1969	2061	2099	2154	2209	2264	2319	2374	2429	2484	2539	2594	2649	2704	2814

Upholstery Requirements
Fabric yds: 3.5 Leather Sq. Ft.: 63
Carton Weight: 50

2 Select Finish

[Click to view finishes](#)

NA

3 Combination Fabrics

[Click to view finishes](#)

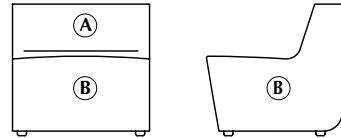

DARRAN is pleased to offer customers the design freedom of combination fabrics. When using fabric, vinyl or leather combinations, pricing/yardage requirements will be as follows:

A Inside Back & Seat 1 yd
B Lounge Exterior 3 yds

Top View

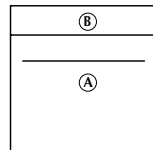

- When combining two materials of the same grade, pricing will be specified grade + 5%
- If combining two materials of different grades or leather/fabric combination, use the highest grade/price + 5%
- If using COM or COL, pricing will be COM or COL + 5%.
- If both COM + COL are used in combination, use COL + 5%.

Node Power Placement Option

Table Power

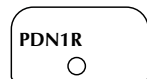

Seat Power

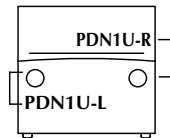

Product Features

- Horizontal back provides easy ganging capabilities.
- Utilizes elastic webbing suspension that conforms to individual's lumbar curvatures for adaptive support.
- All units are standard with 1" adjustable glides that allow for leveling

Options

Ganging Device

- GDEV-L: Left Facing Ganging Device - \$20
- GDEV-R: Right Facing Ganging Device - \$20
- GDEV-C: Center Ganging Device - \$40

Power

- PDN1U-L: Node in Left Facing Seat Front; 1 Power/1 USB Charger - \$355
- PDN1U-R: Node in Right Facing Seat Front; 1 Power/1 USB Charger - \$355
- PDN1U-B: Node in Both Left and Right Facing Seat Front; 1 Power/1 USB Charger per pod - \$709
- PDN1R- Node in Rear Mount Table Top; 1 Power/1 USB Charger - \$409
- Standard in White (Available in Silver and Black)

1/2" Compact Matte Laminate Rear Table

- Matte Laminate RTD29: Rear Work Table - \$633, Specify LAW Alaska or LNB Nero Finish
- Rear table available on units that gang providing stability
- Rear table is mounted at 28.5"

Premium Finish Option (Standard White)

- Specify rear table bracket Metal Finish color - \$100 per unit
- MFS: Silver, MFB: Black

Bota

Single Seat With Privacy Screen
 Low Back - 10.5" Privacy Screen

[Click here to view statement of line](#)

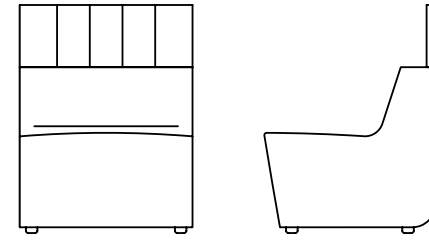

1 Model BOT0160SLC11

w" x d" x h"
 29.5 x 29.25 x 39
 Arm Height -
 Seat Height 17.5
 Inside Seat Depth 17
 Inside Seat Width 29.5

COM	COL	1	2	3	4	5	6	7	8	9	10	11/L1	12	13/L2
2684	2798	2851	2933	3015	3097	3179	3261	3343	3425	3507	3589	3671	3753	3917

Upholstery Requirements
 Fabric yds: 4.5 Leather Sq. Ft.: 81
 Carton Weight: 55

Product Features

- Horizontal back provides easy ganging capabilities.
- Utilizes elastic webbing suspension that conforms to individual's lumbar curvatures for adaptive support.
- Upholstered Privacy Screen
- Upholstered screens can be specified in contrasting fabrics, vinyl, or leathers.
- All units are standard with 1" adjustable glides that allow for leveling

2 Select Finish

[Click to view finishes](#)

NA

3 Combination Fabrics

[Click to view finishes](#)

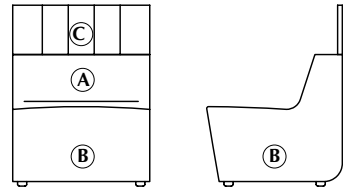

DARRAN is pleased to offer customers the design freedom of combination fabrics. When using fabric, vinyl or leather combinations, pricing/yardage requirements will be as follows:

- A Inside Back & Seat 1 yd
- B Lounge Exterior 3 yds
- C Privacy Screen 1 yd

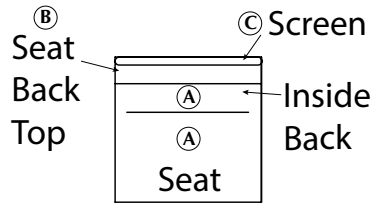

- When combining two materials of the same grade, pricing will be specified grade + 5%
- If combining two materials of different grades or leather/fabric combination, use the highest grade/price + 5%
- If using COM or COL, pricing will be COM or COL + 5%.
- If both COM + COL are used in combination, use COL + 5%.

Node Power Placement Option

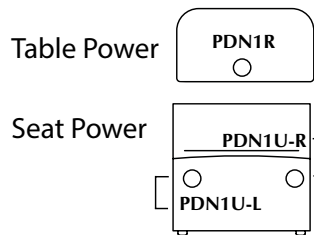

Options

Ganging Device

- GDEV-L: Left Facing Ganging Device - \$20
- GDEV-R: Right Facing Ganging Device - \$20
- GDEV-C: Center Ganging Device - \$40

Power

- PDN1U-L: Node in Left Facing Seat Front; 1 Power/1 USB Charger - \$355
- PDN1U-R: Node in Right Facing Seat Front; 1 Power/1 USB Charger - \$355
- PDN1U-B: Node in Both Left and Right Facing Seat Front; 1 Power/1 USB Charger per pod - \$709
- PDN1R- Node in Rear Mount Table Top; 1 Power/1 USB Charger - \$409
- Standard in White (Available in Silver and Black)
- 1/2" Compact Matte Laminate Rear Table**
- Matte Laminate RTD29: Rear Work Table - \$633, Specify LAW Alaska or LNB Nero Finish
- Rear table available on units that gang providing stability
- Rear table is mounted at 28.5"
- Premium Finish Option (Standard White)**
- Specify rear table bracket Metal Finish color - \$100 per unit
- MFS: Silver, MFB: Black

Bota

Single Seat With Privacy Screen
 Low Back - 24.75" Privacy Screen

[Click here to view statement of line](#)

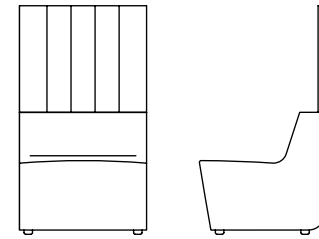

1 Model BOT0160SLC21

w" x d" x h"
 29.5 x 29.25 x 53.25
 Arm Height -
 Seat Height 17.5
 Inside Seat Depth 17
 Inside Seat Width 29.5

COM	COL	1	2	3	4	5	6	7	8	9	10	11/L1	12	13/L2
2973	3115	3158	3249	3340	3431	3522	3613	3704	3795	3886	3977	4068	4159	4341

Upholstery Requirements
 Fabric yds: 5 Leather Sq. Ft.: 90
 Carton Weight: 65

Product Features

- Horizontal back provides easy ganging capabilities.
- Utilizes elastic webbing suspension that conforms to individual's lumbar curvatures for adaptive support.
- Upholstered Privacy Screen
- Upholstered screens can be specified in contrasting fabrics, vinyl, or leathers.
- All units are standard with 1" adjustable glides that allow for leveling

2 Select Finish

[Click to view finishes](#)

NA

3 Combination Fabrics

[Click to view finishes](#)

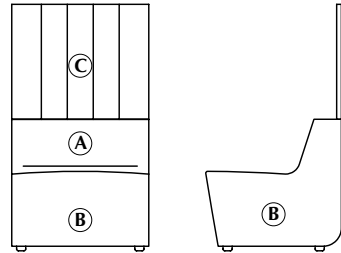

DARRAN is pleased to offer customers the design freedom of combination fabrics. When using fabric, vinyl or leather combinations, pricing/yardage requirements will be as follows:

- A Inside Back & Seat 1 yd
- B Lounge Exterior 3 yds
- C Privacy Screen 1.5 yds

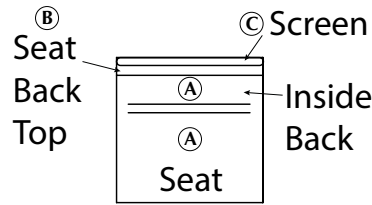

- When combining two materials of the same grade, pricing will be specified grade + 5%
- If combining two materials of different grades or leather/fabric combination, use the highest grade/price + 5%
- If using COM or COL, pricing will be COM or COL + 5%.
- If both COM + COL are used in combination, use COL + 5%.

Node Power Placement Option

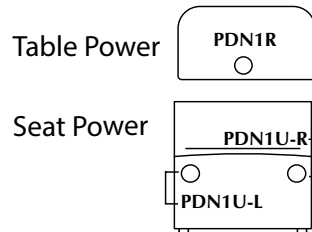

Options

Ganging Device

- GDEV-L: Left Facing Ganging Device - \$20
- GDEV-R: Right Facing Ganging Device - \$20
- GDEV-C: Center Ganging Device - \$40

Power

- PDN1U-L: Node in Left Facing Seat Front; 1 Power/1 USB Charger - \$355
- PDN1U-R: Node in Right Facing Seat Front; 1 Power/1 USB Charger - \$355
- PDN1U-B: Node in Both Left and Right Facing Seat Front; 1 Power/1 USB Charger per pod - \$709
- PDN1R- Node in Rear Mount Table Top; 1 Power/1 USB Charger - \$409
- Standard in White (Available in Silver and Black)

1/2" Compact Matte Laminate Rear Table

- Matte Laminate RTD29: Rear Work Table - \$633, Specify LAW Alaska or LNB Nero Finish
- Rear table available on units that gang providing stability
- Rear table is mounted at 28.5"

Premium Finish Option (Standard White)

- Specify rear table bracket Metal Finish color - \$100 per unit
- MFS: Silver, MFB: Black

Bota

Single Seat
High Back

[Click here to view statement of line](#)

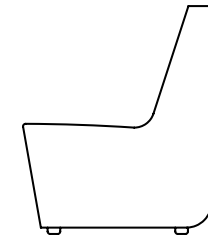
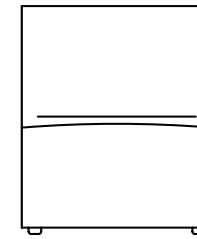

1 Model BOT0160SHC01

w" x d" x h"
29.5 x 29.25 x 35.5
Arm Height -
Seat Height 17.5
Inside Seat Depth 17
Inside Seat Width 29.5

COM	COL	1	2	3	4	5	6	7	8	9	10	11/L1	12	13/L2
2197	2297	2345	2418	2491	2564	2637	2710	2783	2856	2929	3002	3075	3148	3294

Upholstery Requirements
Fabric yds: 4 Leather Sq. Ft.: 72
Carton Weight: 50

2 Select Finish

[Click to view finishes](#)

NA

3 Combination Fabrics

[Click to view finishes](#)

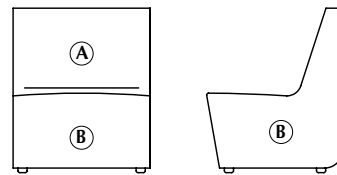

DARRAN is pleased to offer customers the design freedom of combination fabrics. When using fabric, vinyl or leather combinations, pricing/yardage requirements will be as follows:

A Inside Back & Seat 1.5 yds
B Lounge Exterior 3 yds

Top View

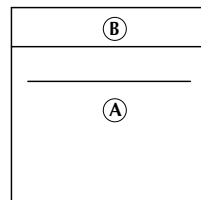

- When combining two materials of the same grade, pricing will be specified grade + 5%
- If combining two materials of different grades or leather/fabric combination, use the highest grade/price + 5%
- If using COM or COL, pricing will be COM or COL + 5%.
- If both COM + COL are used in combination, use COL + 5%.

Node Power Placement Option

Table Power Seat Power

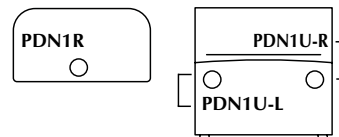

Product Features

- Horizontal back provides easy ganging capabilities.
- Utilizes elastic webbing suspension that conforms to individual's lumbar curvatures for adaptive support.
- All units are standard with 1" adjustable glides that allow for leveling

Options

Ganging Device

- GDEV-L: Left Facing Ganging Device - \$20
- GDEV-R: Right Facing Ganging Device - \$20
- GDEV-C: Center Ganging Device - \$40

Power

- PDN1U-L: Node in Left Facing Seat Front; 1 Power/1 USB Charger - \$355
- PDN1U-R: Node in Right Facing Seat Front; 1 Power/1 USB Charger - \$355
- PDN1U-B: Node in Both Left and Right Facing Seat Front; 1 Power/1 USB Charger per pod - \$709
- PDN1R- Node in Rear Mount Table Top; 1 Power/1 USB Charger - \$409
- Standard in White (Available in Silver and Black)

1/2" Compact Matte Laminate Rear Table

- Matte Laminate RTD29: Rear Work Table - \$633, Specify LAW Alaska or LNB Nero Finish
- Rear table available on units that gang providing stability
- Rear table is mounted at 35.5"

Premium Finish Option (Standard White)

- Specify rear table bracket Metal Finish color - \$100 per unit
- MFS: Silver, MFB: Black

Bota

Single Seat With Privacy Screen
High Back - 10.5" Privacy Screen

[Click here to view statement of line](#)

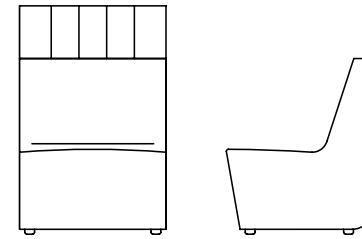

1 Model BOT0160SHC11

w" x d" x h"
29.5 x 29.25 x 46
Arm Height -
Seat Height 17.5
Inside Seat Depth 17
Inside Seat Width 29.5

COM	COL	1	2	3	4	5	6	7	8	9	10	11/L1	12	13/L2
2872	2994	3057	3148	3239	3330	3421	3512	3603	3694	3785	3876	3967	4058	4240

Upholstery Requirements
Fabric yds: 5 Leather Sq. Ft.: 90
Carton Weight: 60

Product Features

- Horizontal back provides easy ganging capabilities.
- Utilizes elastic webbing suspension that conforms to individual's lumbar curvatures for adaptive support.
- Upholstered Privacy Screen
- Upholstered screens can be specified in contrasting fabrics, vinyl, or leathers.
- All units are standard with 1" adjustable glides that allow for leveling

2 Select Finish

[Click to view finishes](#)

NA

3 Combination Fabrics

[Click to view finishes](#)

DARRAN is pleased to offer customers the design freedom of combination fabrics. When using fabric, vinyl or leather combinations, pricing/yardage requirements will be as follows:

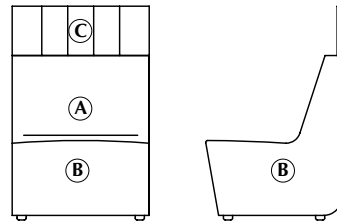

A Inside Back & Seat 2.5 yds
B Lounge Exterior 4 yds
C Privacy Screen 2 yd

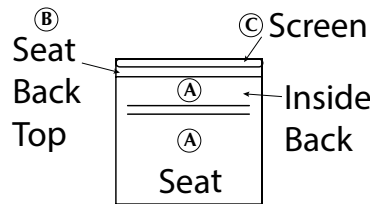

- When combining two materials of the same grade, pricing will be specified grade + 5%
- If combining two materials of different grades or leather/fabric combination, use the highest grade/price + 5%
- If using COM or COL, pricing will be COM or COL + 5%.
- If both COM + COL are used in combination, use COL + 5%.

Node Power Placement Option

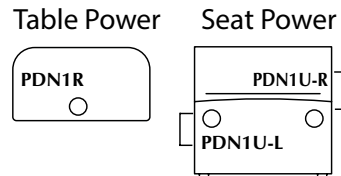

Options

Ganging Device

- GDEV-L: Left Facing Ganging Device - \$20
- GDEV-R: Right Facing Ganging Device - \$20
- GDEV-C: Center Ganging Device - \$40

Power

- PDN1U-L: Node in Left Facing Seat Front; 1 Power/1 USB Charger - \$355
- PDN1U-R: Node in Right Facing Seat Front; 1 Power/1 USB Charger - \$355
- PDN1U-B: Node in Both Left and Right Facing Seat Front; 1 Power/1 USB Charger per pod - \$709
- PDN1R- Node in Rear Mount Table Top; 1 Power/1 USB Charger - \$409
- Standard in White (Available in Silver and Black)

1/2" Compact Matte Laminate Rear Table

- Matte Laminate RTD29: Rear Work Table - \$633, Specify LAW Alaska or LNB Nero Finish
- Rear table available on units that gang providing stability
- Rear table is mounted at 35.5"

Premium Finish Option (Standard White)

- Specify rear table bracket Metal Finish color - \$100 per unit
- MFS: Silver, MFB: Black

Bota

Single Seat With Privacy Screen
High Back - 17.5" Privacy Screen

[Click here to view statement of line](#)

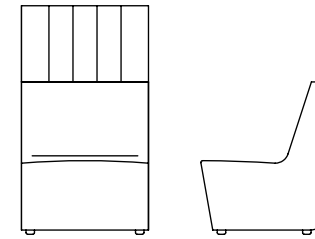

1 Model BOT0160SHC21

w" x d" x h"
29.5 x 29.25 x 53
Arm Height -
Seat Height 17.5
Inside Seat Depth 17
Inside Seat Width 29.5

COM	COL	1	2	3	4	5	6	7	8	9	10	11/L1	12	13/L2
3081	3218	3285	3385	3485	3585	3685	3785	3885	3985	4085	4185	4285	4385	4585

Upholstery Requirements
Fabric yds: 5.5 Leather Sq. Ft.: 99
Carton Weight: 65

2 Select Finish

[Click to view finishes](#)

NA

3 Combination Fabrics

[Click to view finishes](#)

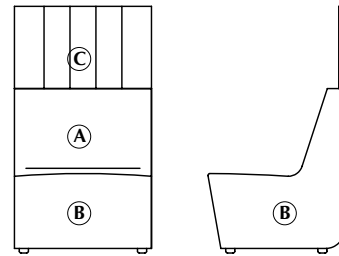

DARRAN is pleased to offer customers the design freedom of combination fabrics. When using fabric, vinyl or leather combinations, pricing/yardage requirements will be as follows:

A Inside Back & Seat 1.5 yds
B Lounge Exterior 3 yds
C Privacy Screen 1.5 yds

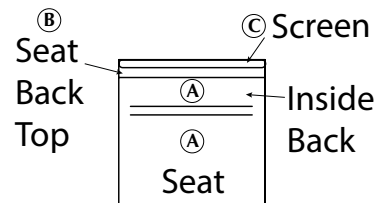

- When combining two materials of the same grade, pricing will be specified grade + 5%
- If combining two materials of different grades or leather/fabric combination, use the highest grade/price + 5%
- If using COM or COL, pricing will be COM or COL + 5%.
- If both COM + COL are used in combination, use COL + 5%.

Node Power Placement Option

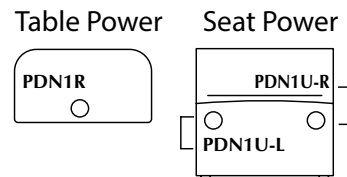

Product Features

- Horizontal back provides easy ganging capabilities.
- Utilizes elastic webbing suspension that conforms to individual's lumbar curvatures for adaptive support.
- Upholstered Privacy Screen
- Upholstered screens can be specified in contrasting fabrics, vinyl, or leathers.
- All units are standard with 1" adjustable glides that allow for leveling

Options

Ganging Device

- GDEV-L: Left Facing Ganging Device - \$20
- GDEV-R: Right Facing Ganging Device - \$20
- GDEV-C: Center Ganging Device - \$40

Power

- PDN1U-L: Node in Left Facing Seat Front; 1 Power/1 USB Charger - \$355
- PDN1U-R: Node in Right Facing Seat Front; 1 Power/1 USB Charger - \$355
- PDN1U-B: Node in Both Left and Right Facing Seat Front; 1 Power/1 USB Charger per pod - \$709
- PDN1R- Node in Rear Mount Table Top; 1 Power/1 USB Charger - \$409
- Standard in White (Available in Silver and Black)

1/2" Compact Matte Laminate Rear Table

- Matte Laminate RTD29: Rear Work Table - \$633, Specify LAW Alaska or LNB Nero Finish
- Rear table available on units that gang providing stability
- Rear table is mounted at 35.5"

Premium Finish Option (Standard White)

- Specify rear table bracket Metal Finish color - \$100 per unit
- MFS: Silver, MFB: Black

Bota

Double Seat
Low Back

[Click here to view statement of line](#)

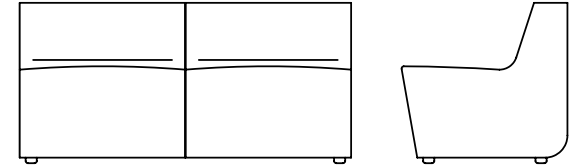

1 Model BOT0160DLC02

w" x d" x h"
59 x 29.25 x 28.5
Arm Height -
Seat Height 17.5
Inside Seat Depth 17
Inside Seat Width 29.5

COM	COL	1	2	3	4	5	6	7	8	9	10	11/L1	12	13/L2
3387	3544	3609	3718	3827	3936	4045	4154	4263	4372	4481	4590	4699	4808	5026

Upholstery Requirements
Fabric yds: 6 Leather Sq. Ft.: 108
Carton Weight: 90

2 Select Finish

[Click to view finishes](#)

NA

3 Combination Fabrics

[Click to view finishes](#)

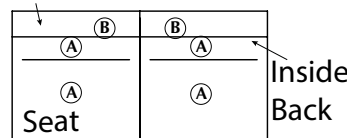
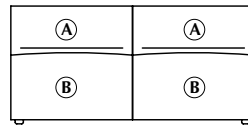
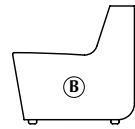

DARRAN is pleased to offer customers the design freedom of combination fabrics. When using fabric, vinyl or leather combinations, pricing/yardage requirements will be as follows:

A Inside Back & Seat 2 yds
B Lounge Exterior 4 yds

- When combining two materials of the same grade, pricing will be specified grade + 5%
- If combining two materials of different grades or leather/fabric combination, use the highest grade/price + 5%
- If using COM or COL, pricing will be COM or COL + 5%.
- If both COM + COL are used in combination, use COL + 5%.

Node Power Placement Option

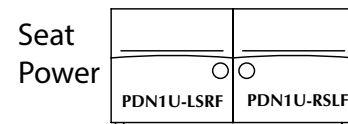

Product Features

- Horizontal back provides easy ganging capabilities.
- Utilizes elastic webbing suspension that conforms to individual's lumbar curvatures for adaptive support.
- All units are standard with 1" adjustable glides that allow for leveling

Options

Ganging Device

- GDEV-L: Left Facing Ganging Device - \$20
- GDEV-R: Right Facing Ganging Device - \$20
- GDEV-C: Center Ganging Device - \$40

Power

- PDN1U-LSRF: Node in Left Seat Right Facing Seat Front; 1 Power/1 USB Charger - \$355
- PDN1U-RSLF: Node in Right Seat Left Facing Seat Front; 1 Power/1 USB Charger - \$355
- PDN1U-BC: Node in Both Left and Right Facing Center Seat Front; 1 Power/1 USB Charger per pod - \$709
- PDN1R: Node in Rear Mount Table Top; 1 Power/1 USB Charger - \$409
- Standard in White (Available in Silver and Black)

1/2" Compact Matte Laminate Rear Table

- Matte Laminate RTD59: Rear Work Table - \$862, Specify LAW Alaska or LNB Nero Finish
- Rear table available on units that gang providing stability
- Rear table is mounted at 28.5"

1/2" Compact Matte Laminate Tablet

- FFTD: 1/2" Compact Matte Laminate Tablet - \$622, Specify LAW Alaska or LNB Nero Finish
- Tablet is center mount only

Premium Finish Option (Standard White)

- Specify rear table bracket Metal Finish color - \$100 per unit
- Specify tablet Metal Finish color - \$100 per unit
- MFS: Silver, MFB: Black

Bota

Double Seat With Privacy Screen
 Low Back - 10.5" Privacy Screen

[Click here to view statement of line](#)

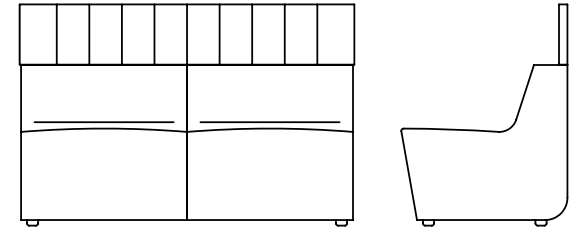

1 Model BOT0160DLC12

w" x d" x h"
 59 x 29.25 x 39
 Arm Height -
 Seat Height 17.5
 Inside Seat Depth 17
 Inside Seat Width 29.5

COM	COL	1	2	3	4	5	6	7	8	9	10	11/L1	12	13/L2
4335	4535	4631	4777	4923	5069	5215	5361	5507	5653	5799	5945	6091	6237	6529

Upholstery Requirements
 Fabric yds: 8 Leather Sq. Ft.: 144
 Carton Weight: 110

2 Select Finish

[Click to view finishes](#)

NA

3 Combination Fabrics

[Click to view finishes](#)

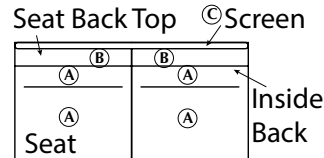
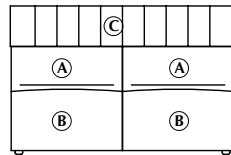
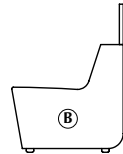

DARRAN is pleased to offer customers the design freedom of combination fabrics. When using fabric, vinyl or leather combinations, pricing/yardage requirements will be as follows:

- A Inside Back & Seat 2 yds
- B Lounge Exterior 4 yds
- C Privacy Screen 2 yds

- When combining two materials of the same grade, pricing will be specified grade + 5%
- If combining two materials of different grades or leather/fabric combination, use the highest grade/price + 5%
- If using COM or COL, pricing will be COM or COL + 5%.
- If both COM + COL are used in combination, use COL + 5%.

Node Power Placement Option

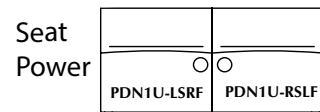

Product Features

- Horizontal back provides easy ganging capabilities.
- Utilizes elastic webbing suspension that conforms to individual's lumbar curvatures for adaptive support.
- Upholstered Privacy Screen
- Upholstered screens can be specified in contrasting fabrics, vinyl, or leathers.
- All units are standard with 1" adjustable glides that allow for leveling

Options

Ganging Device

- GDEV-L: Left Facing Ganging Device - \$20
- GDEV-R: Right Facing Ganging Device - \$20
- GDEV-C: Center Ganging Device - \$40

Power

- PDN1U-LSRF: Node in Left Seat Right Facing Seat Front; 1 Power/1 USB Charger - \$355
- PDN1U-RSLF: Node in Right Seat Left Facing Seat Front; 1 Power/1 USB Charger - \$355
- PDN1U-BC: Node in Both Left and Right Facing Center Seat Front; 1 Power/1 USB Charger per pod - \$709
- PDN1R: Node in Rear Mount Table Top; 1 Power/1 USB Charger - \$409
- Standard in White (Available in Silver and Black)

1/2" Compact Matte Laminate Rear Table

- Matte Laminate RTD59: Rear Work Table - \$862, Specify LAW Alaska or LNB Nero Finish
- Rear table available on units that gang providing stability
- Rear table is mounted at 28.5"

1/2" Compact Matte Laminate Tablet

- FFD: 1/2" Compact Matte Laminate Tablet - \$622, Specify LAW Alaska or LNB Nero Finish
- Tablet is center mount only

Premium Finish Option (Standard White)

- Specify rear table bracket Metal Finish color - \$100 per unit
- Specify tablet Metal Finish color - \$100 per unit
- MFS: Silver, MFB: Black

Bota

Double Seat With Privacy Screen
 Low Back - 24.75" Privacy Screen

[Click here to view statement of line](#)

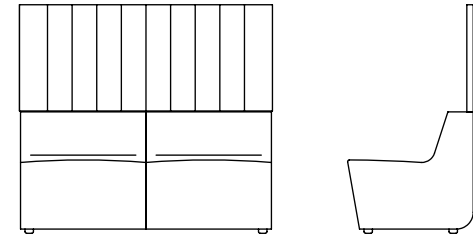

1 Model BOT0160DLC22

w" x d" x h"
 59 x 29.25 x 53.25
 Arm Height -
 Seat Height 17.5
 Inside Seat Depth 17
 Inside Seat Width 29.5

COM	COL	1	2	3	4	5	6	7	8	9	10	11/L1	12	13/L2
5131	5390	5427	5573	5719	5865	6011	6157	6303	6449	6595	6741	6887	7033	7325

Upholstery Requirements
 Fabric yds: 8 Leather Sq. Ft.: 144
 Carton Weight: 130

2 Select Finish

[Click to view finishes](#)

NA

3 Combination Fabrics

[Click to view finishes](#)

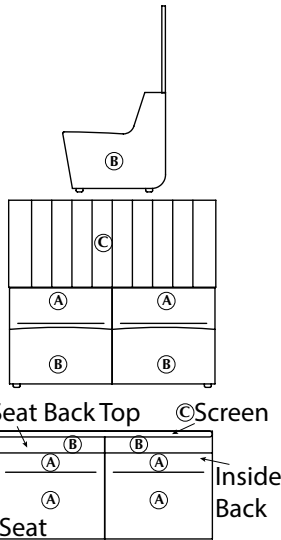

DARRAN is pleased to offer customers the design freedom of combination fabrics. When using fabric, vinyl or leather combinations, pricing/yardage requirements will be as follows:

- A Inside Back & Seat 2 yds
- B Lounge Exterior 4 yds
- C Privacy Screen 3.5 yds

- When combining two materials of the same grade, pricing will be specified grade + 5%
- If combining two materials of different grades or leather/fabric combination, use the highest grade/price + 5%
- If using COM or COL, pricing will be COM or COL + 5%.
- If both COM + COL are used in combination, use COL + 5%.

Node Power Placement Option

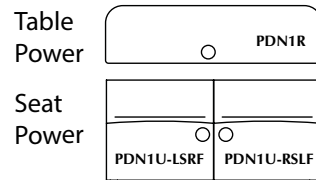

Product Features

- Horizontal back provides easy ganging capabilities.
- Utilizes elastic webbing suspension that conforms to individual's lumbar curvatures for adaptive support.
- Upholstered Privacy Screen
- Upholstered screens can be specified in contrasting fabrics, vinyl, or leathers.
- All units are standard with 1" adjustable glides that allow for leveling

Options

Ganging Device

- GDEV-L: Left Facing Ganging Device - \$20
- GDEV-R: Right Facing Ganging Device - \$20
- GDEV-C: Center Ganging Device - \$40

Power

- PDN1U-LSRF: Node in Left Seat Right Facing Seat Front; 1 Power/1 USB Charger - \$355
- PDN1U-RSLF: Node in Right Seat Left Facing Seat Front; 1 Power/1 USB Charger - \$355
- PDN1U-BC: Node in Both Left and Right Facing Center Seat Front; 1 Power/1 USB Charger per pod - \$709
- PDN1R: Node in Rear Mount Table Top; 1 Power/1 USB Charger - \$409
- Standard in White (Available in Silver and Black)

1/2" Compact Matte Laminate Rear Table

- Matte Laminate RTD59: Rear Work Table - \$862, Specify LAW Alaska or LNB Nero Finish
- Rear table available on units that gang providing stability
- Rear table is mounted at 28.5"

1/2" Compact Matte Laminate Tablet

- FFD: 1/2" Compact Matte Laminate Tablet - \$622, Specify LAW Alaska or LNB Nero Finish
- Tablet is center mount only

Premium Finish Option (Standard White)

- Specify rear table bracket Metal Finish color - \$100 per unit
- Specify tablet Metal Finish color - \$100 per unit
- MFS: Silver, MFB: Black

Bota

Double Seat
High Back

[Click here to view statement of line](#)

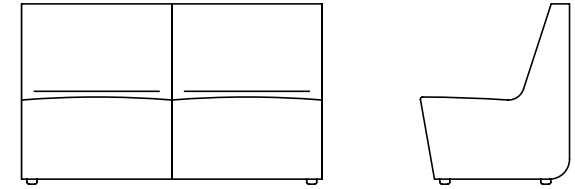

1 Model BOT0160DHC02

w" x d" x h"
59 x 29.25 x 35.5
Arm Height -
Seat Height 17.5
Inside Seat Depth 17
Inside Seat Width 29.5

COM	COL	1	2	3	4	5	6	7	8	9	10	11/L1	12	13/L2
3766	3938	4007	4126	4245	4364	4483	4602	4721	4840	4959	5078	5197	5316	5554

Upholstery Requirements
Fabric yds: 6.5 Leather Sq. Ft.: 117
Carton Weight: 95

2 Select Finish

[Click to view finishes](#)

NA

3 Combination Fabrics

[Click to view finishes](#)

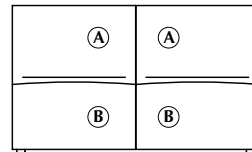
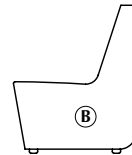

Seat Back Top

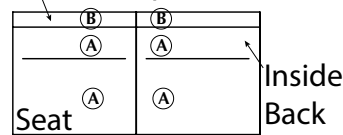

DARRAN is pleased to offer customers the design freedom of combination fabrics. When using fabric, vinyl or leather combinations, pricing/yardage requirements will be as follows:

A Inside Back & Seat 2.5 yds
B Lounge Exterior 4.5 yds

- When combining two materials of the same grade, pricing will be specified grade + 5%
- If combining two materials of different grades or leather/fabric combination, use the highest grade/price + 5%
- If using COM or COL, pricing will be COM or COL + 5%.
- If both COM + COL are used in combination, use COL + 5%.

Node Power Placement Option

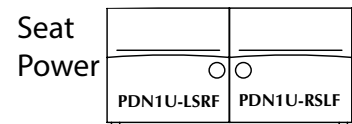

Product Features

- Horizontal back provides easy ganging capabilities.
- Utilizes elastic webbing suspension that conforms to individual's lumbar curvatures for adaptive support.
- All units are standard with 1" adjustable glides that allow for leveling

Options

Ganging Device

- GDEV-L: Left Facing Ganging Device - \$20
- GDEV-R: Right Facing Ganging Device - \$20
- GDEV-C: Center Ganging Device - \$40

Power

- PDN1U-LSRF: Node in Left Seat Right Facing Seat Front; 1 Power/1 USB Charger - \$355
- PDN1U-RSLF: Node in Right Seat Left Facing Seat Front; 1 Power/1 USB Charger - \$355
- PDN1U-BC: Node in Both Left and Right Facing Center Seat Front; 1 Power/1 USB Charger per pod - \$709
- PDN1R: Node in Rear Mount Table Top; 1 Power/1 USB Charger - \$409
- Standard in White (Available in Silver and Black)

1/2" Compact Matte Laminate Rear Table

- Matte Laminate RTD59: Rear Work Table - \$862, Specify LAW Alaska or LNB Nero Finish
- Rear table available on units that gang providing stability
- Rear table is mounted at 35.5"

1/2" Compact Matte Laminate Tablet

- FFTD: 1/2" Compact Matte Laminate Tablet - \$622, Specify LAW Alaska or LNB Nero Finish
- Tablet is center mount only

Premium Finish Option (Standard White)

- Specify rear table bracket Metal Finish color - \$100 per unit
- Specify tablet Metal Finish color - \$100 per unit
- MFS: Silver, MFB: Black

DARRAN

Bota

Double Seat With Privacy Screen
High Back - 10.5" Privacy Screen

[Click here to view statement of line](#)

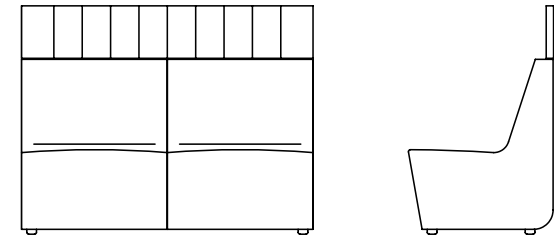

1 Model BOT0160DHC12

w" x d" x h"
59 x 29.25 x 46
Arm Height -
Seat Height 17.5
Inside Seat Depth 17
Inside Seat Width 29.5

COM	COL	1	2	3	4	5	6	7	8	9	10	11/L1	12	13/L2
4709	4924	5024	5179	5334	5489	5644	5799	5954	6109	6264	6419	6574	6729	7039

Upholstery Requirements
Fabric yds: 8.5 Leather Sq. Ft.: 153
Carton Weight: 115

2 Select Finish

[Click to view finishes](#)

NA

3 Combination Fabrics

[Click to view finishes](#)

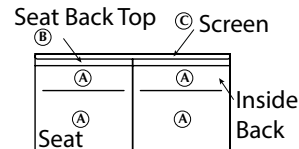
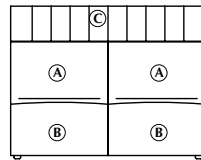
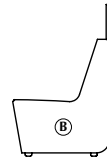

DARRAN is pleased to offer customers the design freedom of combination fabrics. When using fabric, vinyl or leather combinations, pricing/yardage requirements will be as follows:

A Inside Back & Seat 2.5 yds
B Lounge Exterior 4.5 yds
C Privacy Screen 2 yds

- When combining two materials of the same grade, pricing will be specified grade + 5%
- If combining two materials of different grades or leather/fabric combination, use the highest grade/price + 5%
- If using COM or COL, pricing will be COM or COL + 5%.
- If both COM + COL are used in combination, use COL + 5%.

Node Power Placement Option

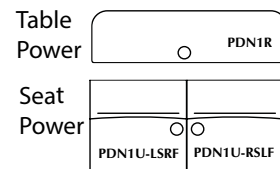

Product Features

- Horizontal back provides easy ganging capabilities.
- Utilizes elastic webbing suspension that conforms to individual's lumbar curvatures for adaptive support.
- Upholstered Privacy Screen
- Upholstered screens can be specified in contrasting fabrics, vinyl, or leathers.
- All units are standard with 1" adjustable glides that allow for leveling

Options

Ganging Device

- GDEV-L: Left Facing Ganging Device - \$20
- GDEV-R: Right Facing Ganging Device - \$20
- GDEV-C: Center Ganging Device - \$40

Power

- PDN1U-LSRF: Node in Left Seat Right Facing Seat Front; 1 Power/1 USB Charger - \$355
- PDN1U-RSLF: Node in Right Seat Left Facing Seat Front; 1 Power/1 USB Charger - \$355
- PDN1U-BC: Node in Both Left and Right Facing Center Seat Front; 1 Power/1 USB Charger per pod - \$709
- PDN1R: Node in Rear Mount Table Top; 1 Power/1 USB Charger - \$409
- Standard in White (Available in Silver and Black)

1/2" Compact Matte Laminate Rear Table

- Matte Laminate RTD59: Rear Work Table - \$862, Specify LAW Alaska or LNB Nero Finish
- Rear table available on units that gang providing stability
- Rear table is mounted at 35.5"

1/2" Compact Matte Laminate Tablet

- FFD: 1/2" Compact Matte Laminate Tablet - \$622, Specify LAW Alaska or LNB Nero Finish
- Tablet is center mount only

Premium Finish Option (Standard White)

- Specify rear table bracket Metal Finish color - \$100 per unit
- Specify tablet Metal Finish color - \$100 per unit
- MFS: Silver, MFB: Black

Bota

Double Seat With Privacy Screen
High Back - 17.5" Privacy Screen

[Click here to view statement of line](#)

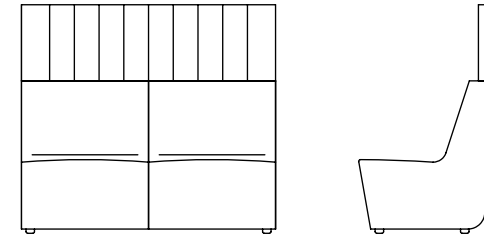

1 Model BOT0160DHC22

w" x d" x h"
59 x 29.25 x 53
Arm Height -
Seat Height 17.5
Inside Seat Depth 17
Inside Seat Width 29.5

COM	COL	1	2	3	4	5	6	7	8	9	10	11/L1	12	13/L2
5169	5414	5558	5750	5942	6134	6326	6518	6710	6902	7094	7286	7478	7670	8054

Upholstery Requirements
Fabric yds: 10.5 Leather Sq. Ft.: 189
Carton Weight: 135

2 Select Finish

[Click to view finishes](#)

NA

3 Combination Fabrics

[Click to view finishes](#)

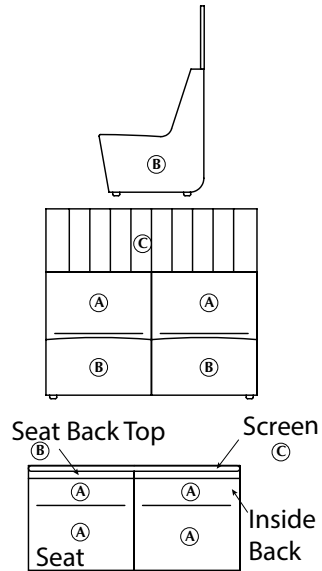

DARRAN is pleased to offer customers the design freedom of combination fabrics. When using fabric, vinyl or leather combinations, pricing/yardage requirements will be as follows:

- A Inside Back & Seat 2.5 yds
- B Lounge Exterior 4.5 yds
- C Privacy Screen 4 yds

- When combining two materials of the same grade, pricing will be specified grade + 5%
- If combining two materials of different grades or leather/fabric combination, use the highest grade/price + 5%
- If using COM or COL, pricing will be COM or COL + 5%.
- If both COM + COL are used in combination, use COL + 5%.

Node Power Placement Option

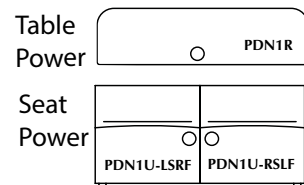

Product Features

- Horizontal back provides easy ganging capabilities.
- Utilizes elastic webbing suspension that conforms to individual's lumbar curvatures for adaptive support.
- Upholstered Privacy Screen
- Upholstered screens can be specified in contrasting fabrics, vinyl, or leathers.
- All units are standard with 1" adjustable glides that allow for leveling

Options

Ganging Device

- GDEV-L: Left Facing Ganging Device - \$20
- GDEV-R: Right Facing Ganging Device - \$20
- GDEV-C: Center Ganging Device - \$40

Power

- PDN1U-LSRF: Node in Left Seat Right Facing Seat Front; 1 Power/1 USB Charger - \$355
- PDN1U-RSLF: Node in Right Seat Left Facing Seat Front; 1 Power/1 USB Charger - \$355
- PDN1U-BC: Node in Both Left and Right Facing Center Seat Front; 1 Power/1 USB Charger per pod - \$709
- PDN1R- Node in Rear Mount Table Top; 1 Power/1 USB Charger - \$409
- Standard in White (Available in Silver and Black)

1/2" Compact Matte Laminate Rear Table

- Matte Laminate RTD59: Rear Work Table - \$862, Specify LAW Alaska or LNB Nero Finish
- Rear table available on units that gang providing stability
- Rear table is mounted at 35.5"

1/2" Compact Matte Laminate Tablet

- FFTD: 1/2" Compact Matte Laminate Tablet - \$622, Specify LAW Alaska or LNB Nero Finish
- Tablet is center mount only

Premium Finish Option (Standard White)

- Specify rear table bracket Metal Finish color - \$100 per unit
- Specify tablet Metal Finish color - \$100 per unit
- MFS: Silver, MFB: Black

Bota

Triple Seat
Low Back

[Click here to view statement of line](#)

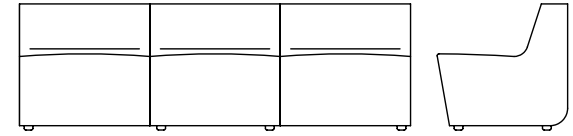

1 Model BOT0160TLC03

w" x d" x h"
88.5 x 29.25 x 28.5
Arm Height -
Seat Height 17.5
Inside Seat Depth 17
Inside Seat Width 29.5

COM	COL	1	2	3	4	5	6	7	8	9	10	11/L1	12	13/L2
4753	5020	5086	5250	5414	5578	5742	5906	6070	6234	6398	6562	6726	6890	7218

Upholstery Requirements
Fabric yds: 8 Leather Sq. Ft.: 144
Carton Weight: 135

2 Select Finish

[Click to view finishes](#)

NA

3 Combination Fabrics

[Click to view finishes](#)

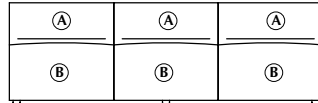
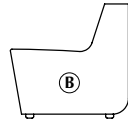

Seat Back Top

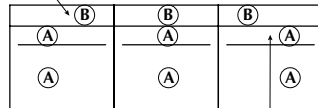

Inside Back

Node Power Placement Option

Table Power

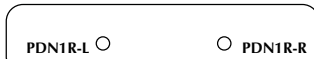

Seat Power

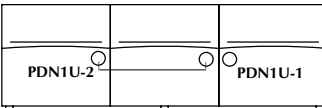

DARRAN is pleased to offer customers the design freedom of combination fabrics. When using fabric, vinyl or leather combinations, pricing/yardage requirements will be as follows:

A Inside Back & Seat 3 yds
B Lounge Exterior 6 yds

- When combining two materials of the same grade, pricing will be specified grade + 5%
- If combining two materials of different grades or leather/fabric combination, use the highest grade/price + 5%
- If using COM or COL, pricing will be COM or COL + 5%.
- If both COM + COL are used in combination, use COL + 5%.

Product Features

- Horizontal back provides easy ganging capabilities.
- Utilizes elastic webbing suspension that conforms to individual's lumbar curvatures for adaptive support.
- All units are standard with 1" adjustable glides that allow for leveling

Options

Ganging Device

- GDEV-L: Left Facing Ganging Device - \$20
- GDEV-R: Right Facing Ganging Device - \$20
- GDEV-C: Center Ganging Device - \$40

Power

- PDN1U-1: Node in Right Facing Seat Front; 1 Power/1 USB Charger - \$355
- PDN1U-2: Node in Left and Center Seat, Right Facing Seat Fronts; 1 power/1 USB per pod - \$709
- PDN1R-R: Node in Right Facing Rear Mount Table Top; 1 Power/1 USB Charger - \$409
- PDN2R-L- 2 Node in Left Facing Rear Mount Table Top; 1 Power/1 USB Charger - \$375
- Standard in White (Available in Silver and Black)

1/2" Compact Matte Laminate Rear Table

- Matte Laminate RTD88: Rear Work Table - \$1,096, Specify LAW Alaska or LNB Nero Finish
- Rear table available on units that gang providing stability
- Rear table is mounted at 28.5"

1/2" Compact Matte Laminate Tablet

- FFTD: 1/2" Compact Matte Laminate Tablet - \$622, Specify LAW Alaska or LNB Nero Finish
- Tablet mounts left or right of center cushion

Premium Finish Option (Standard White)

- Specify rear table bracket Metal Finish color - \$100 per unit
- Specify tablet Metal Finish color - \$100 per unit
- MFS: Silver, MFB: Black

Bota

Triple Seat With Privacy Screen
Low Back - 10.5" Privacy Screen

[Click here to view statement of line](#)

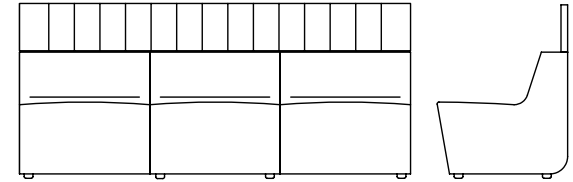

1 Model BOT0160TLC13

w" x d" x h"
88.5 x 29.25 x 39
Arm Height -
Seat Height 17.5
Inside Seat Depth 17
Inside Seat Width 29.5

COM	COL	1	2	3	4	5	6	7	8	9	10	11/L1	12	13/L2
6101	6456	6490	6682	6874	7066	7258	7450	7642	7834	8026	8218	8410	8602	8986

Upholstery Requirements
Fabric yds: 10.5 Leather Sq. Ft.: 189
Carton Weight: 165

2 Select Finish

[Click to view finishes](#)

NA

3 Combination Fabrics

[Click to view finishes](#)

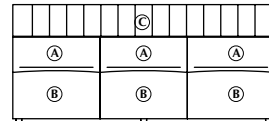
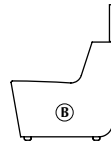

B Seat Back Top Screen C

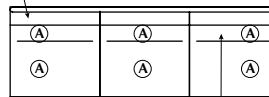

Inside Back

Node Power Placement Option

Table Power



Seat Power

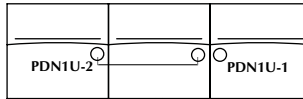

DARRAN is pleased to offer customers the design freedom of combination fabrics. When using fabric, vinyl or leather combinations, pricing/yardage requirements will be as follows:

A Inside Back & Seat 3 yds
B Lounge Exterior 6 yds
C Privacy Screen 2.5 yds

- When combining two materials of the same grade, pricing will be specified grade + 5%
- If combining two materials of different grades or leather/fabric combination, use the highest grade/price + 5%
- If using COM or COL, pricing will be COM or COL + 5%.
- If both COM + COL are used in combination, use COL + 5%.

Product Features

- Horizontal back provides easy ganging capabilities.
- Utilizes elastic webbing suspension that conforms to individual's lumbar curvatures for adaptive support.
- Upholstered Privacy Screen
- Upholstered screens can be specified in contrasting fabrics, vinyl, or leathers.
- All units are standard with 1" adjustable glides that allow for leveling

Options

Ganging Device

- GDEV-L: Left Facing Ganging Device - \$20
- GDEV-R: Right Facing Ganging Device - \$20
- GDEV-C: Center Ganging Device - \$40

Power

- PDN1U-1: Node in Right Facing Seat Front; 1 Power/1 USB Charger - \$355
- PDN1U-2: Node in Left and Center Seat, Right Facing Seat Fronts; 1 power/1 USB per pod - \$709
- PDN1R-R: Node in Right Facing Rear Mount Table Top; 1 Power/1 USB Charger - \$409
- PDN2R-L- 2 Node in Left Facing Rear Mount Table Top; 1 Power/1 USB Charger - \$375
- Standard in White (Available in Silver and Black)

1/2" Compact Matte Laminate Rear Table

- Matte Laminate RTD88: Rear Work Table - \$1,096, Specify LAW Alaska or LNB Nero Finish
- Rear table available on units that gang providing stability
- Rear table is mounted at 28.5"

1/2" Compact Matte Laminate Tablet

- FFTD: 1/2" Compact Matte Laminate Tablet - \$622, Specify LAW Alaska or LNB Nero Finish
- Tablet mounts left or right of center cushion

Premium Finish Option (Standard White)

- Specify rear table bracket Metal Finish color - \$100 per unit
- Specify tablet Metal Finish color - \$100 per unit
- MFS: Silver, MFB: Black

Bota

Triple Seat With Privacy Screen
 Low Back - 24.75" Privacy Screen

[Click here to view statement of line](#)

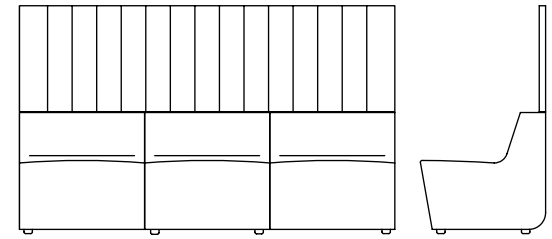

1 Model BOT0160TLC23

w" x d" x h"
 88.5 x 29.25 x 53.25
 Arm Height -
 Seat Height 17.5
 Inside Seat Depth 17
 Inside Seat Width 29.5

COM	COL	1	2	3	4	5	6	7	8	9	10	11/L1	12	13/L2
7076	7475	7557	7794	8031	8268	8505	8742	8979	9216	9453	9690	9927	10164	10638

Upholstery Requirements
 Fabric yds: 13 Leather Sq. Ft.: 234
 Carton Weight: 195

2 Select Finish

[Click to view finishes](#)

NA

3 Combination Fabrics

[Click to view finishes](#)

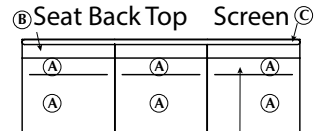
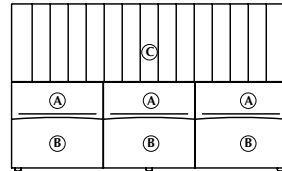
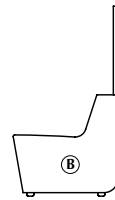

Inside Back

DARRAN is pleased to offer customers the design freedom of combination fabrics. When using fabric, vinyl or leather combinations, pricing/yardage requirements will be as follows:

- A Inside Back & Seat 3 yds
- B Lounge Exterior 6 yds
- C Privacy Screen 5 yds

- When combining two materials of the same grade, pricing will be specified grade + 5%
- If combining two materials of different grades or leather/fabric combination, use the highest grade/price + 5%
- If using COM or COL, pricing will be COM or COL + 5%.
- If both COM + COL are used in combination, use COL + 5%.

Node Power Placement Option

Table Power

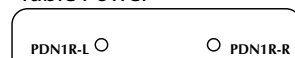

Seat Power

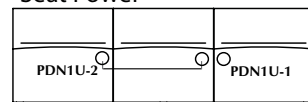

Product Features

- Horizontal back provides easy ganging capabilities.
- Utilizes elastic webbing suspension that conforms to individual's lumbar curvatures for adaptive support.
- Upholstered Privacy Screen
- Upholstered screens can be specified in contrasting fabrics, vinyl, or leathers.
- All units are standard with 1" adjustable glides that allow for leveling

Options

Ganging Device

- GDEV-L: Left Facing Ganging Device - \$20
- GDEV-R: Right Facing Ganging Device - \$20
- GDEV-C: Center Ganging Device - \$40

Power

- PDN1U-1: Node in Right Facing Seat Front; 1 Power/1 USB Charger - \$355
- PDN1U-2: Node in Left and Center Seat, Right Facing Seat Fronts; 1 power/1 USB per pod - \$709
- PDN1R-R: Node in Right Facing Rear Mount Table Top; 1 Power/1 USB Charger - \$409
- PDN2R-L- 2 Node in Left Facing Rear Mount Table Top; 1 Power/1 USB Charger - \$375

- Standard in White (Available in Silver and Black)

1/2" Compact Matte Laminate Rear Table

- Matte Laminate RTD88: Rear Work Table - \$1,096, Specify LAW Alaska or LNB Nero Finish
- Rear table available on units that gang providing stability
- Rear table is mounted at 28.5"

1/2" Compact Matte Laminate Tablet

- FFTD: 1/2" Compact Matte Laminate Tablet - \$622, Specify LAW Alaska or LNB Nero Finish
- Tablet mounts left or right of center cushion

Premium Finish Option (Standard White)

- Specify rear table bracket Metal Finish color - \$100 per unit
- Specify tablet Metal Finish color - \$100 per unit
- MFS: Silver, MFB: Black

Bota

Triple Seat
High Back

[Click here to view statement of line](#)

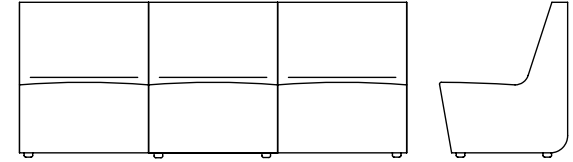

1 Model BOT0160THC03

w" x d" x h"
88.5 x 29.25 x 35.5
Arm Height -
Seat Height 17.5
Inside Seat Depth 17
Inside Seat Width 29.5

COM	COL	1	2	3	4	5	6	7	8	9	10	11/L1	12	13/L2
5173	5463	5506	5670	5834	5998	6162	6326	6490	6654	6818	6982	7146	7310	7638

Upholstery Requirements
Fabric yds: 9 Leather Sq. Ft.: 162
Carton Weight: 143

2 Select Finish

[Click to view finishes](#)

NA

3 Combination Fabrics

[Click to view finishes](#)

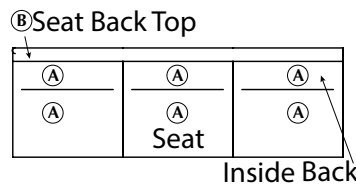
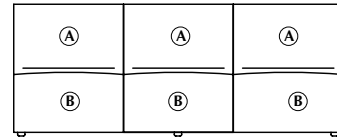
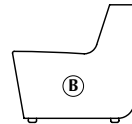

Node Power Placement Option

Table Power



Seat Power

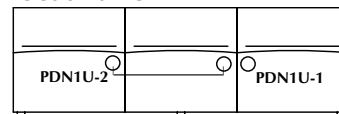

DARRAN is pleased to offer customers the design freedom of combination fabrics. When using fabric, vinyl or leather combinations, pricing/yardage requirements will be as follows:

A Inside Back & Seat 3.5 yds
B Lounge Exterior 6.5 yds

- When combining two materials of the same grade, pricing will be specified grade + 5%
- If combining two materials of different grades or leather/fabric combination, use the highest grade/price + 5%
- If using COM or COL, pricing will be COM or COL + 5%.
- If both COM + COL are used in combination, use COL + 5%.

Product Features

- Horizontal back provides easy ganging capabilities.
- Utilizes elastic webbing suspension that conforms to individual's lumbar curvatures for adaptive support.
- All units are standard with 1" adjustable glides that allow for leveling

Options

Ganging Device

- GDEV-L: Left Facing Ganging Device - \$20
- GDEV-R: Right Facing Ganging Device - \$20
- GDEV-C: Center Ganging Device - \$40

Power

- PDN1U-1: Node in Right Facing Seat Front; 1 Power/1 USB Charger - \$355
- PDN1U-2: Node in Left and Center Seat, Right Facing Seat Fronts; 1 power/1 USB per pod - \$709
- PDN1R-R: Node in Right Facing Rear Mount Table Top; 1 Power/1 USB Charger - \$409
- PDN2R-L- 2 Node in Left Facing Rear Mount Table Top; 1 Power/1 USB Charger - \$375
- Standard in White (Available in Silver and Black)

1/2" Compact Matte Laminate Rear Table

- Matte Laminate RTD88: Rear Work Table - \$1,096, Specify LAW Alaska or LNB Nero Finish
- Rear table available on units that gang providing stability
- Rear table is mounted at 35.5"

1/2" Compact Matte Laminate Tablet

- FFTD: 1/2" Compact Matte Laminate Tablet - \$622, Specify LAW Alaska or LNB Nero Finish
- Tablet mounts left or right of center cushion

Premium Finish Option (Standard White)

- Specify rear table bracket Metal Finish color - \$100 per unit
- Specify tablet Metal Finish color - \$100 per unit
- MFS: Silver, MFB: Black

Bota

Triple Seat With Privacy Screen
High Back - 10.5" Privacy Screen

[Click here to view statement of line](#)

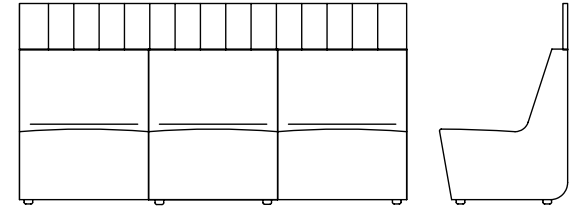

1 Model BOT0160THC13

w" x d" x h"
88.5 x 29.25 x 46
Arm Height -
Seat Height 17.5
Inside Seat Depth 17
Inside Seat Width 29.5

COM	COL	1	2	3	4	5	6	7	8	9	10	11/L1	12	13/L2
6497	6852	6923	7133	7343	7553	7763	7973	8183	8393	8603	8813	9023	9233	9653

Upholstery Requirements
Fabric yds: 11.5 Leather Sq. Ft.: 207
Carton Weight: 173

2 Select Finish

[Click to view finishes](#)

NA

3 Combination Fabrics

[Click to view finishes](#)

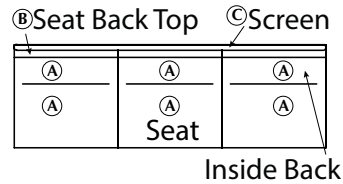
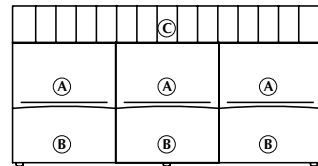
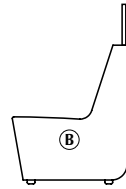

DARRAN is pleased to offer customers the design freedom of combination fabrics. When using fabric, vinyl or leather combinations, pricing/yardage requirements will be as follows:

A Inside Back & Seat 3.5 yds
B Lounge Exterior 6.5 yds
C Privacy Screen 2.5 yds

- When combining two materials of the same grade, pricing will be specified grade + 5%
- If combining two materials of different grades or leather/fabric combination, use the highest grade/price + 5%
- If using COM or COL, pricing will be COM or COL + 5%.
- If both COM + COL are used in combination, use COL + 5%.

Node Power Placement Option

Table Power



Seat Power

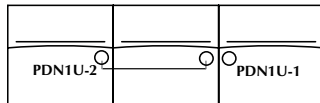

Product Features

- Horizontal back provides easy ganging capabilities.
- Utilizes elastic webbing suspension that conforms to individual's lumbar curvatures for adaptive support.
- Upholstered Privacy Screen
- Upholstered screens can be specified in contrasting fabrics, vinyl, or leathers.
- All units are standard with 1" adjustable glides that allow for leveling

Options

Ganging Device

- GDEV-L: Left Facing Ganging Device - \$20
- GDEV-R: Right Facing Ganging Device - \$20
- GDEV-C: Center Ganging Device - \$40

Power

- PDN1U-1: Node in Right Facing Seat Front; 1 Power/1 USB Charger - \$355
- PDN1U-2: Node in Left and Center Seat, Right Facing Seat Fronts; 1 power/1 USB per pod - \$709
- PDN1R-R: Node in Right Facing Rear Mount Table Top; 1 Power/1 USB Charger - \$409
- PDN2R-L- 2 Node in Left Facing Rear Mount Table Top; 1 Power/1 USB Charger - \$375

- Standard in White (Available in Silver and Black)

1/2" Compact Matte Laminate Rear Table

- Matte Laminate RTD88: Rear Work Table - \$1,096, Specify LAW Alaska or LNB Nero Finish
- Rear table available on units that gang providing stability
- Rear table is mounted at 35.5"

1/2" Compact Matte Laminate Tablet

- FFD: 1/2" Compact Matte Laminate Tablet - \$622, Specify LAW Alaska or LNB Nero Finish
- Tablet mounts left or right of center cushion

Premium Finish Option (Standard White)

- Specify rear table bracket Metal Finish color - \$100 per unit
- Specify tablet Metal Finish color - \$100 per unit
- MFS: Silver, MFB: Black

Bota

Triple Seat With Privacy Screen
High Back - 17.5" Privacy Screen

[Click here to view statement of line](#)

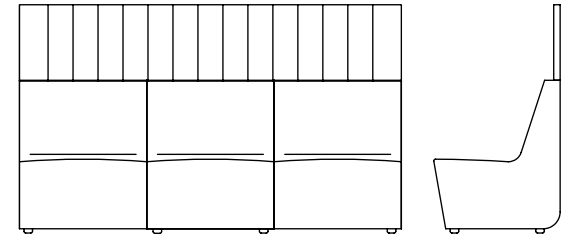

1 Model BOT0160THC23

w" x d" x h"
88.5 x 29.25 x 53
Arm Height -
Seat Height 17.5
Inside Seat Depth 17
Inside Seat Width 29.5

COM	COL	1	2	3	4	5	6	7	8	9	10	11/L1	12	13/L2
7056	7455	7574	7829	8084	8339	8594	8849	9104	9359	9614	9869	10124	10379	10889

Upholstery Requirements
Fabric yds: 14 Leather Sq. Ft.: 252
Carton Weight: 203

2 Select Finish

[Click to view finishes](#)

NA

3 Combination Fabrics

[Click to view finishes](#)

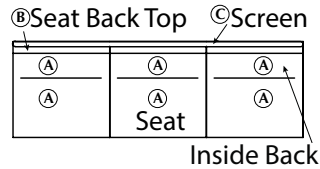
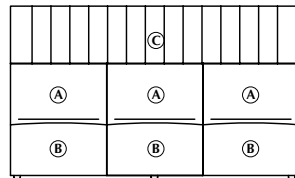
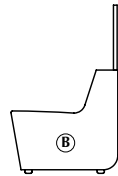

DARRAN is pleased to offer customers the design freedom of combination fabrics. When using fabric, vinyl or leather combinations, pricing/yardage requirements will be as follows:

- A Inside Back & Seat 3.5 yds
- B Lounge Exterior 6.5 yds
- C Privacy Screen 5 yds

- When combining two materials of the same grade, pricing will be specified grade + 5%
- If combining two materials of different grades or leather/fabric combination, use the highest grade/price + 5%
- If using COM or COL, pricing will be COM or COL + 5%.
- If both COM + COL are used in combination, use COL + 5%.

Node Power Placement Option

Table Power



Seat Power

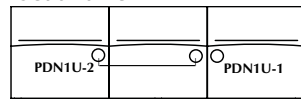

Product Features

- Horizontal back provides easy ganging capabilities.
- Utilizes elastic webbing suspension that conforms to individual's lumbar curvatures for adaptive support.
- Upholstered Privacy Screen
- Upholstered screens can be specified in contrasting fabrics, vinyl, or leathers.
- All units are standard with 1" adjustable glides that allow for leveling

Options

Ganging Device

- GDEV-L: Left Facing Ganging Device - \$20
- GDEV-R: Right Facing Ganging Device - \$20
- GDEV-C: Center Ganging Device - \$40

Power

- PDN1U-1: Node in Right Facing Seat Front; 1 Power/1 USB Charger - \$355
- PDN1U-2: Node in Left and Center Seat, Right Facing Seat Fronts; 1 power/1 USB per pod - \$709
- PDN1R-R: Node in Right Facing Rear Mount Table Top; 1 Power/1 USB Charger - \$409
- PDN2R-L- 2 Node in Left Facing Rear Mount Table Top; 1 Power/1 USB Charger - \$375
- Standard in White (Available in Silver and Black)

1/2" Compact Matte Laminate Rear Table

- Matte Laminate RTD88: Rear Work Table - \$1,096, Specify LAW Alaska or LNB Nero Finish
- Rear table available on units that gang providing stability
- Rear table is mounted at 35.5"

1/2" Compact Matte Laminate Tablet

- FFD: 1/2" Compact Matte Laminate Tablet - \$622, Specify LAW Alaska or LNB Nero Finish
- Tablet mounts left or right of center cushion
- Premium Finish Option (Standard White)**
- Specify rear table bracket Metal Finish color - \$100 per unit
- Specify tablet Metal Finish color - \$100 per unit
- MFS: Silver, MFB: Black

Bota

Shell - Single Seat
 Low Back - Side Screens & Privacy Screen

[Click here to view statement of line](#)

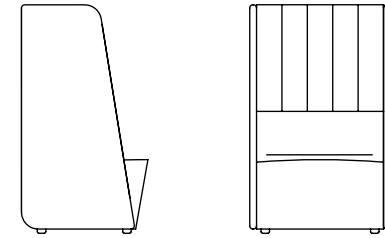

1 Model BOT0160SLN01

w" x d" x h"
 32.75 x 29.25 x 53
 Arm Height -
 Seat Height 17.5
 Inside Seat Depth 17
 Inside Seat Width 29.5

COM	COL	1	2	3	4	5	6	7	8	9	10	11/L1	12	13/L2
4692	4834	4914	5023	5132	5241	5350	5459	5568	5677	5786	5895	6004	6113	6331

Upholstery Requirements
 Fabric yds: 6 Leather Sq. Ft.: 108
 Carton Weight: 110

2 Select Finish

[Click to view finishes](#)

NA

3 Combination Fabrics

[Click to view finishes](#)

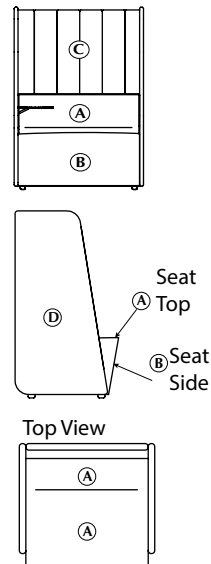

DARRAN is pleased to offer customers the design freedom of combination fabrics. When using fabric, vinyl or leather combinations, pricing/yardage requirements will be as follows:

- A Inside Back & Seat 1.5 yds
- B Lounge Exterior 3 yds
- C Privacy Screen Interior 1 yds
- D Side Screens, Lounge Exterior, Privacy Screens 5 yds

- When combining two materials of the same grade, pricing will be specified grade + 5%
- If combining two materials of different grades or leather/fabric combination, use the highest grade/price + 5%
- If using COM or COL, pricing will be COM or COL + 5%.
- If both COM + COL are used in combination, use COL + 5%.

Node Power Placement Option

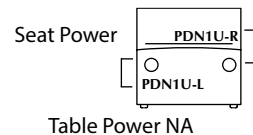

Product Features

- Screens are constructed from tubular metal that is welded to maximize the strength, precise measurements and overall longevity.
- Horizontal back provides easy ganging capabilities.
- Utilizes elastic webbing suspension that conforms to individual's lumbar curvatures for adaptive support.
- Upholstered screens can be specified in contrasting fabrics, vinyl, or leathers.
- All units are standard with 1" adjustable glides that allow for leveling

Notes

- Please consult customer service when specifying a table other than Bota to ensure adequacy of seat access
- When delete side screen option is specified, ganging brackets are installed on the lounge side. If the unit will be open specify the delete screen non-ganging option. Non-ganging option will not have side mounted ganging brackets

Options

Delete Side Screen

Delete Left Screen

- DLSG: Delete Left Side Screen for Ganging - Deduct \$500 (Ganging Hardware Installed)
- DLSN: Delete Left Side Screen for Non-Ganging - Deduct \$475 (Ganging Hardware Not Installed)

Delete Right Screen

- DRSG: Delete Right Side Screen for Ganging - Deduct \$500 (Ganging Hardware Installed)
- DRSN: Delete Right Side Screen for Non-Ganging - Deduct \$475 (Ganging Hardware Not Installed)

Power

- PDNIU-L: Node in Left Facing Seat Front; 1 Power/1 USB Charger - \$355
- PDNIU-R: Node in Right Facing Seat Front; 1 Power/1 USB Charger - \$355
- PDNIU-B: Node in Both Left and Right Facing Seat Front; 1 Power/1 USB Charger per pod - \$709
- Standard in White (Available in Silver and Black)

Bota

Shell - Single Seat
High Back - Side Screens & Privacy Screen

[Click here to view statement of line](#)

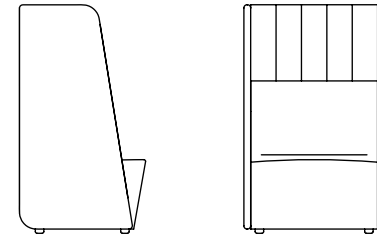

1 Model BOT0160SHN01

w" x d" x h"
32.75 x 29.25 x 53
Arm Height -
Seat Height 17.5
Inside Seat Depth 17
Inside Seat Width 29.5

COM	COL	1	2	3	4	5	6	7	8	9	10	11/L1	12	13/L2
4720	4967	4979	5107	5235	5363	5491	5619	5747	5875	6003	6131	6259	6387	6643

Upholstery Requirements
Fabric yds: 7 Leather Sq. Ft.: 126
Carton Weight: 115

2 Select Finish

[Click to view finishes](#)

NA

3 Combination Fabrics

[Click to view finishes](#)

DARRAN is pleased to offer customers the design freedom of combination fabrics. When using fabric, vinyl or leather combinations, pricing/yardage requirements will be as follows:

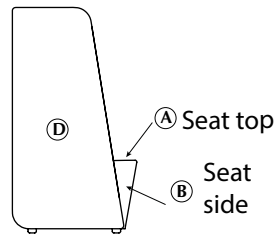
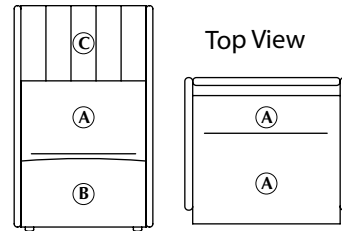

- A Inside Back & Seat 1.5 yds
- B Lounge Exterior 3 yds
- C Privacy Screen 0.75 yds
- D Side Screens, Lounge Exterior, Privacy Screens 5 yds

- When combining two materials of the same grade, pricing will be specified grade + 5%
- If combining two materials of different grades or leather/fabric combination, use the highest grade/price + 5%
- If using COM or COL, pricing will be COM or COL + 5%.
- If both COM + COL are used in combination, use COL + 5%.

Node Power Placement Option

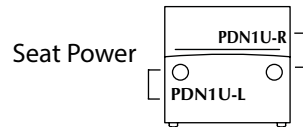

Table Power NA

Product Features

- Screens are constructed from tubular metal that is welded to maximize the strength, precise measurements and overall longevity.
- Horizontal back provides easy ganging capabilities.
- Utilizes elastic webbing suspension that conforms to individual's lumbar curvatures for adaptive support.
- Upholstered screens can be specified in contrasting fabrics, vinyl, or leathers.
- All units are standard with 1" adjustable glides that allow for leveling

Notes

- Please consult customer service when specifying a table other than Bota to ensure adequacy of seat access
- When delete side screen option is specified, ganging brackets are installed on the lounge side. If the unit will be open specify the delete screen non-ganging option. Non-ganging option will not have side mounted ganging brackets

Options

Delete Side Screen

Delete Left Screen

- DLSG: Delete Left Side Screen for Ganging - Deduct \$500 (Ganging Hardware Installed)
- DLSN: Delete Left Side Screen for Non-Ganging - Deduct \$475 (Ganging Hardware Not Installed)

Delete Right Screen

- DRSG: Delete Right Side Screen for Ganging - Deduct \$500 (Ganging Hardware Installed)
- DRSN: Delete Right Side Screen for Non-Ganging - Deduct \$475 (Ganging Hardware Not Installed)

Power

- PDN1U-L: Node in Left Facing Seat Front; 1 Power/1 USB Charger - \$355
- PDN1U-R: Node in Right Facing Seat Front; 1 Power/1 USB Charger - \$355
- PDN1U-B: Node in Both Left and Right Facing Seat Front; 1 Power/1 USB Charger per pod - \$709
- Standard in White (Available in Silver and Black)

Bota

Shell - Single Seat

Low Back - Side Screens, Privacy Screen & Roof

[Click here to view statement of line](#)

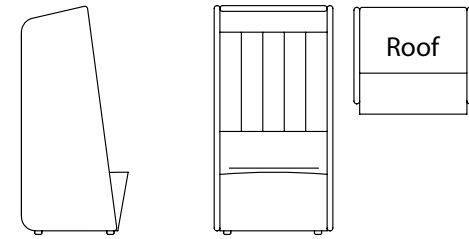

1 Model BOT0160SLR01

w" x d" x h"
32.75 x 29.25 x 63
Arm Height -
Seat Height 17.5
Inside Seat Depth 17
Inside Seat Width 29.5

COM	COL	1	2	3	4	5	6	7	8	9	10	11/L1	12	13/L2
5758	5800	6017	6145	6273	6401	6529	6657	6785	6913	7041	7169	7297	7425	7681

Upholstery Requirements
Fabric yds: 7 Leather Sq. Ft.: 126
Carton Weight: 131

2 Select Finish

[Click to view finishes](#)

NA

3 Combination Fabrics

[Click to view finishes](#)

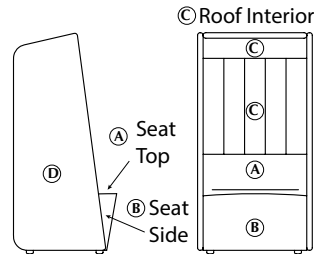

© Roof Interior

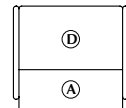

Ⓓ Roof Top View

Node Power Placement Option

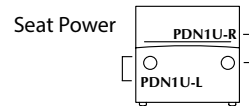

Table Power NA

DARRAN is pleased to offer customers the design freedom of combination fabrics. When using fabric, vinyl or leather combinations, pricing/yardage requirements will be as follows:

- A Inside Back & Seat 1.5 yds
- B Lounge Exterior 3 yds
- C Privacy Screen & Roof Interior 2 yds
- D Side Screens, Lounge Exterior, Roof Exterior 6 yds

- When combining two materials of the same grade, pricing will be specified grade + 5%
- If combining two materials of different grades or leather/fabric combination, use the highest grade/price + 5%
- If using COM or COL, pricing will be COM or COL + 5%.
- If both COM + COL are used in combination, use COL + 5%.

Product Features

- Screens are constructed from tubular metal that is welded to maximize the strength, precise measurements and overall longevity.
- Horizontal back provides easy ganging capabilities.
- Utilizes elastic webbing suspension that conforms to individual's lumbar curvatures for adaptive support.
- Upholstered screens & roof can be specified in contrasting fabrics, vinyl, or leathers.
- All units are standard with 1" adjustable glides that allow for leveling

Notes

- Please consult customer service when specifying a table other than Bota to ensure adequacy of seat access

Options

Power

- PDN1U-L: Node in Left Facing Seat Front; 1 Power/1 USB Charger - \$325
- PDN1U-R: Node in Right Facing Seat Front; 1 Power/1 USB Charger - \$355
- PDN1U-B: Node in Both Left and Right Facing Seat Front; 1 Power/1 USB Charger per pod - \$709
- Standard in White (Available in Silver and Black)

Bota

Work Shell
Single - Seat

[Click here to view statement of line](#)

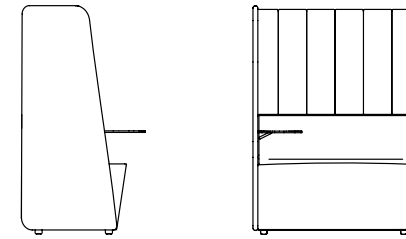

1 Model BOT0160SLW01

w" x d" x h"
38.75 x 29.25 x 53
Arm Height -
Seat Height 17.5
Inside Seat Depth 17
Inside Seat Width 35

COM	COL	1	2	3	4	5	6	7	8	9	10	11/L1	12	13/L2
6418	6670	6677	6805	6933	7061	7189	7317	7445	7573	7701	7829	7957	8085	8341

Upholstery Requirements
Fabric yds: 7 Leather Sq. Ft.: 126
Carton Weight: 130

2 Select Finish

[Click to view finishes](#)

WLO
WEC
WAM
WCM
WGW
WBW
WSW
WNW
WWP

NA

3 Combination Fabrics

[Click to view finishes](#)

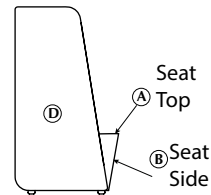
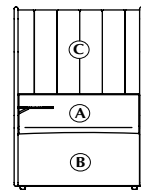

Top View

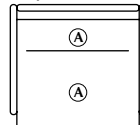

Node Power Placement Option

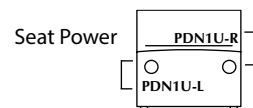

Table Power NA

DARRAN is pleased to offer customers the design freedom of combination fabrics. When using fabric, vinyl or leather combinations, pricing/yardage requirements will be as follows:

- A Inside Back & Seat 3.5 yds
- B Lounge Exterior 5 yds
- C Privacy Screen Interior 3 yds
- D Side Screens, Lounge Exterior, Privacy Screens 5 yds

- When combining two materials of the same grade, pricing will be specified grade + 5%
- If combining two materials of different grades or leather/fabric combination, use the highest grade/price + 5%
- If using COM or COL, pricing will be COM or COL + 5%.
- If both COM + COL are used in combination, use COL + 5%.

Product Features

- Screens are constructed from tubular metal that is welded to maximize the strength, precise measurements and overall longevity.
- Horizontal back provides easy ganging capabilities.
- Utilizes elastic webbing suspension that conforms to individual's lumbar curvatures for adaptive support.
- Upholstered screens can be specified in contrasting fabrics, vinyl, or leathers.
- All units are standard with 1" adjustable glides that allow for leveling
- Work side table on left facing side
- Specify side table finish color
- Height of work side table is 26"
- Size of work side table 14.75W x 16D

Notes

- Please consult customer service when specifying a table other than Bota to ensure adequacy of seat access
- When delete side screen option is specified, ganging brackets are installed on the lounge side. If the unit will be open specify the delete screen non-ganging option. Non-ganging option will not have side mounted ganging brackets

Options

Delete Side Screen

Delete Right Screen

- DRSG: Delete Right Side Screen for Ganging - Deduct \$500 (Ganging Hardware Installed)
- DRSN: Delete Right Side Screen for Non-Ganging - Deduct \$475 (Ganging Hardware Not Installed)

Power

- PDNIU-L: Node in Left Facing Seat Front; 1 Power/1 USB Charger - \$355
- PDNIU-R: Node in Right Facing Seat Front; 1 Power/1 USB Charger - \$355
- PDNIU-B: Node in Both Left and Right Facing Seat Front; 1 Power/1 USB Charger per pod - \$709
- Standard in White (Available in Silver and Black)

Bota

Shell - Single Seat
Low Back - Swivel Base

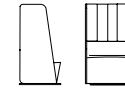

[Click here to view statement of line](#)

1 Model BOT0160SLS01

w" x d" x h"
33.75 x 29.25 x 53
Arm Height -
Seat Height 17.5
Inside Seat Depth 17
Inside Seat Width 29.5

COM	COL	1	2	3	4	5	6	7	8	9	10	11/L1	12	13/L2
6321	6308	6543	6652	6761	6870	6979	7088	7197	7306	7415	7524	7633	7742	7960

Upholstery Requirements
Fabric yds: 6 Leather Sq. Ft.: 108
Carton Weight: 160

2 Select Finish

[Click to view finishes](#)

N/A

NA

3 Combination Fabrics

[Click to view finishes](#)

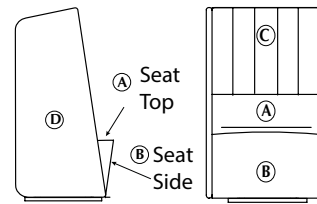

DARRAN is pleased to offer customers the design freedom of combination fabrics. When using fabric, vinyl or leather combinations, pricing/yardage requirements will be as follows:

- A Inside Back & Seat 1.5 yds
- B Lounge Exterior 3 yds
- C Privacy Screen Interior 1 yds
- D Side Screens, Lounge Exterior, Privacy Screens 5 yds

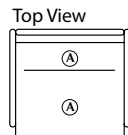

Node Power Placement Option

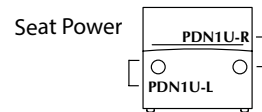

Table Power NA

- When combining two materials of the same grade, pricing will be specified grade + 5%
- If combining two materials of different grades or leather/fabric combination, use the highest grade/price + 5%
- If using COM or COL, pricing will be COM or COL + 5%.
- If both COM + COL are used in combination, use COL + 5%.

Product Features

- Screens are constructed from tubular metal that is welded to maximize the strength, precise measurements and overall longevity.
- Horizontal back provides easy ganging capabilities.
- Utilizes elastic webbing suspension that conforms to individual's lumbar curvatures for adaptive support.
- Upholstered screens can be specified in contrasting fabrics, vinyl, or leathers.
- Swivel base

Notes

- Please consult customer service when specifying a table other than Bota to ensure adequacy of seat access

Power

- PDN1U-L: Node in Left Facing Seat Front; 1 Power/1 USB Charger - \$355
- PDN1U-R: Node in Right Facing Seat Front; 1 Power/1 USB Charger - \$355
- PDN1U-B: Node in Both Left and Right Facing Seat Front; 1 Power/1 USB Charger per pod - \$709
- Standard in White (Available in Silver and Black)

Bota

Shell - Single Seat
High Back - Swivel Base

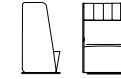

[Click here to view statement of line](#)

1 Model BOT0160SHS01

w" x d" x h"
33.75 x 29.25 x 53
Arm Height -
Seat Height 17.5
Inside Seat Depth 17
Inside Seat Width 29.5

COM	COL	1	2	3	4	5	6	7	8	9	10	11/L1	12	13/L2
6348	6595	6607	6735	6863	6991	7119	7247	7375	7503	7631	7759	7887	8015	8271

Upholstery Requirements
Fabric yds: 7 Leather Sq. Ft.: 126
Carton Weight: 165

2 Select Finish

[Click to view finishes](#)

N/A

NA

3 Combination Fabrics

[Click to view finishes](#)

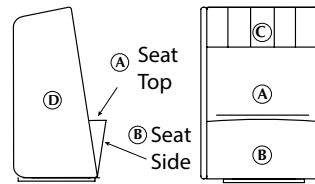

Top View

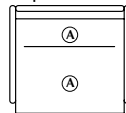

Node Power Placement Option

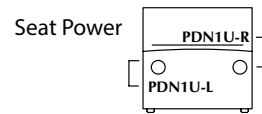

Table Power NA

DARRAN is pleased to offer customers the design freedom of combination fabrics. When using fabric, vinyl or leather combinations, pricing/yardage requirements will be as follows:

- A Inside Back & Seat 1.5 yds
- B Lounge Exterior 3 yds
- C Privacy Screen Interior 1 yds
- D Side Screens, Lounge Exterior, Privacy Screens 5 yds

- When combining two materials of the same grade, pricing will be specified grade + 5%
- If combining two materials of different grades or leather/fabric combination, use the highest grade/price + 5%
- If using COM or COL, pricing will be COM or COL + 5%.
- If both COM + COL are used in combination, use COL + 5%.

Product Features

- Screens are constructed from tubular metal that is welded to maximize the strength, precise measurements and overall longevity.
- Horizontal back provides easy ganging capabilities.
- Utilizes elastic webbing suspension that conforms to individual's lumbar curvatures for adaptive support.
- Upholstered screens can be specified in contrasting fabrics, vinyl, or leathers.
- Swivel base

Notes

- Please consult customer service when specifying a table other than Bota to ensure adequacy of seat access

Power

- PDNIU-L: Node in Left Facing Seat Front; 1 Power/1 USB Charger - \$355
- PDNIU-R: Node in Right Facing Seat Front; 1 Power/1 USB Charger - \$355
- PDNIU-B: Node in Both Left and Right Facing Seat Front; 1 Power/1 USB Charger per pod - \$709
- Standard in White (Available in Silver and Black)

Bota

Shell - Double Seat
 Low Back - Side Screens & Privacy Screen

[Click here to view statement of line](#)

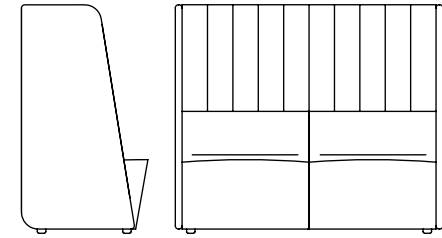

1 Model BOT0160DLN02

w" x d" x h"
 62 x 29.25 x 53
 Arm Height -
 Seat Height 17.5
 Inside Seat Depth 17
 Inside Seat Width 29.5

COM	COL	1	2	3	4	5	6	7	8	9	10	11/L1	12	13/L2
6352	6721	6796	7015	7234	7453	7672	7891	8110	8329	8548	8767	8986	9205	9643

Upholstery Requirements
 Fabric yds: 12 Leather Sq. Ft.: 216
 Carton Weight: 170

2 Select Finish

[Click to view finishes](#)

NA

3 Combination Fabrics

[Click to view finishes](#)

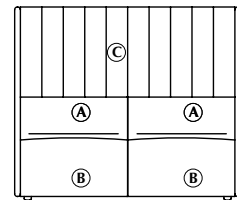
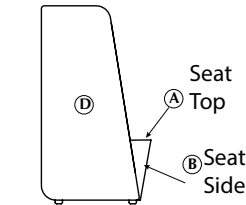

Seat Back Top

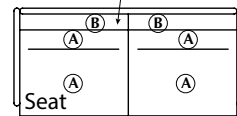

Node Power Placement Option

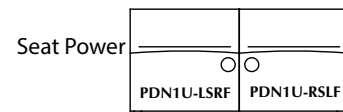

Table Power NA

DARRAN is pleased to offer customers the design freedom of combination fabrics. When using fabric, vinyl or leather combinations, pricing/yardage requirements will be as follows:

- A Inside Back & Seat 2 yds
- B Lounge Exterior 4 yds
- C Privacy Screen 2 yds
- D Side Screens, Lounge Exterior, Privacy Screens 6 yds

- When combining two materials of the same grade, pricing will be specified grade + 5%
- If combining two materials of different grades or leather/fabric combination, use the highest grade/price + 5%
- If using COM or COL, pricing will be COM or COL + 5%.
- If both COM + COL are used in combination, use COL + 5%.

Product Features

- Screens are constructed from tubular metal that is welded to maximize the strength, precise measurements and overall longevity.
- Horizontal back provides easy ganging capabilities.
- Utilizes elastic webbing suspension that conforms to individual's lumbar curvatures for adaptive support.
- Upholstered screens can be specified in contrasting fabrics, vinyl, or leathers.
- All units are standard with 1" adjustable glides that allow for leveling

Notes

- Please consult customer service when specifying a table other than Bota to ensure adequacy of seat access
- When delete side screen option is specified, ganging brackets are installed on the lounge side. If the unit will be open specify the delete screen non-ganging option. Non-ganging option will not have side mounted ganging brackets

Options

Delete Side Screen

Delete Left Screen

- DLSG: Delete Left Side Screen for Ganging - Deduct \$500 (Ganging Hardware Installed)
- DLSN: Delete Left Side Screen for Non-Ganging - Deduct \$475 (Ganging Hardware Not Installed)

Delete Right Screen

- DRSG: Delete Right Side Screen for Ganging - Deduct \$500 (Ganging Hardware Installed)
- DRSN: Delete Right Side Screen for Non-Ganging - Deduct \$475 (Ganging Hardware Not Installed)

Power

- PDN1U-LSRF: Node in Left Seat Right Facing Seat Front; 1 Power/1 USB Charger - \$355
- PDN1U-RSLF: Node in Right Seat Left Facing Seat Front; 1 Power/1 USB Charger - \$355
- PDN1U-BC: Node in Both Left and Right Facing Center Seat Front; 1 Power/1 USB Charger per pod - \$709
- Standard in White (Available in Silver and Black)

1/2" Compact Matte Laminate Tablet

- FFTD: 1/2" Compact Matte Laminate Tablet - \$622, Specify LAW Alaska or LNB Nero Finish
- Tablet is center mount only

Premium Finish Option (Standard White)

- Specify rear table bracket Metal Finish color - \$100 per unit
- Specify tablet Metal Finish color - \$100 per unit
- MFS: Silver, MFB: Black

Bota

Shell - Double Seat
High Back - Side Screens & Privacy Screen

[Click here to view statement of line](#)

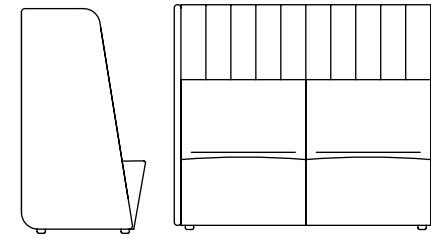

1 Model BOT0160DHN02

w" x d" x h"
62 x 29.25 x 53
Arm Height -
Seat Height 17.5
Inside Seat Depth 17
Inside Seat Width 29.5

COM	COL	1	2	3	4	5	6	7	8	9	10	11/L1	12	13/L2
6377	6732	6858	7095	7332	7569	7806	8043	8280	8517	8754	8991	9228	9465	9939

Upholstery Requirements
Fabric yds: 13 Leather Sq. Ft.: 234
Carton Weight: 175

2 Select Finish

[Click to view finishes](#)

NA

3 Combination Fabrics

[Click to view finishes](#)

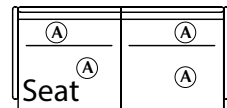
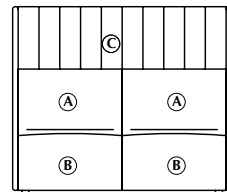
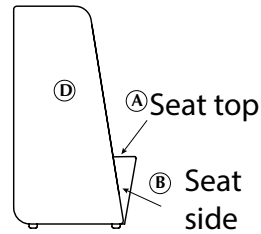

DARRAN is pleased to offer customers the design freedom of combination fabrics. When using fabric, vinyl or leather combinations, pricing/yardage requirements will be as follows:

- A Inside Back & Seat 2 yds
- B Lounge Exterior 5 yds
- C Privacy Screen 2 yds
- D Side Screens, Lounge Exterior, Privacy Screens 6 yds

- When combining two materials of the same grade, pricing will be specified grade + 5%
- If combining two materials of different grades or leather/fabric combination, use the highest grade/price + 5%
- If using COM or COL, pricing will be COM or COL + 5%.
- If both COM + COL are used in combination, use COL + 5%.

Node Power Placement Option

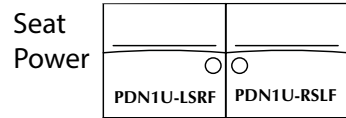

Table Power NA

Product Features

- Screens are constructed from tubular metal that is welded to maximize the strength, precise measurements and overall longevity.
- Horizontal back provides easy ganging capabilities.
- Utilizes elastic webbing suspension that conforms to individual's lumbar curvatures for adaptive support.
- Upholstered screens can be specified in contrasting fabrics, vinyl, or leathers.
- All units are standard with 1" adjustable glides that allow for leveling

Notes

- Please consult customer service when specifying a table other than Bota to ensure adequacy of seat access
- When delete side screen option is specified, ganging brackets are installed on the lounge side. If the unit will be open specify the delete screen non-ganging option. Non-ganging option will not have side mounted ganging brackets

Options

Delete Side Screen

Delete Left Screen

- DLSG: Delete Left Side Screen for Ganging - Deduct \$500 (Ganging Hardware Installed)
- DLSN: Delete Left Side Screen for Non-Ganging - Deduct \$475 (Ganging Hardware Not Installed)

Delete Right Screen

- DRSG: Delete Right Side Screen for Ganging - Deduct \$500 (Ganging Hardware Installed)
- DRSN: Delete Right Side Screen for Non-Ganging - Deduct \$475 (Ganging Hardware Not Installed)

Power

- PDN1U-LSRF: Node in Left Seat Right Facing Seat Front; 1 Power/1 USB Charger - \$355
- PDN1U-RSLF: Node in Right Seat Left Facing Seat Front; 1 Power/1 USB Charger - \$355
- PDN1U-BC: Node in Both Left and Right Facing Center Seat Front; 1 Power/1 USB Charger per pod - \$709
- Standard in White (Available in Silver and Black)

1/2" Compact Matte Laminate Tablet

- FFTD: 1/2" Compact Matte Laminate Tablet - \$622, Specify LAW Alaska or LNB Nero Finish
- Tablet is center mount only

Premium Finish Option (Standard White)

- Specify rear table bracket Metal Finish color - \$100 per unit
- Specify tablet Metal Finish color - \$100 per unit
- MFS: Silver, MFB: Black

Bota

Shell - Double Seat

Low Back - Side Screens, Privacy Screen & Roof

[Click here to view statement of line](#)

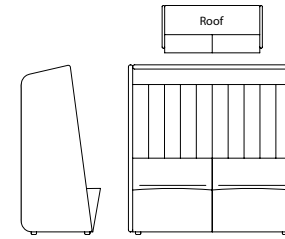

1 Model BOT0160DLR02

w" x d" x h"
62 x 29.25 x 63
Arm Height -
Seat Height 17.5
Inside Seat Depth 17
Inside Seat Width 29.5

COM	COL	1	2	3	4	5	6	7	8	9	10	11/L1	12	13/L2
7855	8288	8447	8739	9031	9323	9615	9907	10199	10491	10783	11075	11367	11659	12243

Upholstery Requirements
Fabric yds: 16 Leather Sq. Ft.: 288
Carton Weight: 185

2 Select Finish

[Click to view finishes](#)

NA

3 Combination Fabrics

[Click to view finishes](#)

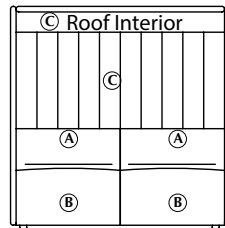
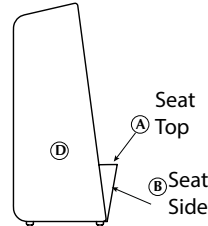
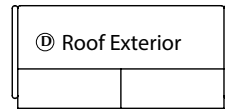

DARRAN is pleased to offer customers the design freedom of combination fabrics. When using fabric, vinyl or leather combinations, pricing/yardage requirements will be as follows:

- A Inside Back & Seat 2 yds
- B Lounge Exterior 4 yds
- C Privacy Screen & Roof Interior 4 yds
- D Side Screens, Lounge Exterior, Roof Exterior 8 yds

- When combining two materials of the same grade, pricing will be specified grade + 5%
- If combining two materials of different grades or leather/fabric combination, use the highest grade/price + 5%
- If using COM or COL, pricing will be COM or COL + 5%.
- If both COM + COL are used in combination, use COL + 5%.

Node Power Placement Option

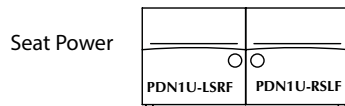

Table Power NA

Product Features

- Screens are constructed from tubular metal that is welded to maximize the strength, precise measurements and overall longevity.
- Horizontal back provides easy ganging capabilities.
- Utilizes elastic webbing suspension that conforms to individual's lumbar curvatures for adaptive support.
- Upholstered screens & roof can be specified in contrasting fabrics, vinyl, or leathers.
- All units are standard with 1" adjustable glides that allow for leveling

Notes

- Please consult customer service when specifying a table other than Bota to ensure adequacy of seat access

Options

Power

- PDN1U-LSRF: Node in Left Seat Right Facing Seat Front; 1 Power/1 USB Charger - \$355
- PDN1U-RSLF: Node in Right Seat Left Facing Seat Front; 1 Power/1 USB Charger - \$355
- PDN1U-BC: Node in Both Left and Right Facing Center Seat Front; 1 Power/1 USB Charger per pod - \$709
- Standard in White (Available in Silver and Black)

1/2" Compact Matte Laminate Tablet

- FFTD: 1/2" Compact Matte Laminate Tablet - \$622, Specify LAW Alaska or LNB Nero Finish
- Tablet is center mount only

Premium Finish Option (Standard White)

- Specify rear table bracket Metal Finish color - \$100 per unit
- Specify tablet Metal Finish color - \$100 per unit
- MFS: Silver, MFB: Black

Bota

90 Deg. Circlet - Single Seat Low Back
 90 Degree Back Inside Radius - Low Back

[Click here to view statement of line](#)

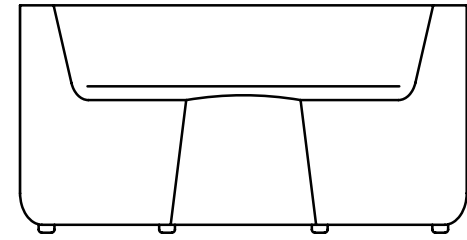

1 Model BOT0160LCS90

w" x d" x h"
 55.75 x 28.5 x 28.25
 Arm Height -
 Seat Height 17.5
 Inside Seat Depth 17
 Inside Seat Width 29.5

COM	COL	1	2	3	4	5	6	7	8	9	10	11/L1	12	13/L2
3066	3234	3288	3397	3506	3615	3724	3833	3942	4051	4160	4269	4378	4487	4705

Upholstery Requirements
 Fabric yds: 6 Leather Sq. Ft.: 108
 Carton Weight: 55

2 Select Finish

[Click to view finishes](#)

NA

3 Combination Fabrics

[Click to view finishes](#)

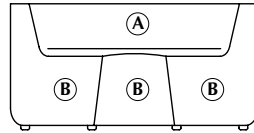

DARRAN is pleased to offer customers the design freedom of combination fabrics. When using fabric, vinyl or leather combinations, pricing/yardage requirements will be as follows:

A Inside Back & Seat 2 yds
 B Lounge Exterior 6 yds

Seat Back Top

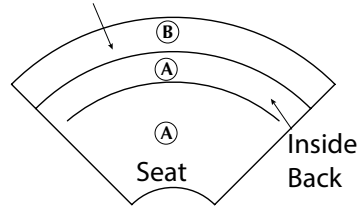

- When combining two materials of the same grade, pricing will be specified grade + 5%
- If combining two materials of different grades or leather/fabric combination, use the highest grade/price + 5%
- If using COM or COL, pricing will be COM or COL + 5%.
- If both COM + COL are used in combination, use COL + 5%.

Node Power Placement Option

Table Power

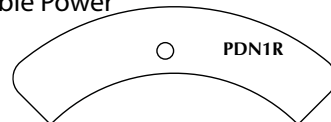

Seat Power N/A

Product Features

- Horizontal back provides easy ganging capabilities.
- Utilizes elastic webbing suspension that conforms to individual's lumbar curvatures for adaptive support.
- All units are standard with 1" adjustable glides that allow for leveling

Options

Ganging Device

- GDEV-L: Left Facing Ganging Device - \$20
- GDEV-R: Right Facing Ganging Device - \$20
- GDEV-C: Center Ganging Device - \$40

Power

- PDN1R- Node in Rear Mount Table Top; 1 Power/1 USB Charger - \$409
- Standard in White (Available in Silver and Black)

1/2" Compact Matte Laminate Rear Table

- Matte Laminate RTD55: Rear Work Table - \$1,423, Specify LAW Alaska or LNB Nero Finish
- Rear table available on units that gang providing stability
- Rear table is mounted at 28.5"

Premium Finish Option (Standard White)

- Specify rear table bracket Metal Finish color - \$100 per unit
- MFS: Silver, MFB: Black

Bota

90 Deg. Circlet - Single Seat Low Back With Privacy Screen
 90 Degree Back Inside Radius - Low Back - 10.5" Privacy Screen

[Click here to view statement of line](#)

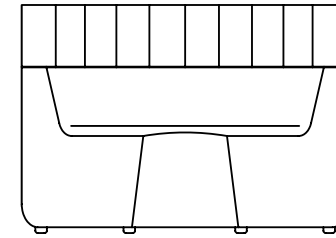

1 Model BOT0160LCL90

w" x d" x h"
 55.75 x 28.5 x 39
 Arm Height -
 Seat Height 17.5
 Inside Seat Depth 17
 Inside Seat Width 29.5

COM	COL	1	2	3	4	5	6	7	8	9	10	11/L1	12	13/L2
4103	4312	4399	4545	4691	4837	4983	5129	5275	5421	5567	5713	5859	6005	6297

Upholstery Requirements
 Fabric yds: 8 Leather Sq. Ft.: 144
 Carton Weight: 65

2 Select Finish

[Click to view finishes](#)

NA

3 Combination Fabrics

[Click to view finishes](#)

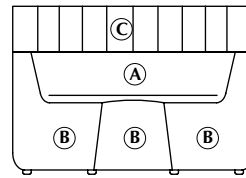

DARRAN is pleased to offer customers the design freedom of combination fabrics. When using fabric, vinyl or leather combinations, pricing/yardage requirements will be as follows:

- A Inside Back & Seat 2 yds
- B Lounge Exterior 6 yds
- C Privacy Screen 2.5 yds

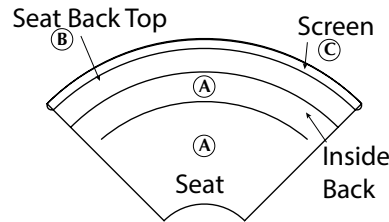

- When combining two materials of the same grade, pricing will be specified grade + 5%
- If combining two materials of different grades or leather/fabric combination, use the highest grade/price + 5%
- If using COM or COL, pricing will be COM or COL + 5%.
- If both COM + COL are used in combination, use COL + 5%.

Node Power Placement Option

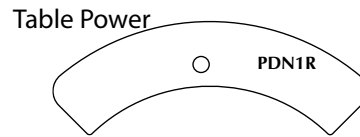

Seat Power N/A

Product Features

- Upholstered screens can be specified in contrasting fabrics, vinyl, or leathers.
- All units are standard with 1" adjustable glides that allow for leveling

Options

Ganging Device

- GDEV-L: Left Facing Ganging Device - \$20
- GDEV-R: Right Facing Ganging Device - \$20
- GDEV-C: Center Ganging Device - \$40

Power

- PDN1R- Node in Rear Mount Table Top; 1 Power/1 USB Charger - \$409
- Standard in White (Available in Silver and Black)

1/2" Compact Matte Laminate Rear Table

- Matte Laminate RTD55: Rear Work Table - \$1,423, Specify LAW Alaska or LNB Nero Finish
- Rear table available on units that gang providing stability
- Rear table is mounted at 28.5"

Premium Finish Option (Standard White)

- Specify rear table bracket Metal Finish color - \$100 per unit
- MFS: Silver, MFB: Black

Bota

90 Deg. Circlet - Single Seat Low Back With Privacy Screen
 90 Degree Back Inside Radius - Low Back - 24.75" Privacy Screen

[Click here to view statement of line](#)

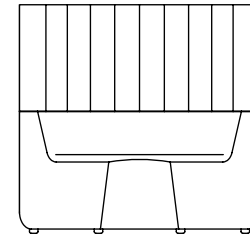

1 Model BOT0160LCH90

w" x d" x h"
 55.75 x 28.5 x 53.25
 Arm Height -
 Seat Height 17.5
 Inside Seat Depth 17
 Inside Seat Width 29.5

COM	COL	1	2	3	4	5	6	7	8	9	10	11/L1	12	13/L2
4732	4996	5102	5284	5466	5648	5830	6012	6194	6376	6558	6740	6922	7104	7468

Upholstery Requirements
 Fabric yds: 10 Leather Sq. Ft.: 180
 Carton Weight: 70

2 Select Finish

[Click to view finishes](#)

NA

3 Combination Fabrics

[Click to view finishes](#)

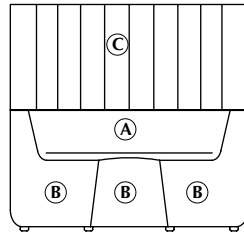

DARRAN is pleased to offer customers the design freedom of combination fabrics. When using fabric, vinyl or leather combinations, pricing/yardage requirements will be as follows:

A Inside Back & Seat 2 yds
 B Lounge Exterior 6 yds
 C Privacy Screen 5 yds

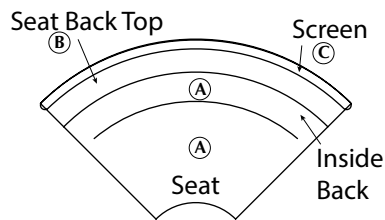

- When combining two materials of the same grade, pricing will be specified grade + 5%
- If combining two materials of different grades or leather/fabric combination, use the highest grade/price + 5%
- If using COM or COL, pricing will be COM or COL + 5%.
- If both COM + COL are used in combination, use COL + 5%.

Node Power Placement Option

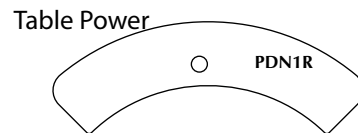

Seat Power N/A

Product Features

- Horizontal back provides easy ganging capabilities.
- Utilizes elastic webbing suspension that conforms to individual's lumbar curvatures for adaptive support.
- Upholstered Privacy Screen
- Upholstered screens can be specified in contrasting fabrics, vinyl, or leathers.
- All units are standard with 1" adjustable glides that allow for leveling

Options

Ganging Device

- GDEV-L: Left Facing Ganging Device - \$20
- GDEV-R: Right Facing Ganging Device - \$20
- GDEV-C: Center Ganging Device - \$40

Power

- PDN1R- Node in Rear Mount Table Top; 1 Power/1 USB Charger - \$409
- Standard in White (Available in Silver and Black)

1/2" Compact Matte Laminate Rear Table

- Matte Laminate RTD55: Rear Work Table - \$1,423, Specify LAW Alaska or LNB Nero Finish
- Rear table available on units that gang providing stability
- Rear table is mounted at 28.5"

Premium Finish Option (Standard White)

- Specify rear table bracket Metal Finish color - \$100 per unit
- MFS: Silver, MFB: Black

Bota

90 Deg. Circlet - Single Seat High Back
 90 Degree Back Inside Radius - High Back

[Click here to view statement of line](#)

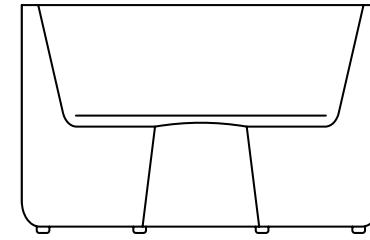

1 Model BOT0160HCS90

w" x d" x h"
 55.75 x 28.5 x 35.5
 Arm Height -
 Seat Height 17.5
 Inside Seat Depth 17
 Inside Seat Width 29.5

COM	COL	1	2	3	4	5	6	7	8	9	10	11/L1	12	13/L2
3529	3704	3770	3889	4008	4127	4246	4365	4484	4603	4722	4841	4960	5079	5317

Upholstery Requirements
 Fabric yds: 6.5 Leather Sq. Ft.: 117
 Carton Weight: 60

2 Select Finish

[Click to view finishes](#)

NA

3 Combination Fabrics

[Click to view finishes](#)

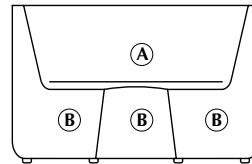

DARRAN is pleased to offer customers the design freedom of combination fabrics. When using fabric, vinyl or leather combinations, pricing/yardage requirements will be as follows:

A Inside Back & Seat 3 yds
 B Lounge Exterior 6 yds

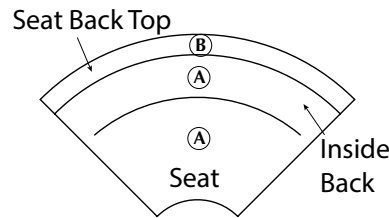

- When combining two materials of the same grade, pricing will be specified grade + 5%
- If combining two materials of different grades or leather/fabric combination, use the highest grade/price + 5%
- If using COM or COL, pricing will be COM or COL + 5%.
- If both COM + COL are used in combination, use COL + 5%.

Node Power Placement Option

Table Power

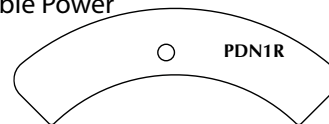

Seat Power N/A

Product Features

- Horizontal back provides easy ganging capabilities.
- Utilizes elastic webbing suspension that conforms to individual's lumbar curvatures for adaptive support.
- All units are standard with 1" adjustable glides that allow for leveling

Options

Ganging Device

- GDEV-L: Left Facing Ganging Device - \$20
- GDEV-R: Right Facing Ganging Device - \$20
- GDEV-C: Center Ganging Device - \$40

Power

- PDN1R- Node in Rear Mount Table Top; 1 Power/1 USB Charger - \$409
- Standard in White (Available in Silver and Black)

1/2" Compact Matte Laminate Rear Table

- Matte Laminate RTD55: Rear Work Table - \$1,423, Specify LAW Alaska or LNB Nero Finish
- Rear table available on units that gang providing stability
- Rear table is mounted at 35.5"

Premium Finish Option (Standard White)

- Specify rear table bracket Metal Finish color - \$100 per unit
- MFS: Silver, MFB: Black

Bota

90 Deg. Circlet - Single Seat High Back With Privacy Screen
 90 Degree Back Inside Radius - High Back - 10.5" Privacy Screen

[Click here to view statement of line](#)

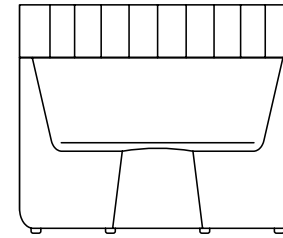

1 Model BOT0160HCL90

w" x d" x h"
 55.75 x 28.5 x 46
 Arm Height -
 Seat Height 17.5
 Inside Seat Depth 17
 Inside Seat Width 29.5

COM	COL	1	2	3	4	5	6	7	8	9	10	11/L1	12	13/L2
4546	4762	4879	5043	5207	5371	5535	5699	5863	6027	6191	6355	6519	6683	7011

Upholstery Requirements
 Fabric yds: 9 Leather Sq. Ft.: 162
 Carton Weight: 70

2 Select Finish

[Click to view finishes](#)

NA

3 Combination Fabrics

[Click to view finishes](#)

DARRAN is pleased to offer customers the design freedom of combination fabrics. When using fabric, vinyl or leather combinations, pricing/yardage requirements will be as follows:

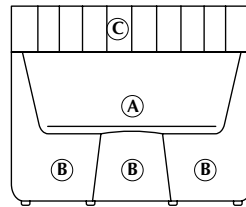

A Inside Back & Seat 3 yds
 B Lounge Exterior 6 yds
 C Privacy Screen 2.5 yds

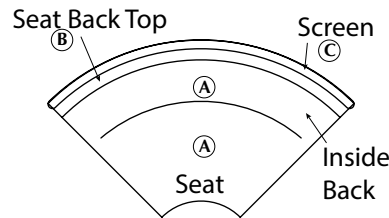

- When combining two materials of the same grade, pricing will be specified grade + 5%
- If combining two materials of different grades or leather/fabric combination, use the highest grade/price + 5%
- If using COM or COL, pricing will be COM or COL + 5%.
- If both COM + COL are used in combination, use COL + 5%.

Node Power Placement Option

Table Power

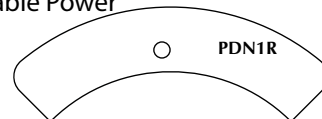

Seat Power N/A

Product Features

- Horizontal back provides easy ganging capabilities.
- Utilizes elastic webbing suspension that conforms to individual's lumbar curvatures for adaptive support.
- Upholstered Privacy Screen
- Upholstered screens can be specified in contrasting fabrics, vinyl, or leathers.
- All units are standard with 1" adjustable glides that allow for leveling

Options

Ganging Device

- GDEV-L: Left Facing Ganging Device - \$20
- GDEV-R: Right Facing Ganging Device - \$20
- GDEV-C: Center Ganging Device - \$40

Power

- PDN1R- Node in Rear Mount Table Top; 1 Power/1 USB Charger - \$409
- Standard in White (Available in Silver and Black)

1/2" Compact Matte Laminate Rear Table

- Matte Laminate RTD55: Rear Work Table - \$1,423, Specify LAW Alaska or LNB Nero Finish
- Rear table available on units that gang providing stability
- Rear table is mounted at 35.5"

Premium Finish Option (Standard White)

- Specify rear table bracket Metal Finish color - \$100 per unit
- MFS: Silver, MFB: Black

Bota

90 Deg. Circlet - Single Seat High Back With Privacy Screen
 90 Degree Back Inside Radius - High Back - 17.5" Privacy Screen

[Click here to view statement of line](#)

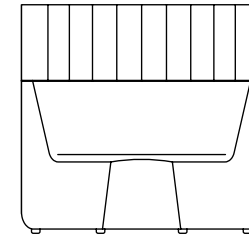

1 Model BOT0160HCH90

w" x d" x h"
 55.75 x 28.5 x 53
 Arm Height -
 Seat Height 17.5
 Inside Seat Depth 17
 Inside Seat Width 29.5

COM	COL	1	2	3	4	5	6	7	8	9	10	11/L1	12	13/L2
4735	4979	5161	5371	5581	5791	6001	6211	6421	6631	6841	7051	7261	7471	7891

Upholstery Requirements
 Fabric yds: 11.5 Leather Sq. Ft.: 207
 Carton Weight: 75

2 Select Finish

[Click to view finishes](#)

NA

3 Combination Fabrics

[Click to view finishes](#)

DARRAN is pleased to offer customers the design freedom of combination fabrics. When using fabric, vinyl or leather combinations, pricing/yardage requirements will be as follows:

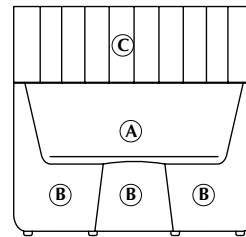

A Inside Back & Seat 3 yds
 B Lounge Exterior 6 yds
 C Privacy Screen 5 yds

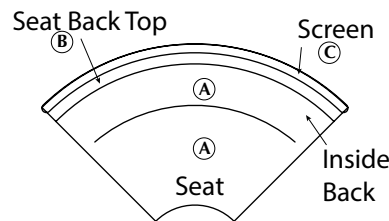

Node Power Placement Option

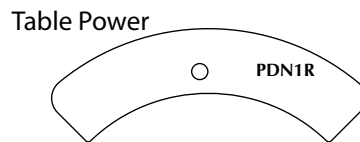

Seat Power N/A

- When combining two materials of the same grade, pricing will be specified grade + 5%
- If combining two materials of different grades or leather/fabric combination, use the highest grade/price + 5%
- If using COM or COL, pricing will be COM or COL + 5%.
- If both COM + COL are used in combination, use COL + 5%.

Product Features

- Horizontal back provides easy ganging capabilities.
- Utilizes elastic webbing suspension that conforms to individual's lumbar curvatures for adaptive support.
- Upholstered Privacy Screen
- Upholstered screens can be specified in contrasting fabrics, vinyl, or leathers.
- All units are standard with 1" adjustable glides that allow for leveling

Options

Ganging Device

- GDEV-L: Left Facing Ganging Device - \$20
- GDEV-R: Right Facing Ganging Device - \$20
- GDEV-C: Center Ganging Device - \$40

Power

- PDN1R- Node in Rear Mount Table Top; 1 Power/1 USB Charger - \$409
- Standard in White (Available in Silver and Black)

1/2" Compact Matte Laminate Rear Table

- Matte Laminate RTD55: Rear Work Table - \$1,423, Specify LAW Alaska or LNB Nero Finish
- Rear table available on units that gang providing stability
- Rear table is mounted at 35.5"

Premium Finish Option (Standard White)

- Specify rear table bracket Metal Finish color - \$100 per unit
- MFS: Silver, MFB: Black

Bota

60 Deg. Circlet - Double Seat Low Back
 60 Degree Back Inside Radius - Low Back

[Click here to view statement of line](#)

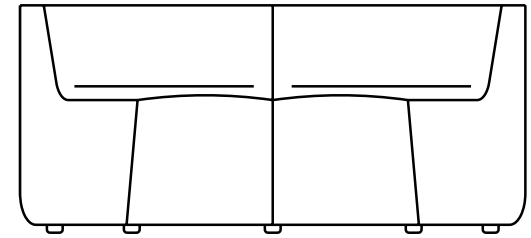

1 Model BOT0160LCS60

w" x d" x h"
 63 x 28.5 x 28.25
 Arm Height -
 Seat Height 17.5
 Inside Seat Depth 17
 Inside Seat Width 29.5

COM	COL	1	2	3	4	5	6	7	8	9	10	11/L1	12	13/L2
3374	3564	3596	3705	3814	3923	4032	4141	4250	4359	4468	4577	4686	4795	5013

Upholstery Requirements
 Fabric yds: 6 Leather Sq. Ft.: 108
 Carton Weight: 89

2 Select Finish

[Click to view finishes](#)

NA

3 Combination Fabrics

[Click to view finishes](#)

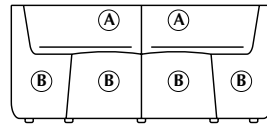

DARRAN is pleased to offer customers the design freedom of combination fabrics. When using fabric, vinyl or leather combinations, pricing/yardage requirements will be as follows:

A Inside Back & Seat 2 yds
 B Lounge Exterior 6 yds

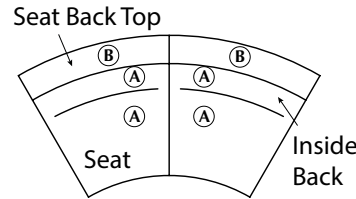

- When combining two materials of the same grade, pricing will be specified grade + 5%
- If combining two materials of different grades or leather/fabric combination, use the highest grade/price + 5%
- If using COM or COL, pricing will be COM or COL + 5%.
- If both COM + COL are used in combination, use COL + 5%.

Node Power Placement Option

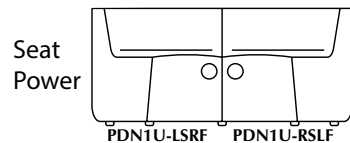
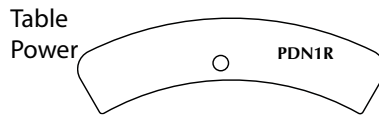

Product Features

- Horizontal back provides easy ganging capabilities.
- Utilizes elastic webbing suspension that conforms to individual's lumbar curvatures for adaptive support.
- All units are standard with 1" adjustable glides that allow for leveling

Options

Ganging Device

- GDEV-L: Left Facing Ganging Device - \$20
- GDEV-R: Right Facing Ganging Device - \$20
- GDEV-C: Center Ganging Device - \$40

Power

- PDN1U-LSRF: Node in Left Seat Right Facing Seat Front; 1 Power/1 USB Charger - \$355
- PDN1U-RSLF: Node in Right Seat Left Facing Seat Front; 1 Power/1 USB Charger - \$355
- PDN1U-BC: Node in Both Left and Right Facing Center Seat Front; 1 Power/1 USB Charger per pod - \$709
- PDN1R: Node in Rear Mount Table Top; 1 Power/1 USB Charger - \$409
- Standard in White (Available in Silver and Black)

1/2" Compact Matte Laminate Rear Table

- Matte Laminate RTD63: Rear Work Table - \$1,472, Specify LAW Alaska or LNB Nero Finish
- Rear table available on units that gang providing stability
- Rear table is mounted at 28.5"

1/2" Compact Matte Laminate Tablet

- FFTD: 1/2" Compact Matte Laminate Tablet - \$622, Specify LAW Alaska or LNB Nero Finish
- Tablet is center mount only

Premium Finish Option (Standard White)

- Specify rear table bracket Metal Finish color - \$100 per unit
- Specify tablet Metal Finish color - \$100 per unit
- MFS: Silver, MFB: Black

Bota

60 Deg. Circlet - Double Seat Low Back With Privacy Screen
 60 Degree Back Inside Radius - Low Back - 10.5" Privacy Screen

[Click here to view statement of line](#)

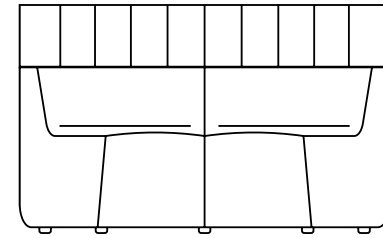

1 Model BOT0160LCL60

w" x d" x h"
 63 x 28.5 x 39
 Arm Height -
 Seat Height 17.5
 Inside Seat Depth 17
 Inside Seat Width 29.5

COM	COL	1	2	3	4	5	6	7	8	9	10	11/L1	12	13/L2
4400	4636	4696	4842	4988	5134	5280	5426	5572	5718	5864	6010	6156	6302	6594

Upholstery Requirements
 Fabric yds: 8 Leather Sq. Ft.: 144
 Carton Weight: 99

2 Select Finish

[Click to view finishes](#)

NA

3 Combination Fabrics

[Click to view finishes](#)

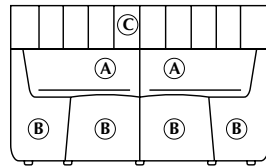

DARRAN is pleased to offer customers the design freedom of combination fabrics. When using fabric, vinyl or leather combinations, pricing/yardage requirements will be as follows:

- A Inside Back & Seat 2 yds
- B Lounge Exterior 6 yds
- C Privacy Screen 2.5 yds

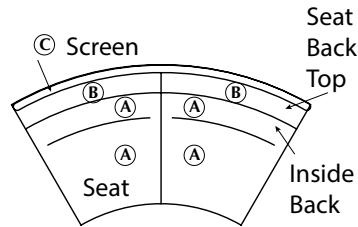

- When combining two materials of the same grade, pricing will be specified grade + 5%
- If combining two materials of different grades or leather/fabric combination, use the highest grade/price + 5%
- If using COM or COL, pricing will be COM or COL + 5%.
- If both COM + COL are used in combination, use COL + 5%.

Node Power Placement Option

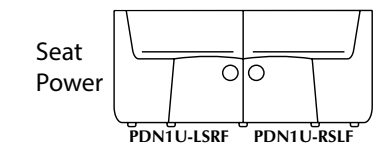
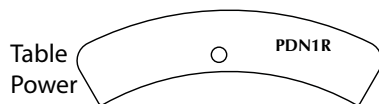

Product Features

- Horizontal back provides easy ganging capabilities.
- Utilizes elastic webbing suspension that conforms to individual's lumbar curvatures for adaptive support.
- Upholstered Privacy Screen
- Upholstered screens can be specified in contrasting fabrics, vinyl, or leathers.
- All units are standard with 1" adjustable glides that allow for leveling

Options

Ganging Device

- GDEV-L: Left Facing Ganging Device - \$20
- GDEV-R: Right Facing Ganging Device - \$20
- GDEV-C: Center Ganging Device - \$40

Power

- PDN1U-LSRF: Node in Left Seat Right Facing Seat Front; 1 Power/1 USB Charger - \$355
- PDN1U-RSLF: Node in Right Seat Left Facing Seat Front; 1 Power/1 USB Charger - \$355
- PDN1U-BC: Node in Both Left and Right Facing Center Seat Front; 1 Power/1 USB Charger per pod - \$709
- PDN1R: Node in Rear Mount Table Top; 1 Power/1 USB Charger - \$409
- Standard in White (Available in Silver and Black)

1/2" Compact Matte Laminate Rear Table

- Matte Laminate RTD63: Rear Work Table - \$1,472, Specify LAW Alaska or LNB Nero Finish
- Rear table available on units that gang providing stability
- Rear table is mounted at 28.5"

1/2" Compact Matte Laminate Tablet

- FFD: 1/2" Compact Matte Laminate Tablet - \$622, Specify LAW Alaska or LNB Nero Finish
- Tablet is center mount only

Premium Finish Option (Standard White)

- Specify rear table bracket Metal Finish color - \$100 per unit
- Specify tablet Metal Finish color - \$100 per unit
- MFS: Silver, MFB: Black

Bota

60 Deg. Circlet - Double Seat Low Back With Privacy Screen
 60 Degree Back Inside Radius - Low Back - 24.75" Privacy Screen

[Click here to view statement of line](#)

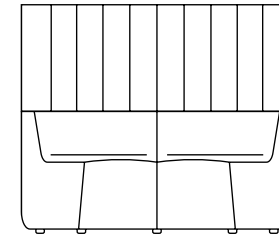

1 Model BOT0160LCH60

w" x d" x h"
 63 x 28.5 x 53.25
 Arm Height -
 Seat Height 17.5
 Inside Seat Depth 17
 Inside Seat Width 29.5

COM	COL	1	2	3	4	5	6	7	8	9	10	11/L1	12	13/L2
5108	5407	5478	5660	5842	6024	6206	6388	6570	6752	6934	7116	7298	7480	7844

Upholstery Requirements
 Fabric yds: 10 Leather Sq. Ft.: 180
 Carton Weight: 119

2 Select Finish

[Click to view finishes](#)

NA

3 Combination Fabrics

[Click to view finishes](#)

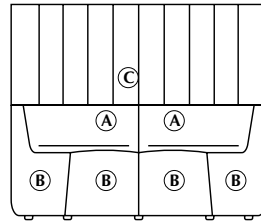

DARRAN is pleased to offer customers the design freedom of combination fabrics. When using fabric, vinyl or leather combinations, pricing/yardage requirements will be as follows:

A Inside Back & Seat 2 yds
 B Lounge Exterior 6 yds
 C Privacy Screen 5 yds

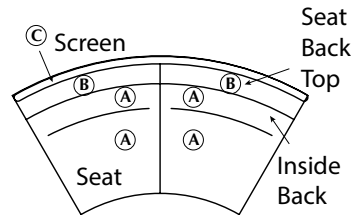

- When combining two materials of the same grade, pricing will be specified grade + 5%
- If combining two materials of different grades or leather/fabric combination, use the highest grade/price + 5%
- If using COM or COL, pricing will be COM or COL + 5%.
- If both COM + COL are used in combination, use COL + 5%.

Node Power Placement Option

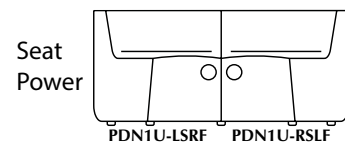
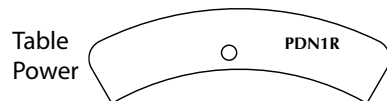

Product Features

- Horizontal back provides easy ganging capabilities.
- Utilizes elastic webbing suspension that conforms to individual's lumbar curvatures for adaptive support.
- Upholstered Privacy Screen
- Upholstered screens can be specified in contrasting fabrics, vinyl, or leathers.
- All units are standard with 1" adjustable glides that allow for leveling

Options

Ganging Device

- GDEV-L: Left Facing Ganging Device - \$20
- GDEV-R: Right Facing Ganging Device - \$20
- GDEV-C: Center Ganging Device - \$40

Power

- PDN1U-LSRF: Node in Left Seat Right Facing Seat Front; 1 Power/1 USB Charger - \$355
- PDN1U-RSLF: Node in Right Seat Left Facing Seat Front; 1 Power/1 USB Charger - \$355
- PDN1U-BC: Node in Both Left and Right Facing Center Seat Front; 1 Power/1 USB Charger per pod - \$709
- PDN1R: Node in Rear Mount Table Top; 1 Power/1 USB Charger - \$409
- Standard in White (Available in Silver and Black)

1/2" Compact Matte Laminate Rear Table

- Matte Laminate RTD63: Rear Work Table - \$1,472, Specify LAW Alaska or LNB Nero Finish
- Rear table available on units that gang providing stability
- Rear table is mounted at 28.5"

1/2" Compact Matte Laminate Tablet

- FFD: 1/2" Compact Matte Laminate Tablet - \$622, Specify LAW Alaska or LNB Nero Finish
- Tablet is center mount only

Premium Finish Option (Standard White)

- Specify rear table bracket Metal Finish color - \$100 per unit
- Specify tablet Metal Finish color - \$100 per unit
- MFS: Silver, MFB: Black

Bota

60 Deg. Circlet - Double Seat High Back
 60 Degree Back Inside Radius - High Back

[Click here to view statement of line](#)

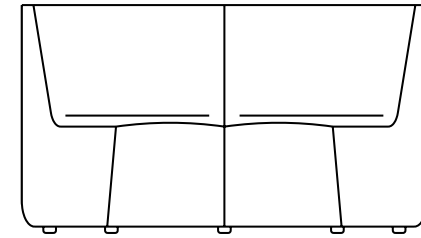

1 Model BOT0160HCS60

w" x d" x h"
 63 x 28.5 x 35.5
 Arm Height -
 Seat Height 17.5
 Inside Seat Depth 17
 Inside Seat Width 29.5

COM	COL	1	2	3	4	5	6	7	8	9	10	11/L1	12	13/L2
3835	4033	4076	4195	4314	4433	4552	4671	4790	4909	5028	5147	5266	5385	5623

Upholstery Requirements
 Fabric yds: 6.5 Leather Sq. Ft.: 117
 Carton Weight: 94

2 Select Finish

[Click to view finishes](#)

NA

3 Combination Fabrics

[Click to view finishes](#)

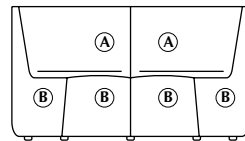

Seat Back Top

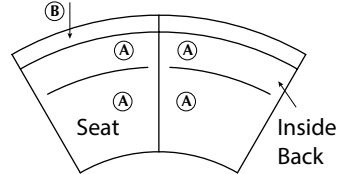

Node Power Placement Option

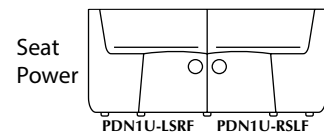
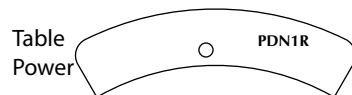

DARRAN is pleased to offer customers the design freedom of combination fabrics. When using fabric, vinyl or leather combinations, pricing/yardage requirements will be as follows:

A Inside Back & Seat 3 yds
 B Lounge Exterior 6 yds

- When combining two materials of the same grade, pricing will be specified grade + 5%
- If combining two materials of different grades or leather/fabric combination, use the highest grade/price + 5%
- If using COM or COL, pricing will be COM or COL + 5%.
- If both COM + COL are used in combination, use COL + 5%.

Product Features

- Horizontal back provides easy ganging capabilities.
- Utilizes elastic webbing suspension that conforms to individual's lumbar curvatures for adaptive support.
- All units are standard with 1" adjustable glides that allow for leveling

Options

Ganging Device

- GDEV-L: Left Facing Ganging Device - \$20
- GDEV-R: Right Facing Ganging Device - \$20
- GDEV-C: Center Ganging Device - \$40

Power

- PDN1U-LSRF: Node in Left Seat Right Facing Seat Front; 1 Power/1 USB Charger - \$355
- PDN1U-RSLF: Node in Right Seat Left Facing Seat Front; 1 Power/1 USB Charger - \$355
- PDN1U-BC: Node in Both Left and Right Facing Center Seat Front; 1 Power/1 USB Charger per pod - \$709
- PDN1R: Node in Rear Mount Table Top; 1 Power/1 USB Charger - \$409
- Standard in White (Available in Silver and Black)

1/2" Compact Matte Laminate Rear Table

- Matte Laminate RTD63: Rear Work Table - \$1,472, Specify LAW Alaska or LNB Nero Finish
- Rear table available on units that gang providing stability
- Rear table is mounted at 35.5"

1/2" Compact Matte Laminate Tablet

- FFTD: 1/2" Compact Matte Laminate Tablet - \$622, Specify LAW Alaska or LNB Nero Finish
- Tablet is center mount only

Premium Finish Option (Standard White)

- Specify rear table bracket Metal Finish color - \$100 per unit
- Specify tablet Metal Finish color - \$100 per unit
- MFS: Silver, MFB: Black

Bota

60 Deg. Circlet - Double Seat High Back With Privacy Screen
 60 Degree Back Inside Radius - High Back - 10.5" Privacy Screen

[Click here to view statement of line](#)

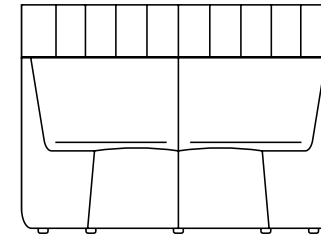

1 Model BOT0160HCL60

w" x d" x h"
 63 x 28.5 x 46
 Arm Height -
 Seat Height 17.5
 Inside Seat Depth 17
 Inside Seat Width 29.5

COM	COL	1	2	3	4	5	6	7	8	9	10	11/L1	12	13/L2
4880	5123	5213	5377	5541	5705	5869	6033	6197	6361	6525	6689	6853	7017	7345

Upholstery Requirements
 Fabric yds: 9 Leather Sq. Ft.: 162
 Carton Weight: 114

2 Select Finish

[Click to view finishes](#)

NA

3 Combination Fabrics

[Click to view finishes](#)

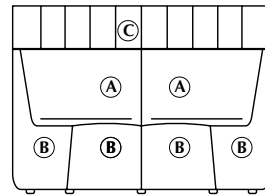

DARRAN is pleased to offer customers the design freedom of combination fabrics. When using fabric, vinyl or leather combinations, pricing/yardage requirements will be as follows:

- A Inside Back & Seat 3 yds
- B Lounge Exterior 6 yds
- C Privacy Screen 2.5 yds

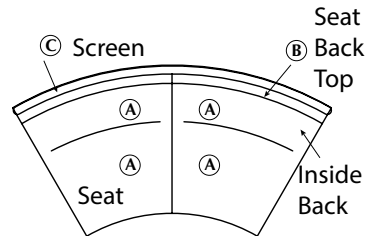

- When combining two materials of the same grade, pricing will be specified grade + 5%
- If combining two materials of different grades or leather/fabric combination, use the highest grade/price + 5%
- If using COM or COL, pricing will be COM or COL + 5%.
- If both COM + COL are used in combination, use COL + 5%.

Node Power Placement Option

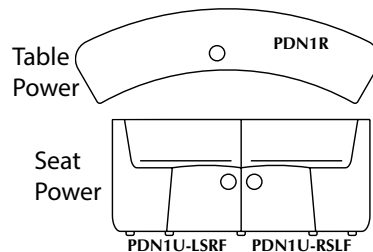

Product Features

- Horizontal back provides easy ganging capabilities.
- Utilizes elastic webbing suspension that conforms to individual's lumbar curvatures for adaptive support.
- Upholstered Privacy Screen
- Upholstered screens can be specified in contrasting fabrics, vinyl, or leathers.
- All units are standard with 1" adjustable glides that allow for leveling

Options

Ganging Device

- GDEV-L: Left Facing Ganging Device - \$20
- GDEV-R: Right Facing Ganging Device - \$20
- GDEV-C: Center Ganging Device - \$40

Power

- PDN1U-LSRF: Node in Left Seat Right Facing Seat Front; 1 Power/1 USB Charger - \$355
- PDN1U-RSLF: Node in Right Seat Left Facing Seat Front; 1 Power/1 USB Charger - \$355
- PDN1U-BC: Node in Both Left and Right Facing Center Seat Front; 1 Power/1 USB Charger per pod - \$709
- PDN1R: Node in Rear Mount Table Top; 1 Power/1 USB Charger - \$409
- Standard in White (Available in Silver and Black)

1/2" Compact Matte Laminate Rear Table

- Matte Laminate RTD63: Rear Work Table - \$1,472, Specify LAW Alaska or LNB Nero Finish
- Rear table available on units that gang providing stability
- Rear table is mounted at 35.5"

1/2" Compact Matte Laminate Tablet

- FFD: 1/2" Compact Matte Laminate Tablet - \$622, Specify LAW Alaska or LNB Nero Finish
- Tablet is center mount only

Premium Finish Option (Standard White)

- Specify rear table bracket Metal Finish color - \$100 per unit
- Specify tablet Metal Finish color - \$100 per unit
- MFS: Silver, MFB: Black

Bota

60 Deg. Circlet - Double Seat High Back With Privacy Screen
 60 Degree Back Inside Radius - High Back - 17.5" Privacy Screen

[Click here to view statement of line](#)

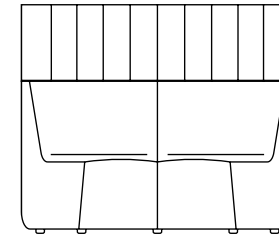

1 Model BOT0160HCH60

w" x d" x h"
 63 x 28.5 x 53
 Arm Height -
 Seat Height 17.5
 Inside Seat Depth 17
 Inside Seat Width 29.5

COM	COL	1	2	3	4	5	6	7	8	9	10	11/L1	12	13/L2
5254	5530	5680	5890	6100	6310	6520	6730	6940	7150	7360	7570	7780	7990	8410

Upholstery Requirements
 Fabric yds: 11.5 Leather Sq. Ft.: 207
 Carton Weight: 124

2 Select Finish

[Click to view finishes](#)

NA

3 Combination Fabrics

[Click to view finishes](#)

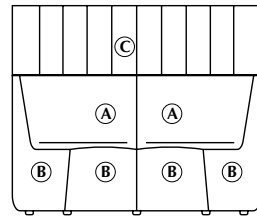

DARRAN is pleased to offer customers the design freedom of combination fabrics. When using fabric, vinyl or leather combinations, pricing/yardage requirements will be as follows:

- A Inside Back & Seat 3 yds
- B Lounge Exterior 6 yds
- C Privacy Screen 5 yds

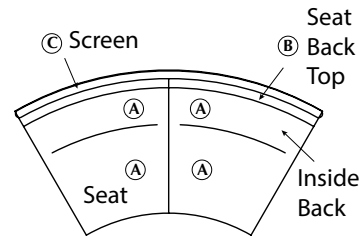

- When combining two materials of the same grade, pricing will be specified grade + 5%
- If combining two materials of different grades or leather/fabric combination, use the highest grade/price + 5%
- If using COM or COL, pricing will be COM or COL + 5%.
- If both COM + COL are used in combination, use COL + 5%.

Node Power Placement Option

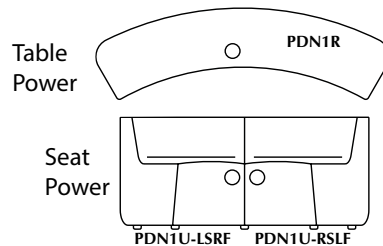

Product Features

- Horizontal back provides easy ganging capabilities.
- Utilizes elastic webbing suspension that conforms to individual's lumbar curvatures for adaptive support.
- Upholstered Privacy Screen
- Upholstered screens can be specified in contrasting fabrics, vinyl, or leathers.
- All units are standard with 1" adjustable glides that allow for leveling

Options

Ganging Device

- GDEV-L: Left Facing Ganging Device - \$20
- GDEV-R: Right Facing Ganging Device - \$20
- GDEV-C: Center Ganging Device - \$40

Power

- PDN1U-LSRF: Node in Left Seat Right Facing Seat Front; 1 Power/1 USB Charger - \$355
- PDN1U-RSLF: Node in Right Seat Left Facing Seat Front; 1 Power/1 USB Charger - \$355
- PDN1U-BC: Node in Both Left and Right Facing Center Seat Front; 1 Power/1 USB Charger per pod - \$709
- PDN1R: Node in Rear Mount Table Top; 1 Power/1 USB Charger - \$409
- Standard in White (Available in Silver and Black)

1/2" Compact Matte Laminate Rear Table

- Matte Laminate RTD63: Rear Work Table - \$1,472, Specify LAW Alaska or LNB Nero Finish
- Rear table available on units that gang providing stability
- Rear table is mounted at 35.5"

1/2" Compact Matte Laminate Tablet

- FFD: 1/2" Compact Matte Laminate Tablet - \$622, Specify LAW Alaska or LNB Nero Finish
- Tablet is center mount only

Premium Finish Option (Standard White)

- Specify rear table bracket Metal Finish color - \$100 per unit
- Specify tablet Metal Finish color - \$100 per unit
- MFS: Silver, MFB: Black

Bota

45 Deg. Circlet - Double Seat Low Back
 45 Degree Back Inside Radius - Low Back

[Click here to view statement of line](#)

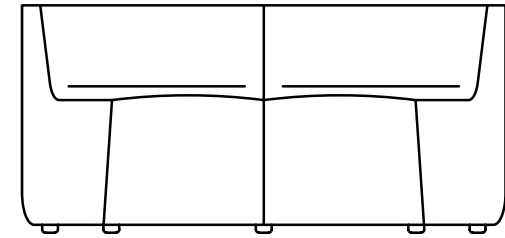

1 Model BOT0160LCS45

w" x d" x h"
 60.25 x 28.5 x 28.25
 Arm Height -
 Seat Height 17.5
 Inside Seat Depth 17
 Inside Seat Width 29.5

COM	COL	1	2	3	4	5	6	7	8	9	10	11/L1	12	13/L2
3313	3503	3572	3700	3828	3956	4084	4212	4340	4468	4596	4724	4852	4980	5236

Upholstery Requirements
 Fabric yds: 7 Leather Sq. Ft.: 126
 Carton Weight: 84

2 Select Finish

[Click to view finishes](#)

NA

3 Combination Fabrics

[Click to view finishes](#)

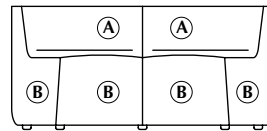

DARRAN is pleased to offer customers the design freedom of combination fabrics. When using fabric, vinyl or leather combinations, pricing/yardage requirements will be as follows:

A Inside Back & Seat 2 yds
 B Lounge Exterior 7 yds

Seat Back Top

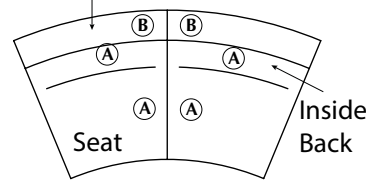

- When combining two materials of the same grade, pricing will be specified grade + 5%
- If combining two materials of different grades or leather/fabric combination, use the highest grade/price + 5%
- If using COM or COL, pricing will be COM or COL + 5%.
- If both COM + COL are used in combination, use COL + 5%.

Node Power Placement Option

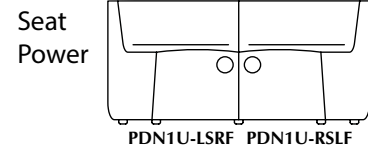
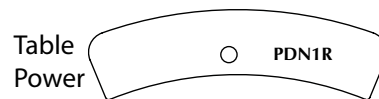

Product Features

- Horizontal back provides easy ganging capabilities.
- Utilizes elastic webbing suspension that conforms to individual's lumbar curvatures for adaptive support.
- All units are standard with 1" adjustable glides that allow for leveling

Options

Ganging Device

- GDEV-L: Left Facing Ganging Device - \$20
- GDEV-R: Right Facing Ganging Device - \$20
- GDEV-C: Center Ganging Device - \$40

Power

- PDN1U-LSRF: Node in Left Seat Right Facing Seat Front; 1 Power/1 USB Charger - \$355
- PDN1U-RSLF: Node in Right Seat Left Facing Seat Front; 1 Power/1 USB Charger - \$355
- PDN1U-BC: Node in Both Left and Right Facing Center Seat Front; 1 Power/1 USB Charger per pod - \$709
- PDN1R: Node in Rear Mount Table Top; 1 Power/1 USB Charger - \$409
- Standard in White (Available in Silver and Black)

1/2" Compact Matte Laminate Rear Table

- Matte Laminate RTD60: Rear Work Table - \$1,374, Specify LAW Alaska or LNB Nero Finish
- Rear table available on units that gang providing stability
- Rear table is mounted at 28.5"

1/2" Compact Matte Laminate Tablet

- FFTD: 1/2" Compact Matte Laminate Tablet - \$622, Specify LAW Alaska or LNB Nero Finish
- Tablet is center mount only

Premium Finish Option (Standard White)

- Specify rear table bracket Metal Finish color - \$100 per unit
- Specify tablet Metal Finish color - \$100 per unit
- MFS: Silver, MFB: Black

Bota

45 Deg. Circlet - Double Seat Low Back With Privacy Screen
 45 Degree Back Inside Radius - Low Back - 10.5" Privacy Screen

[Click here to view statement of line](#)

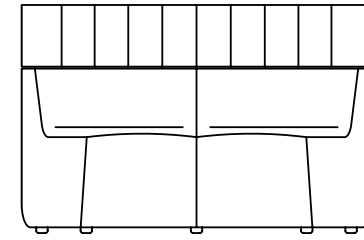

1 Model BOT0160LCL45

w" x d" x h"
 60.25 x 28.5 x 39
 Arm Height -
 Seat Height 17.5
 Inside Seat Depth 17
 Inside Seat Width 29.5

COM	COL	1	2	3	4	5	6	7	8	9	10	11/L1	12	13/L2
4384	4619	4717	4881	5045	5209	5373	5537	5701	5865	6029	6193	6357	6521	6849

Upholstery Requirements
 Fabric yds: 9 Leather Sq. Ft.: 162
 Carton Weight: 94

2 Select Finish

[Click to view finishes](#)

NA

3 Combination Fabrics

[Click to view finishes](#)

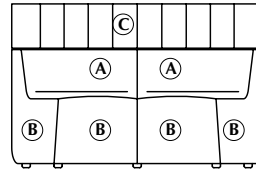

DARRAN is pleased to offer customers the design freedom of combination fabrics. When using fabric, vinyl or leather combinations, pricing/yardage requirements will be as follows:

- A Inside Back & Seat 2 yds
- B Lounge Exterior 7 yds
- C Privacy Screen 2.5 yds

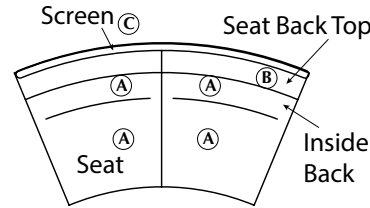

- When combining two materials of the same grade, pricing will be specified grade + 5%
- If combining two materials of different grades or leather/fabric combination, use the highest grade/price + 5%
- If using COM or COL, pricing will be COM or COL + 5%.
- If both COM + COL are used in combination, use COL + 5%.

Node Power Placement Option

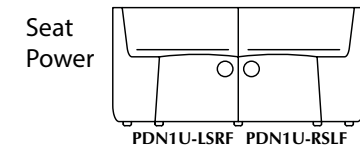
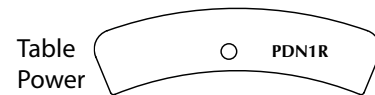

Product Features

- Horizontal back provides easy ganging capabilities.
- Utilizes elastic webbing suspension that conforms to individual's lumbar curvatures for adaptive support.
- Upholstered Privacy Screen
- Upholstered screens can be specified in contrasting fabrics, vinyl, or leathers.
- All units are standard with 1" adjustable glides that allow for leveling

Options

Ganging Device

- GDEV-L: Left Facing Ganging Device - \$20
- GDEV-R: Right Facing Ganging Device - \$20
- GDEV-C: Center Ganging Device - \$40

Power

- PDN1U-LSRF: Node in Left Seat Right Facing Seat Front; 1 Power/1 USB Charger - \$355
- PDN1U-RSLF: Node in Right Seat Left Facing Seat Front; 1 Power/1 USB Charger - \$355
- PDN1U-BC: Node in Both Left and Right Facing Center Seat Front; 1 Power/1 USB Charger per pod - \$709
- PDN1R: Node in Rear Mount Table Top; 1 Power/1 USB Charger - \$409
- Standard in White (Available in Silver and Black)

1/2" Compact Matte Laminate Rear Table

- Matte Laminate RTD60: Rear Work Table - \$1,374, Specify LAW Alaska or LNB Nero Finish
- Rear table available on units that gang providing stability
- Rear table is mounted at 28.5"

1/2" Compact Matte Laminate Tablet

- FFD: 1/2" Compact Matte Laminate Tablet - \$622, Specify LAW Alaska or LNB Nero Finish
- Tablet is center mount only

Premium Finish Option (Standard White)

- Specify rear table bracket Metal Finish color - \$100 per unit
- Specify tablet Metal Finish color - \$100 per unit
- MFS: Silver, MFB: Black

Bota

45 Deg. Circlet - Double Seat Low Back With Privacy Screen
 45 Degree Back Inside Radius - Low Back - 24.75" Privacy Screen

[Click here to view statement of line](#)

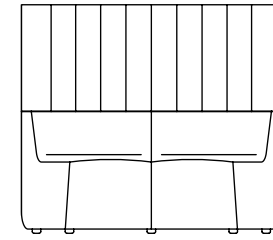

1 Model BOT0160LCH45

w" x d" x h"
 60.25 x 28.5 x 53.25
 Arm Height -
 Seat Height 17.5
 Inside Seat Depth 17
 Inside Seat Width 29.5

COM	COL	1	2	3	4	5	6	7	8	9	10	11/L1	12	13/L2
5059	5354	5466	5667	5868	6069	6270	6471	6672	6873	7074	7275	7476	7677	8079

Upholstery Requirements
 Fabric yds: 11 Leather Sq. Ft.: 198
 Carton Weight: 114

2 Select Finish

[Click to view finishes](#)

NA

3 Combination Fabrics

[Click to view finishes](#)

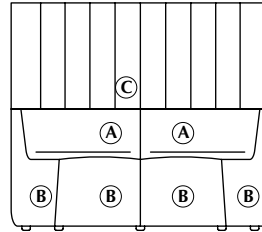

DARRAN is pleased to offer customers the design freedom of combination fabrics. When using fabric, vinyl or leather combinations, pricing/yardage requirements will be as follows:

- A Inside Back & Seat 2 yds
- B Lounge Exterior 7 yds
- C Privacy Screen 5 yds

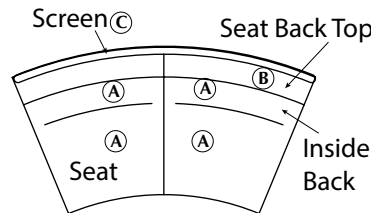

- When combining two materials of the same grade, pricing will be specified grade + 5%
- If combining two materials of different grades or leather/fabric combination, use the highest grade/price + 5%
- If using COM or COL, pricing will be COM or COL + 5%.
- If both COM + COL are used in combination, use COL + 5%.

Node Power Placement Option

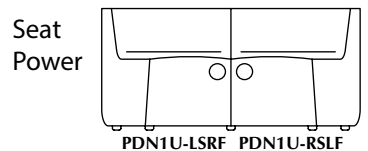
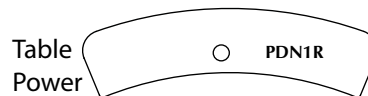

Product Features

- Horizontal back provides easy ganging capabilities.
- Utilizes elastic webbing suspension that conforms to individual's lumbar curvatures for adaptive support.
- Upholstered Privacy Screen
- Upholstered screens can be specified in contrasting fabrics, vinyl, or leathers.
- All units are standard with 1" adjustable glides that allow for leveling

Options

Ganging Device

- GDEV-L: Left Facing Ganging Device - \$20
- GDEV-R: Right Facing Ganging Device - \$20
- GDEV-C: Center Ganging Device - \$40

Power

- PDN1U-LSRF: Node in Left Seat Right Facing Seat Front; 1 Power/1 USB Charger - \$355
- PDN1U-RSLF: Node in Right Seat Left Facing Seat Front; 1 Power/1 USB Charger - \$355
- PDN1U-BC: Node in Both Left and Right Facing Center Seat Front; 1 Power/1 USB Charger per pod - \$709
- PDN1R: Node in Rear Mount Table Top; 1 Power/1 USB Charger - \$409
- Standard in White (Available in Silver and Black)

1/2" Compact Matte Laminate Rear Table

- Matte Laminate RTD60: Rear Work Table - \$1,374, Specify LAW Alaska or LNB Nero Finish
- Rear table available on units that gang providing stability
- Rear table is mounted at 28.5"

1/2" Compact Matte Laminate Tablet

- FFD: 1/2" Compact Matte Laminate Tablet - \$622, Specify LAW Alaska or LNB Nero Finish
- Tablet is center mount only

Premium Finish Option (Standard White)

- Specify rear table bracket Metal Finish color - \$100 per unit
- Specify tablet Metal Finish color - \$100 per unit
- MFS: Silver, MFB: Black

Bota

45 Deg. Circlet - Double Seat High Back
 45 Degree Back Inside Radius - High Back

[Click here to view statement of line](#)

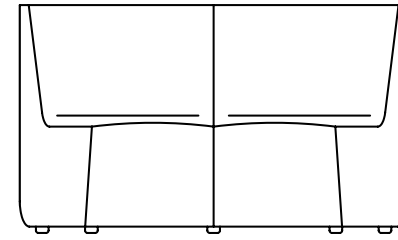

1 Model BOT0160HCS45

w" x d" x h"
 60.25 x 28.5 x 35.5
 Arm Height -
 Seat Height 17.5
 Inside Seat Depth 17
 Inside Seat Width 29.5

COM	COL	1	2	3	4	5	6	7	8	9	10	11/L1	12	13/L2
3782	3980	4023	4142	4261	4380	4499	4618	4737	4856	4975	5094	5213	5332	5570

Upholstery Requirements
 Fabric yds: 6.5 Leather Sq. Ft.: 117
 Carton Weight: 89

2 Select Finish

[Click to view finishes](#)

NA

3 Combination Fabrics

[Click to view finishes](#)

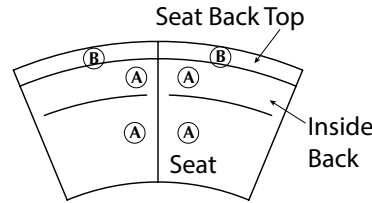
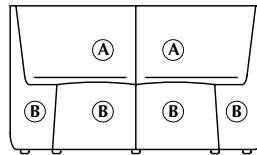

DARRAN is pleased to offer customers the design freedom of combination fabrics. When using fabric, vinyl or leather combinations, pricing/yardage requirements will be as follows:

A Inside Back & Seat 3 yds
 B Lounge Exterior 7 yds

- When combining two materials of the same grade, pricing will be specified grade + 5%
- If combining two materials of different grades or leather/fabric combination, use the highest grade/price + 5%
- If using COM or COL, pricing will be COM or COL + 5%.
- If both COM + COL are used in combination, use COL + 5%.

Node Power Placement Option

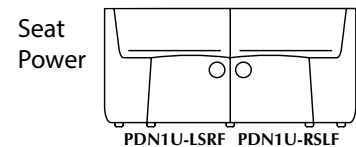
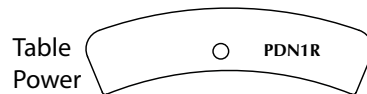

Product Features

- Horizontal back provides easy ganging capabilities.
- Utilizes elastic webbing suspension that conforms to individual's lumbar curvatures for adaptive support.
- All units are standard with 1" adjustable glides that allow for leveling

Options

Ganging Device

- GDEV-L: Left Facing Ganging Device - \$20
- GDEV-R: Right Facing Ganging Device - \$20
- GDEV-C: Center Ganging Device - \$40

Power

- PDN1U-LSRF: Node in Left Seat Right Facing Seat Front; 1 Power/1 USB Charger - \$355
- PDN1U-RSLF: Node in Right Seat Left Facing Seat Front; 1 Power/1 USB Charger - \$355
- PDN1U-BC: Node in Both Left and Right Facing Center Seat Front; 1 Power/1 USB Charger per pod - \$709
- PDN1R: Node in Rear Mount Table Top; 1 Power/1 USB Charger - \$409
- Standard in White (Available in Silver and Black)

1/2" Compact Matte Laminate Rear Table

- Matte Laminate RTD60: Rear Work Table - \$1,374, Specify LAW Alaska or LNB Nero Finish
- Rear table available on units that gang providing stability
- Rear table is mounted at 35.5"

1/2" Compact Matte Laminate Tablet

- FFTD: 1/2" Compact Matte Laminate Tablet - \$622, Specify LAW Alaska or LNB Nero Finish
- Tablet is center mount only

Premium Finish Option (Standard White)

- Specify rear table bracket Metal Finish color - \$100 per unit
- Specify tablet Metal Finish color - \$100 per unit
- MFS: Silver, MFB: Black

Bota

45 Deg. Circlet - Double Seat High Back With Privacy Screen
 45 Degree Back Inside Radius - High Back - 10.5" Privacy Screen

[Click here to view statement of line](#)

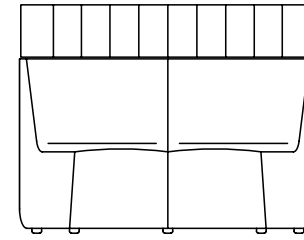

1 Model BOT0160HCL45

w" x d" x h"
 60.25 x 28.5 x 46
 Arm Height -
 Seat Height 17.5
 Inside Seat Depth 17
 Inside Seat Width 29.5

COM	COL	1	2	3	4	5	6	7	8	9	10	11/L1	12	13/L2
4924	4979	5165	5284	5403	5522	5641	5760	5879	5998	6117	6236	6355	6474	6712

Upholstery Requirements
 Fabric yds: 6.5 Leather Sq. Ft.: 117
 Carton Weight: 109

2 Select Finish

[Click to view finishes](#)

NA

3 Combination Fabrics

[Click to view finishes](#)

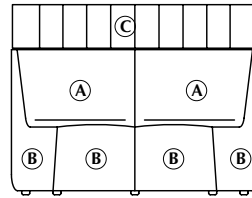

DARRAN is pleased to offer customers the design freedom of combination fabrics. When using fabric, vinyl or leather combinations, pricing/yardage requirements will be as follows:

A Inside Back & Seat 3 yds
 B Lounge Exterior 7 yds
 C Privacy Screen 2.5 yds

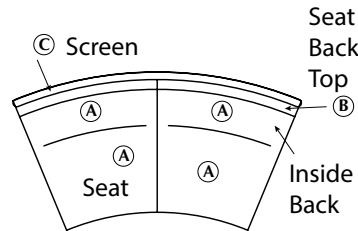

- When combining two materials of the same grade, pricing will be specified grade + 5%
- If combining two materials of different grades or leather/fabric combination, use the highest grade/price + 5%
- If using COM or COL, pricing will be COM or COL + 5%.
- If both COM + COL are used in combination, use COL + 5%.

Node Power Placement Option

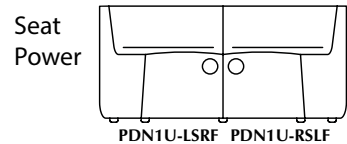
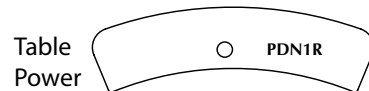

Product Features

- Horizontal back provides easy ganging capabilities.
- Utilizes elastic webbing suspension that conforms to individual's lumbar curvatures for adaptive support.
- Upholstered Privacy Screen
- Upholstered screens can be specified in contrasting fabrics, vinyl, or leathers.
- All units are standard with 1" adjustable glides that allow for leveling

Options

Ganging Device

- GDEV-L: Left Facing Ganging Device - \$20
- GDEV-R: Right Facing Ganging Device - \$20
- GDEV-C: Center Ganging Device - \$40

Power

- PDN1U-LSRF: Node in Left Seat Right Facing Seat Front; 1 Power/1 USB Charger - \$355
- PDN1U-RSLF: Node in Right Seat Left Facing Seat Front; 1 Power/1 USB Charger - \$355
- PDN1U-BC: Node in Both Left and Right Facing Center Seat Front; 1 Power/1 USB Charger per pod - \$709
- PDN1R: Node in Rear Mount Table Top; 1 Power/1 USB Charger - \$409
- Standard in White (Available in Silver and Black)

1/2" Compact Matte Laminate Rear Table

- Matte Laminate RTD60: Rear Work Table - \$1,374, Specify LAW Alaska or LNB Nero Finish
- Rear table available on units that gang providing stability
- Rear table is mounted at 35.5"

1/2" Compact Matte Laminate Tablet

- FFD: 1/2" Compact Matte Laminate Tablet - \$622, Specify LAW Alaska or LNB Nero Finish
- Tablet is center mount only

Premium Finish Option (Standard White)

- Specify rear table bracket Metal Finish color - \$100 per unit
- Specify tablet Metal Finish color - \$100 per unit
- MFS: Silver, MFB: Black

Bota

45 Deg. Circlet - Double Seat High Back With Privacy Screen

45 Degree Back Inside Radius - High Back - 17.5" Privacy Screen

[Click here to view statement of line](#)

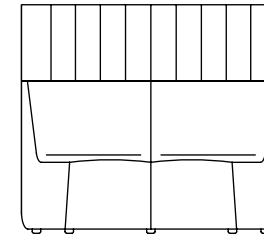

1 Model BOT0160HCH45

w" x d" x h"
60.25 x 28.5 x 53
Arm Height -
Seat Height 17.5
Inside Seat Depth 17
Inside Seat Width 29.5

COM	COL	1	2	3	4	5	6	7	8	9	10	11/L1	12	13/L2
5300	5573	5615	5770	5925	6080	6235	6390	6545	6700	6855	7010	7165	7320	7630

Upholstery Requirements
Fabric yds: 8.5 Leather Sq. Ft.: 153
Carton Weight: 119

2 Select Finish

[Click to view finishes](#)

NA

3 Combination Fabrics

[Click to view finishes](#)

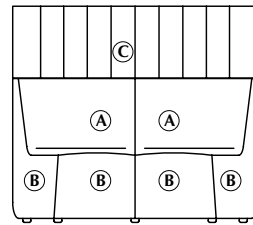

DARRAN is pleased to offer customers the design freedom of combination fabrics. When using fabric, vinyl or leather combinations, pricing/yardage requirements will be as follows:

A Inside Back & Seat 3 yds
B Lounge Exterior 7 yds
C Privacy Screen 5 yds

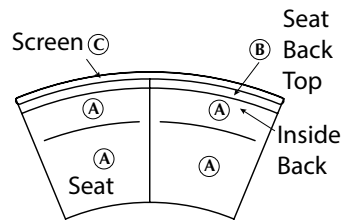

- When combining two materials of the same grade, pricing will be specified grade + 5%
- If combining two materials of different grades or leather/fabric combination, use the highest grade/price + 5%
- If using COM or COL, pricing will be COM or COL + 5%.
- If both COM + COL are used in combination, use COL + 5%.

Node Power Placement Option

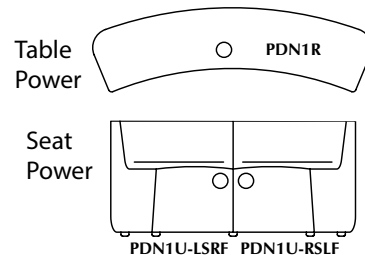

Product Features

- Horizontal back provides easy ganging capabilities.
- Utilizes elastic webbing suspension that conforms to individual's lumbar curvatures for adaptive support.
- Upholstered Privacy Screen
- Upholstered screens can be specified in contrasting fabrics, vinyl, or leathers.
- All units are standard with 1" adjustable glides that allow for leveling

Options

Ganging Device

- GDEV-L: Left Facing Ganging Device - \$20
- GDEV-R: Right Facing Ganging Device - \$20
- GDEV-C: Center Ganging Device - \$40

Power

- PDN1U-LSRF: Node in Left Seat Right Facing Seat Front; 1 Power/1 USB Charger - \$355
- PDN1U-RSLF: Node in Right Seat Left Facing Seat Front; 1 Power/1 USB Charger - \$355
- PDN1U-BC: Node in Both Left and Right Facing Center Seat Front; 1 Power/1 USB Charger per pod - \$709
- PDN1R: Node in Rear Mount Table Top; 1 Power/1 USB Charger - \$409
- Standard in White (Available in Silver and Black)

1/2" Compact Matte Laminate Rear Table

- Matte Laminate RTD60: Rear Work Table - \$1,374, Specify LAW Alaska or LNB Nero Finish
- Rear table available on units that gang providing stability
- Rear table is mounted at 35.5"

1/2" Compact Matte Laminate Tablet

- FFTD: 1/2" Compact Matte Laminate Tablet - \$622, Specify LAW Alaska or LNB Nero Finish
- Tablet is center mount only

Premium Finish Option (Standard White)

- Specify rear table bracket Metal Finish color - \$100 per unit
- Specify tablet Metal Finish color - \$100 per unit
- MFS: Silver, MFB: Black

Bota

Ottoman
19" Ottoman

[Click here to view statement of line](#)

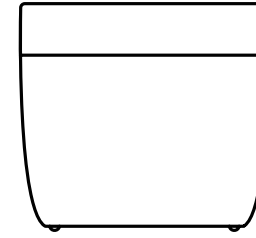

1 Model BOT0160SSO01

w" x d" x h"
19 x 19 x 17.5
Arm Height -
Seat Height 17.5
Inside Seat Depth 19
Inside Seat Width 19

COM	COL	1	2	3	4	5	6	7	8	9	10	11/L1	12	13/L2
889	924	963	999	1035	1071	1107	1143	1179	1215	1251	1287	1323	1359	1431

Upholstery Requirements
Fabric yds: 2 Leather Sq. Ft.: 36
Carton Weight: 23

Product Features

- 360 Degree sitting surface for wide range of uses
- Ottomans are standard with 1/4" nylon glides

Options

Compression Caster

- Caster compresses when weight is applied to ottoman.
- CST30: Caster - \$195

2 Select Finish

[Click to view finishes](#)

NA

3 Combination Fabrics

[Click to view finishes](#)

DARRAN is pleased to offer customers the design freedom of combination fabrics. When using fabric, vinyl or leather combinations, pricing/yardage requirements will be as follows:

A Seat 1 yd
B Base 2 yds

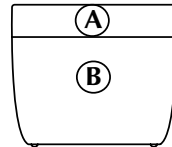

- When combining two materials of the same grade, pricing will be specified grade + 5%
- If combining two materials of different grades or leather/fabric combination, use the highest grade/price + 5%
- If using COM or COL, pricing will be COM or COL + 5%.
- If both COM + COL are used in combination, use COL + 5%.

Bota

Ottoman
48" Ottoman

[Click here to view statement of line](#)

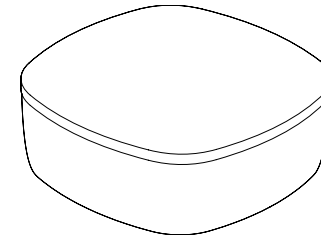

1 Model

BOT0160MSO04

w" x d" x h"
47.5 x 47.5 x 17.5
Arm Height n/a
Seat Height 17.5"
Inside Seat Depth 47.5"
Inside Seat Width 47.5"

COM	COL	1	2	3	4	5	6	7	8	9	10	11/L1	12	13/L2
2449	2531	2597	2670	2743	2816	2889	2962	3035	3108	3181	3254	3327	3400	3546

Upholstery Requirements
Fabric yds: 4 Leather Sq. Ft.: 72
Carton Weight: 75

Product Features

- 360 Degree sitting surface for wide range of uses
- Ottomans are standard with 1" adjustable glides

2 Select Finish

[Click to view finishes](#)

NA

3 Combination Fabrics

[Click to view finishes](#)

DARRAN is pleased to offer customers the design freedom of combination fabrics. When using fabric, vinyl or leather combinations, pricing/yardage requirements will be as follows:

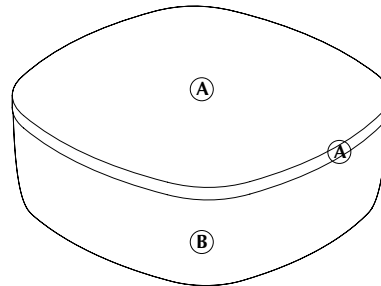

A Seat 2.75 yds
B Base 2.25 yds

Node Power Placement Option

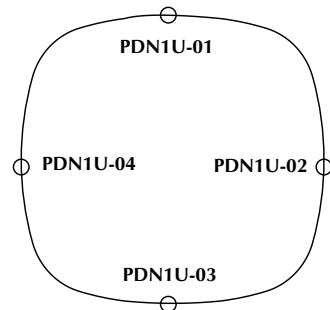

Top View

- When combining two materials of the same grade, pricing will be specified grade + 5%
- If combining two materials of different grades or leather/fabric combination, use the highest grade/price + 5%
- If using COM or COL, pricing will be COM or COL + 5%.
- If both COM + COL are used in combination, use COL + 5%.

Bota

Ottoman
70" Ottoman

[Click here to view statement of line](#)

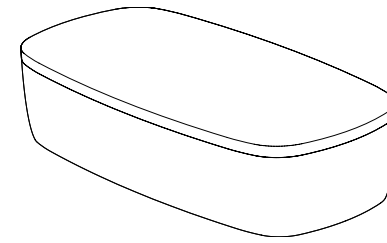

1 Model BOT0160MSO07

w" x d" x h"
71 x 35.5 x 17.5
Arm Height n/a
Seat Height 17.5"
Inside Seat Depth 35.5"
Inside Seat Width 71"

COM	COL	1	2	3	4	5	6	7	8	9	10	11/L1	12	13/L2
3436	3532	3612	3699	3786	3873	3960	4047	4134	4221	4308	4395	4482	4569	4743

Upholstery Requirements
Fabric yds: 4.75 Leather Sq. Ft.: 85.5
Carton Weight: 100

2 Select Finish

[Click to view finishes](#)

NA

3 Combination Fabrics

[Click to view finishes](#)

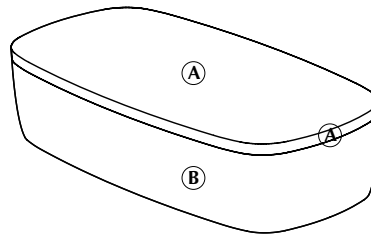

DARRAN is pleased to offer customers the design freedom of combination fabrics. When using fabric, vinyl or leather combinations, pricing/yardage requirements will be as follows:

A Seat 2.75 yds
B Base 2.5 yds

Node Power Placement Option

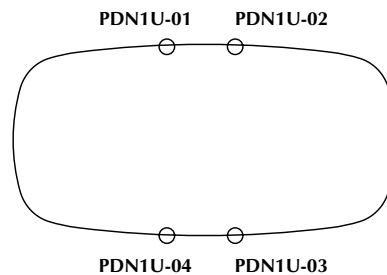

Top View

- When combining two materials of the same grade, pricing will be specified grade + 5%
- If combining two materials of different grades or leather/fabric combination, use the highest grade/price + 5%
- If using COM or COL, pricing will be COM or COL + 5%.
- If both COM + COL are used in combination, use COL + 5%.

Product Features

- 360 Degree sitting surface for wide range of uses
- Ottomans are standard with 1" adjustable glides

Options

Ottoman Power

- PDN1U-01: Node in top face; 1 power/1 USB charger - \$325
- PDN1U-02: Node in right face; 1 power/1 USB charger - \$325
- PDN1U-03: Node in bottom face; 1 power/1 USB charger - \$325
- PDN1U-04: Node in left face; 1 power/1 USB charger - \$325

Bota

Booth
4 Person Meeting Booth

[Click here to view statement of line](#)

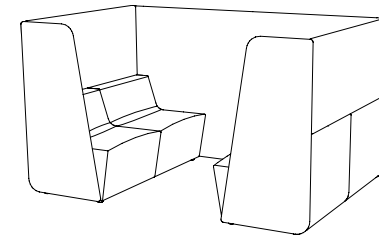

1 Model BOT0160BNT04

w" x d" x h"
95 x 63 x 53
Arm Height n/a
Seat Height 17.5"
Inside Seat Depth 17"
Inside Seat Width 29.5"

COM	COL	1	2	3	4	5	6	7	8	9	10	11/L1	12	13/L2
14425	14799	15350	15806	16262	16718	17174	17630	18086	18542	18998	19454	19910		21278

Upholstery Requirements
Fabric yds: 25 Leather Sq. Ft.: 450
Carton Weight: 300

2 Select Finish

[Click to view finishes](#)

NA

3 Combination Fabrics

[Click to view finishes](#)

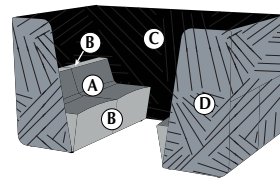

Top View

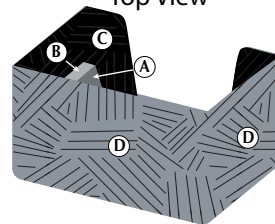

Node Power Placement Option

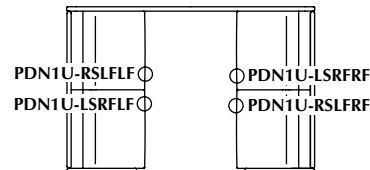

DARRAN is pleased to offer customers the design freedom of combination fabrics. When using fabric, vinyl or leather combinations, pricing/yardage requirements will be as follows:

- A Inside Back & Seat 5 yds
- B Lounge Top/Bottom Side 3 yds
- C Booth Wall Interior 8 yds
- D Booth Wall Exterior 10 yds

- When combining two materials of the same grade, pricing will be specified grade + 5%
- If combining two materials of different grades or leather/fabric combination, use the highest grade/price + 5%
- If using COM or COL, pricing will be COM or COL + 5%.
- If both COM + COL are used in combination, use COL + 5%.

Product Features

- Utilizes elastic webbing suspension that conforms to individual's lumbar curvatures for adaptive support
- Horizontal back provides easy ganging capabilities
- Upholstered screens can be specified in contrasting fabrics, vinyl or leather
- The upholstered wall is structured so that a TV up to 32" can be mounted on the inside or outside back wall of the booth
- Wire management channels are built into the wall to conceal cords
- All units are standard with 1" adjustable glides that allow for leveling

Notes

- Please consult customer service when specifying a table other than Bota to ensure adequacy of seat access

Options

Boards

- MBOC3421: 34" x 21" Marker board - \$440 ea.
- GBOC3421: 34" x 21" Glassboard - \$1098 ea.
- Specify location: interior, exterior, or both

Seat Power

- PDN1U-RSLFLF: Node in right facing seat front, left facing seat - \$387
- PDN1U-LSRFLF: Node in left facing seat front, left facing seat - \$355
- PDN1U-LSRFRF: Node in left facing seat front, right facing seat - \$355
- PDN1U-RSLFRF: Node in right facing seat front, right facing seat - \$355

TV Mount

- TM-1732: Fixed TV mount supports 17"- 32" TV - \$225
- Specify interior or exterior fixed TV mount location (2) TM71 black or TM70 white grommets included for TV wire entry and exit

Bota

Booth
6 Person Meeting Booth

[Click here to view statement of line](#)

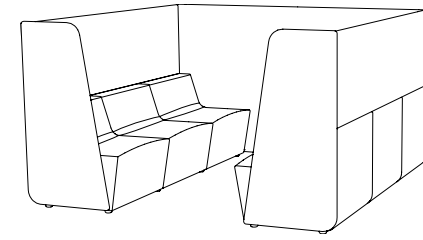

1 Model BOT0160BNT06

w" x d" x h"
95 x 91 x 53
Arm Height n/a
Seat Height 17.5"
Inside Seat Depth 17"
Inside Seat Width 29.5"

COM	COL	1	2	3	4	5	6	7	8	9	10	11/L1	12	13/L2
18653	19623	19837	20421	21005	21589	22173	22757	23341				25677	26261	

Upholstery Requirements
Fabric yds: 32 Leather Sq. Ft.: 576
Carton Weight: 450

2 Select Finish

[Click to view finishes](#)

NA

3 Combination Fabrics

[Click to view finishes](#)

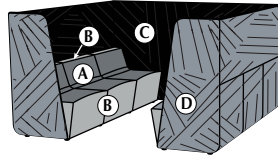

Top View

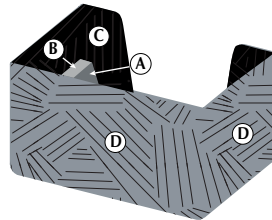

DARRAN is pleased to offer customers the design freedom of combination fabrics. When using fabric, vinyl or leather combinations, pricing/yardage requirements will be as follows:

- A Inside Back & Seat 7 yds
- B Lounge Top/Bottom Side 4 yds
- C Booth Wall Interior 9.5 yds
- D Booth Wall Exterior 12 yds

- When combining two materials of the same grade, pricing will be specified grade + 5%
- If combining two materials of different grades or leather/fabric combination, use the highest grade/price + 5%
- If using COM or COL, pricing will be COM or COL + 5%.
- If both COM + COL are used in combination, use COL + 5%.

Node Power Placement Option

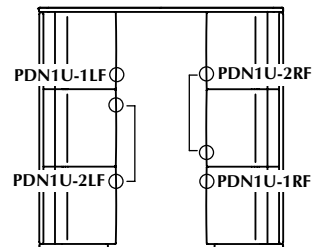

Product Features

- Utilizes elastic webbing suspension that conforms to individual's lumbar curvatures for adaptive support
- Horizontal back provides easy ganging capabilities
- Upholstered screens can be specified in contrasting fabrics, vinyl or leather
- The upholstered wall is structured so that a TV up to 32" can be mounted on the inside or outside back wall of the booth
- Wire management channels are built into the wall to conceal cords
- All units are standard with 1" adjustable glides that allow for leveling

Notes

- Please consult customer service when specifying a table other than Bota to ensure adequacy of seat access

Options

Boards

- MBOC3421: 34" x 21" Marker board - \$440 ea.
- GBOC3421: 34" x 21" Glassboard - \$1145 ea.
- Specify location: interior, exterior, or both

Seat Power

- PDN1U-1LF: Node is right facing seat front, left facing seat - \$355
- PDN1U-2LF: Node in left and center facing seat front, left facing seat - \$709
- PDN1U-1RF: Node in right facing seat front, right facing seat - \$355
- PDN1U-2RF: Node in left and center facing seat front, right facing seat - \$709

TV Mount

- TM-1732: Fixed TV mount supports 17"- 32" TV - \$225
- Specify interior or exterior fixed TV mount location (2) TM71 black or TM70 white grommets included for TV wire entry and exit

Bota

Booth Table
4 Person Meeting Booth Table

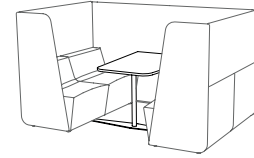

[Click here to view statement of line](#)

1 Select Model

w" x d" x h"
48 x 35 x 29

Weight
70

Standard Veneer Top White Metal Base	Premium Veneer Top White Metal Base	High Pressure Laminate Top White Metal Base	Thermally Fused Laminate Top White Metal Base
BOT4835MT500W 2115	BOT4835MT500P 2327	BOT4835MT500G 2115	BOT4835MT500M 1578

Product Features

- Table legs come standard in white (optional black or silver)

Options

Worksurface Clamp Mount Power

- PD-KENO-B: Keno power pod with clamp (includes 2 wire management grommets) - \$311 ea.
- Specify color and interior or exterior wire exit
- PD-TULLY-B: Tully power pod with clamp (includes 2 wire management grommets) - \$447 ea.
- Specify color and interior or exterior wire exit
- PD-TULLY-DATA: Tully data power pod with clamp (includes 2 wire management grommets) - \$436 ea.
- Specify color and interior or exterior wire exit

Premium Finish Option

- Specify base Metal Finish color - \$160 per base
- MFS: Silver, MFB: Black

2 Select Finish

[Click to view finishes](#)

WEC
WAM
WCM
WGW
WBW
WSW
WNW
WWP

WBO
WLO
WMO
WSO
TSTV
TSMV
TSLV

GEC
GAM
GCM
GSTV
GSLV
GNW
GWL

MEC
MGW
MTW
MSW
MWL

3 Select Edge

[Click to view edges](#)



Flat



Flat



Flat



Flat

4 Select Hardware

[Click to view details](#)

Hardware
N/A

Hardware
N/A

Hardware
N/A

Hardware
N/A

Bota

Booth Table
6 Person Meeting Booth Table

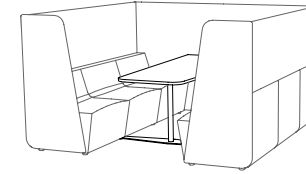

[Click here to view statement of line](#)

1 Select Model

w" x d" x h"
78 x 35 x 29

Weight
95

Standard Veneer Top White Metal Base	Premium Veneer Top White Metal Base	High Pressure Laminate Top White Metal Base	Thermally Fused Laminate Top White Metal Base
BOT7835MT500W 2961	BOT7835MT500P 3259	BOT7835MT500G 2961	BOT7835MT500M 2022

Product Features

- Table legs come standard in white (optional black or silver)

2 Select Finish

[Click to view finishes](#)

WEC
WAM
WCM
WGW
WBW
WSW
WNW
WWP

WBO
WLO
WMO
WSO
TSTV
TSMV
TSLV

GEC
GAM
GCM
GSTV
GSLV
GNW
GWL

MEC
MGW
MTW
MSW
MWL

3 Select Edge

[Click to view edges](#)



4 Select Hardware

[Click to view details](#)

Hardware
N/A

Hardware
N/A

Hardware
N/A

Hardware
N/A

Options

Worksurface Clamp Mount Power

- PD-KENO-B: Keno power pod with clamp (includes 2 wire management grommets) - \$311 ea.
- Specify color and interior or exterior wire exit
- PD-TULLY-B: Tully power pod with clamp (includes 2 wire management grommets) - \$447 ea.
- Specify color and interior or exterior wire exit
- PD-TULLY-DATA: Tully data power pod with clamp (includes 2 wire management grommets) - \$436 ea.
- Specify color and interior or exterior wire exit

Premium Finish Option

- Specify base Metal Finish color - \$160 per base
- MFS: Silver, MFB: Black

Bota

Freestanding Table
Freestanding Table



[Click here to view statement of line](#)

1 Select Model

w" x d" x h"
12.5 x 13.75 x 24.5

Weight
15

Standard Veneer Top Black Metal Base		1/2" Compact Laminate Top Black Metal Base	
BOT0160FST01W	863	BOT0160FST01M	835
		LAW LNB	
		Edge N/A	
		Hardware N/A	

Product Features

- Standard Black Base (optional White, Silver)

Options

Premium Finish Option

- Specify base Metal Finish color - \$160 per base
- MFW: White, MFS: Silver

2 Select Finish

[Click to view finishes](#)

WEC	WWW
WAM	TSTV
WCM	TSMV
WGW	TSLV
WBW	
WSW	
WNW	
WWP	
WLO	
WMO	
WSO	

3 Select Edge

[Click to view edges](#)

Edge
N/A

4 Select Hardware

[Click to view details](#)

Hardware
N/A

Bota

Coat Stand

Wire Coat Stand

[Click here to view statement of line](#)



1 Select Model

w" x d" x h"
20.25 x 18.5 x 67

Weight

25

Black Metal Coat Stand

BOT0160WCS01 1168

Product Features

- Standard Black Finish

2 Select Finish

[Click to view finishes](#)

MFB

3 Select Edge

[Click to view edges](#)

Edge
N/A

4 Select Hardware

[Click to view details](#)

Hardware
N/A

Keno power unit

Style Number	List Price
 PD-KENO-B	\$311

Specifications

- > Size 5.5"L x 2.125"W x 2.5"H
- > 2 TR AC Outlets
- > 14.2A USB module w/ 2 charging ports
- > 10' Power cord
- > Includes 2 wire management grommets

Available: Bota booth table



White



Black

Node power unit

Style Number List Price



STARTER UNITS

PDN1U PLUG \$325

Includes (1) node unit with plug infeed - includes 72" cord
*See pod placement options below

Specifications

- > Size: 4"Dia
- > (1) 15 Amp Receptacles and (1) USB duplex
- > Surface Mount
- > Standard White Finish, Available in Black or Silver Finish upon request
- > UL Approved

Available: Bota



Node Power Placement

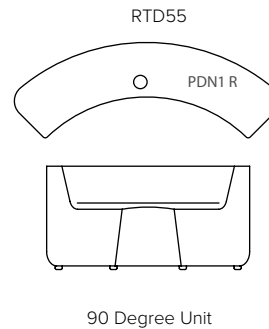
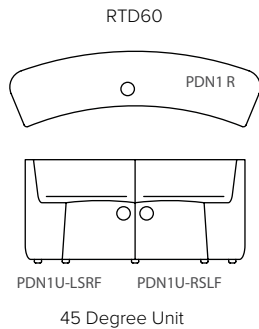
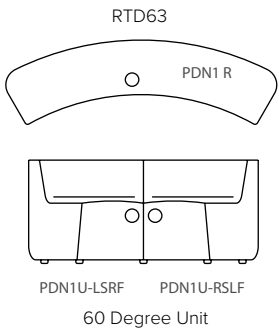
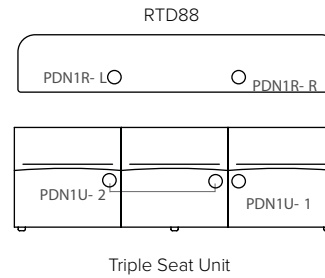
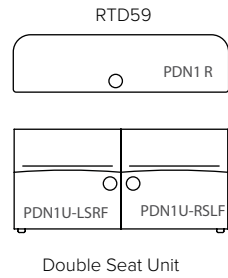
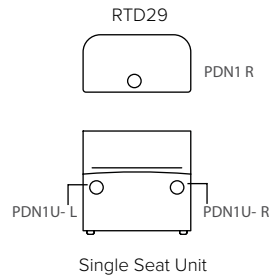

DARRAN®



Babble Price List

Effective November 1, 2022

Date	Page	Modification	Description
11.09.22		Price Increase	9% price increase applied to all items
06.20.23		Added WWW Weathered Walnut finish	
06.20.23		Added WLO Lofty Oak finish	

Seating Specification1
Finishes2
Seating.....3

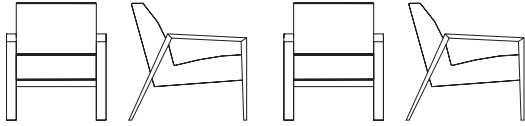

Page 3
Lounge Chair
Lounge Chair - Maple Arms

Page 4
Lounge Chair
Lounge Chair - Walnut Arms

DARRAN®

Width = 27-1/2"
Depth = 30-1/2"
Height = 31"
Seat Width = 22"
Seat Depth = 21"
Seat Height = 17-1/2"
Arm Height = 24"
Cartoned Weight = 46 lbs.

Frame constructed of CNC cut engineered hardwood to maximize the strength, precise measurements and overall longevity.

Designed with clean lines, sweeping back and top stitch throughout.

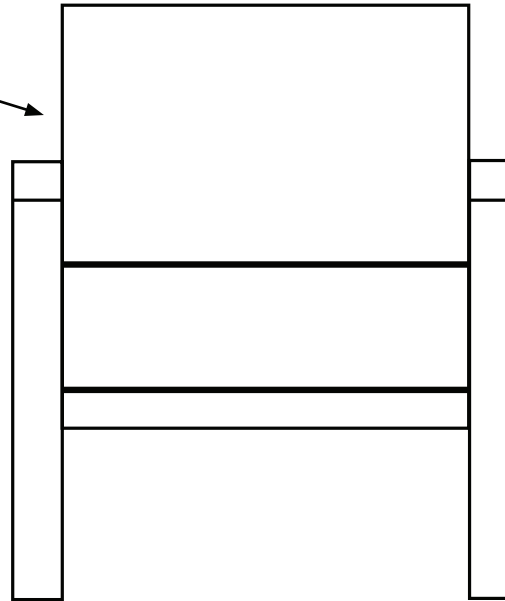

Solid wood arms slope forward for maximum comfort.

Variety of textiles and back options offer customers flexibility in design and consistency within each office setting.

Joints

Joints are securely fastened with mortise and tenon joinery or double doweled construction to ensure long-term use.

Seat suspension

Seat suspension is constructed of 3/4" thick top quality Baltic Birch plywood that is machined to form an open perimeter of rounded inside edges to reduce strain on the seat suspension. Seats are webbed to provide maximum support for seat cushions. Seat cushions are made of high resiliency foam with proper density providing comfort.

Seat assembly

Seat assembly is attached within finger grooved corner blocks and further secured by wood cleats, providing a vast superior means of stability in the chair.

DARRAN®

Finishes are available on maple or walnut wood (for arms)

Babble Finishes

Babble Maple Arm Finishes

WAC Amber Cherry
WIC Crimson Cherry
WHC Honey Cherry
WOC KoKo Cherry
WAM Alabaster Maple
WCM Clear Maple
WLO Lofty Oak
WNO Natural Oak
TBCO Baby's Cheek
SSM Seattle Mist Paint
SSL Skyline Walnut Paint
WWP Designer White Paint
PM01 Olive
PM02 Aquarvert
PM03 Mushroom
PM07 Pebble
PM08 Vapour
PM10 Verde

Babble Walnut Arm Finishes

WOW Clear Walnut
WEW Executive Walnut
WGW Gunstock Walnut
WBW Henna Walnut
WNW Natural Walnut
WSW Smokey Walnut
WWW Weathered Walnut
TBSW Brown Sugar
TOBW Organic Brown
TSTV Studio Teak Walnut

Send 3x3 or larger finish chip for color match.
Custom finish upcharge is 3% or \$250 Net (whichever is greater).



Finish

Welltech Finish delivers a superior furniture coating with exceptional performance that can withstand stringent cleaning agents and possesses unparalleled durability, allowing DARRAN to provide lasting, sustainable products to our customers.

Babble

Lounge Chair
Lounge Chair - Maple Arms

[Click here to view statement of line](#)

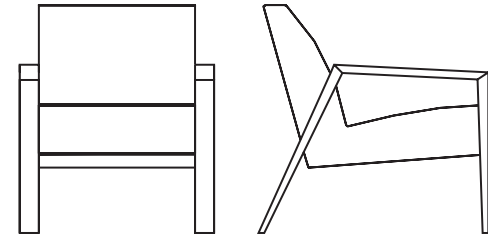

1 Model BAB0110DAC01M

COM	COL	1	2	3	4	5	6	7	8	9	10	11/L1	12	13/L2
1828	1888	1920	1966	2012	2058	2104	2150	2196	2242	2288	2334	2380	2426	2518

w" x d" x h"
27.5 x 30.5 x 31
Arm Height 24"
Seat Height 17 -1/2"
Inside Seat Depth 20 -3/4"
Inside Seat Width 22"

Upholstery Requirements
Fabric yds: 2 -1/2" Leather Sq. Ft.: 45
Carton Weight: 46

Product Features

- Frame constructed of CNC cut engineered hardwood to maximize the strength, precise measurements and overall longevity
- Solid wood arms slope forward for maximum comfort

2 Select Finish

[Click to view finishes](#)

- WAC Amber Cherry
- WIC Crimson Cherry
- WHC Honey Cherry
- WOC KoKo Cherry
- WEC Ebony
- WAM Alabaster Maple
- WCM Clear Maple
- WLO Lofty Oak
- TBCO Baby's Cheek
- SSM Seattle Mist Paint
- SSL Skyline Walnut Paint
- WWP Designer White Paint
- PM01 Olive
- PM02 Aquavert
- PM03 Mushroom
- PM07 Pebble
- PM08 Vapour
- PM09 Copper
- PM10 Verde
- SNA Narvik Ash

3 Combination Fabrics

[Click to view finishes](#)

Combination
Fabric Option
Not Available

Babble

Lounge Chair

Lounge Chair - Walnut Arms

[Click here to view statement of line](#)

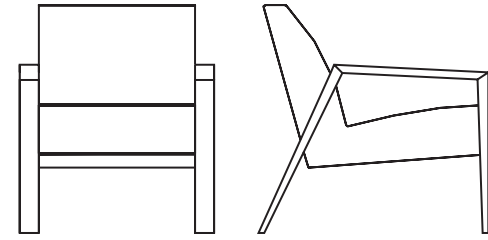

1 Model

BAB0110DAC01W

w" x d" x h"
 27.5 x 30.5 x 31
 Arm Height 24"
 Seat Height 17 -1/2"
 Inside Seat Depth 20 -3/4"
 Inside Seat Width 22"

COM	COL	1	2	3	4	5	6	7	8	9	10	11/L1	12	13/L2
2151	2211	2243	2289	2335	2381	2427	2473	2519	2565	2611	2657	2703	2749	2841

Upholstery Requirements
 Fabric yds: 2 -1/2" Leather Sq. Ft.: 45
 Carton Weight: 46

Product Features

- Frame constructed of CNC cut engineered hardwood to maximize the strength, precise measurements and overall longevity
- Solid wood arms slope forward for maximum comfort

2 Select Finish

[Click to view finishes](#)

- WOW Clear Walnut
- WEW Executive Walnut
- WGW Gunstock Walnut
- WBW Henna Walnut
- WNW Natural Walnut
- WSW Smokey Walnut
- WWW Weathered Walnut
- TBSW Brown Sugar
- TSTV Studio Teak Walnut
- TOBW Organic Brown

3 Combination Fabrics

[Click to view finishes](#)

Combination
 Fabric Option
 Not Available



Covet Price List

Effective November 1, 2022

Designed By Michael Shields

Date	Page	Modification	Description
11.10.22		Price Increase	9% price increase applied to all items excluding options

Fabric seat & leather program.....1
Seating Specification4
Finishes5
Executive Chair6

Statement of Line

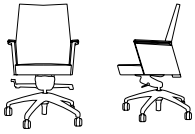

Page 6
Upholstered Arms
Mid-Back

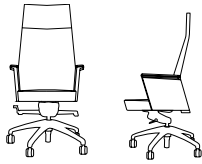

Page 7
Upholstered Arms
High-Back

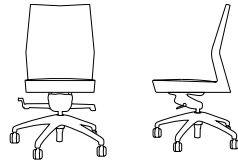

Page 8
Armless
Mid-Back

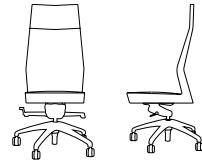

Page 9
Armless
High-Back

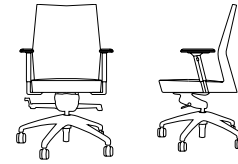

Page 10
Adjustable Ergonomic Arms
Mid-Back

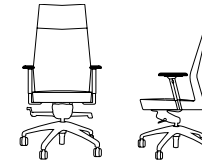

Page 11
Adjustable Ergonomic Arms
High-Back

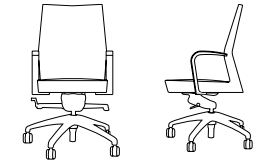

Page 12
Metal "C" Arms
Mid-Back



Page 13
Metal "C" Arms
High-Back

Seating & fabric leather program

DARRAN has partnered with some of the most prestigious fabric suppliers of the office furniture industry to bring you quality fabrics that are engaging designs, environmentally friendly and durable for years to come. The majority of fabrics we have graded-in are in heavy supply making it most likely available on our Quickship however, we cannot guarantee stock. If you do not see the fabric you wish to include in a project, please contact our Factory to see if this pattern can be graded in at 800.334.7891.

Fabrics & Leathers

Please visit our Seating Fabrics page at darran.com/textilesleather

Camira
www.camirafabrics.com
 800.334.789

Wollsdorf
www.wollsdorf.com
 336.884.5005

CFStinson
www.cfstinson.com
 800.841.6279

Green Hides
www.greenhides.com
 336.315.9720

DesignTex
www.designtex.com
 800.797.4949

Maharam
www.maharam.com
 800.645.3943

Momentum Textiles
www.momentumtextiles.com
 800.366.6839

Ultrafabrics
www.ultrafabricsinc.com
 800.334.7891

Application instructions must be specified on the purchase order or COM / COL submission form. In the absence of application instructions, DARRAN will apply materials accordingly.

CAL117

All DARRAN seating products conform to California Technical Bulletin 117 as a minimum standard.

CAL133

To meet the California Technical Bulletin 133 flammability regulation, a combination of proper materials must be used to pass, as it tests the fire resistance of a finished product. Flame resistant fabric, a fire blocker material and special foam must be used to pass CAL133 fire codes.

Testing is available for all seating products with the following fees and considerations:

- If laboratory certification is not required, any style can be manufactured to comply with California Technical Bulletin 133 for \$75 list per yard required. (Customer's Own Materials must factor in additional yardage requirements based on repeat.)
- The purchase order must clearly indicate the requirement of California Technical Bulletin 133
- If laboratory California Technical Bulletin 133 certification is required, the cost of testing a chair is \$820 NET, plus the cost of the chair and covering material.
- An additional lead time of 4 to 6 weeks is required for testing for CAL133.
- Once testing is completed, we will provide a certification letter specific to the sample tested for CAL133.
- DARRAN's manufacturing procedures for California TB 133 compliance are based on the testing of representative style with specific fabrics. Please contact Customer Service for an updated list of tested models.
- A copy of test certification is available upon request.W

Combination fabrics

DARRAN is pleased to offer customers the design freedom of combination fabrics. When using fabric, vinyl or leather combinations, pricing will be as follows:

- When combining two materials of the same grade, pricing will be specified grade + 5%.
- If combining two materials of different grades or leather/ fabric combination, use the highest grade/price + 5%.
- If using COM or COL, pricing will be COM or COL + 5%. If both COM + COL are used in combination, use COL + 5%

COM/COL ordering instructions

Please complete the COM Submission Form prior to ordering the fabric from the supplier. All COM fabrics must be approved prior to order submission. Please refer to our website or contact DARRAN Seating Customer Service for an updated list of preapproved COM fabrics. Application instructions must be specified on the purchase order or COM/COL submission form. In the absence of application instructions, DARRAN will apply materials in the best manner and cannot be held responsible for tailoring or application objections after upholstery. COM orders will be scheduled for production after receipt of the material. Packages must be clearly marked and the fabric must be first quality, continuous yardage.

COM/COL yardage requirements

The yardage requirements stated in this price list for each style are calculated using 54" wide, non-directional fabrics. For fabrics with a different width or for patterns with repeats, please refer to the below chart to calculate the additional percent of fabric required:

Fabric Width	Plain Fabric	2" - 14" Repeat	15" - 19" Repeat	20" - 27" Repeat	28" - 36" Repeat
54"	0	15%	20%	25%	30%
53"	6%	19%	24%	28%	36%
52"	13%	23%	28%	33%	38%
51"	19%	26%	31%	36%	41%
50"	25%	30%	35%	40%	45%
49"	30%	35%	40%	45%	50%
48"	35%	40%	45%	50%	55%
47"	45%	50%	55%	58%	65%

DARRAN®

Covet Seating Fabric & Leather Program

NOTE: Prior To Completion Of This Form, Please Refer To Our Graded In Materials Program For Preapproved Fabrics/Leathers.

COM/COL Approval

DARRAN Furniture Industries
2402 Shore Street, High Point, NC 27263
ATTN: Seating Division / COM/COL Approval
TAG: DARRAN Purchase Order Number

Shipping approved COM/COL materials

DARRAN Furniture Industries
2402 Shore Street, High Point, NC 27263
ATTN: Seating Division / COM/COL Approval
TAG: DARRAN Purchase Order Number

Please complete this form, attach a 6"x 6" sample and mail to the COM/COL APPROVAL address shown above.
This form can also be downloaded from our website at www.darran.com/leathers OR www.darran.com/fabrics

Purchase Order # _____

Dealer's Name _____

Contact _____

Address _____

Telephone _____

Email _____

Chair Style _____

Manufacturer _____

Pattern Name _____

Pattern Color _____

Content _____

Repeat _____

Please specify any special requirements and check the application above.

ATTACH 6" X 6" FABRIC/LEATHER SAMPLE HERE

NOTE
Actual Fabric/Leather samples needed instead of digital images. If digital images are sent in lieu of samples, DARRAN will only verify the pattern and will not take responsibility for color variances that cannot be verified due to printing restrictions

In the absence of application instructions, DARRAN will apply the material in the best manner and cannot be held responsible for tailoring or application objections after upholstering.

Unless otherwise instructed on the purchase order, excess COM materials will be recycled at the discretion of DARRAN after six months of the original product ship date.

The COM approval solely pertains to the application of the fabric onto the specified DARRAN seating product. DARRAN's approval or acceptance does not constitute any responsibility or warranty to the overall appearance, durability, flammability, defects, dye lot variations or colorfastness of the COM. It is the customer's responsibility to ensure the COM meets CAL 117 compliance and are first quality continuous goods.

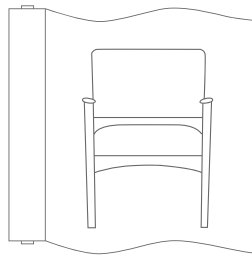

RAILROAD

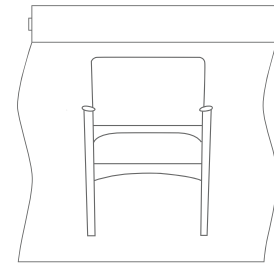

SETUP

DARRAN®

Width = 25-3/4"
 Depth = 23-1/2"
 Height = 47-1/2" - 50-1/2"
 Seat Width = 20-1/2"
 Seat Depth = 19"
 Seat Height = 19" - 22"
 Arm Height = 26" - 29"

Frame Construction: Hardwood
 Plywood components are precision cut on CNC routers and feature interlocking tab joinery for superior strength and long term durability. All joints are assembled utilizing glue and steel fasteners.

Cushioning: Back utilizes an elastic sheet webbing suspension that conforms to individual's lumbar curvatures for adaptive support. Cushioning materials are laminations or CAL117 rated high-density polyurethane foams of varying compression rates, providing durability and long terms comfort.

Upholstered Arms: Upholstered panel arms features caps which can be specified in constraasting fabrics, vinyls or leathers. Optional wood arm caps are also available in any DARRAN finish. Welting between cap and arm can also be specified in contrasting upholstery materials.

Covet Seating Specification

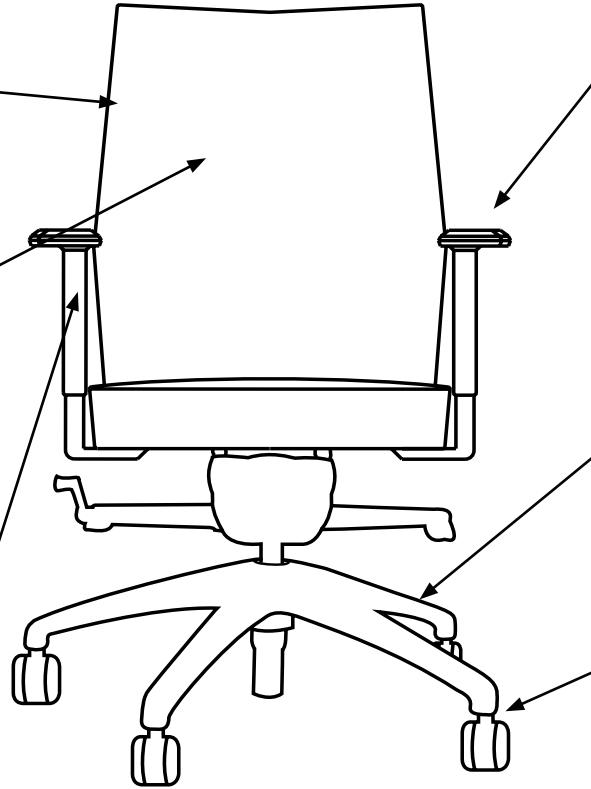

Adjustable Ergonomic Arms:
 Available in either T-Polished Aluminum or T-Nylon Black this multi-functional telescoping arm features height, depth, and pivot adjustability. Activated by a button trigger, it provides 4" of vertical adjustment to help relieve upper back and shoulder fatigue. 3" of front to back friction - activated depth adjustment allows users to get closer to their work surface while maintaining effective use of the backrest. The 30 degree inward / outward pivot provides proper forearm support for various tasks such as keying and mousing.

Bases: 26" diameter, available in Polished Aluminum (Standard), Black or Wood.

Casters: 60mm diameter wheels are standard and promote increased mobility.

Carpet casters are standard. For hard floor surfaces specify CST20 - no upcharge.



Adjustable Arms
 Mid or High-Back

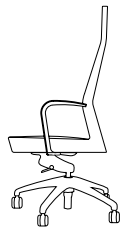

Metal "C" Arms
 Mid or High-Back

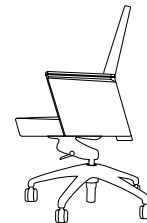

Upholstered Arms
 Mid or High-Back



Armless
 Mid or High-Back

Covet's slim, chiseled, profile compliments DARRAN's contemporary and transitional casegoods and conference room offerings. Finely tailored upholstery featuring elegant top stitch detailing provides a quality image while accommodating "real world" budgets. A family of models is offered, appropriate for Executive private offices, conference rooms, or open plan environments. A high level of detail provides 360° visual interest, especially important in conference room applications. Variety of textiles and back options offer customers flexibility in design and consistency within each office setting.

Knee-tilt swivel mechanism

The standard Knee-tilt mechanism features an advanced forward pivot point that reduces leg lift with a 16 degree seat angle and a 25 degree back angle tilt. The mechanism locks in task and reclined positions with side tensions adjustment. Heigh adjustment and tilt tension are also provided.

DARRAN®

Covet Finishes

Finishes for arms or wood base only

WLA Lofty Ash
WAC Amber Cherry
WIC Crimson Cherry
WHC Honey Cherry
WOC KoKo Cherry
WAM Alabaster Maple
WCM Clear Maple
WMO Mocha Oak
WNO Natural Oak
WSO Salted Oak
WEW Executive Walnut
WGW Gunstock Walnut
WBW Henna Walnut
WNW Natural Walnut
TBCO Baby's Cheek
TBSW Brown Sugar
TSTV Studio Teak Walnut
SSM Seattle Mist Paint
SSL Skyline Walnut Paint
TOBW Organic Brown
WWP Designer White Paint

Send 3x3 or larger finish chip for color match. Custom finish upcharge is 3% or \$250 Net (whichever is greater).



Finish

Welltech Finish delivers a superior furniture coating with exceptional performance that can withstand stringent cleaning agents and possesses unparalleled durability, allowing DARRAN to provide lasting, sustainable products to our customers.

Covet

Upholstered Arms
Mid-Back

[Click here to view statement of line](#)

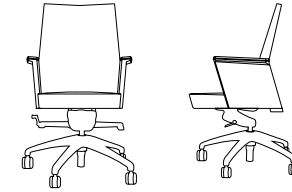

1 Model COV9725UAM04

w" x d" x h"
25.75 x 23.5 x 40-42.75
Arm Height 26" -29"
Seat Height 19" - 22"
Inside Seat Depth 19"
Inside Seat Width 20 -1/2"

COM	COL	1	2	3	4	5	6	7	8	9	10	11/L1	12	13/L2
2413	2491	2524	2579	2634	2689	2744	2799	2854	2909	2964	3019	3074	3129	3239

Upholstery Requirements
Fabric yds: 3 Leather Sq. Ft.: 60
Carton Weight: 55

2 Select Finish

[Click to view finishes](#)

Finishes N/A

3 Combination Fabrics

[Click to view finishes](#)

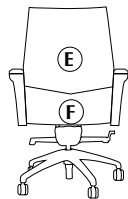
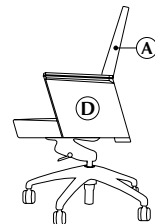
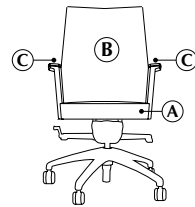

DARRAN is pleased to offer customers the design freedom of combination fabrics. When using fabric, vinyl or leather combinations, pricing/yardage requirements will be as follows:

- A Seat/Sides 1 yd(s).
- B Inside Back .75 yd(s).
- C Arms Caps .5 yd(s).
- D Arms .75 yd(s).
- E Upper Outside Back .75 yd(s).

- When combining two materials of the same grade, pricing will be specified grade + 5%
- If combining two materials of different grades or leather/fabric combination, use the highest grade/price + 5%
- If using COM or COL, pricing will be COM or COL + 5%.
- If both COM + COL are used in combination, use COL + 5%.

Product Features

- 26" diameter polished aluminum base
- Back utilizes an elastic sheet webbing suspension that conforms to individual's lumbar curvatures for adaptive support.
- Knee Tilt Swivel w/ forward pivot point
- Large 60mm diameter casters are standard and promote increased mobility.
- Plywood components feature interlocking tab joinery for superior strength and long term durability.
- Upholstered panel arms feature caps which can be specified in contrasting fabrics, vinyl, or leathers.

Options

Wood Arm Cap

- AOW: Wood Arm Caps - \$100

Base Options

- BBPC: Black Base - \$95
- BOW: Wood Base- \$170

Covet

Upholstered Arms
High-Back

[Click here to view statement of line](#)

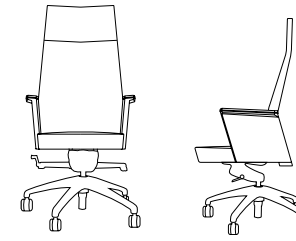

1 Model COV9725UAH05

w" x d" x h"
25-34 x 23.5 x 50.5-53
Arm Height 26" - 29"
Seat Height 19" - 22"
Inside Seat Depth 19"
Inside Seat Width 20 -1/2"

COM	COL	1	2	3	4	5	6	7	8	9	10	11/L1	12	13/L2
2540	2621	2670	2734	2798	2862	2926	2990	3054	3118	3182	3246	3310	3374	3502

Upholstery Requirements
Fabric yds: 3.5 Leather Sq. Ft.: 70
Carton Weight: 60

2 Select Finish

[Click to view finishes](#)

Finishes N/A

3 Combination Fabrics

[Click to view finishes](#)

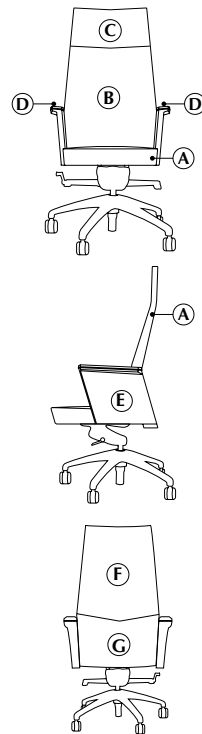

DARRAN is pleased to offer customers the design freedom of combination fabrics. When using fabric, vinyl or leather combinations, pricing/yardage requirements will be as follows:

- A Seat/Sides 1 yd(s).
- B Lower Inside Back .75 yd(s).
- C Upper Inside Back 0.75 yd(s).
- D Arm Cap .5 yd(s).
- E Arms .75 yd(s).

- When combining two materials of the same grade, pricing will be specified grade + 5%
- If combining two materials of different grades or leather/fabric combination, use the highest grade/price + 5%
- If using COM or COL, pricing will be COM or COL + 5%.
- If both COM + COL are used in combination, use COL + 5%.

Product Features

- 26" diameter polished aluminum base
- Back utilizes an elastic sheet webbing suspension that conforms to individual's lumbar curvatures for adaptive support.
- Knee Tilt Swivel w/ forward pivot point
- Large 60mm diameter casters are standard and promote increased mobility.
- Plywood components feature interlocking tab joinery for superior strength and long term durability.
- Upholstered panel arms feature caps which can be specified in contrasting fabrics, vinyl, or leathers.

Options

Wood Arm Cap

- AOW: Wood Arm Caps - \$100

Base Options

- BBPC: Black Base - \$95
- BOW: Wood Base- \$170

Covet

Armless
Mid-Back

[Click here to view statement of line](#)

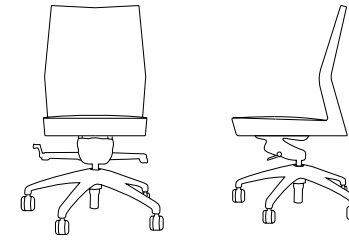

1 Model COV9725NAM00

w" x d" x h"
20.5 x 23.5 x 40-42.75
Arm Height N/A
Seat Height 19" - 22"
Inside Seat Depth 19"
Inside Seat Width 20 -1/2"

COM	COL	1	2	3	4	5	6	7	8	9	10	11/L1	12	13/L2
1887	1942	1980	2026	2072	2118	2164	2210	2256	2302	2348	2394	2440	2486	2578

Upholstery Requirements
Fabric yds: 2.5 Leather Sq. Ft.: 50
Carton Weight: 50

Product Features

- 26" diameter polished aluminum base
- Back utilizes an elastic sheet webbing suspension that conforms to individual's lumbar curvatures for adaptive support.
- Knee Tilt Swivel w/ forward pivot point
- Large 60mm diameter casters are standard and promote increased mobility.
- Plywood components feature interlocking tab joinery for superior strength and long term durability.

2 Select Finish

[Click to view finishes](#)

Finishes N/A

3 Combination Fabrics

[Click to view finishes](#)

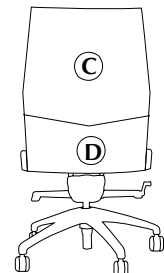
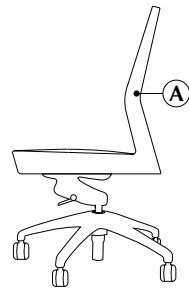
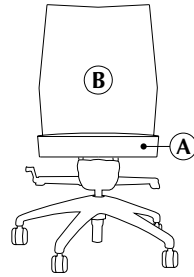

DARRAN is pleased to offer customers the design freedom of combination fabrics. When using fabric, vinyl or leather combinations, pricing/yardage requirements will be as follows:

- A Seat/Sides 1 yd(s).
- B Inside Back .75 yd(s).
- C Upper Outside Back .75 yd(s).
- D Lower Outside Back .75 yd(s).

- When combining two materials of the same grade, pricing will be specified grade + 5%
- If combining two materials of different grades or leather/fabric combination, use the highest grade/price + 5%
- If using COM or COL, pricing will be COM or COL + 5%.
- If both COM + COL are used in combination, use COL + 5%.

Options

Base

- BBPC: Black Base - \$95
- BOW: Wood Base- \$170

Covet

Armless
High-Back

[Click here to view statement of line](#)

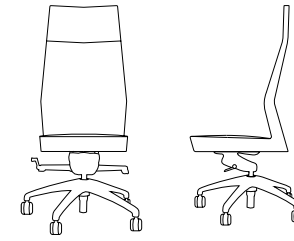

1 Model COV9725NAH01

w" x d" x h"
20.5 x 23.5 x 50.5-53
Arm Height N/A
Seat Height 19" - 22"
Inside Seat Depth 19"
Inside Seat Width 20 -1/2"

COM	COL	1	2	3	4	5	6	7	8	9	10	11/L1	12	13/L2
2014	2072	2125	2180	2235	2290	2345	2400	2455	2510	2565	2620	2675	2730	2840

Upholstery Requirements
Fabric yds: 3 Leather Sq. Ft.: 60
Carton Weight: 55

2 Select Finish

[Click to view finishes](#)

Finishes N/A

3 Combination Fabrics

[Click to view finishes](#)

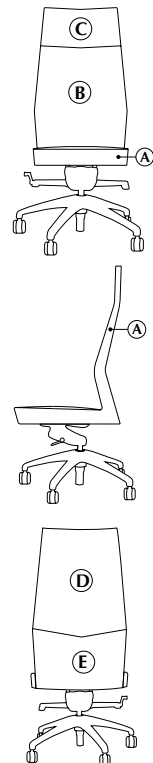

DARRAN is pleased to offer customers the design freedom of combination fabrics. When using fabric, vinyl or leather combinations, pricing/yardage requirements will be as follows:

- A Seat/Sides 1 yd(s).
- B Lower Inside Back .75 yd(s).
- C Upper Inside Back .5 yd(s).
- D Upper Outside Back .75 yd(s).
- E Lower Outside Back .75 yd(s).

- When combining two materials of the same grade, pricing will be specified grade + 5%
- If combining two materials of different grades or leather/fabric combination, use the highest grade/price + 5%
- If using COM or COL, pricing will be COM or COL + 5%.
- If both COM + COL are used in combination, use COL + 5%.

Product Features

- 26" diameter polished aluminum base
- Back utilizes an elastic sheet webbing suspension that conforms to individual's lumbar curvatures for adaptive support.
- Knee Tilt Swivel w/ forward pivot point
- Large 60mm diameter casters are standard and promote increased mobility.
- Plywood components feature interlocking tab joinery for superior strength and long term durability.

Options

Base

- BBPC: Black Base - \$95
- BOW: Wood Base - \$170

Covet

Adjustable Ergonomic Arms
Mid-Back

[Click here to view statement of line](#)

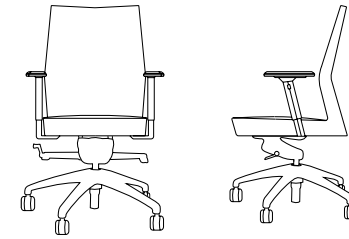

1 Model COV9725AAM02

w" x d" x h"
27.5 x 23.5 x 40-42.75
Arm Height 26" - 29"
Seat Height 19" - 22"
Inside Seat Depth 19"
Inside Seat Width 20 -1/2"

COM	COL	1	2	3	4	5	6	7	8	9	10	11/L1	12	13/L2
2189	2244	2282	2328	2374	2420	2466	2512	2558	2604	2650	2696	2742	2788	2880

Upholstery Requirements
Fabric yds: 2.5 Leather Sq. Ft.: 50
Carton Weight: 55

2 Select Finish

[Click to view finishes](#)

Finishes N/A

3 Combination Fabrics

[Click to view finishes](#)

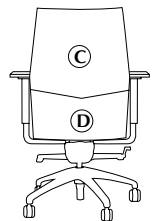
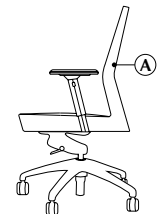
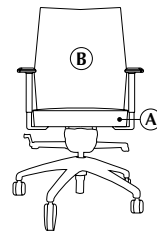

DARRAN is pleased to offer customers the design freedom of combination fabrics. When using fabric, vinyl or leather combinations, pricing/yardage requirements will be as follows:

- A Seat/Sides 1 yd(s).
- B Inside Back .75 yd(s).
- C Upper Outside Back .75 yd(s).
- D Lower Outside Back .75 yd(s).

- When combining two materials of the same grade, pricing will be specified grade + 5%
- If combining two materials of different grades or leather/fabric combination, use the highest grade/price + 5%
- If using COM or COL, pricing will be COM or COL + 5%.
- If both COM + COL are used in combination, use COL + 5%.

Product Features

- 26" diameter polished aluminum base
- Back utilizes an elastic sheet webbing suspension that conforms to individual's lumbar curvatures for adaptive support.
- Back adjustable ergonomic arms are available with spring loaded height adjustment and button activation. Arms are angles at 15 degrees with an adjustable arm pad for additional comfort and support. Arm adjusts 3- 1/4" in height and 1-1/2" in width
- Knee Tilt Swivel w/ forward pivot point
- Large 60mm diameter casters are standard and promote increased mobility.
- Plywood components feature interlocking tab joinery for superior strength and long term durability.

Options

Base

- BBPC: Black Base - \$95
- BOW: Wood Base- \$170

Covet

Adjustable Ergonomic Arms
High-Back

[Click here to view statement of line](#)

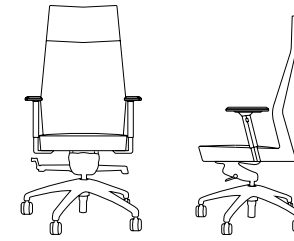

1 Model COV9725AAH03

w" x d" x h"
27.5 x 23.5 x 50.5-53
Arm Height 26" - 29"
Seat Height 19" - 22"
Inside Seat Depth 19"
Inside Seat Width 20 -1/2"

COM	COL	1	2	3	4	5	6	7	8	9	10	11/L1	12	13/L2
2315	2373	2426	2481	2536	2591	2646	2701	2756	2811	2866	2921	2976	3031	3141

Upholstery Requirements
Fabric yds: 3 Leather Sq. Ft.: 60
Carton Weight: 60

2 Select Finish

[Click to view finishes](#)

Finishes N/A

3 Combination Fabrics

[Click to view finishes](#)

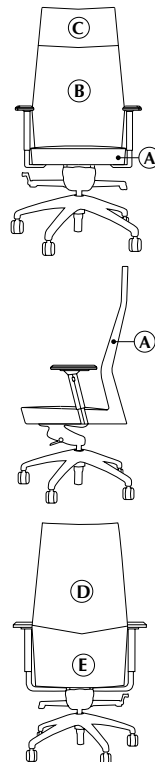

DARRAN is pleased to offer customers the design freedom of combination fabrics. When using fabric, vinyl or leather combinations, pricing/yardage requirements will be as follows:

- A Seat/Sides 1 yd(s).
- B Lower Inside Back .75 yd(s).
- C Upper Inside Back .5 yd(s).
- D Upper Outside Back .75 yd(s).
- E Lower Outside Back .75 yd(s).

- When combining two materials of the same grade, pricing will be specified grade + 5%
- If combining two materials of different grades or leather/fabric combination, use the highest grade/price + 5%
- If using COM or COL, pricing will be COM or COL + 5%.
- If both COM + COL are used in combination, use COL + 5%.

Product Features

- 26" diameter polished aluminum base
- Back utilizes an elastic sheet webbing suspension that conforms to individual's lumbar curvatures for adaptive support.
- Back adjustable ergonomic arms are available with spring loaded height adjustment and button activation. Arms are angles at 15 degrees with an adjustable arm pad for additional comfort and support. Arm adjusts 3- 1/4" in height and 1-1/2" in width
- Knee Tilt Swivel w/ forward pivot point
- Large 60mm diameter casters are standard and promote increased mobility.
- Plywood components feature interlocking tab joinery for superior strength and long term durability.

Options

Base

- BBPC: Black Base - \$95
- BOW: Wood Base- \$170

Covet

Metal "C" Arms
Mid-Back

[Click here to view statement of line](#)

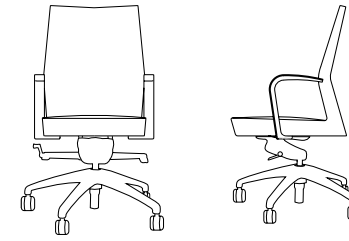

1 Model COV9725CAM06

w" x d" x h"
26 x 23.5 x 40-42.75
Arm Height 26" - 29"
Seat Height 19" - 22"
Inside Seat Depth 19"
Inside Seat Width 20 -1/2"

COM	COL	1	2	3	4	5	6	7	8	9	10	11/L1	12	13/L2
2054	2109	2147	2193	2239	2285	2331	2377	2423	2469	2515	2561	2607	2653	2745

Upholstery Requirements
Fabric yds: 2.5 Leather Sq. Ft.: 50
Carton Weight: 50

2 Select Finish

[Click to view finishes](#)

Finishes N/A

3 Combination Fabrics

[Click to view finishes](#)

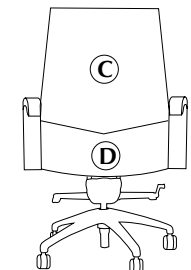
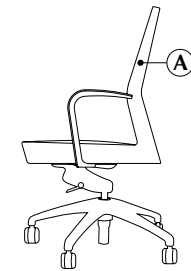
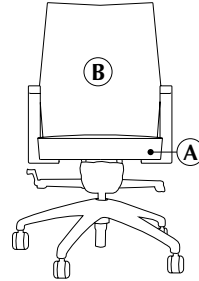

DARRAN is pleased to offer customers the design freedom of combination fabrics. When using fabric, vinyl or leather combinations, pricing/yardage requirements will be as follows:

- A Seat/Sides 1 yd(s).
- B Inside Back .75 yd(s).
- C Upper Outside Back .75 yd(s).
- D Lower Outside Back .75 yd(s).

- When combining two materials of the same grade, pricing will be specified grade + 5%
- If combining two materials of different grades or leather/fabric combination, use the highest grade/price + 5%
- If using COM or COL, pricing will be COM or COL + 5%.
- If both COM + COL are used in combination, use COL + 5%.

Product Features

- 26" diameter polished aluminum base
- Back utilizes an elastic sheet webbing suspension that conforms to individual's lumbar curvatures for adaptive support.
- Knee Tilt Swivel w/ forward pivot point
- Large 60mm diameter casters are standard and promote increased mobility.
- Metal "C" Arm
- Plywood components feature interlocking tab joinery for superior strength and long term durability.

Base Options

- BBPC: Black Base - \$95
- BOW: Wood Base- \$170

Covet

Metal "C" Arms
High-Back

[Click here to view statement of line](#)

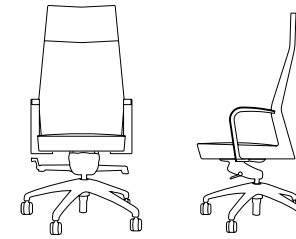

1 Model COV9725CAH07

w" x d" x h"
26 x 23.5 x 50.5-53
Arm Height 26" - 29"
Seat Height 19" - 22"
Inside Seat Depth 19"
Inside Seat Width 20 -1/2"

COM	COL	1	2	3	4	5	6	7	8	9	10	11/L1	12	13/L2
2182	2240	2293	2348	2403	2458	2513	2568	2623	2678	2733	2788	2843	2898	3008

Upholstery Requirements
Fabric yds: 3 Leather Sq. Ft.: 60
Carton Weight: 55

2 Select Finish

[Click to view finishes](#)

Finishes N/A

3 Combination Fabrics

[Click to view finishes](#)

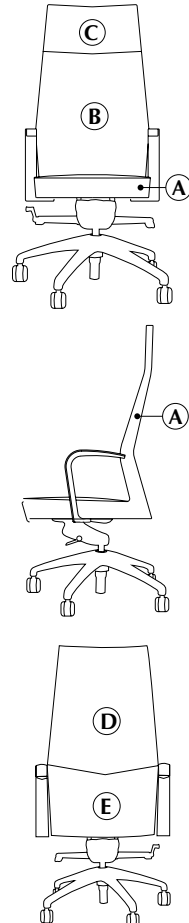

DARRAN is pleased to offer customers the design freedom of combination fabrics. When using fabric, vinyl or leather combinations, pricing/yardage requirements will be as follows:

- A Seat/Sides 1 yd(s).
- B Lower Inside Back .75 yd(s).
- C Upper Inside Back .5 yd(s).
- D Upper Outside Back .75 yd(s).
- E Lower Outside Back .75 yd(s).

- When combining two materials of the same grade, pricing will be specified grade + 5%
- If combining two materials of different grades or leather/fabric combination, use the highest grade/price + 5%
- If using COM or COL, pricing will be COM or COL + 5%.
- If both COM + COL are used in combination, use COL + 5%.

Product Features

- 26" diameter polished aluminum base
- Back utilizes an elastic sheet webbing suspension that conforms to individual's lumbar curvatures for adaptive support.
- Knee Tilt Swivel w/ forward pivot point
- Large 60mm diameter casters are standard and promote increased mobility.
- Metal "C" Arm
- Plywood components feature interlocking tab joinery for superior strength and long term durability.

Base Options

- BBPC: Black Base - \$95
- BOW: Wood Base- \$170

DARRAN®



Guest Seating Price List

Effective November 1, 2022

Lisso Designed by Chris Carter

Date	Page	Modification	Description
11.10.22		Price Increase	9% price increase on all items excluding options
4.25.23		Removed WOW from Cosmo	
5.8.23		Removed WLA and replaced with WLO Lofty Oak	
6.21.23		Added WWW finish	

DARRAN®

Statement of Line	
Seating fabric & leather program.....	1
Finishes specifications.....	4
Composition Seating Specification	5
Cosmo Seating Specification	7
Lisso Seating Specification	8
Maxton Seating Specification.....	9
Monroe Seating Specification.....	10
Silo Seating Specification	12
Composition Guest Chair.....	14
Composition Barstool.....	13
Cosmo Guest Chair.....	15
Lisso Guest Chair.....	17
Maxton Guest Chair.....	19
Monroe Guest Chair.....	23
Silo Guest Chair.....	27

Seating & fabric leather program

DARRAN has partnered with some of the most prestigious fabric suppliers of the office furniture industry to bring you quality fabrics that are engaging designs, environmentally friendly and durable for years to come. The majority of fabrics we have graded-in are in heavy supply making it most likely available on our Quickship however, we cannot guarantee stock. If you do not see the fabric you wish to include in a project, please contact our Factory to see if this pattern can be graded in at 800.334.7891.

Fabrics & Leathers

Please visit our Seating Fabrics page at darran.com/textilesleather

Camira
www.camirafabrics.com
 800.334.789

Wollsdorf
www.wollsdorf.com
 336.884.5005

CFStinson
www.cfstinson.com
 800.841.6279

Green Hides
www.greenhides.com
 336.315.9720

DesignTex
www.designtex.com
 800.797.4949

Maharam
www.maharam.com
 800.645.3943

Momentum Textiles
www.momentumtextiles.com
 800.366.6839

Ultrafabrics
www.ultrafabricsinc.com
 800.334.7891

Application instructions must be specified on the purchase order or COM / COL submission form. In the absence of application instructions, DARRAN will apply materials accordingly.

CAL117

All DARRAN seating products conform to California Technical Bulletin 117 as a minimum standard.

CAL133

To meet the California Technical Bulletin 133 flammability regulation, a combination of proper materials must be used to pass, as it tests the fire resistance of a finished product. Flame resistant fabric, a fire blocker material and special foam must be used to pass CAL133 fire codes.

Testing is available for all seating products with the following fees and considerations:

- If laboratory certification is not required, any style can be manufactured to comply with California Technical Bulletin 133 for \$75 list per yard required. (Customer's Own Materials must factor in additional yardage requirements based on repeat.)
- The purchase order must clearly indicate the requirement of California Technical Bulletin 133
- If laboratory California Technical Bulletin 133 certification is required, the cost of testing a chair is \$820 NET, plus the cost of the chair and covering material.
- An additional lead time of 4 to 6 weeks is required for testing for CAL133.
- Once testing is completed, we will provide a certification letter specific to the sample tested for CAL133.
- DARRAN's manufacturing procedures for California TB 133 compliance are based on the testing of representative style with specific fabrics. Please contact Customer Service for an updated list of tested models.
- A copy of test certification is available upon request.

Statement of Line



Page 13
Composition Guest Chair
Maple



Page 14
Composition Barstool
Maple

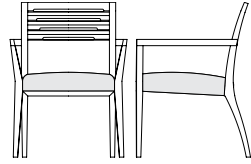

Page 15
Cosmo Guest Chair
Horizontal Multi-Slat Back

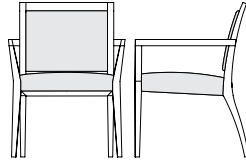

Page 16
Cosmo Guest Chair
Fully Upholstered Back



Page 17
Lisso Guest Chair
Fully Upholstered Back W/ Open
Arms

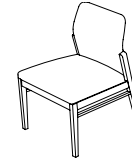

Page 18
Lisso Guest Chair
Fully Upholstered Back W/O Arms

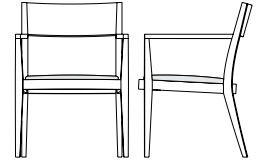

Page 19
Maxton Guest Chair
Open Wood Back

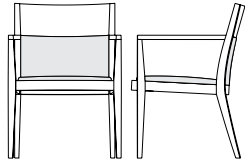

Page 20
Maxton Guest Chair
Half Upholstered Back

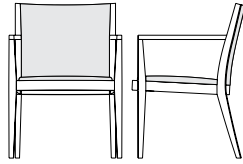

Page 21
Maxton Guest Chair
Fully Upholstered Back

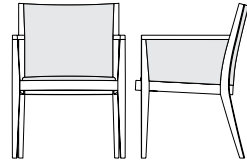

Page 22
Maxton Guest Chair
Fully Uph. Back / Arms

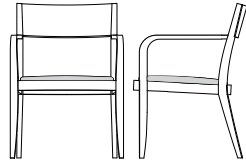

Page 23
Monroe Guest Chair
Open Wooden Back

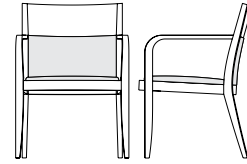

Page 24
Monroe Guest Chair
Half Upholstered Back

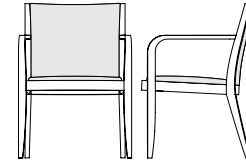

Page 25
Monroe Guest Chair
Fully Upholstered Back



Page 26
Silo Guest Chair
Maple & Tech Walnut



Page 27
Silo Barstool
Maple & Tech Walnut

Combination fabrics

DARRAN is pleased to offer customers the design freedom of combination fabrics. When using fabric, vinyl or leather combinations, pricing will be as follows:

- When combining two materials of the same grade, pricing will be specified grade + 5%.
- If combining two materials of different grades or leather/ fabric combination, use the highest grade/price + 5%.
- If using COM or COL, pricing will be COM or COL + 5%. If both COM + COL are used in combination, use COL + 5%

COM/COL ordering instructions

Please complete the COM Submission Form prior to ordering the fabric from the supplier. All COM fabrics must be approved prior to order submission. Please refer to our website or contact DARRAN Seating Customer Service for an updated list of preapproved COM fabrics. Application instructions must be specified on the purchase order or COM/COL submission form. In the absence of application instructions, DARRAN will apply materials in the best manner and cannot be held responsible for tailoring or application objections after upholstering. COM orders will be scheduled for production after receipt of the material. Packages must be clearly marked and the fabric must be first quality, continuous yardage.

COM/COL yardage requirements

The yardage requirements stated in this price list for each style are calculated using 54" wide, non-directional fabrics. For fabrics with a different width or for patterns with repeats, please refer to the below chart to calculate the additional percent of fabric required:

Fabric Width	Plain Fabric	2"- 14" Repeat	15"- 19" Repeat	20"- 27" Repeat	28"- 36" Repeat
54"	0	15%	20%	25%	30%
53"	6%	19%	24%	28%	36%
52"	13%	23%	28%	33%	38%
51"	19%	26%	31%	36%	41%
50"	25%	30%	35%	40%	45%
49"	30%	35%	40%	45%	50%
48"	35%	40%	45%	50%	55%
47"	45%	50%	55%	58%	65%

DARRAN®

NOTE: Prior To Completion Of This Form, Please Refer To Our Graded In Materials Program For Preapproved Fabrics/Leathers.

COM/COL Approval

DARRAN Furniture Industries
2402 Shore Street, High Point, NC 27263
ATTN: Seating Division / COM/COL Approval
TAG: DARRAN Purchase Order Number

Shipping approved COM/COL materials

DARRAN Furniture Industries
2402 Shore Street, High Point, NC 27263
ATTN: Seating Division / COM/COL Approval
TAG: DARRAN Purchase Order Number

Please complete this form, attach a 6"x 6" sample and mail to the COM/COL APPROVAL address shown above.
This form can also be downloaded from our website at www.darran.com/leathers OR www.darran.com/fabrics

Purchase Order # _____

Dealer's Name _____

Contact _____

Address _____

Telephone _____

Email _____

Chair Stlye _____

Manufacturer _____

Pattern Name _____

Pattern Color _____

Content _____

Repeat _____

Please specify any special requirements and check the application above.

Guest Seating Fabric & Leather Program

ATTACH 6" X 6" FABRIC/LEATHER SAMPLE HERE

NOTE

Actual Fabric/Leather samples needed instead of digital images. If digital images are sent in lieu of samples, DARRAN will only verify the pattern and will not take responsibility for color variances that cannot be verified due to printing restrictions

In the absence of application instructions, DARRAN will apply the material in the best manner and cannot be held responsible for tailoring or application objections after upholstering.

Unless otherwise instructed on the purchase order, excess COM materials will be recycled at the discretion of DARRAN after six months of the original product ship date.

The COM approval solely pertains to the application of the fabric onto the specified DARRAN seating product. DARRAN's approval or acceptance does not constitute any responsibility or warranty to the overall appearance, durability, flammability, defects, dye lot variations or colorfastness of the COM. It is the customer's responsibility to ensure the COM meets CAL 117 compliance and are first quality continuous goods.

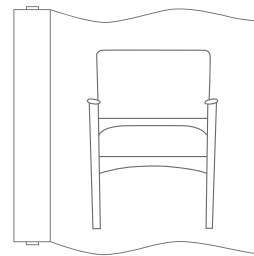

RAILROAD

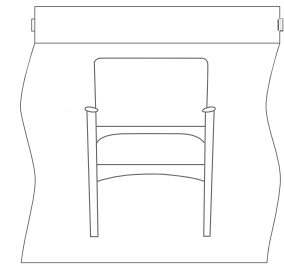

SETUP

WLO Lofty Oak
WAC Amber Cherry
WIC Crimson Cherry
WHC Honey Cherry
WEC Ebony
WOC KoKo Cherry
WAM Alabaster Maple
WCM Clear Maple
WMO Mocha Oak
WNO Natural Oak
WSO Salted Oak
WEW Executive Walnut
WGW Gunstock Walnut
WBW Henna Walnut
WNW Natural Walnut
WWW Weathered Walnut
RWV Clear Tech-grain
TBCO Baby's Cheek
TBSW Brown Sugar
TSTV Studio Teak Walnut
SSM Seattle Mist Paint
SSL Skyline Walnut Paint
TOBW Organic Brown
WWP Designer White
PM01 Olive
PM02 Aquavert
PM03 Mushroom
PM08 Vapour
PM10 Verde
SNA Narvik Ash

*see product page for available finish selection



Finish

Welltech Finish delivers a superior furniture coating with exceptional performance that can withstand stringent cleaning agents and possesses unparalleled durability, allowing DARRAN to provide lasting, sustainable products to our customers.

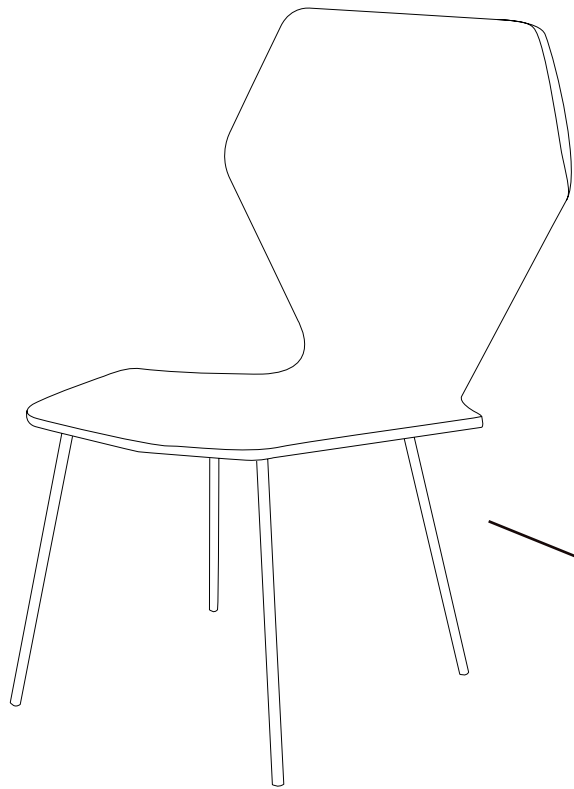

Plywood shells have a 9-ply construction, pressed in Heat-Induction presses with walnut core veneers and any specified face materials.

Frames are 5/8" diameter 13 gauge steel with reinforced rods in the tubes at the bends. The finish on the frame is chrome.

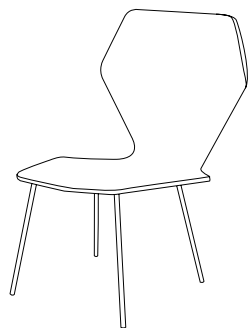

Chair
 Width = 18"
 Depth = 20.5"
 Height = 33.5"
 Seat Width = 18"
 Seat Depth = 13"
 Seat Height = 18.5"

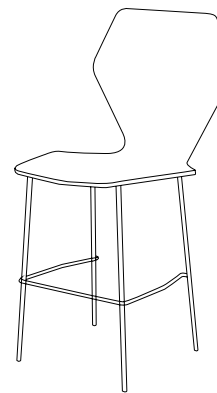

Barstool
 Width = 18"
 Depth = 20.5"
 Height = 43.5"
 Seat Width = 18"
 Seat Depth = 13"
 Seat Height = 29.5"

DARRAN®

Width = 24-1/2"
Depth = 23-3/4"
Height = 32-1/2"
Seat Width = 19"
Seat Depth = 19-1/2"
Seat Height = 18"
Arm Height = 24-3/4"
Cartoned Weight = 25 lbs.

Cosmo Seating Specification

Frame is constructed of kiln-dried European beech, PEFC Certified sustainable yield, perpetuating premium quality and durability.

Seat cushions are made of high resiliency foam with proper density to give comfort and support.

Seat rails are reinforced with tenon and groove corner blocks and cleats attached with glue and wood screws.

Enhancing veinline detail at the back panel to further showcase American craftsmanship and prevent finish cracking.

*Wall-Saver Design

Increased seat width to allow added comfort and increased application.

Non adjustable nylon glides are 7/8" in diameter.

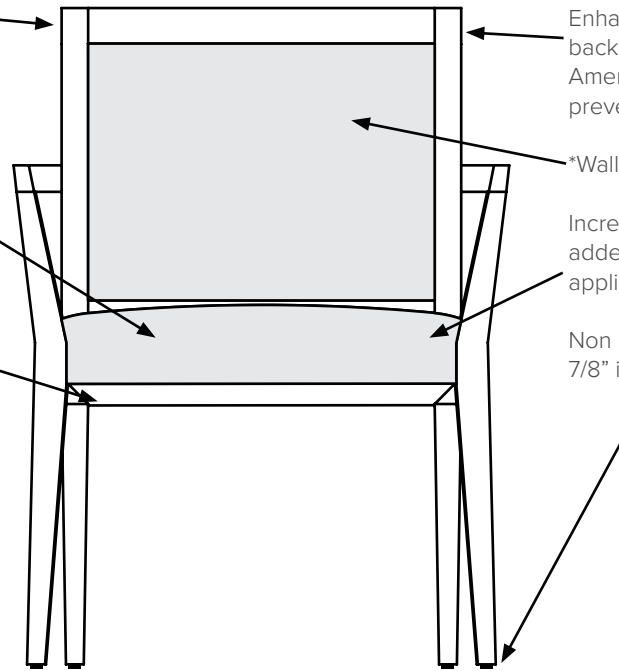

Variety of textiles and back options offer customers flexibility in design and consistency within each office setting.

Joints

Joints are securely fastened with mortise and tenon joinery or double doweled construction to ensure long-term use.

Seat suspension

Seat suspension is constructed of 3/4" thick top quality Baltic Birch plywood that is machined to form an open perimeter of rounded inside edges to reduce strain on the seat suspension. Seats are webbed to provide maximum support for seat cushions. Seat cushions are made of high resiliency foam with proper density providing comfort.

Seat assembly

Seat assembly is attached within finger grooved corner blocks and further secured by wood cleats, providing a vast superior means of stability in the chair.

DARRAN®

Lisso Seating Specification

Width = 23.5"
Depth = 24.5"
Height = 31.5"
Seat Width = 21"
Seat Depth = 18"
Seat Height = 18"
Arm Height = 24"
Cartoned Weight = 30 lbs.

Frame is constructed of kiln-dried European beech, PEFC Certified sustainable yield, perpetuating premium quality and durability.

Seat cushions are made of high resiliency foam with proper density to give comfort and support.

Seat rails are reinforced with hardwood corner blocks and cleats attached with glue and wood screws.

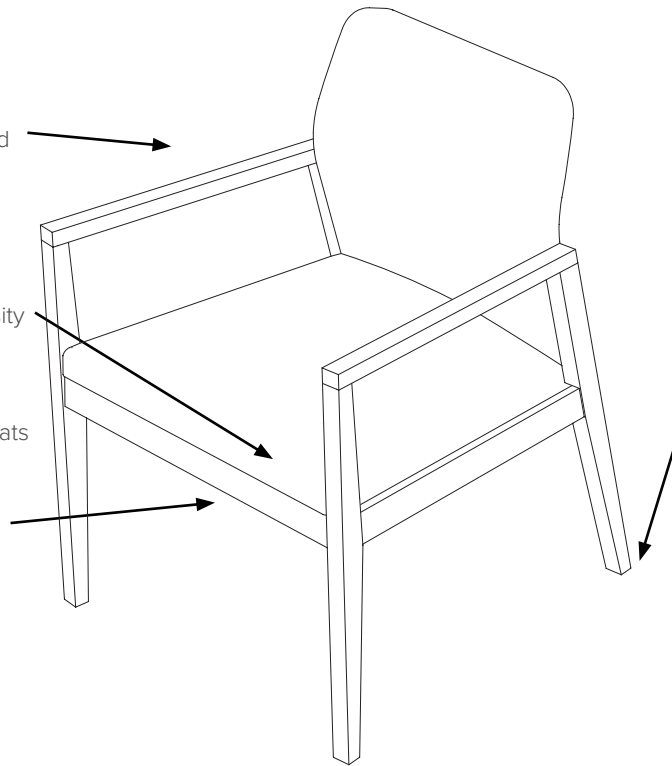

*Wall-Saver Design

Non adjustable nylon glides are 5/8" in diameter.

Variety of textiles and back options offer customers flexibility in design and consistency within each office setting.

Joints

Joints are securely fastened with mortise and tenon joinery or double doweled construction to ensure long-term use.

Seat suspension

Seat suspension is constructed of 3/4" thick top quality Baltic Birch plywood that is machined to form an open perimeter of rounded inside edges to reduce strain on the seat suspension. Seats are webbed to provide maximum support for seat cushions. Seat cushions are made of high resiliency foam with proper density providing comfort.

Seat assembly

Seat assembly is attached within hardwood corner blocks, providing a vast superior means of stability in the chair.

DARRAN®

Width = 23-1/4"
Depth = 23"
Height = 32"
Seat Width = 21"
Seat Depth = 20"
Seat Height = 18"
Arm Height = 25-1/4"
Cartoned Weight = 25 lbs.

Maxton Seating Specification

Frame is constructed of kiln-dried European beech, PEFC Certified sustainable yield, perpetuating premium quality and durability.

Sleek, modern design characterizes the dramatic tapering arms and legs posts which accent designer back options.

Seat cushions are made of high resiliency foam with proper density to give confort and support.

Seat rails are reinforced with tenon and groove corner blocks and cleats attached with glue and wood screws.

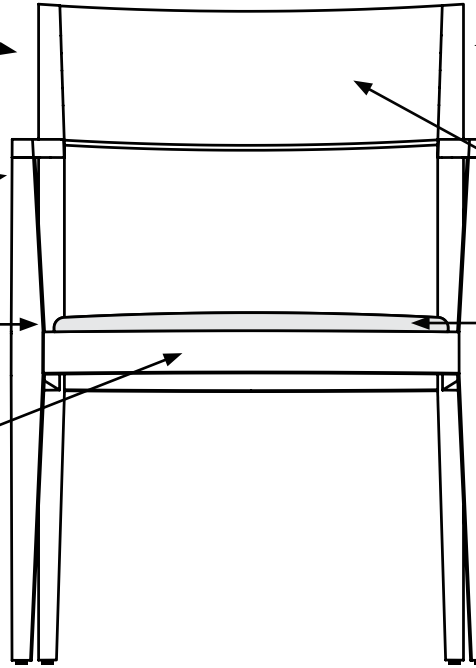

Enhancing veinline detail at the back panel to further showcase American craftsmanship and prevent finish cracking.

Two panel back to enhance durability in the back and to prevent finish cracking.

Increased seat width to allow added confort and increased application.

Non adjustable nylon glides are 7/8" in diameter.

Variety of textiles and back options offer customers flexibility in design and consistency within each office setting.

Joints

Joints are securely fastened with mortise and tenon joinery or double doweled construction to ensure long-term use.

Seat suspension

Seat suspension is constructed of 3/4" thick top quality Baltic Birch plywood that is machined to form an open perimeter of rounded inside edges to reduce strain on the seat suspension. Seats are webbed to provide maximum support for seat cushions. Seat cushions are made of high resiliency foam with proper density providing confort.

Seat assembly

Seat assembly is attached within finger grooved corner blocks and further secured by wood cleats, providing a vast superior means of stability in the chair.

DARRAN®

Monroe seating specification

Width = 23-1/4"
Depth = 23"
Height = 32"
Seat Width = 20-3/4"
Seat Depth = 20"
Seat Height = 18"
Arm Height = 25-1/4"
Cartoned Weight = 25 lbs.

Frame is constructed of kiln-dried European beech, PEFC Certified sustainable yield, perpetuating premium quality and durability.

Sleek, modern design characterizes the simple curved arm design that compliments either a contemporary or transitional setting.

Seat cushions are made of high resiliency foam with proper density to give comfort and support.

Seat rails are reinforced with tenon and groove corner blocks and cleats attached with glue and wood screws.

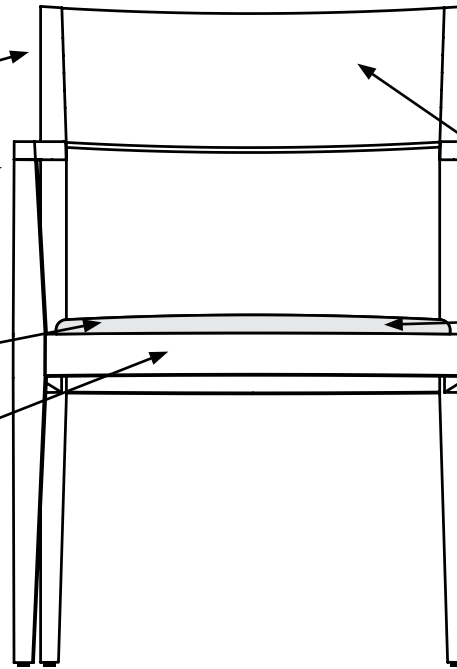

Enhancing veinline detail at the back panel to further showcase American craftsmanship and prevent finish cracking.

Two panel back to enhance durability in the back and to prevent finish cracking.

Increased seat width to allow added comfort and increased application.

Non-adjustable nylon glides are 7/8" in diameter.

Variety of textiles and back options offer customers flexibility in design and consistency within each office setting.

Joints

Joints are securely fastened with mortise and tenon joinery or double doweled construction to ensure long-term use.

Seat suspension

Seat suspension is constructed of 3/4" thick top quality Baltic Birch plywood that is machined to form an open perimeter of rounded inside edges to reduce strain on the seat suspension. Seats are webbed to provide maximum support for seat cushions. Seat cushions are made of high resiliency foam with proper density providing comfort.

Seat assembly

Seat assembly is attached within finger grooved corner blocks and further secured by wood cleats, providing a vast superior means of stability in the chair.



Plywood shells have a 9-ply construction, pressed in Heat-Induction presses with walnut core veneers and any specified face materials, such as maple or tech walnut.



Frames are 5/8" diameter 13 gauge steel with reinforced rods in the tubes at the bends. The finish on the frame is chrome.

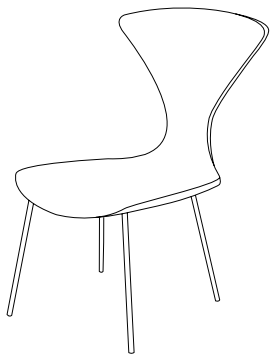

Chair
 Width = 17.5"
 Depth = 21"
 Height = 35.5"
 Seat Width = 17.5"
 Seat Depth = 14"
 Seat Height = 18.5"

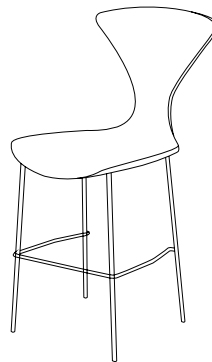

Barstool
 Width = 17.5"
 Depth = 21"
 Height = 45.5"
 Seat Width = 17.5"
 Seat Depth = 14"
 Seat Height = 29.5"

Guest - Composition

Composition Guest Chair
Maple

[Click here to view statement of line](#)



1 Model COM2332NWB17

w" x d" x h"
18 x 20.5 x 33.5
Arm Height N/A
Seat Height 18.5"
Inside Seat Depth 14.5"
Inside Seat Width 18"

COM	COL	1	2	3	4	5	6	7	8	9	10	11/L1	12	13/L2
568	N/A													

Upholstery Requirements
Fabric yds: N/A Leather Sq. Ft.: N/A
Carton Weight:

Product Features

- 1 Piece molded plywood shell standard in maple veneer
- Polished chrome base
- Ships assembled
- Can stack up to 8 chairs

2 Select Finish

[Click to view finishes](#)

- WAC Amber Cherry
- WIC Crimson Cherry
- WHC Honey Cherry
- WOC KoKo Cherry
- WEC Ebony
- WAM Alabaster Maple
- WCM Clear Maple
- TBCO Baby's Cheek
- TBSW Brown Sugar
- TSTV Studio Teak Walnut
- SSM Seattle Mist Paint
- SNA Narvik Ash
- SSL Skyline Walnut Paint
- TOBW Organic Brown
- WWP Designer White Paint
- PM01 Olive
- PM02 Aquavert
- PM03 Mushroom
- PM07 Pebble
- PM08 Vapour
- PM10 Verde

3 Combination Fabrics

[Click to view finishes](#)

Combination
Fabric Option
Not Available

Guest - Composition

Composition Barstool
Maple

[Click here to view statement of line](#)



1 Model COM2332BAR38

w" x d" x h"
18 x 20.5 x 43.5
Arm Height N/A
Seat Height 29.5"
Inside Seat Depth 14.5"
Inside Seat Width 18"

COM	COL	1	2	3	4	5	6	7	8	9	10	11/L1	12	13/L2
738	N/A													

Upholstery Requirements
Fabric yds: N/A Leather Sq. Ft.: N/A
Carton Weight:

Product Features

- 1 Piece molded plywood shell standard in maple veneer
- Polished chrome base
- Ships assembled

2 Select Finish

[Click to view finishes](#)

WAC Amber Cherry
WIC Crimson Cherry
WHC Honey Cherry
WOC KoKo Cherry
WEC Ebony
WAM Alabaster Maple
WCM Clear Maple
TBCO Baby's Cheek
TBSW Brown Sugar
TSTV Studio Teak Walnut
SSM Seattle Mist Paint
SNA Narvik Ash
SSL Skyline Walnut Paint
TOBW Organic Brown
WWP Designer White Paint
PM01 Olive
PM02 Aquavert
PM03 Mushroom
PM07 Pebble
PM08 Vapour
PM10 Verde

3 Combination Fabrics

[Click to view finishes](#)

Combination
Fabric Option
Not Available

Guest - Cosmo

Cosmo Guest Chair
Horizontal Multi-Slat Back

[Click here to view statement of line](#)

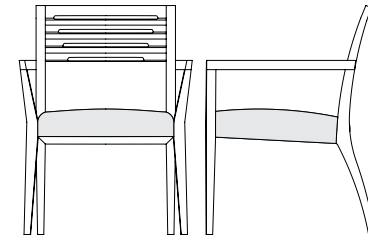

1 Model COS2332MSB38

w" x d" x h"
24.5 x 23.75 x 32.5
Arm Height 24 -3/4"
Seat Height 18"
Inside Seat Depth 19 -1/2"
Inside Seat Width 19"

COM	COL	1	2	3	4	5	6	7	8	9	10	11/L1	12	13/L2
1087	1111	1133	1156	1179	1202	1225	1248	1271	1294	1317	1340	1363	1386	1432

Upholstery Requirements
Fabric yds: 1.25 Leather Sq. Ft.: 22.5
Carton Weight: 25

2 Select Finish

[Click to view finishes](#)

WAC Amber Cherry
WIC Crimson Cherry
WHC Honey Cherry
WOC KoKo Cherry
WEC Ebony
WAM Alabaster Maple
WCM Clear Maple
WMO Mocha Oak
WNO Natural Oak
WSO Salted Oak
WEW Executive Walnut
WGW Gunstock Walnut
WBW Henna Walnut
WSW Smokey Walnut
WNW Natural Walnut
WWW Weathered Walnut
WWP Designer White
SSL Skyline Walnut Paint
SSM Seattle Mist Paint
SNA Narvik Ash
TSTV Studio Teak Walnut
TBCO Baby's Cheek
TBSW Brown Sugar
TOBW Organic Brown

3 Combination Fabrics

[Click to view finishes](#)

Combination
Fabric Option
Not Available

Product Features

- Frame is constructed of kiln-dried European beech, PEFC Certified sustainable yield, perpetuating premium quality and durability.
- Joints are securely fastened with mortise and tenon joinery as well as corner block construction.
- MAS IAQ Certified
- Multi-Slat Back
- Open Arms
- Seat cushions are made of high resiliency foam with proper density to give comfort and support
- Seat rails are reinforced with tenon and groove corner blocks and cleats.
- Seat suspension is constructed of 3/4" thick Baltic Birch plywood.
- Sheet webbing
- Upholstered Seat

Guest - Cosmo

Cosmo Guest Chair
Fully Upholstered Back

[Click here to view statement of line](#)

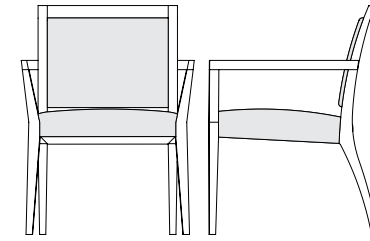

1 Model COS2332FUB39

w" x d" x h"
24.5 x 23.75 x 32.5
Arm Height 24 -3/4"
Seat Height 18"
Inside Seat Depth 19 -1/2"
Inside Seat Width 19"

COM	COL	1	2	3	4	5	6	7	8	9	10	11/L1	12	13/L2
1167	1204	1223	1251	1279	1307	1335	1363	1391	1419	1447	1475	1503	1531	1587

Upholstery Requirements
Fabric yds: 1.5 Leather Sq. Ft.: 27
Carton Weight: 25

2 Select Finish

[Click to view finishes](#)

- WAC Amber Cherry
- WIC Crimson Cherry
- WHC Honey Cherry
- WOC KoKo Cherry
- WEC Ebony
- WAM Alabaster Maple
- WCM Clear Maple
- WMO Mocha Oak
- WNO Natural Oak
- WSO Salted Oak
- WEW Executive Walnut
- WGW Gunstock Walnut
- WBW Henna Walnut
- WSW Smokey Walnut
- WNW Natural Walnut
- WWW Weathered Walnut
- WWP Designer White
- SSL Skyline Walnut Paint
- SSM Seattle Mist Paint
- SNA Narvik Ash
- TSTV Studio Teak Walnut
- TBCO Baby's Cheek
- TBSW Brown Sugar
- TOBW Organic Brown

3 Combination Fabrics

[Click to view finishes](#)

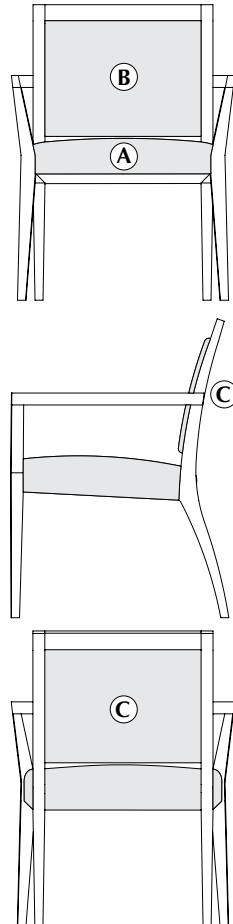

DARRAN is pleased to offer customers the design freedom of combination fabrics. When using fabric, vinyl or leather combinations, pricing/yardage requirements will be as follows:

- A Seat 1 yd(s).
- B Inside Back 0.25 yd(s).
- C Outside Back 0.25 yd(s).

- When combining two materials of the same grade, pricing will be specified grade + 5%
- If combining two materials of different grades or leather/fabric combination, use the highest grade/price + 5%
- If using COM or COL, pricing will be COM or COL + 5%.
- If both COM + COL are used in combination, use COL + 5%.

Product Features

- Frame is constructed of kiln-dried European beech, PEFC Certified sustainable yield, perpetuating premium quality and durability.
- Fully Upholstered Back
- Joints are securely fastened with mortise and tenon joinery as well as corner block construction.
- MAS IAQ Certified
- Open Arms
- Seat cushions are made of high resiliency foam with proper density to give comfort and support
- Seat rails are reinforced with tenon and groove corner blocks and cleats.
- Seat suspension is constructed of 3/4" thick Baltic Birch plywood.
- Sheet webbing
- Upholstered Seat

Guest - Lisso

Lisso Guest Chair
Fully Upholstered Back W/ Open Arms

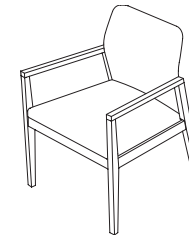

[Click here to view statement of line](#)

1 Model LIS2332AFU25

w" x d" x h"
23.5 x 24.5 x 31.5
Arm Height 24"
Seat Height 18"
Inside Seat Depth 18"
Inside Seat Width 21"

COM	COL	1	2	3	4	5	6	7	8	9	10	11/L1	12	13/L2
899	933	955	983	1011	1039	1067	1095	1123	1151	1179	1207	1235	1263	1319

Upholstery Requirements
Fabric yds: 1.5 Leather Sq. Ft.: 27
Carton Weight: 30

2 Select Finish

[Click to view finishes](#)

WLO Lofty Oak
WAC Amber Cherry
WIC Crimson Cherry
WHC Honey Cherry
WOC KoKo Cherry
WEC Ebony
WAM Alabaster Maple
WCM Clear Maple
WMO Mocha Oak
WNO Natural Oak
WSO Salted Oak
WEW Executive Walnut
WGW Gunstock Walnut
WBW Henna Walnut
WSW Smokey Walnut
WNW Natural Walnut
WWW Weathered Walnut
WWP Designer White Paint
SSL Skyline Walnut Paint
SSM Seattle Mist Paint
SNA Narvik Ash
TBCO Baby's Cheek
TBSW Brown Sugar
TSTV Studio Teak Walnut
TOBW Organic Brown

3 Combination Fabrics

[Click to view finishes](#)

DARRAN is pleased to offer customers the design freedom of combination fabrics. When using fabric, vinyl or leather combinations, pricing/yardage requirements will be as follows:

A Seat 1 yd(s).
B Back 1 yd(s).

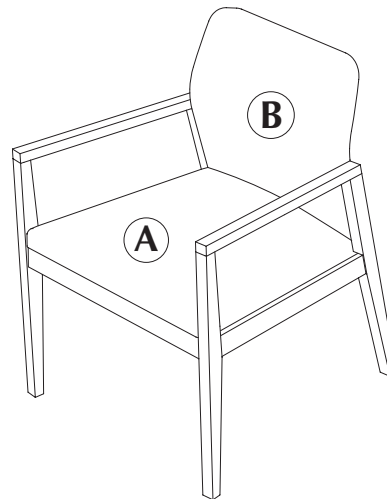

- When combining two materials of the same grade, pricing will be specified grade + 5%
- If combining two materials of different grades or leather/fabric combination, use the highest grade/price + 5%
- If using COM or COL, pricing will be COM or COL + 5%.
- If both COM + COL are used in combination, use COL + 5%.

Product Features

- Frame is constructed of kiln-dried European beech, PEFC Certified sustainable yield, perpetuating premium quality and durability.
- Joints are securely fastened with mortise and tenon joinery as well as hardwood corner block construction.
- Seat cushions are made of high resiliency foam with proper density to give comfort and support
- Seat rails are reinforced with hardwood corner blocks.
- Seat suspension is constructed of 3/4" thick Baltic Birch plywood.
- Sheet webbing
- Upholstered seat and back
- Wall saver leg

Guest - Lisso

Lisso Guest Chair
Fully Upholstered Back W/O Arms

[Click here to view statement of line](#)

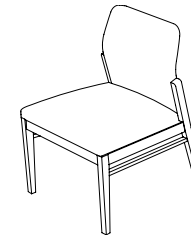

1 Model LIS2332NFU24

w" x d" x h"
23.5 x 24.5 x 31.5
Arm Height n/a
Seat Height 18"
Inside Seat Depth 18"
Inside Seat Width 21"

COM	COL	1	2	3	4	5	6	7	8	9	10	11/L1	12	13/L2
864	898	920	948	976	1004	1032	1060	1088	1116	1144	1172	1200	1228	1284

Upholstery Requirements
Fabric yds: 1.5 Leather Sq. Ft.: 27
Carton Weight: 25

2 Select Finish

[Click to view finishes](#)

WLO Lofty Oak
WAC Amber Cherry
WIC Crimson Cherry
WHC Honey Cherry
WOC KoKo Cherry
WEC Ebony
WAM Alabaster Maple
WCM Clear Maple
WMO Mocha Oak
WNO Natural Oak
WSO Salted Oak
WEW Executive Walnut
WGW Gunstock Walnut
WBW Henna Walnut
WSW Smokey Walnut
WNW Natural Walnut
WWW Weathered Walnut
WWP Designer White Paint
SSL Skyline Walnut Paint
SSM Seattle Mist Paint
SNA Narvik Ash
TBCO Baby's Cheek
TBSW Brown Sugar
TSTV Studio Teak Walnut
TOBW Organic Brown

3 Combination Fabrics

[Click to view finishes](#)

DARRAN is pleased to offer customers the design freedom of combination fabrics. When using fabric, vinyl or leather combinations, pricing/yardage requirements will be as follows:

A Seat 1 yd(s).
B Back 1 yd(s).

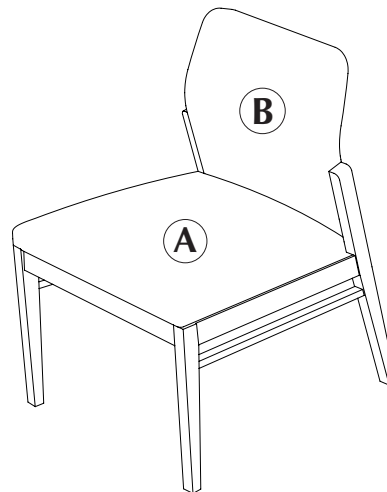

- When combining two materials of the same grade, pricing will be specified grade + 5%
- If combining two materials of different grades or leather/fabric combination, use the highest grade/price + 5%
- If using COM or COL, pricing will be COM or COL + 5%.
- If both COM + COL are used in combination, use COL + 5%.

Product Features

- Frame is constructed of kiln-dried European beech, PEFC Certified sustainable yield, perpetuating premium quality and durability.
- Joints are securely fastened with mortise and tenon joinery as well as hardwood corner block construction.
- Seat cushions are made of high resiliency foam with proper density to give comfort and support
- Seat rails are reinforced with hardwood corner blocks.
- Seat suspension is constructed of 3/4" thick Baltic Birch plywood.
- Sheet webbing
- Upholstered seat and back
- Wall saver leg

Guest - Maxton

Maxton Guest Chair
Open Wood Back

[Click here to view statement of line](#)

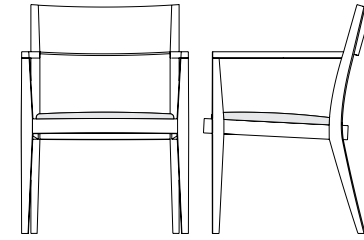

1 Model EMX2332OWB03

w" x d" x h"
23.25 x 23 x 32
Arm Height 25 -1/4"
Seat Height 18"
Inside Seat Depth 20"
Inside Seat Width 21"

COM	COL	1	2	3	4	5	6	7	8	9	10	11/L1	12	13/L2
1059	1077	1087	1101	1115	1129	1143	1157	1171	1185	1199	1213	1227	1241	1269

Upholstery Requirements
Fabric yds: 0.75 Leather Sq. Ft.: 13.5
Carton Weight: 25

2 Select Finish

[Click to view finishes](#)

WLO Lofty Oak
WAC Amber Cherry
WIC Crimson Cherry
WHC Honey Cherry
WOC KoKo Cherry
WEC Ebony
WAM Alabaster Maple
WCM Clear Maple
WMO Mocha Oak
WNO Natural Oak
WSO Salted Oak
WEW Executive Walnut
WGW Gunstock Walnut
WBW Henna Walnut
WSW Smokey Walnut
WNW Natural Walnut
WWW Weathered Walnut
WWP Designer White Paint
SSL Skyline Walnut Paint
SSM Seattle Mist Paint
SNA Narvik Ash
TBCO Baby's Cheek
TBSW Brown Sugar
TSTV Studio Teak Walnut
TOBW Organic Brown

3 Combination Fabrics

[Click to view finishes](#)

Combination
Fabric Option
Not Available

Product Features

- Frame is constructed of kiln-dried European beech, PEFC Certified sustainable yield, perpetuating premium quality and durability.
- Joints are securely fastened with mortise and tenon joinery as well as corner block construction.
- MAS IAQ Certified
- Open Arms
- Open Wood Back
- Seat cushions are made of high resiliency foam.
- Seat rails are reinforced with tenon and groove corner blocks and cleats.
- Seat suspension is constructed of 3/4" thick Baltic Birch plywood.
- Sheet webbing
- Upholstered Seat

Guest - Maxton

Maxton Guest Chair
Half Upholstered Back

[Click here to view statement of line](#)

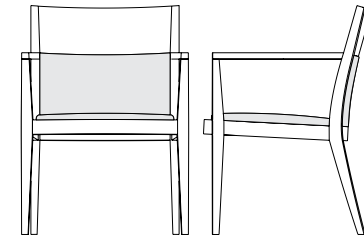

1 Model EMX2332HUB05

w" x d" x h"
23.25 x 23 x 32
Arm Height 25 -1/4"
Seat Height 18"
Inside Seat Depth 20"
Inside Seat Width 21"

COM	COL	1	2	3	4	5	6	7	8	9	10	11/L1	12	13/L2
1175	1201	1221	1244	1267	1290	1313	1336	1359	1382	1405	1428	1451	1474	1520

Upholstery Requirements
Fabric yds: 1.25 Leather Sq. Ft.: 22.5
Carton Weight: 25

2 Select Finish

[Click to view finishes](#)

WLO Lofty Oak
WAC Amber Cherry
WIC Crimson Cherry
WHC Honey Cherry
WOC KoKo Cherry
WEC Ebony
WAM Alabaster Maple
WCM Clear Maple
WMO Mocha Oak
WNO Natural Oak
WSO Salted Oak
WEW Executive Walnut
WGW Gunstock Walnut
WBW Henna Walnut
WSW Smokey Walnut
WNW Natural Walnut
WWW Weathered Walnut
WWP Designer White Paint
SSL Skyline Walnut Paint
SSM Seattle Mist Paint
SNA Narvik Ash
TBCO Baby's Cheek
TBSW Brown Sugar
TSTV Studio Teak Walnut
TOBW Organic Brown

3 Combination Fabrics

[Click to view finishes](#)

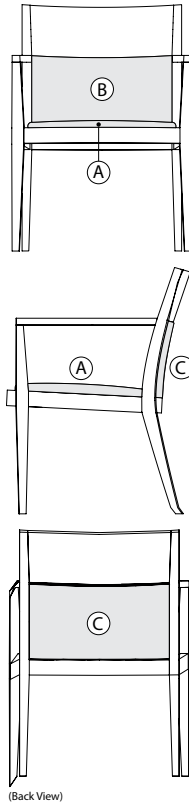

DARRAN is pleased to offer customers the design freedom of combination fabrics. When using fabric, vinyl or leather combinations, pricing/yardage requirements will be as follows:

A Seat 1 yd(s).
B Inside Back 0.25 yd(s)
C Outside Back 0.25 yd(s)

- When combining two materials of the same grade, pricing will be specified grade + 5%
- If combining two materials of different grades or leather/fabric combination, use the highest grade/price + 5%
- If using COM or COL, pricing will be COM or COL + 5%.
- If both COM + COL are used in combination, use COL + 5%.

Product Features

- Frame is constructed of kiln-dried European beech, PEFC Certified sustainable yield, perpetuating premium quality and durability.
- Half Upholstered/Half Wood Back
- Joints are securely fastened with mortise and tenon joinery as well as corner block construction.
- MAS IAQ Certified
- Open Arms
- Seat cushions are made of high resiliency foam.
- Seat rails are reinforced with tenon and groove corner blocks and cleats.
- Seat suspension is constructed of 3/4" thick Baltic Birch plywood.
- Sheet webbing
- Upholstered Seat

Guest - Maxton

Maxton Guest Chair
Fully Upholstered Back

[Click here to view statement of line](#)

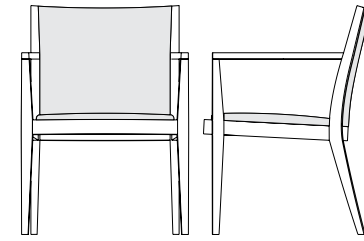

1 Model EMX2332FUB07

w" x d" x h"
23.25 x 23 x 32
Arm Height 25 -1/4"
Seat Height 18"
Inside Seat Depth 20"
Inside Seat Width 21"

COM	COL	1	2	3	4	5	6	7	8	9	10	11/L1	12	13/L2
1166	1198	1231	1263	1295	1327	1359	1391	1423	1455	1487	1519	1551	1583	1647

Upholstery Requirements
Fabric yds: 1.75 Leather Sq. Ft.: 31.5
Carton Weight: 25

2 Select Finish

[Click to view finishes](#)

WLO Lofty Oak
WAC Amber Cherry
WIC Crimson Cherry
WHC Honey Cherry
WOC KoKo Cherry
WEC Ebony
WAM Alabaster Maple
WCM Clear Maple
WMO Mocha Oak
WNO Natural Oak
WSO Salted Oak
WEW Executive Walnut
WGW Gunstock Walnut
WBW Henna Walnut
WSW Smokey Walnut
WNW Natural Walnut
WWW Weathered Walnut
WWP Designer White Paint
SSL Skyline Walnut Paint
SSM Seattle Mist Paint
SNA Narvik Ash
TBCO Baby's Cheek
TBSW Brown Sugar
TSTV Studio Teak Walnut
TOBW Organic Brown

3 Combination Fabrics

[Click to view finishes](#)

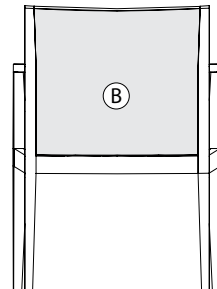
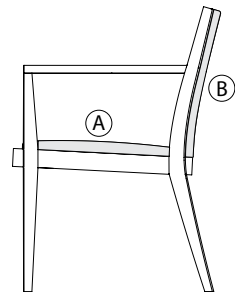
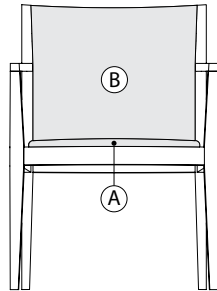

(Back View)
SIN: 33721

DARRAN is pleased to offer customers the design freedom of combination fabrics. When using fabric, vinyl or leather combinations, pricing/yardage requirements will be as follows:

A Seat 1 yd(s).
B Inside/Outside Back 1.5 yd(s).

- When combining two materials of the same grade, pricing will be specified grade + 5%
- If combining two materials of different grades or leather/fabric combination, use the highest grade/price + 5%
- If using COM or COL, pricing will be COM or COL + 5%.
- If both COM + COL are used in combination, use COL + 5%.

Product Features

- Frame is constructed of kiln-dried European beech, PEFC Certified sustainable yield, perpetuating premium quality and durability.
- Fully Upholstered Seat and Back
- Joints are securely fastened with mortise and tenon joinery as well as corner block construction.
- MAS IAQ Certified
- Open Arms
- Seat cushions are made of high resiliency foam.
- Seat rails are reinforced with tenon and groove corner blocks and cleats.
- Seat suspension is constructed of 3/4" thick Baltic Birch plywood.
- Sheet webbing

Guest - Maxton

Maxton Guest Chair
Fully Uph. Back / Arms

[Click here to view statement of line](#)

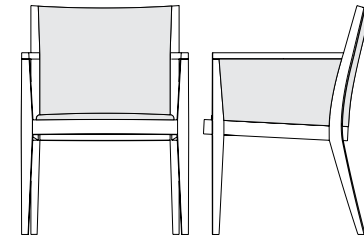

1 Model EMX2332UPA07

w" x d" x h"
23.25 x 23 x 32
Arm Height 25 -1/4"
Seat Height 18"
Inside Seat Depth 20"
Inside Seat Width 21"

COM	COL	1	2	3	4	5	6	7	8	9	10	11/L1	12	13/L2
1417	1473	1491	1528	1565	1602	1639	1676	1713	1750	1787	1824	1861	1898	1972

Upholstery Requirements
Fabric yds: 2 Leather Sq. Ft.: 36
Carton Weight: 25

2 Select Finish

[Click to view finishes](#)

- WLO Lofty Oak
- WAC Amber Cherry
- WIC Crimson Cherry
- WHC Honey Cherry
- WOC KoKo Cherry
- WEC Ebony
- WAM Alabaster Maple
- WCM Clear Maple
- WMO Mocha Oak
- WNO Natural Oak
- WSO Salted Oak
- WEW Executive Walnut
- WGW Gunstock Walnut
- WBW Henna Walnut
- WSW Smokey Walnut
- WNW Natural Walnut
- WWW Weathered Walnut
- WWP Designer White Paint
- SSL Skyline Walnut Paint
- SSM Seattle Mist Paint
- SNA Narvik Ash
- TBCO Baby's Cheek
- TBSW Brown Sugar
- TSTV Studio Teak Walnut
- TOBW Organic Brown

3 Combination Fabrics

[Click to view finishes](#)

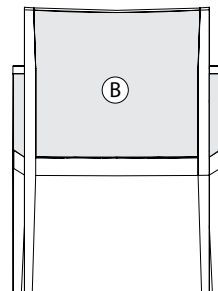
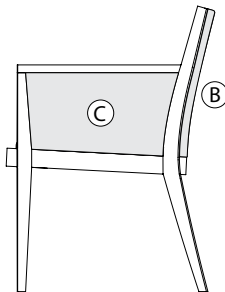
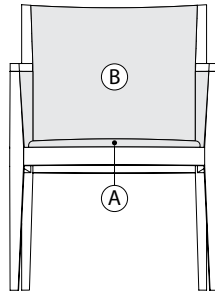

(Back View)
SIN: 33721

DARRAN is pleased to offer customers the design freedom of combination fabrics. When using fabric, vinyl or leather combinations, pricing/yardage requirements will be as follows:

- A Seat 1 yd(s).
- B Inside/Outside Back 1.5 yd(s).
- C Arms 1 yd(s).

- When combining two materials of the same grade, pricing will be specified grade + 5%
- If combining two materials of different grades or leather/fabric combination, use the highest grade/price + 5%
- If using COM or COL, pricing will be COM or COL + 5%.
- If both COM + COL are used in combination, use COL + 5%.

Product Features

- Frame is constructed of kiln-dried European beech, PEFC Certified sustainable yield, perpetuating premium quality and durability.
- Upholstered seat, back and arms
- Joints are securely fastened with mortise and tenon joinery as well as corner block construction.
- MAS IAQ Certified
- Seat cushions are made of high resiliency foam.
- Seat rails are reinforced with tenon and groove corner blocks and cleats.
- Seat suspension is constructed of 3/4" thick Baltic Birch plywood.
- Sheet webbing

Guest - Monroe

Monroe Guest Chair
Open Wooden Back

[Click here to view statement of line](#)

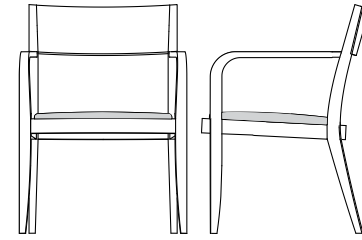

1 Model EMN2332OWB02

w" x d" x h"
23.25 x 23 x 32
Arm Height 25 -1/4"
Seat Height 18"
Inside Seat Depth 20"
Inside Seat Width 20 -3/4"

COM	COL	1	2	3	4	5	6	7	8	9	10	11/L1	12	13/L2
1242	1260	1270	1284	1298	1312	1326	1340	1354	1368	1382	1396	1410	1424	1452

Upholstery Requirements
Fabric yds: 0.75 Leather Sq. Ft.: 13.5
Carton Weight: 25

2 Select Finish

[Click to view finishes](#)

WLO Lofty Oak
WAC Amber Cherry
WIC Crimson Cherry
WHC Honey Cherry
WOC KoKo Cherry
WEC Ebony
WAM Alabaster Maple
WCM Clear Maple
WMO Mocha Oak
WNO Natural Oak
WSO Salted Oak
WEW Executive Walnut
WGW Gunstock Walnut
WBW Henna Walnut
WSW Smokey Walnut
WNW Natural Walnut
WWW Weathered Walnut
WWP Designer White Paint
SSL Skyline Walnut Paint
SSM Seattle Mist Paint
TBCO Baby's Cheek
TBSW Brown Sugar
TSTV Studio Teak Walnut
TOBW Organic Brown
SNA Narvik Ash

3 Combination Fabrics

[Click to view finishes](#)

Combination
Fabric Option
Not Available

Product Features

- Frame is constructed of kiln-dried European beech, PEFC Certified sustainable yield, perpetuating premium quality and durability.
- Joints are securely fastened with mortise and tenon joinery as well as corner block construction.
- MAS IAQ Certified
- Open Arms
- Open Wood Back
- Seat cushions are made of high resiliency foam with proper density to give comfort and support
- Seat rails are reinforced with tenon and groove corner blocks and cleats.
- Seat suspension is constructed of 3/4" thick Baltic Birch plywood.
- Sheet webbing
- Upholstered Seat

Guest - Monroe

Monroe Guest Chair
Half Upholstered Back

[Click here to view statement of line](#)

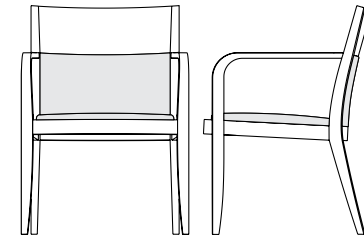

1 Model EMN2332HUB04

w" x d" x h"
23.25 x 23 x 32
Arm Height 25 -1/4"
Seat Height 18"
Inside Seat Depth 20"
Inside Seat Width 20 -3/4"

COM	COL	1	2	3	4	5	6	7	8	9	10	11/L1	12	13/L2
1313	1340	1359	1382	1405	1428	1451	1474	1497	1520	1543	1566	1589	1612	1658

Upholstery Requirements
Fabric yds: 1.25 Leather Sq. Ft.: 22.5
Carton Weight: 25

2 Select Finish

[Click to view finishes](#)

- WLO Lofty Oak
- WAC Amber Cherry
- WIC Crimson Cherry
- WHC Honey Cherry
- WOC KoKo Cherry
- WEC Ebony
- WAM Alabaster Maple
- WCM Clear Maple
- WMO Mocha Oak
- WNO Natural Oak
- WSO Salted Oak
- WEW Executive Walnut
- WGW Gunstock Walnut
- WBW Henna Walnut
- WSW Smokey Walnut
- WNW Natural Walnut
- WWW Weathered Walnut
- WWP Designer White Paint
- SSL Skyline Walnut Paint
- SSM Seattle Mist Paint
- TBCO Baby's Cheek
- TBSW Brown Sugar
- TSTV Studio Teak Walnut
- TOBW Organic Brown
- SNA Narvik Ash

3 Combination Fabrics

[Click to view finishes](#)

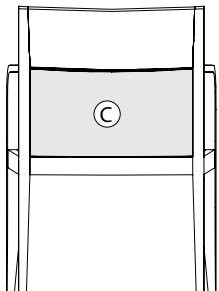
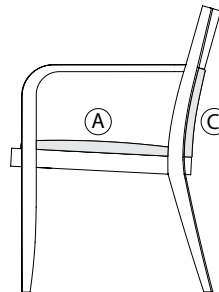
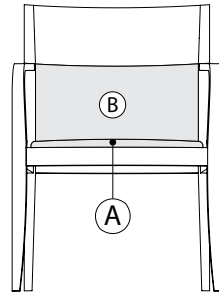

(Back View)

SIN: 33721

DARRAN is pleased to offer customers the design freedom of combination fabrics. When using fabric, vinyl or leather combinations, pricing/yardage requirements will be as follows:

- A Seat 1 yd(s).
- B Inside Back 0.25 yd(s)
- C Outside Back 0.25 yd(s)

- When combining two materials of the same grade, pricing will be specified grade + 5%
- If combining two materials of different grades or leather/fabric combination, use the highest grade/price + 5%
- If using COM or COL, pricing will be COM or COL + 5%.
- If both COM + COL are used in combination, use COL + 5%.

Product Features

- Frame is constructed of kiln-dried European beech, PEFC Certified sustainable yield, perpetuating premium quality and durability.
- Half Upholstered/Half Wood Back
- Joints are securely fastened with mortise and tenon joinery as well as corner block construction.
- MAS IAQ Certified
- Open Arms
- Seat cushions are made of high resiliency foam with proper density to give comfort and support
- Seat rails are reinforced with tenon and groove corner blocks and cleats.
- Seat suspension is constructed of 3/4" thick Baltic Birch plywood.
- Sheet webbing
- Upholstered Seat

Guest - Monroe

Monroe Guest Chair
Fully Upholstered Back

[Click here to view statement of line](#)

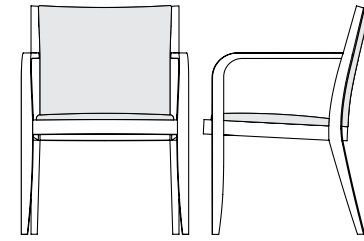

1 Model EMN2332FUB06

w" x d" x h"
23.25 x 23 x 32
Arm Height 25 -1/4"
Seat Height 18"
Inside Seat Depth 20"
Inside Seat Width 20 -3/4"

COM	COL	1	2	3	4	5	6	7	8	9	10	11/L1	12	13/L2
1282	1314	1347	1379	1411	1443	1475	1507	1539	1571	1603	1635	1667	1699	1763

Upholstery Requirements
Fabric yds: 1.75 Leather Sq. Ft.: 31.5
Carton Weight: 25

2 Select Finish

[Click to view finishes](#)

WLO Lofty Oak
WAC Amber Cherry
WIC Crimson Cherry
WHC Honey Cherry
WOC KoKo Cherry
WEC Ebony
WAM Alabaster Maple
WCM Clear Maple
WMO Mocha Oak
WNO Natural Oak
WSO Salted Oak
WEW Executive Walnut
WGW Gunstock Walnut
WBW Henna Walnut
WSW Smokey Walnut
WNW Natural Walnut
WWW Weathered Walnut
WWP Designer White Paint
SSL Skyline Walnut Paint
SSM Seattle Mist Paint
TBCO Baby's Cheek
TBSW Brown Sugar
TSTV Studio Teak Walnut
TOBW Organic Brown
SNA Narvik Ash

3 Combination Fabrics

[Click to view finishes](#)

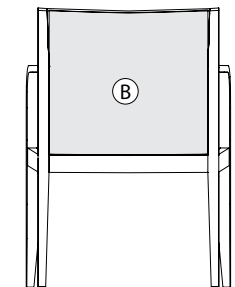
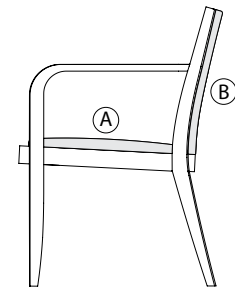
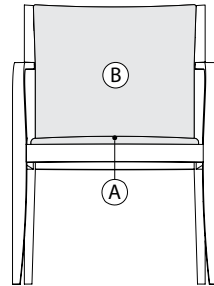

(Back View)

SIN: 33721

DARRAN is pleased to offer customers the design freedom of combination fabrics. When using fabric, vinyl or leather combinations, pricing/yardage requirements will be as follows:

A Seat 1 yd(s).
B Inside/Outside Back 1.5 yd(s).

- When combining two materials of the same grade, pricing will be specified grade + 5%
- If combining two materials of different grades or leather/fabric combination, use the highest grade/price + 5%
- If using COM or COL, pricing will be COM or COL + 5%.
- If both COM + COL are used in combination, use COL + 5%.

Product Features

- Frame is constructed of kiln-dried European beech, PEFC Certified sustainable yield, perpetuating premium quality and durability.
- Fully Upholstered Seat and Back
- Joints are securely fastened with mortise and tenon joinery as well as corner block construction.
- MAS IAQ Certified
- Open Arms
- Seat cushions are made of high resiliency foam with proper density to give comfort and support
- Seat rails are reinforced with tenon and groove corner blocks and cleats.
- Seat suspension is constructed of 3/4" thick Baltic Birch plywood.
- Sheet webbing

Guest - Silo

Silo Guest Chair
Maple & Tech Walnut



[Click here to view statement of line](#)

1 Model SIL2332NWB17

w" x d" x h"
17.5 x 21 x 35.5
Arm Height N/A
Seat Height 18.5"
Inside Seat Depth 16"
Inside Seat Width 17.5"

COM	COL	1	2	3	4	5	6	7	8	9	10	11/L1	12	13/L2
586	N/A													

Upholstery Requirements
Fabric yds: N/A Leather Sq. Ft.: N/A
Carton Weight:

Product Features

- 1 Piece molded plywood shell standard in maple veneer (Tech-grain walnut veneer optional)
- Polished chrome base
- Add 25% to list price for Tech Walnut finishes
- Ships assembled
- Can stack up to 8 chairs

2 Select Finish

[Click to view finishes](#)

- WLO Lofty Oak
- WAC Amber Cherry
- WIC Crimson Cherry
- WHC Honey Cherry
- WOC KoKo Cherry
- WEC Ebony
- WAM Alabaster Maple
- WCM Clear Maple
- WAM Alabaster Maple
- WCM Clear Maple
- WMO Mocha Oak
- WNO Natural Oak
- WSO Salted Oak
- WEW Executive Walnut
- WGW Gunstock Walnut
- WBW Henna Walnut
- WSW Smokey Walnut
- WNW Natual Walnut
- WWW Weathered Walnut
- RWV +25% Clear Tech-grain
- TBCO +25% Baby's Cheek
- TBSW +25% Brown Sugar
- TSTV +25% Studio Teak Walnut
- TSMV +25% Seattle Mist
- TOBW +25% Organic Brown
- PM01 Olive
- PM02 Aquavert
- PM03 Mushroom
- PM07 Pebble
- PM08 Vapour
- PM10 Verde

3 Combination Fabrics

[Click to view finishes](#)

Combination
Fabric Option
Not Available

Guest - Silo

Silo Barstool
Maple & Tech Walnut

[Click here to view statement of line](#)



1 Model SIL2332BAR38

w" x d" x h"
17.5 x 21 x 45.5
Arm Height N/A
Seat Height 29.5"
Inside Seat Depth 16"
Inside Seat Width 17.5"

COM	COL	1	2	3	4	5	6	7	8	9	10	11/L1	12	13/L2
749	N/A													

Upholstery Requirements
Fabric yds: N/A Leather Sq. Ft.: N/A
Carton Weight:

Product Features

- 1 Piece molded plywood shell standard in maple veneer (Tech-grain walnut veneer optional)
- Polished chrome base
- Add 25% to list price for Tech Walnut finishes
- Ships assembled

2 Select Finish

[Click to view finishes](#)

- WLO Lofty Oak
- WAC Amber Cherry
- WIC Crimson Cherry
- WHC Honey Cherry
- WOC KoKo Cherry
- WEC Ebony
- WAM Alabaster Maple
- WCM Clear Maple
- WAM Alabaster Maple
- WCM Clear Maple
- WMO Mocha Oak
- WNO Natural Oak
- WSO Salted Oak
- WEW Executive Walnut
- WGW Gunstock Walnut
- WBW Henna Walnut
- WSW Smokey Walnut
- WNW Natual Walnut
- WWW Weathered Walnut
- RWV +25% Clear Tech-grain
- TBCO +25% Baby's Cheek
- TBSW +25% Brown Sugar
- TSTV +25% Studio Teak Walnut
- TSMV +25% Seattle Mist
- TOBW +25% Organic Brown
- PM01 Olive
- PM02 Aquavert
- PM03 Mushroom
- PM07 Pebble
- PM08 Vapour
- PM10 Verde

3 Combination Fabrics

[Click to view finishes](#)

Combination
Fabric Option
Not Available



Occasional Price List

Effective November 1, 2022

Date	Page	Modification	Description
6.8.22	10	Added Teak Table	Added Teak Table
10.24.22	4, 14-19	Add/Removed Edges	Added Ledge, Prado, Capitol, NSS Bevel and Lamina Cell edges removed discontinued edges.
11.08.22		Price Increase	9% price increase applied on all items excluding options
02.08.23	10	Removed price increase from Teak	
02.27.23		9% Price increase applied to Grove	
03.15.23		Removed Anodized Aluminum Standoffs from Around Town Tables	
05.15.23		Removed WLA and added WLO and WLF finish	
06.21.23		Added the WWW finish	

Statement of Line
Finishes1
Edges | Pulls | Knobs2
Around Town Tables.....3
Cell Tables4
Fluted Post Tables.....5
Grove Tables.....7
Jackson Tables11
Lamina Tables.....14
Trade Street Tables.....15
Zum Tables.....19

Statement of Line

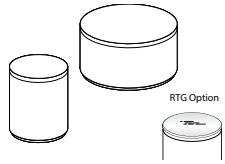

Page 3
Around Town Tables
Plinthe Table

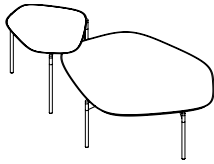

Page 4
Cell Tables
Cocktail Table And End Table



Page 5
Fluted Post Tables
Cocktail Table



Page 6
Fluted Post Tables
Console Table



Page 7
Grove Small Round Table
Acacia Stool/Round Table



Page 8
Grove Square Table
Acacia Stool/Square Table



Page 9
Grove Round Table
Acacia Stool/Round Table



Page 10
Teak Square
Cocktail/Coffee/Side Table

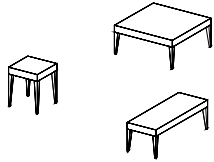

Page 11
Jackson Tables
Square End Table/Cocktail

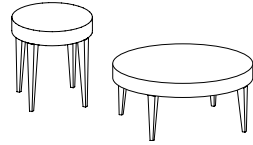

Page 12
Jackson Tables
Round Table

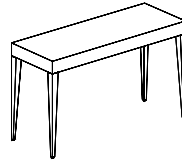

Page 13
Jackson Tables
Console Tables



Page 14
Lamina Tables
End Table/Coffee Table



Page 15
Trade Street Tables
Square Table



Page 16
Trade Street Tables
Round Table



Page 17
Trade Street Tables
Cocktail Table



Page 18
Trade Street Tables
Console Table

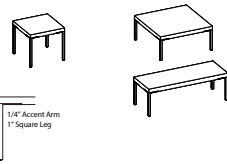

Page 19
Zum Table
End Table/Cocktail Table

STANDARD VENEER	PREMIUM VENEER	HIGH PRESSURE LAMINATE	THERMALLY FUSED LAMINATE
WAC Amber Cherry.....	N/A.....	GAC Amber Cherry.....	MAC Amber Cherry
WIC Crimson Cherry.....	N/A.....	GIC Crimson Cherry.....	N/A
WHC Honey Cherry.....	N/A.....	GHC Honey Cherry.....	N/A
WOC KoKo Cherry.....	N/A.....	GOC KoKo Cherry.....	MOC KoKo Cherry
WEC Ebony Cherry.....	N/A.....	GEC Ebony Cherry.....	N/A
WAM Alabaster Maple.....	N/A.....	GAM Alabaster Maple.....	N/A
WCM Clear Maple.....	N/A.....	GCM Clear Maple.....	N/A
N/A.....	WMO Mocha Oak.....	N/A.....	N/A
N/A.....	WNO Natural Oak.....	N/A.....	N/A
N/A.....	WSO Salted Oak.....	N/A.....	N/A
WLF Lofty Oak on Flat Cut.....	WLO Lofty Oak.....	N/A.....	N/A
WNF Natural Oak on Flat Cut.....	N/A.....	N/A.....	N/A
WMF Mocha Oak on Flat Cu.....	N/A.....	N/A.....	N/A
WSF Salted Oak on Flat Cut.....	N/A.....	N/A.....	N/A
WEW Executive Walnut.....	N/A.....	GEW Executive Walnut.....	N/A
WGW Gunstock Walnut.....	N/A.....	N/A.....	MGW Gunstock Walnut
WBW Henna Walnut.....	N/A.....	N/A.....	N/A
WSW Smokey Walnut.....	N/A.....	N/A.....	N/A
WWW Weathered Walnut.....	N/A.....	N/A.....	N/A
WNW Natural Walnut.....	N/A.....	GNW Natural Walnut.....	N/A
N/A.....	TBCO Baby's Cheek.....	N/A.....	N/A
N/A.....	TBSW Brown Sugar.....	N/A.....	N/A
N/A.....	TOBW Organic Brown.....	N/A.....	N/A
N/A.....	TSTV Studio Teak Walnut.....	GSTV Studio Teak Walnut.....	MTW Studio Teak Walnut
N/A.....	TSMV Seattle Mist.....	N/A.....	N/A
N/A.....	TSLV Skyline Walnut.....	GSLV Skyline Walnut.....	N/A
WWP Designer White Paint.....	N/A.....	GWL Designer White.....	MWL Designer White

Note: Finish availability differs on each product. please see specific product page for availability.



Finish

Welltech Finish delivers a superior furniture coating with exceptional performance that can withstand stringent cleaning agents and possesses unparalleled durability, allowing DARRAN to provide lasting, sustainable products to our customers.

Check Collection Pages for Available Edges

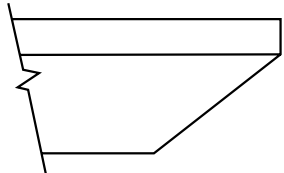

NSS Bevel

3mm solid
hardwood band

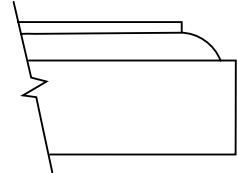

Classic

3mm solid
hardwood band

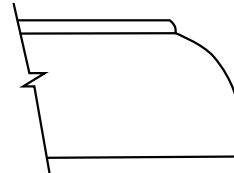

Waterfall

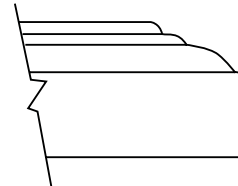

Traditional

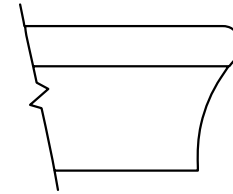

Knife

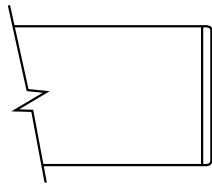

Flat

"W" 3mm solid hardwood band
"P" 3mm solid hardwood band
"G" HPL self edge

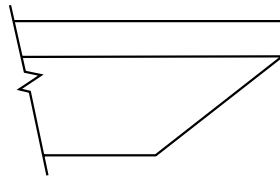

Ledge

"W" 3mm Solid Hardwood Band
"P" 3mm Solid Hardwood Band
"G" HPL Self Edge

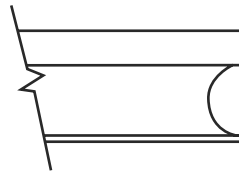

Prado

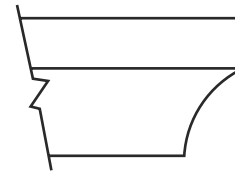

Capitol

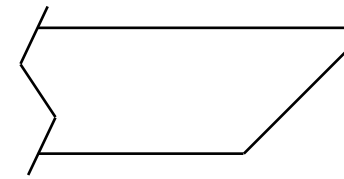

Lamina | Cell

Pulls/knobs

Factory Installed

PL-5 Antique Brass
PL-50 Brushed Pewter

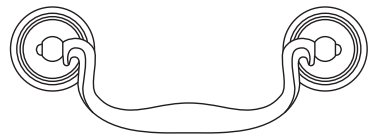

PL-4 Antique Brass



Note: edge and hardware availability differs on each product. please see specific product page for availability.

Occasional

Around Town Tables
Plinthe Table

[Click here to view statement of line](#)

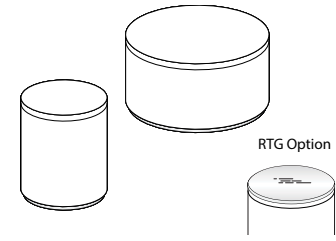

1 Select Model

w" x d" x h"
Cocktail
36 dia x 16
30 dia x 16
End
24 dia x 22
18 dia x 22

Weight	Standard Veneer Top Standard Veneer	Premium Veneer Top Premium Veneer Chassis	High Pressure Laminate Top Veneer Chassis	Thermally Fused Laminate Top Thermally Fused Laminate Chassis
70	DBO3636RT372W 2597	DBO3636RT372P 2857	DBO3636RT372G 2597	"M" Option N/A
55	DBO3030RT372W 2403	DBO3030RT372P 2644	DBO3030RT372G 2403	"M" Option N/A
45	DBO2424RT372W 1687	DBO2424RT372P 1856	DBO2424RT372G 1687	"M" Option N/A
40	DBO1818RT372W 1619	DBO1818RT372P 1782	DBO1818RT372G 1619	"M" Option N/A

Product Features

- 1" Top with 3mm wood edge
- Plinthe base with black or optional silver accent
- Glides

Notes

- Available in maple veneer only. Cherry and walnut finishes are matched on maple veneer.
- Contact Customer Service for Stone/Solid Surface accent tops.

Options

Frosted Glass Top

- RTG22: 17" dia Frosted glass top - \$365
- RTG24: 23" dia Frosted glass top - \$390
- RTG26: 29" dia Frosted glass top - \$570
- RTG28: 35" dia Frosted glass top - \$755

Clear Glass Top

- RTG12: 17" dia Clear glass top - \$260
- RTG14: 23" dia Clear glass top - \$290
- RTG16: 29" dia Clear glass top - \$415
- RTG18: 35" dia Clear glass top - \$550

2 Select Finish

[Click to view finishes](#)

WAC	WNW	WMF(Mocha
WIC	WWW	Oak on Flat
WHC	WLF(Lofty	Cut)
WOC	Oak on Flat	
WEC	Cut)	
WAM	WNF(Natural	
WCM	Oak on Flat	
WEW	Cut)	
WGW	WSF(Salted	
WBW	Oak on Flat	
WSW	Cut)	

WLO
WMO
WNO
WSO

GAC
GIC
GHC
GOC
GEC
GAM
GCM
GEW
GNW

3 Select Edge

[Click to view edges](#)

Edge
N/A

Edge
N/A

Edge
N/A

4 Select Hardware

[Click to view details](#)

Hardware
N/A

Hardware
N/A

Hardware
N/A

Occasional

Cell Tables
Cocktail Table And End Table

[Click here to view statement of line](#)

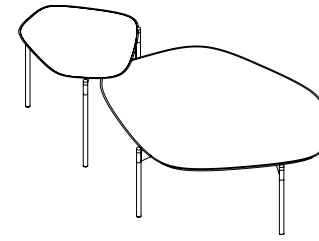

1 Select Model

w" x d" x h"
End Table
23 x 19 x 17.75
Cocktail Table
42 x 32 x 14.25

Weight	Standard Veneer Top Black Metal Base	Premium Veneer Top Black Metal Base	High Pressure Laminate Top Black Metal Base	Thermally Fused Laminate Top Black Metal Base
60	CEL2319MT366W 1304	CEL2319MT366P 1435	CEL2319MT366G 1304	"M" Option N/A
85	CEL4232MT369W 1812	CEL4232MT369P 1994	CEL4232MT369G 1812	"M" Option N/A

Product Features

- 1" Thick top
- Black Metal Finish standard (available in white and silver)
- Shipped KD

Options

Metal Finishes

- Specify Metal Finish leg color. End table - \$80 upcharge. Cocktail table - \$100 upcharge.
- MFW: White, MFS: Silver

2 Select Finish

[Click to view finishes](#)

WAC	WNW	WMF(Mo-cha Oak on Flat Cut)	WLO	TOBW	GAC	GSLV
WIC	WWW		WMO		GIC	GWL
WHC	WLF(Lofty Oak on Flat Cut)		WNO		GHC	
WOC	WOC		WSO		GOC	
WEC	WEC		WOW		GEC	
WAM	WAM		TBCO		GAM	
WCM	WCM		TBSW		GCM	
WEW	WEW		TSTV		GEW	
WGW	WGW		TSMV		GNW	
WBW	WBW		TSLV		GSTV	
WSW	WSW					

3 Select Edge

[Click to view edges](#)



Edge N/A

4 Select Hardware

[Click to view details](#)

Hardware N/A

Occasional

Fluted Post Tables
Cocktail Table

[Click here to view statement of line](#)

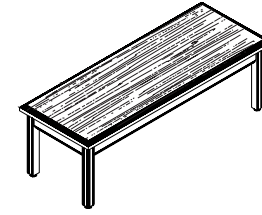

1 Select Model

w" x d" x h"
Bookmatch Face
Cocktail
18 x 48 x 16
36 x 36 x 16
End
24 x 24 x 20
18 x 18 x 20

Weight

Standard Veneer Top Standard Hardwood Base	Premium Veneer Top Premium Hardwood Base	High Pressure Laminate Top Standard Hardwood Base	Thermally Fused Laminate Top Standard Hardwood Base
---	---	--	--

DBO1848FT351W 1629	"P" Option N/A	DBO1848FT351G 1629	"M" Option N/A
DBO3636FT351W 1667	"P" Option N/A	DBO3636FT351G 1667	"M" Option N/A
DBO2424FT351W 1335	"P" Option N/A	DBO2424FT351G 1335	"M" Option N/A
DBO1818FT351W 1077	"P" Option N/A	DBO1818FT351G 1077	"M" Option N/A

Product Features

- 1-5/16" Thick top
- Floor levelers (adjustable 1/2")
- Solid hardwood base legs

Notes

- Tables are available in Cherry and Walnut Finishes

2 Select Finish

[Click to view finishes](#)

WAC
WIC
WHC
WOC
WEC
WAM
WCM
WEW
WGW
WBW
WSW

WNW
WWW

GAC
GIC
GHC
GOC
GEC
GEW
GNW

3 Select Edge

[Click to view edges](#)



Classic



Traditional



Classic



Traditional

4 Select Hardware

[Click to view details](#)

Hardware
N/A

Hardware
N/A

Occasional

Fluted Post Tables Console Table

[Click here to view statement of line](#)

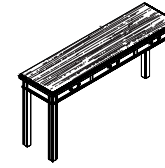

1 Select Model

w" x d" x h"
Bookmatch Face
16 x 60 x 29
16 x 48 x 29

Weight

85
75

Standard Veneer Top Standard Hardwood Base	Premium Veneer Top Premium Hardwood Base	High Pressure Laminate Top Standard Hardwood Base	Thermally Fused Laminate Top Standard Hardwood Base
---	---	--	--

DBO1660JW361W 2146
DBO1648JW361W 1978

"P" Option N/A
"P" Option N/A

DBO1660JW361G 2146
DBO1648JW361G 1978

"M" Option N/A
"M" Option N/A

Product Features

- 1-5/16" Thick top
- Floor levelers (adjustable 1/2")
- Solid hardwood base legs

Notes

- Tables are available in Cherry and Walnut Finishes

2 Select Finish

[Click to view finishes](#)

WAC
WIC
WHC
WOC
WEC
WAM
WCM
WEW
WGW
WBW
WSW

WNW
WWW

GAC
GIC
GHC
GOC
GEC
GEW
GNW

3 Select Edge

[Click to view edges](#)



Classic Traditional



Classic Traditional

4 Select Hardware

[Click to view details](#)



PL-4 Antique Brass



PL-5 Antique Brass
PL-50 Brushed Pewter



PL-4 Antique Brass



PL-5 Antique Brass
PL-50 Brushed Pewter

Occasional

Grove Small Round Table
Acacia Stool/Round Table

[Click here to view statement of line](#)



1 Select Model

w" x d" x h"
12 dia x 17
* Stool/Table depth varies

Weight

Live Edge	
-----------	--

GRO1217AS372W	564
---------------	-----

2 Select Finish

[Click to view finishes](#)

WLE

3 Select Edge

[Click to view edges](#)

Edge
N/A

4 Select Hardware

[Click to view details](#)

Hardware
N/A

Product Features

Notes

- Butterflies are hand placed based on the tables natural characteristic
- Every stool is unique with live edge detailing
- Natural cracks in the wood are considered normal and enhance the beauty of the stool

Occasional

Grove Square Table

Acacia Stool/Square Table

[Click here to view statement of line](#)



1 Select Model

w" x d" x h"
12 x 12 x 18
* Stool/Table depth varies

Weight

Live Edge	
-----------	--

GRO1212CM373W 813

Product Features

Notes

- Butterflies are hand placed based on the tables natural characteristic
- Every stool is unique with live edge detailing
- Natural cracks in the wood are considered normal and enhance the beauty of the stool
- Stools are cut from the Acacia Tree and has figured grain with distinct sap line edges

2 Select Finish

[Click to view finishes](#)

WLE

3 Select Edge

[Click to view edges](#)

Edge
N/A

4 Select Hardware

[Click to view details](#)

Hardware
N/A

Occasional

Grove Round Table
Acacia Stool/Round Table

[Click here to view statement of line](#)



1 Select Model

w" x d" x h"
16 dia x 21
* Stool/Table depth varies

Weight

Live Edge

GRO1621AS372W 1140

2 Select Finish

[Click to view finishes](#)

WLE

3 Select Edge

[Click to view edges](#)

Edge
N/A

4 Select Hardware

[Click to view details](#)

Hardware
N/A

Product Features

Notes

- Butterflies are hand placed based on the tables natural characteristic
- Every stool is unique with live edge detailing
- Natural cracks in the wood are considered normal and enhance the beauty of the stool

Occasional

Teak Square
Cocktail/Coffee/Side Table

[Click here to view statement of line](#)

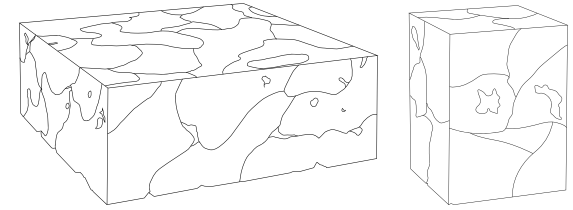

1 Select Model

w" x d" x h"
Cocktail/Coffee Table
39 x 39 x 15
47 x 31 x 15
Side Table
14 x 14 x 19

Weight

Natural Brown Finish

85	DBO3939TK369W	2905
85	DBO4731TK369W	2905
40	DBO1414TK366W	865

2 Select Finish

[Click to view finishes](#)

WNB

3 Select Edge

[Click to view edges](#)

Edge
N/A

4 Select Hardware

[Click to view details](#)

Hardware
N/A

Product Features

Notes

- Crafted from scrap pieces of teak wood that are hand assembled.
- Color and character of wood grain may vary.
- Natural cracks and holes will be present.
- Tables are hollow, reducing weight.

Occasional

Jackson Tables

Square End Table/Cocktail

[Click here to view statement of line](#)

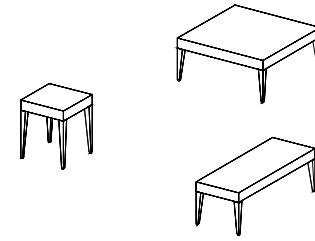

1 Select Model

w" x d" x h"

End Table

24 x 24 x 22

18 x 18 x 22

Cocktail Table

48 x 18 x 16

42 x 42 x 16

36 x 36 x 16

Weight

Standard Veneer Top Standard Hardwood Base	Premium Veneer Top Premium Hardwood Base	High Pressure Laminate Top Standard Hardwood Base	Thermally Fused Laminate Top Standard Hardwood Base
---	---	--	--

40	DBO2424JK366W 1373	"P" Option N/A	DBO2424JK366G 1373	"M" Option N/A
35	DBO1818JK366W 1288	"P" Option N/A	DBO1818JK366G 1288	"M" Option N/A
50	DBO4818JK369W 1863	"P" Option N/A	DBO4818JK369G 1863	"M" Option N/A
65	DBO4242JK369W 2074	"P" Option N/A	DBO4242JK369G 2074	"M" Option N/A
55	DBO3636JK369W 1948	"P" Option N/A	DBO3636JK369G 1948	"M" Option N/A

Product Features

- 3-3/4" Thick top
- Flat-cut w/ reverse slip-matched veneer
- Glides
- Tapered solid hardwood legs

2 Select Finish

[Click to view finishes](#)

- WAC
- WIC
- WHC
- WOC
- WEC
- WCM
- WEW
- WGW
- WBW
- WSW
- WNW

WWW

- GAC
- GIC
- GHC
- GOC
- GEC
- GCM
- GEW
- GNW

3 Select Edge

[Click to view edges](#)

Edge
N/A

Edge
N/A

4 Select Hardware

[Click to view details](#)

Hardware
N/A

Hardware
N/A

Occasional

Jackson Tables Round Table

[Click here to view statement of line](#)

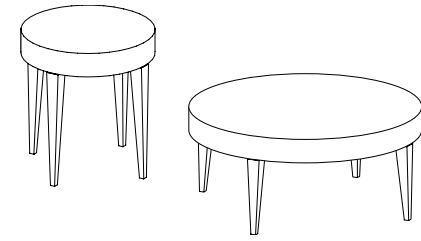

1 Select Model

w" x d" x h"

End Table

24 dia x 22

18 dia x 22

Cocktail Table

42 dia x 16

36 dia x 16

Weight

Standard Veneer Top Standard Hardwood Base	Premium Veneer Top Premium Hardwood Base	High Pressure Laminate Top Standard Hardwood Base	Thermally Fused Laminate Top Standard Hardwood Base
---	---	--	--

40	DBO2424JK367W 1625	"P" Option N/A	DBO2424JK367G 1625	"M" Option N/A
35	DBO1818JK367W 1379	"P" Option N/A	DBO1818JK367G 1379	"M" Option N/A
65	DBO4242JK367W 2340	"P" Option N/A	DBO4242JK367G 2340	"M" Option N/A
55	DBO3636JK367W 2048	"P" Option N/A	DBO3636JK367G 2048	"M" Option N/A

Product Features

- 3-3/4" Thick top
- Flat-cut w/ reverse slip-matched veneer
- Glides
- Tapered solid hardwood legs

2 Select Finish

[Click to view finishes](#)

- WAC
- WIC
- WHC
- WOC
- WEC
- WCM
- WEW
- WGW
- WBW
- WSW
- WNW

WWW

- GAC
- GIC
- GHC
- GOC
- GEC
- GCM
- GEW
- GNW

3 Select Edge

[Click to view edges](#)

Edge
N/A

Edge
N/A

4 Select Hardware

[Click to view details](#)

Hardware
N/A

Hardware
N/A

Occasional

Jackson Tables
Console Tables

[Click here to view statement of line](#)

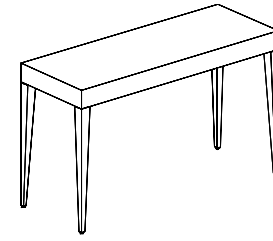

1 Select Model

w" x d" x h"
Square Console Table
48 x 18 x 29

Weight

60

Standard Veneer Top Standard Hardwood Base	Premium Veneer Top Premium Hardwood Base	High Pressure Laminate Top Standard Hardwood Base	Thermally Fused Laminate Top Standard Hardwood Base
---	---	--	--

DBO4818JK361W 1991	"P" Option N/A	DBO4818JK361G 1991	"M" Option N/A
--------------------	----------------	--------------------	----------------

Product Features

- 3-3/4" Thick top
- Flat-cut w/ reverse slip-matched veneer
- Glides
- Tapered solid hardwood legs

2 Select Finish

[Click to view finishes](#)

- WAC
- WIC
- WHC
- WOC
- WEC
- WCM
- WEW
- WGW
- WBW
- WSW
- WNW

WWW

- GAC
- GIC
- GHC
- GOC
- GEC
- GCM
- GEW
- GNW

3 Select Edge

[Click to view edges](#)

Edge
N/A

Edge
N/A

4 Select Hardware

[Click to view details](#)

Hardware
N/A

Hardware
N/A

Occasional

Lamina Tables
End Table/Coffee Table

[Click here to view statement of line](#)

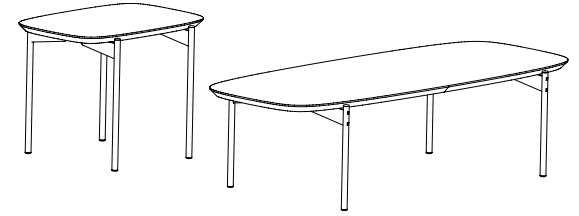

1 Select Model

w" x d" x h"
End Table
23.25 x 15.75 x 17.5
Coffee Table
52.5 x 21.5 x 14.25

Weight

Standard Veneer Top Black Metal Base	Premium Veneer Top Black Metal Base	High Pressure Laminate Top Black Metal Base	Thermally Fused Laminate Top Black Metal Base
LAM2315MT359W 1459	LAM2315MT359P 1605	LAM2315MT359G 1459	"M" Option N/A
LAM5221MT359W 1767	LAM5221MT359P 1945	LAM5221MT359G 1767	"M" Option N/A

Product Features

- 1" Thick top
- Black Metal Finish standard
- Shipped KD

Options

Quartered Veneer

- QW1: Quartered Walnut Veneer Upgrade - 5% upcharge

Metal Finishes

- Specify Metal Finish leg color: \$105 upcharge
- MFB: Black, MFW: White, MFS: Silver

2 Select Finish

[Click to view finishes](#)

WAC	WNW	Cut)
WIC	WWP	WMF(Mocha
WHC	WWW	Oak on Flat
WOC	WLF(Lofty	Cut)
WEC	Oak on Flat	
WAM	Cut)	
WCM	WNF(Natural	
WEW	Oak on Flat	
WGW	Cut)	
WBW	WSF(Salted	
WSW	Oak on Flat	

WLO	TOBW
WMO	
WNO	
WSO	
WOW	
TBCO	
TBSW	
TSTV	
TSMV	
TSLV	

GEC	GSLV
GAC	GWL
GIC	
GHC	
GOC	
GAM	
GCM	
GEW	
GNW	
GSTV	

3 Select Edge

[Click to view edges](#)



Edge
N/A

Edge
N/A

4 Select Hardware

[Click to view details](#)

Hardware
N/A

Hardware
N/A

Hardware
N/A

Occasional

Trade Street Tables
Square Table

[Click here to view statement of line](#)



1 Select Model

w" x d" x h"
Bookmatch Face
Cocktail
36 x 36 x 16
End
24 x 24 x 20
18 x 18 x 20

Weight

Standard Veneer Top Standard Hardwood Base	Premium Veneer Top Premium Hardwood Base	High Pressure Laminate Top Standard Hardwood Base	Thermally Fused Laminate Top Standard Hardwood Base
---	---	--	--

DBO3636TT366W 1415	"P" Option N/A	DBO3636TT366G 1415	"M" Option N/A
DBO2424TT366W 1242	"P" Option N/A	DBO2424TT366G 1242	"M" Option N/A
DBO1818TT366W 1165	"P" Option N/A	DBO1818TT366G 1165	"M" Option N/A

Product Features

- 1-5/16" Thick top
- Glides
- Solid hardwood base and legs

Notes

- Tables are available in Cherry, Maple and Walnut Finishes

2 Select Finish

[Click to view finishes](#)

WAC
WIC
WHC
WOC
WEC
WCM
WEW
WGW
WBW
WSW
WNW

WWW

GAC
GIC
GHC
GOC
GCM
GEW
GNW

3 Select Edge

[Click to view edges](#)

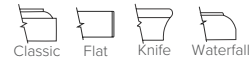
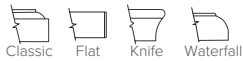

4 Select Hardware

[Click to view details](#)

Hardware
N/A

Hardware
N/A

Occasional

Trade Street Tables
Round Table

[Click here to view statement of line](#)



1 Select Model

w" x d" x h"
Bookmatch Face
Cocktail
36 dia x 16
End
24 dia x 20
18 dia x 20

Weight

Standard Veneer Top Standard Hardwood Base	Premium Veneer Top Premium Hardwood Base	High Pressure Laminate Top Standard Hardwood Base	Thermally Fused Laminate Top Standard Hardwood Base
---	---	--	--

45 DBO3636TT367W 1576 35 DBO2424TT367W 1380 30 DBO1818TT367W 1289	"P" Option N/A "P" Option N/A "P" Option N/A	DBO3636TT367G 1576 DBO2424TT367G 1380 DBO1818TT367G 1289	"M" Option N/A "M" Option N/A "M" Option N/A
---	--	--	--

Product Features

- 1-5/16" Thick top
- Glides
- Solid hardwood base and legs

Notes

- Tables are available in Cherry, Maple and Walnut Finishes

2 Select Finish

[Click to view finishes](#)

WAC
WIC
WHC
WOC
WEC
WCM
WEW
WGW
WBW
WSW
WNW

WWW

GAC
GIC
GHC
GOC
GCM
GEW
GNW

3 Select Edge

[Click to view edges](#)

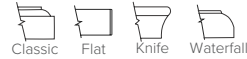
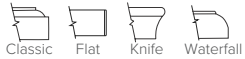

4 Select Hardware

[Click to view details](#)

Hardware
N/A

Hardware
N/A

Occasional

Trade Street Tables
Cocktail Table

[Click here to view statement of line](#)

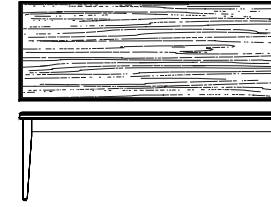

1 Select Model

w" x d" x h"
Bookmatch Face
18 x 48 x 16

Weight

50

Standard Veneer Top Standard Hardwood Base	Premium Veneer Top Premium Hardwood Base	High Pressure Laminate Top Standard Hardwood Base	Thermally Fused Laminate Top Standard Hardwood Base
DBO1848TT369W 1576	"P" Option N/A	DBO1848TT369G 1576	"M" Option N/A

Product Features

- 1-5/16" Thick top
- Glides
- Solid hardwood base and legs

Notes

- Tables are available in Cherry, Maple and Walnut Finishes

2 Select Finish

[Click to view finishes](#)

- WAC
- WIC
- WHC
- WOC
- WEC
- WCM
- WEW
- WGW
- WBW
- WSW
- WNW

WWW

- GAC
- GIC
- GHC
- GOC
- GCM
- GEW
- GNW

3 Select Edge

[Click to view edges](#)

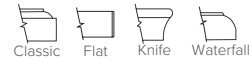
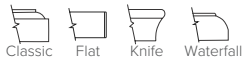

4 Select Hardware

[Click to view details](#)

Hardware
N/A

Hardware
N/A

Occasional

Trade Street Tables Console Table

[Click here to view statement of line](#)

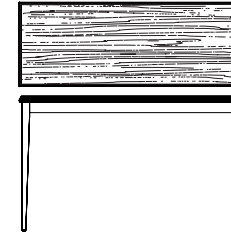

1 Select Model

w" x d" x h"
Bookmatch Face
18 x 60 x 29
18 x 48 x 29

Weight

Standard Veneer Top Standard Hardwood Base		Premium Veneer Top Premium Hardwood Base		High Pressure Laminate Top Standard Hardwood Base		Thermally Fused Laminate Top Standard Hardwood Base	
---	--	---	--	--	--	--	--

70
60

DBO1860TT361W 2054
DBO1848TT361W 1734

"P" Option N/A
"P" Option N/A

DBO1860TT361G 2054
DBO1848TT361G 1734

"M" Option N/A
"M" Option N/A

Product Features

- 1-5/16" Thick top
- Glides
- Solid hardwood base and legs

Notes

- Tables are available in Cherry, Maple and Walnut Finishes

2 Select Finish

[Click to view finishes](#)

WAC
WIC
WHC
WOC
WEC
WCM
WEW
WGW
WBW
WSW
WNW

WWW

GAC
GIC
GHC
GOC
GCM
GEW
GNW

3 Select Edge

[Click to view edges](#)

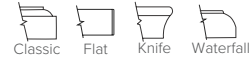
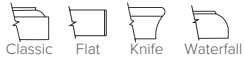

4 Select Hardware

[Click to view details](#)

Hardware
N/A

Hardware
N/A

Occasional

Zum Table End Table/Cocktail Table

[Click here to view statement of line](#)

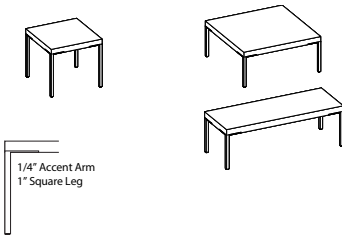

1 Select Model

w" x d" x h"	Weight
End Table	
24 x 24 x 22	35
18 x 18 x 22	30
Cocktail Table	
42 x 42 x 16	60
36 x 36 x 16	55
30 x 30 x 16	45
18 x 48 x 16	45

	Standard Veneer Top Brushed Nickel Base	Premium Veneer Top Brushed Nickel Base	High Pressure Laminate Top Brushed Nickel Base	Thermally Fused Laminate Top Brushed Nickel Base
WAC	OPO2424ZU366W 1271	OPO2424ZU366P 1398	OPO2424ZU366G 1271	"M" Option N/A
WIC	OPO1818ZU366W 1211	OPO1818ZU366P 1332	OPO1818ZU366G 1211	"M" Option N/A
WHC	OPO4242ZU369W 1806	OPO4242ZU369P 1986	OPO4242ZU369G 1806	"M" Option N/A
WOC	OPO3636ZU369W 1772	OPO3636ZU369P 1948	OPO3636ZU369G 1772	"M" Option N/A
WEC	OPO3030ZU369W 1706	OPO3030ZU369P 1877	OPO3030ZU369G 1706	"M" Option N/A
WAM	OPO1848ZU369W 1738	OPO1848ZU369P 1912	OPO1848ZU369G 1738	"M" Option N/A
WCM				
WWP				
WBW				
WSW				
WNW				
WMO				
WNO				
WLO				
WSO				
TBCO				
TBSW				
TSTV				
TSMV				
TSLV				
TOBW				
GAC				
GSLV				
GIC				
GWL				
GHC				
GOC				
GEC				
GAM				
GCM				
GEW				
GNW				
GSTV				
Edge	Edge	Edge	Edge	Edge
N/A	N/A	N/A	N/A	N/A
Hardware	Hardware	Hardware	Hardware	Hardware
N/A	N/A	N/A	N/A	N/A

Product Features

- 2" Thick top with 3mm hardwood edge band
- Glides
- Brushed nickel legs have accent arms recessed in top edge

2 Select Finish

[Click to view finishes](#)

WAC	WEW	Cut)
WIC	WGW	WMF(Mocha
WHC	WWW	Oak on Flat
WOC	WLF(Lofty	Cut)
WEC	Oak on Flat	
WAM	Cut)	
WCM	WNF(Natural	
WWP	Oak on Flat	
WBW	Cut)	
WSW	WSF(Salted	
WNW	Oak on Flat	

3 Select Edge

[Click to view edges](#)

Edge
N/A

4 Select Hardware

[Click to view details](#)

Hardware
N/A



Posh Price List

Effective November 1, 2022

Designed By John Stafford & Chris Carter

Date	Page	Modification	Description
11.10.22		Price Increase	9% price increase applied to all items
5.8.23			Removed WLA and replaced with WLO Lofty Oak
6.21.23			Added WWW finish

Fabric seat & leather program.....1
Seating Specification4
Finishes5
Executive Chair6



Page 6
Upholstered Arms
Mid-Back



Page 7
Upholstered Arms
High-Back

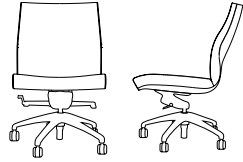

Page 8
Armless
Mid-Back

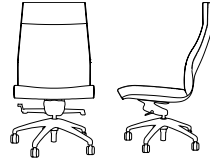

Page 9
Armless
High-Back

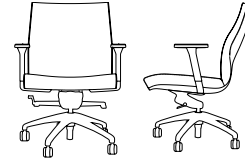

Page 10
Adjustable Ergonomic Arms
Mid-Back

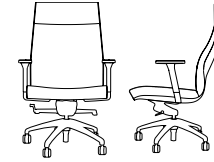

Page 11
Adjustable Ergonomic Arms
High-Back

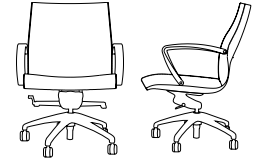

Page 12
Urethane Loop Arms
Mid-Back

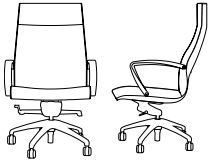

Page 13
Urethane Loop Arms
High-Back

Seating & fabric leather program

DARRAN has partnered with some of the most prestigious fabric suppliers of the office furniture industry to bring you quality fabrics that are engaging designs, environmentally friendly and durable for years to come. The majority of fabrics we have graded-in are in heavy supply making it most likely available on our Quickship however, we cannot guarantee stock. If you do not see the fabric you wish to include in a project, please contact our Factory to see if this pattern can be graded in at 800.334.7891.

Fabrics & Leathers

Please visit our Seating Fabrics page at darran.com/textilesleather

Camira
www.camirafabrics.com
800.334.789

Wollsdorf
www.wollsdorf.com
336.884.5005

CFStinson
www.cfstinson.com
800.841.6279

Green Hides
www.greenhides.com
336.315.9720

DesignTex
www.designtex.com
800.797.4949

Maharam
www.maharam.com
800.645.3943

Momentum Textiles
www.momentumtextiles.com
800.366.6839

Ultrafabrics
www.ultrafabricsinc.com
800.334.7891

Application instructions must be specified on the purchase order or COM / COL submission form. In the absence of application instructions, DARRAN will apply materials accordingly.

CAL117

All DARRAN seating products conform to California Technical Bulletin 117 as a minimum standard.

CAL133

To meet the California Technical Bulletin 133 flammability regulation, a combination of proper materials must be used to pass, as it tests the fire resistance of a finished product. Flame resistant fabric, a fire blocker material and special foam must be used to pass CAL133 fire codes.

Testing is available for all seating products with the following fees and considerations:

- If laboratory certification is not required, any style can be manufactured to comply with California Technical Bulletin 133 for \$75 list per yard required. (Customer's Own Materials must factor in additional yardage requirements based on repeat.)
- The purchase order must clearly indicate the requirement of California Technical Bulletin 133
- If laboratory California Technical Bulletin 133 certification is required, the cost of testing a chair is \$820 NET, plus the cost of the chair and covering material.
- An additional lead time of 4 to 6 weeks is required for testing for CAL133.
- Once testing is completed, we will provide a certification letter specific to the sample tested for CAL133.
- DARRAN's manufacturing procedures for California TB 133 compliance are based on the testing of representative style with specific fabrics. Please contact Customer Service for an updated list of tested models.
- A copy of test certification is available upon request.

Combination fabrics

DARRAN is pleased to offer customers the design freedom of combination fabrics. When using fabric, vinyl or leather combinations, pricing will be as follows:

- When combining two materials of the same grade, pricing will be specified grade + 5%.
- If combining two materials of different grades or leather/ fabric combination, use the highest grade/price + 5%.
- If using COM or COL, pricing will be COM or COL + 5%. If both COM + COL are used in combination, use COL + 5%

COM/COL ordering instructions

Please complete the COM Submission Form prior to ordering the fabric from the supplier. All COM fabrics must be approved prior to order submission. Please refer to our website or contact DARRAN Seating Customer Service for an updated list of preapproved COM fabrics. Application instructions must be specified on the purchase order or COM/COL submission form. In the absence of application instructions, DARRAN will apply materials in the best manner and cannot be held responsible for tailoring or application objections after upholstery. COM orders will be scheduled for production after receipt of the material. Packages must be clearly marked and the fabric must be first quality, continuous yardage.

COM/COL yardage requirements

The yardage requirements stated in this price list for each style are calculated using 54" wide, non-directional fabrics. For fabrics with a different width or for patterns with repeats, please refer to the below chart to calculate the additional percent of fabric required:

Fabric Width	Plain Fabric	2" - 14" Repeat	15" - 19" Repeat	20" - 27" Repeat	28" - 36" Repeat
54"	0	15%	20%	25%	30%
53"	6%	19%	24%	28%	36%
52"	13%	23%	28%	33%	38%
51"	19%	26%	31%	36%	41%
50"	25%	30%	35%	40%	45%
49"	30%	35%	40%	45%	50%
48"	35%	40%	45%	50%	55%
47"	45%	50%	55%	58%	65%

DARRAN®

NOTE: Prior To Completion Of This Form, Please Refer To Our Graded In Materials Program For Preapproved Fabrics/Leathers.

COM/COL Approval

DARRAN Furniture Industries
2402 Shore Street, High Point, NC 27263
ATTN: Seating Division / COM/COL Approval
TAG: DARRAN Purchase Order Number

Shipping approved COM/COL materials

DARRAN Furniture Industries
2402 Shore Street, High Point, NC 27263
ATTN: Seating Division / COM/COL Approval
TAG: DARRAN Purchase Order Number

Please complete this form, attach a 6"x 6" sample and mail to the COM/COL APPROVAL address shown above.
This form can also be downloaded from our website at www.darran.com/leathers OR www.darran.com/fabrics

Purchase Order # _____

Dealer's Name _____

Contact _____

Address _____

Telephone _____

Email _____

Chair Stlye _____

Manufacturer _____

Pattern Name _____

Pattern Color _____

Content _____

Repeat _____

Please specify any special requirements and check the application above.

Posh Fabric & Leather Program

ATTACH 6" X 6" FABRIC/LEATHER SAMPLE HERE

NOTE

Actual Fabric/Leather samples needed instead of digital images. If digital images are sent in lieu of samples, DARRAN will only verify the pattern and will not take responsibility for color variances that cannot be verified due to printing restrictions

In the absence of application instructions, DARRAN will apply the material in the best manner and cannot be held responsible for tailoring or application objections after upholstering.

Unless otherwise instructed on the purchase order, excess COM materials will be recycled at the discretion of DARRAN after six months of the original product ship date.

The COM approval solely pertains to the application of the fabric onto the specified DARRAN seating product. DARRAN's approval or acceptance does not constitute any responsibility or warranty to the overall appearance, durability, flammability, defects, dye lot variations or colorfastness of the COM. It is the customer's responsibility to ensure the COM meets CAL 117 compliance and are first quality continuous goods.

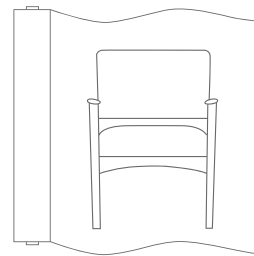

RAILROAD

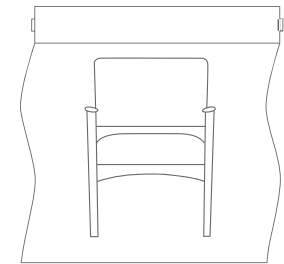

SETUP

Overall Width = 25"
 Overall Depth = 24-1/2"
 Height = 38-1/2" - 41-1/4"
 Seat Width = 22-1/2"
 Seat Depth = 18-1/2"
 Seat Height = 18-1/4" - 21-1/2"
 Arm Height = 27-1/2" - 30-3/4"

Frame Construction: 9-ply hardwood molded plywood frame construction for superior strength and durability. Frames are precision cut on CNC routers to insure uniformity.

Cushioning: High density CAL117 polyurethane foams of varying compression are laminated together to provide long term comfort.

Upholstered Arms: 2" wide upholstered panel arms, urethane coated loop arms, adjustable T arms and armless versions provide options for multiple use applications.

Adjustable Urethane Arms: Black adjustable ergonomic arms are available with spring loaded height adjustment and button activation. Arms are angled at 15 degrees with an adjustable arm pad for additional comfort and ergonomic support. Arms adjust 3-1/4" in height and 1-1/2" in width.

Bases: 26" diameter, available in Polished Aluminum (Standard), Black or Wood.

Casters: 60mm diameter casters are standard and promote increased mobility.

Carpet casters are standard. For hard floor surfaces specify CST20 - no upcharge.

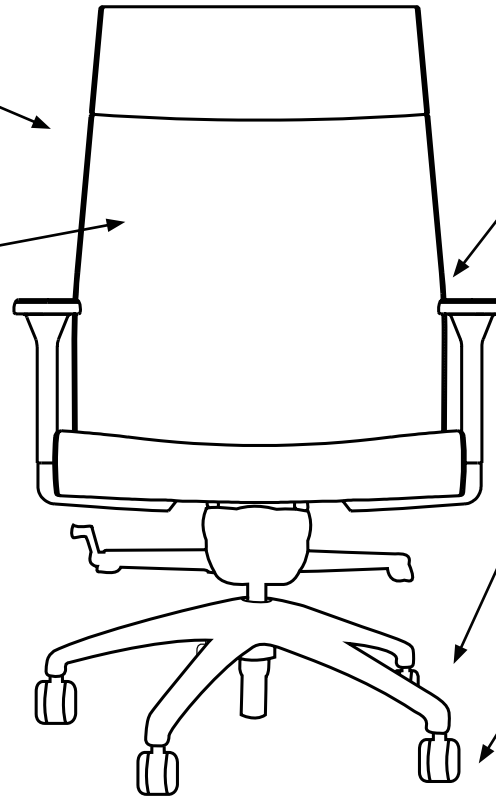

Upholstered Arms
(Mid-Back or High-Back)

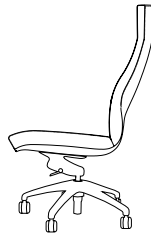

Armless
(Mid-Back or High-Back)



Adjustable Arms
(Mid-Back or High-Back)



Urethane Loop Arms
(Mid-Back or High-Back)

Posh's thin profile of subtle curves and signature channel back design provides an elegant executive seating solution for any office environment. Versatility in options, and highback / midback chair designs allow customers to specify Posh for mid-management, upper executives, and conferencing applications. Posh is offered in armless, upholstered, adjustable, and black urethane arms.

Knee tilt swivel mechanisms

The Knee-tilt mechanism features an advanced forward pivot point that reduces leg tilt with a 16 degree seat angle and a 25 degree back angle tilt. The mechanism locks in task and reclines positions with side tension adjustment. height adjustment and tilt tensions are also provided.

DARRAN®

Posh Finishes

(For base options only)

WLO Lofty Oak
WAC Amber Cherry
WIC Crimson Cherry
WHC Honey Cherry
WOC KoKo Cherry
WAM Alabaster Maple
WCM Clear Maple
WMO Mocha Oak
WNO Natural Oak
WSO Salted Oak
WEW Executive Walnut
WGW Gunstock Walnut
WBW Henna Walnut
WSW Smokey Walnut
WNW Natural Walnut
WWW Weathered Walnut
TBCO Baby's Cheek
TBSW Brown Sugar
TSTV Studio Teak Walnut
SSM Seattle Mist Paint
SSL Skyline Walnut Paint
TOBW Organic Brown
WWP Designer White Paint

Send 3x3 or larger finish chip for color match. Custom finish upcharge is 3% or \$250 Net (whichever is greater).



Finish

Welltech Finish delivers a superior furniture coating with exceptional performance that can withstand stringent cleaning agents and possesses unparalleled durability, allowing DARRAN to provide lasting, sustainable products to our customers.

Posh

Upholstered Arms
Mid-Back

[Click here to view statement of line](#)

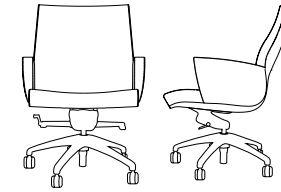

1 Model

PSH9825UAM04

w" x d" x h"
25 x 24.5 x 37.75-40.5
Arm Height 27 -1/2" - 30 -3/4"
Seat Height 18 -1/4" - 21 -1/2"
Inside Seat Depth 18 -1/2"
Inside Seat Width 22 -1/2"

COM	COL	1	2	3	4	5	6	7	8	9	10	11/L1	12	13/L2
2262	2332	2383	2442	2501	2560	2619	2678	2737	2796	2855	2914	2973	3032	3150

Upholstery Requirements
Fabric yds: 3.25 Leather Sq. Ft.: 58.5
Carton Weight: 55

Product Features

- 2" wide upholstered arms
- 26" diameter polished aluminum base
- 9-ply molded plywood frame
- High density CAL117 polyurethane foams of varying compression are laminated together to provide long term comfort.
- Large 60mm diameter casters are standard and promote increased mobility.
- Knee tilt swivel w/ forward pivot point

2 Select Finish

[Click to view finishes](#)

Finishes N/A

3 Combination Fabrics

[Click to view finishes](#)

DARRAN is pleased to offer customers the design freedom of combination fabrics. When using fabric, vinyl or leather combinations, pricing/yardage requirements will be as follows:

- A Seat 1 yd(s).
- B Inside Back .75 yd(s).
- C Arms 1 yd(s).
- D Outside Back .75 yd(s).

- When combining two materials of the same grade, pricing will be specified grade + 5%
- If combining two materials of different grades or leather/fabric combination, use the highest grade/price + 5%
- If using COM or COL, pricing will be COM or COL + 5%.
- If both COM + COL are used in combination, use COL + 5%.

WWP

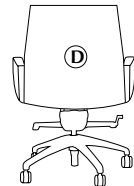
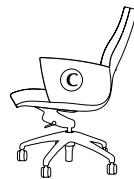
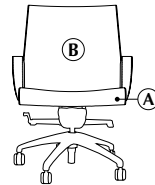

Posh

Upholstered Arms
High-Back

[Click here to view statement of line](#)

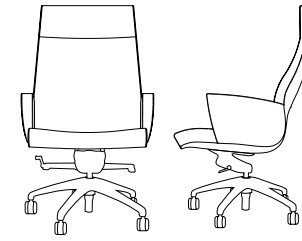

1 Model PSH9825UAH05

w" x d" x h"
25 x 24.5 x 43.25-46.25
Arm Height 27 -1/2" - 30 -3/4"
Seat Height 18 -1/4" - 21 -1/2"
Inside Seat Depth 18 -1/2"
Inside Seat Width 22 -1/2"

COM	COL	1	2	3	4	5	6	7	8	9	10	11/L1	12	13/L2
2394	2467	2524	2588	2652	2716	2780	2844	2908	2972	3036	3100	3164	3228	3356

Upholstery Requirements
Fabric yds: 3.5 Leather Sq. Ft.: 63
Carton Weight: 60

2 Select Finish

[Click to view finishes](#)

Finishes N/A

3 Combination Fabrics

[Click to view finishes](#)

WWP

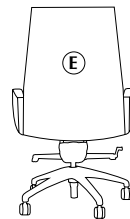
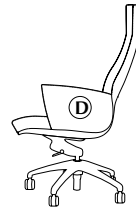
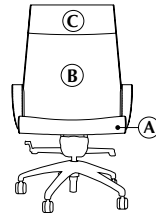

DARRAN is pleased to offer customers the design freedom of combination fabrics. When using fabric, vinyl or leather combinations, pricing/yardage requirements will be as follows:

- A Seat 1 yd(s).
- B Lower Inside Back .75 yd(s).
- C Upper Inside Back .5 yd(s).
- D Arms 1 yd(s).
- E Outside Back .75 yd(s).

- When combining two materials of the same grade, pricing will be specified grade + 5%
- If combining two materials of different grades or leather/fabric combination, use the highest grade/price + 5%
- If using COM or COL, pricing will be COM or COL + 5%.
- If both COM + COL are used in combination, use COL + 5%.

Product Features

- 2" wide upholstered arms
- 26" diameter polished aluminum base
- 9-ply molded plywood frame
- High density CAL117 polyurethane foams of varying compression are laminated together to provide long term comfort.
- Large 60mm diameter casters are standard and promote increased mobility.
- Knee tilt swivel w/ forward pivot point

Options

Base

- BBPC: Black Base - \$95
- BOW: Wood Base, see page 5 to specify finish - \$170

Stitching

- BPS: Back Panel Stitching Detail - \$105

Posh

Armless
Mid-Back

[Click here to view statement of line](#)

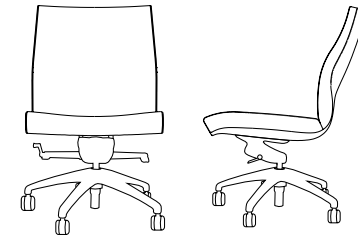

1 Model PSH9825NAM00

w" x d" x h"
21 x 24.5 x 37.75-40.5
Arm Height N/A
Seat Height 18 -1/4" - 21 -1/2"
Inside Seat Depth 18 -1/2"
Inside Seat Width 22 -1/2"

COM	COL	1	2	3	4	5	6	7	8	9	10	11/L1	12	13/L2
1820	1869	1931	1986	2041	2096	2151	2206	2261	2316	2371	2426	2481	2536	2646

Upholstery Requirements
Fabric yds: 3 Leather Sq. Ft.: 54
Carton Weight: 50

2 Select Finish

[Click to view finishes](#)

Finishes N/A

3 Combination Fabrics

[Click to view finishes](#)

DARRAN is pleased to offer customers the design freedom of combination fabrics. When using fabric, vinyl or leather combinations, pricing/yardage requirements will be as follows:

A Seat 1 yd(s).
B Inside Back .75 yd(s).
C Outside Back .75 yd(s).

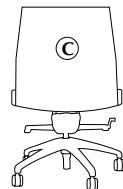
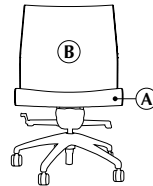

- When combining two materials of the same grade, pricing will be specified grade + 5%
- If combining two materials of different grades or leather/fabric combination, use the highest grade/price + 5%
- If using COM or COL, pricing will be COM or COL + 5%.
- If both COM + COL are used in combination, use COL + 5%.

Product Features

- 26" diameter polished aluminum base
- 9-ply molded plywood frame
- High density CAL117 polyurethane foams of varying compression are laminated together to provide long term comfort.
- Large 60mm diameter casters are standard and promote increased mobility.
- Knee tilt swivel w/ forward pivot point

Options

Base

- BBPC: Black Base - \$95
- BOW: Wood Base, see page 5 to specify finish - \$170

Stitching

- BPS: Back Panel Stitching Detail - \$105

Posh

Armless
High-Back

[Click here to view statement of line](#)

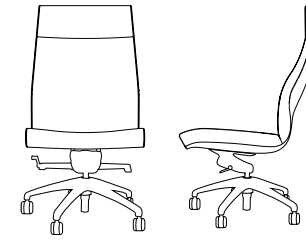

1 Model PSH9825NAH01

w" x d" x h"
21 x 24.5 x 43.25-46.25
Arm Height N/A
Seat Height 18 -1/4" - 21 -1/2"
Inside Seat Depth 18 -1/2"
Inside Seat Width 22 -1/2"

COM	COL	1	2	3	4	5	6	7	8	9	10	11/L1	12	13/L2
1945	1997	2066	2125	2184	2243	2302	2361	2420	2479	2538	2597	2656	2715	2833

Upholstery Requirements
Fabric yds: 3.25 Leather Sq. Ft.: 58.5
Carton Weight: 55

2 Select Finish

[Click to view finishes](#)

Finishes N/A

3 Combination Fabrics

[Click to view finishes](#)

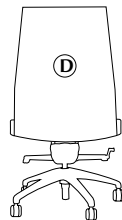
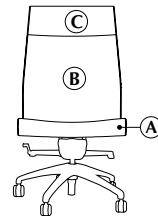

DARRAN is pleased to offer customers the design freedom of combination fabrics. When using fabric, vinyl or leather combinations, pricing/yardage requirements will be as follows:

- A Seat 1 yd(s).
- B Lower Inside Back .75 yd(s).
- C Upper Inside Back .5 yd(s).
- D Outside Back .75 yd(s).

- When combining two materials of the same grade, pricing will be specified grade + 5%
- If combining two materials of different grades or leather/fabric combination, use the highest grade/price + 5%
- If using COM or COL, pricing will be COM or COL + 5%.
- If both COM + COL are used in combination, use COL + 5%.

Product Features

- 26" diameter polished aluminum base
- 9-ply molded plywood frame
- High density CAL117 polyurethane foams of varying compression are laminated together to provide long term comfort.
- Large 60mm diameter casters are standard and promote increased mobility.
- Knee tilt swivel w/ forward pivot point

Options

Base

- BBPC: Black Base - \$95
- BOW: Wood Base, see page 5 to specify finish - \$170

Stitching

- BPS: Back Panel Stitching Detail - \$105

Posh

Adjustable Ergonomic Arms
Mid-Back

[Click here to view statement of line](#)

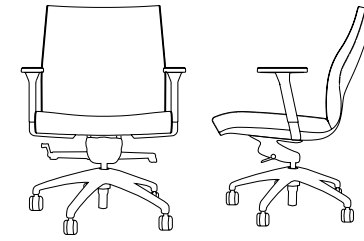

1 Model PSH9825AAM02

w" x d" x h"
21 x 24.5 x 37.75-40.5
Arm Height 28 -1/2" - 31 -3/4"
Seat Height 18 -1/4" - 21 -1/2"
Inside Seat Depth 18 -1/2"
Inside Seat Width 22 -1/2"

COM	COL	1	2	3	4	5	6	7	8	9	10	11/L1	12	13/L2
1972	2021	2083	2138	2193	2248	2303	2358	2413	2468	2523	2578	2633	2688	2798

Upholstery Requirements
Fabric yds: 3 Leather Sq. Ft.: 54
Carton Weight: 55

2 Select Finish

[Click to view finishes](#)

Finishes N/A

3 Combination Fabrics

[Click to view finishes](#)

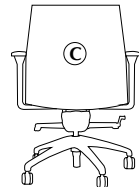
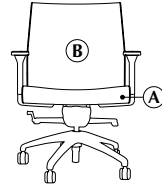

DARRAN is pleased to offer customers the design freedom of combination fabrics. When using fabric, vinyl or leather combinations, pricing/yardage requirements will be as follows:

A Seat 1 yd(s).
B Inside Back .75 yd(s).
C Outside Back .75 yd(s).

- When combining two materials of the same grade, pricing will be specified grade + 5%
- If combining two materials of different grades or leather/fabric combination, use the highest grade/price + 5%
- If using COM or COL, pricing will be COM or COL + 5%.
- If both COM + COL are used in combination, use COL + 5%.

Product Features

- 26" diameter polished aluminum base
- 9-ply molded plywood frame
- Black adjustable ergonomic arms are available with spring loaded height adjustment and button activation. Arms are angled at 15 degrees with an adjustable arm pad for additional comfort and support. Arm adjusts 3- 1/4" in height and 1-1/2" in width
- High density CAL117 polyurethane foams of varying compression are laminated together to provide long term comfort.
- Large 60mm diameter casters are standard and promote increased mobility.
- Knee tilt swivel w/ forward pivot point

Options

Base

- BBPC: Black Base - \$95
- BOW: Wood Base, see page 5 to specify finish - \$170

Stitching

- BPS: Back Panel Stitching Detail - \$105

Posh

Adjustable Ergonomic Arms
High-Back

[Click here to view statement of line](#)

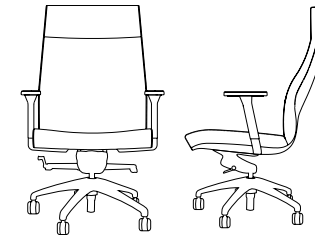

1 Model PSH9825AAH03

w" x d" x h"
21 x 24.5 x 43.25-46.25
Arm Height 28 -1/2" - 31 -3/4"
Seat Height 18 -1/4" - 21 1/2"
Inside Seat Depth 18 -1/2"
Inside Seat Width 22 -1/2"

COM	COL	1	2	3	4	5	6	7	8	9	10	11/L1	12	13/L2
2095	2147	2216	2275	2334	2393	2452	2511	2570	2629	2688	2747	2806	2865	2983

Upholstery Requirements
Fabric yds: 3.25 Leather Sq. Ft.: 58.5
Carton Weight: 60

2 Select Finish

[Click to view finishes](#)

Finishes N/A

3 Combination Fabrics

[Click to view finishes](#)

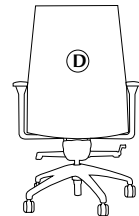
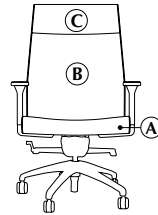

DARRAN is pleased to offer customers the design freedom of combination fabrics. When using fabric, vinyl or leather combinations, pricing/yardage requirements will be as follows:

- A Seat 1 yd(s).
- B Lower Inside Back .75 yd(s).
- C Upper Inside Back .5 yd(s).
- D Outside Back .75 yd(s).

- When combining two materials of the same grade, pricing will be specified grade + 5%
- If combining two materials of different grades or leather/fabric combination, use the highest grade/price + 5%
- If using COM or COL, pricing will be COM or COL + 5%.
- If both COM + COL are used in combination, use COL + 5%.

Product Features

- 26" diameter polished aluminum base
- 9-ply molded plywood frame
- Black adjustable ergonomic arms are available with spring loaded height adjustment and button activation. Arms are angled at 15 degrees with an adjustable arm pad for additional comfort and support. Arm adjusts 3- 1/4" in height and 1-1/2" in width
- High density CAL117 polyurethane foams of varying compression are laminated together to provide long term comfort.
- Large 60mm diameter casters are standard and promote increased mobility.
- Knee tilt swivel w/ forward pivot point

Options

Base

- BBPC: Black Base - \$95
- BOW: Wood Base, see page 5 to specify finish - \$170

Stitching

- BPS: Back Panel Stitching Detail - \$105

Posh

Urethane Loop Arms
Mid-Back

[Click here to view statement of line](#)

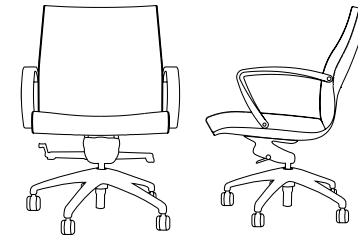

1 Model PSH9825CAM16

w" x d" x h"
25 x 24.5 x 37.75-40.5
Arm Height 27 -3/4" - 31"
Seat Height 18 -1/4" - 21 -1/2"
Inside Seat Depth 18 -1/2"
Inside Seat Width 22 -1/2"

COM	COL	1	2	3	4	5	6	7	8	9	10	11/L1	12	13/L2
1903	1952	2014	2069	2124	2179	2234	2289	2344	2399	2454	2509	2564	2619	2729

Upholstery Requirements
Fabric yds: 3 Leather Sq. Ft.: 54
Carton Weight: 55

2 Select Finish

[Click to view finishes](#)

Finishes N/A

3 Combination Fabrics

[Click to view finishes](#)

DARRAN is pleased to offer customers the design freedom of combination fabrics. When using fabric, vinyl or leather combinations, pricing/yardage requirements will be as follows:

A Seat 1 yd(s).
B Inside Back .75 yd(s).
C Outside Back .75 yd(s).

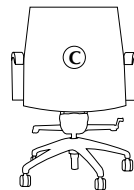
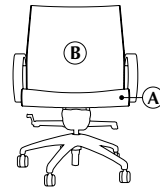

- When combining two materials of the same grade, pricing will be specified grade + 5%
- If combining two materials of different grades or leather/fabric combination, use the highest grade/price + 5%
- If using COM or COL, pricing will be COM or COL + 5%.
- If both COM + COL are used in combination, use COL + 5%.

Product Features

- 26" diameter polished aluminum base
- 9-ply molded plywood frame
- Black urethane loop arms
- High density CAL117 polyurethane foams of varying compression are laminated together to provide long term comfort.
- Large 60mm diameter casters are standard and promote increased mobility.
- Knee tilt swivel w/ forward pivot point

Options

Base

- BBPC: Black Base - \$95
- BOW: Wood Base, see page 5 to specify finish - \$170

Stitching

- BPS: Back Panel Stitching Detail - \$105

Posh

Urethane Loop Arms
High-Back

[Click here to view statement of line](#)

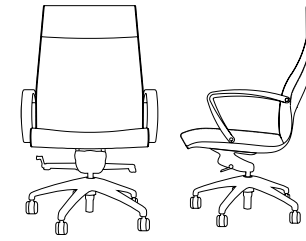

1 Model
PSH9825CAH17

w" x d" x h"
25 x 24.5 x 43.25-46.25
Arm Height 27 -3/4" - 31"
Seat Height 18 -1/4" - 21 -1/2"
Inside Seat Depth 18 -1/2"
Inside Seat Width 22 -1/2"

COM	COL	1	2	3	4	5	6	7	8	9	10	11/L1	12	13/L2
2025	2077	2146	2205	2264	2323	2382	2441	2500	2559	2618	2677	2736	2795	2913

Upholstery Requirements
Fabric yds: 3.25 Leather Sq. Ft.: 58.5
Carton Weight: 60

Product Features

- 26" diameter polished aluminum base
- 9-ply molded plywood frame
- Black urethane loop arms
- High density CAL117 polyurethane foams of varying compression are laminated together to provide long term comfort.
- Large 60mm diameter casters are standard and promote increased mobility.
- Knee tilt swivel w/ forward pivot point

2 Select Finish

[Click to view finishes](#)

Finishes N/A

3 Combination Fabrics

[Click to view finishes](#)

DARRAN is pleased to offer customers the design freedom of combination fabrics. When using fabric, vinyl or leather combinations, pricing/yardage requirements will be as follows:

- A Seat 1 yd(s).
- B Lower Inside Back .75 yd(s).
- C Upper Inside Back .5 yd(s).
- D Outside Back .75 yd(s).

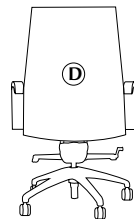
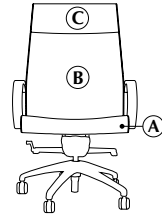

- When combining two materials of the same grade, pricing will be specified grade + 5%
- If combining two materials of different grades or leather/fabric combination, use the highest grade/price + 5%
- If using COM or COL, pricing will be COM or COL + 5%.
- If both COM + COL are used in combination, use COL + 5%.

Options

Base

- BBPC: Black Base - \$95
- BOW: Wood Base, see page 5 to specify finish - \$170

Stitching

- BPS: Back Panel Stitching Detail - \$105



Spire Price List

Effective November 1, 2022

Designed By Michael Wolk

Date	Page	Modification	Description
8.18		Removed TFL from Pricelist	
11.11.22		Price Increase	9% price increase applied
11.15.22		Added GNA Narvik Ash	
11.22.22		Added MFGM Gold and MFDB Dark Bronze	

Statement of Line
Guest seating fabric & leather program.....1
Finishes4
Occasional Tables.....7
Conference Tables9
Barstool13
Guest/Lounge Chairs14
Power & Data.....24

Statement of Line



Page 7
Occasional Table
Y Blade Base Occasional Table



Page 8
Occasional Table
Blade Base Occasional Table



Page 9
Conference Table
Y Blade Base Work Table



Page 10
Conference Table
Blade Base Work Table



Page 11
Conference Table
Y Blade Base Bar Table



Page 12
Conference Table
Blade Base Bar Table

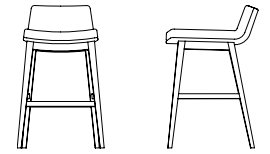

Page 13
Barstool
Wood Base Barstool

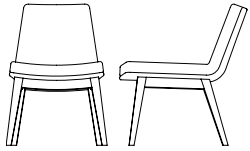

Page 14
Guest Chair
Wood Base Guest Chair

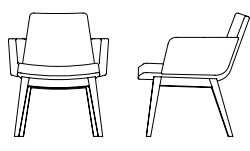

Page 15
Guest Chair
Wood Base Guest Chair W/ Arms

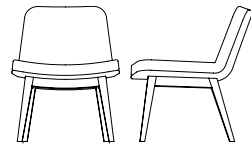

Page 16
Lounge Chair
Wood Base Lounge Chair

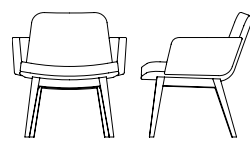

Page 17
Lounge Chair
Wood Base Lounge Chair W/ Arms

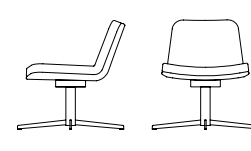

Page 18
Guest Chair
Swivel Blade Base Guest Chair

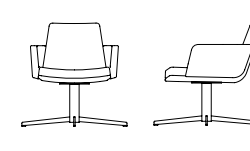

Page 19
Guest Chair
Swivel Blade Base Guest Chair W/ Arms

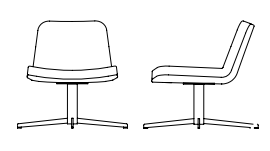

Page 20
Lounge Chair
Swivel Blade Base Lounge Chair

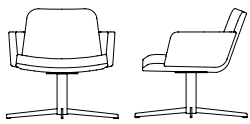

Page 21
Lounge Chair
Swivel Blade Base Lounge Chair W/ Arms

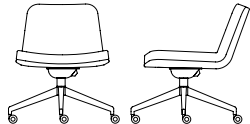

Page 22
Conference Lounge Chair
Conference Chair

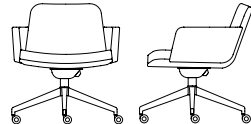

Page 23
Conference Lounge Chair
Conference Chair W/ Arms

Seating & fabric leather program

DARRAN has partnered with some of the most prestigious fabric suppliers of the office furniture industry to bring you quality fabrics that are engaging designs, environmentally friendly and durable for years to come. The majority of fabrics we have graded-in are in heavy supply making it most likely available on our Quickship however, we cannot guarantee stock. If you do not see the fabric you wish to include in a project, please contact our Factory to see if this pattern can be graded in at 800.334.7891.

Fabrics & Leathers

Please visit our Seating Fabrics page at darran.com/textilesleather

Camira
www.camirafabrics.com
800.334.789

Wollsdorf
www.wollsdorf.com
336.884.5005

CFStinson
www.cfstinson.com
800.841.6279

Green Hides
www.greenhides.com
336.315.9720

DesignTex
www.designtex.com
800.797.4949

Maharam
www.maharam.com
800.645.3943

Momentum Textiles
www.momentumtextiles.com
800.366.6839

Ultrafabrics
www.ultrafabricsinc.com
800.334.7891

Application instructions must be specified on the purchase order or COM / COL submission form. In the absence of application instructions, DARRAN will apply materials accordingly.

CAL117

All DARRAN seating products conform to California Technical Bulletin 117 as a minimum standard.

CAL133

To meet the California Technical Bulletin 133 flammability regulation, a combination of proper materials must be used to pass, as it tests the fire resistance of a finished product. Flame resistant fabric, a fire blocker material and special foam must be used to pass CAL133 fire codes.

Testing is available for all seating products with the following fees and considerations:

- If laboratory certification is not required, any style can be manufactured to comply with California Technical Bulletin 133 for \$75 list per yard required. (Customer's Own Materials must factor in additional yardage requirements based on repeat.)
- The purchase order must clearly indicate the requirement of California Technical Bulletin 133
- If laboratory California Technical Bulletin 133 certification is required, the cost of testing a chair is \$820 NET, plus the cost of the chair and covering material.
- An additional lead time of 4 to 6 weeks is required for testing for CAL133.
- Once testing is completed, we will provide a certification letter specific to the sample tested for CAL133.
- DARRAN's manufacturing procedures for California TB 133 compliance are based on the testing of representative style with specific fabrics. Please contact Customer Service for an updated list of tested models.
- A copy of test certification is available upon request.W

Combination fabrics

DARRAN is pleased to offer customers the design freedom of combination fabrics. When using fabric, vinyl or leather combinations, pricing will be as follows:

- When combining two materials of the same grade, pricing will be specified grade + 5%.
- If combining two materials of different grades or leather/ fabric combination, use the highest grade/price + 5%.
- If using COM or COL, pricing will be COM or COL + 5%. If both COM + COL are used in combination, use COL + 5%

COM/COL ordering instructions

Please complete the COM Submission Form prior to ordering the fabric from the supplier. All COM fabrics must be approved prior to order submission. Please refer to our website or contact DARRAN Seating Customer Service for an updated list of preapproved COM fabrics. Application instructions must be specified on the purchase order or COM/COL submission form. In the absence of application instructions, DARRAN will apply materials in the best manner and cannot be held responsible for tailoring or application objections after upholstery. COM orders will be scheduled for production after receipt of the material. Packages must be clearly marked and the fabric must be first quality, continuous yardage.

COM/COL yardage requirements

The yardage requirements stated in this price list for each style are calculated using 54" wide, non-directional fabrics. For fabrics with a different width or for patterns with repeats, please refer to the below chart to calculate the additional percent of fabric required:

Fabric Width	Plain Fabric	2"- 14" Repeat	15"- 19" Repeat	20"- 27" Repeat	28"- 36" Repeat
54"	0	15%	20%	25%	30%
53"	6%	19%	24%	28%	36%
52"	13%	23%	28%	33%	38%
51"	19%	26%	31%	36%	41%
50"	25%	30%	35%	40%	45%
49"	30%	35%	40%	45%	50%
48"	35%	40%	45%	50%	55%
47"	45%	50%	55%	58%	65%

DARRAN®

NOTE: Prior To Completion Of This Form, Please Refer To Our Graded In Materials Program For Preapproved Fabrics/Leathers.

COM/COL Approval

DARRAN Furniture Industries
2402 Shore Street, High Point, NC 27263
ATTN: Seating Division / COM/COL Approval
TAG: DARRAN Purchase Order Number

Shipping approved COM/COL materials

DARRAN Furniture Industries
2402 Shore Street, High Point, NC 27263
ATTN: Seating Division / COM/COL Approval
TAG: DARRAN Purchase Order Number

Please complete this form, attach a 6"x 6" sample and mail to the COM/COL APPROVAL address shown above.
This form can also be downloaded from our website at www.darran.com/leathers OR www.darran.com/fabrics

Purchase Order # _____

Dealer's Name _____

Contact _____

Address _____

Telephone _____

Email _____

Chair Stlye _____

Manufacturer _____

Pattern Name _____

Pattern Color _____

Content _____

Repeat _____

Please specify any special requirements and check the application above.

Spire Seating Fabric & Leather Program

ATTACH 6" X 6" FABRIC/LEATHER SAMPLE HERE

NOTE

Actual Fabric/Leather samples needed instead of digital images. If digital images are sent in lieu of samples, DARRAN will only verify the pattern and will not take responsibility for color variances that cannot be verified due to printing restrictions

In the absence of application instructions, DARRAN will apply the material in the best manner and cannot be held responsible for tailoring or application objections after upholstering.

Unless otherwise instructed on the purchase order, excess COM materials will be recycled at the discretion of DARRAN after six months of the original product ship date.

The COM approval solely pertains to the application of the fabric onto the specified DARRAN seating product. DARRAN's approval or acceptance does not constitute any responsibility or warranty to the overall appearance, durability, flammability, defects, dye lot variations or colorfastness of the COM. It is the customer's responsibility to ensure the COM meets CAL 117 compliance and are first quality continuous goods.

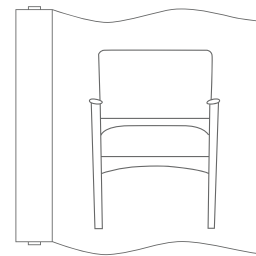

RAILROAD

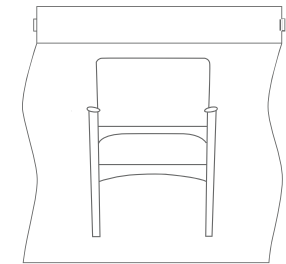

SETUP

Solid Ash Frame Finishes

WLA Lofty Ash

WAM Alabaster Maple

WMO Mocha Oak

WNO Natural Oak

WSO Salted Oak

TBCO Baby's Cheek

TBSW Brown Sugar

TOBW Organic Brown

TSTV Studio Teak

SSM Seattle Mist Paint

SSL Skyline Walnut Paint

WWP Designer White Paint

Solid Walnut Frame Finishes

WOW Clear Walnut

WEW Executive Walnut

WGW Gunstock Walnut

WBW Henna Walnut

WSW Smokey Walnut

WNW Natural Walnut

Send 3x3 or larger finish chip for color match. Custom finish upcharge is 3% or \$250 Net (whichever is greater).



Finish

Welltech Finish delivers a superior furniture coating with exceptional performance that can withstand stringent cleaning agents and possesses unparalleled durability, allowing DARRAN to provide lasting, sustainable products to our customers.

Seat cushions are made of high resiliency foam with proper density to give comfort and support.

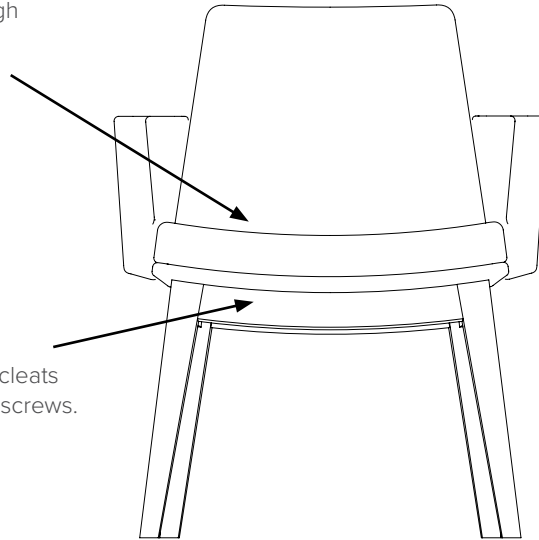

Seat rails are reinforced with hardwood corner blocks and cleats attached with glue and wood screws.

Frame is constructed of kiln-dried solid Ash or Walnut, perpetuating premium quality and durability.

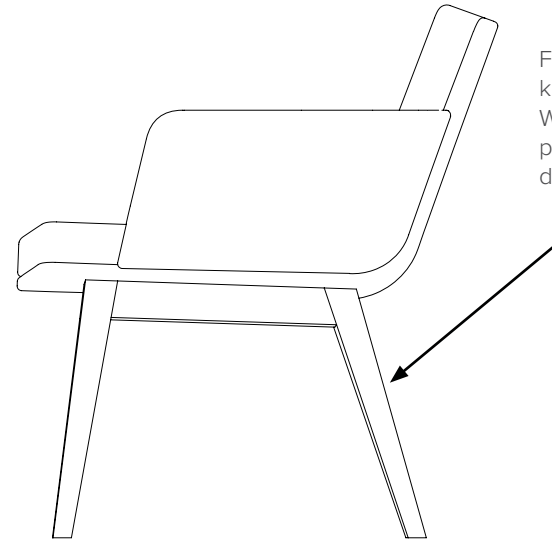

Variety of textiles and back options offer customers flexibility in design and consistency within each office setting.

STANDARD VENEER	PREMIUM VENEER	HIGH PRESSURE LAMINATE	THERMALLY FUSED LAMINATE
WLA Lofty Ash.....	N/A.....	N/A.....	N/A.....
WAM Alabaster Maple.....	N/A.....	GAM Alabaster Maple.....	N/A.....
N/A.....	WOW Clear Walnut.....	N/A.....	N/A.....
WEW Executive Walnut.....	N/A.....	GEW Executive Walnut.....	N/A.....
WGW Gunstock Walnut.....	N/A.....	N/A.....	N/A.....
WBW Henna Walnut.....	N/A.....	N/A.....	N/A.....
WSW Smokey Walnut.....	N/A.....	N/A.....	N/A.....
WNW Natural Walnut.....	N/A.....	GNW Natural Walnut.....	N/A.....
N/A.....	WMO Mocha Oak.....	N/A.....	N/A.....
N/A.....	WNO Natural Oak.....	N/A.....	N/A.....
N/A.....	WSO Salted Oak.....	N/A.....	N/A.....
WNF Natural Oak on Flat Cut.....	N/A.....	N/A.....	N/A.....
WMF Mocha Oak on Flat Cut.....	N/A.....	N/A.....	N/A.....
WSF Salted Oak on Flat Cut.....	N/A.....	N/A.....	N/A.....
N/A.....	TBCO Baby's Cheek.....	N/A.....	N/A.....
N/A.....	TBSW Brown Sugar.....	N/A.....	N/A.....
N/A.....	TOBW Organic Brown.....	N/A.....	N/A.....
N/A.....	TSTV Studio Teak Walnut.....	GSTV Studio Teak Walnut.....	N/A.....
N/A.....	TSMV Seattle Mist Walnut.....	N/A.....	N/A.....
N/A.....	TSLV Skyline Walnut.....	GSLV Skyline Walnut.....	N/A.....
WWP Designer White Paint.....	N/A.....	GWL Designer White.....	N/A.....
N/A.....	N/A.....	GNA Narvik Ash + 5%.....	N/A.....
WEC Ebony.....	N/A.....	GEC Ebony.....	N/A.....

Send 3x3 or larger finish chip for color match. Custom finish upcharge is 3% or \$250 Net (whichever is greater).



Finish

Welltech Finish delivers a superior furniture coating with exceptional performance that can withstand stringent cleaning agents and possesses unparalleled durability, allowing DARRAN to provide lasting, sustainable products to our customers.

Spire

Occasional Table
Y Blade Base Occasional Table

[Click here to view statement of line](#)

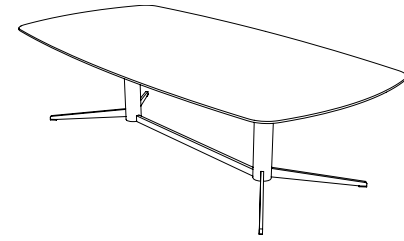

1 Select Model

w" x d" x h"
30" Depth
60 x 30 x 16
72 x 30 x 16
36" Depth
60 x 36 x 16
72 x 36 x 16

Weight

Standard Veneer Top	Premium Veneer Top	High Pressure Laminate Top	Thermally Fused Laminate Top
---------------------	--------------------	----------------------------	------------------------------

90	SPI6030RE111W 2186	SPI6030RE111P 2405	SPI6030RE111G 2186	"M" Option N/A
100	SPI7230RE111W 2240	SPI7230RE111P 2465	SPI7230RE111G 2240	"M" Option N/A
100	SPI6036RE111W 2283	SPI6036RE111P 2512	SPI6036RE111G 2283	"M" Option N/A
130	SPI7236RE111W 2460	SPI7236RE111P 2706	SPI7236RE111G 2460	"M" Option N/A

Product Features

- 1-5/16" Thick top
- WellTech Finish Technology on wood tops
- Hollow legs allow for concealed wire management
- Standard white blade metal base (optional black, silver)

Options

Power

- PDP01: Pepper (Power) - \$95 ea.
- PDS01: Salt (Powered USB) - \$225 ea.
- Installed directly above post

Premium Finish Option

- Base Metal Finish color - \$160 per base
- Specify MFB: Black, MFS: Silver, MFGM Matte Gold, MFDB Dark Bronze

2 Select Finish

[Click to view finishes](#)

Metal Finish

MFW White. Additional

Metal Finishes are

available, see options

WEC Cut)
WAM WSF(Salted
WEW Oak on Flat
WGW Cut)
WBW WMF(Mocha
WSW Oak on Flat
WNW Cut)
WWP
WLA
WNF(Natural
Oak on Flat

TBCO
TBSW
TSTV
TSMV
TSLV
TOBW
WMO
WNO
WSO

GEC
GAM
GEW
GNW
GSTV
GSLV
GWL
GNA + 5%

3 Select Edge



Spire



Spire



Spire

4 Select Hardware

[Click to view details](#)

Hardware
N/A

Hardware
N/A

Hardware
N/A

Spire

Occasional Table
Blade Base Occasional Table

[Click here to view statement of line](#)



1 Select Model

w" x d" x h"
30" Square
30 x 30 x 16
36" Square
36 x 36 x 16
42" Square
42 x 42 x 16

Weight

Standard Veneer Top	Premium Veneer Top	High Pressure Laminate Top	Thermally Fused Laminate Top
---------------------	--------------------	----------------------------	------------------------------

50	SPI3030SQ111W 1676	SPI3030SQ111P 1844	SPI3030SQ111G 1676	"M" Option N/A
55	SPI3636SQ111W 1792	SPI3636SQ111P 1972	SPI3636SQ111G 1792	"M" Option N/A
60	SPI4242SQ111W 1970	SPI4242SQ111P 2167	SPI4242SQ111G 1970	"M" Option N/A

Product Features

- 1-5/16" Thick top
- WellTech Finish Technology on wood tops
- Hollow legs allow for concealed wire management
- Standard white blade metal base (optional black, silver)

Options

Power

- PDP01: Pepper (Power) - \$95 ea.
- PDS01: Salt (Powered USB) - \$225 ea.
- Installed directly above post

Premium Finish Option

- Base Metal Finish color - \$160 per base
- Specify MFB: Black, MFS: Silver, MFGM Matte Gold, MFDB Dark Bronze

2 Select Finish

[Click to view finishes](#)

Metal Finish

MFV White. Additional

Metal Finishes are

available, see options

WEC Cut)
WAM WSF(Salted
WEW Oak on Flat
WGW Cut)
WBW WMF(Mocha
WSW Oak on Flat
WNW Cut)
WWP
WLA
WNF(Natural
Oak on Flat

TBCO
TBSW
TSTV
TSMV
TSLV
TOBW
WMO
WNO
WSO

GEC
GAM
GEW
GNW
GSTV
GSLV
GWL
GNA + 5%

3 Select Edge



Spire



Spire



Spire

4 Select Hardware

[Click to view details](#)

Hardware
N/A

Hardware
N/A

Hardware
N/A

Spire

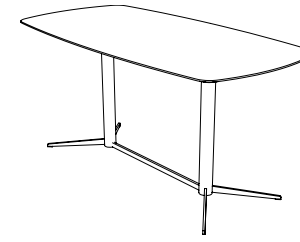

Conference Table
Y Blade Base Work Table

[Click here to view statement of line](#)



1 Select Model

w" x d" x h"	Weight
30" Depth	
60 x 30 x 29	100
72 x 30 x 29	110
36" Depth	
60 x 36 x 29	110
72 x 36 x 29	140
84 x 36 x 29	150

	Standard Veneer Top	Premium Veneer Top	High Pressure Laminate Top	Thermally Fused Laminate Top
WEC (Cut)		TBCO	GEC	
WAM (WSF(Salted Cut))		TBSW	GAM	
WEW (Oak on Flat Cut)		TSTV	GEW	
WGW (Cut)		TSMV	GNW	
WBW (WMF(Mocha Cut))		TSLV	GSTV	
WSW (Oak on Flat Cut)		TOBW	GSLV	
WNW (Cut)		WMO	GWL	
WWP		WNO	GNA + 5%	
WLA		WSO		
WNF(Natural Oak on Flat)				
				
		Hardware N/A	Hardware N/A	

2 Select Finish

[Click to view finishes](#)

Metal Finish
MFW White. Additional Metal Finishes are available, see options

3 Select Edge



4 Select Hardware

[Click to view details](#)

Hardware N/A

Product Features

- 1-5/16" Thick top
- WellTech Finish Technology on wood tops
- Hollow legs allow for concealed wire management
- Standard white blade metal base (optional black, silver)

Options

Power

- PDP01: Pepper (Power) - \$95 ea.
- PDS01: Salt (Powered USB) - \$225 ea.
- Installed directly above post

Premium Finish Option

- Base Metal Finish color - \$160 per base
- Specify MFB: Black, MFS: Silver, MFGM Matte Gold, MFDB Dark Bronze

Spire

Conference Table
Blade Base Work Table

[Click here to view statement of line](#)



1 Select Model

w" x d" x h"
30" Square
30 x 30 x 29
36" Square
36 x 36 x 29
42" Square
42 x 42 x 29

Weight

	Standard Veneer Top	Premium Veneer Top	High Pressure Laminate Top	Thermally Fused Laminate Top
55	SPI3030SQ121W 1731	SPI3030SQ121P 1905	SPI3030SQ121G 1731	"M" Option N/A
60	SPI3636SQ121W 1850	SPI3636SQ121P 2036	SPI3636SQ121G 1850	"M" Option N/A
65	SPI4242SQ121W 2026	SPI4242SQ121P 2228	SPI4242SQ121G 2026	"M" Option N/A

Product Features

- 1-5/16" Thick top
- WellTech Finish Technology on wood tops
- Hollow legs allow for concealed wire management
- Standard white blade metal base (optional black, silver)

Options

Power

- PDP01: Pepper (Power) - \$95 ea.
- PDS01: Salt (Powered USB) - \$225 ea.
- Installed directly above post

Premium Finish Option

- Base Metal Finish color - \$160 per base
- Specify MFB: Black, MFS: Silver, MFGM Matte Gold, MFDB Dark Bronze

2 Select Finish

[Click to view finishes](#)

Metal Finish

MFW White. Additional

Metal Finishes are available, options

WEC
WAM
WEW
WGW
WBW
WSW
WNW
WWP
WLA
WNF(Natural
Oak on Flat

Cut)
WSF(Salted
Oak on Flat
Cut)
WMF(Mocha
Oak on Flat
Cut)

TBCO
TBSW
TSTV
TSMV
TSLV
TOBW
WMO
WNO
WSO

GEC
GAM
GEW
GNW
GSTV
GSLV
GWL
GNA + 5%

3 Select Edge



Spire



Spire



Spire

4 Select Hardware

[Click to view details](#)

Hardware
N/A

Hardware
N/A

Hardware
N/A

Spire

Conference Table
Y Blade Base Bar Table

[Click here to view statement of line](#)



1 Select Model

w" x d" x h"
30" Depth
60 x 30 x 42
72 x 30 x 42
36" Depth
60 x 36 x 42
72 x 36 x 42
84 x 36 x 42

Weight

		Standard Veneer Top	Premium Veneer Top	High Pressure Laminate Top	Thermally Fused Laminate Top		
110	SPI6030RE141W	2389	SPI6030RE141P	2628	SPI6030RE141G	2389	"M" Option N/A
120	SPI7230RE141W	2452	SPI7230RE141P	2697	SPI7230RE141G	2452	"M" Option N/A
120	SPI6036RE141W	2479	SPI6036RE141P	2728	SPI6036RE141G	2479	"M" Option N/A
150	SPI7236RE141W	2656	SPI7236RE141P	2922	SPI7236RE141G	2656	"M" Option N/A
160	SPI8436RE141W	2878	SPI8436RE141P	3166	SPI8436RE141G	2878	"M" Option N/A

Product Features

- 1-5/16" Thick top
- WellTech Finish Technology on wood tops
- Hollow legs allow for concealed wire management
- Standard white blade metal base (optional black, silver)

Options

Power

- PDP01: Pepper (Power) - \$95 ea.
- PDS01: Salt (Powered USB) - \$225 ea.
- Installed directly above post

Premium Finish Option

- Base Metal Finish color - \$160 per base
- Specify MFB: Black, MFS: Silver, MFGM Matte Gold, MFDB Dark Bronze

2 Select Finish

[Click to view finishes](#)

Metal Finish
MFW White. Additional
Metal Finishes are
available, options

WEC
WAM
WEW
WGW
WBW
WSW
WNW
WWP
WLA
WNF(Natural
Oak on Flat

Cut)
WSF(Salted
Oak on Flat
Cut)
WMF(Mocha
Oak on Flat
Cut)

TBCO
TBSW
TSTV
TSMV
TSLV
TOBW
WMO
WNO
WSO

GEC
GAM
GEW
GNW
GSTV
GSLV
GWL
GNA + 5%

3 Select Edge



Spire



Spire



Spire

4 Select Hardware

[Click to view details](#)

Hardware
N/A

Hardware
N/A

Hardware
N/A

Spire

Conference Table
Blade Base Bar Table

[Click here to view statement of line](#)



1 Select Model

w" x d" x h"
30" Square
30 x 30 x 42
36" Square
36 x 36 x 42
42" Square
42 x 42 x 42

Weight	Standard Veneer Top		Premium Veneer Top		High Pressure Laminate Top		Thermally Fused Laminate Top
60	SPI3030SQ141W	1787	SPI3030SQ141P	1966	SPI3030SQ141G	1787	"M" Option N/A
65	SPI3636SQ141W	1906	SPI3636SQ141P	2098	SPI3636SQ141G	1906	"M" Option N/A
70	SPI4242SQ141W	2080	SPI4242SQ141P	2288	SPI4242SQ141G	2080	"M" Option N/A

Product Features

- 1-5/16" Thick top
- WellTech Finish Technology on wood tops
- Hollow legs allow for concealed wire management
- Standard white blade metal base (optional black, silver)

Options

Power

- PDP01: Pepper (Power) - \$95 ea.
- PDS01: Salt (Powered USB) - \$225 ea.
- Installed directly above post

Premium Finish Option

- Base Metal Finish color - \$160 per base
- Specify MFB: Black, MFS: Silver, MFGM Matte Gold, MFDB Dark Bronze

2 Select Finish

[Click to view finishes](#)

Metal Finish
MFW White. Additional
Metal Finishes are
available, options

WEC Cut)
WAM WSF(Salted
WEW Oak on Flat
WGW Cut)
WBW WMF(Mocha
WSW Oak on Flat
WNW Cut)
WWP
WLA
WNF(Natural
Oak on Flat

TBCO
TBSW
TSTV
TSMV
TSLV
TOBW
WMO
WNO
WSO

GEC
GAM
GEW
GNW
GSTV
GSLV
GWL
GNA + 5%

3 Select Edge



4 Select Hardware

[Click to view details](#)

Hardware
N/A

Hardware
N/A

Hardware
N/A

Spire

Barstool
Wood Base Barstool

[Click here to view statement of line](#)

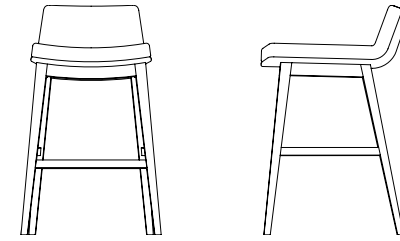

1 Model SPI2332WFS38

w" x d" x h"
22.5 x 22 x 36.5
Arm Height n/a
Seat Height 30"
Inside Seat Depth 16"
Inside Seat Width 19"

COM	COL	1	2	3	4	5	6	7	8	9	10	11/L1	12	13/L2
1446	1466	1521	1558	1595	1632	1669	1706	1743	1780	1817	1854	1891	1928	2002

Upholstery Requirements
Fabric yds: 2 Leather Sq. Ft.: 36
Carton Weight: 35

Product Features

- Seat and back utilizes high density ultra cell cushioning that conforms to individual's lumbar curvatures for adaptive support
- Upholstered seat and back
- Hardwood base to maximize strength and longevity
- Frame is constructed of kiln-dried solid Ash or Walnut, perpetuating premium quality and durability

2 Select Finish

[Click to view finishes](#)

- WEC Ebony
- WLA Lofty Ash
- WAM Alabaster Maple
- WMO Mocha Oak
- WNO Natural Oak
- WSO Salted Oak
- WOW Clear Walnut
- WEW Executive Walnut
- WGW Gunstock Walnut
- WBW Henna Walnut
- WSW Smokey Walnut
- WNW Natural Walnut
- TBCO Baby's Cheek
- TBSW Brown Sugar
- TSTV Studio Teak Walnut
- SSM Seattle Mist Paint
- SSL Skyline Walnut Paint
- TOBW Organic Brown
- WWP Designer White Paint

3 Combination Fabrics

[Click to view finishes](#)

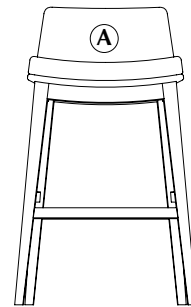

Front View

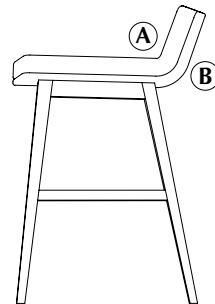

Side View

DARRAN is pleased to offer customers the design freedom of combination fabrics. When using fabric, vinyl or leather combinations, pricing/yardage requirements will be as follows:

- A Inside Seat 1 yd(s).
- B Outside Back 1 yd(s).

- When combining two materials of the same grade, pricing will be specified grade + 5%
- If combining two materials of different grades or leather/fabric combination, use the highest grade/price + 5%
- If using COM or COL, pricing will be COM or COL + 5%
- If both COM + COL are used in combination, use COL + 5%

Spire

Guest Chair
Wood Base Guest Chair

[Click here to view statement of line](#)

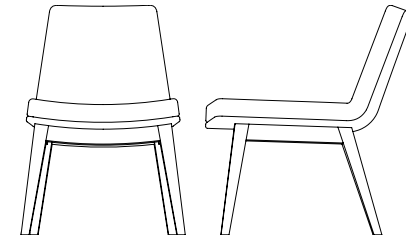

1 Model SPI2332WFC24

w" x d" x h"
20.5 x 26 x 29
Arm Height n/a
Seat Height 17"
Inside Seat Depth 18"
Inside Seat Width 19"

COM	COL	1	2	3	4	5	6	7	8	9	10	11/L1	12	13/L2
1309	1390	1392	1433	1474	1515	1556	1597	1638	1679	1720	1761	1802	1843	1925

Upholstery Requirements
Fabric yds: 2.25 Leather Sq. Ft.: 40.5
Carton Weight: 25

Product Features

- Seat and back utilizes high density ultra cell cushioning that conforms to individual's lumbar curvatures for adaptive support
- Upholstered seat and back
- Hardwood base to maximize strength and longevity
- Frame is constructed of kiln-dried solid Ash or Walnut, perpetuating premium quality and durability

2 Select Finish

[Click to view finishes](#)

- WEC Ebony
- WLA Lofty Ash
- WAM Alabaster Maple
- WMO Mocha Oak
- WNO Natural Oak
- WSO Salted Oak
- WOW Clear Walnut
- WEW Executive Walnut
- WGW Gunstock Walnut
- WBW Henna Walnut
- WSW Smokey Walnut
- WNW Natural Walnut
- TBCO Baby's Cheek
- TBSW Brown Sugar
- TSTV Studio Teak Walnut
- SSM Seattle Mist Paint
- SSL Skyline Walnut Paint
- TOBW Organic Brown
- WWP Designer White Paint

3 Combination Fabrics

[Click to view finishes](#)

DARRAN is pleased to offer customers the design freedom of combination fabrics. When using fabric, vinyl or leather combinations, pricing/yardage requirements will be as follows:

- A Inside Seat 1.25 yd(s).
- B Outside Back 1 yd(s).

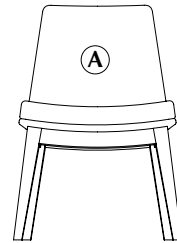

Front View

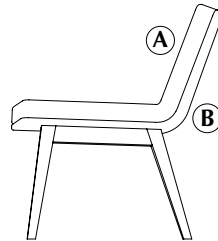

Side View

- When combining two materials of the same grade, pricing will be specified grade + 5%
- If combining two materials of different grades or leather/fabric combination, use the highest grade/price + 5%
- If using COM or COL, pricing will be COM or COL + 5%
- If both COM + COL are used in combination, use COL + 5%

Spire

Guest Chair
Wood Base Guest Chair W/ Arms

[Click here to view statement of line](#)

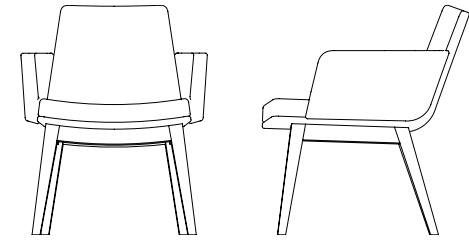

1 Model SPI2332WFC25

w" x d" x h"
24.5 x 26 x 29
Arm Height 23.5"
Seat Height 17"
Inside Seat Depth 18"
Inside Seat Width 19"

COM	COL	1	2	3	4	5	6	7	8	9	10	11/L1	12	13/L2
1631	1735	1742	1797	1852	1907	1962	2017	2072	2127	2182	2237	2292	2347	2457

Upholstery Requirements
Fabric yds: 3 Leather Sq. Ft.: 54
Carton Weight: 30

Product Features

- Seat and back utilizes high density ultra cell cushioning that conforms to individual's lumbar curvatures for adaptive support
- Upholstered seat, back and arms
- Hardwood base to maximize strength and longevity
- Frame is constructed of kiln-dried solid Ash or Walnut, perpetuating premium quality and durability

2 Select Finish

[Click to view finishes](#)

- WEC Ebony
- WLA Lofty Ash
- WAM Alabaster Maple
- WMO Mocha Oak
- WNO Natural Oak
- WSO Salted Oak
- WOW Clear Walnut
- WEW Executive Walnut
- WGW Gunstock Walnut
- WBW Henna Walnut
- WSW Smokey Walnut
- WNW Natural Walnut
- TBCO Baby's Cheek
- TBSW Brown Sugar
- TSTV Studio Teak Walnut
- SSM Seattle Mist Paint
- SSL Skyline Walnut Paint
- TOBW Organic Brown
- WWP Designer White Paint

3 Combination Fabrics

[Click to view finishes](#)

DARRAN is pleased to offer customers the design freedom of combination fabrics. When using fabric, vinyl or leather combinations, pricing/yardage requirements will be as follows:

A Inside Seat 2 yd(s).
B Outside Back and Arms 1 yd(s).

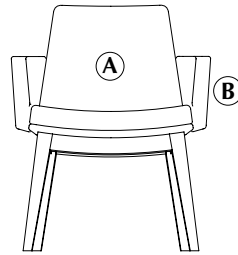

Front View

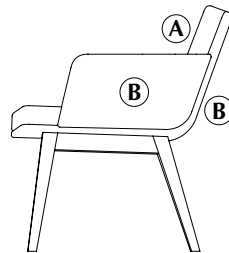

Side View

- When combining two materials of the same grade, pricing will be specified grade + 5%
- If combining two materials of different grades or leather/fabric combination, use the highest grade/price + 5%
- If using COM or COL, pricing will be COM or COL + 5%
- If both COM + COL are used in combination, use COL + 5%

Spire

Lounge Chair
Wood Base Lounge Chair

[Click here to view statement of line](#)

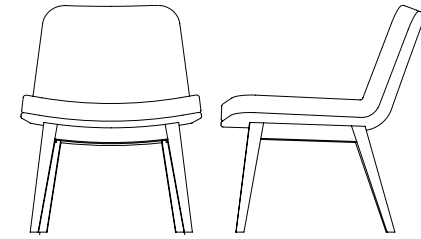

1 Model SPI2332WFL24

w" x d" x h"
22.5 x 26 x 29
Arm Height n/a
Seat Height 17"
Inside Seat Depth 18"
Inside Seat Width 22.5

COM	COL	1	2	3	4	5	6	7	8	9	10	11/L1	12	13/L2
1314	1395	1407	1453	1499	1545	1591	1637	1683	1729	1775	1821	1867	1913	2005

Upholstery Requirements
Fabric yds: 2.5 Leather Sq. Ft.: 45
Carton Weight: 25

Product Features

- Seat and back utilizes high density ultra cell cushioning that conforms to individual's lumbar curvatures for adaptive support
- Upholstered seat and back
- Hardwood base to maximize strength and longevity
- Frame is constructed of kiln-dried solid Ash or Walnut, perpetuating premium quality and durability

2 Select Finish

[Click to view finishes](#)

- WEC Ebony
- WLA Lofty Ash
- WAM Alabaster Maple
- WMO Mocha Oak
- WNO Natural Oak
- WSO Salted Oak
- WOW Clear Walnut
- WEW Executive Walnut
- WGW Gunstock Walnut
- WBW Henna Walnut
- WSW Smokey Walnut
- WNW Natural Walnut
- TBCO Baby's Cheek
- TBSW Brown Sugar
- TSTV Studio Teak Walnut
- SSM Seattle Mist Paint
- SSL Skyline Walnut Paint
- TOBW Organic Brown
- WWP Designer White Paint

3 Combination Fabrics

[Click to view finishes](#)

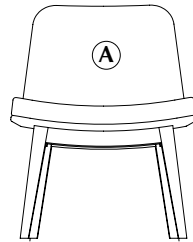

Front View

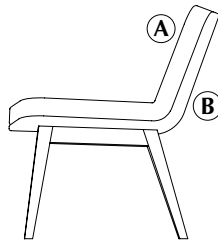

Side View

DARRAN is pleased to offer customers the design freedom of combination fabrics. When using fabric, vinyl or leather combinations, pricing/yardage requirements will be as follows:

A Inside Seat 1.25 yd(s).
B Outside Back 1.25 yd(s).

- When combining two materials of the same grade, pricing will be specified grade + 5%
- If combining two materials of different grades or leather/fabric combination, use the highest grade/price + 5%
- If using COM or COL, pricing will be COM or COL + 5%
- If both COM + COL are used in combination, use COL + 5%

Spire

Lounge Chair
Wood Base Lounge Chair W/ Arms

[Click here to view statement of line](#)

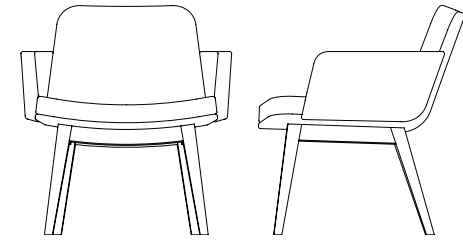

1 Model SPI2332WFL25

w" x d" x h"
26.5 x 26 x 29
Arm Height 23.5"
Seat Height 18"
Inside Seat Depth 18"
Inside Seat Width 22.5

COM	COL	1	2	3	4	5	6	7	8	9	10	11/L1	12	13/L2
1643	1747	1773	1837	1901	1965	2029	2093	2157	2221	2285	2349	2413	2477	2605

Upholstery Requirements
Fabric yds: 3.5 Leather Sq. Ft.: 63
Carton Weight: 30

Product Features

- Seat and back utilizes high density ultra cell cushioning that conforms to individual's lumbar curvatures for adaptive support
- Upholstered seat, back and arms
- Hardwood base to maximize strength and longevity
- Frame is constructed of kiln-dried solid Ash or Walnut, perpetuating premium quality and durability

2 Select Finish

[Click to view finishes](#)

- WEC Ebony
- WLA Lofty Ash
- WAM Alabaster Maple
- WMO Mocha Oak
- WNO Natural Oak
- WSO Salted Oak
- WOW Clear Walnut
- WEW Executive Walnut
- WGW Gunstock Walnut
- WBW Henna Walnut
- WSW Smokey Walnut
- WNW Natural Walnut
- TBCO Baby's Cheek
- TBSW Brown Sugar
- TSTV Studio Teak Walnut
- SSM Seattle Mist Paint
- SSL Skyline Walnut Paint
- TOBW Organic Brown
- WWP Designer White Paint

3 Combination Fabrics

[Click to view finishes](#)

DARRAN is pleased to offer customers the design freedom of combination fabrics. When using fabric, vinyl or leather combinations, pricing/yardage requirements will be as follows:

A Inside Seat 2.25 yd(s).s
B Outside Back and Arms 1.25 yd(s).

- When combining two materials of the same grade, pricing will be specified grade + 5%
- If combining two materials of different grades or leather/fabric combination, use the highest grade/price + 5%
- If using COM or COL, pricing will be COM or COL + 5%
- If both COM + COL are used in combination, use COL + 5%

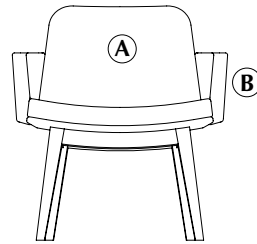

Front View

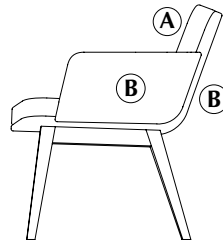

Side View

Spire

Guest Chair
Swivel Blade Base Guest Chair

[Click here to view statement of line](#)

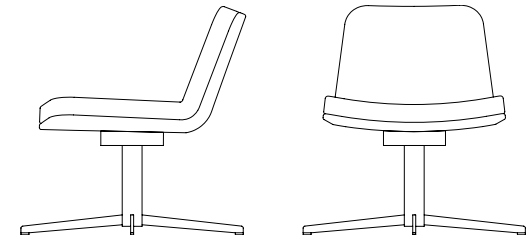

1 Model SPI2332NSC26

w" x d" x h"
20.5 x 26 x 29
Arm Height n/a
Seat Height 18"
Inside Seat Depth 18"
Inside Seat Width 19"

COM	COL	1	2	3	4	5	6	7	8	9	10	11/L1	12	13/L2
1557	1638	1640	1681	1722	1763	1804	1845	1886	1927	1968	2009	2050	2091	2173

Upholstery Requirements
Fabric yds: 2.25 Leather Sq. Ft.: 40.5
Carton Weight: 25

Product Features

- Seat and back utilizes high density ultra cell cushioning that conforms to individual's lumbar curvatures for adaptive support
- Upholstered seat and back
- Carbon steel powdercoated base with a memory swivel
- Standard white blade metal base (optional black, silver)

2 Select Finish

[Click to view finishes](#)

Metal Finish
MFW White. Additional Metal Finishes are available, see options

3 Combination Fabrics

[Click to view finishes](#)

DARRAN is pleased to offer customers the design freedom of combination fabrics. When using fabric, vinyl or leather combinations, pricing/yardage requirements will be as follows:

A Inside Seat 1.25 yd(s).
B Outside Back 1 yd(s).

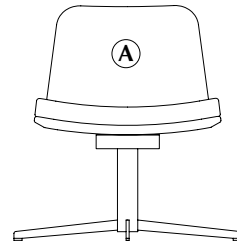

Front View

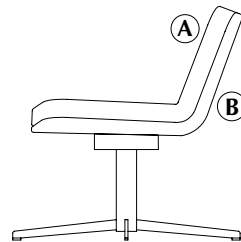

Side View

- When combining two materials of the same grade, pricing will be specified grade + 5%
- If combining two materials of different grades or leather/fabric combination, use the highest grade/price + 5%
- If using COM or COL, pricing will be COM or COL + 5%
- If both COM + COL are used in combination, use COL + 5%

Spire

Guest Chair

Swivel Blade Base Guest Chair W/ Arms

[Click here to view statement of line](#)

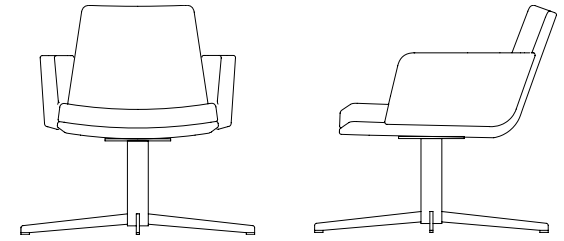

1 Model SPI2332ASC27

w" x d" x h"
24.5 x 26 x 29
Arm Height 23.5"
Seat Height 18"
Inside Seat Depth 18"
Inside Seat Width 19"

COM	COL	1	2	3	4	5	6	7	8	9	10	11/L1	12	13/L2
1947	2051	2058	2113	2168	2223	2278	2333	2388	2443	2498	2553	2608	2663	2773

Upholstery Requirements
Fabric yds: 3 Leather Sq. Ft.: 54
Carton Weight: 30

Product Features

- Seat and back utilizes high density ultra cell cushioning that conforms to individual's lumbar curvatures for adaptive support
- Upholstered seat, back and arms
- Carbon steel powdercoated base with a memory swivel
- Standard white blade metal base (optional black, silver)

2 Select Finish

[Click to view finishes](#)

Metal Finish
MFW White. Additional Metal Finishes are available, see options

3 Combination Fabrics

[Click to view finishes](#)

DARRAN is pleased to offer customers the design freedom of combination fabrics. When using fabric, vinyl or leather combinations, pricing/yardage requirements will be as follows:

A Inside Seat 2 yd(s).
B Outside Back and Arms 1 yd(s).

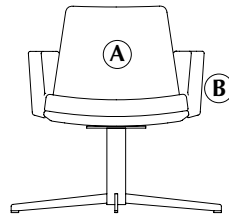

Front View

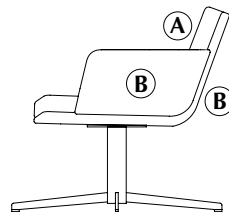

Side View

- When combining two materials of the same grade, pricing will be specified grade + 5%
- If combining two materials of different grades or leather/fabric combination, use the highest grade/price + 5%
- If using COM or COL, pricing will be COM or COL + 5%
- If both COM + COL are used in combination, use COL + 5%

Spire

Lounge Chair
Swivel Blade Base Lounge Chair

[Click here to view statement of line](#)

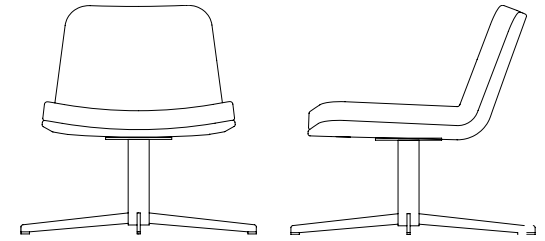

1 Model SPI2332NSL26

w" x d" x h"
22.5 x 26 x 29
Arm Height n/a
Seat Height 18"
Inside Seat Depth 18"
Inside Seat Width 22.5"

COM	COL	1	2	3	4	5	6	7	8	9	10	11/L1	12	13/L2
1574	1655	1685	1740	1795	1850	1905	1960	2015	2070	2125	2180	2235	2290	2400

Upholstery Requirements
Fabric yds: 3 Leather Sq. Ft.: 54
Carton Weight: 25

Product Features

- Seat and back utilizes high density ultra cell cushioning that conforms to individual's lumbar curvatures for adaptive support
- Upholstered seat and back
- Carbon steel powdercoated base with a memory swivel
- Standard white blade metal base (optional black, silver)

2 Select Finish

[Click to view finishes](#)

Metal Finish
MFW White. Additional Metal Finishes are available, see options

3 Combination Fabrics

[Click to view finishes](#)

DARRAN is pleased to offer customers the design freedom of combination fabrics. When using fabric, vinyl or leather combinations, pricing/yardage requirements will be as follows:

A Inside Seat 2 yd(s).s
B Outside Back 1 yd(s).s

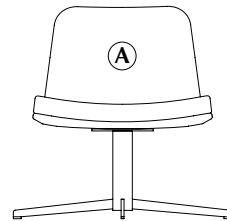

Front View

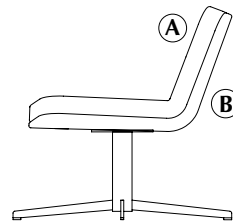

Side View

- When combining two materials of the same grade, pricing will be specified grade + 5%
- If combining two materials of different grades or leather/fabric combination, use the highest grade/price + 5%
- If using COM or COL, pricing will be COM or COL + 5%
- If both COM + COL are used in combination, use COL + 5%

Spire

Lounge Chair
Swivel Blade Base Lounge Chair W/ Arms

[Click here to view statement of line](#)

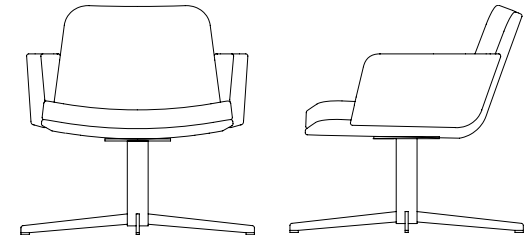

1 Model SPI2332ASL27

w" x d" x h"
26.5 x 26 x 29
Arm Height 23.5"
Seat Height 18"
Inside Seat Depth 18"
Inside Seat Width 22.5

COM	COL	1	2	3	4	5	6	7	8	9	10	11/L1	12	13/L2
1959	2063	2089	2153	2217	2281	2345	2409	2473	2537	2601	2665	2729	2793	2921

Upholstery Requirements
Fabric yds: 3.5 Leather Sq. Ft.: 63
Carton Weight: 30

Product Features

- Seat and back utilizes high density ultra cell cushioning that conforms to individual's lumbar curvatures for adaptive support
- Upholstered seat, back and arms
- Carbon steel powdercoated base with a memory swivel
- Standard white blade metal base (optional black, silver)

2 Select Finish

[Click to view finishes](#)

Metal Finish
MFW White. Additional Metal Finishes are available, see options

3 Combination Fabrics

[Click to view finishes](#)

DARRAN is pleased to offer customers the design freedom of combination fabrics. When using fabric, vinyl or leather combinations, pricing/yardage requirements will be as follows:

A Inside Seat 2.25 yd(s).s
B Outside Back and Arms 1.25 yd(s).

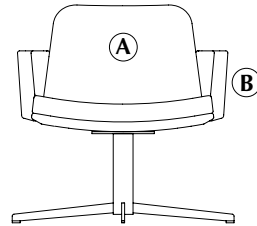

Front View

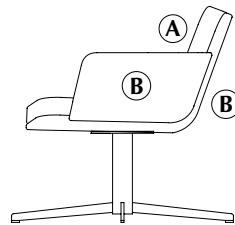

Side View

- When combining two materials of the same grade, pricing will be specified grade + 5%
- If combining two materials of different grades or leather/fabric combination, use the highest grade/price + 5%
- If using COM or COL, pricing will be COM or COL + 5%
- If both COM + COL are used in combination, use COL + 5%

Options

Premium Finish Option

- Base Metal Finish color - \$160 per base
- Specify MFB: Black, MFS: Silver, MFGM Matte Gold, MFDB Dark Bronze
- MFW: White, MFS: Silver, MFGG: Graphite Gray, MFSS: Salmon Sienna, MFSA: Surfing Aquavert, MFPS: Pistachio, MFOS: Oyster, MFNA: Navy, MFOL: Olive, MFGB: Grey Beige

Spire

Conference Lounge Chair
Conference Chair

[Click here to view statement of line](#)

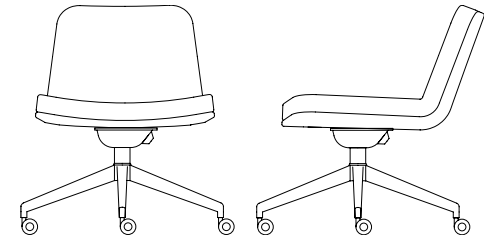

1 Model SPI2332NLC31

w" x d" x h"
27 x 26 x 31.5
Arm Height n/a
Seat Height 19-22"
Inside Seat Depth 18"
Inside Seat Width 22.5"

COM	COL	1	2	3	4	5	6	7	8	9	10	11/L1	12	13/L2
1595	1676	1688	1734	1780	1826	1872	1918	1964	2010	2056	2102	2148	2194	2286

Upholstery Requirements
Fabric yds: 2.5 Leather Sq. Ft.: 45
Carton Weight: 30

Product Features

- 26" diameter polished aluminum base
- Seat and back utilizes high density ultra cell cushioning that conforms to individual's lumbar curvatures for adaptive support
- Knee Tilt Swivel w/ forward pivot point
- Large 60mm diameter casters are standard to promote increased mobility
- Upholstered seat and back

3 Combination Fabrics

[Click to view finishes](#)

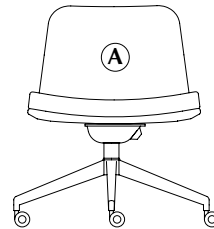

Front View

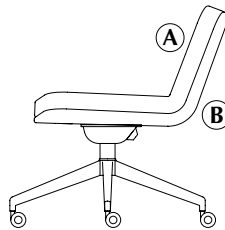

Side View

DARRAN is pleased to offer customers the design freedom of combination fabrics. When using fabric, vinyl or leather combinations, pricing/yardage requirements will be as follows:

A Inside Seat 1.25 yd(s).
B Outside Back 1.25 yd(s).

- When combining two materials of the same grade, pricing will be specified grade + 5%
- If combining two materials of different grades or leather/fabric combination, use the highest grade/price + 5%
- If using COM or COL, pricing will be COM or COL + 5%
- If both COM + COL are used in combination, use COL + 5%

Spire

Conference Lounge Chair
Conference Chair W/ Arms

[Click here to view statement of line](#)

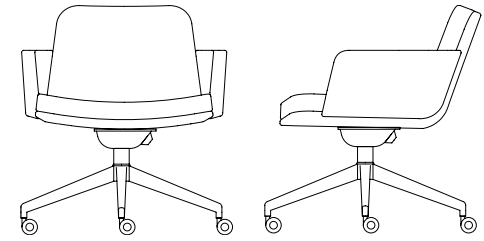

1 Model SPI2332ALC32

w" x d" x h"
24.5 x 26 x 29
Arm Height
Seat Height 18-22"
Inside Seat Depth 18"
Inside Seat Width 22.5"

COM	COL	1	2	3	4	5	6	7	8	9	10	11/L1	12	13/L2
1986	2090	2116	2180	2244	2308	2372	2436	2500	2564	2628	2692	2756	2820	2948

Upholstery Requirements
Fabric yds: 3.5 Leather Sq. Ft.: 63
Carton Weight: 30

Product Features

- 26" diameter polished aluminum base
- Seat and back utilizes high density ultra cell cushioning that conforms to individual's lumbar curvatures for adaptive support
- Knee Tilt Swivel w/ forward pivot point
- Large 60mm diameter casters are standard to promote increased mobility
- Upholstered Seat, back and arms

2 Select Finish

[Click to view finishes](#)

3 Combination Fabrics

[Click to view finishes](#)

DARRAN is pleased to offer customers the design freedom of combination fabrics. When using fabric, vinyl or leather combinations, pricing/yardage requirements will be as follows:

A Inside Seat 2.25 yd(s).s
B Outside Back and Arms
1.25 yd(s).

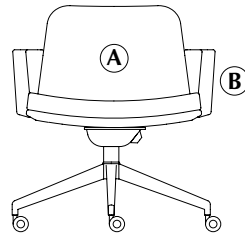

Front View

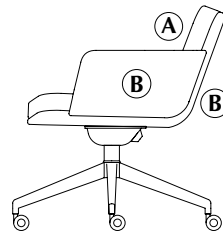

Side View

- When combining two materials of the same grade, pricing will be specified grade + 5%
- If combining two materials of different grades or leather/fabric combination, use the highest grade/price + 5%
- If using COM or COL, pricing will be COM or COL + 5%
- If both COM + COL are used in combination, use COL + 5%

Salt & pepper power ports

Style Number

List Price



PDP01 Pepper (power)

\$95

PDS01 Salt (powered USB)

\$225

Specifications

- > Pepper port includes 1 power plug
- > Salt port includes 2 power USB
- > Cord is 72" long
- > Spill-proof technology

Available: Boss, Spire

Power & Data Options



Pepper power pod



Salt powered USB





Tablo Price List

Effective November 1, 2022

Designed By Michael Wolk

Date	Page	Modification	Description
11.10.22		Price Increase	9% price increase applied to all items excluding options
5.15.23		Removed WLA and added WLO and WLF finish	

Statement of Line
Fabric seat & leather program.....1
Finishes4
Platforms7
Cushion10
Ottoman Platform16
Ottoman Cushion18
Platform - Ottoman.....22
Seating Unit - Ottoman.....23
Power and Data32

Statement of Line

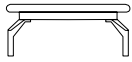

Page 7
Platform - Bench
21 3/4" Depth One Seat Bench
Platform

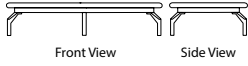

Page 8
Platform - Bench
21 3/4" Depth Two Seat Bench
Platform

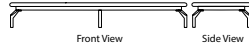

Page 9
Platform - Bench
21 3/4" Depth Three Seat Bench
Platform

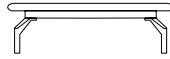

Page 10
Platform - Seating Units (Cushion)
33 3/4" Depth One Seat Platform



Page 11
Platform - Seating Units (Cushion)
33 3/4" Depth Two Seat Platform

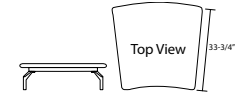

Page 12
Platform - Inside Radius Seating
Unit (Cushion)
15 Degree Inside Radius Platform

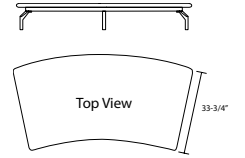

Page 13
Platform - Inside Radius Seating
Unit (Cushion)
30 Degree Inside Radius Platform

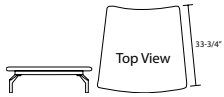

Page 14
Platform - Outside Radius Seating
Unit (Cushion)
15 Degree Outside Radius
Platform

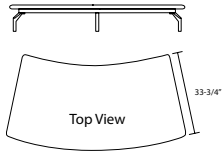

Page 15
Platform - Outside Radius Seating
Unit (Cushion)
30 Degree Outside Radius
Platform

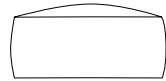

Page 16
Seating Unit - Bench
19 1/2" One Seat Bench Cushion

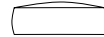

Page 17
Seating Unit - Bench
31-1/2" One Seat Bench Cushion



Page 18
Seating Unit - Cushion
Armless Chair Cushion



Page 19
Seating Unit - Cushion
Left Arm (Facing) Chair Cushion



Page 20
Seating Unit - Cushion
Right Arm (Facing) Chair Cushion

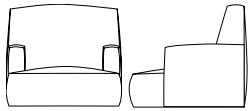

Page 21
Seating Unit - Cushion
Lounge Chair Cushion

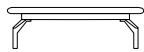

Page 22
Platform - Ottoman
20" Depth Ottoman Platform



Page 23
Seating Unit - Ottoman
18" Ottoman Cushion

Seating & fabric leather program

DARRAN has partnered with some of the most prestigious fabric suppliers of the office furniture industry to bring you quality fabrics that are engaging designs, environmentally friendly and durable for years to come. The majority of fabrics we have graded-in are in heavy supply making it most likely available on our Quickship however, we cannot guarantee stock. If you do not see the fabric you wish to include in a project, please contact our Factory to see if this pattern can be graded in at 800.334.7891.

Fabrics & Leathers

Please visit our Seating Fabrics page at darran.com/textilesleather

Camira
www.camirafabrics.com
 800.334.789

Wollsdorf
www.wollsdorf.com
 336.884.5005

CFStinson
www.cfstinson.com
 800.841.6279

Green Hides
www.greenhides.com
 336.315.9720

DesignTex
www.designtex.com
 800.797.4949

Maharam
www.maharam.com
 800.645.3943

Momentum Textiles
www.momentumtextiles.com
 800.366.6839

Ultrafabrics
www.ultrafabricsinc.com
 800.334.7891

Application instructions must be specified on the purchase order or COM / COL submission form. In the absence of application instructions, DARRAN will apply materials accordingly.

CAL117

All DARRAN seating products conform to California Technical Bulletin 117 as a minimum standard.

CAL133

To meet the California Technical Bulletin 133 flammability regulation, a combination of proper materials must be used to pass, as it tests the fire resistance of a finished product. Flame resistant fabric, a fire blocker material and special foam must be used to pass CAL133 fire codes.

Testing is available for all seating products with the following fees and considerations:

- If laboratory certification is not required, any style can be manufactured to comply with California Technical Bulletin 133 for \$75 list per yard required. (Customer's Own Materials must factor in additional yardage requirements based on repeat.)
- The purchase order must clearly indicate the requirement of California Technical Bulletin 133
- If laboratory California Technical Bulletin 133 certification is required, the cost of testing a chair is \$820 NET, plus the cost of the chair and covering material.
- An additional lead time of 4 to 6 weeks is required for testing for CAL133.
- Once testing is completed, we will provide a certification letter specific to the sample tested for CAL133.
- DARRAN's manufacturing procedures for California TB 133 compliance are based on the testing of representative style with specific fabrics. Please contact Customer Service for an updated list of tested models.
- A copy of test certification is available upon request.

Combination fabrics

DARRAN is pleased to offer customers the design freedom of combination fabrics. When using fabric, vinyl or leather combinations, pricing will be as follows:

- When combining two materials of the same grade, pricing will be specified grade + 5%.
- If combining two materials of different grades or leather/ fabric combination, use the highest grade/price + 5%.
- If using COM or COL, pricing will be COM or COL + 5%. If both COM + COL are used in combination, use COL + 5%

COM/COL ordering instructions

Please complete the COM Submission Form prior to ordering the fabric from the supplier. All COM fabrics must be approved prior to order submission. Please refer to our website or contact DARRAN Seating Customer Service for an updated list of preapproved COM fabrics. Application instructions must be specified on the purchase order or COM/COL submission form. In the absence of application instructions, DARRAN will apply materials in the best manner and cannot be held responsible for tailoring or application objections after upholstery. COM orders will be scheduled for production after receipt of the material. Packages must be clearly marked and the fabric must be first quality, continuous yardage.

COM/COL yardage requirements

The yardage requirements stated in this price list for each style are calculated using 54" wide, non-directional fabrics. For fabrics with a different width or for patterns with repeats, please refer to the below chart to calculate the additional percent of fabric required:

Fabric Width	Plain Fabric	2" - 14" Repeat	15" - 19" Repeat	20" - 27" Repeat	28" - 36" Repeat
54"	0	15%	20%	25%	30%
53"	6%	19%	24%	28%	36%
52"	13%	23%	28%	33%	38%
51"	19%	26%	31%	36%	41%
50"	25%	30%	35%	40%	45%
49"	30%	35%	40%	45%	50%
48"	35%	40%	45%	50%	55%
47"	45%	50%	55%	58%	65%

DARRAN®

NOTE: Prior To Completion Of This Form, Please Refer To Our Graded In Materials Program For Preapproved Fabrics/Leathers.

COM/COL Approval

DARRAN Furniture Industries
2402 Shore Street, High Point, NC 27263
ATTN: Seating Division / COM/COL Approval
TAG: DARRAN Purchase Order Number

Shipping approved COM/COL materials

DARRAN Furniture Industries
2402 Shore Street, High Point, NC 27263
ATTN: Seating Division / COM/COL Approval
TAG: DARRAN Purchase Order Number

Please complete this form, attach a 6"x 6" sample and mail to the COM/COL APPROVAL address shown above.
This form can also be downloaded from our website at www.darran.com/leathers OR www.darran.com/fabrics

Purchase Order # _____

Dealer's Name _____

Contact _____

Address _____

Telephone _____

Email _____

Chair Stlye _____

Manufacturer _____

Pattern Name _____

Pattern Color _____

Content _____

Repeat _____

Please specify any special requirements and check the application above.

Tablo Seating Fabric & Leather Program

ATTACH 6" X 6" FABRIC/LEATHER SAMPLE HERE

NOTE

Actual Fabric/Leather samples needed instead of digital images. If digital images are sent in lieu of samples, DARRAN will only verify the pattern and will not take responsibility for color variances that cannot be verified due to printing restrictions

In the absence of application instructions, DARRAN will apply the material in the best manner and cannot be held responsible for tailoring or application objections after upholstering.

Unless otherwise instructed on the purchase order, excess COM materials will be recycled at the discretion of DARRAN after six months of the original product ship date.

The COM approval solely pertains to the application of the fabric onto the specified DARRAN seating product. DARRAN's approval or acceptance does not constitute any responsibility or warranty to the overall appearance, durability, flammability, defects, dye lot variations or colorfastness of the COM. It is the customer's responsibility to ensure the COM meets CAL 117 compliance and are first quality continuous goods.

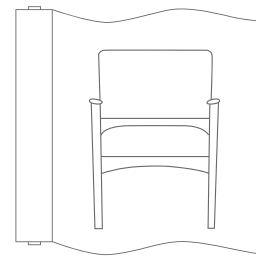

RAILROAD

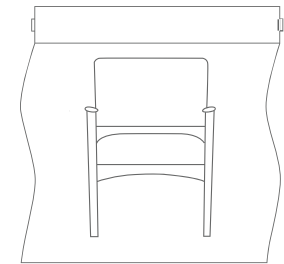

SETUP

STANDARD VENEER FINISHES

WAC Amber Cherry
WEC Ebony
WIC Crimson Cherry
WHC Honey Cherry
WOC KoKo Cherry
WAM Alabaster Maple
WCM Clear Maple
WEW Executive Walnut
WGW Gunstock Walnut
WBW Henna Walnut
WNW Natural Walnut
WSW Smokey Walnut
WWP Designer White
WLF Lofty Oak on Flat cut
WNF Natural Oak on Flat Cut
WMF Mocha Oak on Flat Cut
WSF Salted Oak on Flat Cut

PREMIUM VENEER FINISHES

WLO Lofty Oak
WMO Mocha Oak
WNO Natural Oak
WSO Salted Oak
TBCO Baby's Cheek
TBSW Brown Sugar
TSTV Studio Teak Walnut
TSMV Seattle Mist
TSLV Skyline Walnut
TOBW Organic Brown



Finish

Welltech Finish delivers a superior furniture coating with exceptional performance that can withstand stringent cleaning agents and possesses unparalleled durability, allowing DARRAN to provide lasting, sustainable products to our customers.

Tablo

Platform - Bench
21 3/4" Depth One Seat Bench Platform

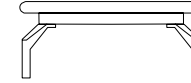

[Click here to view statement of line](#)

1 Select Model

w" x d" x h"
Platform Bench For Cushion
21.75 x 21.75 x 8.5 25
Platform Bench Used as Table
21.75 x 21.75 x 8.5 35
*Cushion not included

Weight

Standard Veneer Top Standard Veneer Chassis	Premium Veneer Top Premium Veneer Chassis	High Pressure Laminate Top Veneer Chassis	Thermally Fused Laminate Top Thermally Fused Laminate Chassis
TAB2121RPT01W 852	TAB2121RPT01P 938	"G" Option N/A	"M" Option N/A
TAB2121RPT00W 852	TAB2121RPT00P 938	"G" Option N/A	"M" Option N/A

Product Features

- 1- 1/4" Platform
- Polished Aluminum legs
- Platforms for a cushion feature a route to reduce unit weight

Notes

- If platform for cushion is desired, use with 19-1/2" bench cushion
- Power Options not available on Platform for Cushion
- Cushions (ordered separately) attach to platform with 4 bolts (Field Assembly Required). Cushions are reversible on platform.
- Each flush cut option reduces the platform width 5/8"

Options

Flush Cut

- FC-B: Flush Unit Both Sides(Facing) for Ganging - \$100
- FC-L: Flush Unit Left (Facing) for Ganging - \$100
- FC-R: Flush Unit Right(Facing) for Ganging - \$100

Power

- AirCharge offers a convenient way to charge any Qi compatible smart-phone or device without the need to carry charging cables or find an available power outlet.
- ACWG: AirCharge Wireless Grommet - \$213
 - Cove Power Pod (Linking/Non-Linking)
 - PD-COVE: Non-Linking Rectangle Power Unit - \$600, For Table Top
 - COV-DCH: Hardwire Infeed, 1 Linking Cove unit - \$774
 - COV-DCP: Plug Infeed, 1 Linking Cove unit - \$872
 - COV-DCL: Additional Units (includes 1 Linking Cove unit + 72" jumpers) - \$627

2 Select Finish

[Click to view finishes](#)

WAC	WLF(Lofty Oak on Flat
WIC	Oak on Flat Cut)
WHC	Cut)
WOC	WNW
WEC	WNF(Natural
WAM	Oak on Flat
WCM	Cut)
WEW	WSF(Salted
WGW	Oak on Flat
WBW	Cut)
WSW	WMF(Mocha

TBCO
TBSW
TSTV
TSMV
TSLV
TOBW
WLO
WMO
WNO
WSO

3 Select Edge

[Click to view edges](#)

Edge
N/A

Edge
N/A

4 Select Hardware

[Click to view details](#)

Hardware
N/A

Hardware
N/A

Tablo

Platform - Bench
21 3/4" Depth Two Seat Bench Platform

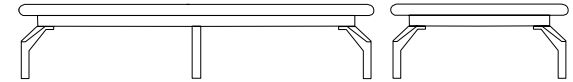

Front View

Side View

[Click here to view statement of line](#)

1 Select Model

w" x d" x h"

Platform Bench For Left Facing Cushion	Weight	Standard Veneer Top Standard Veneer Chassis	Premium Veneer Top Premium Veneer Chassis	High Pressure Laminate Top Veneer Chassis	Thermally Fused Laminate Top Thermally Fused Laminate Chassis
42.25 x 21.75 x 8.5	45	TAB4221RPT02W	1312	TAB4221RPT02P	1444
Platform Bench For Right Facing Cushion					
42.25 x 21.75 x 8.5	45	TAB4221RPT03W	1312	TAB4221RPT03P	1444
Platform Bench For Left & Right Facing Cushion					
42.25 x 21.75 x 8.5	40	TAB4221RPT05	1740	TAB4221RPT05P	1915
Platform Bench Used as Table Platform					
42.25 x 21.75 x 8.5	55	TAB4221RPT00	1740	TAB4221RPT00P	1915

*Cushion not included

2 Select Finish

[Click to view finishes](#)

WAC	WLF(Lofty	Oak on Flat
WIC	Oak on Flat	Cut)
WHC	Cut)	
WOC	WNW	
WEC	WNF(Natural	
WAM	Oak on Flat	
WCM	Cut)	
WEW	WSF(Salted	
WGW	Oak on Flat	
WBW	Cut)	
WSW	WMF(Mocha	

3 Select Edge

[Click to view edges](#)

Edge
N/A

Edge
N/A

4 Select Hardware

[Click to view details](#)

Hardware
N/A

Hardware
N/A

Product Features

- 1- 1/4" Platform
- Polished Aluminum legs
- Platforms for a cushion feature a route to reduce unit weight

Notes

- If platform for cushion is desired, use with 19-1/2" bench cushion
- AirCharge not available on TAB4221RPT05
- Cushions (ordered separately) attach to platform with 4 bolts (Field Assembly Required). Cushions are reversible on platform.
- Center leg is a black recessed support
- Each flush cut option reduces the platform width 5/8"

Options

Flush Cut

- FC-B: Flush Unit Both Sides(Facing) for Ganging - \$100
- FC-L: Flush Unit Left (Facing) for Ganging - \$100
- FC-R: Flush Unit Right(Facing) for Ganging - \$100

Power

- AirCharge offers a convenient way to charge any Qi compatible smart-phone or device without the need to carry charging cables or find an available power outlet.
- ACWG: AirCharge Wireless Grommet - \$213
- Cove Power Pod (Linking/Non-Linking)
- PD-COVE: Non-Linking Rectangle Power Unit - \$600, For Table Top
- COV-DCH: Hardwire Infeed, 1 Linking Cove unit - \$774
- COV-DCP: Plug Infeed, 1 Linking Cove unit - \$872
- COV-DCL: Additional Units (includes 1 Linking Cove unit + 72" jumpers) - \$627

Tablo

Platform - Bench
21 3/4" Depth Three Seat Bench Platform



[Click here to view statement of line](#)

1 Select Model

w" x d" x h"

	Weight	Standard Veneer Top Standard Veneer Chassis	Premium Veneer Top Premium Veneer Chassis	High Pressure Laminate Top Veneer Chassis	Thermally Fused Laminate Top Thermally Fused Laminate Chassis
Platform Bench For Left Facing Cushion 62.75 x 21.75 x 8.5	70	TAB6221RPT02W 1740	TAB6221RPT02P 1915	"G" Option N/A	"M" Option N/A
Platform Bench For Platform for Center Cushion 62.75 x 21.75 x 8.5	70	TAB6221RPT04W 1740	TAB6221RPT04P 1915	"G" Option N/A	"M" Option N/A
Platform Bench For Right Facing Cushion 62.75 x 21.75 x 8.5	70	TAB6221RPT03 1740	TAB6221RPT03P 1915	"G" Option N/A	"M" Option N/A
Platform Bench For Left & Center Facing Cushion 62.75 x 21.75 x 8.5	60	TAB6221RPT06 1740	TAB6221RPT06P 1915	"G" Option N/A	"M" Option N/A
Platform Bench For Center & Right Facing Cushion 62.75 x 21.75 x 8.5	60	TAB6221RPT07 1740	TAB6221RPT07P 1915	"G" Option N/A	"M" Option N/A
Platform Bench For Left & Right Facing Cushion 62.75 x 21.75 x 8.5	60	TAB6221RPT05 1740	TAB6221RPT05P 1915	"G" Option N/A	"M" Option N/A
Platform Bench For Left, Center & Right Facing Cushion 62.75 x 21.75 x 8.5	50	TAB6221RPT08 1740	TAB6221RPT08P 1915	"G" Option N/A	"M" Option N/A
Platform Bench Used as Table Platform 62.75 x 21.75 x 8.5	80	TAB6221RPT00 1740	TAB6221RPT00P 1915	"G" Option N/A	"M" Option N/A

Product Features

- 1- 1/4" Platform
- Polished Aluminum legs
- Platforms for a cushion feature a route to reduce unit weight

Notes

- If platform for cushion is desired, use with 19-1/2" bench cushion
- AirCharge not available TAB6221RPT08
- Cushions (ordered separately) attach to platform with 4 bolts (Field Assembly Required). Cushions are reversible on platform.
- Center leg is a black recessed support
- Each flush cut option reduces the platform width 5/8"

Options

Flush Cut

- FC-B: Flush Unit Both Sides(Facing) for Ganging - \$100
- FC-L: Flush Unit Left (Facing) for Ganging - \$100
- FC-R: Flush Unit Right(Facing) for Ganging - \$100

Power

- AirCharge offers a convenient way to charge any Qi compatible smart-phone or device without the need to carry charging cables or find an available power outlet.
- ACWG: AirCharge Wireless Grommet - \$213
- Cove Power Pod (Linking/Non-Linking)
- PD-COVE: Non-Linking Rectangle Power Unit - \$600, For Table Top
- COV-DCH: Hardwire Infeed, 1 Linking Cove unit - \$774
- COV-DCP: Plug Infeed, 1 Linking Cove unit - \$872
- COV-DCL: Additional Units (includes 1 Linking Cove unit + 72" jumpers) - \$627

2 Select Finish

[Click to view finishes](#)

WAC	WLF(Lofty Oak on Flat
WIC	Oak on Flat Cut)
WHC	Cut)
WOC	WNW
WEC	WNF(Natural
WAM	Oak on Flat
WCM	Cut)
WEW	WSF(Salted
WGW	Oak on Flat
WBW	Cut)
WSW	WMF(Mocha

TBCO
TBSW
TSTV
TSMV
TSLV
TOBW
WLO
WMO
WNO
WSO

3 Select Edge

[Click to view edges](#)

Edge
N/A

Edge
N/A

4 Select Hardware

[Click to view details](#)

Hardware
N/A

Hardware
N/A

Tablo

Platform - Seating Units (Cushion)
33 3/4" Depth One Seat Platform

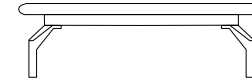

[Click here to view statement of line](#)

1 Select Model

w" x d" x h"

Platform Seating Unit For Cushion

33.75 x 33.75 x 8.5 50

TAB3333RPT01W 1279

Platform Seating Unit Used as Table

33.75 x 33.75 x 8.5 60

TAB3333RPT00W 1279

*Cushion not included

Weight

Standard Veneer Top Standard Veneer Chassis	Premium Veneer Top Premium Veneer Chassis	High Pressure Laminate Top Veneer Chassis	Thermally Fused Laminate Top Thermally Fused Laminate Chassis
--	--	--	--

TAB3333RPT01P 1408

"G" Option N/A

"M" Option N/A

TAB3333RPT00P 1408

"G" Option N/A

"M" Option N/A

2 Select Finish

[Click to view finishes](#)

WAC	WLF(Lofty Oak on Flat	TBCO
WIC	Oak on Flat Cut)	TBSW
WHC	Cut)	TSTV
WOC	WNW	TSMV
WEC	WNF(Natural	TSLV
WAM	Oak on Flat	TOBW
WCM	Cut)	WLO
WEW	WSF(Salted	WMO
WGW	Oak on Flat	WNO
WBW	Cut)	WSO
WSW	WMF(Mocha	

3 Select Edge

[Click to view edges](#)

Edge
N/A

Edge
N/A

4 Select Hardware

[Click to view details](#)

Hardware
N/A

Hardware
N/A

Product Features

- 1- 1/4" Platform
- Polished Aluminum legs
- Platforms for a cushion feature a route to reduce unit weight

Notes

- If platform for cushion is desired, use with 31-1/2" chair or 31-1/2" cushion
- AirCharge not available on Platform for Cushion
- Cushions (ordered separately) attach to platform with 4 bolts (Field Assembly Required). Cushions are reversible on platform.
- Each flush cut option reduces the platform width 5/8"

Options

Flush Cut

- FC-B: Flush Unit Both Sides(Facing) for Ganging - \$100
- FC-L: Flush Unit Left (Facing) for Ganging - \$100
- FC-R: Flush Unit Right(Facing) for Ganging - \$100

Power

- AirCharge offers a convenient way to charge any Qi compatible smart-phone or device without the need to carry charging cables or find an available power outlet.
- ACWG: AirCharge Wireless Grommet - \$213
- Cove Power Pod (Linking/Non-Linking)
- PD-COVE: Non-Linking Rectangle Power Unit - \$600, For Table Top
- COV-DCH: Hardwire Infeed, 1 Linking Cove unit - \$774
- COV-DCP: Plug Infeed, 1 Linking Cove unit - \$872
- COV-DCL: Additional Units (includes 1 Linking Cove unit + 72" jumpers) - \$627

Tablo

Platform - Seating Units (Cushion)
33 3/4" Depth Two Seat Platform

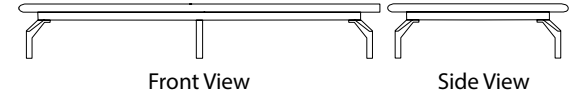

[Click here to view statement of line](#)

1 Select Model

w" x d" x h"

Weight	Standard Veneer Top Standard Veneer Chassis	Premium Veneer Top Premium Veneer Chassis	High Pressure Laminate Top Veneer Chassis	Thermally Fused Laminate Top Thermally Fused Laminate Chassis
66.25 x 33.75 x 8.5	95 TAB6633RPT02W	2281	TAB6633RPT02P	2510
66.25 x 33.75 x 8.5	95 TAB6633RPT03W	2281	TAB6633RPT03P	2510
66.25 x 33.75 x 8.5	85 TAB6633RPT05	2281	TAB6633RPT05P	2510
66.25 x 33.75 x 8.5	105 TAB6633RPT00	2281	TAB6633RPT00P	2510

*Cushion not included

2 Select Finish

[Click to view finishes](#)

WAC	WLF(Lofty Oak on Flat
WIC	Oak on Flat Cut)
WHC	Cut)
WOC	WNW
WEC	WNF(Natural
WAM	Oak on Flat
WCM	Cut)
WEW	WSF(Salted
WGW	Oak on Flat
WBW	Cut)
WSW	WMF(Mocha

3 Select Edge

[Click to view edges](#)

Edge
N/A

Edge
N/A

4 Select Hardware

[Click to view details](#)

Hardware
N/A

Hardware
N/A

Product Features

- 1- 1/4" Platform
- Polished Aluminum legs
- Platforms for a cushion feature a route to reduce unit weight

Notes

- If platform for cushion is desired, use with 31-1/2" chair or 31-1/2" cushion
- AirCharge not available on TAB6633RPT05
- Cushions (ordered separately) attach to platform with 4 bolts (Field Assembly Required). Cushions are reversible on platform.
- Center leg is a black recessed support
- Each flush cut option reduces the platform width 5/8"

Options

Flush Cut

- FC-B: Flush Unit Both Sides(Facing) for Ganging - \$100
- FC-L: Flush Unit Left (Facing) for Ganging - \$100
- FC-R: Flush Unit Right(Facing) for Ganging - \$100

Power

- AirCharge offers a convenient way to charge any Qi compatible smart-phone or device without the need to carry charging cables or find an available power outlet.
- ACWG: AirCharge Wireless Grommet - \$213
- Cove Power Pod (Linking/Non-Linking)
- PD-COVE: Non-Linking Rectangle Power Unit - \$600, For Table Top
- COV-DCH: Hardwire Infeed, 1 Linking Cove unit - \$774
- COV-DCP: Plug Infeed, 1 Linking Cove unit - \$872
- COV-DCL: Additional Units (includes 1 Linking Cove unit + 72" jumpers) - \$627

Tablo

Platform - Inside Radius Seating Unit (Cushion)
15 Degree Inside Radius Platform

[Click here to view statement of line](#)

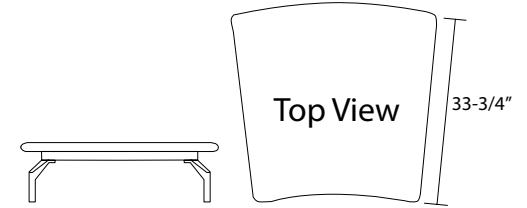

1 Select Model

w" x d" x h"

Platform Seating Unit For Cushion

42.5 x 35.5 x 8.5 60

TAB4236ISP01W 1447

TAB4236ISP01P 1592

"G" Option N/A

"M" Option N/A

Platform Seating Unit Used as Table

42.5 x 35.5 x 8.5 70

TAB4236ISP00W 1447

TAB4236ISP00P 1592

"G" Option N/A

"M" Option N/A

*Cushion not included

Weight

Standard Veneer Top Standard Veneer Chassis	Premium Veneer Top Premium Veneer Chassis	High Pressure Laminate Top Veneer Chassis	Thermally Fused Laminate Top Thermally Fused Laminate Chassis
--	--	--	--

2 Select Finish

[Click to view finishes](#)

WAC	WLF(Lofty Oak on Flat	TBCO
WIC	Oak on Flat Cut)	TBSW
WHC	Cut)	TSTV
WOC	WNW	TSMV
WEC	WNF(Natural	TSLV
WAM	Oak on Flat	TOBW
WCM	Cut)	WLO
WEW	WSF(Salted	WMO
WGW	Oak on Flat	WNO
WBW	Cut)	WSO
WSW	WMF(Mocha	

3 Select Edge

[Click to view edges](#)

Edge
N/A

Edge
N/A

4 Select Hardware

[Click to view details](#)

Hardware
N/A

Hardware
N/A

Product Features

- 1- 1/4" Platform
- Polished Aluminum legs
- Platforms for a cushion feature a route to reduce unit weight

Notes

- If platform for cushion is desired, use with 31-1/2" chair or 31-1/2" cushion
- AirCharge not available on Platform for Cushion
- Cushions (ordered separately) attach to platform with 4 bolts (Field Assembly Required). Cushions are reversible on platform.
- Each flush cut option reduces the platform width 5/8"

Options

Flush Cut

- FC-B: Flush Unit Both Sides(Facing) for Ganging - \$100
- FC-L: Flush Unit Left (Facing) for Ganging - \$100
- FC-R: Flush Unit Right(Facing) for Ganging - \$100

Power

- AirCharge offers a convenient way to charge any Qi compatible smart-phone or device without the need to carry charging cables or find an available power outlet.
- ACWG: AirCharge Wireless Grommet - \$213
 - Cove Power Pod (Linking/Non-Linking)
 - PD-COVE: Non-Linking Rectangle Power Unit - \$600, For Table Top
 - COV-DCH: Hardwire Infeed, 1 Linking Cove unit - \$774
 - COV-DCP: Plug Infeed, 1 Linking Cove unit - \$872
 - COV-DCL: Additional Units (includes 1 Linking Cove unit + 72" jumpers) - \$627

Tablo

Platform - Inside Radius Seating Unit (Cushion)
30 Degree Inside Radius Platform

[Click here to view statement of line](#)

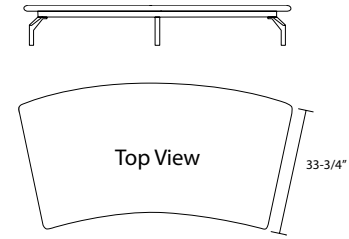

1 Select Model

w" x d" x h"

Platform Seating Unit For Left Facing Cushion	Weight	Standard Veneer Top Standard Veneer Chassis	Premium Veneer Top Premium Veneer Chassis	High Pressure Laminate Top Veneer Chassis	Thermally Fused Laminate Top Thermally Fused Laminate Chassis
94.5 x 39 x 8.5	105	TAB9539ISP02W	2648	TAB9539ISP02P	2913
Platform Seating Unit For Right Facing Cushion					
94.5 x 39 x 8.5	105	TAB9539ISP03W	2648	TAB9539ISP03P	2913
Platform Seating Unit For Left & Right Facing Cushion					
94.5 x 39 x 8.5	95	TAB9539ISP05	2648	TAB9539ISP05P	2913
Platform Seating Unit Used as Table Platform					
94.5 x 39 x 8.5	115	TAB9539ISP00	2648	TAB9539ISP00P	2913

*Cushion not included

2 Select Finish

[Click to view finishes](#)

WAC	WLF(Lofty	Oak on Flat
WIC	Oak on Flat	Cut)
WHC	Cut)	
WOC	WNW	
WEC	WNF(Natural	
WAM	Oak on Flat	
WCM	Cut)	
WEW	WSF(Salted	
WGW	Oak on Flat	
WBW	Cut)	
WSW	WMF(Mocha	

3 Select Edge

[Click to view edges](#)

Edge
N/A

Edge
N/A

4 Select Hardware

[Click to view details](#)

Hardware
N/A

Hardware
N/A

Product Features

- 1- 1/4" Platform
- Polished Aluminum legs
- Platforms for a cushion feature a route to reduce unit weight

Notes

- If platform for cushion is desired, use with 31-1/2" chair or 31-1/2" cushion
- AirCharge not available on TAB9539ISP05
- Cushions (ordered separately) attach to platform with 4 bolts (Field Assembly Required). Cushions on 30 degree radius platform are NOT reversible.
- Center leg is a black recessed support
- Each flush cut option reduces the platform width 5/8"

Options

Flush Cut

- FC-B: Flush Unit Both Sides(Facing) for Ganging - \$100
- FC-L: Flush Unit Left (Facing) for Ganging - \$100
- FC-R: Flush Unit Right(Facing) for Ganging - \$100

Power

- AirCharge offers a convenient way to charge any Qi compatible smart-phone or device without the need to carry charging cables or find an available power outlet.
- ACWG: AirCharge Wireless Grommet - \$213
 - Cove Power Pod (Linking/Non-Linking)
 - PD-COVE: Non-Linking Rectangle Power Unit - \$600, For Table Top
 - COV-DCH: Hardwire Infeed, 1 Linking Cove unit - \$774
 - COV-DCP: Plug Infeed, 1 Linking Cove unit - \$872
 - COV-DCL: Additional Units (includes 1 Linking Cove unit + 72" jumpers) - \$627

Tablo

Platform - Outside Radius Seating Unit (Cushion)
15 Degree Outside Radius Platform

[Click here to view statement of line](#)

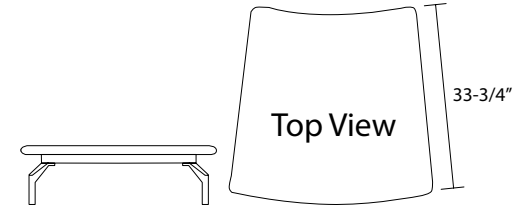

1 Select Model

w" x d" x h"
Platform Seating Unit For Cushion
42.5 x 35.5 x 8.5 60
Platform Seating Unit Used as Table
42.5 x 35.5 x 8.5 70
*Cushion not included

Weight

Standard Veneer Top Standard Veneer Chassis	Premium Veneer Top Premium Veneer Chassis	High Pressure Laminate Top Veneer Chassis	Thermally Fused Laminate Top Thermally Fused Laminate Chassis
TAB4236OSP01W 1447	TAB4236OSP01P 1592	"G" Option N/A	"M" Option N/A
TAB4236OSP00W 1447	TAB4236OSP00P 1592	"G" Option N/A	"M" Option N/A

2 Select Finish

Click to view finishes

WAC	WLF(Lofty Oak on Flat	TBCO
WIC	Oak on Flat Cut)	TBSW
WHC	Cut)	TSTV
WOC	WNW	TSMV
WEC	WNF(Natural	TSLV
WAM	Oak on Flat	TOBW
WCM	Cut)	WLO
WEW	WSF(Salted	WMO
WGW	Oak on Flat	WNO
WBW	Cut)	WSO
WSW	WMF(Mocha	

3 Select Edge

Click to view edges

Edge
N/A

Edge
N/A

4 Select Hardware

Click to view details

Hardware
N/A

Hardware
N/A

Product Features

- 1- 1/4" Platform
- Polished Aluminum legs
- Platforms for a cushion feature a route to reduce unit weight

Notes

- If platform for cushion is desired, use with 31-1/2" chair or 31-1/2" cushion
- AirCharge not available on Platform for Cushion
- Cushions (ordered separately) attach to platform with 4 bolts (Field Assembly Required). Cushions are reversible on platform.
- Each flush cut option reduces the platform width 5/8"

Options

Flush Cut

- FC-B: Flush Unit Both Sides(Facing) for Ganging - \$100
- FC-L: Flush Unit Left (Facing) for Ganging - \$100
- FC-R: Flush Unit Right(Facing) for Ganging - \$100

Power

- AirCharge offers a convenient way to charge any Qi compatible smart-phone or device without the need to carry charging cables or find an available power outlet.
- ACWG: AirCharge Wireless Grommet - \$213
- Cove Power Pod (Linking/Non-Linking)
- PD-COVE: Non-Linking Rectangle Power Unit - \$600, For Table Top
- COV-DCH: Hardwire Infeed, 1 Linking Cove unit - \$774
- COV-DCP: Plug Infeed, 1 Linking Cove unit - \$872
- COV-DCL: Additional Units (includes 1 Linking Cove unit + 72" jumpers) - \$627

Tablo

Platform - Outside Radius Seating Unit (Cushion) 30 Degree Outside Radius Platform

[Click here to view statement of line](#)

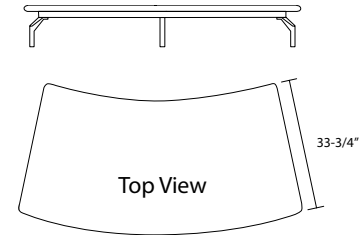

1 Select Model

w" x d" x h"

	Standard Veneer Top Standard Veneer Chassis	Premium Veneer Top Premium Veneer Chassis	High Pressure Laminate Top Veneer Chassis	Thermally Fused Laminate Top Thermally Fused Laminate Chassis
Platform Seating Unit For Left Facing Cushion 94.5 x 39 x 8.5	105 TAB9539OSP02W 2648	TAB9539OSP02P 2913	"G" Option N/A	"M" Option N/A
Platform Seating Unit For Right Facing Cushion 94.5 x 39 x 8.5	105 TAB9539OSP03W 2648	TAB9539OSP03P 2913	"G" Option N/A	"M" Option N/A
Platform Seating Unit For Left & Right Facing Cushion 94.5 x 39 x 8.5	95 TAB9539OSP05 2648	TAB9539OSP05P 2913	"G" Option N/A	"M" Option N/A
Platform Seating Unit Used as Table Platform 94.5 x 39 x 8.5	115 TAB9539OSP00 2648	TAB9539OSP00P 2913	"G" Option N/A	"M" Option N/A

*Cushion not included

2 Select Finish

[Click to view finishes](#)

WAC	WLF(Lofty Oak on Flat	TBCO
WIC	Oak on Flat Cut)	TBSW
WHC	Cut)	TSTV
WOC	WNW	TSMV
WEC	WNF(Natural	TSLV
WAM	Oak on Flat	TOBW
WCM	Cut)	WLO
WEW	WSF(Salted	WMO
WGW	Oak on Flat	WNO
WBW	Cut)	WSO
WSW	WMF(Mocha	

3 Select Edge

[Click to view edges](#)

Edge
N/A

Edge
N/A

4 Select Hardware

[Click to view details](#)

Hardware
N/A

Hardware
N/A

Product Features

- 1- 1/4" Platform
- Polished Aluminum legs
- Platforms for a cushion feature a route to reduce unit weight

Notes

- If platform for cushion is desired, use with 31-1/2" chair or 31-1/2" cushion
- AirCharge not available on TAB9539OSP05
- Cushions (ordered separately) attach to platform with 4 bolts (Field Assembly Required). Cushions on 30 Degree radius platform are NOT reversible.
- Center leg is a black recessed support
- Each flush cut option reduces the platform width 5/8"

Options

Flush Cut

- FC-B: Flush Unit Both Sides(Facing) for Ganging - \$100
- FC-L: Flush Unit Left (Facing) for Ganging - \$100
- FC-R: Flush Unit Right(Facing) for Ganging - \$100

Power

- AirCharge offers a convenient way to charge any Qi compatible smart-phone or device without the need to carry charging cables or find an available power outlet.
- ACWG: AirCharge Wireless Grommet - \$213
 - Cove Power Pod (Linking/Non-Linking)
 - PD-COVE: Non-Linking Rectangle Power Unit - \$600, For Table Top
 - COV-DCH: Hardwire Infeed, 1 Linking Cove unit - \$774
 - COV-DCP: Plug Infeed, 1 Linking Cove unit - \$872
 - COV-DCL: Additional Units (includes 1 Linking Cove unit + 72" jumpers) - \$627

Tablo

Seating Unit - Bench
 19 1/2" One Seat Bench Cushion

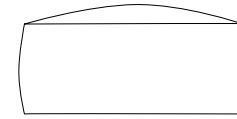

[Click here to view statement of line](#)

1 Model
TAB1919OSB01

w" x d" x h"
 19.5 x 19.5 x 9.25
 Arm Height N/A
 Seat Height 17-3/4"
 Inside Seat Depth 19-1/2"
 Inside Seat Width 19-1/2"

COM	COL	1	2	3	4	5	6	7	8	9	10	11/L1	12	13/L2
1004	1043	1060	1088	1116	1144	1172	1200	1228	1256	1284	1312	1340	1368	1424

Upholstery Requirements
 Fabric yds: 1.5 | Leather Sq. Ft.: 23
 Carton Weight: 20

[Click to view finishes](#)

[Click to view finishes](#)

Product Features

- Frame constructed of CNC cut Plywood components featuring interlocking tab joinery for superior strength and long term durability.
- Joints are securely fastened with corner block construction.
- Seats and back are webbed to enhance comfort, sustainability and endurance.
- 4" Top cushion

Notes

- Use with 21-3/4" bench platform
- Seating Units should be ordered in addition to a platform. Multiple platforms can be ganged with a flush cut option to create various arrangements.
- Cushion is reversible on all platforms except 30 Degree Radius
- Must specify with platform

Tablo

Seating Unit - Bench
31-1/2" One Seat Bench Cushion



[Click here to view statement of line](#)

1 Model
TAB3131OSB01

w" x d" x h"
31.5 x 31.5 x 9.25
Arm Height N/A
Seat Height 17-3/4"
Inside Seat Depth 32.5"
Inside Seat Width 32-1/2"

COM	COL	1	2	3	4	5	6	7	8	9	10	11/L1	12	13/L2
1147	1186	1221	1258	1295	1332	1369	1406	1443	1480	1517	1554	1591	1628	1702

Upholstery Requirements
Fabric yds: 2 Leather Sq. Ft.: 36
Carton Weight: 30

[Click to view finishes](#)

[Click to view finishes](#)

Product Features

- Frame constructed of CNC cut Plywood components featuring interlocking tab joinery for superior strength and long term durability.
- Joints are securely fastened with corner block construction.
- Seats and back are webbed to enhance comfort, sustainability and endurance.
- 4" Top cushion

Notes

- Seating Units should be ordered in addition to a platform. Multiple platforms can be ganged with a flush cut option to create various arrangements.
- For 33-3/4" deep & radius platforms
- Cushion is reversible on all platforms except 30 Degree Radius
- Must specify with platform

Tablo

Seating Unit - Cushion
Armless Chair Cushion

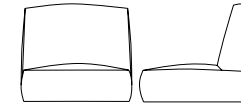

[Click here to view statement of line](#)

1 Model TAB3131NAC01

w" x d" x h"
31.5 x 31.5 x 24.25
Arm Height N/A
Seat Height 17-3/4"
Inside Seat Depth 21"
Inside Seat Width 31-1/2"

COM	COL	1	2	3	4	5	6	7	8	9	10	11/L1	12	13/L2
2247	2327	2377	2441	2505	2569	2633	2697	2761	2825	2889	2953	3017	3081	3209

Upholstery Requirements
Fabric yds: 3.5 Leather Sq. Ft.: 63
Carton Weight: 40

2 Select Finish

[Click to view finishes](#)

Finishes N/A

3 Combination Fabrics

[Click to view finishes](#)

DARRAN is pleased to offer customers the design freedom of combination fabrics. When using fabric, vinyl or leather combinations, pricing/yardage requirements will be as follows:

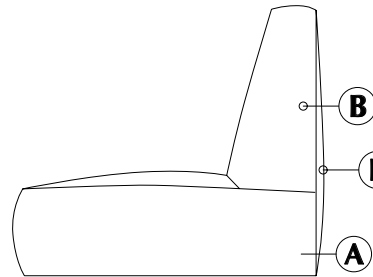

A Seat 1.75 yds
B Back 2.5 yds

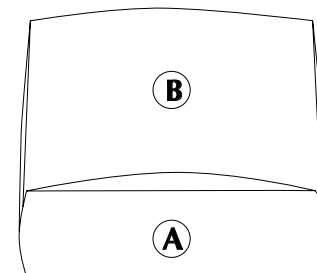

- When combining two materials of the same grade, pricing will be specified grade + 5%
- If combining two materials of different grades or leather/fabric combination, use the highest grade/price + 5%
- If using COM or COL, pricing will be COM or COL + 5%.
- If both COM + COL are used in combination, use COL + 5%

Product Features

- Frame constructed of CNC cut Plywood components featuring interlocking tab joinery for superior strength and long term durability.
- Joints are securely fastened with corner block construction.
- Seats and back are webbed to enhance comfort, sustainability and endurance.
- 4" Top cushion

Notes

- Seating Units should be ordered in addition to a platform. Multiple platforms can be ganged with a flush cut option to create various arrangements.
- For 33-3/4" deep & radius platforms
- Cushion is reversible on all platforms except 30 Degree Radius
- Must specify with platform

Tablo

Seating Unit - Cushion
Left Arm (Facing) Chair Cushion

[Click here to view statement of line](#)

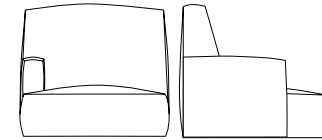

1 Model TAB3131LAC01

w" x d" x h"
31.5 x 31.5 x 24.25
Arm Height 22"
Seat Height 17-3/4"
Inside Seat Depth 21"
Inside Seat Width 26-3/4"

COM	COL	1	2	3	4	5	6	7	8	9	10	11/L1	12	13/L2
2327	2418	2475	2548	2621	2694	2767	2840	2913	2986	3059	3132	3205	3278	3424

Upholstery Requirements
Fabric yds: 4 Leather Sq. Ft.: 72
Carton Weight: 45

2 Select Finish

[Click to view finishes](#)

Finishes N/A

3 Combination Fabrics

[Click to view finishes](#)

DARRAN is pleased to offer customers the design freedom of combination fabrics. When using fabric, vinyl or leather combinations, pricing/yardage requirements will be as follows:

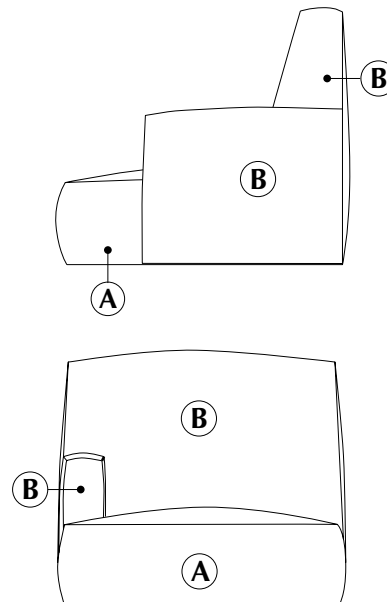

A Seat 1.75 yds
B Back and Arm 2.5 yds

- When combining two materials of the same grade, pricing will be specified grade + 5%
- If combining two materials of different grades or leather/fabric combination, use the highest grade/price + 5%
- If using COM or COL, pricing will be COM or COL + 5%.
- If both COM + COL are used in combination, use COL + 5%.

Product Features

- Frame constructed of CNC cut Plywood components featuring interlocking tab joinery for superior strength and long term durability.
- Joints are securely fastened with corner block construction.
- Seats and back are webbed to enhance comfort, sustainability and endurance.
- 4" Top cushion

Notes

- Seating Units should be ordered in addition to a platform. Multiple platforms can be ganged with a flush cut option to create various arrangements.
- For 33-3/4" deep & radius platforms
- Cushion is reversible on all platforms except 30 Degree Radius
- Must specify with platform

Tablo

Seating Unit - Cushion
Right Arm (Facing) Chair Cushion

[Click here to view statement of line](#)

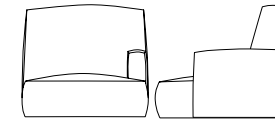

1 Model TAB3131RAC01

w" x d" x h"
31.5 x 31.5 x 24.25
Arm Height 22"
Seat Height 17-3/4"
Inside Seat Depth 21"
Inside Seat Width 26-3/4"

COM	COL	1	2	3	4	5	6	7	8	9	10	11/L1	12	13/L2
2327	2418	2475	2548	2621	2694	2767	2840	2913	2986	3059	3132	3205	3278	3424

Upholstery Requirements
Fabric yds: 4 Leather Sq. Ft.: 72
Carton Weight: 45

2 Select Finish

[Click to view finishes](#)

Finishes N/A

3 Combination Fabrics

[Click to view finishes](#)

DARRAN is pleased to offer customers the design freedom of combination fabrics. When using fabric, vinyl or leather combinations, pricing/yardage requirements will be as follows:

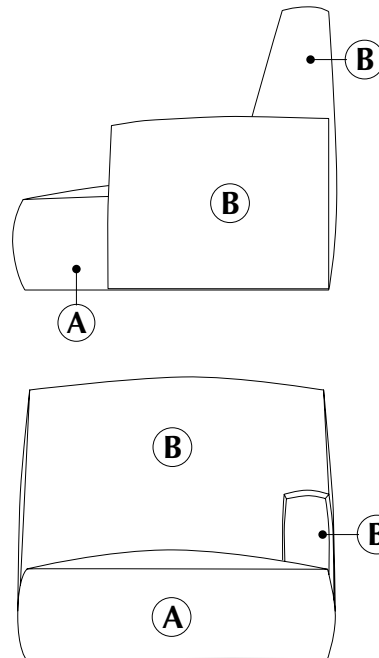

A Seat 1.75 yds
B Back and Arm 2.5 yds

- When combining two materials of the same grade, pricing will be specified grade + 5%
- If combining two materials of different grades or leather/fabric combination, use the highest grade/price + 5%
- If using COM or COL, pricing will be COM or COL + 5%.
- If both COM + COL are used in combination, use COL + 5%.

Product Features

- Frame constructed of CNC cut Plywood components featuring interlocking tab joinery for superior strength and long term durability.
- Joints are securely fastened with corner block construction.
- Seats and back are webbed to enhance comfort, sustainability and endurance.
- 4" Top cushion

Notes

- Seating Units should be ordered in addition to a platform. Multiple platforms can be ganged with a flush cut option to create various arrangements.
- For 33-3/4" deep & radius platforms
- Cushion is reversible on all platforms except 30 Degree Radius
- Must specify with platform

Tablo

Seating Unit - Cushion
Lounge Chair Cushion

[Click here to view statement of line](#)

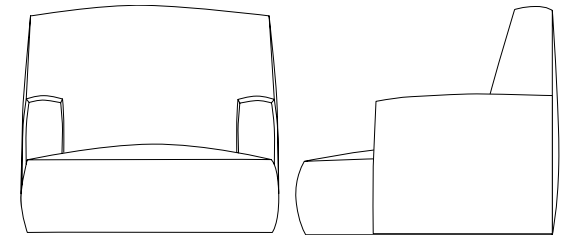

1 Model TAB3131DAC01

w" x d" x h"
31.5 x 31.5 x 24.25
Arm Height 22"
Seat Height 17-3/4"
Inside Seat Depth 21"
Inside Seat Width 20-3/4"

COM	COL	1	2	3	4	5	6	7	8	9	10	11/L1	12	13/L2
2617	2617	2912	3058	3204	3350	3496	3642	3788	3934	4080	4226	4372	4518	4810

Upholstery Requirements
Fabric yds: 6 Leather Sq. Ft.: 81
Carton Weight: 50

2 Select Finish

[Click to view finishes](#)

Finishes N/A

3 Combination Fabrics

[Click to view finishes](#)

DARRAN is pleased to offer customers the design freedom of combination fabrics. When using fabric, vinyl or leather combinations, pricing/yardage requirements will be as follows:

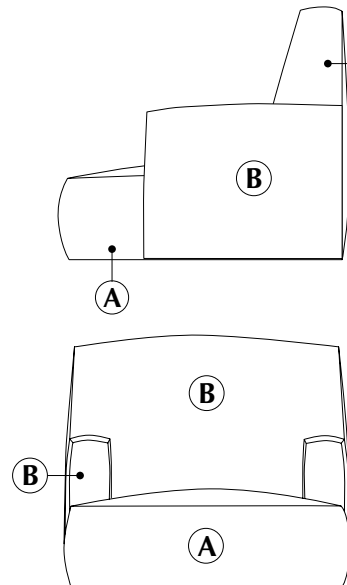

A Seat 1.75 yds
B Back and Arms 3.75 yds

- When combining two materials of the same grade, pricing will be specified grade + 5%
- If combining two materials of different grades or leather/fabric combination, use the highest grade/price + 5%
- If using COM or COL, pricing will be COM or COL + 5%.
- If both COM + COL are used in combination, use COL + 5%.

Product Features

- Frame constructed of CNC cut Plywood components featuring interlocking tab joinery for superior strength and long term durability.
- Joints are securely fastened with corner block construction.
- Seats and back are webbed to enhance comfort, sustainability and endurance.
- 4" Top cushion

Notes

- Seating Units should be ordered in addition to a platform. Multiple platforms can be ganged with a flush cut option to create various arrangements.
- For 33-3/4" deep & radius platforms
- Cushion is reversible on all platforms except 30 Degree Radius
- Must specify with platform

Tablo

Platform - Ottoman
20" Depth Ottoman Platform

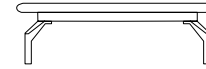

[Click here to view statement of line](#)

1 Select Model

w" x d" x h"
33.75 x 20 x 8.5

Weight
30

Standard Veneer Top Standard Veneer Chassis	Premium Veneer Top Premium Veneer Chassis	High Pressure Laminate Top Veneer Chassis	Thermally Fused Laminate Top Thermally Fused Laminate Chassis
TAB3320RPT01W 1233	TAB3320RPT01P 1358	"G" Option N/A	"M" Option N/A

Product Features

- 1- 1/4" Platform
- Polished Aluminum legs

Notes

- Cushions (ordered separately) attach to platform with 4 bolts (Field Assembly Required). Cushions are reversible on platforms.
- Ottoman features a route to reduce unit weight

2 Select Finish

[Click to view finishes](#)

- WAC
- WIC
- WHC
- WOC
- WEC
- WAM
- WCM
- WEW
- WGW
- WBW
- WSW

WNW

- TBCO
- TBSW
- TSTV
- TSMV
- TSLV
- TOBW
- WLO
- WMO
- WNO
- WSO

3 Select Edge

[Click to view edges](#)

Edge
N/A

Edge
N/A

4 Select Hardware

[Click to view details](#)

Hardware
N/A

Hardware
N/A

Tablo

Seating Unit - Ottoman
18" Ottoman Cushion

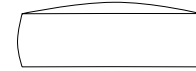

[Click here to view statement of line](#)

1 Model TAB3118OSB01

w" x d" x h"
31.5 x 18 x 9.25
Arm Height N/A
Seat Height 17-3/4"
Inside Seat Depth N/A
Inside Seat Width N/A

COM	COL	1	2	3	4	5	6	7	8	9	10	11/L1	12	13/L2
1004	1043	1060	1088	1116	1144	1172	1200	1228	1256	1284	1312	1340	1368	1424

Upholstery Requirements
Fabric yds: 1.5 Leather Sq. Ft.: 23
Carton Weight: 25

2 Select Finish

[Click to view finishes](#)

Finishes N/A

3 Combination Fabrics

[Click to view finishes](#)

Combination
Fabric Option
Not Available

Product Features

- Frame constructed of CNC cut Plywood components featuring interlocking tab joinery for superior strength and long term durability.
- Joints are securely fastened with corner block construction.
- 4" Top cushion

Notes

- Use on Ottoman platforms only
- Ottoman cushion should be ordered in addition to Ottoman Platform. Multiple platforms can be ganged with a flush cut option to create various arrangements.
- Must specify with platform