



Covet Price List

Effective April 1, 2024

Designed By Michael Shields

Date	Page	Modification	Description
04.04.24		Updated Pricing	

Fabric seat & leather program.....1
Seating Specification4
Finishes5
Executive Chair6

Statement of Line

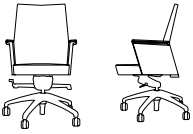

Page 6
Upholstered Arms
Mid-Back

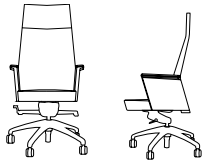

Page 7
Upholstered Arms
High-Back

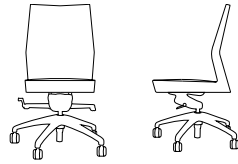

Page 8
Armless
Mid-Back

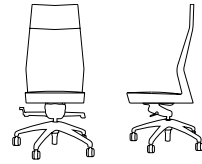

Page 9
Armless
High-Back

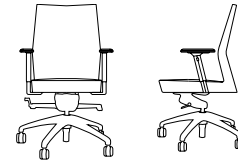

Page 10
Adjustable Ergonomic Arms
Mid-Back

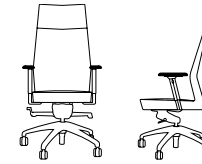

Page 11
Adjustable Ergonomic Arms
High-Back

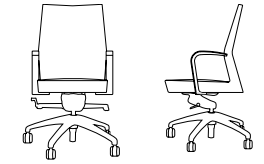

Page 12
Metal "C" Arms
Mid-Back

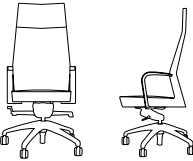

Page 13
Metal "C" Arms
High-Back

Seating & fabric leather program

DARRAN has partnered with some of the most prestigious fabric suppliers of the office furniture industry to bring you quality fabrics that are engaging designs, environmentally friendly and durable for years to come. The majority of fabrics we have graded-in are in heavy supply making it most likely available on our Quickship however, we cannot guarantee stock. If you do not see the fabric you wish to include in a project, please contact Customer Service to see if this pattern can be graded in at 800.334.7891.

Fabrics & Leathers

Please visit our Seating Fabrics page at darran.com/textilesleather

Camira
www.camirafabrics.com
 800.334.789

Wollsdorf
www.wollsdorf.com
 336.884.5005

CFStinson
www.cfstinson.com
 800.841.6279

Green Hides
www.greenhides.com
 336.315.9720

DesignTex
www.designtex.com
 800.797.4949

Kvadrat
www.kvadrat.fabrics.com
 +45 8953 1866

Maharam
www.maharam.com
 800.645.3943

Momentum Textiles
www.momentumtextiles.com
 800.366.6839

Ultrafabrics
www.ultrafabricsinc.com
 800.334.7891

Application instructions must be specified on the purchase order or COM / COL submission form. In the absence of application instructions, DARRAN will apply materials accordingly.

CAL117

All DARRAN seating products conform to California Technical Bulletin 117 as a minimum standard.

CAL133

To meet the California Technical Bulletin 133 flammability regulation, a combination of proper materials must be used to pass, as it tests the fire resistance of a finished product. Flame resistant fabric, a fire blocker material and special foam must be used to pass CAL133 fire codes.

Testing is available for all seating products with the following fees and considerations:

- If laboratory certification is not required, any style can be manufactured to comply with California Technical Bulletin 133 for \$75 list per yard required. (Customer's Own Materials must factor in additional yardage requirements based on repeat.)
- The purchase order must clearly indicate the requirement of California Technical Bulletin 133
- If laboratory California Technical Bulletin 133 certification is required, the cost of testing a chair is \$820 NET, plus the cost of the chair and covering material.
- An additional lead time of 4 to 6 weeks is required for testing for CAL133.
- Once testing is completed, we will provide a certification letter specific to the sample tested for CAL133.
- DARRAN's manufacturing procedures for California TB 133 compliance are based on the testing of representative style with specific fabrics. Please contact Customer Service for an updated list of tested models.
- A copy of test certification is available upon request.W

Combination fabrics

DARRAN is pleased to offer customers the design freedom of combination fabrics. When using fabric, vinyl or leather combinations, pricing will be as follows:

- When combining two materials of the same grade, pricing will be specified grade + 5%.
- If combining two materials of different grades or leather/ fabric combination, use the highest grade/price + 5%.
- If using COM or COL, pricing will be COM or COL + 5%. If both COM + COL are used in combination, use COL + 5%

COM/COL ordering instructions

Please complete the COM Submission Form prior to ordering the fabric from the supplier. All COM fabrics must be approved prior to order submission. Please refer to our website or contact DARRAN Seating Customer Service for an updated list of preapproved COM fabrics. Application instructions must be specified on the purchase order or COM/COL approval form. In the absence of application instructions, DARRAN will apply materials in the best manner and cannot be held responsible for tailoring or application objections after upholstery. COM orders will be scheduled for production after receipt of the material. Packages must be clearly marked and the fabric must be first quality, continuous yardage.

COM/COL yardage requirements

The yardage requirements stated in this price list for each style are calculated using 54" wide, non-directional fabrics. For fabrics with a different width or for patterns with repeats, please refer to the below chart to calculate the additional percent of fabric required:

Fabric Width	Plain Fabric	2" - 14" Repeat	15" - 19" Repeat	20" - 27" Repeat	28" - 36" Repeat
54"	0	15%	20%	25%	30%
53"	6%	19%	24%	28%	36%
52"	13%	23%	28%	33%	38%
51"	19%	26%	31%	36%	41%
50"	25%	30%	35%	40%	45%
49"	30%	35%	40%	45%	50%
48"	35%	40%	45%	50%	55%
47"	45%	50%	55%	58%	65%

DARRAN®

Covet Seating Fabric & Leather Program

NOTE: Prior To Completion Of This Form, Please Refer To Our Graded In Materials Program For Preapproved Fabrics/Leathers.

COM/COL Approval

DARRAN Furniture Industries
2402 Shore Street, High Point, NC 27263
ATTN: Seating Division / COM/COL Approval
TAG: DARRAN Quote Number

Shipping approved COM/COL materials

DARRAN Furniture Industries
2402 Shore Street, High Point, NC 27263
ATTN: Seating Division / COM/COL Approval
TAG: DARRAN Quote Number

Please complete this form, attach a 6"x 6" sample and mail to the COM/COL APPROVAL address shown above.
This form can also be downloaded from our website at www.darran.com/leathers OR www.darran.com/fabrics

Quote# _____

Dealer's Name _____

Contact _____

Address _____

Telephone _____

Email _____

Chair Style _____

Manufacturer _____

Pattern Name _____

Pattern Color _____

Content _____

Repeat _____

Please specify any special requirements and check the application above.

ATTACH 6" X 6" FABRIC/LEATHER SAMPLE HERE

NOTE
Actual Fabric/Leather samples needed instead of digital images. If digital images are sent in lieu of samples, DARRAN will only verify the pattern and will not take responsibility for color variances that cannot be verified due to printing limitations.

In the absence of application instructions, DARRAN will apply the material in the best manner and cannot be held responsible for tailoring or application objections after upholstering.

Unless otherwise instructed on the purchase order, excess COM materials will be recycled at the discretion of DARRAN after six months of the original product ship date.

The COM approval solely pertains to the application of the fabric onto the specified DARRAN seating product. DARRAN's approval or acceptance does not constitute any responsibility or warranty to the overall appearance, durability, flammability, defects, dye lot variations or colorfastness of the COM. It is the customer's responsibility to ensure the COM meets CAL 117 compliance and are first quality continuous goods.

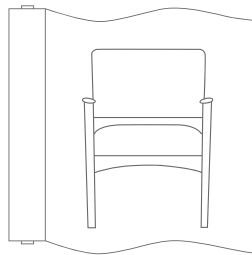

RAILROAD

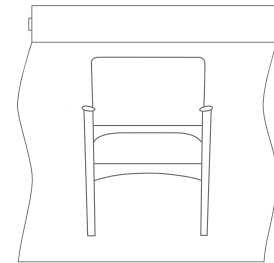

SETUP

DARRAN®

Width = 25-3/4"
 Depth = 23-1/2"
 Height = 47-1/2" - 50-1/2"
 Seat Width = 20-1/2"
 Seat Depth = 19"
 Seat Height = 19" - 22"
 Arm Height = 26" - 29"

Frame Construction: Hardwood
 Plywood components are precision cut on CNC routers and feature interlocking tab joinery for superior strength and long term durability. All joints are assembled utilizing glue and steel fasteners.

Cushioning: Back utilizes an elastic sheet webbing suspension that conforms to individual's lumbar curvatures for adaptive support. Cushioning materials are laminations or CAL117 rated high-density polyurethane foams of varying compression rates, providing durability and long terms comfort.

Upholstered Arms: Upholstered panel arms features caps which can be specified in constraasting fabrics, vinyls or leathers. Optional wood arm caps are also available in any DARRAN finish. Welting between cap and arm can also be specified in contrasting upholstery materials.

Covet Seating Specification

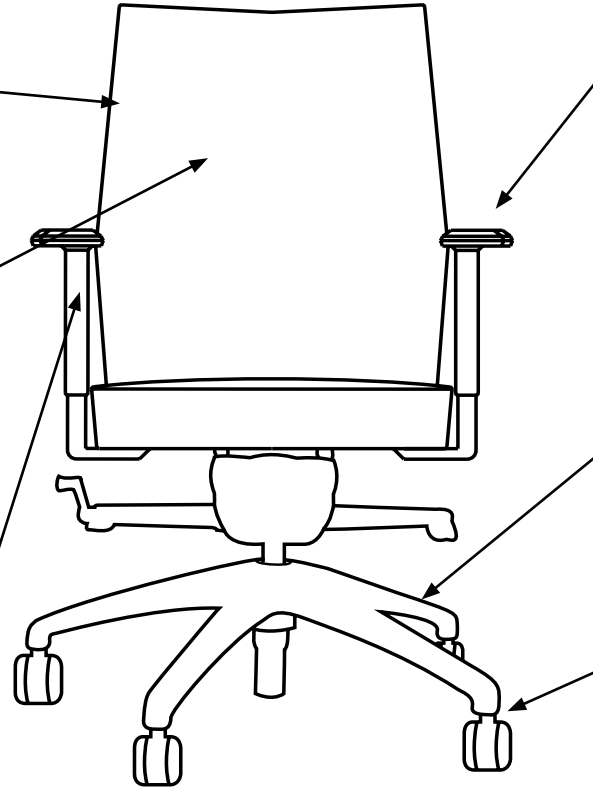

Adjustable Ergonomic Arms:
 Available in either T-Polished Aluminum or T-Nylon Black this multi-functional telescoping arm features height, depth, and pivot adjustability. Activated by a button trigger, it provides 4" of vertical adjustment to help relieve upper back and shoulder fatigue. 3" of front to back friction - activated depth adjustment allows users to get closer to their work surface while maintaining effective use of the backrest. The 30 degree inward / outward pivot provides proper forearm support for various tasks such as keying and mousing.

Bases: 26" diameter, available in Polished Aluminum (Standard), Black or Wood.

Casters: 60mm diameter wheels are standard and promote increased mobility.

Carpet casters are standard. For hard floor surfaces specify CST20 - no upcharge.



Adjustable Arms
 Mid or High-Back



Metal "C" Arms
 Mid or High-Back

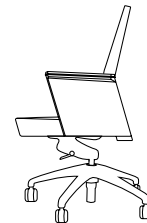

Upholstered Arms
 Mid or High-Back



Armless
 Mid or High-Back

Covet's slim, chiseled, profile compliments DARRAN's contemporary and transitional casegoods and conference room offerings. Finely tailored upholstery featuring elegant top stitch detailing provides a quality image while accommodating "real world" budgets. A family of models is offered, appropriate for Executive private offices, conference rooms, or open plan environments. A high level of detail provides 360° visual interest, especially important in conference room applications. Variety of textiles and back options offer customers flexibility in design and consistency within each office setting.

Knee-tilt swivel mechanism

The standard Knee-tilt mechanism features an advanced forward pivot point that reduces leg lift with a 16 degree seat angle and a 25 degree back angle tilt. The mechanism locks in task and reclined positions with side tensions adjustment. Heigh adjustment and tilt tension are also provided.

Finishes for arms or wood base only

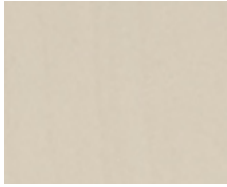
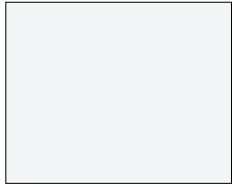

GWL Designer White

WAM Alabaster Maple

SSM Seattle Mist

WCM Clear Maple

TBCO Baby's Cheek

WSO Salted Oak

WLF Lofty Oak

WNF Natural Oak



TSTV Studio Teak Walnut

WHC Honey Cherry

WGW Gunstock Walnut

TBSW Brown Sugar

WAC Amber Cherry

WNW Natural Walnut

WMF Mocha Oak

TSLV Skyline Walnut

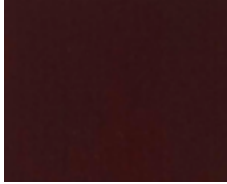
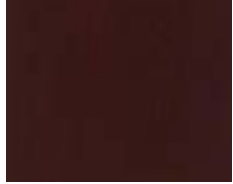

WEW Executive Walnut

WIC Crimson Cherry

GOC KoKo Cherry

WBW Henna Walnut



Finish

Welltech Finish delivers a superior furniture coating with exceptional performance that can withstand stringent cleaning agents and possesses unparalleled durability, allowing DARRAN to provide lasting, sustainable products to our customers.

Covet

Upholstered Arms
Mid-Back

[Click here to view statement of line](#)

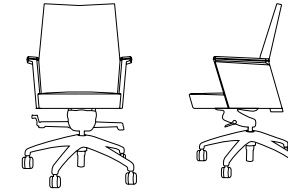

1 Model COV9725UAM04

w" x d" x h"
25.75 x 23.5 x 40-42.75
Arm Height 26" -29"
Seat Height 19" - 22"
Inside Seat Depth 19"
Inside Seat Width 20 -1/2"

COM	COL	1	2	3	4	5	6	7	8	9	10	11/L1	12	13/L2
2514	2592	2625	2680	2735	2790	2845	2900	2955	3010	3065	3120	3175	3230	3340

Upholstery Requirements
Fabric yds: 3 Leather Sq. Ft.: 60
Carton Weight: 55

2 Select Finish

[Click to view finishes](#)

Finishes N/A

3 Combination Fabrics

[Click to view finishes](#)

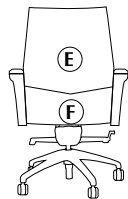
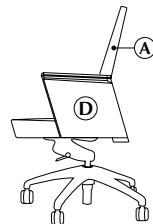
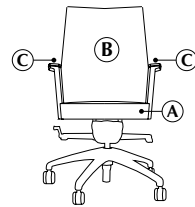

DARRAN is pleased to offer customers the design freedom of combination fabrics. When using fabric, vinyl or leather combinations, pricing/yardage requirements will be as follows:

A Seat/Sides 1 yd(s).
B Inside Back .75 yd(s).
C Arms Caps .5 yd(s).
D Arms .75 yd(s).
E Upper Outside Back .75 yd(s).

- When combining two materials of the same grade, pricing will be specified grade + 5%
- If combining two materials of different grades or leather/fabric combination, use the highest grade/price + 5%
- If using COM or COL, pricing will be COM or COL + 5%.
- If both COM + COL are used in combination, use COL + 5%.

Product Features

- 26" diameter polished aluminum base
- Back utilizes an elastic sheet webbing suspension that conforms to individual's lumbar curvatures for adaptive support.
- Knee Tilt Swivel w/ forward pivot point
- Large 60mm diameter casters are standard and promote increased mobility.
- Plywood components feature interlocking tab joinery for superior strength and long term durability.
- Upholstered panel arms feature caps which can be specified in contrasting fabrics, vinyl, or leathers.

Options

Wood Arm Cap

- AOW: Wood Arm Caps - \$100

Base Options

- BBPC: Black Base - \$95
- BOW: Wood Base- \$170

Covet

Upholstered Arms
High-Back

[Click here to view statement of line](#)

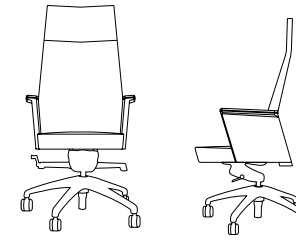

1 Model COV9725UAH05

w" x d" x h"
25-34 x 23.5 x 50.5-53
Arm Height 26" - 29"
Seat Height 19" - 22"
Inside Seat Depth 19"
Inside Seat Width 20 -1/2"

COM	COL	1	2	3	4	5	6	7	8	9	10	11/L1	12	13/L2
2647	2728	2777	2841	2905	2969	3033	3097	3161	3225	3289	3353	3417	3481	3609

Upholstery Requirements
Fabric yds: 3.5 Leather Sq. Ft.: 70
Carton Weight: 60

2 Select Finish

[Click to view finishes](#)

Finishes N/A

3 Combination Fabrics

[Click to view finishes](#)

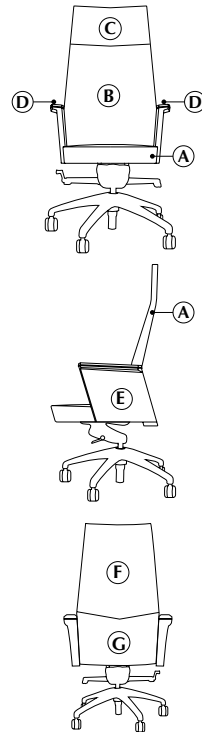

DARRAN is pleased to offer customers the design freedom of combination fabrics. When using fabric, vinyl or leather combinations, pricing/yardage requirements will be as follows:

- A Seat/Sides 1 yd(s).
- B Lower Inside Back .75 yd(s).
- C Upper Inside Back 0.75 yd(s).
- D Arm Cap .5 yd(s).
- E Arms .75 yd(s).

- When combining two materials of the same grade, pricing will be specified grade + 5%
- If combining two materials of different grades or leather/fabric combination, use the highest grade/price + 5%
- If using COM or COL, pricing will be COM or COL + 5%.
- If both COM + COL are used in combination, use COL + 5%.

Product Features

- 26" diameter polished aluminum base
- Back utilizes an elastic sheet webbing suspension that conforms to individual's lumbar curvatures for adaptive support.
- Knee Tilt Swivel w/ forward pivot point
- Large 60mm diameter casters are standard and promote increased mobility.
- Plywood components feature interlocking tab joinery for superior strength and long term durability.
- Upholstered panel arms feature caps which can be specified in contrasting fabrics, vinyl, or leathers.

Options

Wood Arm Cap

- AOW: Wood Arm Caps - \$100

Base Options

- BBPC: Black Base - \$95
- BOW: Wood Base- \$170

DARRAN

Covet

Armless
Mid-Back

[Click here to view statement of line](#)

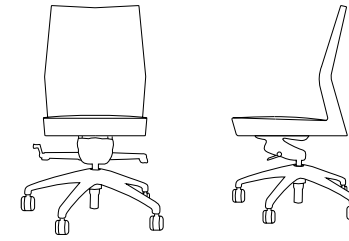

1 Model COV9725NAM00

w" x d" x h"
20.5 x 23.5 x 40-42.75
Arm Height N/A
Seat Height 19" - 22"
Inside Seat Depth 19"
Inside Seat Width 20 -1/2"

COM	COL	1	2	3	4	5	6	7	8	9	10	11/L1	12	13/L2
1966	2021	2059	2105	2151	2197	2243	2289	2335	2381	2427	2473	2519	2565	2657

Upholstery Requirements
Fabric yds: 2.5 Leather Sq. Ft.: 50
Carton Weight: 50

Product Features

- 26" diameter polished aluminum base
- Back utilizes an elastic sheet webbing suspension that conforms to individual's lumbar curvatures for adaptive support.
- Knee Tilt Swivel w/ forward pivot point
- Large 60mm diameter casters are standard and promote increased mobility.
- Plywood components feature interlocking tab joinery for superior strength and long term durability.

2 Select Finish

[Click to view finishes](#)

Finishes N/A

3 Combination Fabrics

[Click to view finishes](#)

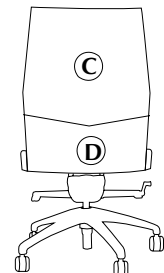
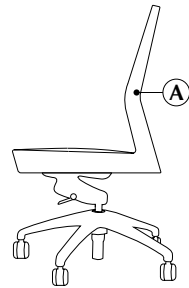
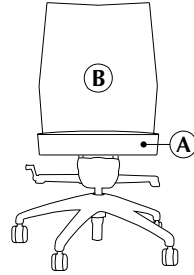

DARRAN is pleased to offer customers the design freedom of combination fabrics. When using fabric, vinyl or leather combinations, pricing/yardage requirements will be as follows:

- A Seat/Sides 1 yd(s).
- B Inside Back .75 yd(s).
- C Upper Outside Back .75 yd(s).
- D Lower Outside Back .75 yd(s).

- When combining two materials of the same grade, pricing will be specified grade + 5%
- If combining two materials of different grades or leather/fabric combination, use the highest grade/price + 5%
- If using COM or COL, pricing will be COM or COL + 5%.
- If both COM + COL are used in combination, use COL + 5%.

Options

Base

- BBPC: Black Base - \$95
- BOW: Wood Base- \$170

Covet

Armless
High-Back

[Click here to view statement of line](#)

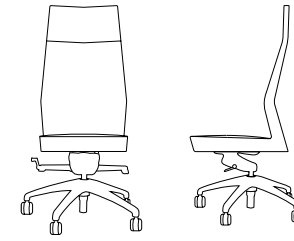

1 Model COV9725NAH01

w" x d" x h"
20.5 x 23.5 x 50.5-53
Arm Height N/A
Seat Height 19" - 22"
Inside Seat Depth 19"
Inside Seat Width 20 -1/2"

COM	COL	1	2	3	4	5	6	7	8	9	10	11/L1	12	13/L2
2099	2157	2210	2265	2320	2375	2430	2485	2540	2595	2650	2705	2760	2815	2925

Upholstery Requirements
Fabric yds: 3 Leather Sq. Ft.: 60
Carton Weight: 55

2 Select Finish

[Click to view finishes](#)

Finishes N/A

3 Combination Fabrics

[Click to view finishes](#)

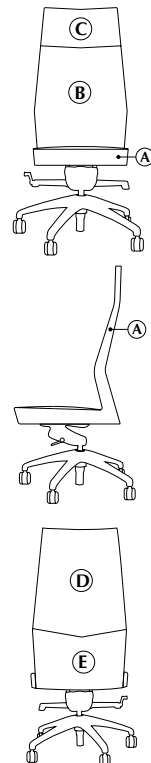

DARRAN is pleased to offer customers the design freedom of combination fabrics. When using fabric, vinyl or leather combinations, pricing/yardage requirements will be as follows:

- A Seat/Sides 1 yd(s).
- B Lower Inside Back .75 yd(s).
- C Upper Inside Back .5 yd(s).
- D Upper Outside Back .75 yd(s).
- E Lower Outside Back .75 yd(s).

- When combining two materials of the same grade, pricing will be specified grade + 5%
- If combining two materials of different grades or leather/fabric combination, use the highest grade/price + 5%
- If using COM or COL, pricing will be COM or COL + 5%.
- If both COM + COL are used in combination, use COL + 5%.

Product Features

- 26" diameter polished aluminum base
- Back utilizes an elastic sheet webbing suspension that conforms to individual's lumbar curvatures for adaptive support.
- Knee Tilt Swivel w/ forward pivot point
- Large 60mm diameter casters are standard and promote increased mobility.
- Plywood components feature interlocking tab joinery for superior strength and long term durability.

Options

Base

- BBPC: Black Base - \$95
- BOW: Wood Base - \$170

Covet

Adjustable Ergonomic Arms
Mid-Back

[Click here to view statement of line](#)

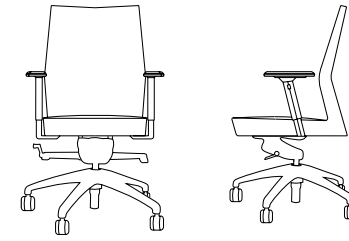

1 Model COV9725AAM02

w" x d" x h"
27.5 x 23.5 x 40-42.75
Arm Height 26" - 29"
Seat Height 19" - 22"
Inside Seat Depth 19"
Inside Seat Width 20 -1/2"

COM	COL	1	2	3	4	5	6	7	8	9	10	11/L1	12	13/L2
2280	2335	2373	2419	2465	2511	2557	2603	2649	2695	2741	2787	2833	2879	2971

Upholstery Requirements
Fabric yds: 2.5 Leather Sq. Ft.: 50
Carton Weight: 55

2 Select Finish

[Click to view finishes](#)

Finishes N/A

3 Combination Fabrics

[Click to view finishes](#)

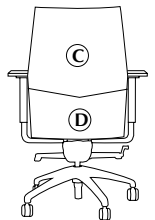
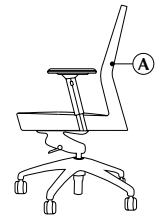
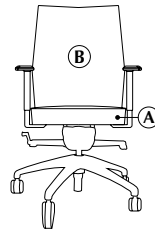

DARRAN is pleased to offer customers the design freedom of combination fabrics. When using fabric, vinyl or leather combinations, pricing/yardage requirements will be as follows:

- A Seat/Sides 1 yd(s).
- B Inside Back .75 yd(s).
- C Upper Outside Back .75 yd(s).
- D Lower Outside Back .75 yd(s).

- When combining two materials of the same grade, pricing will be specified grade + 5%
- If combining two materials of different grades or leather/fabric combination, use the highest grade/price + 5%
- If using COM or COL, pricing will be COM or COL + 5%.
- If both COM + COL are used in combination, use COL + 5%.

Product Features

- 26" diameter polished aluminum base
- Back utilizes an elastic sheet webbing suspension that conforms to individual's lumbar curvatures for adaptive support.
- Back adjustable ergonomic arms are available with spring loaded height adjustment and button activation. Arms are angles at 15 degrees with an adjustable arm pad for additional comfort and support. Arm adjusts 3- 1/4" in height and 1-1/2" in width
- Knee Tilt Swivel w/ forward pivot point
- Large 60mm diameter casters are standard and promote increased mobility.
- Plywood components feature interlocking tab joinery for superior strength and long term durability.

Options

Base

- BBPC: Black Base - \$95
- BOW: Wood Base- \$170

Covet

Adjustable Ergonomic Arms
High-Back

[Click here to view statement of line](#)

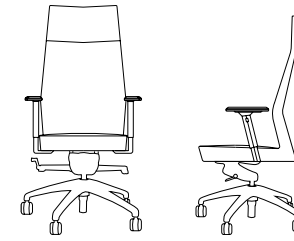

1 Model COV9725AAH03

w" x d" x h"
27.5 x 23.5 x 50.5-53
Arm Height 26" - 29"
Seat Height 19" - 22"
Inside Seat Depth 19"
Inside Seat Width 20 -1/2"

COM	COL	1	2	3	4	5	6	7	8	9	10	11/L1	12	13/L2
2412	2470	2523	2578	2633	2688	2743	2798	2853	2908	2963	3018	3073	3128	3238

Upholstery Requirements
Fabric yds: 3 Leather Sq. Ft.: 60
Carton Weight: 60

2 Select Finish

[Click to view finishes](#)

Finishes N/A

3 Combination Fabrics

[Click to view finishes](#)

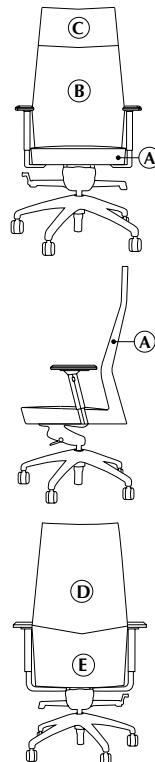

DARRAN is pleased to offer customers the design freedom of combination fabrics. When using fabric, vinyl or leather combinations, pricing/yardage requirements will be as follows:

- A Seat/Sides 1 yd(s).
- B Lower Inside Back .75 yd(s).
- C Upper Inside Back .5 yd(s).
- D Upper Outside Back .75 yd(s).
- E Lower Outside Back .75 yd(s).

- When combining two materials of the same grade, pricing will be specified grade + 5%
- If combining two materials of different grades or leather/fabric combination, use the highest grade/price + 5%
- If using COM or COL, pricing will be COM or COL + 5%.
- If both COM + COL are used in combination, use COL + 5%.

Product Features

- 26" diameter polished aluminum base
- Back utilizes an elastic sheet webbing suspension that conforms to individual's lumbar curvatures for adaptive support.
- Black adjustable ergonomic arms are available with spring loaded height adjustment and button activation. Arms are angles at 15 degrees with an adjustable arm pad for additional comfort and support. Arm adjusts 3- 1/4" in height and 1-1/2" in width
- Knee Tilt Swivel w/ forward pivot point
- Large 60mm diameter casters are standard and promote increased mobility.
- Plywood components feature interlocking tab joinery for superior strength and long term durability.

Options

Base

- BBPC: Black Base - \$95
- BOW: Wood Base- \$170

Covet

Metal "C" Arms
Mid-Back

[Click here to view statement of line](#)

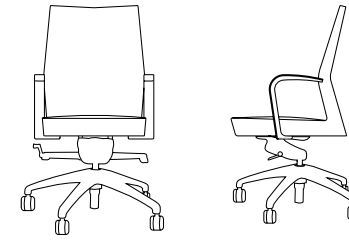

1 Model COV9725CAM06

w" x d" x h"
26 x 23.5 x 40-42.75
Arm Height 26" - 29"
Seat Height 19" - 22"
Inside Seat Depth 19"
Inside Seat Width 20 -1/2"

COM	COL	1	2	3	4	5	6	7	8	9	10	11/L1	12	13/L2
2140	2195	2233	2279	2325	2371	2417	2463	2509	2555	2601	2647	2693	2739	2831

Upholstery Requirements
Fabric yds: 2.5 Leather Sq. Ft.: 50
Carton Weight: 50

2 Select Finish

[Click to view finishes](#)

Finishes N/A

3 Combination Fabrics

[Click to view finishes](#)

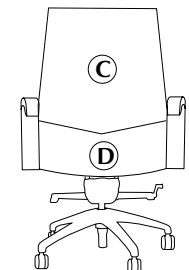
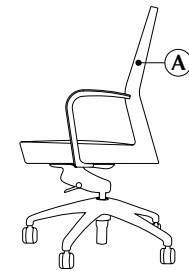
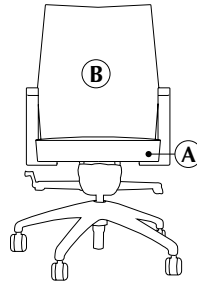

DARRAN is pleased to offer customers the design freedom of combination fabrics. When using fabric, vinyl or leather combinations, pricing/yardage requirements will be as follows:

- A Seat/Sides 1 yd(s).
- B Inside Back .75 yd(s).
- C Upper Outside Back .75 yd(s).
- D Lower Outside Back .75 yd(s).

- When combining two materials of the same grade, pricing will be specified grade + 5%
- If combining two materials of different grades or leather/fabric combination, use the highest grade/price + 5%
- If using COM or COL, pricing will be COM or COL + 5%.
- If both COM + COL are used in combination, use COL + 5%.

Product Features

- 26" diameter polished aluminum base
- Back utilizes an elastic sheet webbing suspension that conforms to individual's lumbar curvatures for adaptive support.
- Knee Tilt Swivel w/ forward pivot point
- Large 60mm diameter casters are standard and promote increased mobility.
- Metal "C" Arm
- Plywood components feature interlocking tab joinery for superior strength and long term durability.

Base Options

- BBPC: Black Base - \$95
- BOW: Wood Base- \$170

Covet

Metal "C" Arms
High-Back

[Click here to view statement of line](#)

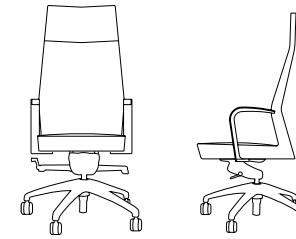

1 Model COV9725CAH07

w" x d" x h"
26 x 23.5 x 50.5-53
Arm Height 26" - 29"
Seat Height 19" - 22"
Inside Seat Depth 19"
Inside Seat Width 20 -1/2"

COM	COL	1	2	3	4	5	6	7	8	9	10	11/L1	12	13/L2
2274	2332	2385	2440	2495	2550	2605	2660	2715	2770	2825	2880	2935	2990	3100

Upholstery Requirements
Fabric yds: 3 Leather Sq. Ft.: 60
Carton Weight: 55

2 Select Finish

[Click to view finishes](#)

Finishes N/A

3 Combination Fabrics

[Click to view finishes](#)

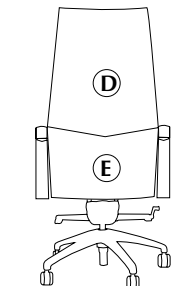
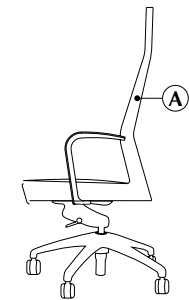
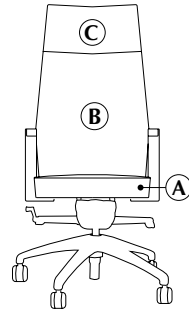

DARRAN is pleased to offer customers the design freedom of combination fabrics. When using fabric, vinyl or leather combinations, pricing/yardage requirements will be as follows:

- A Seat/Sides 1 yd(s).
- B Lower Inside Back .75 yd(s).
- C Upper Inside Back .5 yd(s).
- D Upper Outside Back .75 yd(s).
- E Lower Outside Back .75 yd(s).

- When combining two materials of the same grade, pricing will be specified grade + 5%
- If combining two materials of different grades or leather/fabric combination, use the highest grade/price + 5%
- If using COM or COL, pricing will be COM or COL + 5%.
- If both COM + COL are used in combination, use COL + 5%.

Product Features

- 26" diameter polished aluminum base
- Back utilizes an elastic sheet webbing suspension that conforms to individual's lumbar curvatures for adaptive support.
- Knee Tilt Swivel w/ forward pivot point
- Large 60mm diameter casters are standard and promote increased mobility.
- Metal "C" Arm
- Plywood components feature interlocking tab joinery for superior strength and long term durability.

Base Options

- BBPC: Black Base - \$95
- BOW: Wood Base- \$170