

D A R R A N

Occasional Park Price List

Effective April 15, 2012



ENVI-UT / BAC GUARD SILVER™ ANTI-MICROBIAL FINISH



GENERAL INFORMATION



officepark

ALL DARRAN PRODUCTS AND RAW MATERIALS ARE PROUDLY MANUFACTURED IN THE U.S.A

**BUILT TO ORDER:** Manufactured per order the way you want it, including modifications.

**FULLY ASSEMBLED:** Unless otherwise noted, all products are fully assembled and ready to use, including add-on options.

**PERFORMANCE TESTED:** All products are tested to ensure performance exceeds BIFMA / ANSI standards.

**GREEN CERTIFIED:**



DARRAN has been committed to improving indoor air quality of office buildings since 1996. Since then, finish technology has allowed our commitment to continue with products that are air quality Certified Green.

DARRAN is proud to announce that all Design-Build and Office Park Products in veneer, laminate, and guest seating are MAS Certified Green for complying with the ANSI/BIFMA X 7.1 standard / LEED 4.5 Standard for low –VOC emitting Furniture.

MAS is an independent emission testing laboratory that is ISO 17025 compliant using ASTM, ANSI and CEN methods. MAS is a true 3rd party certification through NSF International to BIFMA standards and California’s ARB formaldehyde standard. Certification of compliance under the Low – VOC emitting Furniture testing, qualifies products for LEED 4.5 credits.

**FINISH TECHNOLOGY:**



DARRAN has continued its partnership with AkzoNobel Chemicals ([www.akzonobel.com](http://www.akzonobel.com)) to develop a new finish technology further improving indoor air quality with a coating that meets today’s environmental standards and supports LEED buildings.

ENVI-UT (Environmental Urethane Technology) utilizes advanced European finish technology to deliver a high-end furniture coating with superior performance in appearance and durability, allowing DARRAN to deliver more sustainable products to our customers.

ENVI-UT Advantages:

- ENVI-UT is a re-engineered high performance Urethane Top Coat
- Sprayed on 100% of DARRAN’s casegoods (DB & OP) using the most advanced Plural Component Spray Technology.
- Exceptional hardness and clarity
- Highly resistant to solvents and chemicals
- Plasticizer Migration resistant
- Excellent UV inhibitors for maximum color resistance
- Exceeds current and proposed future Federal and State air quality requirements
- Field Repairable
- Dynamic chamber emissions tested and certified compliant to ANSI/BIFMA X 7.1 Standard / LEED 4.5 Standard for low – VOC emitting furniture.
- Standard with **BAC■GUARD SILVER™** Anti-microbial additive.

**BAC■GUARD SILVER™**

Advantages:

DARRAN has upgraded the standard **BAC■GUARD™** Anti-microbial protection, to **BAC■GUARD SILVER™**, the latest in Silver Ion Technology. DARRAN collaborated with the world’s leader in finishing materials, to formulate an additive that will inhibit the growth of mold, mildew, fungus and bacteria on wood surfaces. This additive infuses Silver Ions into DARRAN’s ENVI-UT (Environmental Urethane Finish Technology), creating a protective surface for the life of the furniture. The best part - **BAC■GUARD SILVER™** is standard on all DARRAN Casegoods for no additional fee. For more information on **BAC■GUARD SILVER™** or for test data and photos, visit [www.darran.com](http://www.darran.com) or call Customer Service, 800.334.7891.

**FINISH COMPATIBILITY:**

Office Park finishes have been developed for compatibility to DARRAN Design-Build finishes. This allows specification coordination of Executive offices and task offices for a consistent interior appearance.

**While compatible, DARRAN does not recommend mixing Office Park and Design-Build units together at a single workstation.**

**FINISH COMPATIBILITY MATRIX:**

<b>OFFICE PARK FINISH</b>	<b>DESIGN-BUILD FINISH</b>
CARAMEL CHERRY	CLEAR CHERRY
AMBER CHERRY	NATURAL CHERRY
BOURBON CHERRY	SCOTCH CHERRY
CRIMSON CHERRY	MEDIUM CHERRY
KOKO CHERRY	KOKO CHERRY
GUNSTOCK WALNUT	LIGHT WALNUT
HERITAGE WALNUT	NATURAL WALNUT
CONGRESS WALNUT	EXECUTIVE WALNUT

## WARRANTY

## Limited Lifetime Warranty

DARRAN Furniture Industries, Inc. ("DARRAN") warrants that each piece of furniture manufactured in its North Carolina facilities will be free from manufacturing defects and workmanship for as long as the original purchaser owns and uses the products.

DARRAN, at its discretion, will replace or repair with comparable product, free of charge to the customer, any product shown to be of normal care and use. This warranty is made to the original customer for as long as that customer owns and uses the product.

**LIMITATIONS: Use / Care**

- Warranty is limited to normal single shift use.
- Warranty is limited to generally accepted care and maintenance of natural wood products and environments.

**LIMITATIONS: Materials / Components**

- Laminates, Veneers/Finishes - 10 years
- Electrical lamps, ballasts, transformers - 5 years
- Fabrics, Pneumatic lifts, Foam - 5 years
- Custom/Modified products to customers specifications - 3 years

**WARRANTY EXCLUSIONS**

- Damage identified as carrier or installer related.
- Normal wear and tear of wood products during course of ownership.
- Color, grain, or texture of natural wood materials, laminates and other covering materials.
- Damages or failures resulting from misuse, abuse, negligence, improper care, modifications, or relocation.
- Non Commercial use or locations.

All Warranty Claims are subject to Factory approved inspections. Disputes may involve independent 3rd party evaluation.

**LIFETIME COVERAGE**

All components covered under DARRAN limited lifetime warranty includes repair / replacement labor for the 1st 5 years and component replacement including shipping after 5 years.

**QUALITY ASSURANCE**

DARRAN manufactures in accordance with the standards set by the Architectural Woodwork Institute for Quality Standards. DARRAN maintains a staffed testing facility to ensure products manufactured meet BIFMA/ANSI performance standards.

Every unit produced at DARRAN is completely inspected by an independent quality control team located within each plant whose emphasis is on assembly, finish and final inspections with empowerment to stop any unit not meeting DARRAN's high quality standards.

**LIGHT AND NATURAL FINISHES**

DARRAN carefully selects veneer and solids going into every product to ensure color and natural wood variations are within acceptable commercial AWI standards. Light and natural finishes inherently will greater reflect the natural grain and color variation found in hardwood veneers, solids and other core materials. Variations may be between components or unit to unit. DARRAN does not warrant color and grain variations associated with natural wood color and grain seen in any finish color.

**GLASS**

Due to the risk of veneer damage and top warping, DARRAN does not recommend the use of heavy glass overlays on surfaces.

**GENERAL**

Performance questions will be tested to generally accepted practices and AWI guidelines and standards for wood veneer furniture. There are no other warranties except as expressly set forth above either expressed or implied. To obtain performance of these Limited Warranties, the purchaser should contact in writing the authorized DARRAN representatives or current dealer who sold the product to the purchaser or mail the warranty claim to:

**Warranty Department**  
**1-800-334-7891**  
**DARRAN Furniture Industries, Inc.**  
**P.O. Box 7614**  
**High Point, NC 27264**

**DAMAGES / RETURNS / REPAIRS****NO HASSLE FREIGHT DAMAGED MERCHANDISE**

DARRAN Office Park products are packed in specially designed cartons and padding that protects all edges and corners from damage. This is proven by an industry low damage rate of .0030% per total pieces shipped.

For qualified freight damage claims DARRAN will take responsibility for the claim and remedy processes including assuming total cost coverage from claim settlements. (Some items may not qualify. Contact Factory for specific details.)

Qualified Claim Conditions:

1. Only DARRAN approved contract furniture carriers qualify
- 2a. Bills of Lading with damage notations will qualify
- 2b. Concealed damage will qualify IF:
  - Damages were found and furniture is located at original delivery docks.
  - Original cartons and padding is saved and available for carrier inspection.
  - Damage claims involving glass or stone components must be inspected and damage noted on delivering freight bill to qualify for replacement.

For qualified claims per above contact DARRAN Warranty Service Department at 1-800-334-7891.

Non-Qualified Claim Conditions:

1. Deliveries made to non-dock locations
2. Claims made after furniture is installed and/or removed from original delivery location
3. Carton and padding has been discarded
4. Carrier used was not DARRAN approved
5. Inspection reveals questionable damages

**REPLACEMENT ORDERS:**

Replacement orders entered without replacement tagging or factory authorization is considered a new order without dispute, therefore full payment is expected and will be collected.

**RETURN SHIPMENTS**

DARRAN will not accept return of merchandise without a signed RA (return authorization) form.

DARRAN will specify the carrier to be used. Return bills of lading must be marked "Class 125" freight rate and a copy of the RA should be used as a packing list. All returns must be received by DARRAN within 30 days of the RA date or the products will be considered accepted by the customer.

All products being returned must be properly packed and protected to avoid freight damage. Whenever possible, use the original cartons in which the merchandise was shipped. Freight damage, signs of usage, missing parts, etc., will result in an adjustment of any credit to be issued.

DARRAN will issue RA's for the following reasons:

1. Manufacturing defect (inspection required)
2. Order processing error by DARRAN
3. Shipping error
4. Mismarked carton / merchandise

**SPECIFICATION CHANGES**

We reserve the right to change without notice any dimension, style, or specification of any model in the DARRAN line. Dimensions shown in the price list are nominal. It is the buyer's responsibility to read specification carefully when matching existing goods is desired.

**MANUFACTURING DEFECTS**

Claims of manufacturing defects will not be entertained without prior consultation with DARRAN's warranty department. Unauthorized deduction in payment of invoices will not be allowed without prior factory approval. Unapproved deductions are subject to factor's late payment charges.

**DAMAGE CLAIMS**

Claims of manufacturing damage or freight damage reported as nicks, dents, scratches, etc. after installation of furniture will not be covered under warranty or freight claim.

**Attention:** Damage claims involving glass or stone components must be inspected and damage noted on delivering freight bill to qualify for replacement.

**REPAIR CHARGES**

Factory authorization must be secured from DARRAN's warranty department prior to incurring repair charges. Warranty will utilize DARRAN's National Repair Service through the Furniture Medic Franchise ([www.furnituremedic.com](http://www.furnituremedic.com)). Repair charge authorizations are based on:

- Set travel rate
- Average regional job rate
- Factory set maximum repair time
- Falsely reported defect claims are subject to local service charges being charged to dealer/distributor.

**FINISH MAINTENANCE**

Wood office furniture and wood finishes can retain their natural beauty for life if proper care is taken and a stable environment is provided. **Fluctuations in humidity and temperature cause panels and solid wood components to expand and contract and may lead to panel warpage and finish "checking" or cracking. Prolonged exposure of furniture to dry heat during winter months should be avoided. Careful examination of interior wood trim may indicate a damaging dry environment. If open joints, splits and cracks are appearing in trimwork consult with a HVAC professional for appropriate remedy.**

DARRAN finishes are field repairable should damage occur. Professional furniture repair services are recommended. Regular cleaning with a non-silicone polish is recommended.

**DARRAN FURNITURE POLISH**

DARRAN has formulated a surface polish that will protect surfaces from light scratches and abrasions, yet will not build up or splotch with age. Contact Factory Customer Service for ordering information.

## ORDERING INFORMATION AND INSTRUCTIONS

**ORDERING**

All orders should be mailed, phoned, or transmitted by fax to:

DARRAN Furniture Industries, Inc.  
P.O. Box 7614  
High Point, NC 27264  
Telephone: 336-861-2400  
Toll Free: 800-334-7891  
Fax: 336-861-6485

DARRAN will only accept Office Park orders from authorized Dealers.

All orders must be accurate and detailed. All Quick Ship orders must contain Quick Ship product ONLY. Orders should be separated and submitted according to lead time. Orders must contain Quick Ship code "QS" or have designated Quick Ship lead time to ensure correct order entry. Orders that contain multiple lead time products will be entered as one order and scheduled with the most extended lead time.

List product by office and tag accordingly. DARRAN will key alike all products under the office tag. Failure to assign and tag may result in random key number assignments. Keying is field changeable.

**CREDIT APPROVAL**

All orders are subject to credit approval for open account. All new accounts must be approved by a local DARRAN Sales Representative and should submit current financial information and trade references to:

DARRAN Furniture Industries, Inc.  
ATTN: Credit Department  
P.O. Box 7614  
High Point, NC 27264  
Telephone: 336/861-2400  
Toll Free: 800/334-7891  
Fax: 336/861-2512

**Orders submitted without accounts pre-approval or credit approval are subject to acceptance with lead times scheduled only after approval dates.**

**LEAD TIME SCHEDULE**

DARRAN cannot assign a firm lead time until Credit approval and order accuracy are complete. Extended lead times due to credit or information delays are the responsibility of the Buyer.

**SHIPPING SCHEDULE**

Order acknowledgements are assigned a projected delivery date based on carrier's average transit time to point of destination. When requested, DARRAN will assist in locating special express carriers that may have short transit times. These services may exceed our prepaid freight costs; therefore, pricing is limited to the Freight Excluded formula with special express charges added to the invoice.

For special deliveries, DARRAN will make every effort to meet the appointed time; however DARRAN will not be responsible for any additional charges for late deliveries beyond our control.

**ORDER DELAY / HOLD**

Due to the committed manufacturing cost on Office Park Quick Ship processes, DARRAN cannot delay or hold orders, either in process or after completion.

**CANCELLATION AND ORDER CHANGES - FEES**

Acknowledged orders are considered firm orders and therefore not subject to cancellation or change. However, in the event we are able to stop an order prior to manufacturing process, we will consider cancellation or changes with a reprocessing fee of \$40.00 Net. Exceptions: Quickship orders cannot be changed or cancelled after the 3rd business date after acknowledgement. **Qualified changes/cancellations will be accessed a \$40.00 Net processing fee.**

Changes or cancellation of order with special options or custom quoted items are also subject to additional material and vendor fee costs, plus a DARRAN special/custom reprocessing fee of \$100 NET.

**ORDER MOVEUPS**

Should an original scheduled ship date need to be improved, the Factory must be contacted 15 business days prior to the desired ship date.

**ORDER ACKNOWLEDGMENT**

Upon credit approval your order will be acknowledged and identified by an order number. When making reference to your order, please use this order number. Your acknowledgment is a detailed description of our interpretation of your order, pricing, shipping information, and estimated delivery date.

If you have not received an Acknowledgment within 10 Days of order issue, contact Customer Service immediately. All Quick Ship order acknowledgements will be faxed or emailed upon request to speed processing. Please read your acknowledgment carefully for correctness and notify DARRAN immediately of any discrepancies. Failure to notify relieves DARRAN from error liability.

Order acknowledgment is the final agreement between DARRAN and the customer superseding all previous communications regarding the order. DARRAN will not be responsible for errors made on orders placed by phone without written confirmation.

**SELLING INFORMATION**

Possession of this price list does not in itself constitute the right to sell DARRAN products. DARRAN products are sold and distributed through authorized dealerships. Contact factory for a listing of local representatives and dealerships.

**INVOICE TERMS**

Standard terms are NET 30 days. Finance charges of 1-1/2% will be added to delinquent accounts after 45 Days and for each 30 Days thereafter until paid.

Complaints involving newly received merchandise must be reported within 10 days from receipt to qualify for full invoice remittance suspension or term extension. **Otherwise only items in dispute can be suspended from payment of invoice within terms.**

**WAREHOUSE/STORAGE**

DARRAN will determine order warehousing approvals on a case by case basis. Orders that can be accommodated will be limited to a max of 30 days storage and must be invoiced at time of storage. Orders that exceed factory storage capacity will be transferred to local storage facilities subject to current storage rates and handling-transit charges. Storage charges must be paid prior to order release to shipping.

## Business Classification: Woman-Owned Small Business

### FURNITURE GRADES

Legislative Branches of the Federal Government. Grades of construction/materials are identified by an additional suffix (1,2,3,4,5 or 6). The grades of furniture were established to help our customers make a good purchasing decision based on quality, their needs, and budget. Grade (1) includes furniture that tends to be of high quality and most expensive in this schedule. Grade (2) furniture tends to be of high quality but more moderately priced and Grades (3-6) furniture tend to be good quality and progressively more affordably priced when compared to Grades (1) and (2).

On-line access to contract ordering information, terms and conditions, up-to-date pricing, and the option to create an electronic delivery order are available through GSA Advantage!, a menu driven database system.

The INTERNET address for GSA Advantage! is <http://www.fss.gsa.gov>

Executive Office and Conference Room Furniture  
FSC Group 71, Part 1, CLASSES 7710, 7195, 7105, 7125

**GSA Contract Number: GS-28F-2024D**

For more information on ordering from Federal Supply Schedules click on the FSS Schedules button at <http://www.fss.gsa.gov>

DARRAN Furniture Industries, Inc.  
P.O. Box 7614  
High Point, NC 27264  
TF: 800.334.7891, Tel: 336.861.2400, Fax: 336.861.6485

Size of Business: Small

### 2. Order Limitations:

711-8 \$500,000  
711-9 \$500,000  
711-11 \$500,000  
711-16 \$500,000  
711-18 \$500,000  
711-22 \$500,000  
711-95 \$500 (HIGHER IF PREVIOUSLY NEGOTIATED)

### 3. Minimum Order: \$100.00

### 4. Geographic Coverage: 48 Contiguous States and the District of Columbia

### 5. Point of Production: High Point, North Carolina

### 6. Discount: Prices shown herein are List (Discount is 57.71% Off List)

### 7. Quantity Discounts: EFFECTIVE 10/31/2010

Orders Totaling	Discount
\$100,000 NET	58.75%
\$200,000 NET	59.82%
\$300,000 NET	60.87%

### 8. Payment Terms: Standard Terms Net 30 Days

Finance charges of 1-1/2% will be added to delinquent accounts after 45 days and for each 30 days thereafter until paid.

### 8a. Terms and Conditions of Government Credit Card Acceptance:

- No discount allowed for payment by Government Purchase Card
- Provide commercial credit card number
- Provide commercial credit card expiration date
- Provide individual's name as it appears on credit card
- Provide telephone number of individual to whom credit is issued

### 9a. Government Purchase Cards are accepted below the Micro Purchase Threshold.

### 9b. Government Purchase Cards are accepted above the Micro Purchase Threshold.

### 10. Foreign Terms: None

### 11a. Time of Delivery:

Regular Product: 60 days after receipt of order  
Quick Ship Program: 15-30 days after receipt of order

### 11b. Quick Ship Program: Items available for expedited delivery are included in main Price Lists.

### 11c. Overnight and 2-day delivery: N/A

11d. Urgent Requirements: Will be considered on an individual basis. Contact factory for details.

### 12. FOB Point: Destination freight inclusive per Zone. Zone 1, Zone 2, Zone 3, and Zone 4. All destinations are limited to Commercial docks only. Carriers may refuse non-dock deliveries.

12a. Zone prices include normal freight rates. Zone pricing also subject to any extra carrier charges that include:

- Fuel Surcharges - Not to exceed 2% of NET
- Zone 1-2-3 shipments under 300lbs add \$75 Net. Zone 4 under 500lbs add \$100 Net

### 13. Ordering Address:

DARRAN Furniture Industries  
P.O. Box 7614  
High Point, NC 27264  
Ph: 336.861.2400 Fax: 336.861-6485

### 14. Warranty Provision: Limited Lifetime. Details on Page 1.03.

### 15. Export Packing Charges: Quoted on request

### 16. Terms and Conditions: Order Cancellation / Changes. See page 1.05.

Terms and Conditions: Order shipment delays and storage. See page 1.05.

Terms and Conditions: Misorder Returns and Restocking. See page 1.04.

### 17. Terms and Condition of Rental, Maintenance and Repair: Consult the Factory.

### 18. Terms and Conditions of Installation: Installation by a Third party to be quoted on a per job basis. The ordering must specify what ranges of installation services are required.

### 19. Terms and Conditions of Repair Parts: Consult the Factory

### 20. List of Service and distribution points: Consult the Factory.

### 21. Preventative Maintenance: Information enclosed with product.

### 23. Environmental Attributes: Each desk is composed of approximately 80% particleboard. **95% of the particleboard DARRAN uses is SCS (Scientific Certification System) certified to be composed of 100% Recycled or recovered wood fiber. DARRAN's MDF is CPA Certified as an environmentally preferable product.** DARRAN is compliant with EPA standards.

### 23a. Recyclable and Recycled Content Packaging:

Note: The corrugated packaging that is supplied to DARRAN, meets the federal mandate that requires the paperboard to be composed of 30%-50% recycled paper, and in some cases the recycled content is close to 100%.

### 23b. Chemical Emission: DARRAN finishes its Office Park products in ENVI-UT (Environmental Urethane Technology). ENVI-UT is a low formaldehyde finish, allowing DARRAN products to be MAS Certified Green under the ANSI Bifma X.1 Standard. Products assist with LEED 4.5 Credit.

### 23c. Vapor Emissions: DARRAN uses ENVI-UT, an environmental urethane technology that provides lasting durability and exceptional clarity with BACGUARD Silver anti-microbial protection built-in. ENVI-UT allows DARRAN casegoods to be MAS Certified Green meeting LEED Credit 4.5.

### 24a. Duns Number: 08-363-5318

### 24b. Cage Code: 0Y-6B6

### 24c. Federal ID Number: 56-117-1971

### 25. CCR: DARRAN is registered in Central Contractor Registration Database

**PRICING AND FREIGHT CHARGES**

**PRICES AND ZONES**

- All prices shown are suggested list prices with freight included where indicated.
- Freight inclusive Zones allow delivery to one qualified destination.
- Price orders according to destination state as per Zone chart below.
- **Orders less than 300 lbs. in Zone 1, 2, 3 will be assessed a surcharge of \$75 net per order. Zone 4 is \$100 net for shipments less than 500lbs.**

**CALL BEFORE DELIVERY REQUEST**

DARRAN will arrange for carriers to call before delivery when requested.

**FUEL SURCHARGES**

This Price List includes carrier fuel surcharges up to 18% within each zone. DARRAN reserves the right to pass fuel surcharges that exceed 18% onto the buyer. Contact Customer Service for current fuel surcharges. Surcharges will be added to the Order Acknowledgement as a separate line item notice after discount. This surcharge is Net and not subject to discounting. Buyer will have the option to change the order from prepaid ship costs to collect ship costs.

**CARRIER SELECTION**

DARRAN selects and uses only carriers specialized in furniture transportation. Customer requested carriers can be authorized using Freight Excluded pricing with invoice add-on as described in *Prices and Zones*.

**SPECIFIC DELIVERY TIMES**

DARRAN will assist in coordinating a requested delivery time from a carrier. DARRAN makes no guarantees and accepts no responsibility for such services as DARRAN has no control over possible carrier hazards. To ensure specific time arrival, we recommend arranging single stop, designated load carriers. Less than trailer load (LTL) shipments cannot be coordinated for a guaranteed delivery time.

**EXPRESS CARRIERS**

When requested DARRAN will assist in locating special express carriers that may have short transit times. These services exceed our prepaid freight cost, therefore, pricing is limited to the Freight Excluded formula with special express charges added to invoice.



**IMPORTANT NON-Qualified Destinations**  
DARRAN Prepaid Freight Pricing does not include delivery to:

- Residential Areas
- Restricted Commercial Areas
- No Dock Locations
- Inside delivery/setup service

Orders having these situations can only be accepted less prepaid freight pricing and shipped collect per buyers instructions.

**Orders received and installed without professional Furniture Installers voids all Warranty Coverage.**



**Zone 1  
Fgt. Included**

- Alabama
- District of Columbia
- Georgia
- Kentucky
- Maryland
- N. Carolina
- S. Carolina
- Tennessee
- Virginia
- W. Virginia

**Zone 2  
Fgt. Included**

- Arkansas
- Connecticut
- Delaware
- Florida
- Illinois
- Indiana
- Louisiana
- Massachusetts
- Michigan
- Missouri
- Mississippi
- New Jersey
- New York
- Ohio
- Pennsylvania
- Rhode Island

**Zone 3  
Fgt. Included**

- Arizona
- Colorado
- Iowa
- Kansas
- Maine
- Minnesota
- Nebraska
- N. Hampshire
- N. Dakota
- New Mexico
- Oklahoma
- S. Dakota
- Texas
- Utah
- Vermont
- Wisconsin

**Zone 4  
Fgt. Included**

- California
- Idaho
- Montana
- Nevada
- Oregon
- Washington
- Wyoming

**Zone 4: Delivered Pricing**

Use current Zone 3 prices, Plus (+) 8% Plus any current fuel surcharges.

**Zone 4 Minimum Weight Charge:**

Orders less than 500lbs, will be assessed a surcharge of \$100 Net per shipment.

See map of United States below for zones by screen tint.

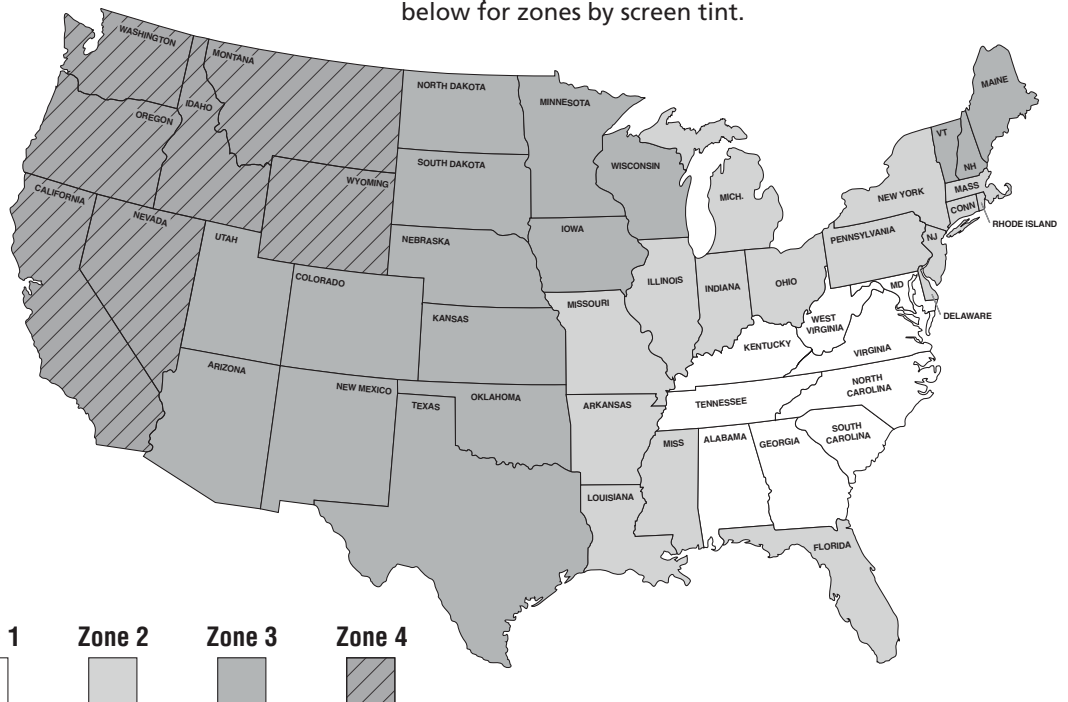





Office Park now offers expanded occasional table solutions for lobbies and offices demanding affordable design. Table quality has been enhanced to offer **BAC GUARD SILVER™** Anti-microbial surfaces and MAS Green Certification for healthier interiors.



All Wood & Laminate Caseloads: Compliant with ANSI/BIFMA X7.1 (Private & Open Office Environments) and LEED CI EQ 4.5 Credit Under Option C.



**BAC GUARD SILVER™**  
Anti-Microbial Protection

## SPECIFICATIONS

**(GO TO INDEX)**

Q denotes Quickship Product

### STANDARD VENEER FINISHES

Q • CRIMSON CHERRY	WIC
Q • BOURBON CHERRY	WBC
Q • CARAMEL CHERRY	WRC
Q • AMBER CHERRY	WAC
Q • KOKO CHERRY	WOC
Q • CONGRESS WALNUT	WCW
Q • HERITAGE WALNUT	WHW
Q • GUNSTOCK WALNUT	WGW
Q • CLEAR MAPLE	WCM
Q • WHEAT MAPLE	WWM

Q denotes Quickship Product

### STANDARD LAMINATE HPL TOPS

Q • CRIMSON CHERRY	GIC
Q • BOURBON CHERRY	GBC
Q • CARAMEL CHERRY	GRC
Q • AMBER CHERRY	GAC
Q • KOKO CHERRY	GOC
Q • CONGRESS WALNUT	GCW
Q • HERITAGE WALNUT	GHW
Q • GUNSTOCK WALNUT	GGW
Q • CLEAR MAPLE	GCM
Q • WHEAT MAPLE	GWM

N/A On Quickship

### QUARRY STONE LAMINATE TOPS

• GRAPHITE NEBULA	LGN
• JEWELLED IVORY	LJI
• DESERT SPRINGS	LDS
• SPICEWOOD SPRINGS	LSS

(Available Only Where Noted)

**\*Note\***

**Quarry Stone Is Available As Self Edge (Flat) w/ No Shape**

Gunstock Walnut (WGW), Clear Maple (WCM) & Wheat Maple (WWM) Are NOT Available On Traditional Styles.

## Construction Specifications

### Occasional Tables

- Legs are solid hardwood  
kiln dried to 6-8% moisture
- Panels are 45 lb particle board or 48 lb Premium Grade MDF
- Veneer tops are 1-5/16" thick #1 select veneers
- metal accents and legs are steel plated or powder coated
- Tempered glass is minimum 1/2" thick with flat polished edge

## 1-5/16" Edge Profiles

### Standard Profiles:

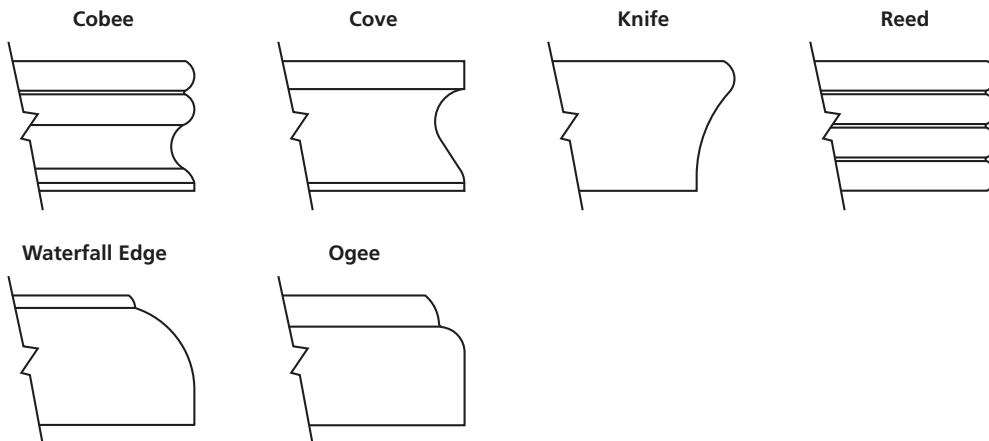

### Edge Profiles With Hardwood Rim Edge Bands:

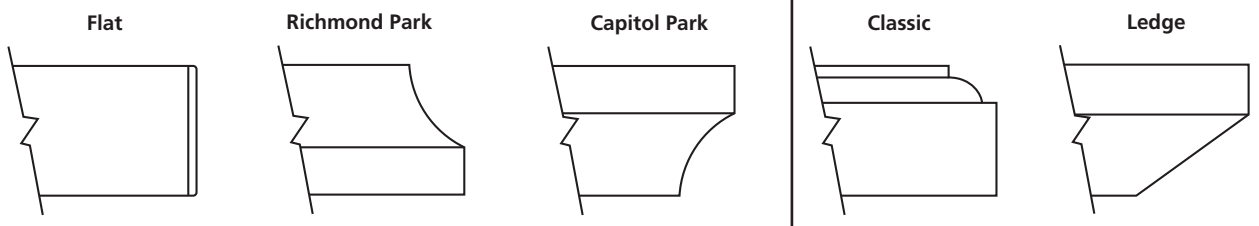

**PREMIUM EDGE PROFILES: (Add \$50 Per Top)**

*Premium Profiles Feature Hardwood Rim Bands Of Same Species As Surface.*

PRODUCT INDEX

(Click On Page Number Under Furniture Icon To Link Directly To Product SKU)

**OCCASIONAL TABLES:**

*Traditional / Richmond Park:*



Page 11.04

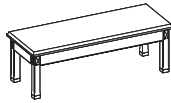

Page 11.04

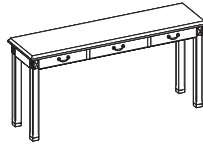

Page 11.04

*Fluted Leg Traditional:*



Page 11.04

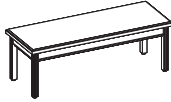

Page 11.04

*Queen Anne Traditional:*



Page 11.04

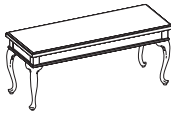

Page 11.04

*Tapered Leg:*



Page 11.05

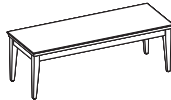

Page 11.05

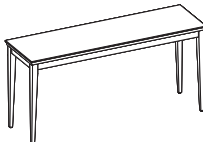

Page 11.05

*Panel End:*

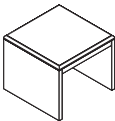

Page 11.06

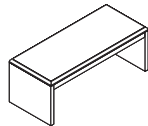

Page 11.06

*Zum:*

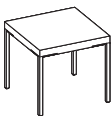

Page 11.06

*Levity Park:*



Page 11.06



Page 11.06

*Capitol Park:*



Page 11.06



## STANDARD FEATURES

**(GO TO INDEX)**

### TRADITIONAL / RICHMOND PARK

- Solid hardwood legs
- Antique brass or optional brushed pewter ferrule toe
- Scalloped apron rail

### FLUTED LEG - TRADITIONAL

- 2" Square hardwood legs - fluted
- Scalloped apron rail

### QUEEN ANNE TABLE

- Carved solid hardwood legs & beltline moldings

Q denotes Quickship Product

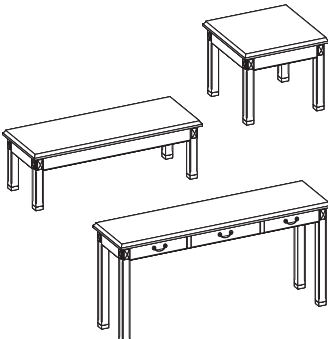
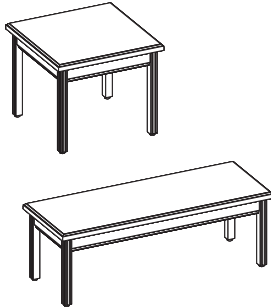
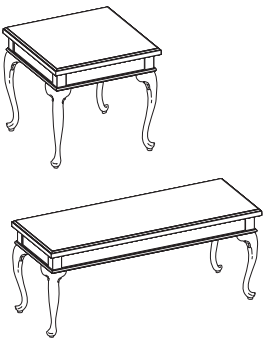
Tables	DIMENSIONS W X D X H	WGT	STYLE NUMBER	MUST SELECT	ZONE 1	LIST PRICE ZONE 2	ZONE 3
 <ul style="list-style-type: none"> <li>• Richmond Park Profile Standard</li> <li>• See Richmond Park For Pull Choices</li> </ul>	End Table 18 x 18 x 20	30	OPO-1818-RP366	Caramel Cherry Gunstock Walnut Wheat/Clear Maple Finishes N/A	809	819	872
	End Table Q 24 x 24 x 20	35	OPO-2424-RP366	WOOD/METAL FINISH	856	866	924
	Cocktail Table Q 18 x 48 x 16	45	OPO-1848-RP369	PULL (CONSOLE)	945	956	1013
	Console Table 16 x 60 x 30	70	OPO-1660-RP361		1528	1544	1596
 <p>Classic Profile Standard</p>	End Table 18 x 18 x 20	30	OPO-1818-FT351	Caramel Cherry Gunstock Walnut Wheat/Clear Maple Finishes N/A	782	793	845
End Table 24 x 24 x 20	35	OPO-2424-FT351	FINISH	798	809	861	
Cocktail Table 18 x 48 x 16	45	OPO-1848-FT351		929	940	998	
 <p>Classic Profile Standard</p>	End Table 18 x 18 x 23	30	OPO-1818-QT350	Caramel Cherry Gunstock Walnut Wheat/Clear Maple Finishes N/A	1076	1087	1145
End Table 24 x 24 x 23	35	OPO-2424-QT350	FINISH	1092	1108	1160	
Cocktail Table 18 x 48 x 18	45	OPO-1848-QT350		1166	1176	1234	

STANDARD FEATURES

**(GO TO INDEX)**

**TAPERED LEG - VENEER TOP**

- Solid hardwood legs
- Apron rail
- Veneer top - 1-5/16"
- Choice of edge detail

**Veneer:**

- Cherry
- Walnut
- Maple

**Wood Grain Laminate:**

- Standard Colors

**Quarry Stone Laminate:**

- Graphite Nebula - LGN
- Jeweled Ivory - LJI
- Desert Springs - LDS
- Spicewood Springs - LSS (Flat Edge - No Shape)

Q denotes Quickship Product

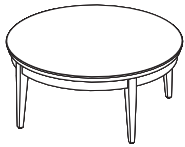
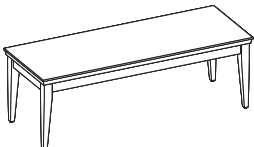
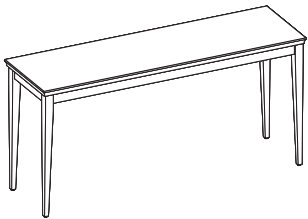
Tables	DIMENSIONS W X D X H	WGT	STYLE NUMBER	MUST SELECT	ZONE 1	LIST PRICE ZONE 2	ZONE 3
<b>ROUND END TABLE - TAPERED LEG / WOOD VENEER TOP</b>  	End Table Round						
	Q 19Ø x 20	30	OPO-1919-CP367	FINISH EDGE	782	793	845
	25Ø x 20	35	OPO-2525-CP367		793	803	856
Cocktail Table							
Q 37Ø x 16	55	OPO-3737-CP367			1024	1034	1087
<b>SQUARE END TABLE - TAPERED LEG / WOOD VENEER TOP</b>  	End Table Square						
	Q 18 x 18 x 20	30	OPO-1818-CP366	FINISH EDGE	761	777	830
	24 x 24 x 20	35	OPO-2424-CP366		782	793	845
	Cocktail Table						
36 x 36 x 16	55	OPO-3636-CP369			1013	1024	1076
18 x 48 x 16	45	OPO-1848-CP369			882	893	945
<b>CONSOLE TABLE - TAPERED LEG / WOOD VENEER TOP</b>  	Console Table						
	18 x 48 x 29	60	OPO-1848-CP361	FINISH EDGE	1407	1418	1475
18 x 60 x 29	70	OPO-1860-CP361	1549		1559	1612	

## STANDARD FEATURES

**(GO TO INDEX)**

### PANEL END TABLES

- 1-1/4" Top
- Panel ends with levelers

### ZUM METAL BASE TABLE

- Brushed nickel legs have accent arms recessed in top edge
- 2" Thick top with 3mm hardwood edge band

### LEVITY TABLE

- Tapered solid hardwood leg
- Black mounting top sleeve
- Black toe accent
- Knife edge shape standard

### CAPITOL PARK WOOD TABLE

- Solid hardwood tapered legs
- Profile edge subtop w/ stepped top surface
- Stepped top surface can be ordered in Quarry Stone Accent

Q denotes Quickship Product

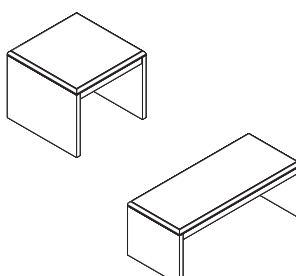
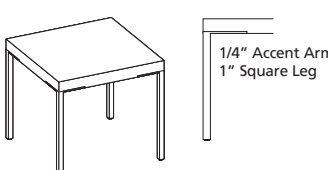
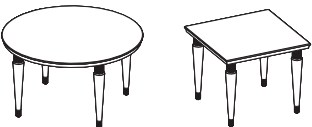
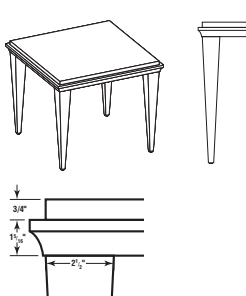
Tables	DIMENSIONS W X D X H	WGT	STYLE NUMBER	MUST SELECT	ZONE 1	LIST PRICE ZONE 2	ZONE 3
<b>PANEL END TABLES</b>  	End Table 18 x 18 x 20	50	OPO-1818-PE357	FINISH EDGE	677	688	740
	Q 24 x 24 x 20	60	OPO-2424-PE357		698	709	761
	Cocktail Table 36 x 36 x 16	80	OPO-3636-PE357		798	809	861
	Q 18 x 48 x 16	70	OPO-1848-PE357		756	772	824
<b>ZUM METAL BASE TABLE</b>   <p>1/4" Accent Arm 1" Square Leg</p>	End Table 18 x 18 x 22	30	OPO-1818-ZU366	STANDARD VENEER FINISH	740	756	803
	24 x 24 x 22	35	OPO-2424-ZU366		824	840	872
	Cocktail Table 18 x 48 x 16	45	OPO-1848-ZU369	OPTIONAL N/C WOOD GRAIN LAMINATE	935	950	982
	30 x 30 x 16	45	OPO-3030-ZU369		935	950	982
	36 x 36 x 16	55	OPO-3636-ZU369		QUARRY STONE LAMINATE	1045	1061
Choice Of Veneer, Laminate Or Quarry Stone Laminate (See Page 11.02 For Finishes / Colors)	42 x 42 x 16	60	OPO-4242-ZU369	1155	1171	1202	
<b>LEVITY PARK TABLE</b>   <p>Finished Knife Edge (Standard)</p>	Round Table 18Ø x 20	30	OPO-1818-LP367	FINISH METAL COLOR	814	824	882
	Q 24Ø x 20	35	OPO-2424-LP367		851	861	919
	Q 36Ø x 16	55	OPO-3636-LP367		977	992	1045
	Square Table 18 x 18 x 20	30	OPO-1818-LP366		803	814	866
	Q 24 x 24 x 20	35	OPO-2424-LP366		845	856	914
	Q 36 x 36 x 16	55	OPO-3636-LP366		956	966	1024
	Choice of black or matte silver accents						
<b>CAPITOL PARK WOOD TABLE</b>  	18 x 18 x 20	30	OPO-1818-CT373	FINISH	924	935	966
	24 x 24 x 20	35	OPO-2424-CT373		971	982	1019
	18 x 42 x 16	40	OPO-1842-CT373		971	982	1019
	18 x 48 x 16	45	OPO-1848-CT373		1034	1045	1076
	30 x 30 x 16	45	OPO-3030-CT373		1034	1045	1076
	36 x 36 x 16	55	OPO-3636-CT373		1082	1092	1139
	42 x 42 x 16	65	OPO-4242-CT373		1192	1202	1250

**OPTIONS****MODESTY OPTIONS**

BREAKFRONT ARCHED MODESTY;  
 BREAKFRONT HALF MODESTY;  
 FULL MODESTY / FLUSH FRONT CHASSIS;  
 WOOD MODESTY LOGOS

**DESK / DRAWER OPTIONS**

CENTER DRAWERS; CENTER DRAWER LINER;  
 ROTATING UTILITY TRAY; PULLOUT WRITING  
 SHELF; WOOD DRAWERS

**CONFERENCE DESK SUPPORT POST OPTIONS**

WOOD DRUM; WOOD HALF DRUM; TAPERED  
 WOOD POST; METAL POST-SQUARE; METAL  
 OVAL "T" BASE; METAL SLEIGH BASE

**PEDESTAL MODIFICATIONS**

BREAKFRONT PEDESTAL WIRE MANAGEMENT  
 CAVITY DOOR; PULLOUT BOTTOM SHELF;  
 ADDITIONAL KNEESPACE CABINETS;  
 MODIFY PEDESTAL DRAWERS

**UNIT WIDTH / HEIGHT MODIFICATIONS**

WIDTH / DEPTH / HEIGHT MODIFICATIONS

**COMPUTER SUPPORT OPTIONS**

MONITOR ARMS; CPU RETRACTABLE CRADLE;  
 KEYBOARD TRAY

**OVERHEAD / WALL HUNG ACCESSORIES**

SLAT WALL / ACCESSORIES; RECESSED  
 ALUMINUM TOOL CHANNEL / ACCESSORIES

**POWER / DATA OPTIONS**

POP-UP; FLIP-UP; FIXED; SURFACE MOUNT;  
 TOUCH LIFT; CONTROL PANEL; POWER SUPPLY  
 CORDSETS

**WIRE MANAGEMENT OPTIONS**

HORIZONTAL "J" / "U" WIRE RACEWAY;  
 VERTICAL WIRE MANAGEMENT; VERTEBRA

**TASKING / DISPLAY OPTIONS**





GLASS SHELVES; HEAVY DUTY WOOD SHELVES

**MISCELLANEOUS OPTIONS**

BLUEPRINT TILT-OUT STORAGE; SLOW CLOSE  
 DOOR CLOSER; DELETE DOORS;  
 REFRIGERATOR CABINET MODIFICATION;  
 DOOR LOCKS; WIRE DIVIDERS;  
 FURNITURE POLISH

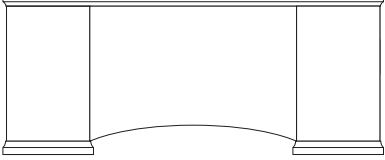

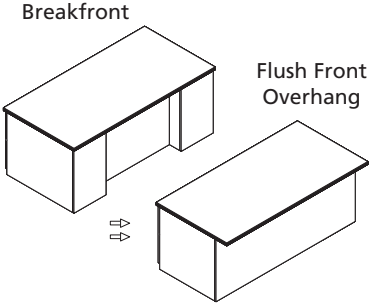
## MODESTY OPTIONS

**(GO TO INDEX)**

DESCRIPTION / ILLUSTRATION	OPTIONS CODE	SPECIFICATIONS	LIST UPCHARGE	COLLECTIONS AVAILABLE
<b>BREAKFRONT ARCHED MODESTY</b>  	M11A	<b>Breakfront Arched Modesty</b>  Modify standard Capitol Park desk with breakfront modesty to arched curve.	\$195	All Office Park Products
<b>BREAKFRONT HALF MODESTY</b>  	MODHM	<b>Breakfront Half Modesty</b>  <ul style="list-style-type: none"> <li>Modify standard double breakfront full modesty to half modesty</li> </ul>	n/c	All Office Park Products
<b>FULL MODESTY / FLUSH FRONT CHASSIS DESIGN</b>   <p>Breakfront</p> <p>Flush Front Overhang</p>	MODCX	<b>Flush Front / Full Modesty Chassis Design</b>  Due to the complexity of chassis style modifications, pricing is subject to engineering and cost input.	Quote Only	All Office Park Products
<b>WOOD MODESTY LOGOS</b>  	LEWM	<b>Wood Modesty Logos</b>  <ul style="list-style-type: none"> <li>Wood veneer modesty is laser etched with logo detailing</li> <li>Not recommended on dark finishes</li> </ul> <p><i>Prices Based On Logo Size And Detailing.</i></p>	Quote Only	All Office Park Products



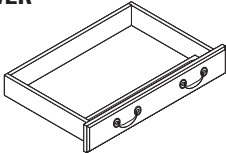
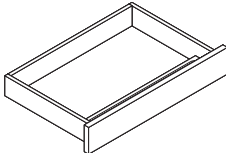
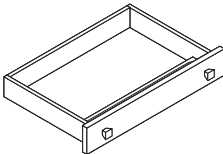
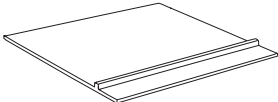
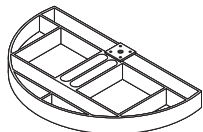

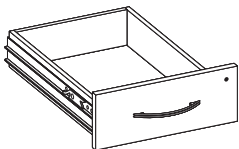
DESK / DRAWER OPTIONS

(GO TO INDEX)

DESCRIPTION / ILLUSTRATION	OPTIONS CODE	SPECIFICATIONS	LIST UPCHARGE	COLLECTIONS AVAILABLE
<p><b>FINISHED TRADITIONAL CENTER DRAWER</b></p>  <p>SPECIFY PULLS / FACTORY INSTALLED</p>	K30	<p><b>Finished Traditional Center Drawer</b></p> <p>Veneer drawer front finished to match unit veneer and color. Edges are scalloped to match standard drawers. Specify drawer pulls.</p> <ul style="list-style-type: none"> <li>• Standard with matching wood grain pencil tray</li> </ul> <p>Pulls selected to match unit installed</p>	\$195	Richmond Park
<p><b>FINISHED CENTER DRAWER</b></p>  <p>FACTORY INSTALLED</p>	K31	<p><b>Finished Center Drawer</b></p> <p>Veneer drawer front finished to match unit Veneer and color. Ball bearing smooth operation. Drawer has lifetime guarantee.</p> <ul style="list-style-type: none"> <li>• Standard with matching wood grain pencil tray</li> </ul>	\$195	All Office Park Products
<p><b>CENTER DRAWER WITH KNOBS</b></p>  <p>SPECIFY PULLS / FACTORY INSTALLED</p>	K31K	<p><b>Center Drawer With Knob Pulls</b></p> <p>Veneer drawer front finished to match unit veneer and color. Ball bearing smooth operation. Drawer has lifetime guarantee.</p> <ul style="list-style-type: none"> <li>• Standard with matching wood grain pencil tray</li> </ul>	\$225	All Office Park Products
<p><b>FELT BOTTOM CENTER DRAWER INSERT LINER</b></p>  <p>FACTORY INSTALLED</p>	K3	<p><b>Felt Bottom Center Drawer Insert Liner</b></p> <p>Inserts into center drawer and features divider for open pen and pencil storage. Removable for easy cleaning.</p> <p>Adds a luxurious touch to center drawers. Color: Dark Brown Coal</p>	\$95	All Office Park Products
<p><b>ROTATING UTILITY TRAY</b></p> 	K32	<p><b>Rotating Utility Tray</b></p> <p>Black Plastic Size: 13<sup>7</sup>/<sub>8</sub>" x 8<sup>3</sup>/<sub>8</sub>" Deep Holds 3" x 3" post it's and dispenses 1/2" to 3/4" scotch tape. General storage for pens, pencils, clips, coins, etc.</p> <p>Factory Installed</p>	\$75	All Office Park Products
<p><b>DESK BOX/BOX/FILE PEDESTAL WITH PULLOUT WRITING SHELF</b></p> 	P1A	<p><b>Desk Box/Box/File Pedestal w/ Pullout Writing Shelf</b></p> <ul style="list-style-type: none"> <li>• Laminate surface w/ solid wood front strip</li> <li>• Knob matches pull finish</li> <li>• Size: 14"W / Extends 15" Out</li> <li>• Not available on file/file pedestals</li> <li>• Only available on 30" / 36" desk pedestals</li> </ul>	\$195	Desks Only  N/A Levity Park
<p><b>WOOD DRAWERS</b></p> 	P33	<p><b>Wood Drawers (Any Size)</b></p> <ul style="list-style-type: none"> <li>• Dowel joint construction</li> <li>• Hardwood veneer multi-ply drawer</li> <li>• UV finish</li> <li>• 1/4" Wood veneer bottoms</li> <li>• File drawer bottoms are give block reinforced for heavy weight capacity</li> <li>• Lifetime guaranteed</li> </ul>	\$40 Per Drawer	All Office Park Products

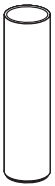
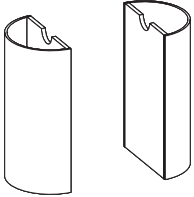
## CONFERENCE DESK SUPPORT POST OPTIONS

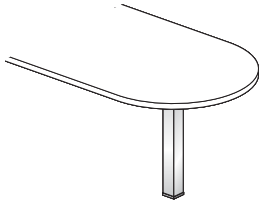
[\(GO TO INDEX\)](#)

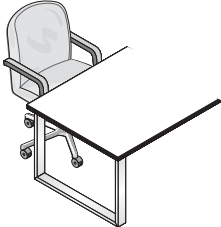
DESCRIPTION / ILLUSTRATION	OPTIONS CODE	SPECIFICATIONS	LIST UPCHARGE	MUST SELECT
<b>WOOD DRUM</b> 	<b>B6</b>  <b>B8</b>	<b>6" Dia. Wood Drum</b>  <b>8" Dia. Wood Drum</b> <ul style="list-style-type: none"> <li>• Available In Walnut / Cherry / Maple</li> <li>• Adjustable levelers</li> <li>• Replaces standard metal round legs</li> </ul>	<b>\$395</b>  <b>\$425</b>	Finish
<b>WOOD HALF DRUM</b> 	<b>HC08</b>  <b>HC16</b>	<b>8" Half Drum</b>  <b>16" Half Drum</b> <ul style="list-style-type: none"> <li>• Available In Walnut / Cherry / Maple</li> <li>• Adjustable levelers</li> </ul>	<b>\$695</b>  <b>\$895</b>	Finish
<b>TAPERED WOOD POST WITH METAL ACCENT COLLAR / TOE</b> 	<b>BTWPS</b> <b>BTWPB</b>	<b>Silver</b> <b>Black</b> <ul style="list-style-type: none"> <li>• Metal collar / toe available in silver &amp; matte black</li> <li>• Replaces standard metal round leg</li> </ul>	<b>\$395</b> <b>\$395</b>	Wood Finish  Collar / Toe: <ul style="list-style-type: none"> <li>• Silver</li> <li>• Black</li> </ul>
<b>METAL POST - SQUARE</b> 	<b>AL100P</b>	<b>Metal Post - Square</b> <ul style="list-style-type: none"> <li>• 3" x 3" Aluminum square extrusion</li> <li>• Leveler adjustment</li> <li>• Replaces standard round post only</li> </ul>	<b>N/C</b>	Silver Or Black
<b>METAL OVAL "T" BASE</b> 	<b>32MOTS</b>  <b>32MOTB</b>	<b>Silver</b>  <b>Black</b> <ul style="list-style-type: none"> <li>• Floor leveler adjustment</li> <li>• Replaces standard round post only</li> <li>• Oval post</li> </ul>	<b>\$595</b>  <b>\$595</b>	All Office Park Products
<b>METAL SLEIGH BASE</b> 	<b>27SLG</b>	<b>Anodized Silver Metal Sleigh Base</b> <ul style="list-style-type: none"> <li>• Aluminum / Anodized Silver</li> <li>• Leveler adjustment</li> <li>• 3" x 1" Aluminum extrusion</li> <li>• Leg recessed under top 1-1/2"</li> </ul>	<b>\$895</b>	All Office Park Products

**PEDESTAL MODIFICATIONS**

**(GO TO INDEX)**

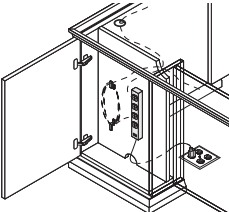
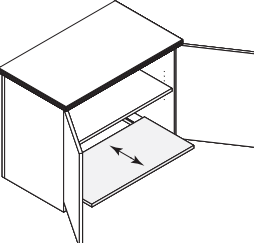
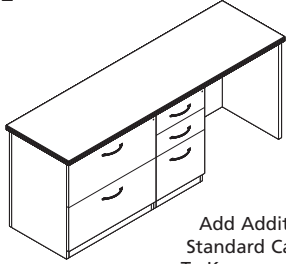
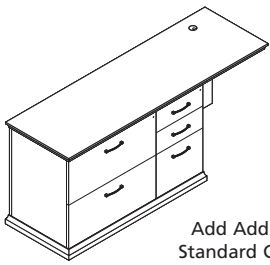
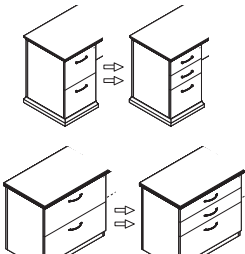
DESCRIPTION / ILLUSTRATION	OPTIONS CODE	SPECIFICATIONS	LIST UPCHARGE	COLLECTIONS AVAILABLE
<p><b>BREAKFRONT PEDESTAL WITH WIRE MANAGEMENT CAVITY DOOR</b></p> 	<p>PC10</p>	<p><b>Breakfront Pedestal Wire Mgmt. Door</b></p> <ul style="list-style-type: none"> <li>• Hinged pedestal front door offers easy access for wire management</li> <li>• Wire hooks provide wire coil storage</li> <li>• Wire access openings allow access to floor, cabinets interior and kneespace</li> <li>• Cabinet interior is black finish</li> <li>• Top grommet is positioned over cavity for access ease</li> </ul> <p>(Power Strip Optional)</p>	<p><b>\$95</b></p>	<p>All Office Park Products  <i>*NOTE*</i>                      Not Available In Richmond Park                       Breakfront Chassis Only</p>
<p><b>PULLOUT BOTTOM SHELF</b></p> 	<p>PPOS</p>	<p><b>Pullout Bottom Shelf</b></p> <ul style="list-style-type: none"> <li>• Black laminate pullout shelf on suspension</li> <li>• Back grommet</li> <li>• Adjustable Shelf</li> </ul>	<p><b>\$195</b></p>	<p>All Office Park Products</p>
<p><b>ADD KNEESPACE CABINETS - NO BASE</b></p>  <p>Add Additional Standard Cabinets To Kneespace Area.</p>	<p>P40 P41 P42 P43 P44</p>	<p><b>Add Box/Box/File or File/File</b>  <b>Add Lateral File 29"W</b>  <b>Add Multi-File - 31"W</b>                      (Specify Box/Box Left Or Right)  <b>Add Storage With Doors - 29"W</b>  <b>Add CPU / Printer Cabinet - Open</b>                      (Specify CPU Left Or Right)</p>	<p><b>\$795</b> <b>\$895</b> <b>\$995</b> <b>\$895</b> <b>\$895</b></p>	<p>All Office Park Products</p>
<p><b>ADD KNEESPACE CABINETS - BASE</b></p>  <p>Add Additional Standard Cabinets To Kneespace Area.</p>	<p>P40B P41B P42B P43B P44B</p>	<p><b>Add Box/Box/File or File/File</b>  <b>Add Lateral File 29"W</b>  <b>Add Multi-File - 31"W</b>                      (Specify Box/Box Left Or Right)  <b>Add Storage With Doors - 29"W</b>  <b>Add CPU / Printer Cabinet - Open</b>                      (Specify CPU Left Or Right)</p>	<p><b>\$895</b> <b>\$1095</b> <b>\$1095</b> <b>\$995</b> <b>\$995</b></p>	<p>All Office Park Products</p>
<p><b>MODIFY PEDESTAL DRAWER CONFIGURATION</b></p> 	<p>P6OP  P8OP</p>	<p><b>Modify File/File To Box/Box/File - Any Unit</b>  <b>Modify Lateral File To (2) Box Drawers</b></p>	<p><b>\$50</b>  <b>\$95</b></p>	<p>All Office Park Products</p>



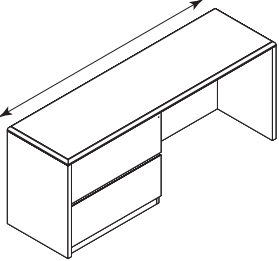
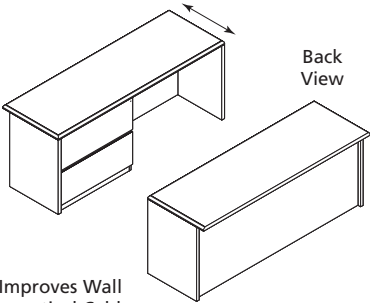
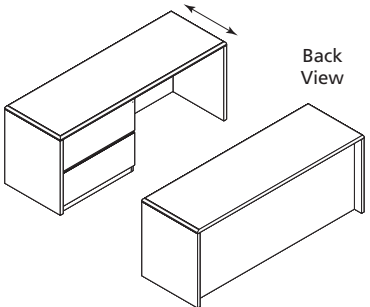
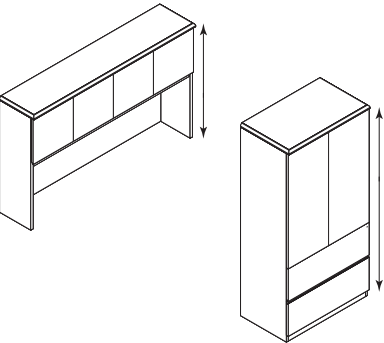

## UNIT WIDTH / HEIGHT MODIFICATIONS

**(GO TO INDEX)**

DESCRIPTION / ILLUSTRATION	OPTIONS CODE	SPECIFICATIONS	LIST UPCHARGE	COLLECTIONS AVAILABLE
<p><b>MODIFY WIDTHS</b></p> 	<p><b>MODWX</b></p>	<p><b>Modify Widths</b></p> <ul style="list-style-type: none"> <li>• Open kneespace required - All other units require engineering approval</li> <li>• Widths over 96" require approval</li> <li>• Quantity less than five is subject to setup charges</li> </ul> <p>Prices Vary Depending On Cabinets &amp; Unit Depths. Contact Factory For Prices.</p>	<p><b>Contact Factory</b></p>	<p>All Office Park Products</p>
<p><b>MODIFY 21" DEPTH CREENZA ONLY WITH BACK OVERHANG</b></p>  <p>Improves Wall Receptical Cable Clearance</p>	<p><b>MOD24DO</b> <b>MOD30DO</b></p>	<p>Modify to 24" or 30" depth w/ back overhang.</p> <p><b>24" Depth</b> <b>30" Depth</b></p> <p>Prices Vary Depending On Chassis Type &amp; Width. Contact Factory For Prices.</p>	<p><b>Contact Factory</b> <b>Contact Factory</b></p>	<p>All Office Park Products</p>
<p><b>MODIFY STANDARD 21" CASEGOOD TOP &amp; CHASSIS DEPTH TO 24" / 30"</b></p> 	<p><b>MOD24DS</b> <b>MOD30DS</b></p>	<p>Modify to 24" or 30" depth w/ standard back recess.</p> <p><b>24" Depth</b> <b>30" Depth</b></p> <p>Prices Vary Depending On Chassis Type &amp; Width. Contact Factory For Prices.</p>	<p><b>Contact Factory</b> <b>Contact Factory</b></p>	<p>All Office Park Products</p>
<p><b>MODIFY HEIGHTS</b></p> 	<p><b>MODHX</b></p>	<p><b>Modify Heights</b></p> <p>Due to the complexity of height adjustment, pricing requires engineering and cost input.</p> <p>Pricing By Quote Only</p>	<p><b>Quote Only</b></p>	<p>All Office Park Products</p>

COMPUTER SUPPORT OPTIONS

(GO TO INDEX)

DESCRIPTION / ILLUSTRATION	OPTIONS CODE	SPECIFICATIONS	LIST UPCHARGE	MUST SELECT
<p><b>SINGLE MONITOR ARM</b></p>  <p>POSTS / ARMS ASSEMBLY REQUIRED</p>	<p>MA1959</p>	<p><b>Single Monitor Arm</b></p> <ul style="list-style-type: none"> <li>• Post Base: 4-1/2" Dia.</li> <li>• Post Length: 20-7/8"H</li> <li>• Arm Extends 10-1/2"</li> <li>• Rotates Left / Right 180°</li> <li>• Tilts Screen 85°</li> <li>• Silver Powdercoat</li> <li>• Post Base Requires 60mm Dia. Hole</li> <li>• Arm: Die Cast Aluminum</li> </ul>	<p>\$395</p>	<p>Surface Factory Bored / Ready To Install</p>
<p><b>DOUBLE MONITOR ARM</b></p>  <p>POSTS / ARMS ASSEMBLY REQUIRED</p>	<p>MA2959</p>	<p><b>Double Monitor Arm</b></p> <ul style="list-style-type: none"> <li>• Post Base: 4-1/2" Dia.</li> <li>• Post Length: 20-7/8"H</li> <li>• Arm Extends 10-1/2"</li> <li>• Rotates Left / Right 180°</li> <li>• Tilts Screen 85°</li> <li>• Silver Powdercoat</li> <li>• Post Base Requires 60mm Dia. Hole</li> <li>• Arm: Die Cast Aluminum</li> </ul> <p><i>Can Accommodate Up To 4 Monitors By Ordering Extra Double Arms.</i></p>	<p>\$650</p>	<p>Surface Factory Bored / Ready To Install</p>
<p><b>DELUXE SINGLE MONITOR ARM W/ USB POST</b></p>  <p>POSTS / ARMS ASSEMBLY REQUIRED</p>	<p>MA1952</p>	<p><b>Deluxe Single Monitor Arm</b></p> <ul style="list-style-type: none"> <li>• (4) 2.0 USB Ports</li> <li>• Post Length: 22-1/2"H</li> <li>• Post Base Requires 80mm Dia. Hole</li> <li>• Spring Assist - Full Movement Arm</li> <li>• Supports Screens Up To 24"</li> <li>• Arm: Die Cast Aluminum</li> <li>• Arm Extends Up To 13-3/8"</li> <li>• Swivels 180° - Mount Plate Tilts 85°</li> </ul>	<p>\$495</p>	<p>Surface Factory Bored / Ready To Install</p>
<p><b>DELUXE DOUBLE MONITOR ARM W/ USB POST</b></p>  <p>POSTS / ARMS ASSEMBLY REQUIRED</p>	<p>MA2952</p>	<p><b>Deluxe Single Monitor Arm</b></p> <ul style="list-style-type: none"> <li>• (4) 2.0 USB Ports</li> <li>• Post Length: 22-1/2"H</li> <li>• Post Base Requires 80mm Dia. Hole</li> <li>• Spring Assist - Full Movement Arm</li> <li>• Supports Screens Up To 24"</li> <li>• Arm: Die Cast Aluminum</li> <li>• Arm Extends Up To 13-3/8"</li> <li>• Swivels 180° - Mount Plate Tilts 85°</li> </ul> <p><i>Can Accommodate Up To 4 Monitors By Ordering Extra Double Arms.</i></p>	<p>\$795</p>	<p>Surface Factory Bored / Ready To Install</p>





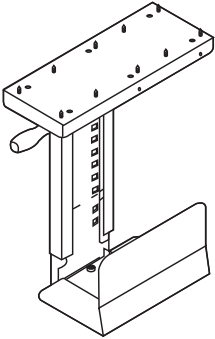
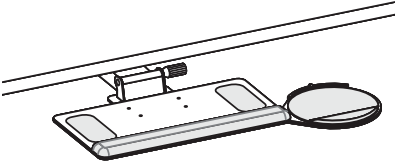

## COMPUTER SUPPORT OPTIONS

**(GO TO INDEX)**

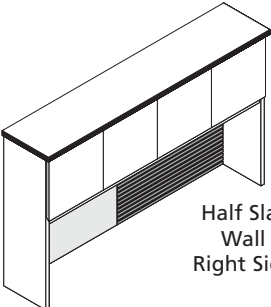
DESCRIPTION / ILLUSTRATION	OPTIONS CODE	SPECIFICATIONS	LIST UPCHARGE	COLLECTIONS AVAILABLE
<b>CPU RETRACTABLE CRADLE</b>  	K18	<b>CPU Retractable Cradle</b>  Black Metal CPU Carriage  <ul style="list-style-type: none"> <li>• Full 360° swivel capability allows easy access to rear of CPU for cables / wires.</li> <li>• Track allows 8-1/2" extension</li> <li>• Width adjustment 5-1/2" to 9-1/4"</li> <li>• Height adjustment 14-5/8" to 20-1/2"</li> <li>• Black epoxy finish</li> </ul>	<b>\$195</b>	All Office Park Products  Factory Installed
<b>ARTICULATING KEYBOARD TRAY</b>  	K28	<b>Articulating Keyboard w/Left or Right Mouse</b> <b>FACTORY INSTALLED</b> <ul style="list-style-type: none"> <li>• Adjusts effortlessly - A simple one-handed motion allows the keyboard to be repositioned instantly, without the use of locks or levers.</li> <li>• Encourages low-risk postures - Maximizes adjustability within a safe operating range.</li> <li>• Will last a lifetime - Exceeds all applicable BIFMA Standards and comes with a lifetime guarantee.</li> </ul>	<b>\$425</b>	All Office Park Products  Factory Installed
<b>CUSTOMER'S OWN KEYBOARD</b>	K00	<b>Customer's Own Keyboard (Factory Installed)</b> <b>FACTORY INSTALLED</b> (Contact Factory For Pricing)		

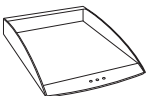
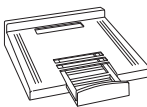

CONSOLE TASK BACK - SLAT WALL ACCESSORIES

(GO TO INDEX)

DESCRIPTION / ILLUSTRATION	OPTIONS CODE	SPECIFICATIONS	LIST UPCHARGE	MUST SPECIFY
<p><b>SLAT WALL PANEL</b></p>  <p>Half Slat Wall Right Side</p>  <p>Half Slat Wall Left Side</p> <p>Specify Silver Or Black Color</p>	<p><b>SW420P</b></p>	<ul style="list-style-type: none"> <li>• Available in silver or black</li> <li>• Can be combined w/ fabric tack panel or white dry marker board</li> <li>• For use on 42"/43" height consoles</li> </ul> <p>Specify Full Width In Inches _____" x \$5 per 1"W</p> <p>See Standard Fabric Tack Panels &amp; Dry Marker Panels In Product Sections.</p>		<p>Specify Black Or Silver</p> <p>Specify Left Or Right Position</p>
<p><b>SLAT WALL PAPER TRAY</b></p> 	<p><b>SWA2</b></p>	<p><b>Slat Wall Paper Tray</b></p> <p>Specify Black Or Matte Silver</p>	<p><b>\$35</b></p>	
<p><b>SLAT WALL TELEPHONE HOLDER</b></p> 	<p><b>SWA3</b></p>	<p><b>Slat Wall Telephone Holder</b></p> <p>Specify Black Or Matte Silver</p>	<p><b>\$35</b></p>	
<p><b>SLAT WALL PENCIL HOLDER</b></p> 	<p><b>SWA4</b></p>	<p><b>Slat Wall Pencil Holder</b></p> <p>Specify Black Or Matte Silver</p>	<p><b>\$25</b></p>	
<p><b>SLAT WALL CD HOLDER</b></p> 	<p><b>SWA5</b></p>	<p><b>Slat Wall CD Holder</b></p> <p>Specify Black Or Matte Silver</p>	<p><b>\$25</b></p>	
<p><b>SLAT WALL FOLDER TRAY</b></p> 	<p><b>SWA7</b></p>	<p><b>Slat Wall Folder Tray</b></p> <p>Specify Black Or Matte Silver</p>	<p><b>\$45</b></p>	
<p><b>SLAT WALL ACCESSORY TRAY</b></p> 	<p><b>SWA9</b></p>	<p><b>Slat Wall Accessory Tray</b></p> <p>Specify Black Or Matte Silver</p>	<p><b>\$45</b></p>	

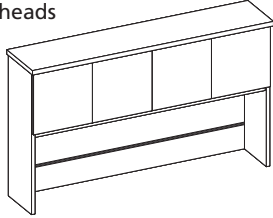
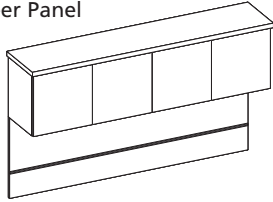
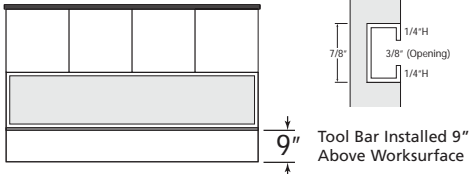
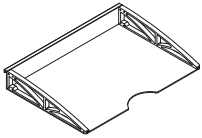
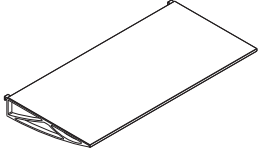
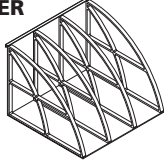
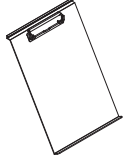
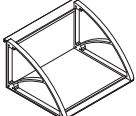

## OVERHEAD / WALL HUNG ACCESSORIES

**(GO TO INDEX)**

DESCRIPTION / ILLUSTRATION	OPTIONS CODE	SPECIFICATIONS	LIST UPCHARGE	MUST SPECIFY
<p><b>RECESSED ALUMINUM TOOL CHANNEL</b></p> <p>Overheads</p>  <p>Wall Hung Veneer Panel</p> 	<p><b>ATB02</b></p> <p><b>FTOC15</b> <b>FTOC16</b> <b>FTOC17</b> <b>FTOC18</b> <b>FTOC19</b></p>	<ul style="list-style-type: none"> <li>Anodized aluminum finish</li> <li>Fully recessed</li> <li>Finish matches anodized aluminum accessories</li> <li>Can be specified with fabric tack surface mounted above channel</li> </ul>  <p>Specify Full Width In Inches _____" x</p> <p><b>TACKBOARD 15"H (Specify full width in inches)</b></p> <p>Office Park Tackboard Fabric _____" x <b>\$3</b> per inch</p> <p>Design-Build Tackboard Fabric _____" x <b>\$4</b> per inch</p> <p>DARRAN Seating Fabric Grade 1-3 _____" x <b>\$5</b> per inch</p> <p>DARRAN Seating Fabric Grade 4-6 _____" x <b>\$6</b> per inch</p> <p>DARRAN Seating Fabric Grade 7-10 _____" x <b>\$7</b> per inch</p> <ul style="list-style-type: none"> <li>Half panel must indicate location left or right when full width tool channel is specified.</li> <li>For combination with dry marker board, specify each separately with left/right location.</li> </ul>	<p><b>\$5</b> per 1"W</p>	<p>Left Or Right Locations</p>
<p><b>PAPER TRAY</b></p> 	<p><b>ATB10</b></p>	<p><b>Solid Aluminum - Anodized Finish</b></p> <p>Width: 326mm Depth: 224mm Height: 44mm</p>	<p><b>\$60</b></p>	
<p><b>SHELF</b></p> 	<p><b>ATB12</b></p>	<p><b>Solid Aluminum - Anodized Finish</b></p> <p>Width: 450mm Depth: 222mm Height: 43mm</p>	<p><b>\$60</b></p>	
<p><b>BINDER HOLDER</b></p> 	<p><b>ATB14</b></p>	<p><b>Solid Aluminum - Anodized Finish</b></p> <p>Width: 270mm Depth: 252mm Height: 201mm</p>	<p><b>\$195</b></p>	
<p><b>COPY HOLDER</b></p> 	<p><b>ATB16</b></p>	<p><b>Solid Aluminum - Anodized Finish</b></p> <p>Width: 226mm Height: 312mm</p>	<p><b>\$60</b></p>	
<p><b>CD HOLDER</b></p> 	<p><b>ATB18</b></p>	<p><b>Solid Aluminum - Anodized Finish</b></p> <p>Width: 190mm Depth: 155mm Height: 109mm</p>	<p><b>\$60</b></p>	
<p><b>PEN / HEADPHONE HOLDER</b></p> 	<p><b>ATB20</b></p>	<p><b>Solid Aluminum - Anodized Finish</b></p> <p>Width: 85mm Depth: 62mm Height: 97mm</p>	<p><b>\$60</b></p>	

POWER / DATA OPTIONS

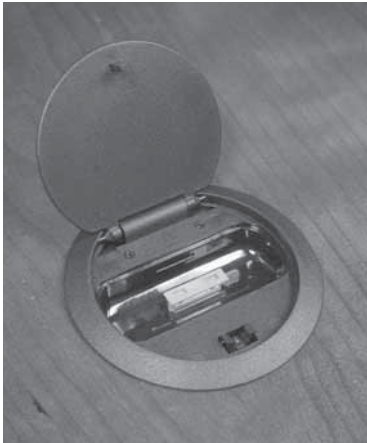
(GO TO INDEX)

DESCRIPTION / ILLUSTRATION	OPTIONS CODE	SPECIFICATIONS	LIST UPCHARGE	MUST SELECT
<p><b>POP-UP POWER STATION</b></p>  <p>FACTORY INSTALLED SPECIFY LOCATION</p>	<p><b>PD280</b></p>	<p><b>Pop-Up Power Station</b></p> <ul style="list-style-type: none"> <li>• (3) AC 125V - 12A Outlets</li> <li>• 3" Dia. hole required</li> <li>• Requires 12" space below mounting surface</li> <li>• 6' 14amp power cord</li> <li>• Black finish</li> </ul>	<p><b>\$150</b></p>	<p>Factory Installed</p>
<p><b>"i" DOCKING STATION</b></p>  <p>FACTORY INSTALLED SPECIFY LOCATION</p>	<p><b>PD300</b></p>	<p><b>"i" Docking Station</b></p> <p>Universal dock for ipod / iphone w/ video out / audio out and dual charging options.</p> <ul style="list-style-type: none"> <li>• Apple certified</li> <li>• Synchronized with PC / MAC</li> <li>• iPod / iPhone audio/video output for amplifier / monitor</li> <li>• Charges while docked</li> <li>• Pop-Up lid</li> <li>• 100 - 240V AC/DC adapter</li> <li>• 8' audio / video cable</li> <li>• 8' USB cable</li> <li>• Black finish</li> <li>• 3-1/2" Diameter</li> </ul>	<p><b>\$195</b></p>	<p>Factory Installed</p>
<p><b>MULTI-DOCKING STATION</b></p>  <p>FACTORY INSTALLED SPECIFY LOCATION</p>	<p><b>PD310</b></p>	<p><b>Multi-Docking Station</b></p> <p>Central location dock to plug and download files directly to your computer from iphones, MP3 players and digital cameras.</p> <ul style="list-style-type: none"> <li>• (3) USB 2.0 Ports - Type A</li> <li>• (2) Card reader for SD / SDHC / MMC, MS Pro / Duo slots</li> <li>• (2) External jacks 3.5mm headphone &amp; microphone</li> <li>• 100 - 240V AC/DC 2A adapter</li> <li>• 6' Digital cable</li> <li>• 3-1/2" Diameter</li> <li>• Black finish</li> </ul>	<p><b>\$195</b></p>	<p>Factory Installed</p>

**POWER / DATA OPTIONS**

**(GO TO INDEX)**

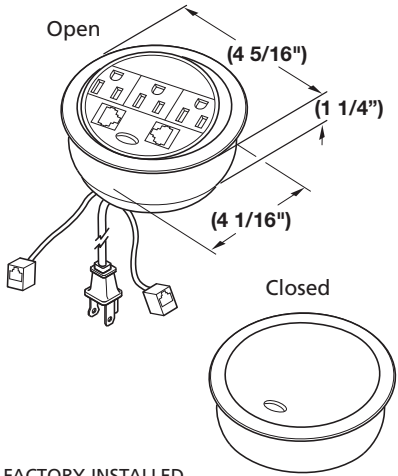
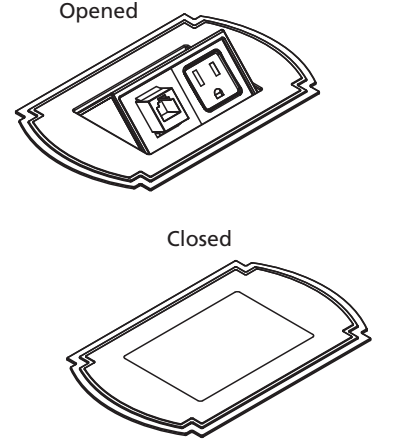
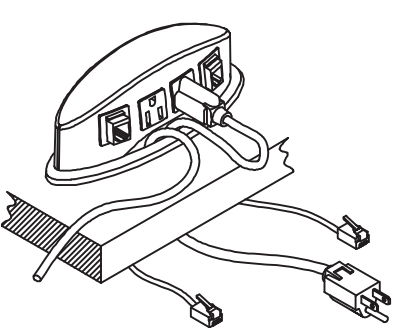
DESCRIPTION / ILLUSTRATION	OPTIONS CODE	SPECIFICATIONS	LIST UPCHARGE	MUST SELECT
<p><b>ROUND / FLIP-UP - POWER / DATA CENTER</b></p>  <p>Open</p> <p>Closed</p> <p>FACTORY INSTALLED SPECIFY LOCATION</p>	<p>PDFUR</p>	<p><b>Round / Flip-Up - Power / Data Center</b></p> <p>SIZE: 4-5/16" Dia. x 1-1/4" H</p> <ul style="list-style-type: none"> <li>• (3) Grounded outlets (12A / 125V)</li> <li>• (2) Universal data modules accommodates RJ-11 or RJ-45</li> <li>• 10 Foot power cord</li> <li>• UL Listed</li> <li>• Black plastic casing operates smoothly and locks into position</li> </ul>	<p><b>\$395</b></p>	<p>Specify Connector</p> <p>Specify Location</p>
<p><b>FLIP-UP TRADITIONAL PORT</b></p>  <p>Opened</p> <p>Closed</p> <p>RECOMMENDED FOR CAPITOL PARK &amp; RICHMOND PARK</p>	<p>PDFUT</p>	<p><b>Flip-Up Traditional Port</b></p> <p>SIZE: 6.75" L x 4.25" W x 1.25" H</p> <ul style="list-style-type: none"> <li>• Fluid one touch accessibility</li> <li>• (1) Data/Comm Connector w/ 6' Cord</li> <li>• Choice of RJ-11 or RJ-45 (Factory Installed)</li> <li>• UL Listed</li> </ul> <p>Available In: Antique Brass, Satin Nickel or Midnight Black Finishes</p> <p>MUST SPECIFY FINISH</p>	<p><b>\$695</b></p>	<p>Finish</p> <p>Specify Location</p>
<p><b>ELLIPTICAL MULTI-PORT SURFACE MOUNT</b></p>  <p>NOTE: Elliptical multi port is fixed and does not retract.</p> <p>FACTORY INSTALLED SPECIFY LOCATION</p>	<p>PDEP</p> <p>RJ11C</p> <p>RJ45C</p>	<p><b>Elliptical Multi-Port Surface Mount Silver Soft Touch Finish</b></p> <p>SIZE: 7-58" L x 2-1/4" W x 2-3/4" H</p> <p>(2) 15 Amp receptacles with 10' cord (2) Voice/Data Ports - Open for customer supplied connectors</p> <p>Available Factory Installed Voice/data connectors only. Select (2)</p> <p><b>RJ-11 Connector (Factory Installed)</b></p> <p><b>RJ-45 Connector (Factory Installed)</b></p> <p>Available on: Top Surfaces</p>	<p><b>\$250</b></p> <p><b>\$35 ea</b></p> <p><b>\$35 ea</b></p>	<p>Connector</p> <p>Undertop wire mgmt base / trough or channel</p> <p>Location</p>

POWER / DATA OPTIONS

(GO TO INDEX)

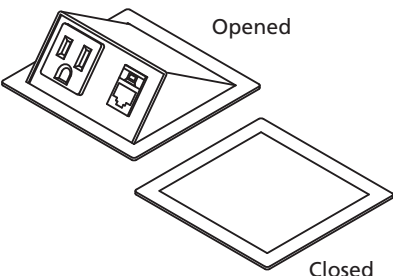
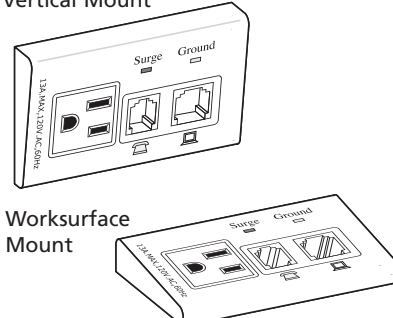
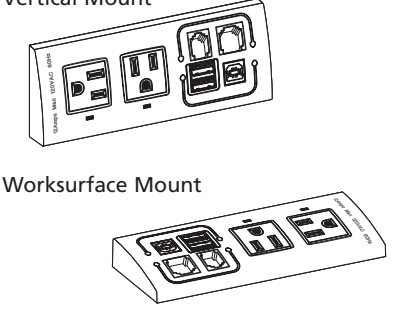
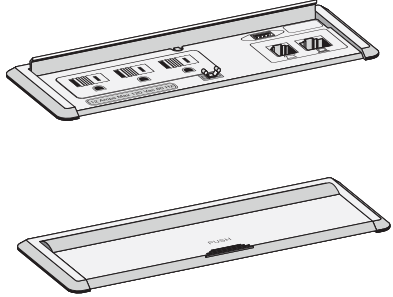
DESCRIPTION / ILLUSTRATION	OPTIONS CODE	SPECIFICATIONS	LIST UPCHARGE	MUST SELECT
<p><b>FLIP-UP SINGLE PORT</b> Worksurface Mount Only</p>  <p>Opened</p> <p>Closed</p> <p>Must be open while in use FACTORY INSTALLED SPECIFY LOCATION</p>	<p>PDFUS PDFUB</p>	<p><b>Flip Up Single Port</b></p> <p><b>Anodized Silver Powdercoat Finish</b></p> <p><b>Black Powdercoat Finish</b></p> <p>SIZE: 3.5"L x 3.67"W x 1.3"H (Open)</p> <p>(1) 15 Amp receptacle w/ 6' Cord Hardwire N/A</p> <p>(1) Data/Comm Connector w/ 6' Cord Choice of RJ-11 or RJ-45 (Factory Installed)</p> <p>Available on: Top Surface</p>	<p>\$695 \$645</p>	<p>Finish</p> <p>Undertop wire mgmt base / trough or channel</p> <p>Specify Connector</p> <p>Surface Location</p>
<p><b>FIXED SINGLE PORT</b> Vertical Mount</p>  <p>Worksurface Mount</p> <p>FACTORY INSTALLED SPECIFY LOCATION</p>	<p>PDFL1 FLBM1</p>	<p><b>Fixed Single Port</b></p> <p><b>Vertical Mount</b></p> <p><b>Undersurface Bracket Mount</b></p> <p>SIZE: 3.44"L x 2.13"W x 5/8"H Hardwire N/A</p> <p>(1) 12 Amp receptacle w/ 10' Cord</p> <p>(1) RJ-11 Connector - Installed</p> <p>(1) RJ-45 Connector - Installed</p> <p>Black Finish</p> <p>Available on: Vertical Panels, Top Surface, and Apron Rails or Bracket Mount</p>	<p>\$175 \$195</p>	<p>Location</p>
<p><b>FIXED MULTI-PORT</b> Vertical Mount</p>  <p>Worksurface Mount</p> <p>FACTORY INSTALLED SPECIFY LOCATION</p>	<p>PDFL2 FLBM2</p>	<p><b>Fixed Multi-Port</b></p> <p><b>Vertical Mount</b></p> <p><b>Undersurface Bracket Mount</b></p> <p>SIZE: 5.43"L x 2.13"W x 5/8"H Hardwire N/A</p> <p>(2) 12 Amp receptacle w/ 10' Cord</p> <p>(1) RJ-11 Connector</p> <p>(1) RJ-45 Connector</p> <p>(2) USB Ports</p> <p>Black Finish</p> <p>Available on: Vertical Panels, Top Surface, and Apron Rails or Bracket Mount</p>	<p>\$195 \$225</p>	<p>Surface Location</p>
<p><b>POCKET DOOR- MULTI-PORT</b> <b>WORKSURFACE MOUNT ONLY</b></p>  <p>FACTORY INSTALLED SPECIFY LOCATION</p>	<p>PDPD2</p>	<p><b>Pocket Door Multi-Port</b></p> <p>SIZE: 7-5/8"L x 2-3/4"W x 5/8"H (Open) Hardwire N/A</p> <p>(3) 12 Amp receptacle w/ 10' Cord</p> <p>(1) RJ-11 Connector</p> <p>(1) RJ-45 Connector</p> <p>(2) USB Telecom Ports</p> <p>Black Finish</p> <p>Available on: Top Surfaces Only</p>	<p>\$295</p>	<p>Undertop wire mgmt base / trough or channel</p> <p>Surface Location</p>







**POWER / DATA OPTIONS**

**(GO TO INDEX)**

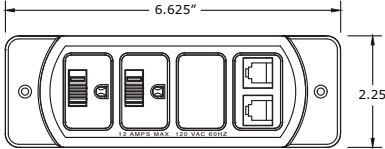
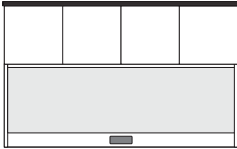
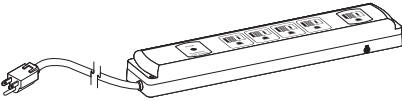
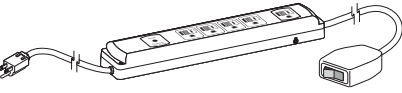
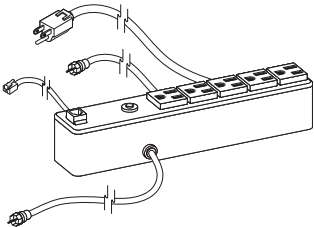
DESCRIPTION / ILLUSTRATION	OPTIONS CODE	SPECIFICATIONS	LIST UPCHARGE	MUST SELECT
<p><b>OVERHEAD BACK PANEL POWER / DATA / COMMUNICATION CONTROL PANEL</b></p>  <p>Black Finish</p>	<p><b>PD225</b></p>	<p><b>Overhead Control Panel</b></p> <ul style="list-style-type: none"> <li>• (2) Grounded 12 AMP Receptacles</li> <li>• 10' Power Cord (14-3)</li> <li>• Internet / Phone Connections</li> <li>• Recessed Into Back Cutout</li> </ul>  <p>Optional Fabric Tack Surface Mounts Above Control Panel</p>	<p><b>\$195</b></p>	<p>Overhead Back Panels</p> <p>Wall Hung Veneer Panels</p> <p>Storage Back Panels</p>
<p><b>POWER SUPPLY CORDSET</b></p>  <p>FACTORY INSTALLED SPECIFY LOCATION</p>	<p><b>PD717</b></p>	<p><b>Power Supply Cordset</b></p> <p>SIZE: 10.75"L x 2.0"W x 1.06"H</p> <ul style="list-style-type: none"> <li>• (5) Outlets w/ 10' cord</li> <li>• Surge suppression (720 Joules)</li> <li>• 15 Amp breaker</li> </ul> <p>Available on: Vertical Panels, Cabinet Interiors, and under tops</p>	<p><b>\$95</b></p>	<p>Location</p>
<p><b>POWER SUPPLY CORDSET WITH REMOTE ON/OFF</b></p>  <p>FACTORY INSTALLED SPECIFY LOCATION</p>	<p><b>PD718</b></p>	<p><b>Power Supply Cordset With Remote</b></p> <p>SIZE: 10.75"L x 2.0"W x 1.125"H</p> <ul style="list-style-type: none"> <li>• (5) Outlets w/ 10' cord</li> <li>• Surge suppression (720 Joules)</li> <li>• 15 Amp breaker</li> <li>• 36" Remote on/off rocker switch</li> </ul> <p>Available on: Vertical Panels, Cabinet Interiors, and under tops</p>	<p><b>\$110</b></p>	<p>Location</p>
<p><b>POWER/COM/VIDEO CORDSET</b></p>  <p>FACTORY INSTALLED SPECIFY LOCATION</p>	<p><b>PD222</b></p>	<p><b>POWER / COMMUNICATIONS/ VIDEO CORDSET</b></p> <p>SIZE: 9.5"L x 1.875"W x 1.8125"H</p> <ul style="list-style-type: none"> <li>• 5 Outlets w/ 10' Cord</li> <li>• RJ-11 Phone connector w/ 14' cord</li> <li>• Coaxial Cable - 7' Cord</li> <li>• 13 Amp Breaker</li> <li>• Surge Suppression (720 Joules)</li> </ul> <p>Available on: Vertical Panels, Cabinet Interiors, and under tops</p>	<p><b>\$125</b></p>	<p>Location</p>

## WIRE MANAGEMENT OPTIONS

**(GO TO INDEX)**

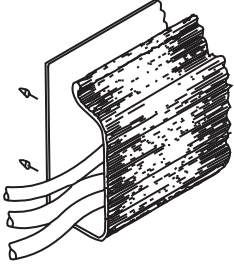
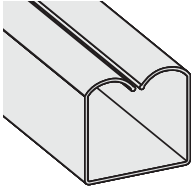
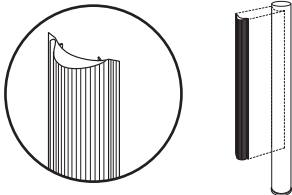
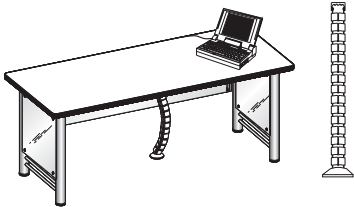
DESCRIPTION / ILLUSTRATION	OPTIONS CODE	SPECIFICATIONS	LIST UPCHARGE	MUST SELECT
<b>HORIZONTAL J-CHANNEL WIRE MANAGEMENT RACEWAY</b> 	W1	<b>Horizontal J-Channel Wire Management Raceway</b> 4' section for field installation.  The "J" shape black thermoplastic wire raceway may be added to specified worksurface tops to provide concealed channeling of wires to and from worksurface grommets. For use in open kneespace areas, raceway is attachable to top of back panel with pan head screws. Interior dimensions are 1" x 1½" providing ample storage for multiple wires and excess cable. Front of raceway flexes out for easy cord insertion.	\$75 Per 4 Foot Section	Note: Units w/ Wire Channel Standard.  Field Installation
<b>HORIZONTAL U-CHANNEL WIRE MANAGEMENT RACEWAY</b> 	W2A	<b>Horizontal U-Channel Wire Management Raceway</b> 4' section for field installation.	\$75 Per 4 Foot Section	Note: Units w/ Wire Channel Standard.  Field Installation
<b>VERTICAL WIRE MANAGEMENT RACEWAY FOR ROUND TABLE LEGS</b> 	W13	<b>Vertical Wire Management Raceway For Round Table Legs</b>  25" length curved raceway conforms to metal or wood legs for wire management. Conforms to round legs from 3" to 30" in diameter. Black plastic raceway with vertical grooves, has high strength adhesive for attachment. (Available: Black Only)  Factory Installed	\$35 Per Piece	Location
<b>VERTEBRA - ROUND</b> 	W16	<b>Vertebra - Round</b>  Weighted Base, Table attachment plate 39-1/2" Length Black	\$95	Location

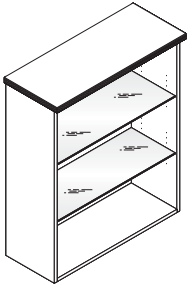
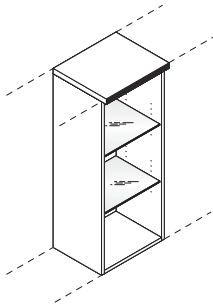
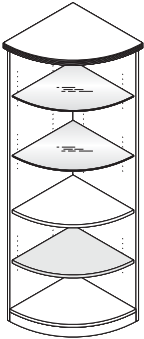
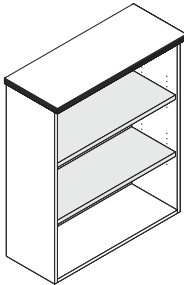

**TASKING / DISPLAY OPTIONS**

**(GO TO INDEX)**

DESCRIPTION / ILLUSTRATION	OPTIONS CODE	SPECIFICATIONS	LIST UPCHARGE	COLLECTIONS AVAILABLE
<p><b>GLASS SHELVES - TEMPERED FULL WIDTH 26" - 35"</b></p> 	<p>GS14F GS21F</p>	<p><b>Glass Shelves - Tempered</b> Glass Shelves Replace Wood Shelf In Open Or Glass Door Cabinet. Also Order Interior Cabinet Lighting.</p> <p><b>Full Width Glass Shelf 26"W - 35"W x 14"D</b> <b>Full Width Glass Shelf 26"W - 35"W x 21"D</b></p>	<p><b>\$85</b> <b>\$95</b></p>	<p>All Office Park Products</p>
<p><b>TEMPERED GLASS SHELVES FOR HALF CABINET 17-1/2" WIDTHS</b></p> 	<p>GS14H GS21H</p>	<p><b>Half Width Glass Shelf 14-1/2"W - 17-1/2"W x 14"D</b> <b>Half Width Glass Shelf 14-1/2"W - 17-1/2"W x 21"D</b></p> <p><b>*NOTE:</b> Replace only adjustable shelves between cabinet light and fixed lower wood shelf.</p>	<p><b>\$65 ea.</b> <b>\$75 ea.</b></p>	<p>All Office Park Products</p>
<p><b>CURVED CORNER GLASS SHELVES</b></p> 	<p>GS14CC GS21CC</p>	<p><b>For Cabinets 14" D and Curved Corners 15"D</b> <b>For Cabinets 21"D and Curved Corner 21"D</b></p> <p>Curved shelves feature glass retainer clips to prevent tipping.</p> <p><b>*NOTE:</b> Replace only adjustable shelves between cabinet light and fixed lower wood shelf.</p>	<p><b>\$85 ea.</b> <b>\$95 ea.</b></p>	<p>All Office Park Products</p>
<p><b>HEAVY DUTY SOLID WOOD BOOKCASE REPLACEMENT SHELVES</b></p> 	<p>S714F S721F S714FX S721FX</p>	<p><b>Heavy Duty Solid Wood Bookcase Replacement Shelves</b> 1" Solid Lumber Core Shelves Replace Standard 3/4" Plywood Adjustable And Fixed Shelves.</p> <p><b>1" Wood Shelf 14" Deep</b> <b>1" Wood Shelf 21" Deep</b> <b>Extra 14" Deep Shelves (Non-Replacement)</b> <b>Extra 21" Deep Shelves (Non-Replacement)</b></p>	<p><b>\$75 Each</b> <b>\$95 Each</b> <b>\$150 Each</b> <b>\$195 Each</b></p>	<p>All Office Park Products</p>

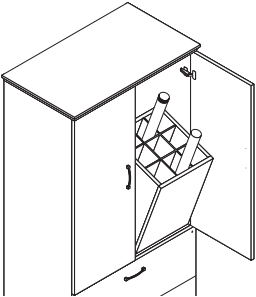

## MISCELLANEOUS OPTIONS

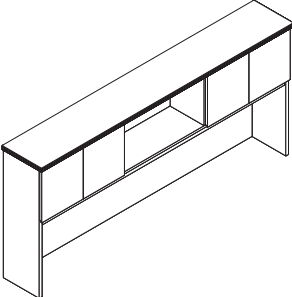
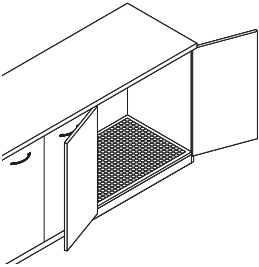
**(GO TO INDEX)**

DESCRIPTION / ILLUSTRATION	OPTIONS CODE	SPECIFICATIONS	LIST UPCHARGE	COLLECTIONS AVAILABLE
<p><b>BLUEPRINT TILT-OUT STORAGE</b></p>  <p>Available Only On 36"W Vertical File Wardrobe Tower</p>	BP1A	<p><b>Blueprint Tilt-Out Storage</b></p> <ul style="list-style-type: none"> <li>• Black laminate cabinet w/ silver grid storage dividers.</li> <li>• Pneumatic tilt action allows smooth control and movement.</li> </ul>	\$295	<p>All Office Park Products</p> <p>Factory Installed</p>
<p><b>SLOW CLOSE DOOR CLOSER</b></p> 	D9SC	<p><b>Slow Close Door Closer</b></p> <ul style="list-style-type: none"> <li>• Snap onto standard door hinge</li> <li>• Requires (1) per door</li> <li>• Max door height 43"</li> <li>• Factory installed where specified</li> <li>• Individually shipped for field installation</li> </ul> 	\$15 Per Door	<p>Specify Each Item To Have Slow Close Feature</p>
<p><b>DELETE DOORS</b></p> 	D6	<p><b>Delete Doors</b></p> <p>Standard Door overheads and cabinets can have door deleted for open access. Modification of hinge rails and structural components are made face ready.</p>	N/C	<p>All Office Park Products</p>
<p><b>REFRIGERATOR CABINET MODIFICATION</b></p> 	REF01	<p><b>Modify Storage Cabinets On 24" Deep Units For Refrigerator Install</b></p> <p>Features:</p> <ul style="list-style-type: none"> <li>•Open back</li> <li>•Moisture sponge mat</li> <li>•Containment Ledge</li> </ul> <p>Available on: Storage Credenza</p> <p>Contact customer service for maximum refrigerator size.</p>	\$195	<p>All Office Park Products</p>

MISCELLANEOUS OPTIONS

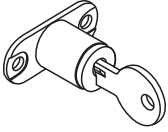
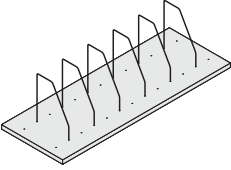
(GO TO INDEX)

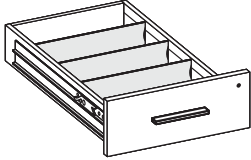
DESCRIPTION / ILLUSTRATION	OPTIONS CODE	SPECIFICATIONS	LIST UPCHARGE	COLLECTIONS AVAILABLE
<p><b>DOOR LOCKS / WOOD DOORS</b></p> 	<p><b>D2</b></p>	<p><b>Door Locks - 1 Door w/ Lock, Other Door w/ Catch Latch</b></p> <p>Available On Wood Panel &amp; Wood Frame Doors Only. Contact Customer Service regarding limited lock locations and keying.</p>	<p><b>\$95</b></p>	<p>All Office Park Products</p>
<p><b>EXTRA WIRE DIVIDERS</b></p> 	<p><b>S13</b></p>	<p><b>Extra Wire Dividers - Set Of Six</b></p> <p>Silver Finish</p>	<p><b>\$95</b></p>	<p>All Office Park Products</p>
<p><b>FURNITURE POLISH</b></p> 	<p><b>POL1 POS2</b></p>	<p><b>Furniture Polish</b></p> <p><b>8 Ounce Polish 16 Ounce Polish</b></p> <p>For Larger Quantities Contact Factory. Polish is non-silicone / non-oil polish safe for most lacquer and varnish coatings. Helps prevent light surface scratches commonly found with normal use. <b>Polish shipped via UPS</b></p>	<p><b>\$10 NET \$18 NET</b></p>	<p>All Office Park Products</p>
<p><b>BOX DRAWER ACCESSORIES</b></p> 	<p><b>K-DIV</b></p>	<p><b>Extra Wood Drawer Dividers with Clips</b></p> <p>Top Box drawers standard with 1 divider.</p>	<p><b>SET OF 3 \$30</b></p>	<p>All Office Park Products</p>