



PREMIER®

Contracted Supplier

Casegoods price list

# Boss price list

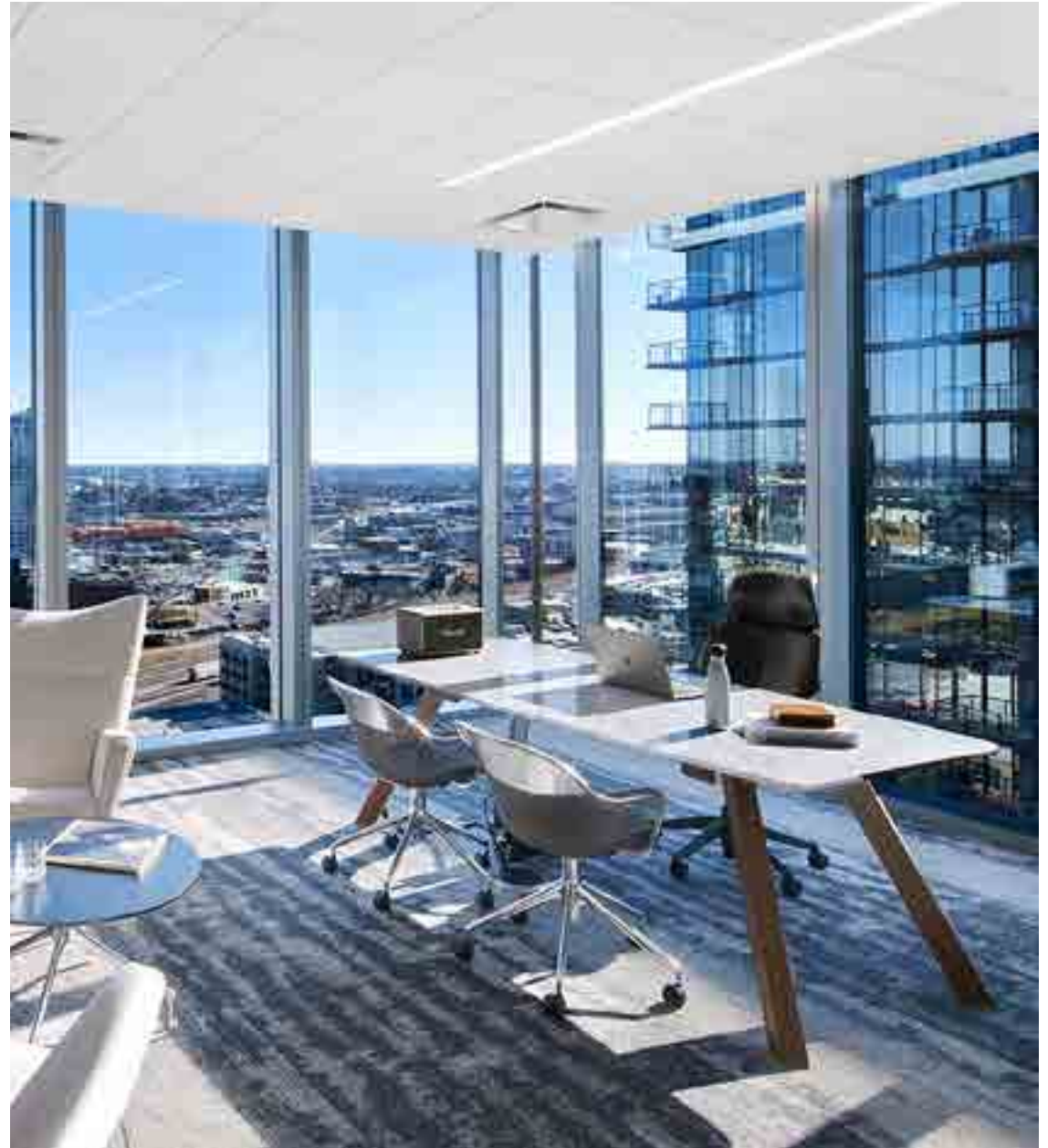

effective july 1, 2021

## Boss table of contents

Statement of Line	
Features & Advantages .....	1
Finishes.....	3
Edges   Pulls   Knobs.....	4
Grommets   Grommet Reference.....	5
Modesty Reference   Grain Direction .....	6
Drawer Dimensions   Filing Reference.....	7
Conferencing Credenzas.....	8
Boat Conference Tables.....	11
Table Frames.....	14
Wall Hung Overheads .....	15
Options.....	17
Power & Data .....	23

# Boss statement of line

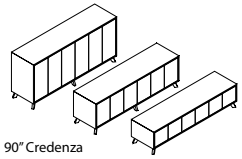

90° Credenza  
PAGE 8  
Conferencing Credenzas

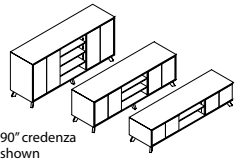

90° credenza shown  
PAGE 9  
Conferencing Credenzas

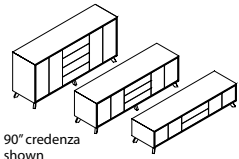

90° credenza shown  
PAGE 10  
Conferencing Credenzas

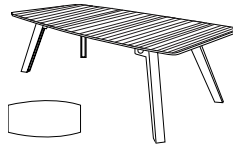

PAGE 11  
Boat Conference Tables

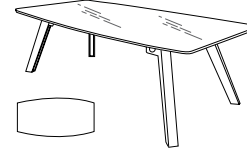

PAGE 12  
Boat Conference Tables

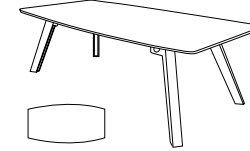

PAGE 13  
Boat Conference Tables

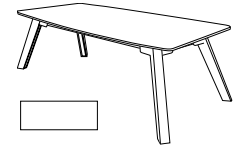

PAGE 14  
Table Frame

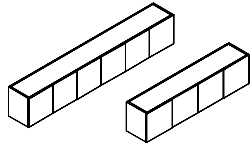

PAGE 15  
Single Height Wall Hung Overheads

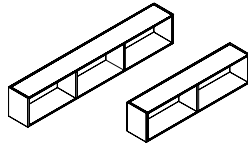

PAGE 16  
Single Height Wall Hung Overheads

## Boss features & advantages

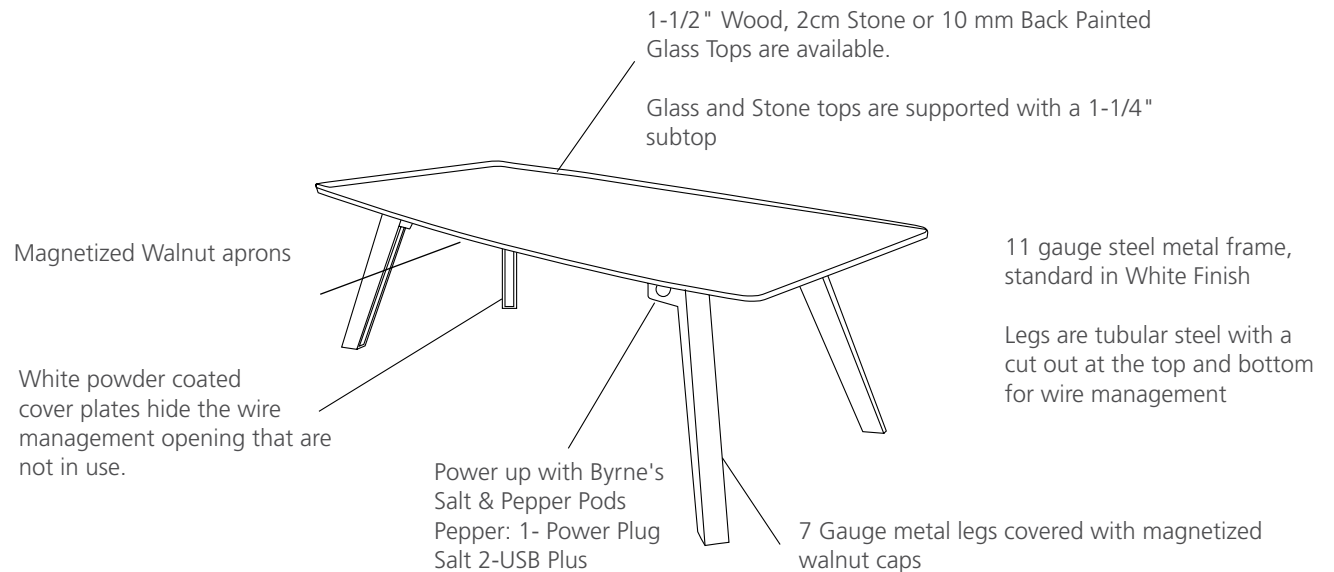
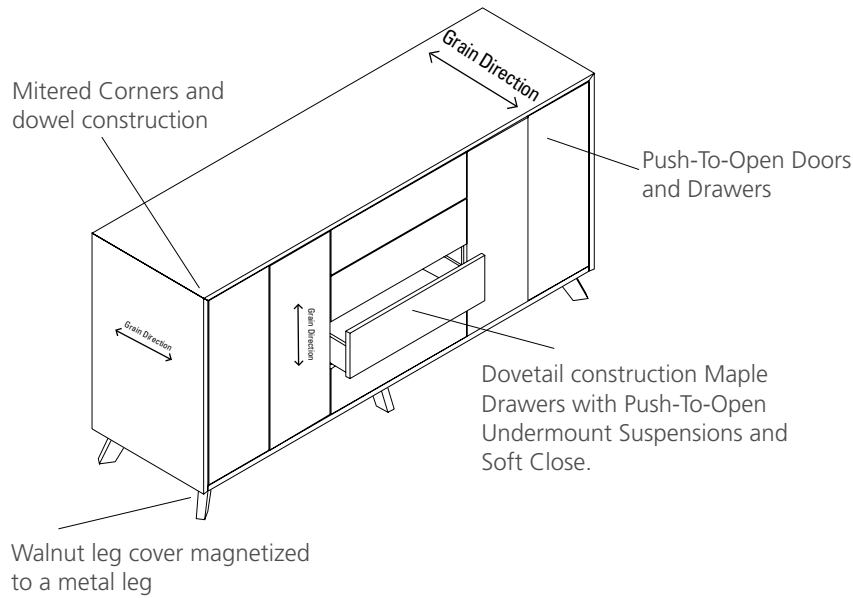

## Boss features & advantages

### Veneer

Boss is standard with Quartered Walnut veneer that is slip-matched. They are cut perpendicular to a log's growth rings with quartered veneers and generally produce a very straight grain. Veneer leaves are cut consecutively and are easy to match. In many species, this method will reveal a decorative element in the wood. Quarter slicing produces smaller veneer leaves and has a higher-end veneer appearance. Boss veneers are slipmatched, meaning adjoining veneer leaves are fed out in sequence without being turned so that the same side of the veneer leaves is exposed. This allows the leaves' grain pattern to repeat across the face of the panel, improving color uniformity.

### Veneer tops

Veneer table desk and Veneer conferencing tops are 1-1/2" thick on 45lb density MDF core comprised of 100% recycled and recovered wood fibers with a balanced 3-ply construction. All veneer tops are Quartered Walnut that is slipmatched and features a 3mm external solid hardwood band with profile edge. Tops are finished in a 5-sheen matte finish.

### Cleaning wood & laminate

In addition to regular dusting, give your furniture an occasional cleaning in accordance with our cleaning instructions. DARRAN wood and laminate products can be cleaned with a soft cloth and a mild soap and water mixture. Use approximately 32 oz of water mixed with one tablespoon of dish soap, always wiping with the grain. Dry with a soft cloth, going with the grain, to avoid spotting or streaking.

Wood products should be waxed periodically using a non-wax liquid; please do not use any waxy polish or cleaner. Interior of drawers may also be cleaned with mild soap and water mixture, or any household cleaner that is not petroleum or thinner-based.

### Chassis & pedestal

Chassis components are 1" thick core of particle board or MDF rated EPP/SCS/CARBII material with 3-ply balanced construction. Case construction features 90 degree mitered joints. All units are standard with 1" adjustable glides that allow for leveling.

### Conference tops

1 1/2" thick core, Particleboard rated EPP/SCS/CARB-II material with 3 ply balanced construction. Quartered walnut veneers. Standard with hardwood rim bands.

### Overhead cabinet construction

#### Freestanding & wall mount

Freestanding Overhead storage cabinets are constructed of 1" and 3/4" thick core of particle board or MDF rated EPP/SCS/CARB-II material with 3-ply balanced

construction. Panels are attached with cam fasteners in conjunction with dowels securely adhered with glue. All surface mount cabinets connect to work surface with anti-slip tape. Wall mount cabinets are mounted to the wall with steel "z" bracket attachment method using 5mm euro screws to attach to the back of the cabinet. Units ship with a steel "z" bracket. This bracket is mounted to the wall by field installers. Installers are responsible for selecting and supplying appropriate fasteners for wall conditions.

### Tackboards

Wall mount tackboards are constructed of .75" thick fiberboard. The fabric is precisely aligned and fitted to the tackboard with a sock on cover. Wall mount cabinets are mounted to the wall with steel "z" bracket attachment method using 5mm euro screws to attach to the back of the cabinet. All units ship with a steel "z" bracket. This bracket is mounted to the wall by field installers. Installers are responsible for selecting and supplying appropriate fasteners for wall conditions.

### Adjustable glides

Glides provide 1" of vertical leveling adjustment. Glide bottom is durable metal. Glides are secured in solid wood blocks that are screwed and glued for durability.

### Standard wood drawers

Maple drawers are dovetailed at corners. Sides are 1/2" thick with a 3/4" thick bottom. UV cured finish.

### Doors & drawer fronts

Door and drawer fronts are vertically matched in balanced sets in Quartered walnut.

### Suspensions

All casegoods utilize cold rolled steel zinc plated high-grade drawer suspensions. Box and File drawers are full extension, featuring steel ball bearings for a smoother quieter range of motion with soft close operation and are rated 100lbs. Lateral file drawers are a progressive action full extension suspension with the soft close operation and is rated at 150lbs. Lateral files include anti tip mechanism that will allow only one drawer at a time to be opened. All suspensions are soft close and are warranted for the lifetime of the product.

### Hinges

Units with doors include 95 degree swing hinges

### Locks

Locks are optional on all drawers/doors below the worksurface. Random lock cores are installed at the factory. Some units may be shipped with the same key number. Locks are Silver unless otherwise specified. DARRAN will also send lock cores

## Boss features & advantages

### Keying

Keying is available either factory or field installed. Factory installed keying is random.

### Wire management

Wire management capabilities include standard and optional worksurface grommets. Specify W-1 under surface wire channels for organization and management of all communication wires and cords. Horizontal J-Channel wire management (Sku: W-1) is sold separately to conceal wire under worksurfaces.

### Grommets

Metal grommets are provided to match the drawer pull selection. Grommet is available in black, silver or white. Must specify standard or non-standard location. Black plastic grommets are available as an option for vertical applications..

### Powerports

A large selection of power pods are available and handle power, data, docking stations and communication. See options section for selection.

### LED tasklights

LED task lighting provides high efficiency, low energy lighting with a long life. Recessed light is encased in silver aluminum channel with milk lense and rounded end caps. Lights are factory installed. Product specifications listed below:

- Diffuser creates a softer light and eliminates hot spots
- Touch dimmer switch
- Can be "daisy chained" up to 90W
- 4.6 watts per foot
- 120 LEDs per meter
- Certification: UL Listed
- 50,000 hour life span.

Color Temp is 4000K

## Boss finishes

STANDARD VENEER	PREMIUM VENEER	HIGH PRESSURE LAMINATE	THERMALLY FUSED LAMINATE
WOW Clear Walnut .....	N/A .....	N/A .....	N/A
WEW Executive Walnut.....	N/A .....	N/A .....	N/A
WGW Gunstock Walnut....	N/A .....	N/A .....	N/A
WBW Henna Walnut.....	N/A .....	N/A .....	N/A
WSW Smokey Walnut.....	N/A .....	N/A .....	N/A
WNW Natural Walnut .....	N/A .....	N/A .....	N/A

Boss Collection features Quartered Walnut Veneers

Send 3x3 or larger finish chip for color match. Custom finish upcharge is 3% or \$250 Net (whichever is greater).

## Finish

ENVI-CT Green Certified European Technology Coatings Finish.



Boss edges | pulls | knobs

### Boss Table Profile

Boss Profile - Only Available on Quartered Walnut Table

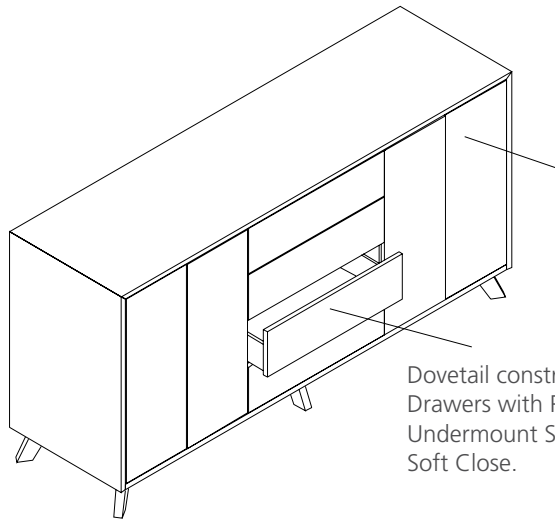
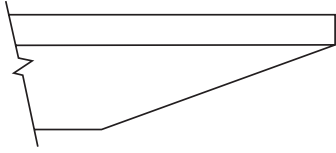

Push-To-Open  
Doors and Drawers

Dovetail construction Maple  
Drawers with Push-To-Open  
Undermount Suspensions and  
Soft Close.

## Boss grommets | grommet reference

### Optional wire management grommets

Factory Installed

When grommets are specified or standard in a unit, DARRAN provides wire channels under the surface for organization and management of all communication wires and cords.

Grommets (Standard Location)

Specify Color and Left/Right/Center - \$50 ea.

- Silver: TM31-R (Right), TM31-L (Left), TM31-C (Center)
- White: TM34-R (Right), TM34-L (Left), TM34-C (Center)

Grommets (Non-Standard Location)

Provide drawing w/ Grommet Location and Specify Color - \$95 ea.

- Silver: TM31-NS
- White: TM34-NS

TM31  
Silver  
1-5/8" Dia.

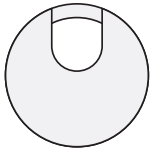

TM34  
White  
1-5/8" Dia.

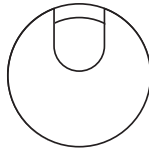

### Grommets (vertical surface)

Standard Location - \$50 ea.

- Black Plastic Vertical Surface: TM50-C (Bottom Center)

Non-Standard Location - \$95 ea.

- Black Plastic Vertical Surface: TM50-NS

TM50

Black

1-5/8" Dia.



## Boss modesty reference | grain direction

Veneer chassis parts are vertical grain. Doors feature vertical veneer matched vertically.

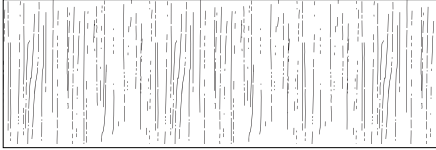

Credenza

## Boss drawer dimensions | filing reference

INTERIOR DRAWER DIMENSIONS		OVERALL DIMENSIONS			INTERIOR DRAWER DIMENSIONS			NOTES
UNIT DEPTH	DRAWER TYPE	W	D	H	W	D	H	
29" Wde	24" Box	27-7/8	18	5	26-7/8	17	3-3/4	Conference Box Drawers

## Filing reference

29" : 26-1/2" Wide File Drawer - 16-1/16" Deep

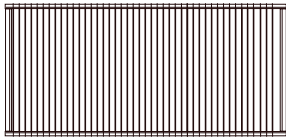

Legal Side to Side

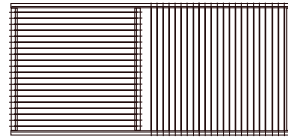

Legal Side to Side  
Letter Front to Back  
with File Rail

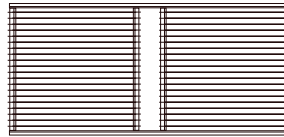

Letter Front to Back  
with File Rail

# Boss.

## Conferencing Credenzas Storage With Doors

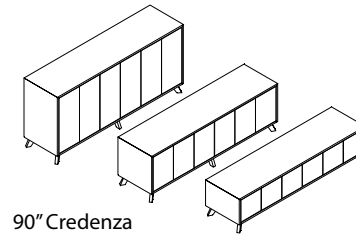

90" Credenza

[View statement of line](#)

1 Select a model w" x d" x h"	weight	Standard Veneer Top	Premium Veneer Top	High Pressure Laminate Top	Thermally Fused Laminate Top
		Standard Veneer Chassis	Premium Veneer Chassis	Veneer Chassis	Thermally Fused Laminate Chassis
<b>90" 6 Door Storage Credenza</b>					
90 x 24 x 42	490	BOS9042CA125W 6688	"P" Option N/A	"G" Option N/A	"M" Option N/A
90 x 24 x 30	330	BOS9030CA125W 5843	"P" Option N/A	"G" Option N/A	"M" Option N/A
90 x 24 x 22	220	BOS9022CA125W 5297	"P" Option N/A	"G" Option N/A	"M" Option N/A
<b>84" 6 Door Storage Credenza</b>					
84 x 24 x 42	460	BOS8442CA125W 6268	"P" Option N/A	"G" Option N/A	"M" Option N/A
84 x 24 x 30	310	BOS8430CA125W 5477	"P" Option N/A	"G" Option N/A	"M" Option N/A
84 x 24 x 22	205	BOS8422CA125W 4963	"P" Option N/A	"G" Option N/A	"M" Option N/A
<b>72" 4 Door Storage Credenza</b>					
72 x 24 x 42	395	BOS7242CA125W 5416	"P" Option N/A	"G" Option N/A	"M" Option N/A
72 x 24 x 30	265	BOS7230CA125W 4756	"P" Option N/A	"G" Option N/A	"M" Option N/A
72 x 24 x 22	180	BOS7222CA125W 4292	"P" Option N/A	"G" Option N/A	"M" Option N/A
<b>2 Select a finish</b> <a href="#">View finish details</a>					
		WOW			
		WEW			
		WGW			
		WBW			
		WSW			
		WNW			
<b>3 Select a edge</b> <a href="#">View edge details</a>					
		Edge			
		N/A			
<b>4 Select hardware</b> <a href="#">View hardware details</a>					
		Hardware			
		N/A			

## Product features.

- 30" Height has 1 adjustable shelves per door section
- 42" Height has 2 adjustable shelves per door section
- Floor levelers (adjustable 1/2")
- Open Plan
- Quartered Walnut runs horizontally on case and vertically on doors. Top is short grain.

### NOTES

- Boss features push-to-open drawers and doors. Hardware is not available.
- Center vertical section will be removed when REF-01 option is specified. For interior cabinet dimensions contact factory

## Options.

### DOOR

- D2: Wood Door Lock - \$100 per door set
- D6: Delete Doors - n/c
- WPD3061: Designer White Fronts - \$130 per 2 door section

### REFRIGERATOR

- REF-01: Specify Right or Left Refrigerator option (Water mat, heat vent and grommet hole) - \$205
- Option is available on BOS9042CA125, BOS8442CA125, BOS-7242CA125

### TRASH CAN

- Specify Location
- TRC230: Trash Can Insert - (2) 30 gal containers - \$495
- Option is available on BOS9042CA125, BOS8442CA125, BOS-7242CA125

# Boss.

## Conferencing Credenzas Storage With Doors/ Open Center

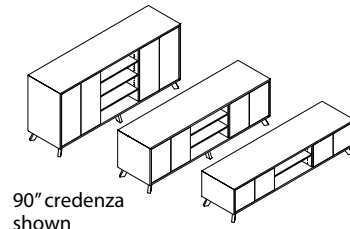

90" credenza shown

[View statement of line](#)

1 Select a model w" x d" x h"	weight	Standard Veneer Top	Premium Veneer Top	High Pressure Laminate Top	Thermally Fused Laminate Top
		Standard Veneer Chassis	Premium Veneer Chassis	Veneer Chassis	Thermally Fused Laminate Chassis
<b>90" 4 Door Open/Storage Credenza</b>					
90 x 24 x 42	470	BOS9042CA128W 6470	"P" Option N/A	"G" Option N/A	"M" Option N/A
90 x 24 x 30	310	BOS9030CA128W 5678	"P" Option N/A	"G" Option N/A	"M" Option N/A
90 x 24 x 22	200	BOS9022CA128W 5188	"P" Option N/A	"G" Option N/A	"M" Option N/A
<b>84" 4 Door Open/Storage Credenza</b>					
84 x 24 x 42	440	BOS8442CA128W 6066	"P" Option N/A	"G" Option N/A	"M" Option N/A
84 x 24 x 30	290	BOS8430CA128W 5324	"P" Option N/A	"G" Option N/A	"M" Option N/A
84 x 24 x 22	185	BOS8422CA128W 4860	"P" Option N/A	"G" Option N/A	"M" Option N/A
<b>72" 2 Door Open/Storage Credenza</b>					
72 x 24 x 42	375	BOS7242CA128W 5242	"P" Option N/A	"G" Option N/A	"M" Option N/A
72 x 24 x 30	245	BOS7230CA128W 4603	"P" Option N/A	"G" Option N/A	"M" Option N/A
72 x 24 x 22	160	BOS7222CA128W 4205	"P" Option N/A	"G" Option N/A	"M" Option N/A
2 Select a finish <a href="#">View finish details</a>		WOW			
		WEW			
		WGW			
		WBW			
		WSW			
		WNW			
3 Select a edge <a href="#">View edge details</a>		Edge			
		N/A			
4 Select hardware <a href="#">View hardware details</a>		Hardware			
		N/A			

## Product features.

- 30" Height has 1 adjustable shelves per door section
- 42" Height has 2 adjustable shelves per door section
- Floor levelers (adjustable 1/2")
- Open Plan
- Quartered Walnut runs horizontally on case and vertically on doors. Top is short grain.

### NOTES

- Boss features push-to-open drawers and doors. Hardware is not available.
- Center vertical section will be removed when REF-01 option is specified. For interior cabinet dimensions contact factory

## Options.

### DOOR

- D2: Wood Door Lock - \$100 per door set
- D6: Delete Doors - n/c
- WPD3061: Designer White Fronts - \$130 per 2 door section

### REFRIGERATOR

- REF-01: Specify Right or Left Refrigerator option (Water mat, heat vent and grommet hole) - \$205
- Option is available on BOS9042CA128, BOS8442CA128, BOS-7242CA128

### TRASH CAN

- Specify Location
- TRC230: Trash Can Insert - (2) 30 gal containers - \$495
- Option is available on BOS9042CA128, BOS8442CA128, BOS-7242CA128

# Boss.

## Conferencing Credenzas Box Drawers/Storage With Doors

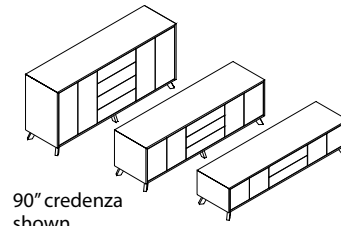

90" credenza shown

[View statement of line](#)

1 Select a model w" x d" x h"	weight	Standard Veneer Top	Premium Veneer Top	High Pressure Laminate Top	Thermally Fused Laminate Top
		Standard Veneer Chassis	Premium Veneer Chassis	Veneer Chassis	Thermally Fused Laminate Chassis
<b>90" 4 Door/Drawer Storage Credenza</b>					
90 x 24 x 42	490	BOS9042CA139W 8108	"P" Option N/A	"G" Option N/A	"M" Option N/A
90 x 24 x 30	330	BOS9030CA139W 6804	"P" Option N/A	"G" Option N/A	"M" Option N/A
90 x 24 x 22	220	BOS9022CA139W 6011	"P" Option N/A	"G" Option N/A	"M" Option N/A
<b>84" 4 Door/4 Drawer Storage Credenza</b>					
84 x 24 x 42	460	BOS8442CA139W 7677	"P" Option N/A	"G" Option N/A	"M" Option N/A
84 x 24 x 30	310	BOS8430CA139W 6432	"P" Option N/A	"G" Option N/A	"M" Option N/A
84 x 24 x 22	205	BOS8422CA139W 5673	"P" Option N/A	"G" Option N/A	"M" Option N/A
<b>72" 2 Door/ Drawer Storage Credenza</b>					
72 x 24 x 42	395	BOS7242CA139W 6797	"P" Option N/A	"G" Option N/A	"M" Option N/A
72 x 24 x 30	265	BOS7230CA139W 5684	"P" Option N/A	"G" Option N/A	"M" Option N/A
72 x 24 x 22	180	BOS7222CA139W 4985	"P" Option N/A	"G" Option N/A	"M" Option N/A
<b>2 Select a finish</b> <a href="#">View finish details</a>					
		WOW			
		WEW			
		WGW			
		WBW			
		WSW			
		WNW			
<b>3 Select a edge</b> <a href="#">View edge details</a>					
		Edge			
		N/A			
<b>4 Select hardware</b> <a href="#">View hardware details</a>					
		Hardware			
		N/A			

## Product features.

- 30" Height has 1 adjustable shelves per door section
- 42" Height has 2 adjustable shelves per door section
- Drawers feature soft close suspension
- Floor levelers (adjustable 1/2")
- Open Plan
- Quartered Walnut runs horizontally on case and vertically on doors. Top is short grain.

### NOTES

- Boss features push-to-open drawers and doors. Hardware is not available.
- For interior cabinet dimensions contact factory

## Options.

### DOOR

- D2: Wood Door Lock - \$100 per door set
- D6: Delete Doors - n/c
- WPD3061: Designer White Fronts - \$130 per 2 door section
- WPD3062: Designer White Fronts - \$65 per drawer

### DRAWER

- P21U: Modify upper box/box to lateral - n/c
- P21L: Modify lower box/box to lateral - n/c

### REFRIGERATOR

- REF-01: Specify Right or Left Refrigerator option (Water mat, heat vent and grommet hole) - \$205
- Option is available on BOS9042CA139, BOS8442CA139, BOS-7242CA139

### TRASH CAN

- Specify Location
- TRC230: Trash Can Insert - (2) 30 gal containers - \$495
- Option is available on BOS9042CA139, BOS8442CA139, BOS-7242CA139

**Boss.**

Boat Conference Tables  
Quartered Walnut Top

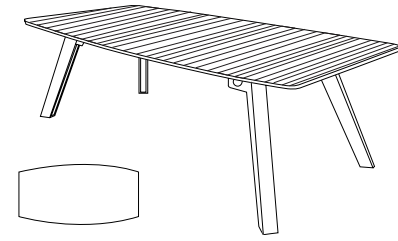

[View statement of line](#)

1 Select a model w" x d" x h"	weight	Standard Veneer Top Standard Veneer Chassis		Premium Veneer Top Premium Veneer Chassis		High Pressure Laminate Top Veneer Chassis		Thermally Fused Laminate Top Thermally Fused Laminate Chassis	
		72 x 42 x 30	240	BOS7242WT200W	5242	"P" Option N/A	"G" Option N/A	"M" Option N/A	"M" Option N/A
84 x 42 x 30	280	BOS8442WT200W	5717	"P" Option N/A	"G" Option N/A	"M" Option N/A	"M" Option N/A	"M" Option N/A	
96 x 48 x 30	315	BOS9648WT200W	6039	"P" Option N/A	"G" Option N/A				

2 Select a finish <a href="#">View finish details</a>	
	WOW
	WEW
	WGW
	WBW
	WSW
	WNW

3 Select a edge <a href="#">View edge details</a>	
	 Boss

4 Select hardware <a href="#">View hardware details</a>	
	Hardware N/A

**Product features.**

- 1.5" thick Quartered Walnut Top
- Adjustable Glides
- Hidden Wire Management down each leg, specify legs to be powered
- Quartered Walnut Runs Short Grain
- White steel Frame with magnetized solid wood aprons and leg caps
- Tops and bases are pre-located to ensure proper installation location

**NOTES**

- Table Ships KD

**Options.**

**POWER**

- PDP01: Pepper (Power) - \$95 ea.
- PDS01: Salt (Powered USB) - \$225 ea.
- PD717: Power Supply Cordset - \$100 ea.
- Can specify up to 8 total power units (Specify location on drawing)
- W1: Horizontal J-Channel Wire Management Raceway - \$80 per 4'



# Boss.

## Boat Conference Tables 10Mm Ice White Glass Top

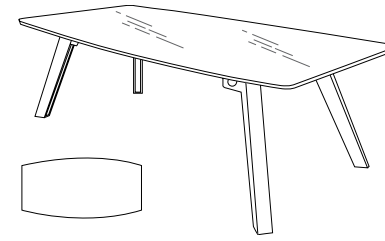

[View statement of line](#)

1 Select a model w" x d" x h"	weight	Glass Top Veneer Base		High Pressure Laminate Top Veneer Chassis		Thermally Fused Laminate Top Thermally Fused Laminate Chassis	
		72 x 42 x 30	300	BOS7242GT200W	9413	"P" Option N/A	"G" Option N/A
84 x 42 x 30	350	BOS8442GT200W	10510	"P" Option N/A	"G" Option N/A	"M" Option N/A	
96 x 48 x 30	560	BOS9648GT200W	11652	"P" Option N/A	"G" Option N/A	"M" Option N/A	

2 Select a finish <a href="#">View finish details</a>	
	WOW
	WEW
	WGW
	WBW
	WSW
	WNW

3 Select a edge <a href="#">View edge details</a>	
	 Flat

4 Select hardware <a href="#">View hardware details</a>	
	Hardware N/A

## Product features.

- 10mm Ice White Glass Top
- 1-1/4" Subtop
- Adjustable glides
- Hidden Wire Management down each leg, specify legs to be powered
- White steel Frame with magnetized solid wood aprons and leg caps

### NOTES

- Table Ships KD

## Options.

### POWER

- PDP01: Pepper (Power) - \$95 ea.
- PDS01: Salt (Powered USB) - \$225 ea.
- PD717: Power Supply Cordset - \$100 ea.
- Can specify up to 8 total power units (Specify location on drawing)
- W1: Horizontal J-Channel Wire Management Raceway - \$80 per 4'

**Boss.**

Boat Conference Tables  
2Cm White Carrara Top Table

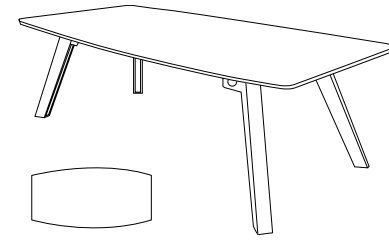

[View statement of line](#)

1 Select a model w" x d" x h"	weight	Stone Top Veneer Base		High Pressure Laminate Top Veneer Chassis		Thermally Fused Laminate Top Thermally Fused Laminate Chassis	
		72 x 42 x 30	555	BOS7242ST200W	10893	"P" Option N/A	"G" Option N/A
84 x 42 x 30	632	BOS8442ST200W	12607	"P" Option N/A	"G" Option N/A	"M" Option N/A	
96 x 48 x 30	800	BOS9648ST200W	14579	"P" Option N/A	"G" Option N/A	"M" Option N/A	

2 Select a finish  
[View finish details](#)

WOW  
WEW  
WGW  
WBW  
WSW  
WNW

3 Select a edge  
[View edge details](#)

  
Flat

4 Select hardware  
[View hardware details](#)

Hardware  
N/A

**Product features.**

- 1-1/4" Subtop
- 2cm White Carrara Top Table
- Adjustable glides
- Hidden Wire Management down each leg, specify legs to be powered
- White steel Frame with magnetized solid wood aprons and leg caps

**NOTES**  
- Table Ships KD

**Options.**

- POWER**
- PDP01: Pepper (Power) - \$95 ea.
  - PDS01: Salt (Powered USB) - \$225 ea.
  - PD717: Power Supply Cordset - \$100 ea.
  - Can specify up to 8 total power units (Specify location on drawing)
  - W1: Horizontal J-Channel Wire Management Raceway - \$80 per 4'

# Boss.

Table Frame  
 Table Frame W/ Wood Aprons, Legs & Subtop

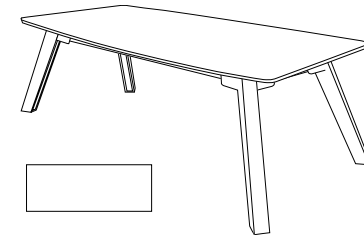

[View statement of line](#)

1 Select a model w" x d" x h"	weight	Standard Veneer Top Standard Veneer Chassis		Premium Veneer Top Premium Veneer Chassis		High Pressure Laminate Top Veneer Chassis		Thermally Fused Laminate Top	
		66 x 36 x 29	140	BOS7242FO199W	4985	"P" Option N/A	"G" Option N/A	"M" Option N/A	"M" Option N/A
78 x 36 x 29	165	BOS8442FO199W	5285	"P" Option N/A	"G" Option N/A	"M" Option N/A	"M" Option N/A	"M" Option N/A	
90 x 42 x 29	220	BOS9648FO199W	5602	"P" Option N/A	"G" Option N/A	"M" Option N/A	"M" Option N/A	"M" Option N/A	

2 Select a finish <a href="#">View finish details</a>	
	WOW
	WEW
	WGW
	WBW
	WSW
	WNW

3 Select a edge <a href="#">View edge details</a>	
	 Flat

4 Select hardware <a href="#">View hardware details</a>	
	Hardware N/A

## Product features.

- Adjustable glides
- Edge of subtop matches leg finish
- Hidden Wire Management down each leg, specify legs to be powered
- Steel Frame with magnetized solid wood aprons and leg caps
- Top & Bottom of Subtop is Finished Black (Template is available upon request for customers own top material)
- Does not include finished top

### NOTES

- Frame Ships KD

## Options.

### POWER

- PDP01: Pepper (Power) - \$95 ea.
- PDS01: Salt (Powered USB) - \$225 ea.
- PD717: Power Supply Cordset - \$100 ea.
- Can specify up to 8 total power units (Specify location on drawing)
- W1: Horizontal J-Channel Wire Management Raceway - \$80 per 4'

**Boss.**

Single Height Wall Hung Overheads  
14" D Panel Doors - 2/3 Section

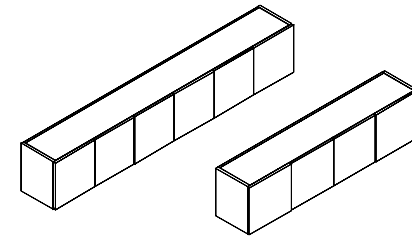

[View statement of line](#)

1 Select a model w" x d" x h"	weight	Standard Veneer Top Standard Veneer Chassis	Premium Veneer Top Premium Veneer Chassis	High Pressure Laminate Top Veneer Chassis	Thermally Fused Laminate Top
<b>6 Door / 3 Section</b> 90 x 14 x 18	240	BOS9018WH330W 3629	"P" Option N/A	"G" Option N/A	"M" Option N/A
<b>4 Door / 2 Section</b> 84 x 14 x 18	210	BOS8418WH330W 3518	"P" Option N/A	"G" Option N/A	"M" Option N/A
72 x 14 x 18	180	BOS7218WH330W 2900	"P" Option N/A	"G" Option N/A	"M" Option N/A
2 Select a finish <a href="#">View finish details</a>		WOW WEW WGW WBW WSW WNW			
3 Select a edge <a href="#">View edge details</a>		Edge N/A			
4 Select hardware <a href="#">View hardware details</a>		Hardware N/A			

**Product features.**

- Doors fully matched set, quarter grain runs vertical
- Finished top
- Interior cabinet depth 12"
- Mounting wall rail included
- Touch latch doors standard

**NOTES**

- Proper installation is critical to ensure safety from possible falling cabinets. The factory assumes no liability for damage or injury from the following: installation into non-load bearing or unlevel walls. Improper fasteners used in installation. Overloading of cabinets resulting in failures of wall and surrounding structures, fasteners, or cabinet construction. Misuse of cabinets for intended purposes.

**Options.**

**DOOR**

- D2: Door Lock - \$100 per door set
- D6: Delete doors - n/c
- D9SC: Soft Close Door Hinges - \$20 per door
- RF375AW: Aluminum/White Glass - \$395 per door
- WPD3061: Designer White - \$35 per door

**LEGAL DEPTH**

- MLD1: Modify to legal depth 18" - 10% upcharge

**RECESSED TASK LIGHT**

- LT-LED24R: 24" LED Task light - \$190
- LT-LED48R: 48" LED Task light - \$245
- LT-LED60R: 60" LED Task light - \$310
- LT-LED72R: 72" LED Task light - \$335
- LC24: Linking Task light cable - \$25

Boss.

Single Height Wall Hung Overheads  
14" D Open Storage Cabinet - 2/3 Section

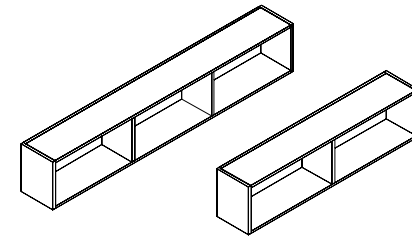

[View statement of line](#)

1 Select a model w" x d" x h"	weight	Standard Veneer Top Standard Veneer Chassis		Premium Veneer Top Premium Veneer Chassis		High Pressure Laminate Top Veneer Chassis		Thermally Fused Laminate Top	
		<b>3 Section</b> 90 x 14 x 18 84 x 14 x 18	225 200	BOS9018WH332W BOS8418WH332W	3450 3388	"P" Option N/A "P" Option N/A	"G" Option N/A "G" Option N/A	"M" Option N/A "M" Option N/A	
<b>2 Section</b> 72 x 14 x 18	170	BOS7218WH332W	2752	"P" Option N/A	"G" Option N/A	"M" Option N/A			
<b>2 Select a finish</b> <a href="#">View finish details</a>		WOW WEW WGW WBW WSW WNW							
<b>3 Select a edge</b> <a href="#">View edge details</a>		Edge N/A							
<b>4 Select hardware</b> <a href="#">View hardware details</a>		Hardware N/A							

Product features.

- Finished top
- Interior cabinet depth 12"
- Mounting wall rail included

NOTES

- 3 Section Overhead Available w/ 1 or 2 Sliding Doors
- 2 Section available w/ 1 sliding door
- Proper installation is critical to ensure safety from possible falling cabinets. The factory assumes no liability for damage or injury from The following: installation into non-load bearing or unlevel walls. Improper fasteners used in installation. Overloading of cabinets resulting in failures of wall and surrounding structures, fasteners, or cabinet construction. Misuse of cabinets for intended purposes.

Options.

SLIDING DOORS

- RF550AW: Aluminum/White Glass - \$575 per door
- SLD17WD: Panel Door - \$260 per door
- SLD17WP: White Painted Door - \$340 per door

INTERIOR CABINET LIGHT

- LEDPK starter kit includes Infeed, 1 Puck Interior Light and the ability to daisy chain up to 6 total Puck Lights
- LEDPK: LED Puck Starter Kit - \$310
- PK: 1 LED Interior Light - \$130 ea.

LEGAL DEPTH

- MLD1: Modify to legal depth 18" - 10% upcharge

RECESSED TASK LIGHT

- LT-LED24R: 24" LED Task light - \$190
- LT-LED48R: 48" LED Task light - \$245
- LT-LED60R: 60" LED Task light - \$310
- LT-LED72R: 72" LED Task light - \$335
- LC24: Linking Task light cable - \$25

## Boss options.



### COMPUTER SUPPORT *single monitor arm*

Style Number	List Price
MA1	280

### Specifications

- Available in black or silver
- Desk clamp and mounting included
- Easy assembly and flexibility
- Elastic painting process for a durable and beautiful finish
- Gas spring tension adjustment for counter-balance height adjustment for monitors 1-8 KG
- Gas spring tested to 50,000 repetitions
- Hidden cable management

### COMPUTER SUPPORT *double monitor arm*

Style Number	List Price
MA2	450

### Specifications

- Available in black or silver
- Desk clamp and mounting included
- Easy assembly and flexibility
- Elastic painting process for a durable and beautiful finish
- Gas spring tension adjustment for counter-balance height adjustment for monitors 1-8 KG
- Gas spring tested to 50,000 repetitions
- Hidden cable management

### COMPUTER SUPPORT *triple monitor arm*

Style Number	List Price
MA3	530

### Specifications

- Available in black or silver
- Desk clamp and mounting included
- Easy assembly and flexibility
- Elastic painting process for a durable and beautiful finish
- Gas spring tension adjustment for counter-balance height adjustment for monitors 1-8 KG
- Gas spring tested to 50,000 repetitions
- Hidden cable management

### COMPUTER SUPPORT *quadruple monitor arm*

Style Number	List Price
MA4	705

### Specifications

- Available in black
- Desk clamp and mounting included
- Easy assembly and flexibility
- Elastic painting process for a durable and beautiful finish
- Gas spring tension adjustment for counter-balance height adjustment for monitors 1-8 KG
- Gas spring tested to 50,000 repetitions
- Hidden cable management

## Boss options.

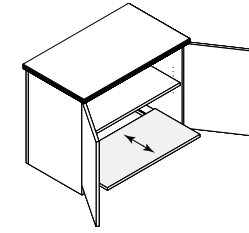
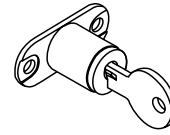
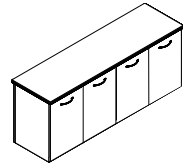

### DOOR MODIFICATIONS *soft close door hinge*

Style Number	List Price
D9SC	20 Per door

### Specifications

- Snap onto standard door hinge
- Requires (2) per door
- Max door height 43"
- Factory installed where specified
- Individually shipped for field installation

#### Notes

- Specify Each Item To Have Slow Close Feature

### DOOR MODIFICATIONS *delete doors*

Style Number	List Price
D6	N/C

### Specifications

- Standard Door cabinets can have door deleted for open access. Modification of hinge rails and structural components are made face ready.

### DOOR MODIFICATIONS *panel door lock*

Style Number	List Price
D2	100 Per door set

### Specifications

- Door Locks - 1 Door w/ Lock, Other Door w/ Catch Latch
- Contact Customer Service regarding limited lock locations and keying.

#### Notes

- Available on: Panel Doors, Wood Frame Doors, and Silverluma doors

### PEDESTAL MODIFICATIONS *black laminate printer pullout bottom shelf*

Style Number	List Price
PPOS	225

### Specifications

- Black Laminate pullout shelf on suspension
- Black grommet in back
- Adjustable Shelf

## Boss options.

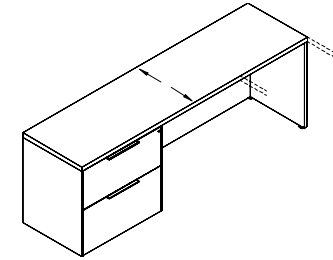
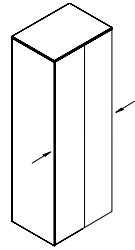
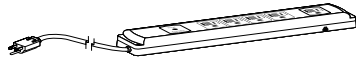

### POWER / DATA *power supply cordset*

Style Number	List Price
PD717	95

### Specifications

- SIZE: 10.75"L x 2.0"W x 1.06"H
- (5) Outlets w/ 10' cord
- Surge suppression (720 Joules)
- 15 Amp breaker
- Available on: Vertical Panels, Cabinet Interiors, and under tops

### PRODUCT MODIFICATIONS *modify width - open/closed storage*

Style Number	List Price
MOD-2	250

### Specifications

- Modify width down on any unit with open or closed storage section: overheads, wall hung units, storage credenzas, towers

### PRODUCT MODIFICATIONS *modify width - outside of mod-1, mod-2*

Style Number	List Price
MOD-3	Contact for pricing

### Specifications

- Width modification outside of MOD-1 & MOD-2

### PRODUCT MODIFICATIONS *modify depth - increase depth*

Style Number	List Price
MOD-6	Add 10%

### Specifications

- Increase depth by no more than 6"

#### Notes

- Ex. 24" to 30", 30" to 36", and 36" to 42"
- Add 10% to the unit you want to increase the depth of by no more than 6"



## Boss options.

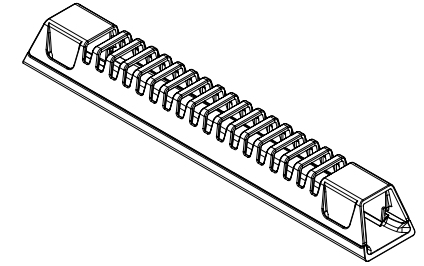
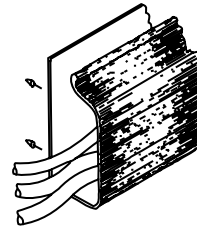
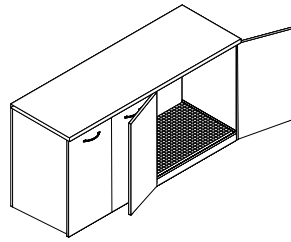

### PRODUCT MODIFICATIONS *modify height*

Style Number	List Price
MOD-7	Contact for pricing

### REFRIGERATOR MODIFICATION *refrigerator cabinet modification*

Style Number	List Price
REF01	205

### WIRE MANAGEMENT *horizontal j-channel wire management raceway*

Style Number	List Price
W1	80 Per 4' section

### WIRE MANAGEMENT *horizontal wire management raceway*

Style Number	List Price
W21	35

## Specifications

- Modify height of a unit

## Specifications

- Open back cutout for venting
- Moisture sponge mat
- Contaminate ledge
- Contact customer service for maximum refrigerator size (Changes based on unit).

### Notes

- Available on: 36" and 42" Storage Credenzas

## Specifications

- 4" section for field installation.
- The "J" shape black thermoplastic wire raceway may be added to specified worksurface tops to provide concealed channeling of wires to and from worksurface grommets. For use in open kneespace areas, raceway is attachable to top of back panel with pan head screws. Interior dimensions are 1" x 1- 1/2" providing ample storage for multiple wires and excess cable. Front of raceway flexes out for easy cord insertion.

### Notes

- Units w/ Wire Channel Standard.
- Field Installation

## Specifications

- 10"W x 1.5"D x 1.25"H
- Grey Wire Manager (10.5")
- Power and data cables can be discretely housed and managed with the W21 Gray Wire Manager. This can be mounted in any location to metal frame or underside of conference tables and runs cables through a 1" channel from power module to hollow steel legs. This keeps cables organized under the table top. Release clips make it simple to snap on and off the Wire Manager for easy organization and access after attached to the table

### Notes

- Field installed

Boss options.

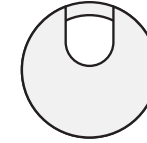
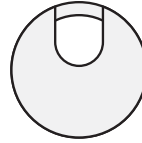

WIRE MANAGEMENT  
*horizontal u-channel wire management raceway*

Style Number	List Price
W2A	80 Per 4' section

Specifications

- 4' section for field installation.

Notes

- Units w/ Wire Channel Standard.
- Field Installation

WIRE MANAGEMENT  
*coil wire manager*

Style Number	List Price
W18	160

Specifications

- Weighted Base, Table attachment plate
- 39- 1/2" Length
- Black

Notes

- Location

WIRE MANAGEMENT  
*standard location grommets - factory installed*

Style Number	List Price
Standard Location Grommet	
Black	
TM30	50
Silver	
TM31	50
Antique Brass	
TM33	50
White	
TM34	50

Specifications

- 1 -5/8" Metal Grommet

Notes

- \*Units w/ Grommets Standard Are Noted Under Standard Features. Grommets Match Pull Finish - Standard (Unless Specified Otherwise)

WIRE MANAGEMENT  
*non-standard location grommets - factory installed*

Style Number	List Price
Non-Standard Location Grommet	
Black	
TM30 -NS	95
Silver	
TM31 -NS	95
Antique Brass	
TM33 -NS	95
White	
TM34 -NS	95

Specifications

- 1 -5/8" Metal Grommet

Notes

- \*Units w/ Grommets Standard Are Noted Under Standard Features. Grommets Match Pull Finish - Standard (Unless Specified Otherwise)

## Boss options.



### WIRE MANAGEMENT

*black plastic vertical surface grommets  
- factory installed*

Style Number	List Price
Standard Location Grommet TM50-C	50
Non-Standard Location Grommet TM50-NS	95

### Specifications

- 2 " Black Plastic Grommet

#### Notes

- Standard Location is Bottom Center

## power & data options.

Aircharge wireless charging grommet

Style Number	List Price
 ACWG WIRELESS GROMMET	\$195

## Specifications

- › When used with GROVE Tables an additional \$350 LIST will apply for the special cutout required.
- › AirCharge offers a convenient way to charge any Qi compatible smartphone or device without the need to carry charging cables or find an available power outlet.
- › The Aircharge is powered by the latest Qi compliant IC offering reliable and efficient wireless charging in a convenient 3" grommet hub. Simply place your phone on the Aircharge and an LED will confirm pairing and begin wireless charging.
- › Recess: Efficient space conservation and quick access
- › Input: DC 5V (with included AC power adapter), DC 9V, 1.67A (with optional QC 2.0 power adapter)
- › Output: 5 watts Max. with DC 5V, 2A power adapter, 10 watts Max. with QC 2.0 power adapter
- › Qi V1.2 compliant IC
- › Charging distance: 6mm Max.

Available: All DARRAN collections



## power & data options.

Cove power unit - non-linking

Style Number

List Price



PD-COVE PLUG

\$550

Non-linking version

## Specifications

- › Size 5.75"L x 2.5"W
- › (2) 15 Amp Receptacles and (2) USB charging ports
- › Surface Mount
- › 108" Cord
- › Standard Silver Finish, Available in White or Black Finish upon request
- › ETL Listed

Available: All DARRAN collections



## power & data options.

Cove corded series

Style Number

List Price



PD-COVE-PKO

\$800

## Specifications

- › Size 9.5" L x 2.5" W x 3.18" D
- › When used with GROVE Tables an additional \$350 LIST will apply for the special cutout required.
- › (2) Power Receptacles, (2) 2.1 Amp USB charging ports and (1) Telecom Plate Knockout
- › Surface Mount
- › 108" Cord
- › Standard Silver Finish, Available in White or Black Finish upon request
- › ETL Listed

Available: All DARRAN collections

### Telecom Plates

RJ45 (1)	\$35
RJ45 (2)	\$70
RJ45 (3)	\$105
USB (1)	\$70
USB (2)	\$140
RJ11/RJ45	\$70
RJ45/USB	\$105
RJ45/HDMI	\$190
HDMI/DVI	\$325
HDMI/USB	\$205
HDMI/VGA	\$240
VGA/MINI-STEREO	\$155
VGA/USB	\$175

This pod can have up to 1 total plates.

\*All telecom connectors sold separately.



## power & data options.

Reef power unit with daisylink

Style Number	List Price
 REF310 PLUG	\$1100

## Specifications

- › Size 16.1"L x 6.25"W x 4.89"D
- › When used with GROVE Tables an additional \$350 LIST will apply for the special cutout required.
- › (3) 120V Receptacles, (2) USB charging ports, 1 Data Plate Knockout, (2) Knockouts for RJ45 Data Ports
- › Surface Mount
- › 108" Cord
- › Features Convenience Plug on bottom of unit that allows for max (3) Daisy Chain
- › Standard Black Finish, Available in White or Silver Finish upon request
- › Additional Telecom Plate Knockout
- › RJ45 for Knockouts not required. If not ordered a small hole will be present in the pod in this this location
- › ETL Listed

Available: Conferencing

Telecom Plates	
RJ45 (1)	\$35
RJ45 (2)	\$70
RJ45 (3)	\$105
USB (1)	\$70
USB (2)	\$140
RJ11/RJ45	\$70
RJ45/USB	\$105
RJ45/HDMI	\$190
HDMI/DVI	\$325
HDMI/USB	\$205
HDMI/VGA	\$240
VGA/MINI-STEREO	\$155
VGA/USB	\$175

This pod can have up to 1 total plates.  
\*All telecom connectors sold separately.



## power & data options.

Salt & pepper power ports

Style Number

List Price



PDP01 Pepper (power)

\$95

PDP01 Salt (powered USB)

\$225

### Specifications

- › Pepper port includes 1 power plug
- › Salt port includes 2 power USB
- › Cord is 72" long
- › Spill-proof technology

Available: Boss, Spire



Pepper power pod



Salt powered USB





## power & data options.

VILLA Power unit - non-linking

Style Number	List Price
VIL-C PLUG Non-Linking	\$515

### Specifications

- › Size: Top Grommet 5.68" L X 3.39"W; Under Top 12"L x 3.13"W x 3.08"D
- › (2) Power receptacles; (2) USB charging ports and (1) Knockouts for RJ45 Data Ports
- › Surface Mount
- › 72" Cord (Longer cord available, contact Customer Service)
- › Standard Silver Finish, Black Finish available upon request
- › UL or ETL Certified

Available: All DARRAN collections, excludes Grove

RJ45 Knockout RJ45 (1)	\$35
---------------------------	------



# Bota price list



## Bota table of contents

Statement of Line	
Bota seating & fabric program.....	1
Seating Specification.....	4
Rear Table Specification.....	5
Grommet Placement.....	7
Finishes.....	8
Seating.....	9
Ottoman.....	54
Booths.....	57
Freestanding Table.....	59
Coat Stand.....	62
Power and Data.....	63

# Bota statement of line.

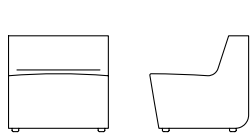

PAGE 9  
Single Seat

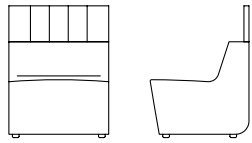

PAGE 10  
Single Seat With Privacy Screen

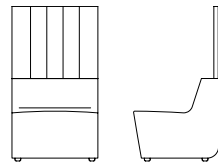

PAGE 11  
Single Seat With Privacy Screen

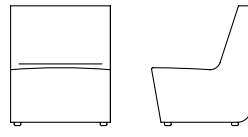

PAGE 12  
Single Seat

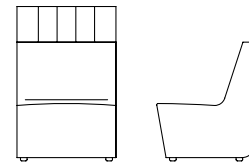

PAGE 13  
Single Seat With Privacy Screen

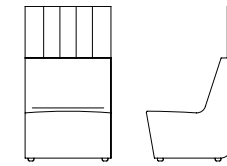

PAGE 14  
Single Seat With Privacy Screen

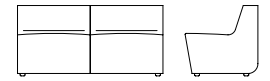

PAGE 15  
Double Seat

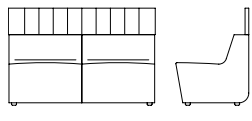

PAGE 16  
Double Seat With Privacy Screen

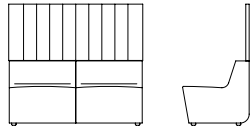

PAGE 17  
Double Seat With Privacy Screen

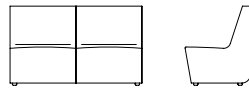

PAGE 18  
Double Seat

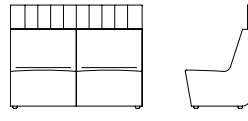

PAGE 19  
Double Seat With Privacy Screen

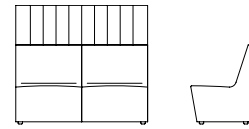

PAGE 20  
Double Seat With Privacy Screen

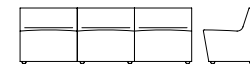

PAGE 21  
Triple Seat

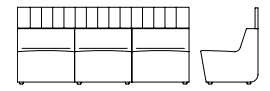

PAGE 22  
Triple Seat With Privacy Screen

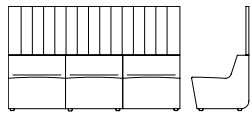

PAGE 23  
Triple Seat With Privacy Screen

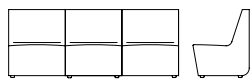

PAGE 24  
Triple Seat

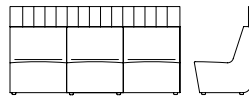

PAGE 25  
Triple Seat With Privacy Screen

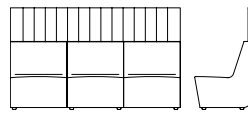

PAGE 26  
Triple Seat With Privacy Screen

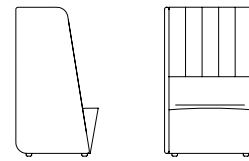

PAGE 27  
Shell - Single Seat

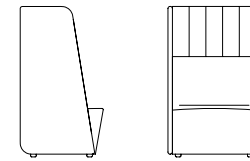

PAGE 28  
Shell - Single Seat

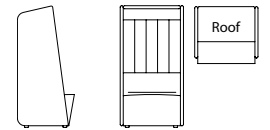

PAGE 29  
Shell - Single Seat

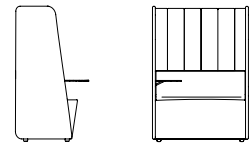

PAGE 30  
Shell - Double Seat

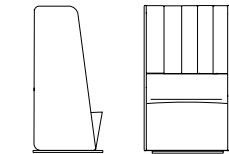

PAGE 31  
Shell - Single Seat

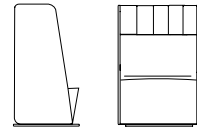

PAGE 32  
Shell - Double Seat

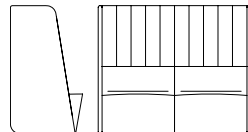

PAGE 33  
Shell - Double Seat

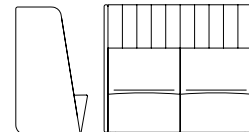

PAGE 34  
Shell - Double Seat

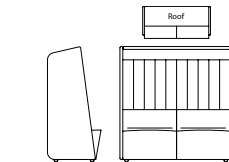

PAGE 35  
Shell - Double Seat

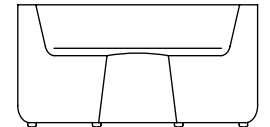

PAGE 36  
90 Deg. Circler - Single Seat Low Back

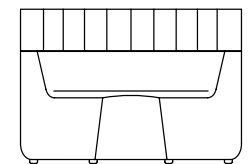

PAGE 37  
90 Deg. Circler - Single Seat Low Back With Privacy Screen

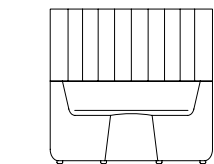

PAGE 38  
90 Deg. Circler - Single Seat Low Back With Privacy Screen

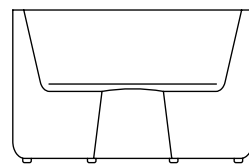

PAGE 39  
90 Deg. Circler - Single Seat High Back

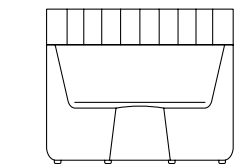

PAGE 40  
90 Deg. Circler - Single Seat High Back With Privacy Screen

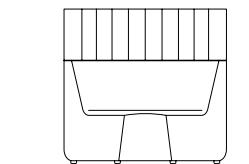

PAGE 41  
90 Deg. Circler - Single Seat High Back With Privacy Screen

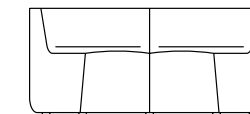

PAGE 42  
60 Deg. Circler - Double Seat Low Back

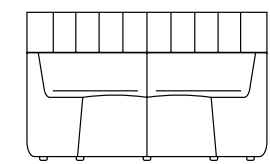

PAGE 43  
60 Deg. Circler - Double Seat Low Back With Privacy Screen

Bota statement of line.

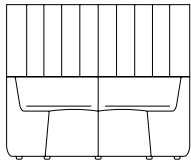

PAGE 44  
60 Deg. Circler - Double Seat Low Back  
With Privacy Screen

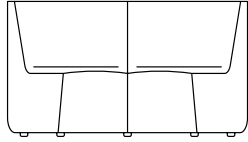

PAGE 45  
60 Deg. Circler - Double Seat High  
Back

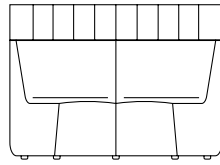

PAGE 46  
60 Deg. Circler - Double Seat High  
Back With Privacy Screen

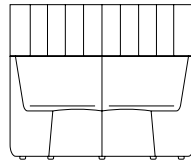

PAGE 47  
60 Deg. Circler - Double Seat High  
Back With Privacy Screen

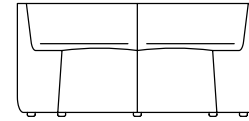

PAGE 48  
45 Deg. Circler - Double Seat Low Back

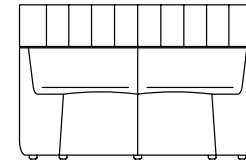

PAGE 49  
45 Deg. Circler - Double Seat Low Back  
With Privacy Screen

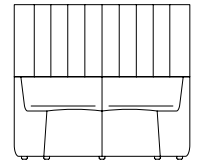

PAGE 50  
45 Deg. Circler - Double Seat Low Back  
With Privacy Screen

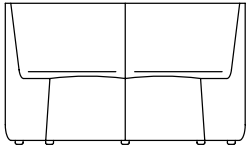

PAGE 51  
45 Deg. Circler - Double Seat High  
Back

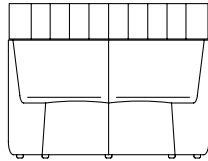

PAGE 52  
45 Deg. Circler - Double Seat High  
Back With Privacy Screen

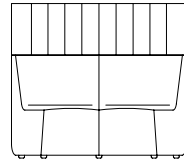

PAGE 53  
45 Deg. Circler - Double Seat High  
Back With Privacy Screen



PAGE 54  
Ottoman

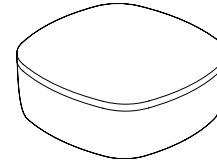

PAGE 55  
Ottoman

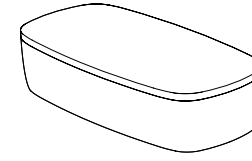

PAGE 56  
Ottoman

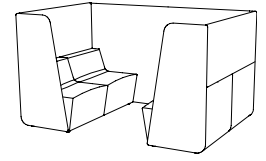

PAGE 57  
Booth

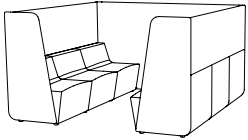

PAGE 58  
Booth



PAGE 59  
Booth Table



PAGE 60  
Booth Table



PAGE 61  
Freestanding Table



PAGE 62  
Coat Stand

## Bota seating fabric & leather program

### Seating & fabric leather program

DARRAN has partnered with some of the most prestigious fabric suppliers of the office furniture industry to bring you quality fabrics that are engaging designs, environmentally friendly and durable for years to come. The majority of fabrics we have graded-in are in heavy supply making it most likely available on our Quickship however, we cannot guarantee stock. If you do not see the fabric you wish to include in a project, please contact our Factory to see if this pattern can be graded in at 800.334.7891.

### Fabrics & Leathers

Please visit our Seating Fabrics page at [darran.com/textilesleather](http://darran.com/textilesleather)

Camira  
[www.camirafabrics.com](http://www.camirafabrics.com)  
 800.334.789

Wollsdorf  
[www.wollsdorf.com](http://www.wollsdorf.com)  
 336.884.5005

CFStinson  
[www.cfstinson.com](http://www.cfstinson.com)  
 800.841.6279

Green Hides  
[www.greenhides.com](http://www.greenhides.com)  
 336.315.9720

DesignTex  
[www.designtex.com](http://www.designtex.com)  
 800.797.4949

Maharam  
[www.maharam.com](http://www.maharam.com)  
 800.645.3943

Momentum Textiles  
[www.momentumtextiles.com](http://www.momentumtextiles.com)  
 800.366.6839

Ultrafabrics  
[www.ultrafabricsinc.com](http://www.ultrafabricsinc.com)  
 800.334.7891

Application instructions must be specified on the purchase order or COM / COL submission form. In the absence of application instructions, DARRAN will apply materials accordingly.

### CAL117

All DARRAN seating products conform to California Technical Bulletin 117 as a minimum standard.

### CAL133

To meet the California Technical Bulletin 133 flammability regulation, a combination of proper materials must be used to pass, as it tests the fire resistance of a finished product. Flame resistant fabric, a fire blocker material and special foam must be used to pass CAL133 fire codes.

Testing is available for all seating products with the following fees and considerations:

- If laboratory certification is not required, any style can be manufactured to comply with California Technical Bulletin 133 for \$75 list per yard required. (Customer's Own Materials must factor in additional yardage requirements based on repeat.)
- The purchase order must clearly indicate the requirement of California Technical Bulletin 133
- If laboratory California Technical Bulletin 133 certification is required, the cost of testing a chair is \$820 NET, plus the cost of the chair and covering material.
- An additional lead time of 4 to 6 weeks is required for testing for CAL133.
- Once testing is completed, we will provide a certification letter specific to the sample tested for CAL133.
- DARRAN's manufacturing procedures for California TB 133 compliance are based on the testing of representative style with specific fabrics. Please contact Customer Service for an updated list of tested models.
- A copy of test certification is available upon request.

## Bota seating fabric & leather program

### Combination fabrics

DARRAN is pleased to offer customers the design freedom of combination fabrics. When using fabric, vinyl or leather combinations, pricing will be as follows:

- When combining two materials of the same grade, pricing will be specified grade + 5%.
- If combining two materials of different grades or leather/ fabric combination, use the highest grade/price + 5%.
- If using COM or COL, pricing will be COM or COL + 5%. If both COM + COL are used in combination, use COL + 5%

### COM/COL ordering instructions

Please complete the COM Submission Form prior to ordering the fabric from the supplier. All COM fabrics must be approved prior to order submission. Please refer to our website or contact DARRAN Seating Customer Service for an updated list of preapproved COM fabrics. Application instructions must be specified on the purchase order or COM/COL submission form. In the absence of application instructions, DARRAN will apply materials in the best manner and cannot be held responsible for tailoring or application objections after upholstering. COM orders will be scheduled for production after receipt of the material. Packages must be clearly marked and the fabric must be first quality, continuous yardage.

### COM/COL yardage requirements

The yardage requirements stated in this price list for each style are calculated using 54" wide, non-directional fabrics. For fabrics with a different width or for patterns with repeats, please refer to the below chart to calculate the additional percent of fabric required:

Fabric Width	Plain Fabric	2" - 14" Repeat	15" - 19" Repeat	20" - 27" Repeat	28" - 36" Repeat
54"	0	15%	20%	25%	30%
53"	6%	19%	24%	28%	36%
52"	13%	23%	28%	33%	38%
51"	19%	26%	31%	36%	41%
50"	25%	30%	35%	40%	45%
49"	30%	35%	40%	45%	50%
48"	35%	40%	45%	50%	55%
47"	45%	50%	55%	58%	65%

## Bota seating fabric & leather program

NOTE: Prior To Completion Of This Form, Please Refer To Our Graded In Materials Program For Preapproved Fabrics/Leathers.

### COM/COL Approval

DARRAN Furniture Industries  
 2402 Shore Street, High Point, NC 27263  
 ATTN: Seating Division / COM/COL Approval  
 TAG: DARRAN Purchase Order Number

### Shipping approved COM/COL materials

DARRAN Furniture Industries  
 2402 Shore Street, High Point, NC 27263  
 ATTN: Seating Division / COM/COL Approval  
 TAG: DARRAN Purchase Order Number

Please complete this form, attach a 6"x 6" sample and mail to the COM/COL APPROVAL address shown above.  
 This form can also be downloaded from our website at [www.darran.com/leathers](http://www.darran.com/leathers) OR [www.darran.com/fabrics](http://www.darran.com/fabrics)

Purchase Order # \_\_\_\_\_  
 Dealer's Name \_\_\_\_\_  
 Contact \_\_\_\_\_  
 Address \_\_\_\_\_  
 Telephone \_\_\_\_\_  
 Email \_\_\_\_\_  
 Chair Stlye \_\_\_\_\_  
 Manufacturer \_\_\_\_\_  
 Pattern Name \_\_\_\_\_  
 Pattern Color \_\_\_\_\_  
 Content \_\_\_\_\_  
 Repeat \_\_\_\_\_

Please specify any special requirements and check the application above.

\_\_\_\_\_  
 \_\_\_\_\_  
 \_\_\_\_\_

ATTACH 6" X 6" FABRIC/LEATHER SAMPLE HERE

**NOTE**

Actual Fabric/Leather samples needed instead of digital images. If digital images are sent in lieu of samples, DARRAN will only verify the pattern and will not take responsibility for color variances that cannot be verified due to printing restrictions

In the absence of application instructions, DARRAN will apply the material in the best manner and cannot be held responsible for tailoring or application objections after upholstering.

Unless otherwise instructed on the purchase order, excess COM materials will be recycled at the discretion of DARRAN after six months of the original product ship date.

The COM approval solely pertains to the application of the fabric onto the specified DARRAN seating product. DARRAN's approval or acceptance does not constitute any responsibility or warranty to the overall appearance, durability, flammability, defects, dye lot variations or colorfastness of the COM. It is the customer's responsibility to ensure the COM meets CAL 117 compliance and are first quality continuous goods.

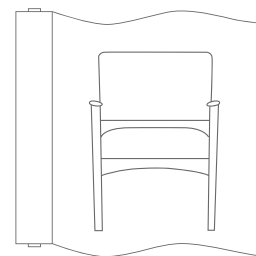

**RAILROAD**

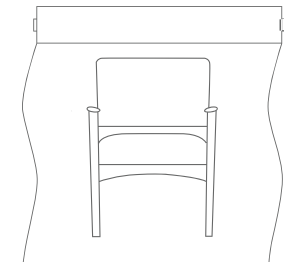

**SETUP**



## Bota seating specification

Joints are securely fastened with mortise and tenon joinery as well as corner block construction to ensure long-term use.

### Ability to incorporate variety of options

Tablet mounts and combination fabrics.

### Complete domestic production

Complete domestic production from frame through upholstery, controlled by one manufacturing facility. Less stress / damage to chair parts normally caused by overseas transit, providing consistent, reliable quality standards as a quick response to shorter lead times.

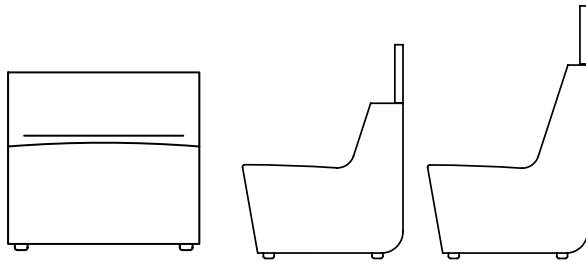

Offered in Low or high back. Seats and back are webbed to enhance comfort, sustainability and endurance. Frame constructed CNC cut engineered wood to maximize the strength, precise measurements and overall longevity. Soy-based, high resilient polyurethane foam consisting of multiple densities in seat and backs, achieving maximum comfort and durability.

Optional tablet or rear tables offered in 1/2" compact laminate featuring a black core. Tablets are center mounted between 2 seats. Horizontal back frame provides easy ganging capabilities for expansion and flexibility in various settings.

Rear tables are at 28.5" high on low back units, and 35.5" high on high back units.

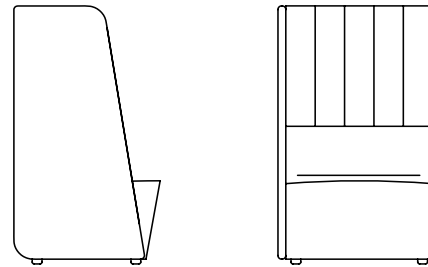

Side Screens and Back Privacy screens create private areas to focus or define a team.

Privacy Screens are available in 10.5", 17.5" & 24.75"

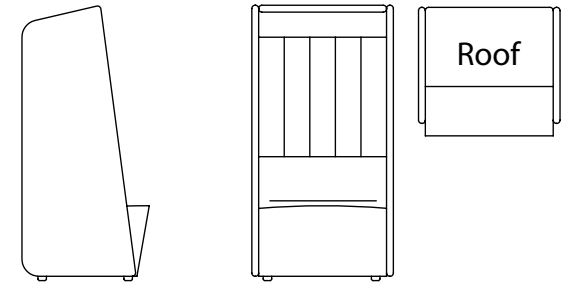

The Bota Roof allows for sound to be absorbed creating a focus nook.

Available in a single or double seat module.

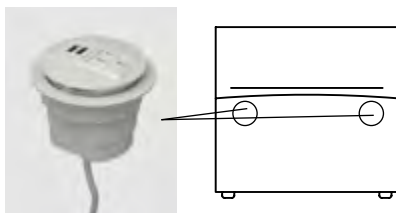

Specify power

Node features 1 power & 1 USB duplex, ideal for charging tablets and other USB-friendly electronics. Node is UL approved.

Specify location, see page 64 for additional details.

bota circler specification

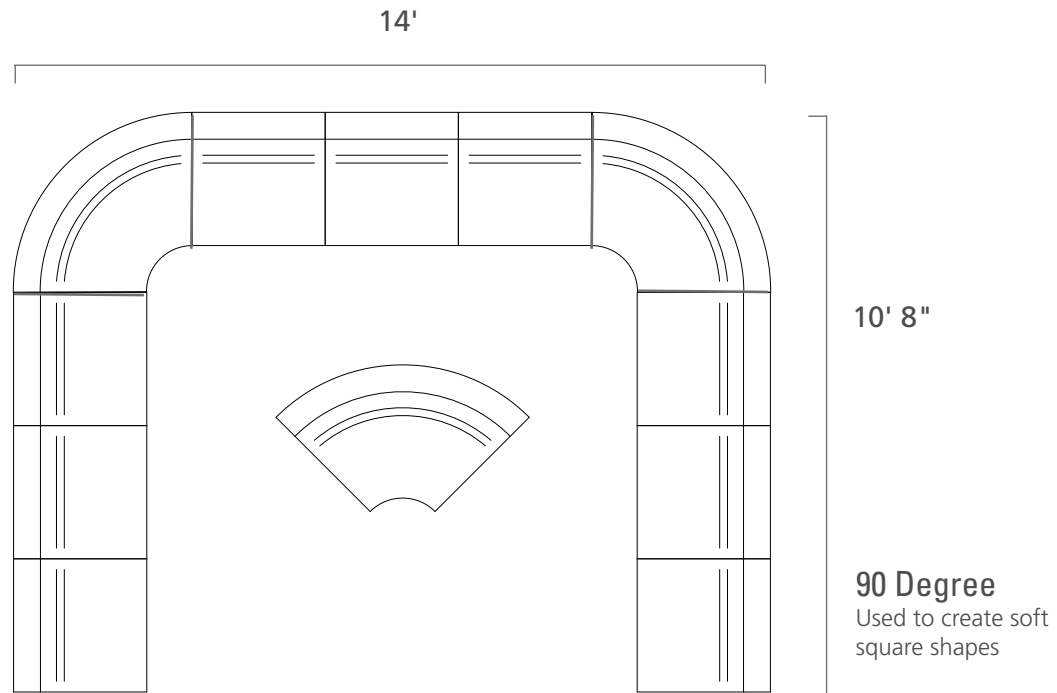
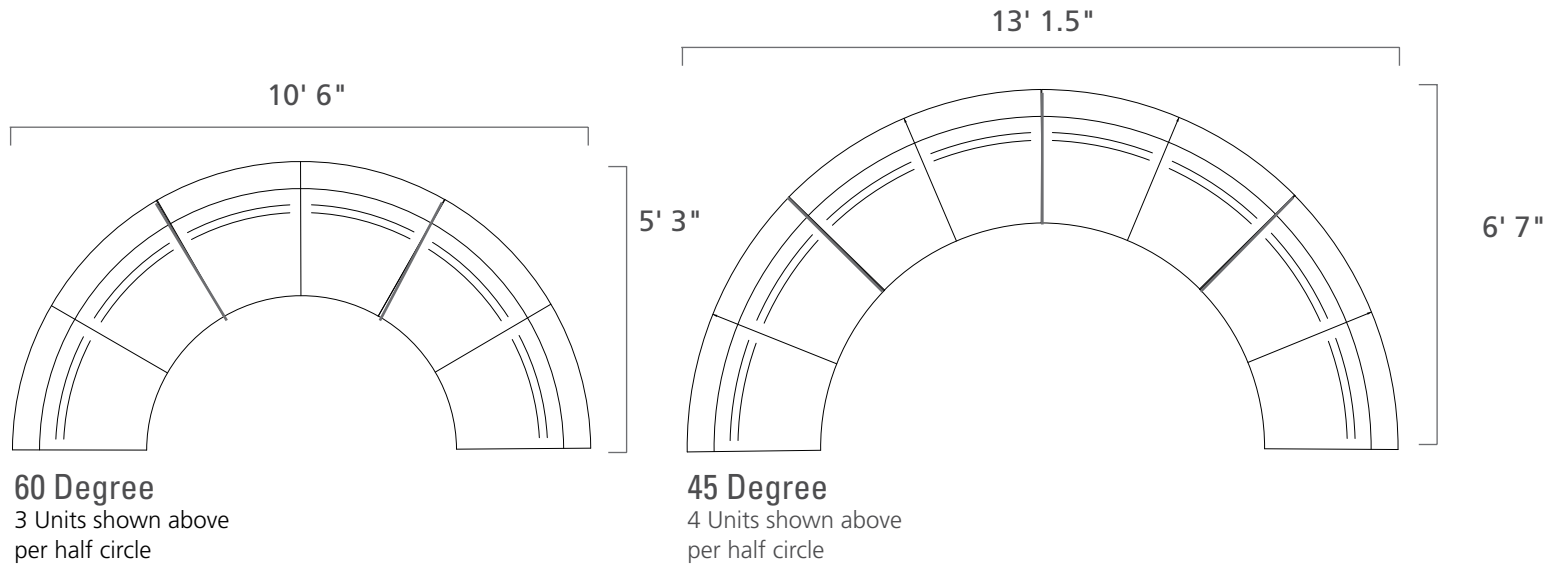

bota rear tables specification

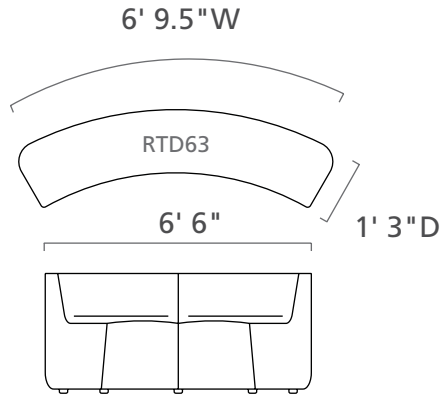
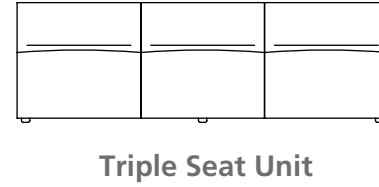
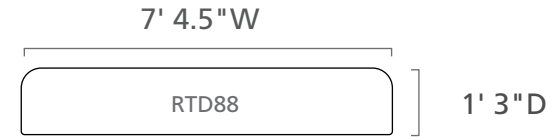
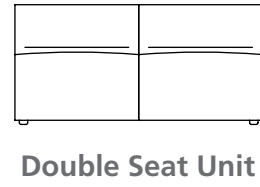
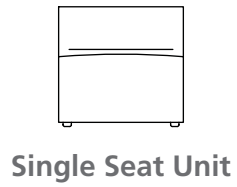

60 Degree Unit

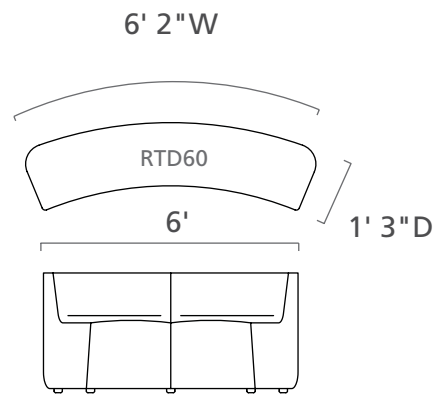

45 Degree Unit

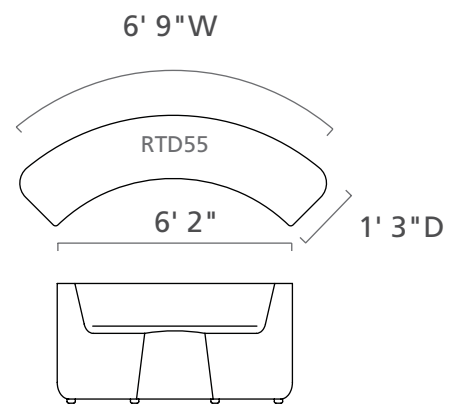

90 Degree Unit

## Bota grommet placement

### Booth wall exterior

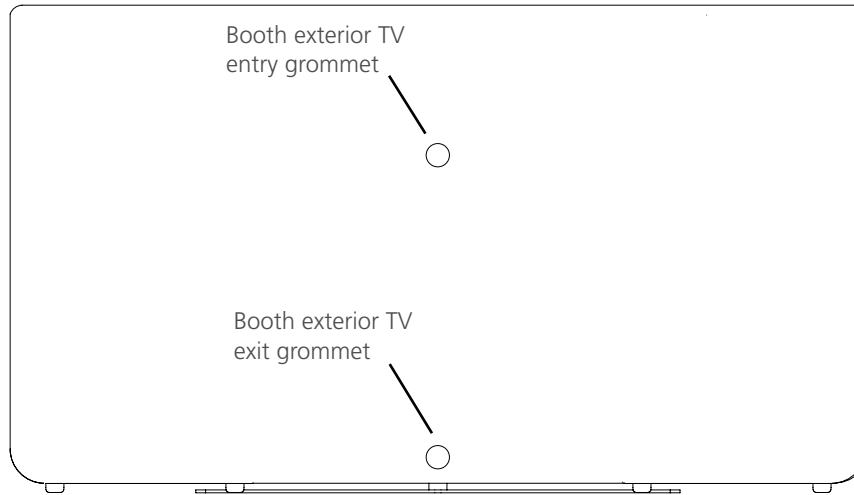

### Booth wall interior

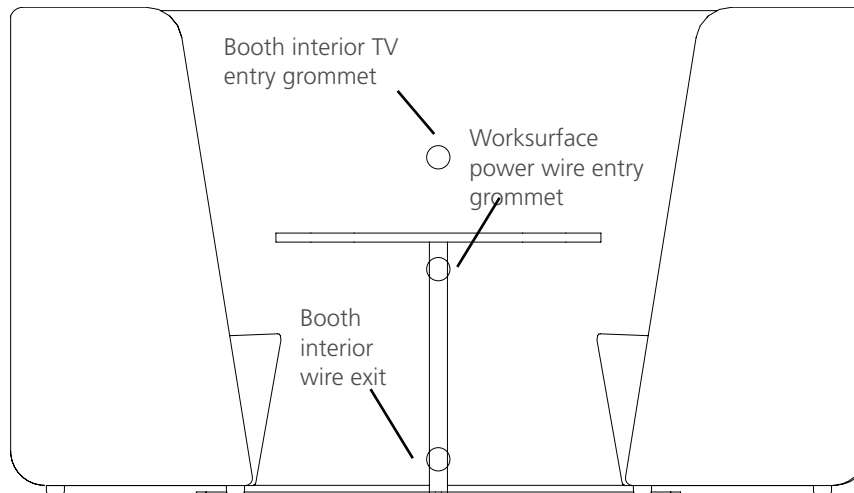

## Bota booth grommet placement

Bota booth walls have an integrated wire management channel built into the frame. Grommets are available in black or white.

The channel runs through the center of the wall, allowing cables to enter and exit. Specify interior or exterior location.

## Bota finishes

STANDARD VENEER	PREMIUM VENEER	HIGH PRESSURE LAMINATE	THERMALLY FUSED LAMINATE
WLA Lofty Ash.....	N/A .....	N/A .....	N/A
WEC Ebony .....	N/A .....	GEC Ebony .....	MEC Ebony
WAM Alabaster Maple .....	N/A .....	GAM Alabaster Maple.....	N/A
WCM Clear Maple.....	N/A .....	GCM Clear Maple .....	N/A
WWW Wheat Maple.....	N/A .....	GWM Wheat Maple .....	N/A
N/A.....	WBO Blush Oak .....	N/A .....	N/A
N/A.....	WMO Mocha Oak .....	N/A .....	N/A
N/A.....	WNO Natural Oak.....	N/A .....	N/A
N/A.....	WSO Salted Oak .....	N/A .....	N/A
WGW Gunstock Walnut.....	N/A .....	N/A .....	MGW Gunstock Walnut
WBW Henna Walnut.....	N/A .....	N/A .....	N/A
WSW Smokey Walnut .....	N/A .....	N/A .....	N/A
WNW Natural Walnut.....	N/A .....	GNW Natural Walnut .....	N/A
N/A.....	TSTV Studio Teak Walnut.....	GSTV Studio Teak Walnut .....	MTW Studio Teak Walnut
N/A.....	TSMV Seattle Mist.....	N/A .....	N/A
N/A.....	TSLV Skyline Walnut .....	GSLV Skyline Walnut .....	MSW Skyline Walnut
WWP Designer White Paint.....	N/A .....	GWL Designer White .....	MWL Designer White

HPL TOPS ON TFL PRODUCTS ADD 10% - AVAILABLE WITH FLAT EDGE ONLY

Send 3x3 or larger finish chip for color match. Custom finish upcharge is 3% or \$250 Net (whichever is greater).

## Finish

ENVI-CT Green Certified European Technology Coatings Finish.

## 1/2" Compact laminate finishes

(Black Core)

LAW Alaska Matte

LNB Nero Matte

Compact laminate is a paper fiber-based solid surface material. Matte Compact Laminate has a soft-and silky texture that feels velvety to the touch, while resisting smears, smudges and fingerprints. Compact laminate is essentially very thick HPL. Extra layers of paper in the core gives it its thickness and strength, as well as its characteristic black core.

bota.

Single Seat  
Low Back

1 model	COM	COL	1	2	3	4	5	6	7	8	9	10	11/L1	12	13/L2
BOT0160SLC01	1569	1661	1699	1754	1809	1864	1919	1974	2029	2084	2139	2194	2249	2304	2414
W x D x H			Upholstery Requirements												
29.5 x 29.25 x 28.5			Fabric yds: 3.5 Leather Sq. Ft.: 63												
Arm Height: -			Carton Weight: 50												
Seat Height: 17.5															
Inside Seat Depth: 17															
Inside Seat Width: 29.5															

2 Select a finish  
[View finish details](#)

3 Combination Fabrics  
[View finish details](#)

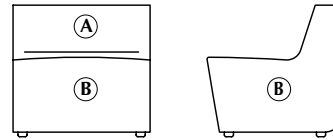

Top View

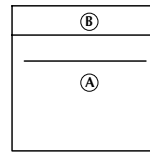

Node Power Placement Option

Table Power

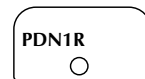

Seat Power

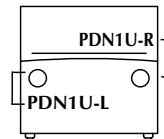

DARRAN is pleased to offer customers the design freedom of combination fabrics. When using fabric, vinyl or leather combinations, pricing/yardage requirements will be as follows:

A Inside Back & Seat 1 yd  
B Lounge Exterior 3 yds

- When combining two materials of the same grade, pricing will be specified grade + 5%
- If combining two materials of different grades or leather/fabric combination, use the highest grade/price + 5%
- If using COM or COL, pricing will be COM or COL + 5%.
- If both COM + COL are used in combination, use COL + 5%.

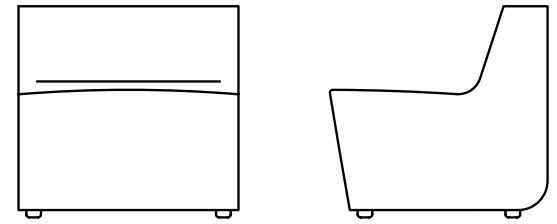

[View statement of line](#)

Product features.

- Horizontal back provides easy ganging capabilities.
- Utilizes elastic webbing suspension that conforms to individual's lumbar curvatures for adaptive support.
- All units are standard with 1" adjustable glides that allow for leveling

Options.

GANGING DEVICE

- GDEV-L: Left Facing Ganging Device - \$20
- GDEV-R: Right Facing Ganging Device - \$20
- GDEV-C: Center Ganging Device - \$40

POWER

- PDN1U-L: Node in Left Facing Seat Front; 1 Power/1 USB Charger - \$325
- PDN1U-R: Node in Right Facing Seat Front; 1 Power/1 USB Charger - \$325
- PDN1U-B: Node in Both Left and Right Facing Seat Front; 1 Power/1 USB Charger per pod - \$650
- PDN1R- Node in Rear Mount Table Top; 1 Power/1 USB Charger - \$375
- Standard in White (Available in Silver and Black)

1/2" COMPACT MATTE LAMINATE REAR TABLE

- Matte Laminate RTD29: Rear Work Table - \$580, Specify LAW Alaska or LNB Nero Finish
- Rear table available on units that gang providing stability
- Rear table is mounted at 28.5"

PREMIUM FINISH OPTION (STANDARD WHITE)

- Specify rear table bracket metal finish color - \$100 per unit
- MFS: Silver, MFB: Black

DARRAN

bota.

Single Seat With Privacy Screen  
Low Back - 10.5" Privacy Screen

1 model	COM	COL	1	2	3	4	5	6	7	8	9	10	11/L1	12	13/L2
BOT0160SLC11	2140	2254	2307	2389	2471	2553	2635	2717	2799	2881	2963	3045	3127	3209	3373
W x D x H 29.5 x 29.25 x 39 Arm Height: - Seat Height: 17.5 Inside Seat Depth: 17 Inside Seat Width: 29.5			Upholstery Requirements Fabric yds: 4.5 Leather Sq. Ft.: 81 Carton Weight: 55												

2 Select a finish  
[View finish details](#)

3 Combination Fabrics  
[View finish details](#)

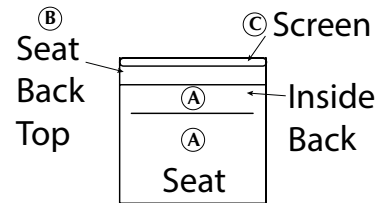
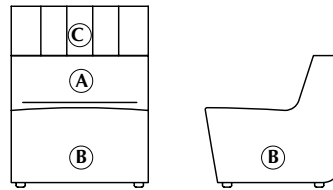

Node Power Placement Option

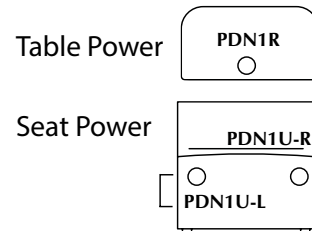

DARRAN is pleased to offer customers the design freedom of combination fabrics. When using fabric, vinyl or leather combinations, pricing/yardage requirements will be as follows:

- A Inside Back & Seat 1 yd
- B Lounge Exterior 3 yds
- C Privacy Screen 1 yd

- When combining two materials of the same grade, pricing will be specified grade + 5%
- If combining two materials of different grades or leather/fabric combination, use the highest grade/price + 5%
- If using COM or COL, pricing will be COM or COL + 5%.
- If both COM + COL are used in combination, use COL + 5%.

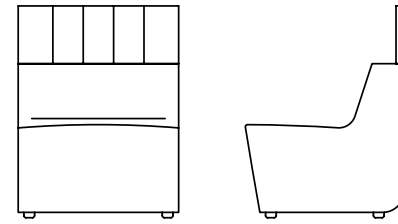

[View statement of line](#)

Product features.

- Horizontal back provides easy ganging capabilities.
- Utilizes elastic webbing suspension that conforms to individual's lumbar curvatures for adaptive support.
- Upholstered Privacy Screen
- Upholstered screens can be specified in contrasting fabrics, vinyl, or leathers.
- All units are standard with 1" adjustable glides that allow for leveling

Options.

GANGING DEVICE

- GDEV-L: Left Facing Ganging Device - \$20
- GDEV-R: Right Facing Ganging Device - \$20
- GDEV-C: Center Ganging Device - \$40

POWER

- PDN1U-L: Node in Left Facing Seat Front; 1 Power/1 USB Charger - \$325
- PDN1U-R: Node in Right Facing Seat Front; 1 Power/1 USB Charger - \$325
- PDN1U-B: Node in Both Left and Right Facing Seat Front; 1 Power/1 USB Charger per pod - \$650
- PDN1R- Node in Rear Mount Table Top; 1 Power/1 USB Charger - \$375
- Standard in White (Available in Silver and Black)
- 1/2" COMPACT MATTE LAMINATE REAR TABLE
- Matte Laminate RTD29: Rear Work Table - \$580, Specify LAW Alaska or LNB Nero Finish
- Rear table available on units that gang providing stability
- Rear table is mounted at 28.5"
- PREMIUM FINISH OPTION (STANDARD WHITE)
- Specify rear table bracket metal finish color - \$100 per unit
- MFS: Silver, MFB: Black

bota.

Single Seat With Privacy Screen  
Low Back - 24.75" Privacy Screen

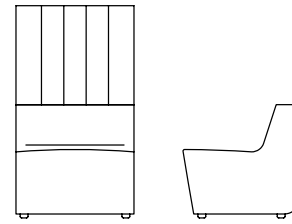

[View statement of line](#)

## Product features.

- Horizontal back provides easy ganging capabilities.
- Utilizes elastic webbing suspension that conforms to individual's lumbar curvatures for adaptive support.
- Upholstered Privacy Screen
- Upholstered screens can be specified in contrasting fabrics, vinyl, or leathers.
- All units are standard with 1" adjustable glides that allow for leveling

DARRAN™

1 model	COM	COL	1	2	3	4	5	6	7	8	9	10	11/L1	12	13/L2
BOT0160SLC21	2371	2513	2556	2647	2738	2829	2920	3011	3102	3193	3284	3375	3466	3557	3739
W x D x H			Upholstery Requirements												
29.5 x 29.25 x 53.25			Fabric yds: 5 Leather Sq. Ft.: 90												
Arm Height: -			Carton Weight: 65												
Seat Height: 17.5															
Inside Seat Depth: 17															
Inside Seat Width: 29.5															

## 2 Select a finish

[View finish details](#)

## 3 Combination Fabrics

[View finish details](#)

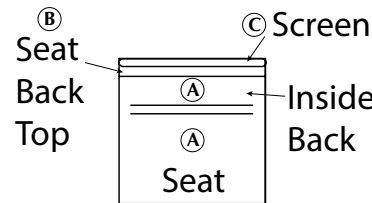
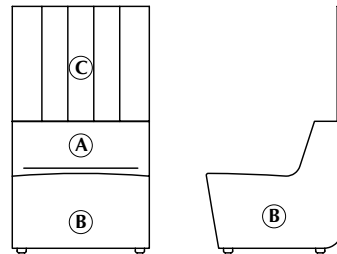

DARRAN is pleased to offer customers the design freedom of combination fabrics. When using fabric, vinyl or leather combinations, pricing/yardage requirements will be as follows:

**A** Inside Back & Seat 1 yd  
**B** Lounge Exterior 3 yds  
**C** Privacy Screen 1.5 yds

- When combining two materials of the same grade, pricing will be specified grade + 5%
- If combining two materials of different grades or leather/fabric combination, use the highest grade/price + 5%
- If using COM or COL, pricing will be COM or COL + 5%.
- If both COM + COL are used in combination, use COL + 5%.

### Node Power Placement Option

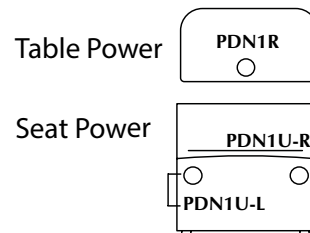

## Options.

### GANGING DEVICE

- GDEV-L: Left Facing Ganging Device - \$20
- GDEV-R: Right Facing Ganging Device - \$20
- GDEV-C: Center Ganging Device - \$40

### POWER

- PDN1U-L: Node in Left Facing Seat Front; 1 Power/1 USB Charger - \$325
- PDN1U-R: Node in Right Facing Seat Front; 1 Power/1 USB Charger - \$325
- PDN1U-B: Node in Both Left and Right Facing Seat Front; 1 Power/1 USB Charger per pod - \$650
- PDN1R- Node in Rear Mount Table Top; 1 Power/1 USB Charger - \$375
- Standard in White (Available in Silver and Black)
- **1/2" COMPACT MATTE LAMINATE REAR TABLE**
- Matte Laminate RTD29: Rear Work Table - \$580, Specify LAW Alaska or LNB Nero Finish
- Rear table available on units that gang providing stability
- Rear table is mounted at 28.5"

### PREMIUM FINISH OPTION (STANDARD WHITE)

- Specify rear table bracket metal finish color - \$100 per unit
- MFS: Silver, MFB: Black



bota.

Single Seat  
High Back

1 model	COM	COL	1	2	3	4	5	6	7	8	9	10	11/L1	12	13/L2
BOT0160SHC01	1750	1850	1898	1971	2044	2117	2190	2263	2336	2409	2482	2555	2628	2701	2847
W x D x H 29.5 x 29.25 x 35.5 Arm Height: - Seat Height: 17.5 Inside Seat Depth: 17 Inside Seat Width: 29.5			Upholstery Requirements Fabric yds: 4 Leather Sq. Ft.: 72 Carton Weight: 50												

2 Select a finish  
[View finish details](#)

3 Combination Fabrics  
[View finish details](#)

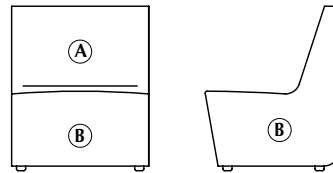

Top View

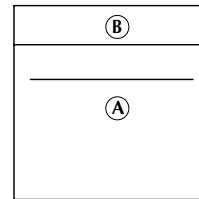

Node Power Placement Option

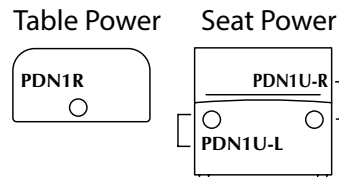

**DARRAN is pleased to offer customers the design freedom of combination fabrics. When using fabric, vinyl or leather combinations, pricing/yardage requirements will be as follows:**

**A Inside Back & Seat 1.5 yds**  
**B Lounge Exterior 3 yds**

- When combining two materials of the same grade, pricing will be specified grade + 5%
- If combining two materials of different grades or leather/fabric combination, use the highest grade/price + 5%
- If using COM or COL, pricing will be COM or COL + 5%.
- If both COM + COL are used in combination, use COL + 5%.

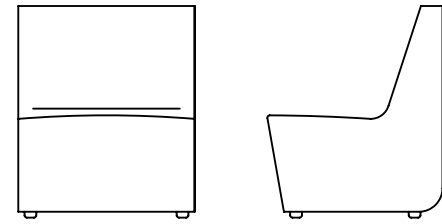

[View statement of line](#)

**Product features.**

- Horizontal back provides easy ganging capabilities.
- Utilizes elastic webbing suspension that conforms to individual's lumbar curvatures for adaptive support.
- All units are standard with 1" adjustable glides that allow for leveling

**Options.**

**GANGING DEVICE**

- GDEV-L: Left Facing Ganging Device - \$20
- GDEV-R: Right Facing Ganging Device - \$20
- GDEV-C: Center Ganging Device - \$40

**POWER**

- PDN1U-L: Node in Left Facing Seat Front; 1 Power/1 USB Charger - \$325
- PDN1U-R: Node in Right Facing Seat Front; 1 Power/1 USB Charger - \$325
- PDN1U-B: Node in Both Left and Right Facing Seat Front; 1 Power/1 USB Charger per pod - \$650
- PDN1R- Node in Rear Mount Table Top; 1 Power/1 USB Charger - \$375
- Standard in White (Available in Silver and Black)

**1/2" COMPACT MATTE LAMINATE REAR TABLE**

- Matte Laminate RTD29: Rear Work Table - \$580, Specify LAW Alaska or LNB Nero Finish
- Rear table available on units that gang providing stability
- Rear table is mounted at 35.5"

**PREMIUM FINISH OPTION (STANDARD WHITE)**

- Specify rear table bracket metal finish color - \$100 per unit
- MFS: Silver, MFB: Black

DARRAN

bota.

Single Seat With Privacy Screen  
High Back - 10.5" Privacy Screen

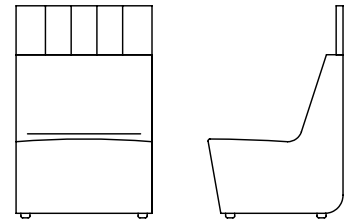

[View statement of line](#)

Product features.

- Horizontal back provides easy ganging capabilities.
- Utilizes elastic webbing suspension that conforms to individual's lumbar curvatures for adaptive support.
- Upholstered Privacy Screen
- Upholstered screens can be specified in contrasting fabrics, vinyl, or leathers.
- All units are standard with 1" adjustable glides that allow for leveling

1 model	COM	COL	1	2	3	4	5	6	7	8	9	10	11/L1	12	13/L2
BOT0160SHC11	2289	2411	2474	2565	2656	2747	2838	2929	3020	3111	3202	3293	3384	3475	3657
W x D x H			Upholstery Requirements												
29.5 x 29.25 x 46			Fabric yds: 5 Leather Sq. Ft.: 90												
Arm Height: -			Carton Weight: 60												
Seat Height: 17.5															
Inside Seat Depth: 17															
Inside Seat Width: 29.5															

2 Select a finish  
[View finish details](#)

3 Combination Fabrics  
[View finish details](#)

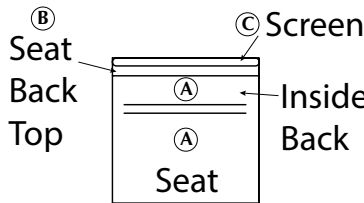
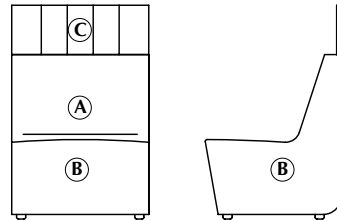

DARRAN is pleased to offer customers the design freedom of combination fabrics. When using fabric, vinyl or leather combinations, pricing/yardage requirements will be as follows:

- A** Inside Back & Seat 2.5 yds
- B** Lounge Exterior 4 yds
- C** Privacy Screen 2 yd

- When combining two materials of the same grade, pricing will be specified grade + 5%
- If combining two materials of different grades or leather/fabric combination, use the highest grade/price + 5%
- If using COM or COL, pricing will be COM or COL + 5%.
- If both COM + COL are used in combination, use COL + 5%.

Node Power Placement Option

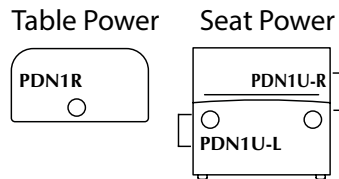

Options.

**GANGING DEVICE**

- GDEV-L: Left Facing Ganging Device - \$20
- GDEV-R: Right Facing Ganging Device - \$20
- GDEV-C: Center Ganging Device - \$40

**POWER**

- PDN1U-L: Node in Left Facing Seat Front; 1 Power/1 USB Charger - \$325
- PDN1U-R: Node in Right Facing Seat Front; 1 Power/1 USB Charger - \$325
- PDN1U-B: Node in Both Left and Right Facing Seat Front; 1 Power/1 USB Charger per pod - \$650
- PDN1R- Node in Rear Mount Table Top; 1 Power/1 USB Charger - \$375
- Standard in White (Available in Silver and Black)
- **1/2" COMPACT MATTE LAMINATE REAR TABLE**
- Matte Laminate RTD29: Rear Work Table - \$580, Specify LAW Alaska or LNB Nero Finish
- Rear table available on units that gang providing stability
- Rear table is mounted at 35.5"

**PREMIUM FINISH OPTION (STANDARD WHITE)**

- Specify rear table bracket metal finish color - \$100 per unit
- MFS: Silver, MFB: Black

bota.

Single Seat With Privacy Screen  
High Back - 17.5" Privacy Screen

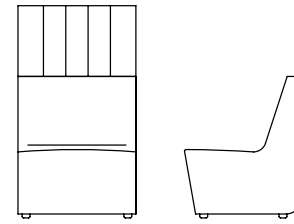

[View statement of line](#)

Product features.

- Horizontal back provides easy ganging capabilities.
- Utilizes elastic webbing suspension that conforms to individual's lumbar curvatures for adaptive support.
- Upholstered Privacy Screen
- Upholstered screens can be specified in contrasting fabrics, vinyl, or leathers.
- All units are standard with 1" adjustable glides that allow for leveling

1 model	COM	COL	1	2	3	4	5	6	7	8	9	10	11/L1	12	13/L2
BOT0160SHC21	2455	2592	2659	2759	2859	2959	3059	3159	3259	3359	3459	3559	3659	3759	3959
W x D x H 29.5 x 29.25 x 53 Arm Height: - Seat Height: 17.5 Inside Seat Depth: 17 Inside Seat Width: 29.5			Upholstery Requirements Fabric yds: 5.5 Leather Sq. Ft.: 99 Carton Weight: 65												

2 Select a finish  
[View finish details](#)

3 Combination Fabrics  
[View finish details](#)

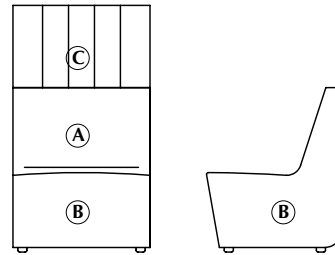

DARRAN is pleased to offer customers the design freedom of combination fabrics. When using fabric, vinyl or leather combinations, pricing/yardage requirements will be as follows:

- A Inside Back & Seat 1.5 yds
- B Lounge Exterior 3 yds
- C Privacy Screen 1.5 yds

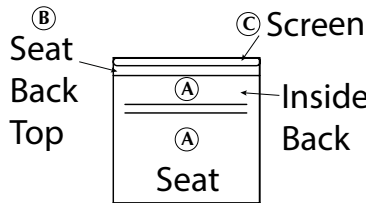

- When combining two materials of the same grade, pricing will be specified grade + 5%
- If combining two materials of different grades or leather/fabric combination, use the highest grade/price + 5%
- If using COM or COL, pricing will be COM or COL + 5%.
- If both COM + COL are used in combination, use COL + 5%.

Node Power Placement Option

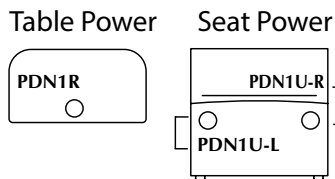

Options.

**GANGING DEVICE**

- GDEV-L: Left Facing Ganging Device - \$20
- GDEV-R: Right Facing Ganging Device - \$20
- GDEV-C: Center Ganging Device - \$40

**POWER**

- PDN1U-L: Node in Left Facing Seat Front; 1 Power/1 USB Charger - \$325
- PDN1U-R: Node in Right Facing Seat Front; 1 Power/1 USB Charger - \$325
- PDN1U-B: Node in Both Left and Right Facing Seat Front; 1 Power/1 USB Charger per pod - \$650
- PDN1R- Node in Rear Mount Table Top; 1 Power/1 USB Charger - \$375
- Standard in White (Available in Silver and Black)

**1/2" COMPACT MATTE LAMINATE REAR TABLE**

- Matte Laminate RTD29: Rear Work Table - \$580, Specify LAW Alaska or LNB Nero Finish
- Rear table available on units that gang providing stability
- Rear table is mounted at 35.5"

**PREMIUM FINISH OPTION (STANDARD WHITE)**

- Specify rear table bracket metal finish color - \$100 per unit
- MFS: Silver, MFB: Black

bota.

Double Seat  
Low Back

1 model	COM	COL	1	2	3	4	5	6	7	8	9	10	11/L1	12	13/L2
BOT0160DLC02	2700	2857	2922	3031	3140	3249	3358	3467	3576	3685	3794	3903	4012	4121	4339
W x D x H			Upholstery Requirements												
59 x 29.25 x 28.5			Fabric yds: 6 Leather Sq. Ft.: 108												
Arm Height: -			Carton Weight: 90												
Seat Height: 17.5															
Inside Seat Depth: 17															
Inside Seat Width: 29.5															

2 Select a finish  
[View finish details](#)

3 Combination Fabrics  
[View finish details](#)

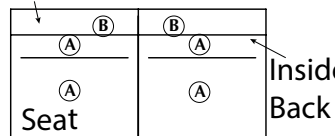
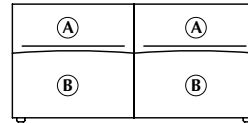
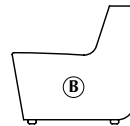

**DARRAN is pleased to offer customers the design freedom of combination fabrics. When using fabric, vinyl or leather combinations, pricing/yardage requirements will be as follows:**

**A Inside Back & Seat 2 yds**  
**B Lounge Exterior 4 yds**

- When combining two materials of the same grade, pricing will be specified grade + 5%
- If combining two materials of different grades or leather/fabric combination, use the highest grade/price + 5%
- If using COM or COL, pricing will be COM or COL + 5%.
- If both COM + COL are used in combination, use COL + 5%.

### Node Power Placement Option

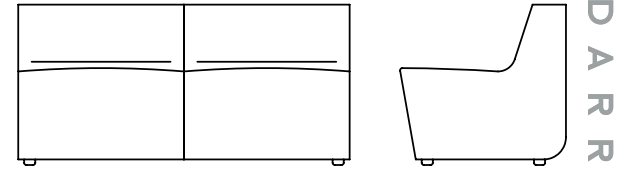
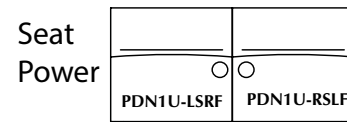

DARRAN™

[View statement of line](#)

## Product features.

- Horizontal back provides easy ganging capabilities.
- Utilizes elastic webbing suspension that conforms to individual's lumbar curvatures for adaptive support.
- All units are standard with 1" adjustable glides that allow for leveling

## Options.

### GANGING DEVICE

- GDEV-L: Left Facing Ganging Device - \$20
- GDEV-R: Right Facing Ganging Device - \$20
- GDEV-C: Center Ganging Device - \$40

### POWER

- PDN1U-LSRF: Node in Left Seat Right Facing Seat Front; 1 Power/1 USB Charger - \$325
- PDN1U-RSLF: Node in Right Seat Left Facing Seat Front; 1 Power/1 USB Charger - \$325
- PDN1U-BC: Node in Both Left and Right Facing Center Seat Front; 1 Power/1 USB Charger per pod - \$650
- PDN1R- Node in Rear Mount Table Top; 1 Power/1 USB Charger - \$375
- Standard in White (Available in Silver and Black)

### 1/2" COMPACT MATTE LAMINATE REAR TABLE

- Matte Laminate RTD59: Rear Work Table - \$790, Specify LAW Alaska or LNB Nero Finish
- Rear table available on units that gang providing stability
- Rear table is mounted at 28.5"

### 1/2" COMPACT MATTE LAMINATE TABLET

- FFD: 1/2" Compact Matte Laminate Tablet - \$570, Specify LAW Alaska or LNB Nero Finish
- Tablet is center mount only

### PREMIUM FINISH OPTION (STANDARD WHITE)

- Specify rear table bracket metal finish color - \$100 per unit
- Specify tablet metal finish color - \$100 per unit
- MFS: Silver, MFB: Black

bota.

Double Seat With Privacy Screen  
Low Back - 10.5" Privacy Screen

1 model	COM	COL	1	2	3	4	5	6	7	8	9	10	11/L1	12	13/L2
BOT0160DLC12	3452	3652	3748	3894	4040	4186	4332	4478	4624	4770	4916	5062	5208	5354	5646
W x D x H			Upholstery Requirements												
59 x 29.25 x 39			Fabric yds: 8 Leather Sq. Ft.: 144												
Arm Height: -			Carton Weight: 110												
Seat Height: 17.5															
Inside Seat Depth: 17															
Inside Seat Width: 29.5															

2 Select a finish  
[View finish details](#)

3 Combination Fabrics  
[View finish details](#)

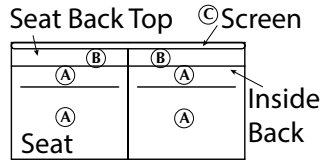
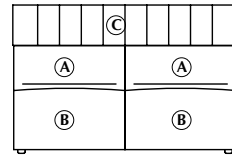
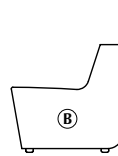

Node Power Placement Option

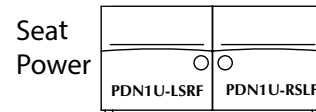

DARRAN is pleased to offer customers the design freedom of combination fabrics. When using fabric, vinyl or leather combinations, pricing/yardage requirements will be as follows:

- A Inside Back & Seat 2 yds
- B Lounge Exterior 4 yds
- C Privacy Screen 2 yds

- When combining two materials of the same grade, pricing will be specified grade + 5%
- If combining two materials of different grades or leather/fabric combination, use the highest grade/price + 5%
- If using COM or COL, pricing will be COM or COL + 5%.
- If both COM + COL are used in combination, use COL + 5%.

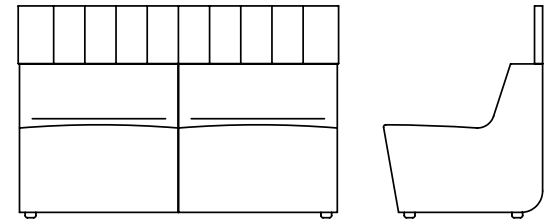

[View statement of line](#)

Product features.

- Horizontal back provides easy ganging capabilities.
- Utilizes elastic webbing suspension that conforms to individual's lumbar curvatures for adaptive support.
- Upholstered Privacy Screen
- Upholstered screens can be specified in contrasting fabrics, vinyl, or leathers.
- All units are standard with 1" adjustable glides that allow for leveling

Options.

GANGING DEVICE

- GDEV-L: Left Facing Ganging Device - \$20
- GDEV-R: Right Facing Ganging Device - \$20
- GDEV-C: Center Ganging Device - \$40

POWER

- PDN1U-LSRF: Node in Left Seat Right Facing Seat Front; 1 Power/1 USB Charger - \$325
- PDN1U-RSLF: Node in Right Seat Left Facing Seat Front; 1 Power/1 USB Charger - \$325
- PDN1U-BC: Node in Both Left and Right Facing Center Seat Front; 1 Power/1 USB Charger per pod - \$650
- PDN1R- Node in Rear Mount Table Top; 1 Power/1 USB Charger - \$375
- Standard in White (Available in Silver and Black)
- 1/2" COMPACT MATTE LAMINATE REAR TABLE
- Matte Laminate RTD59: Rear Work Table - \$790, Specify LAW Alaska or LNB Nero Finish
- Rear table available on units that gang providing stability
- Rear table is mounted at 28.5"

1/2" COMPACT MATTE LAMINATE TABLE

- FFD: 1/2" Compact Matte Laminate Tablet - \$570, Specify LAW Alaska or LNB Nero Finish
- Tablet is center mount only

PREMIUM FINISH OPTION (STANDARD WHITE)

- Specify rear table bracket metal finish color - \$100 per unit
- Specify tablet metal finish color - \$100 per unit
- MFS: Silver, MFB: Black

bota.

Double Seat With Privacy Screen  
Low Back - 24.75" Privacy Screen

1 model	COM	COL	1	2	3	4	5	6	7	8	9	10	11/L1	12	13/L2
BOT0160DLC22	4097	4356	4393	4539	4685	4831	4977	5123	5269	5415	5561	5707	5853	5999	6291
W x D x H			Upholstery Requirements												
59 x 29.25 x 53.25			Fabric yds: 8 Leather Sq. Ft.: 144												
Arm Height: -			Carton Weight: 130												
Seat Height: 17.5															
Inside Seat Depth: 17															
Inside Seat Width: 29.5															

2 Select a finish  
[View finish details](#)

3 Combination Fabrics  
[View finish details](#)

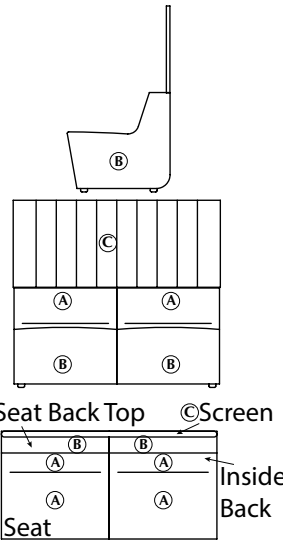

Node Power Placement Option

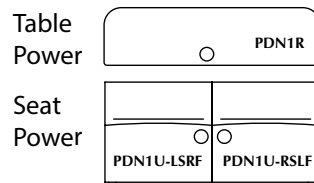

DARRAN is pleased to offer customers the design freedom of combination fabrics. When using fabric, vinyl or leather combinations, pricing/yardage requirements will be as follows:

- A** Inside Back & Seat 2 yds
- B** Lounge Exterior 4 yds
- C** Privacy Screen 3.5 yds

- When combining two materials of the same grade, pricing will be specified grade + 5%
- If combining two materials of different grades or leather/fabric combination, use the highest grade/price + 5%
- If using COM or COL, pricing will be COM or COL + 5%.
- If both COM + COL are used in combination, use COL + 5%.

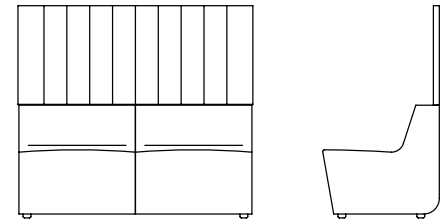

[View statement of line](#)

Product features.

- Horizontal back provides easy ganging capabilities.
- Utilizes elastic webbing suspension that conforms to individual's lumbar curvatures for adaptive support.
- Upholstered Privacy Screen
- Upholstered screens can be specified in contrasting fabrics, vinyl, or leathers.
- All units are standard with 1" adjustable glides that allow for leveling

Options.

**GANGING DEVICE**

- GDEV-L: Left Facing Ganging Device - \$20
- GDEV-R: Right Facing Ganging Device - \$20
- GDEV-C: Center Ganging Device - \$40

**POWER**

- PDN1U-LSRF: Node in Left Seat Right Facing Seat Front; 1 Power/1 USB Charger - \$325
- PDN1U-RSLF: Node in Right Seat Left Facing Seat Front; 1 Power/1 USB Charger - \$325
- PDN1U-BC: Node in Both Left and Right Facing Center Seat Front; 1 Power/1 USB Charger per pod - \$650
- PDN1R- Node in Rear Mount Table Top; 1 Power/1 USB Charger - \$375
- Standard in White (Available in Silver and Black)

**1/2" COMPACT MATTE LAMINATE REAR TABLE**

- Matte Laminate RTD59: Rear Work Table - \$790, Specify LAW Alaska or LNB Nero Finish
- Rear table available on units that gang providing stability
- Rear table is mounted at 28.5"

**1/2" COMPACT MATTE LAMINATE TABLET**

- FFD: 1/2" Compact Matte Laminate Tablet - \$570, Specify LAW Alaska or LNB Nero Finish
- Tablet is center mount only

**PREMIUM FINISH OPTION (STANDARD WHITE)**

- Specify rear table bracket metal finish color - \$100 per unit
- Specify tablet metal finish color - \$100 per unit
- MFS: Silver, MFB: Black

bota.

Double Seat  
High Back

1 model	COM	COL	1	2	3	4	5	6	7	8	9	10	11/L1	12	13/L2
BOT0160DHC02	3002	3174	3243	3362	3481	3600	3719	3838	3957	4076	4195	4314	4433	4552	4790
W x D x H			Upholstery Requirements												
59 x 29.25 x 35.5			Fabric yds: 6.5 Leather Sq. Ft.: 117												
Arm Height: -			Carton Weight: 95												
Seat Height: 17.5															
Inside Seat Depth: 17															
Inside Seat Width: 29.5															

2 Select a finish  
[View finish details](#)

3 Combination Fabrics  
[View finish details](#)

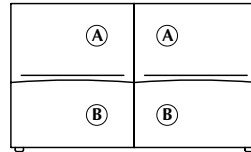
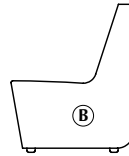

Seat Back Top

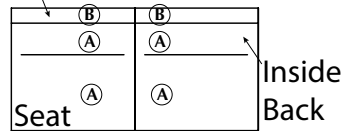

Node Power Placement Option

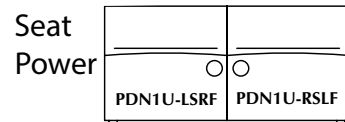

**DARRAN is pleased to offer customers the design freedom of combination fabrics. When using fabric, vinyl or leather combinations, pricing/yardage requirements will be as follows:**

**A Inside Back & Seat 2.5 yds**  
**B Lounge Exterior 4.5 yds**

- When combining two materials of the same grade, pricing will be specified grade + 5%
- If combining two materials of different grades or leather/fabric combination, use the highest grade/price + 5%
- If using COM or COL, pricing will be COM or COL + 5%.
- If both COM + COL are used in combination, use COL + 5%.

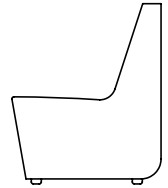
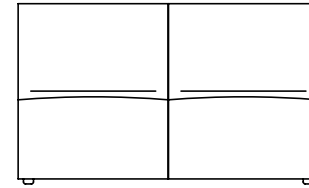

DARRAN™

[View statement of line](#)

## Product features.

- Horizontal back provides easy ganging capabilities.
- Utilizes elastic webbing suspension that conforms to individual's lumbar curvatures for adaptive support.
- All units are standard with 1" adjustable glides that allow for leveling

## Options.

### GANGING DEVICE

- GDEV-L: Left Facing Ganging Device - \$20
- GDEV-R: Right Facing Ganging Device - \$20
- GDEV-C: Center Ganging Device - \$40

### POWER

- PDN1U-LSRF: Node in Left Seat Right Facing Seat Front; 1 Power/1 USB Charger - \$325
- PDN1U-RSLF: Node in Right Seat Left Facing Seat Front; 1 Power/1 USB Charger - \$325
- PDN1U-BC: Node in Both Left and Right Facing Center Seat Front; 1 Power/1 USB Charger per pod - \$650
- PDN1R- Node in Rear Mount Table Top; 1 Power/1 USB Charger - \$375
- Standard in White (Available in Silver and Black)

### 1/2" COMPACT MATTE LAMINATE REAR TABLE

- Matte Laminate RTD59: Rear Work Table - \$790, Specify LAW Alaska or LNB Nero Finish
- Rear table available on units that gang providing stability
- Rear table is mounted at 35.5"

### 1/2" COMPACT MATTE LAMINATE TABLET

- FFD: 1/2" Compact Matte Laminate Tablet - \$570, Specify LAW Alaska or LNB Nero Finish
- Tablet is center mount only

### PREMIUM FINISH OPTION (STANDARD WHITE)

- Specify rear table bracket metal finish color - \$100 per unit
- Specify tablet metal finish color - \$100 per unit
- MFS: Silver, MFB: Black

bota.

Double Seat With Privacy Screen  
High Back - 10.5" Privacy Screen

1 model	COM	COL	1	2	3	4	5	6	7	8	9	10	11/L1	12	13/L2
BOT0160DHC12	3752	3967	4067	4222	4377	4532	4687	4842	4997	5152	5307	5462	5617	5772	6082
W x D x H			Upholstery Requirements												
59 x 29.25 x 46			Fabric yds: 8.5 Leather Sq. Ft.: 153												
Arm Height: -			Carton Weight: 115												
Seat Height: 17.5															
Inside Seat Depth: 17															
Inside Seat Width: 29.5															

2 Select a finish  
[View finish details](#)

3 Combination Fabrics  
[View finish details](#)

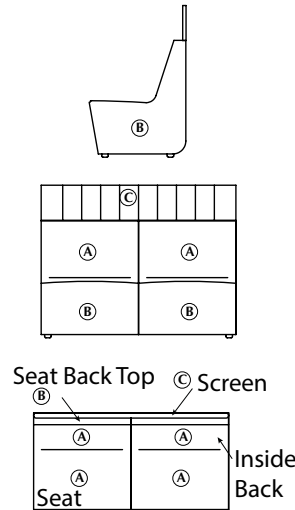

Node Power Placement Option

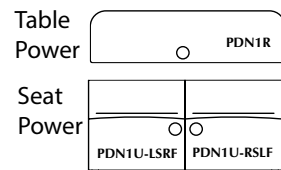

DARRAN is pleased to offer customers the design freedom of combination fabrics. When using fabric, vinyl or leather combinations, pricing/yardage requirements will be as follows:

- A Inside Back & Seat 2.5 yds
- B Lounge Exterior 4.5 yds
- C Privacy Screen 2 yds

- When combining two materials of the same grade, pricing will be specified grade + 5%
- If combining two materials of different grades or leather/fabric combination, use the highest grade/price + 5%
- If using COM or COL, pricing will be COM or COL + 5%.
- If both COM + COL are used in combination, use COL + 5%.

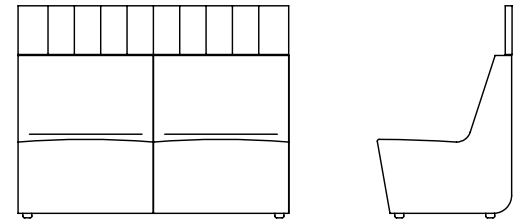

[View statement of line](#)

Product features.

- Horizontal back provides easy ganging capabilities.
- Utilizes elastic webbing suspension that conforms to individual's lumbar curvatures for adaptive support.
- Upholstered Privacy Screen
- Upholstered screens can be specified in contrasting fabrics, vinyl, or leathers.
- All units are standard with 1" adjustable glides that allow for leveling

Options.

GANGING DEVICE

- GDEV-L: Left Facing Ganging Device - \$20
- GDEV-R: Right Facing Ganging Device - \$20
- GDEV-C: Center Ganging Device - \$40

POWER

- PDN1U-LSRF: Node in Left Seat Right Facing Seat Front; 1 Power/1 USB Charger - \$325
  - PDN1U-RSLF: Node in Right Seat Left Facing Seat Front; 1 Power/1 USB Charger - \$325
  - PDN1U-BC: Node in Both Left and Right Facing Center Seat Front; 1 Power/1 USB Charger per pod - \$650
  - PDN1R- Node in Rear Mount Table Top; 1 Power/1 USB Charger - \$375
  - Standard in White (Available in Silver and Black)
- 1/2" COMPACT MATTE LAMINATE REAR TABLE**
- Matte Laminate RTD59: Rear Work Table - \$790, Specify LAW Alaska or LNB Nero Finish
  - Rear table available on units that gang providing stability
  - Rear table is mounted at 35.5"

1/2" COMPACT MATTE LAMINATE TABLE

- FFD: 1/2" Compact Matte Laminate Tablet - \$570, Specify LAW Alaska or LNB Nero Finish
- Tablet is center mount only

PREMIUM FINISH OPTION (STANDARD WHITE)

- Specify rear table bracket metal finish color - \$100 per unit
- Specify tablet metal finish color - \$100 per unit
- MFS: Silver, MFB: Black



bota.

Double Seat With Privacy Screen  
High Back - 17.5" Privacy Screen

1 model	COM	COL	1	2	3	4	5	6	7	8	9	10	11/L1	12	13/L2
BOT0160DHC22	4111	4356	4500	4692	4884	5076	5268	5460	5652	5844	6036	6228	6420	6612	6996
W x D x H			Upholstery Requirements												
59 x 29.25 x 53			Fabric yds: 10.5 Leather Sq. Ft.: 189												
Arm Height: -			Carton Weight: 135												
Seat Height: 17.5															
Inside Seat Depth: 17															
Inside Seat Width: 29.5															

2 Select a finish  
[View finish details](#)

3 Combination Fabrics  
[View finish details](#)

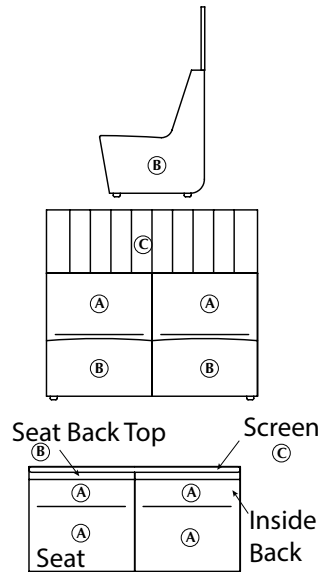

DARRAN is pleased to offer customers the design freedom of combination fabrics. When using fabric, vinyl or leather combinations, pricing/yardage requirements will be as follows:

- A Inside Back & Seat** 2.5 yds
- B Lounge Exterior** 4.5 yds
- C Privacy Screen** 4 yds

- When combining two materials of the same grade, pricing will be specified grade + 5%
- If combining two materials of different grades or leather/fabric combination, use the highest grade/price + 5%
- If using COM or COL, pricing will be COM or COL + 5%.
- If both COM + COL are used in combination, use COL + 5%.

Node Power Placement Option

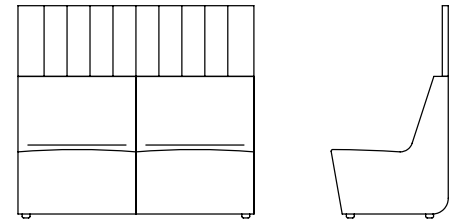
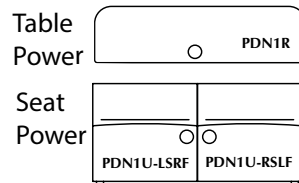

[View statement of line](#)

Product features.

- Horizontal back provides easy ganging capabilities.
- Utilizes elastic webbing suspension that conforms to individual's lumbar curvatures for adaptive support.
- Upholstered Privacy Screen
- Upholstered screens can be specified in contrasting fabrics, vinyl, or leathers.
- All units are standard with 1" adjustable glides that allow for leveling

Options.

**GANGING DEVICE**

- GDEV-L: Left Facing Ganging Device - \$20
- GDEV-R: Right Facing Ganging Device - \$20
- GDEV-C: Center Ganging Device - \$40

**POWER**

- PDN1U-LSRF: Node in Left Seat Right Facing Seat Front; 1 Power/1 USB Charger - \$325
- PDN1U-RSLF: Node in Right Seat Left Facing Seat Front; 1 Power/1 USB Charger - \$325
- PDN1U-BC: Node in Both Left and Right Facing Center Seat Front; 1 Power/1 USB Charger per pod - \$650
- PDN1R- Node in Rear Mount Table Top; 1 Power/1 USB Charger - \$375
- Standard in White (Available in Silver and Black)

**1/2" COMPACT MATTE LAMINATE REAR TABLE**

- Matte Laminate RTD59: Rear Work Table - \$790, Specify LAW Alaska or LNB Nero Finish
- Rear table available on units that gang providing stability
- Rear table is mounted at 35.5"

**1/2" COMPACT MATTE LAMINATE TABLE**

- FFD: 1/2" Compact Matte Laminate Tablet - \$570, Specify LAW Alaska or LNB Nero Finish
- Tablet is center mount only

**PREMIUM FINISH OPTION (STANDARD WHITE)**

- Specify rear table bracket metal finish color - \$100 per unit
- Specify tablet metal finish color - \$100 per unit
- MFS: Silver, MFB: Black

bota.

Triple Seat  
Low Back

1 model	COM	COL	1	2	3	4	5	6	7	8	9	10	11/L1	12	13/L2
BOT0160TLC03	3784	4051	4117	4281	4445	4609	4773	4937	5101	5265	5429	5593	5757	5921	6249
W x D x H			Upholstery Requirements												
88.5 x 29.25 x 28.5			Fabric yds: 8 Leather Sq. Ft.: 144												
Arm Height: -			Carton Weight: 135												
Seat Height: 17.5															
Inside Seat Depth: 17															
Inside Seat Width: 29.5															

2 Select a finish  
[View finish details](#)

3 Combination Fabrics  
[View finish details](#)

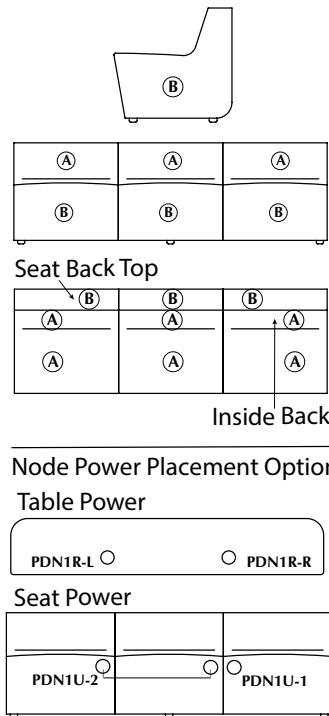

**DARRAN is pleased to offer customers the design freedom of combination fabrics. When using fabric, vinyl or leather combinations, pricing/yardage requirements will be as follows:**

**A Inside Back & Seat 3 yds**  
**B Lounge Exterior 6 yds**

- When combining two materials of the same grade, pricing will be specified grade + 5%
- If combining two materials of different grades or leather/fabric combination, use the highest grade/price + 5%
- If using COM or COL, pricing will be COM or COL + 5%.
- If both COM + COL are used in combination, use COL + 5%.

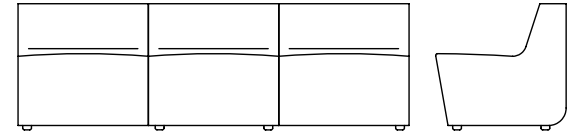

DARRAN™

[View statement of line](#)

## Product features.

- Horizontal back provides easy ganging capabilities.
- Utilizes elastic webbing suspension that conforms to individual's lumbar curvatures for adaptive support.
- All units are standard with 1" adjustable glides that allow for leveling

## Options.

### GANGING DEVICE

- GDEV-L: Left Facing Ganging Device - \$20
- GDEV-R: Right Facing Ganging Device - \$20
- GDEV-C: Center Ganging Device - \$40

### POWER

- PDN1U-1: Node in Right Facing Seat Front; 1 Power/1 USB Charger - \$325
- PDN1U-2: Node in Left and Center Seat, Right Facing Seat Fronts; 1 power/1 USB per pod - \$650
- PDN1R-R: Node in Right Facing Rear Mount Table Top; 1 Power/1 USB Charger - \$375
- PDN2R-L- 2 Node in Left Facing Rear Mount Table Top; 1 Power/1 USB Charger - \$375
- Standard in White (Available in Silver and Black)

### 1/2" COMPACT MATTE LAMINATE REAR TABLE

- Matte Laminate RTD88: Rear Work Table - \$1,005, Specify LAW Alaska or LNB Nero Finish
- Rear table available on units that gang providing stability
- Rear table is mounted at 28.5"

### 1/2" COMPACT MATTE LAMINATE TABLET

- FFD: 1/2" Compact Matte Laminate Tablet - \$570, Specify LAW Alaska or LNB Nero Finish
- Tablet mounts left or right of center cushion

### PREMIUM FINISH OPTION (STANDARD WHITE)

- Specify rear table bracket metal finish color - \$100 per unit
- Specify tablet metal finish color - \$100 per unit
- MFS: Silver, MFB: Black

bota.

Triple Seat With Privacy Screen  
Low Back - 10.5" Privacy Screen

1 model	COM	COL	1	2	3	4	5	6	7	8	9	10	11/L1	12	13/L2
BOT0160TLC13	4865	5220	5254	5446	5638	5830	6022	6214	6406	6598	6790	6982	7174	7366	7750
W x D x H			Upholstery Requirements												
88.5 x 29.25 x 39			Fabric yds: 10.5 Leather Sq. Ft.: 189												
Arm Height: -			Carton Weight: 165												
Seat Height: 17.5															
Inside Seat Depth: 17															
Inside Seat Width: 29.5															

2 Select a finish  
[View finish details](#)

3 Combination Fabrics  
[View finish details](#)

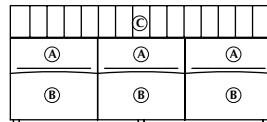
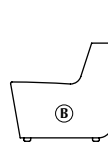

ⓑ Seat Back Top Screen ⓒ

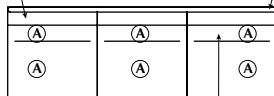

Inside Back

Node Power Placement Option

Table Power



Seat Power

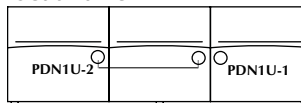

DARRAN is pleased to offer customers the design freedom of combination fabrics. When using fabric, vinyl or leather combinations, pricing/yardage requirements will be as follows:

- A Inside Back & Seat 3 yds
- B Lounge Exterior 6 yds
- C Privacy Screen 2.5 yds

- When combining two materials of the same grade, pricing will be specified grade + 5%
- If combining two materials of different grades or leather/fabric combination, use the highest grade/price + 5%
- If using COM or COL, pricing will be COM or COL + 5%.
- If both COM + COL are used in combination, use COL + 5%.

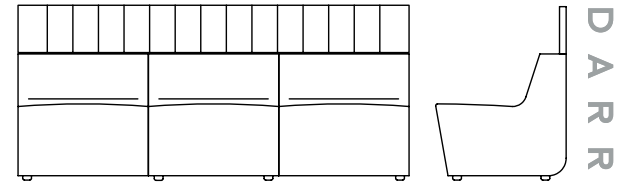

DARRAN

[View statement of line](#)

Product features.

- Horizontal back provides easy ganging capabilities.
- Utilizes elastic webbing suspension that conforms to individual's lumbar curvatures for adaptive support.
- Upholstered Privacy Screen
- Upholstered screens can be specified in contrasting fabrics, vinyl, or leathers.
- All units are standard with 1" adjustable glides that allow for leveling

Options.

GANGING DEVICE

- GDEV-L: Left Facing Ganging Device - \$20
- GDEV-R: Right Facing Ganging Device - \$20
- GDEV-C: Center Ganging Device - \$40

POWER

- PDN1U-1: Node in Right Facing Seat Front; 1 Power/1 USB Charger - \$325
- PDN1U-2: Node in Left and Center Seat, Right Facing Seat Fronts; 1 power/1 USB per pod - \$650
- PDN1R-R: Node in Right Facing Rear Mount Table Top; 1 Power/1 USB Charger - \$375
- PDN2R-L- 2 Node in Left Facing Rear Mount Table Top; 1 Power/1 USB Charger - \$375
- Standard in White (Available in Silver and Black)

1/2" COMPACT MATTE LAMINATE REAR TABLE

- Matte Laminate RTD88: Rear Work Table - \$1,005, Specify LAW Alaska or LNB Nero Finish
- Rear table available on units that gang providing stability
- Rear table is mounted at 28.5"

1/2" COMPACT MATTE LAMINATE TABLET

- FFD: 1/2" Compact Matte Laminate Tablet - \$570, Specify LAW Alaska or LNB Nero Finish
- Tablet mounts left or right of center cushion

PREMIUM FINISH OPTION (STANDARD WHITE)

- Specify rear table bracket metal finish color - \$100 per unit
- Specify tablet metal finish color - \$100 per unit
- MFS: Silver, MFB: Black

bota.

Triple Seat With Privacy Screen  
Low Back - 24.75" Privacy Screen

1 model	COM	COL	1	2	3	4	5	6	7	8	9	10	11/L1	12	13/L2
BOT0160TLC23	5637	6036	6118	6355	6592	6829	7066	7303	7540	7777	8014	8251	8488	8725	9199
W x D x H			Upholstery Requirements												
88.5 x 29.25 x 53.25			Fabric yds: 13 Leather Sq. Ft.: 234												
Arm Height: -			Carton Weight: 195												
Seat Height: 17.5															
Inside Seat Depth: 17															
Inside Seat Width: 29.5															

2 Select a finish  
[View finish details](#)

3 Combination Fabrics  
[View finish details](#)

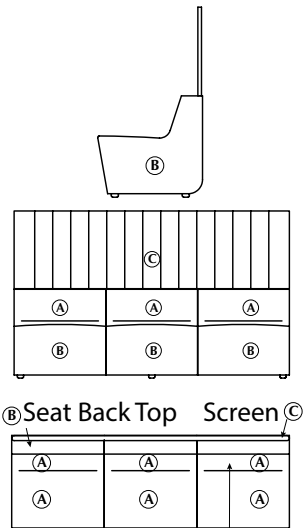

Node Power Placement Option

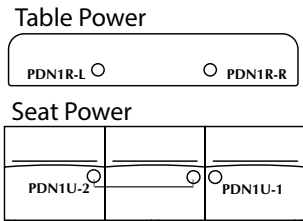

DARRAN is pleased to offer customers the design freedom of combination fabrics. When using fabric, vinyl or leather combinations, pricing/yardage requirements will be as follows:

- A Inside Back & Seat 3 yds
- B Lounge Exterior 6 yds
- C Privacy Screen 5 yds

- When combining two materials of the same grade, pricing will be specified grade + 5%
- If combining two materials of different grades or leather/fabric combination, use the highest grade/price + 5%
- If using COM or COL, pricing will be COM or COL + 5%.
- If both COM + COL are used in combination, use COL + 5%.

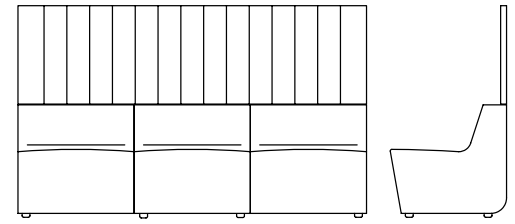

[View statement of line](#)

## Product features.

- Horizontal back provides easy ganging capabilities.
- Utilizes elastic webbing suspension that conforms to individual's lumbar curvatures for adaptive support.
- Upholstered Privacy Screen
- Upholstered screens can be specified in contrasting fabrics, vinyl, or leathers.
- All units are standard with 1" adjustable glides that allow for leveling

## Options.

### GANGING DEVICE

- GDEV-L: Left Facing Ganging Device - \$20
- GDEV-R: Right Facing Ganging Device - \$20
- GDEV-C: Center Ganging Device - \$40

### POWER

- PDN1U-1: Node in Right Facing Seat Front; 1 Power/1 USB Charger - \$325
- PDN1U-2: Node in Left and Center Seat, Right Facing Seat Fronts; 1 power/1 USB per pod - \$650
- PDN1R-R: Node in Right Facing Rear Mount Table Top; 1 Power/1 USB Charger - \$375
- PDN2R-L- 2 Node in Left Facing Rear Mount Table Top; 1 Power/1 USB Charger - \$375
- Standard in White (Available in Silver and Black)
- 1/2" COMPACT MATTE LAMINATE REAR TABLE
- Matte Laminate RTD88: Rear Work Table - \$1,005, Specify LAW Alaska or LNB Nero Finish
- Rear table available on units that gang providing stability
- Rear table is mounted at 28.5"

### 1/2" COMPACT MATTE LAMINATE TABLET

- FFTD: 1/2" Compact Matte Laminate Tablet - \$570, Specify LAW Alaska or LNB Nero Finish
- Tablet mounts left or right of center cushion

### PREMIUM FINISH OPTION (STANDARD WHITE)

- Specify rear table bracket metal finish color - \$100 per unit
- Specify tablet metal finish color - \$100 per unit
- MFS: Silver, MFB: Black

bota.

Triple Seat  
High Back

1 model	COM	COL	1	2	3	4	5	6	7	8	9	10	11/L1	12	13/L2
BOT0160THC03	4124	4414	4457	4621	4785	4949	5113	5277	5441	5605	5769	5933	6097	6261	6589
W x D x H			Upholstery Requirements												
88.5 x 29.25 x 35.5			Fabric yds: 9 Leather Sq. Ft.: 162												
Arm Height: -			Carton Weight: 143												
Seat Height: 17.5															
Inside Seat Depth: 17															
Inside Seat Width: 29.5															

2 Select a finish  
[View finish details](#)

3 Combination Fabrics  
[View finish details](#)

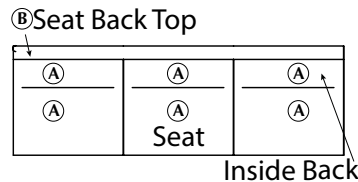
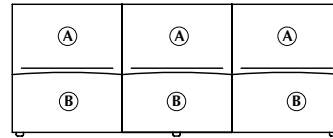
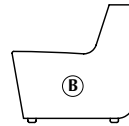

Node Power Placement Option

Table Power

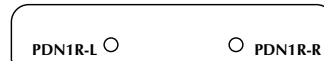

Seat Power

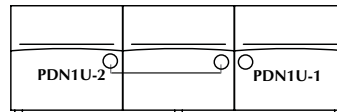

**DARRAN is pleased to offer customers the design freedom of combination fabrics. When using fabric, vinyl or leather combinations, pricing/yardage requirements will be as follows:**

**A Inside Back & Seat 3.5 yds**  
**B Lounge Exterior 6.5 yds**

- When combining two materials of the same grade, pricing will be specified grade + 5%
- If combining two materials of different grades or leather/fabric combination, use the highest grade/price + 5%
- If using COM or COL, pricing will be COM or COL + 5%.
- If both COM + COL are used in combination, use COL + 5%.

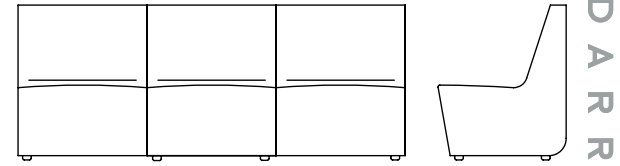

DARRAN™

[View statement of line](#)

Product features.

- Horizontal back provides easy ganging capabilities.
- Utilizes elastic webbing suspension that conforms to individual's lumbar curvatures for adaptive support.
- All units are standard with 1" adjustable glides that allow for leveling

Options.

**GANGING DEVICE**

- GDEV-L: Left Facing Ganging Device - \$20
- GDEV-R: Right Facing Ganging Device - \$20
- GDEV-C: Center Ganging Device - \$40

**POWER**

- PDN1U-1: Node in Right Facing Seat Front; 1 Power/1 USB Charger - \$325
- PDN1U-2: Node in Left and Center Seat, Right Facing Seat Fronts; 1 power/1 USB per pod - \$650
- PDN1R-R: Node in Right Facing Rear Mount Table Top; 1 Power/1 USB Charger - \$375
- PDN2R-L- 2 Node in Left Facing Rear Mount Table Top; 1 Power/1 USB Charger - \$375
- Standard in White (Available in Silver and Black)

**1/2" COMPACT MATTE LAMINATE REAR TABLE**

- Matte Laminate RTD88: Rear Work Table - \$1,005, Specify LAW Alaska or LNB Nero Finish
- Rear table available on units that gang providing stability
- Rear table is mounted at 35.5"

**1/2" COMPACT MATTE LAMINATE TABLET**

- FFD: 1/2" Compact Matte Laminate Tablet - \$570, Specify LAW Alaska or LNB Nero Finish
- Tablet mounts left or right of center cushion

**PREMIUM FINISH OPTION (STANDARD WHITE)**

- Specify rear table bracket metal finish color - \$100 per unit
- Specify tablet metal finish color - \$100 per unit
- MFS: Silver, MFB: Black

bota.

Triple Seat With Privacy Screen  
High Back - 10.5" Privacy Screen

1 model	COM	COL	1	2	3	4	5	6	7	8	9	10	11/L1	12	13/L2
BOT0160THC13	5178	5533	5604	5814	6024	6234	6444	6654	6864	7074	7284	7494	7704	7914	8334
W x D x H			Upholstery Requirements												
88.5 x 29.25 x 46			Fabric yds: 11.5 Leather Sq. Ft.: 207												
Arm Height: -			Carton Weight: 173												
Seat Height: 17.5															
Inside Seat Depth: 17															
Inside Seat Width: 29.5															

2 Select a finish  
[View finish details](#)

3 Combination Fabrics  
[View finish details](#)

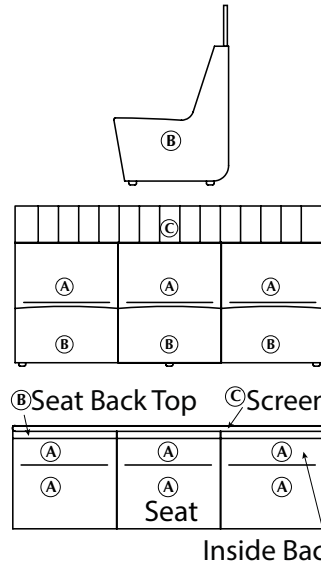

Node Power Placement Option

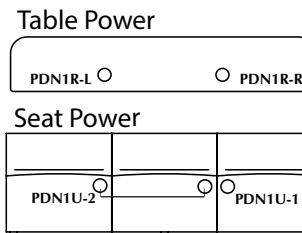

DARRAN is pleased to offer customers the design freedom of combination fabrics. When using fabric, vinyl or leather combinations, pricing/yardage requirements will be as follows:

- A Inside Back & Seat 3.5 yds
- B Lounge Exterior 6.5 yds
- C Privacy Screen 2.5 yds

- When combining two materials of the same grade, pricing will be specified grade + 5%
- If combining two materials of different grades or leather/fabric combination, use the highest grade/price + 5%
- If using COM or COL, pricing will be COM or COL + 5%.
- If both COM + COL are used in combination, use COL + 5%.

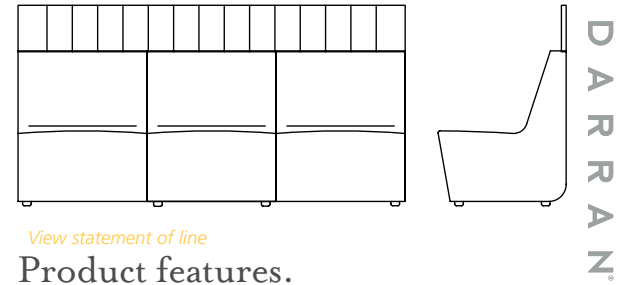

[View statement of line](#)

Product features.

- Horizontal back provides easy ganging capabilities.
- Utilizes elastic webbing suspension that conforms to individual's lumbar curvatures for adaptive support.
- Upholstered Privacy Screen
- Upholstered screens can be specified in contrasting fabrics, vinyl, or leathers.
- All units are standard with 1" adjustable glides that allow for leveling

Options.

GANGING DEVICE

- GDEV-L: Left Facing Ganging Device - \$20
- GDEV-R: Right Facing Ganging Device - \$20
- GDEV-C: Center Ganging Device - \$40

POWER

- PDN1U-1: Node in Right Facing Seat Front; 1 Power/1 USB Charger - \$325
- PDN1U-2: Node in Left and Center Seat, Right Facing Seat Fronts; 1 power/1 USB per pod - \$650
- PDN1R-R: Node in Right Facing Rear Mount Table Top; 1 Power/1 USB Charger - \$375
- PDN2R-L- 2 Node in Left Facing Rear Mount Table Top; 1 Power/1 USB Charger - \$375
- Standard in White (Available in Silver and Black)

1/2" COMPACT MATTE LAMINATE REAR TABLE

- Matte Laminate RTD88: Rear Work Table - \$1,005, Specify LAW Alaska or LNB Nero Finish
- Rear table available on units that gang providing stability
- Rear table is mounted at 35.5"

1/2" COMPACT MATTE LAMINATE TABLET

- FFD: 1/2" Compact Matte Laminate Tablet - \$570, Specify LAW Alaska or LNB Nero Finish
- Tablet mounts left or right of center cushion

PREMIUM FINISH OPTION (STANDARD WHITE)

- Specify rear table bracket metal finish color - \$100 per unit
- Specify tablet metal finish color - \$100 per unit
- MFS: Silver, MFB: Black

bota.

Triple Seat With Privacy Screen  
High Back - 17.5" Privacy Screen

1 model	COM	COL	1	2	3	4	5	6	7	8	9	10	11/L1	12	13/L2
BOT0160THC23	5614	6013	6132	6387	6642	6897	7152	7407	7662	7917	8172	8427	8682	8937	9447
W x D x H			Upholstery Requirements												
88.5 x 29.25 x 53			Fabric yds: 14 Leather Sq. Ft.: 252												
Arm Height: -			Carton Weight: 203												
Seat Height: 17.5															
Inside Seat Depth: 17															
Inside Seat Width: 29.5															

2 Select a finish  
[View finish details](#)

3 Combination Fabrics  
[View finish details](#)

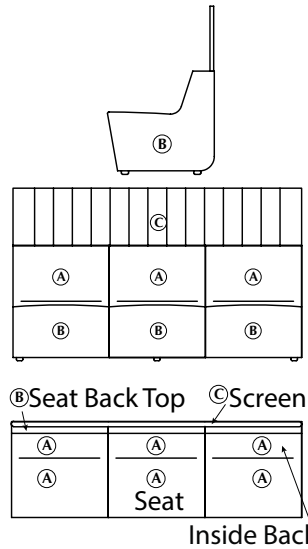

Node Power Placement Option

Table Power



Seat Power

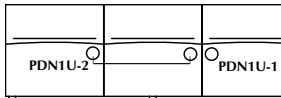

DARRAN is pleased to offer customers the design freedom of combination fabrics. When using fabric, vinyl or leather combinations, pricing/yardage requirements will be as follows:

- A Inside Back & Seat 3.5 yds
- B Lounge Exterior 6.5 yds
- C Privacy Screen 5 yds

- When combining two materials of the same grade, pricing will be specified grade + 5%
- If combining two materials of different grades or leather/fabric combination, use the highest grade/price + 5%
- If using COM or COL, pricing will be COM or COL + 5%.
- If both COM + COL are used in combination, use COL + 5%.

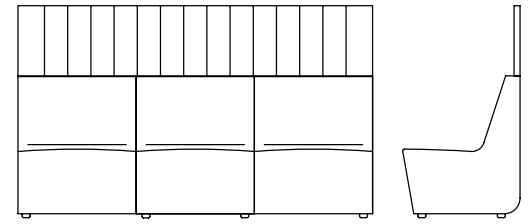

[View statement of line](#)

Product features.

- Horizontal back provides easy ganging capabilities.
- Utilizes elastic webbing suspension that conforms to individual's lumbar curvatures for adaptive support.
- Upholstered Privacy Screen
- Upholstered screens can be specified in contrasting fabrics, vinyl, or leathers.
- All units are standard with 1" adjustable glides that allow for leveling

Options.

GANGING DEVICE

- GDEV-L: Left Facing Ganging Device - \$20
- GDEV-R: Right Facing Ganging Device - \$20
- GDEV-C: Center Ganging Device - \$40

POWER

- PDN1U-1: Node in Right Facing Seat Front; 1 Power/1 USB Charger - \$325
  - PDN1U-2: Node in Left and Center Seat, Right Facing Seat Fronts; 1 power/1 USB per pod - \$650
  - PDN1R-R: Node in Right Facing Rear Mount Table Top; 1 Power/1 USB Charger - \$375
  - PDN2R-L- 2 Node in Left Facing Rear Mount Table Top; 1 Power/1 USB Charger - \$375
  - Standard in White (Available in Silver and Black)
- 1/2" COMPACT MATTE LAMINATE REAR TABLE**
- Matte Laminate RTD88: Rear Work Table - \$1,005, Specify LAW Alaska or LNB Nero Finish
  - Rear table available on units that gang providing stability
  - Rear table is mounted at 35.5"

1/2" COMPACT MATTE LAMINATE TABLET

- FFTD: 1/2" Compact Matte Laminate Tablet - \$570, Specify LAW Alaska or LNB Nero Finish
- Tablet mounts left or right of center cushion

PREMIUM FINISH OPTION (STANDARD WHITE)

- Specify rear table bracket metal finish color - \$100 per unit
- Specify tablet metal finish color - \$100 per unit
- MFS: Silver, MFB: Black

bota.

Shell - Single Seat  
 Low Back - Side Screens & Privacy Screen

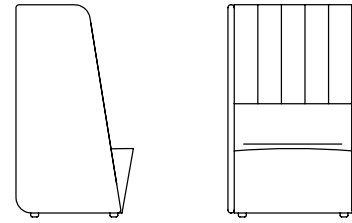

[View statement of line](#)

### Product features.

- Screens are constructed from tubular metal that is welded to maximize the strength, precise measurements and overall longevity.
- Horizontal back provides easy ganging capabilities.
- Utilizes elastic webbing suspension that conforms to individual's lumbar curvatures for adaptive support.
- Upholstered screens can be specified in contrasting fabrics, vinyl, or leathers.
- All units are standard with 1" adjustable glides that allow for leveling

1 model	COM	COL	1	2	3	4	5	6	7	8	9	10	11/L1	12	13/L2
BOT0160SLN01	3756	3898	3978	4087	4196	4305	4414	4523	4632	4741	4850	4959	5068	5177	5395
W x D x H 32.75 x 29.25 x 53 Arm Height: - Seat Height: 17.5 Inside Seat Depth: 17 Inside Seat Width: 29.5			Upholstery Requirements Fabric yds: 6 Leather Sq. Ft.: 108 Carton Weight: 110												

2 Select a finish  
[View finish details](#)

3 Combination Fabrics  
[View finish details](#)

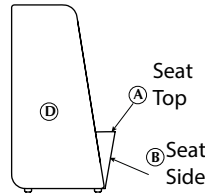
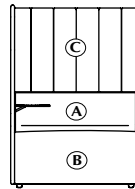

Top View

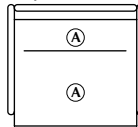

#### Node Power Placement Option

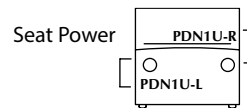

Table Power NA

DARRAN is pleased to offer customers the design freedom of combination fabrics. When using fabric, vinyl or leather combinations, pricing/yardage requirements will be as follows:

- A Inside Back & Seat** 1.5 yds
- B Lounge Exterior** 3 yds
- C Privacy Screen Interior** 1 yds
- D Side Screens, Lounge Exterior, Privacy Screens** 5 yds

- When combining two materials of the same grade, pricing will be specified grade + 5%
- If combining two materials of different grades or leather/fabric combination, use the highest grade/price + 5%
- If using COM or COL, pricing will be COM or COL + 5%.
- If both COM + COL are used in combination, use COL + 5%.

#### NOTES

- Please consult customer service when specifying a table other than Bota to ensure adequacy of seat access

### Options.

#### DELETE SIDE SCREEN

Delete Left Screen

- DLSG: Delete Left Side Screen for Ganging - Deduct \$500 (Ganging Hardware Installed)
- DLSN: Delete Left Side Screen for Non-Ganging - Deduct \$475 (Ganging Hardware Not Installed)

Delete Right Screen

- DRSG: Delete Right Side Screen for Ganging - Deduct \$500 (Ganging Hardware Installed)
- DRSN: Delete Right Side Screen for Non-Ganging - Deduct \$475 (Ganging Hardware Not Installed)

#### POWER

- PDN1U-L: Node in Left Facing Seat Front; 1 Power/1 USB Charger - \$325
- PDN1U-R: Node in Right Facing Seat Front; 1 Power/1 USB Charger - \$325
- PDN1U-B: Node in Both Left and Right Facing Seat Front; 1 Power/1 USB Charger per pod - \$650
- Standard in White (Available in Silver and Black)



bota.

Shell - Single Seat  
High Back - Side Screens & Privacy Screen

1 model	COM	COL	1	2	3	4	5	6	7	8	9	10	11/L1	12	13/L2
BOT0160SHN01	3771	4018	4030	4158	4286	4414	4542	4670	4798	4926	5054	5182	5310	5438	5694
W x D x H			Upholstery Requirements												
32.75 x 29.25 x 53			Fabric yds: 7 Leather Sq. Ft.: 126												
Arm Height: -			Carton Weight: 115												
Seat Height: 17.5															
Inside Seat Depth: 17															
Inside Seat Width: 29.5															

2 Select a finish  
[View finish details](#)

3 Combination Fabrics  
[View finish details](#)

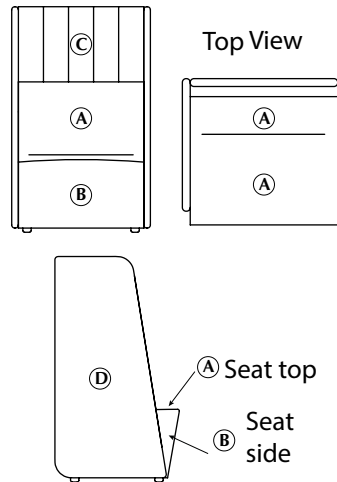

**DARRAN is pleased to offer customers the design freedom of combination fabrics. When using fabric, vinyl or leather combinations, pricing/yardage requirements will be as follows:**

- A Inside Back & Seat** 1.5 yds
- B Lounge Exterior** 3 yds
- C Privacy Screen** 0.75 yds
- D Side Screens, Lounge Exterior, Privacy Screens** 5 yds

- When combining two materials of the same grade, pricing will be specified grade + 5%
- If combining two materials of different grades or leather/fabric combination, use the highest grade/price + 5%
- If using COM or COL, pricing will be COM or COL + 5%.
- If both COM + COL are used in combination, use COL + 5%.

**Node Power Placement Option**

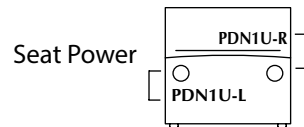
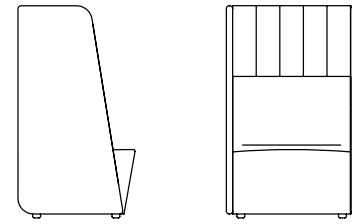

Table Power NA



[View statement of line](#)

**Product features.**

- Screens are constructed from tubular metal that is welded to maximize the strength, precise measurements and overall longevity.
- Horizontal back provides easy ganging capabilities.
- Utilizes elastic webbing suspension that conforms to individual's lumbar curvatures for adaptive support.
- Upholstered screens can be specified in contrasting fabrics, vinyl, or leathers.
- All units are standard with 1" adjustable glides that allow for leveling

**NOTES**

- Please consult customer service when specifying a table other than Bota to ensure adequacy of seat access

**Options.**

**DELETE SIDE SCREEN**

- Delete Left Screen
  - DLSG: Delete Left Side Screen for Ganging - Deduct \$500 (Ganging Hardware Installed)
  - DLSN: Delete Left Side Screen for Non-Ganging - Deduct \$475 (Ganging Hardware Not Installed)
- Delete Right Screen
  - DRSG: Delete Right Side Screen for Ganging - Deduct \$500 (Ganging Hardware Installed)
  - DRSN: Delete Right Side Screen for Non-Ganging - Deduct \$475 (Ganging Hardware Not Installed)

**POWER**

- PDN1U-L: Node in Left Facing Seat Front; 1 Power/1 USB Charger - \$325
- PDN1U-R: Node in Right Facing Seat Front; 1 Power/1 USB Charger - \$325
- PDN1U-B: Node in Both Left and Right Facing Seat Front; 1 Power/1 USB Charger per pod - \$650
- Standard in White (Available in Silver and Black)

bota.

Shell - Single Seat  
 Low Back - Side Screens, Privacy Screen & Roof

1 model	COM	COL	1	2	3	4	5	6	7	8	9	10	11/L1	12	13/L2
BOT0160SLR01	4612	4910	4871	4999	5127	5255	5383	5511	5639	5767	5895	6023	6151	6279	6535
W x D x H			Upholstery Requirements												
32.75 x 29.25 x 63			Fabric yds: 7 Leather Sq. Ft.: 126												
Arm Height: -			Carton Weight: 131												
Seat Height: 17.5															
Inside Seat Depth: 17															
Inside Seat Width: 29.5															

2 Select a finish  
[View finish details](#)

3 Combination Fabrics  
[View finish details](#)

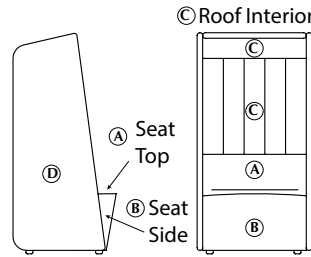

© Roof Interior

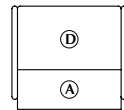

Node Power Placement Option

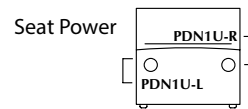
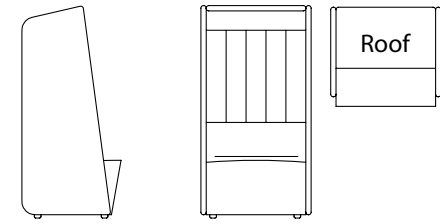

Table Power NA



[View statement of line](#)

## Product features.

- Screens are constructed from tubular metal that is welded to maximize the strength, precise measurements and overall longevity.
- Horizontal back provides easy ganging capabilities.
- Utilizes elastic webbing suspension that conforms to individual's lumbar curvatures for adaptive support.
- Upholstered screens & roof can be specified in contrasting fabrics, vinyl, or leathers.
- All units are standard with 1" adjustable glides that allow for leveling

### NOTES

- Please consult customer service when specifying a table other than Bota to ensure adequacy of seat access

## Options.

### POWER

- PDN1U-L: Node in Left Facing Seat Front; 1 Power/1 USB Charger - \$325
- PDN1U-R: Node in Right Facing Seat Front; 1 Power/1 USB Charger - \$325
- PDN1U-B: Node in Both Left and Right Facing Seat Front; 1 Power/1 USB Charger per pod - \$650
- Standard in White (Available in Silver and Black)

**DARRAN is pleased to offer customers the design freedom of combination fabrics. When using fabric, vinyl or leather combinations, pricing/yardage requirements will be as follows:**

- A Inside Back & Seat 1.5 yds**
- B Lounge Exterior 3 yds**
- C Privacy Screen & Roof Interior 2 yds**
- D Side Screens, Lounge Exterior, Roof Exterior 6 yds**

- When combining two materials of the same grade, pricing will be specified grade + 5%
- If combining two materials of different grades or leather/fabric combination, use the highest grade/price + 5%
- If using COM or COL, pricing will be COM or COL + 5%.
- If both COM + COL are used in combination, use COL + 5%.

Work Shell  
Single - Seat

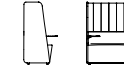

1 model	COM	COL	1	2	3	4	5	6	7	8	9	10	11/L1	12	13/L2
BOT0160SLW01	5146	5398	5405	5533	5661	5789	5917	6045	6173	6301	6429	6557	6685	6813	7069
W x D x H 38.75 x 29.25 x 53			Upholstery Requirements												
Arm Height: -			Fabric yds: 7 Leather Sq. Ft.: 126												
Seat Height: 17.5			Carton Weight: 130												
Inside Seat Depth: 17															
Inside Seat Width: 35															

2 Select a finish  
[View finish details](#)

- WLA
- WEC
- WAM
- WCM
- WWM
- WGW
- WBW
- WSW
- WNW
- WWP

Metal finish  
MFB Black. Additional metal finishes are available, see options.

3 Combination Fabrics  
[View finish details](#)

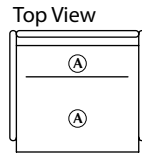
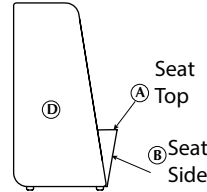
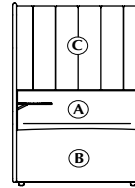

Node Power Placement Option

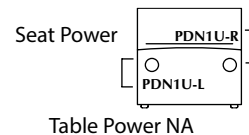

**DARRAN is pleased to offer customers the design freedom of combination fabrics. When using fabric, vinyl or leather combinations, pricing/yardage requirements will be as follows:**

- A Inside Back & Seat** 3.5 yds
- B Lounge Exterior** 5 yds
- C Privacy Screen Interior** 3 yds
- D Side Screens, Lounge Exterior, Privacy Screens** 5 yds

- When combining two materials of the same grade, pricing will be specified grade + 5%
- If combining two materials of different grades or leather/fabric combination, use the highest grade/price + 5%
- If using COM or COL, pricing will be COM or COL + 5%.
- If both COM + COL are used in combination, use COL + 5%.

[View statement of line](#)

**Product features.**

- Screens are constructed from tubular metal that is welded to maximize the strength, precise measurements and overall longevity.
- Horizontal back provides easy ganging capabilities.
- Utilizes elastic webbing suspension that conforms to individual's lumbar curvatures for adaptive support.
- Upholstered screens can be specified in contrasting fabrics, vinyl, or leathers.
- All units are standard with 1" adjustable glides that allow for leveling
- Adjustable work side table on left facing side
- Specify side table finish color
- Height of work side table is 26"
- Size of work side table 14.75W x 16D

**NOTES**

- Please consult customer service when specifying a table other than Bota to ensure adequacy of seat access

**Options.**

**DELETE SIDE SCREEN**

- Delete Right Screen
- DRSG: Delete Right Side Screen for Ganging - Deduct \$500 (Ganging Hardware Installed)
- DRSN: Delete Right Side Screen for Non-Ganging - Deduct \$475 (Ganging Hardware Not Installed)

**POWER**

- PDN1U-L: Node in Left Facing Seat Front; 1 Power/1 USB Charger - \$325
- PDN1U-R: Node in Right Facing Seat Front; 1 Power/1 USB Charger - \$325
- PDN1U-B: Node in Both Left and Right Facing Seat Front; 1 Power/1 USB Charger per pod - \$650
- Standard in White (Available in Silver and Black)

bota.

Shell - Single Seat  
Low Back - Swivel Base

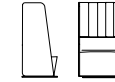

1 model	COM	COL	1	2	3	4	5	6	7	8	9	10	11/L1	12	13/L2
BOT0160SL501	5075	5327	5297	5406	5515	5624	5733	5842	5951	6060	6169	6278	6387	6496	6714
W x D x H			Upholstery Requirements												
33.75 x 29.25 x 53			Fabric yds: 6 Leather Sq. Ft.: 108												
Arm Height: -			Carton Weight: 160												
Seat Height: 17.5															
Inside Seat Depth: 17															
Inside Seat Width: 29.5															

2 Select a finish  
[View finish details](#)  
N/A

3 Combination Fabrics  
[View finish details](#)

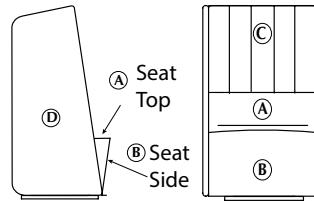

Top View

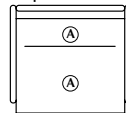

Node Power Placement Option

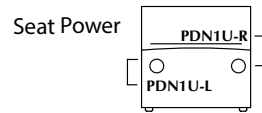

Table Power NA

**DARRAN is pleased to offer customers the design freedom of combination fabrics. When using fabric, vinyl or leather combinations, pricing/yardage requirements will be as follows:**

- A Inside Back & Seat** 1.5 yds
- B Lounge Exterior** 3 yds
- C Privacy Screen Interior** 1 yds
- D Side Screens, Lounge Exterior, Privacy Screens** 5 yds

- When combining two materials of the same grade, pricing will be specified grade + 5%
- If combining two materials of different grades or leather/fabric combination, use the highest grade/price + 5%
- If using COM or COL, pricing will be COM or COL + 5%.
- If both COM + COL are used in combination, use COL + 5%.

[View statement of line](#)

**Product features.**

- Screens are constructed from tubular metal that is welded to maximize the strength, precise measurements and overall longevity.
- Horizontal back provides easy ganging capabilities.
- Utilizes elastic webbing suspension that conforms to individual's lumbar curvatures for adaptive support.
- Upholstered screens can be specified in contrasting fabrics, vinyl, or leathers.
- Swivel base

**NOTES**

- Please consult customer service when specifying a table other than Bota to ensure adequacy of seat access

**POWER**

- PDN1U-L: Node in Left Facing Seat Front; 1 Power/1 USB Charger - \$325
- PDN1U-R: Node in Right Facing Seat Front; 1 Power/1 USB Charger - \$325
- PDN1U-B: Node in Both Left and Right Facing Seat Front; 1 Power/1 USB Charger per pod - \$650
- Standard in White (Available in Silver and Black)

bota.

Shell - Single Seat  
High Back - Swivel Base



1 model	COM	COL	1	2	3	4	5	6	7	8	9	10	11/L1	12	13/L2
BOT0160SHS01	5090	5337	5349	5477	5605	5733	5861	5989	6117	6245	6373	6501	6629	6757	7013
W x D x H 33.75 x 29.25 x 53 Arm Height: - Seat Height: 17.5 Inside Seat Depth: 17 Inside Seat Width: 29.5			Upholstery Requirements Fabric yds: 7 Leather Sq. Ft.: 126 Carton Weight: 165												

2 Select a finish  
[View finish details](#)  
N/A

3 Combination Fabrics  
[View finish details](#)

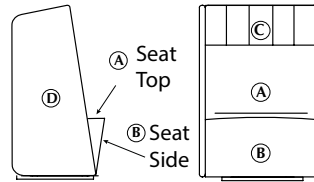

Top View

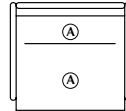

Node Power Placement Option

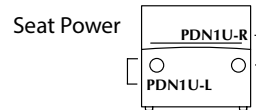

Seat Power

Table Power NA

**DARRAN is pleased to offer customers the design freedom of combination fabrics. When using fabric, vinyl or leather combinations, pricing/yardage requirements will be as follows:**

- A Inside Back & Seat** 1.5 yds
- B Lounge Exterior** 3 yds
- C Privacy Screen Interior** 1 yds
- D Side Screens, Lounge Exterior, Privacy Screens** 5 yds

- When combining two materials of the same grade, pricing will be specified grade + 5%
- If combining two materials of different grades or leather/fabric combination, use the highest grade/price + 5%
- If using COM or COL, pricing will be COM or COL + 5%.
- If both COM + COL are used in combination, use COL + 5%.

[View statement of line](#)

**Product features.**

- Screens are constructed from tubular metal that is welded to maximize the strength, precise measurements and overall longevity.
- Horizontal back provides easy ganging capabilities.
- Utilizes elastic webbing suspension that conforms to individual's lumbar curvatures for adaptive support.
- Upholstered screens can be specified in contrasting fabrics, vinyl, or leathers.
- Swivel base

**NOTES**

- Please consult customer service when specifying a table other than Bota to ensure adequacy of seat access

**POWER**

- PDN1U-L: Node in Left Facing Seat Front; 1 Power/1 USB Charger - \$325
- PDN1U-R: Node in Right Facing Seat Front; 1 Power/1 USB Charger - \$325
- PDN1U-B: Node in Both Left and Right Facing Seat Front; 1 Power/1 USB Charger per pod - \$650
- Standard in White (Available in Silver and Black)

bota.

Shell - Double Seat  
 Low Back - Side Screens & Privacy Screen

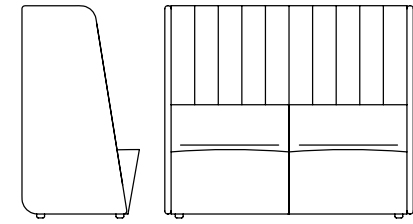

View statement of line

### Product features.

- Screens are constructed from tubular metal that is welded to maximize the strength, precise measurements and overall longevity.
- Horizontal back provides easy ganging capabilities.
- Utilizes elastic webbing suspension that conforms to individual's lumbar curvatures for adaptive support.
- Upholstered screens can be specified in contrasting fabrics, vinyl, or leathers.
- All units are standard with 1" adjustable glides that allow for leveling

1 model	COM	COL	1	2	3	4	5	6	7	8	9	10	11/L1	12	13/L2
BOT0160DLN02	5057	5426	5501	5720	5939	6158	6377	6596	6815	7034	7253	7472	7691	7910	8348
W x D x H			Upholstery Requirements												
62 x 29.25 x 53			Fabric yds: 12 Leather Sq. Ft.: 216												
Arm Height: -			Carton Weight: 170												
Seat Height: 17.5															
Inside Seat Depth: 17															
Inside Seat Width: 29.5															

### 2 Select a finish View finish details

### 3 Combination Fabrics View finish details

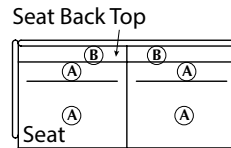
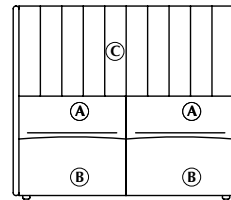
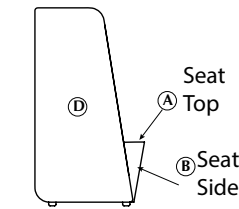

#### Node Power Placement Option

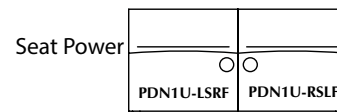

Table Power NA

DARRAN is pleased to offer customers the design freedom of combination fabrics. When using fabric, vinyl or leather combinations, pricing/yardage requirements will be as follows:

- A Inside Back & Seat 2 yds
- B Lounge Exterior 4 yds
- C Privacy Screen 2 yds
- D Side Screens, Lounge Exterior, Privacy Screens 6 yds

- When combining two materials of the same grade, pricing will be specified grade + 5%
- If combining two materials of different grades or leather/fabric combination, use the highest grade/price + 5%
- If using COM or COL, pricing will be COM or COL + 5%.
- If both COM + COL are used in combination, use COL + 5%.

#### NOTES

- Please consult customer service when specifying a table other than Bota to ensure adequacy of seat access
- When delete side screen option is specified, ganging brackets are installed on the lounge side. If the unit will be open specify the delete screen non-ganging option. Non-ganging option will not have side mounted ganging brackets

### Options.

#### DELETE SIDE SCREEN

- Delete Left Screen
  - DLSG: Delete Left Side Screen for Ganging - Deduct \$500 (Ganging Hardware Installed)
  - DLSN: Delete Left Side Screen for Non-Ganging - Deduct \$475 (Ganging Hardware Not Installed)
- Delete Right Screen
  - DRSG: Delete Right Side Screen for Ganging - Deduct \$500 (Ganging Hardware Installed)
  - DRSN: Delete Right Side Screen for Non-Ganging - Deduct \$475 (Ganging Hardware Not Installed)

#### POWER

- PDN1U-LSRF: Node in Left Seat Right Facing Seat Front; 1 Power/1 USB Charger - \$325
- PDN1U-RSLF: Node in Right Seat Left Facing Seat Front; 1 Power/1 USB Charger - \$325
- PDN1U-BC: Node in Both Left and Right Facing Center Seat Front; 1 Power/1 USB Charger per pod - \$650
- Standard in White (Available in Silver and Black)

#### 1/2" COMPACT MATTE LAMINATE TABLET

- FFD: 1/2" Compact Matte Laminate Tablet - \$570, Specify LAW Alaska or LNB Nero Finish
- Tablet is center mount only

#### PREMIUM FINISH OPTION (STANDARD WHITE)

- Specify rear table bracket metal finish color - \$100 per unit
- Specify tablet metal finish color - \$100 per unit
- MFS: Silver, MFB: Black

bota.

Shell - Double Seat  
High Back - Side Screens & Privacy Screen

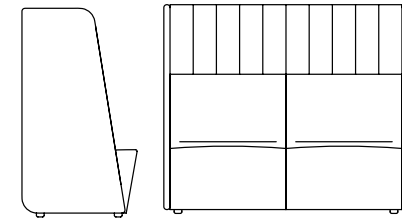

[View statement of line](#)

## Product features.

- Screens are constructed from tubular metal that is welded to maximize the strength, precise measurements and overall longevity.
- Horizontal back provides easy ganging capabilities.
- Utilizes elastic webbing suspension that conforms to individual's lumbar curvatures for adaptive support.
- Upholstered screens can be specified in contrasting fabrics, vinyl, or leathers.
- All units are standard with 1" adjustable glides that allow for leveling

1 model	COM	COL	1	2	3	4	5	6	7	8	9	10	11/L1	12	13/L2
BOT0160DHN02	5071	5426	5552	5789	6026	6263	6500	6737	6974	7211	7448	7685	7922	8159	8633
W x D x H			Upholstery Requirements												
62 x 29.25 x 53			Fabric yds: 13 Leather Sq. Ft.: 234												
Arm Height: -			Carton Weight: 175												
Seat Height: 17.5															
Inside Seat Depth: 17															
Inside Seat Width: 29.5															

## 2 Select a finish

[View finish details](#)

## 3 Combination Fabrics

[View finish details](#)

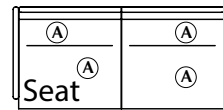
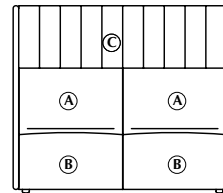
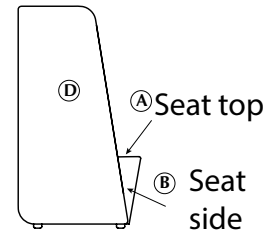

**DARRAN is pleased to offer customers the design freedom of combination fabrics. When using fabric, vinyl or leather combinations, pricing/yardage requirements will be as follows:**

- A Inside Back & Seat 2 yds**
- B Lounge Exterior 5 yds**
- C Privacy Screen 2 yds**
- D Side Screens, Lounge Exterior, Privacy Screens 6 yds**

- When combining two materials of the same grade, pricing will be specified grade + 5%
- If combining two materials of different grades or leather/fabric combination, use the highest grade/price + 5%
- If using COM or COL, pricing will be COM or COL + 5%.
- If both COM + COL are used in combination, use COL + 5%.

### Node Power Placement Option

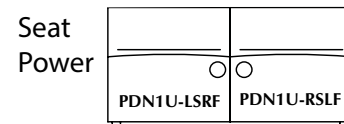

Table Power NA

### NOTES

- Please consult customer service when specifying a table other than Bota to ensure adequacy of seat access
- When delete side screen option is specified, ganging brackets are installed on the lounge side. If the unit will be open specify the delete screen non-ganging option. Non-ganging option will not have side mounted ganging brackets

## Options.

### DELETE SIDE SCREEN

Delete Left Screen

- DLSG: Delete Left Side Screen for Ganging - Deduct \$500 (Ganging Hardware Installed)
- DLSN: Delete Left Side Screen for Non-Ganging - Deduct \$475 (Ganging Hardware Not Installed)

Delete Right Screen

- DRSG: Delete Right Side Screen for Ganging - Deduct \$500 (Ganging Hardware Installed)
- DRSN: Delete Right Side Screen for Non-Ganging - Deduct \$475 (Ganging Hardware Not Installed)

### POWER

- PDN1U-LSRF: Node in Left Seat Right Facing Seat Front; 1 Power/1 USB Charger - \$325
- PDN1U-RSLF: Node in Right Seat Left Facing Seat Front; 1 Power/1 USB Charger - \$325
- PDN1U-BC: Node in Both Left and Right Facing Center Seat Front; 1 Power/1 USB Charger per pod - \$650
- Standard in White (Available in Silver and Black)

### 1/2" COMPACT MATTE LAMINATE TABLET

- FFD: 1/2" Compact Matte Laminate Tablet - \$570, Specify LAW Alaska or LNB Nero Finish
- Tablet is center mount only

### PREMIUM FINISH OPTION (STANDARD WHITE)

- Specify rear table bracket metal finish color - \$100 per unit
- Specify tablet metal finish color - \$100 per unit
- MFS: Silver, MFB: Black

bota.

Shell - Double Seat  
 Low Back - Side Screens, Privacy Screen & Roof

1 model	COM	COL	1	2	3	4	5	6	7	8	9	10	11/L1	12	13/L2
BOT0160DLR02	6246	6679	6838	7130	7422	7714	8006	8298	8590	8882	9174	9466	9758	10050	10634
W x D x H 62 x 29.25 x 63			Upholstery Requirements												
Arm Height: -			Fabric yds: 16 Leather Sq. Ft.: 288												
Seat Height: 17.5			Carton Weight: 185												
Inside Seat Depth: 17															
Inside Seat Width: 29.5															

2 Select a finish  
[View finish details](#)

3 Combination Fabrics  
[View finish details](#)

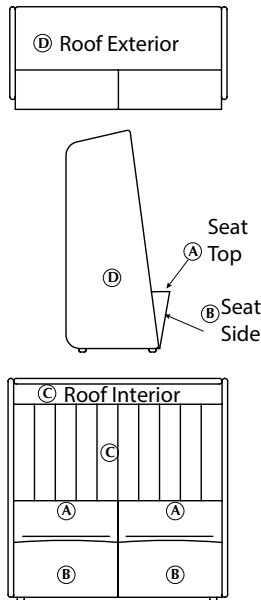

**DARRAN is pleased to offer customers the design freedom of combination fabrics. When using fabric, vinyl or leather combinations, pricing/yardage requirements will be as follows:**

- A Inside Back & Seat 2 yds**
- B Lounge Exterior 4 yds**
- C Privacy Screen & Roof Interior 4 yds**
- D Side Screens, Lounge Exterior, Roof Exterior 8 yds**

- When combining two materials of the same grade, pricing will be specified grade + 5%
- If combining two materials of different grades or leather/fabric combination, use the highest grade/price + 5%
- If using COM or COL, pricing will be COM or COL + 5%.
- If both COM + COL are used in combination, use COL + 5%.

Node Power Placement Option

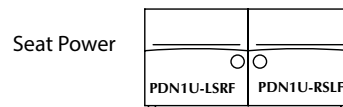
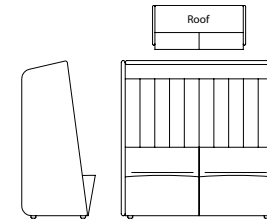

Table Power NA



[View statement of line](#)

## Product features.

- Screens are constructed from tubular metal that is welded to maximize the strength, precise measurements and overall longevity.
- Horizontal back provides easy ganging capabilities.
- Utilizes elastic webbing suspension that conforms to individual's lumbar curvatures for adaptive support.
- Upholstered screens & roof can be specified in contrasting fabrics, vinyl, or leathers.
- All units are standard with 1" adjustable glides that allow for leveling

### NOTES

- Please consult customer service when specifying a table other than Bota to ensure adequacy of seat access

## Options.

### POWER

- PDN1U-LSRF: Node in Left Seat Right Facing Seat Front; 1 Power/1 USB Charger - \$325
- PDN1U-RSLF: Node in Right Seat Left Facing Seat Front; 1 Power/1 USB Charger - \$325
- PDN1U-BC: Node in Both Left and Right Facing Center Seat Front; 1 Power/1 USB Charger per pod - \$650
- Standard in White (Available in Silver and Black)

### 1/2" COMPACT MATTE LAMINATE TABLET

- FFD: 1/2" Compact Matte Laminate Tablet - \$570, Specify LAW Alaska or LNB Nero Finish
- Tablet is center mount only

### PREMIUM FINISH OPTION (STANDARD WHITE)

- Specify rear table bracket metal finish color - \$100 per unit
- Specify tablet metal finish color - \$100 per unit
- MFS: Silver, MFB: Black



bota.

90 Deg. Circllet - Single Seat Low Back  
 90 Degree Back Inside Radius - Low Back

1 model	COM	COL	1	2	3	4	5	6	7	8	9	10	11/L1	12	13/L2
BOT0160LCS90	2439	2607	2661	2770	2879	2988	3097	3206	3315	3424	3533	3642	3751	3860	4078
W x D x H			Upholstery Requirements												
55.75 x 28.5 x 28.25			Fabric yds: 6 Leather Sq. Ft.: 108												
Arm Height: -			Carton Weight: 55												
Seat Height: 17.5															
Inside Seat Depth: 17															
Inside Seat Width: 29.5															

2 Select a finish  
[View finish details](#)

3 Combination Fabrics  
[View finish details](#)

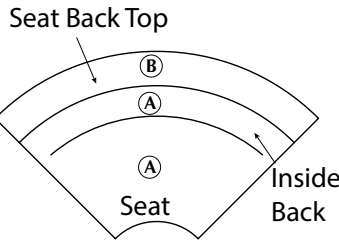
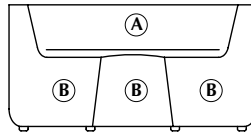

Node Power Placement Option

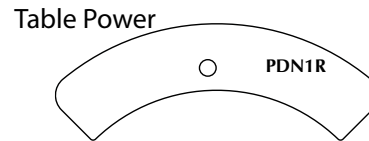

Seat Power N/A

**DARRAN is pleased to offer customers the design freedom of combination fabrics. When using fabric, vinyl or leather combinations, pricing/yardage requirements will be as follows:**

**A Inside Back & Seat 2 yds**  
**B Lounge Exterior 6 yds**

- When combining two materials of the same grade, pricing will be specified grade + 5%
- If combining two materials of different grades or leather/fabric combination, use the highest grade/price + 5%
- If using COM or COL, pricing will be COM or COL + 5%.
- If both COM + COL are used in combination, use COL + 5%.

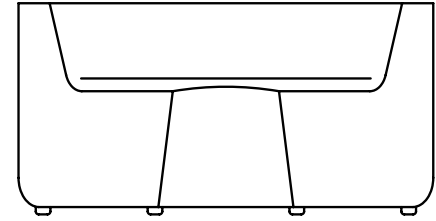

[View statement of line](#)

### Product features.

- Horizontal back provides easy ganging capabilities.
- Utilizes elastic webbing suspension that conforms to individual's lumbar curvatures for adaptive support.
- All units are standard with 1" adjustable glides that allow for leveling

### Options.

#### GANGING DEVICE

- GDEV-L: Left Facing Ganging Device - \$20
- GDEV-R: Right Facing Ganging Device - \$20
- GDEV-C: Center Ganging Device - \$40

#### POWER

- PDN1R- Node in Rear Mount Table Top; 1 Power/1 USB Charger - \$375
- Standard in White (Available in Silver and Black)

#### 1/2" COMPACT MATTE LAMINATE REAR TABLE

- Matte Laminate RTD55: Rear Work Table - \$1,305, Specify LAW Alaska or LNB Nero Finish
- Rear table available on units that gang providing stability
- Rear table is mounted at 28.5"

#### PREMIUM FINISH OPTION (STANDARD WHITE)

- Specify rear table bracket metal finish color - \$100 per unit
- MFS: Silver, MFB: Black

bota.

90 Deg. Circllet - Single Seat Low Back With Privacy Screen  
 90 Degree Back Inside Radius - Low Back - 10.5" Privacy Screen

1 model	COM	COL	1	2	3	4	5	6	7	8	9	10	11/L1	12	13/L2
BOT0160LCL90	3265	3474	3561	3707	3853	3999	4145	4291	4437	4583	4729	4875	5021	5167	5459
W x D x H			Upholstery Requirements												
55.75 x 28.5 x 39			Fabric yds: 8 Leather Sq. Ft.: 144												
Arm Height: -			Carton Weight: 65												
Seat Height: 17.5															
Inside Seat Depth: 17															
Inside Seat Width: 29.5															

2 Select a finish  
[View finish details](#)

3 Combination Fabrics  
[View finish details](#)

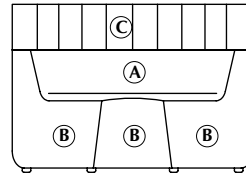

DARRAN is pleased to offer customers the design freedom of combination fabrics. When using fabric, vinyl or leather combinations, pricing/yardage requirements will be as follows:

- A Inside Back & Seat 2 yds
- B Lounge Exterior 6 yds
- C Privacy Screen 2.5 yds

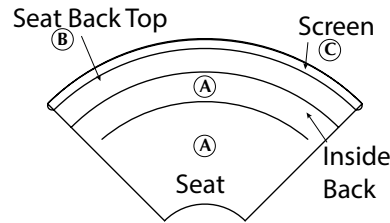

- When combining two materials of the same grade, pricing will be specified grade + 5%
- If combining two materials of different grades or leather/fabric combination, use the highest grade/price + 5%
- If using COM or COL, pricing will be COM or COL + 5%.
- If both COM + COL are used in combination, use COL + 5%.

Node Power Placement Option

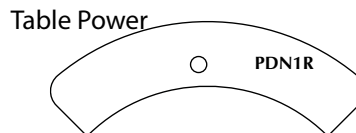

Seat Power N/A

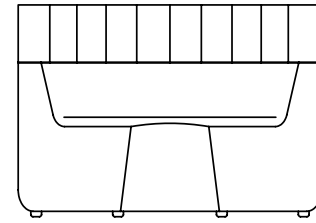

[View statement of line](#)

## Product features.

- Upholstered screens can be specified in contrasting fabrics, vinyl, or leathers.
- All units are standard with 1" adjustable glides that allow for leveling

## Options.

### GANGING DEVICE

- GDEV-L: Left Facing Ganging Device - \$20
- GDEV-R: Right Facing Ganging Device - \$20
- GDEV-C: Center Ganging Device - \$40

### POWER

- PDN1R- Node in Rear Mount Table Top; 1 Power/1 USB Charger - \$375
- Standard in White (Available in Silver and Black)

### 1/2" COMPACT MATTE LAMINATE REAR TABLE

- Matte Laminate RTD55: Rear Work Table - \$1,305, Specify LAW Alaska or LNB Nero Finish
- Rear table available on units that gang providing stability
- Rear table is mounted at 28.5"

### PREMIUM FINISH OPTION (STANDARD WHITE)

- Specify rear table bracket metal finish color - \$100 per unit
- MFS: Silver, MFB: Black

bota.

90 Deg. Circlet - Single Seat Low Back With Privacy Screen  
 90 Degree Back Inside Radius - Low Back - 24.75" Privacy Screen

1 model	COM	COL	1	2	3	4	5	6	7	8	9	10	11/L1	12	13/L2
BOT0160LCH90	3760	4024	4130	4312	4494	4676	4858	5040	5222	5404	5586	5768	5950	6132	6496
W x D x H			Upholstery Requirements												
55.75 x 28.5 x 53.25			Fabric yds: 10 Leather Sq. Ft.: 180												
Arm Height: -			Carton Weight: 70												
Seat Height: 17.5															
Inside Seat Depth: 17															
Inside Seat Width: 29.5															

2 Select a finish  
[View finish details](#)

3 Combination Fabrics  
[View finish details](#)

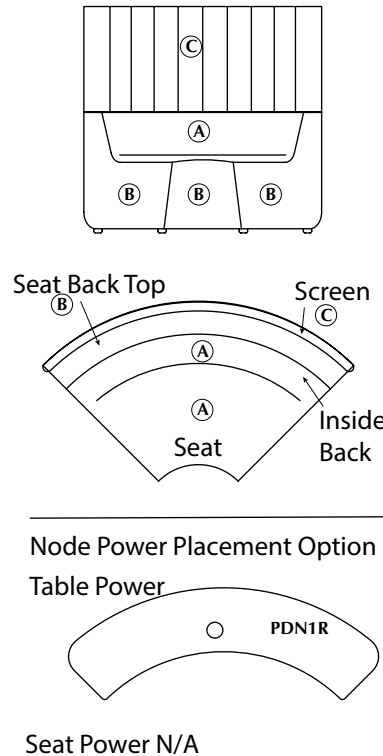

DARRAN is pleased to offer customers the design freedom of combination fabrics. When using fabric, vinyl or leather combinations, pricing/yardage requirements will be as follows:

- A Inside Back & Seat 2 yds
- B Lounge Exterior 6 yds
- C Privacy Screen 5 yds

- When combining two materials of the same grade, pricing will be specified grade + 5%
- If combining two materials of different grades or leather/fabric combination, use the highest grade/price + 5%
- If using COM or COL, pricing will be COM or COL + 5%.
- If both COM + COL are used in combination, use COL + 5%.

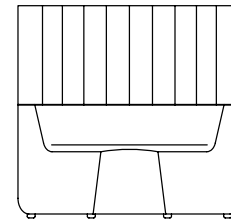

[View statement of line](#)

## Product features.

- Horizontal back provides easy ganging capabilities.
- Utilizes elastic webbing suspension that conforms to individual's lumbar curvatures for adaptive support.
- Upholstered Privacy Screen
- Upholstered screens can be specified in contrasting fabrics, vinyl, or leathers.
- All units are standard with 1" adjustable glides that allow for leveling

## Options.

### GANGING DEVICE

- GDEV-L: Left Facing Ganging Device - \$20
- GDEV-R: Right Facing Ganging Device - \$20
- GDEV-C: Center Ganging Device - \$40

### POWER

- PDN1R- Node in Rear Mount Table Top; 1 Power/1 USB Charger - \$375
- Standard in White (Available in Silver and Black)

### 1/2" COMPACT MATTE LAMINATE REAR TABLE

- Matte Laminate RTD55: Rear Work Table - \$1,305, Specify LAW Alaska or LNB Nero Finish
- Rear table available on units that gang providing stability
- Rear table is mounted at 28.5"

### PREMIUM FINISH OPTION (STANDARD WHITE)

- Specify rear table bracket metal finish color - \$100 per unit
- MFS: Silver, MFB: Black

bota.

90 Deg. Circllet - Single Seat High Back  
 90 Degree Back Inside Radius - High Back

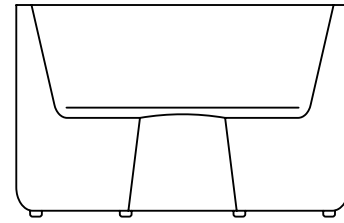

*View statement of line*

**Product features.**

- Horizontal back provides easy ganging capabilities.
- Utilizes elastic webbing suspension that conforms to individual's lumbar curvatures for adaptive support.
- All units are standard with 1" adjustable glides that allow for leveling

1 model	COM	COL	1	2	3	4	5	6	7	8	9	10	11/L1	12	13/L2
BOT0160HCS90	2810	2985	3051	3170	3289	3408	3527	3646	3765	3884	4003	4122	4241	4360	4598
W x D x H			Upholstery Requirements												
55.75 x 28.5 x 35.5			Fabric yds: 6.5 Leather Sq. Ft.: 117												
Arm Height: -			Carton Weight: 60												
Seat Height: 17.5															
Inside Seat Depth: 17															
Inside Seat Width: 29.5															

2 Select a finish  
*View finish details*

3 Combination Fabrics  
*View finish details*

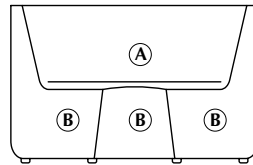

**DARRAN is pleased to offer customers the design freedom of combination fabrics. When using fabric, vinyl or leather combinations, pricing/yardage requirements will be as follows:**

**A Inside Back & Seat 3 yds**  
**B Lounge Exterior 6 yds**

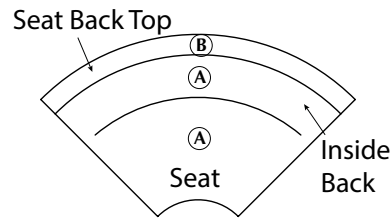

- When combining two materials of the same grade, pricing will be specified grade + 5%
- If combining two materials of different grades or leather/fabric combination, use the highest grade/price + 5%
- If using COM or COL, pricing will be COM or COL + 5%.
- If both COM + COL are used in combination, use COL + 5%.

**Node Power Placement Option**

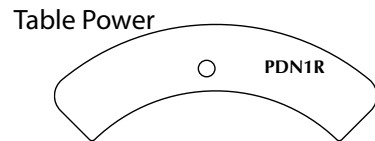

Table Power  
 Seat Power N/A

**Options.**

**GANGING DEVICE**

- GDEV-L: Left Facing Ganging Device - \$20
- GDEV-R: Right Facing Ganging Device - \$20
- GDEV-C: Center Ganging Device - \$40

**POWER**

- PDN1R- Node in Rear Mount Table Top; 1 Power/1 USB Charger - \$375
- Standard in White (Available in Silver and Black)

**1/2" COMPACT MATTE LAMINATE REAR TABLE**

- Matte Laminate RTD55: Rear Work Table - \$1,305, Specify LAW Alaska or LNB Nero Finish
- Rear table available on units that gang providing stability
- Rear table is mounted at 35.5"

**PREMIUM FINISH OPTION (STANDARD WHITE)**

- Specify rear table bracket metal finish color - \$100 per unit
- MFS: Silver, MFB: Black

bota.

90 Deg. Circllet - Single Seat High Back With Privacy Screen  
 90 Degree Back Inside Radius - High Back - 10.5" Privacy Screen

1 model	COM	COL	1	2	3	4	5	6	7	8	9	10	11/L1	12	13/L2
BOT0160HCL90	3617	3833	3950	4114	4278	4442	4606	4770	4934	5098	5262	5426	5590	5754	6082
W x D x H			Upholstery Requirements												
55.75 x 28.5 x 46			Fabric yds: 9 Leather Sq. Ft.: 162												
Arm Height: -			Carton Weight: 70												
Seat Height: 17.5															
Inside Seat Depth: 17															
Inside Seat Width: 29.5															

2 Select a finish  
[View finish details](#)

3 Combination Fabrics  
[View finish details](#)

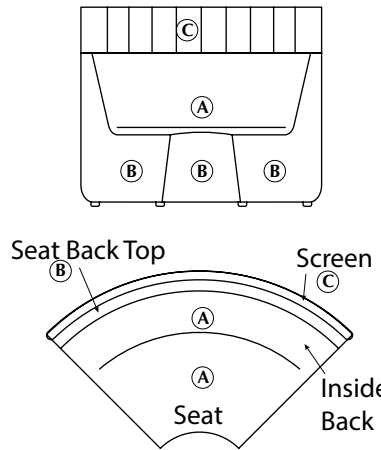

Node Power Placement Option

Table Power

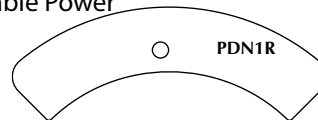

Seat Power N/A

DARRAN is pleased to offer customers the design freedom of combination fabrics. When using fabric, vinyl or leather combinations, pricing/yardage requirements will be as follows:

- A Inside Back & Seat 3 yds
- B Lounge Exterior 6 yds
- C Privacy Screen 2.5 yds

- When combining two materials of the same grade, pricing will be specified grade + 5%
- If combining two materials of different grades or leather/fabric combination, use the highest grade/price + 5%
- If using COM or COL, pricing will be COM or COL + 5%.
- If both COM + COL are used in combination, use COL + 5%.

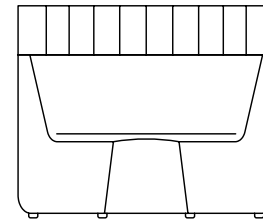

[View statement of line](#)

## Product features.

- Horizontal back provides easy ganging capabilities.
- Utilizes elastic webbing suspension that conforms to individual's lumbar curvatures for adaptive support.
- Upholstered Privacy Screen
- Upholstered screens can be specified in contrasting fabrics, vinyl, or leathers.
- All units are standard with 1" adjustable glides that allow for leveling

## Options.

### GANGING DEVICE

- GDEV-L: Left Facing Ganging Device - \$20
- GDEV-R: Right Facing Ganging Device - \$20
- GDEV-C: Center Ganging Device - \$40

### POWER

- PDN1R- Node in Rear Mount Table Top; 1 Power/1 USB Charger - \$375
- Standard in White (Available in Silver and Black)

### 1/2" COMPACT MATTE LAMINATE REAR TABLE

- Matte Laminate RTD55: Rear Work Table - \$1,305, Specify LAW Alaska or LNB Nero Finish
- Rear table available on units that gang providing stability
- Rear table is mounted at 35.5"

### PREMIUM FINISH OPTION (STANDARD WHITE)

- Specify rear table bracket metal finish color - \$100 per unit
- MFS: Silver, MFB: Black

bota.

90 Deg. Circllet - Single Seat High Back With Privacy Screen  
 90 Degree Back Inside Radius - High Back - 17.5" Privacy Screen

1 model	COM	COL	1	2	3	4	5	6	7	8	9	10	11/L1	12	13/L2
BOT0160HCH90	3751	3995	4177	4387	4597	4807	5017	5227	5437	5647	5857	6067	6277	6487	6907
W x D x H			Upholstery Requirements												
55.75 x 28.5 x 53			Fabric yds: 11.5 Leather Sq. Ft.: 207												
Arm Height: -			Carton Weight: 75												
Seat Height: 17.5															
Inside Seat Depth: 17															
Inside Seat Width: 29.5															

2 Select a finish  
[View finish details](#)

3 Combination Fabrics  
[View finish details](#)

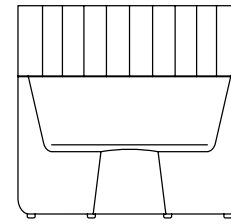

[View statement of line](#)

### Product features.

- Horizontal back provides easy ganging capabilities.
- Utilizes elastic webbing suspension that conforms to individual's lumbar curvatures for adaptive support.
- Upholstered Privacy Screen
- Upholstered screens can be specified in contrasting fabrics, vinyl, or leathers.
- All units are standard with 1" adjustable glides that allow for leveling

### Options.

#### GANGING DEVICE

- GDEV-L: Left Facing Ganging Device - \$20
- GDEV-R: Right Facing Ganging Device - \$20
- GDEV-C: Center Ganging Device - \$40

#### POWER

- PDN1R- Node in Rear Mount Table Top; 1 Power/1 USB Charger - \$375
- Standard in White (Available in Silver and Black)

#### 1/2" COMPACT MATTE LAMINATE REAR TABLE

- Matte Laminate RTD55: Rear Work Table - \$1,305, Specify LAW Alaska or LNB Nero Finish
- Rear table available on units that gang providing stability
- Rear table is mounted at 35.5"

#### PREMIUM FINISH OPTION (STANDARD WHITE)

- Specify rear table bracket metal finish color - \$100 per unit
- MFS: Silver, MFB: Black

DARRAN is pleased to offer customers the design freedom of combination fabrics. When using fabric, vinyl or leather combinations, pricing/yardage requirements will be as follows:

- A** Inside Back & Seat 3 yds
- B** Lounge Exterior 6 yds
- C** Privacy Screen 5 yds

- When combining two materials of the same grade, pricing will be specified grade + 5%
- If combining two materials of different grades or leather/fabric combination, use the highest grade/price + 5%
- If using COM or COL, pricing will be COM or COL + 5%.
- If both COM + COL are used in combination, use COL + 5%.

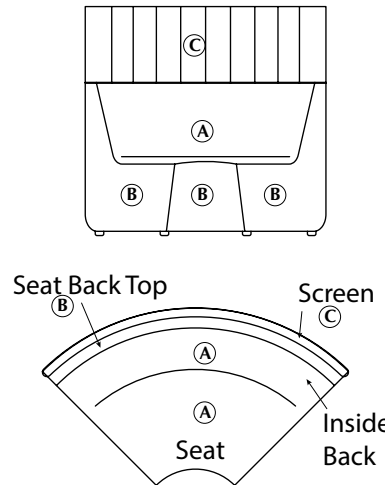

#### Node Power Placement Option

#### Table Power

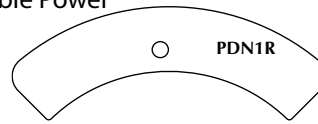

#### Seat Power N/A

bota.

60 Deg. Circllet - Double Seat Low Back  
60 Degree Back Inside Radius - Low Back

1 model	COM	COL	1	2	3	4	5	6	7	8	9	10	11/L1	12	13/L2
BOT0160LCS60	2689	2879	2911	3020	3129	3238	3347	3456	3565	3674	3783	3892	4001	4110	4328
W x D x H 63 x 28.5 x 28.25 Arm Height: - Seat Height: 17.5 Inside Seat Depth: 17 Inside Seat Width: 29.5			Upholstery Requirements Fabric yds: 6 Leather Sq. Ft.: 108 Carton Weight: 89												

2 Select a finish  
[View finish details](#)

3 Combination Fabrics  
[View finish details](#)

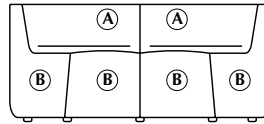

**DARRAN is pleased to offer customers the design freedom of combination fabrics. When using fabric, vinyl or leather combinations, pricing/yardage requirements will be as follows:**

**A Inside Back & Seat 2 yds**  
**B Lounge Exterior 6 yds**

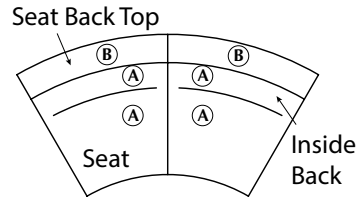

- When combining two materials of the same grade, pricing will be specified grade + 5%
- If combining two materials of different grades or leather/fabric combination, use the highest grade/price + 5%
- If using COM or COL, pricing will be COM or COL + 5%.
- If both COM + COL are used in combination, use COL + 5%.

**Node Power Placement Option**

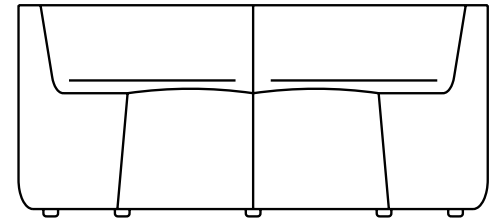
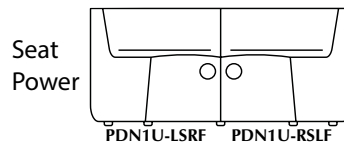
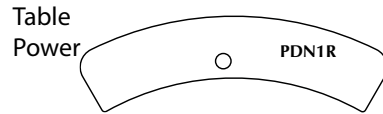

[View statement of line](#)

**Product features.**

- Horizontal back provides easy ganging capabilities.
- Utilizes elastic webbing suspension that conforms to individual's lumbar curvatures for adaptive support.
- All units are standard with 1" adjustable glides that allow for leveling

**Options.**

**GANGING DEVICE**

- GDEV-L: Left Facing Ganging Device - \$20
- GDEV-R: Right Facing Ganging Device - \$20
- GDEV-C: Center Ganging Device - \$40

**POWER**

- PDN1U-LSRF: Node in Left Seat Right Facing Seat Front; 1 Power/1 USB Charger - \$325
- PDN1U-RSLF: Node in Right Seat Left Facing Seat Front; 1 Power/1 USB Charger - \$325
- PDN1U-BC: Node in Both Left and Right Facing Center Seat Front; 1 Power/1 USB Charger per pod - \$650
- PDN1R- Node in Rear Mount Table Top; 1 Power/1 USB Charger - \$375
- Standard in White (Available in Silver and Black)

**1/2" COMPACT MATTE LAMINATE REAR TABLE**

- Matte Laminate RTD63: Rear Work Table - \$1,350, Specify LAW Alaska or LNB Nero Finish
- Rear table available on units that gang providing stability
- Rear table is mounted at 28.5"

**1/2" COMPACT MATTE LAMINATE TABLET**

- FFD: 1/2" Compact Matte Laminate Tablet - \$570, Specify LAW Alaska or LNB Nero Finish
- Tablet is center mount only

**PREMIUM FINISH OPTION (STANDARD WHITE)**

- Specify rear table bracket metal finish color - \$100 per unit
- Specify tablet metal finish color - \$100 per unit
- MFS: Silver, MFB: Black

bota.

60 Deg. Circllet - Double Seat Low Back With Privacy Screen  
 60 Degree Back Inside Radius - Low Back - 10.5" Privacy Screen

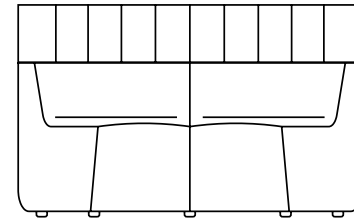

*View statement of line*

### Product features.

- Horizontal back provides easy ganging capabilities.
- Utilizes elastic webbing suspension that conforms to individual's lumbar curvatures for adaptive support.
- Upholstered Privacy Screen
- Upholstered screens can be specified in contrasting fabrics, vinyl, or leathers.
- All units are standard with 1" adjustable glides that allow for leveling

1 model	COM	COL	1	2	3	4	5	6	7	8	9	10	11/L1	12	13/L2
BOT0160LCL60	3505	3741	3801	3947	4093	4239	4385	4531	4677	4823	4969	5115	5261	5407	5699
W x D x H			Upholstery Requirements												
63 x 28.5 x 39			Fabric yds: 8 Leather Sq. Ft.: 144												
Arm Height: -			Carton Weight: 99												
Seat Height: 17.5															
Inside Seat Depth: 17															
Inside Seat Width: 29.5															

2 Select a finish  
*View finish details*

3 Combination Fabrics  
*View finish details*

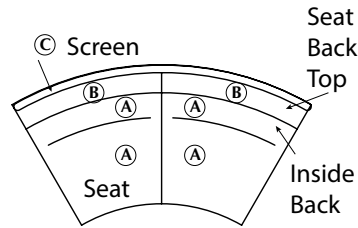
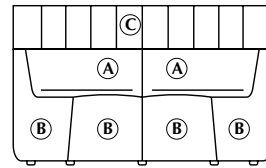

DARRAN is pleased to offer customers the design freedom of combination fabrics. When using fabric, vinyl or leather combinations, pricing/yardage requirements will be as follows:

- A Inside Back & Seat 2 yds
- B Lounge Exterior 6 yds
- C Privacy Screen 2.5 yds

- When combining two materials of the same grade, pricing will be specified grade + 5%
- If combining two materials of different grades or leather/fabric combination, use the highest grade/price + 5%
- If using COM or COL, pricing will be COM or COL + 5%.
- If both COM + COL are used in combination, use COL + 5%.

### Node Power Placement Option

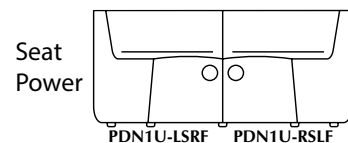
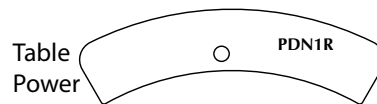

### Options.

#### GANGING DEVICE

- GDEV-L: Left Facing Ganging Device - \$20
- GDEV-R: Right Facing Ganging Device - \$20
- GDEV-C: Center Ganging Device - \$40

#### POWER

- PDN1U-LSRF: Node in Left Seat Right Facing Seat Front; 1 Power/1 USB Charger - \$325
- PDN1U-RSLF: Node in Right Seat Left Facing Seat Front; 1 Power/1 USB Charger - \$325
- PDN1U-BC: Node in Both Left and Right Facing Center Seat Front; 1 Power/1 USB Charger per pod - \$650
- PDN1R- Node in Rear Mount Table Top; 1 Power/1 USB Charger - \$375
- Standard in White (Available in Silver and Black)

#### 1/2" COMPACT MATTE LAMINATE REAR TABLE

- Matte Laminate RTD63: Rear Work Table - \$1,350, Specify LAW Alaska or LNB Nero Finish
- Rear table available on units that gang providing stability
- Rear table is mounted at 28.5"

#### 1/2" COMPACT MATTE LAMINATE TABLET

- FFD: 1/2" Compact Matte Laminate Tablet - \$570, Specify LAW Alaska or LNB Nero Finish
- Tablet is center mount only

#### PREMIUM FINISH OPTION (STANDARD WHITE)

- Specify rear table bracket metal finish color - \$100 per unit
- Specify tablet metal finish color - \$100 per unit
- MFS: Silver, MFB: Black



bota.

60 Deg. Circllet - Double Seat Low Back With Privacy Screen  
 60 Degree Back Inside Radius - Low Back - 24.75" Privacy Screen

1 model	COM	COL	1	2	3	4	5	6	7	8	9	10	11/L1	12	13/L2
BOT0160LCH60	4064	4363	4434	4616	4798	4980	5162	5344	5526	5708	5890	6072	6254	6436	6800
W x D x H			Upholstery Requirements												
63 x 28.5 x 53.25			Fabric yds: 10 Leather Sq. Ft.: 180												
Arm Height: -			Carton Weight: 119												
Seat Height: 17.5															
Inside Seat Depth: 17															
Inside Seat Width: 29.5															

2 Select a finish  
[View finish details](#)

3 Combination Fabrics  
[View finish details](#)

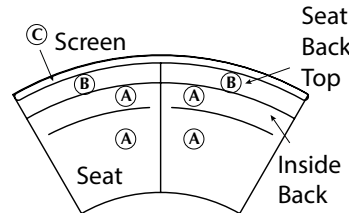
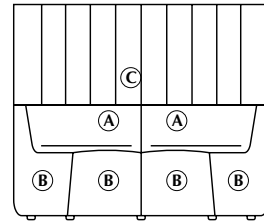

DARRAN is pleased to offer customers the design freedom of combination fabrics. When using fabric, vinyl or leather combinations, pricing/yardage requirements will be as follows:

- A Inside Back & Seat 2 yds
- B Lounge Exterior 6 yds
- C Privacy Screen 5 yds

- When combining two materials of the same grade, pricing will be specified grade + 5%
- If combining two materials of different grades or leather/fabric combination, use the highest grade/price + 5%
- If using COM or COL, pricing will be COM or COL + 5%.
- If both COM + COL are used in combination, use COL + 5%.

Node Power Placement Option

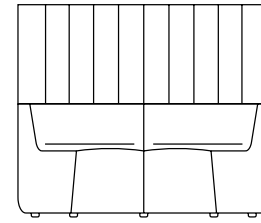
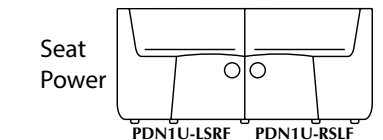
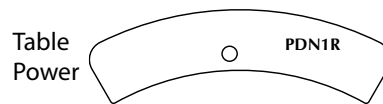

[View statement of line](#)

Product features.

- Horizontal back provides easy ganging capabilities.
- Utilizes elastic webbing suspension that conforms to individual's lumbar curvatures for adaptive support.
- Upholstered Privacy Screen
- Upholstered screens can be specified in contrasting fabrics, vinyl, or leathers.
- All units are standard with 1" adjustable glides that allow for leveling

Options.

GANGING DEVICE

- GDEV-L: Left Facing Ganging Device - \$20
- GDEV-R: Right Facing Ganging Device - \$20
- GDEV-C: Center Ganging Device - \$40

POWER

- PDN1U-LSRF: Node in Left Seat Right Facing Seat Front; 1 Power/1 USB Charger - \$325
- PDN1U-RSLF: Node in Right Seat Left Facing Seat Front; 1 Power/1 USB Charger - \$325
- PDN1U-BC: Node in Both Left and Right Facing Center Seat Front; 1 Power/1 USB Charger per pod - \$650
- PDN1R- Node in Rear Mount Table Top; 1 Power/1 USB Charger - \$375
- Standard in White (Available in Silver and Black)

1/2" COMPACT MATTE LAMINATE REAR TABLE

- Matte Laminate RTD63: Rear Work Table - \$1,350, Specify LAW Alaska or LNB Nero Finish
- Rear table available on units that gang providing stability
- Rear table is mounted at 28.5"

1/2" COMPACT MATTE LAMINATE TABLET

- FFD: 1/2" Compact Matte Laminate Tablet - \$570, Specify LAW Alaska or LNB Nero Finish
- Tablet is center mount only

PREMIUM FINISH OPTION (STANDARD WHITE)

- Specify rear table bracket metal finish color - \$100 per unit
- Specify tablet metal finish color - \$100 per unit
- MFS: Silver, MFB: Black

bota.

60 Deg. Circllet - Double Seat High Back  
60 Degree Back Inside Radius - High Back

1 model	COM	COL	1	2	3	4	5	6	7	8	9	10	11/L1	12	13/L2
BOT0160HCS60	3059	3257	3300	3419	3538	3657	3776	3895	4014	4133	4252	4371	4490	4609	4847
W x D x H 63 x 28.5 x 35.5			Upholstery Requirements												
Arm Height: -			Fabric yds: 6.5 Leather Sq. Ft.: 117												
Seat Height: 17.5			Carton Weight: 94												
Inside Seat Depth: 17															
Inside Seat Width: 29.5															

2 Select a finish  
[View finish details](#)

3 Combination Fabrics  
[View finish details](#)

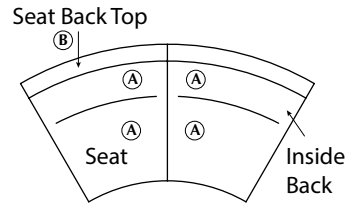
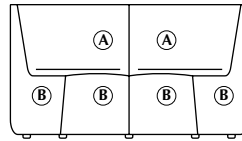

Node Power Placement Option

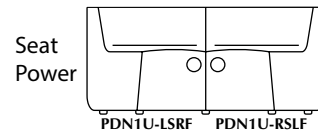
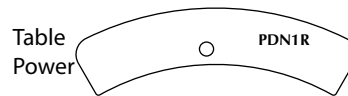

**DARRAN is pleased to offer customers the design freedom of combination fabrics. When using fabric, vinyl or leather combinations, pricing/yardage requirements will be as follows:**

**A Inside Back & Seat 3 yds**  
**B Lounge Exterior 6 yds**

- When combining two materials of the same grade, pricing will be specified grade + 5%
- If combining two materials of different grades or leather/fabric combination, use the highest grade/price + 5%
- If using COM or COL, pricing will be COM or COL + 5%.
- If both COM + COL are used in combination, use COL + 5%.

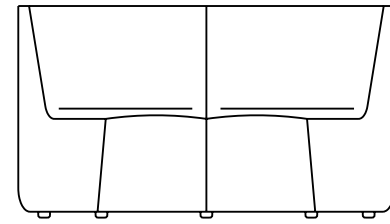

[View statement of line](#)

## Product features.

- Horizontal back provides easy ganging capabilities.
- Utilizes elastic webbing suspension that conforms to individual's lumbar curvatures for adaptive support.
- All units are standard with 1" adjustable glides that allow for leveling

## Options.

### GANGING DEVICE

- GDEV-L: Left Facing Ganging Device - \$20
- GDEV-R: Right Facing Ganging Device - \$20
- GDEV-C: Center Ganging Device - \$40

### POWER

- PDN1U-LSRF: Node in Left Seat Right Facing Seat Front; 1 Power/1 USB Charger - \$325
- PDN1U-RSLF: Node in Right Seat Left Facing Seat Front; 1 Power/1 USB Charger - \$325
- PDN1U-BC: Node in Both Left and Right Facing Center Seat Front; 1 Power/1 USB Charger per pod - \$650
- PDN1R- Node in Rear Mount Table Top; 1 Power/1 USB Charger - \$375
- Standard in White (Available in Silver and Black)

### 1/2" COMPACT MATTE LAMINATE REAR TABLE

- Matte Laminate RTD63: Rear Work Table - \$1,350, Specify LAW Alaska or LNB Nero Finish
- Rear table available on units that gang providing stability
- Rear table is mounted at 35.5"

### 1/2" COMPACT MATTE LAMINATE TABLET

- FFD: 1/2" Compact Matte Laminate Tablet - \$570, Specify LAW Alaska or LNB Nero Finish
- Tablet is center mount only

### PREMIUM FINISH OPTION (STANDARD WHITE)

- Specify rear table bracket metal finish color - \$100 per unit
- Specify tablet metal finish color - \$100 per unit
- MFS: Silver, MFB: Black

bota.

60 Deg. Circllet - Double Seat High Back With Privacy Screen  
 60 Degree Back Inside Radius - High Back - 10.5" Privacy Screen

1 model	COM	COL	1	2	3	4	5	6	7	8	9	10	11/L1	12	13/L2
BOT0160HCL60	3887	4130	4220	4384	4548	4712	4876	5040	5204	5368	5532	5696	5860	6024	6352
W x D x H			Upholstery Requirements												
63 x 28.5 x 46			Fabric yds: 9 Leather Sq. Ft.: 162												
Arm Height: -			Carton Weight: 114												
Seat Height: 17.5															
Inside Seat Depth: 17															
Inside Seat Width: 29.5															

2 Select a finish  
 View finish details

3 Combination Fabrics  
 View finish details

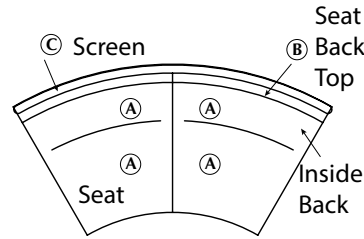
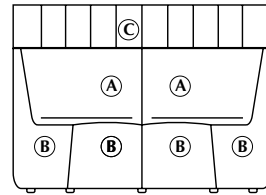

Node Power Placement Option

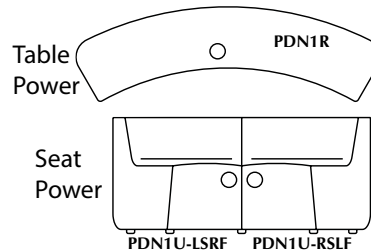

DARRAN is pleased to offer customers the design freedom of combination fabrics. When using fabric, vinyl or leather combinations, pricing/yardage requirements will be as follows:

- A Inside Back & Seat 3 yds
- B Lounge Exterior 6 yds
- C Privacy Screen 2.5 yds

- When combining two materials of the same grade, pricing will be specified grade + 5%
- If combining two materials of different grades or leather/fabric combination, use the highest grade/price + 5%
- If using COM or COL, pricing will be COM or COL + 5%.
- If both COM + COL are used in combination, use COL + 5%.

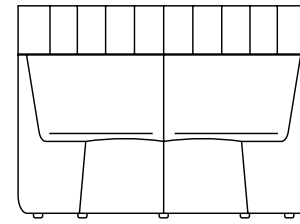

View statement of line

Product features.

- Horizontal back provides easy ganging capabilities.
- Utilizes elastic webbing suspension that conforms to individual's lumbar curvatures for adaptive support.
- Upholstered Privacy Screen
- Upholstered screens can be specified in contrasting fabrics, vinyl, or leathers.
- All units are standard with 1" adjustable glides that allow for leveling

Options.

GANGING DEVICE

- GDEV-L: Left Facing Ganging Device - \$20
- GDEV-R: Right Facing Ganging Device - \$20
- GDEV-C: Center Ganging Device - \$40

POWER

- PDN1U-LSRF: Node in Left Seat Right Facing Seat Front; 1 Power/1 USB Charger - \$325
- PDN1U-RSLF: Node in Right Seat Left Facing Seat Front; 1 Power/1 USB Charger - \$325
- PDN1U-BC: Node in Both Left and Right Facing Center Seat Front; 1 Power/1 USB Charger per pod - \$650
- PDN1R- Node in Rear Mount Table Top; 1 Power/1 USB Charger - \$375
- Standard in White (Available in Silver and Black)
- 1/2" COMPACT MATTE LAMINATE REAR TABLE
- Matte Laminate RTD63: Rear Work Table - \$1,350, Specify LAW Alaska or LNB Nero Finish
- Rear table available on units that gang providing stability
- Rear table is mounted at 35.5"
- 1/2" COMPACT MATTE LAMINATE TABLET
- FFD: 1/2" Compact Matte Laminate Tablet - \$570, Specify LAW Alaska or LNB Nero Finish
- Tablet is center mount only
- PREMIUM FINISH OPTION (STANDARD WHITE)
- Specify rear table bracket metal finish color - \$100 per unit
- Specify tablet metal finish color - \$100 per unit
- MFS: Silver, MFB: Black

bota.

60 Deg. Circlet - Double Seat High Back With Privacy Screen  
 60 Degree Back Inside Radius - High Back - 17.5" Privacy Screen

1 model	COM	COL	1	2	3	4	5	6	7	8	9	10	11/L1	12	13/L2
BOT0160HCH60	4173	4449	4599	4809	5019	5229	5439	5649	5859	6069	6279	6489	6699	6909	7329
W x D x H			Upholstery Requirements												
63 x 28.5 x 53			Fabric yds: 11.5 Leather Sq. Ft.: 207												
Arm Height: -			Carton Weight: 124												
Seat Height: 17.5															
Inside Seat Depth: 17															
Inside Seat Width: 29.5															

2 Select a finish  
[View finish details](#)

3 Combination Fabrics  
[View finish details](#)

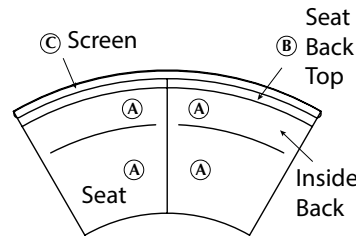
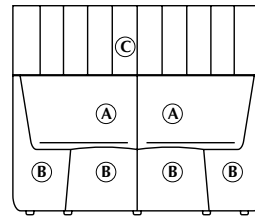

**Node Power Placement Option**

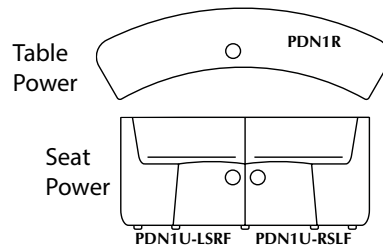

DARRAN is pleased to offer customers the design freedom of combination fabrics. When using fabric, vinyl or leather combinations, pricing/yardage requirements will be as follows:

- A** Inside Back & Seat 3 yds
- B** Lounge Exterior 6 yds
- C** Privacy Screen 5 yds

- When combining two materials of the same grade, pricing will be specified grade + 5%
- If combining two materials of different grades or leather/fabric combination, use the highest grade/price + 5%
- If using COM or COL, pricing will be COM or COL + 5%.
- If both COM + COL are used in combination, use COL + 5%.

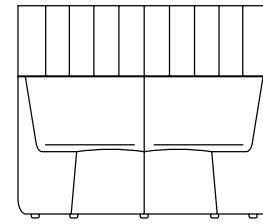

[View statement of line](#)

**Product features.**

- Horizontal back provides easy ganging capabilities.
- Utilizes elastic webbing suspension that conforms to individual's lumbar curvatures for adaptive support.
- Upholstered Privacy Screen
- Upholstered screens can be specified in contrasting fabrics, vinyl, or leathers.
- All units are standard with 1" adjustable glides that allow for leveling

**Options.**

**GANGING DEVICE**

- GDEV-L: Left Facing Ganging Device - \$20
- GDEV-R: Right Facing Ganging Device - \$20
- GDEV-C: Center Ganging Device - \$40

**POWER**

- PDN1U-LSRF: Node in Left Seat Right Facing Seat Front; 1 Power/1 USB Charger - \$325
- PDN1U-RSLF: Node in Right Seat Left Facing Seat Front; 1 Power/1 USB Charger - \$325
- PDN1U-BC: Node in Both Left and Right Facing Center Seat Front; 1 Power/1 USB Charger per pod - \$650
- PDN1R- Node in Rear Mount Table Top; 1 Power/1 USB Charger - \$375
- Standard in White (Available in Silver and Black)

**1/2" COMPACT MATTE LAMINATE REAR TABLE**

- Matte Laminate RTD63: Rear Work Table - \$1,350, Specify LAW Alaska or LNB Nero Finish
- Rear table available on units that gang providing stability
- Rear table is mounted at 35.5"

**1/2" COMPACT MATTE LAMINATE TABLET**

- FFD: 1/2" Compact Matte Laminate Tablet - \$570, Specify LAW Alaska or LNB Nero Finish
- Tablet is center mount only

**PREMIUM FINISH OPTION (STANDARD WHITE)**

- Specify rear table bracket metal finish color - \$100 per unit
- Specify tablet metal finish color - \$100 per unit
- MFS: Silver, MFB: Black

bota.

45 Deg. Circllet - Double Seat Low Back  
45 Degree Back Inside Radius - Low Back

1 model	COM	COL	1	2	3	4	5	6	7	8	9	10	11/L1	12	13/L2
BOT0160LCS45	2633	2823	2892	3020	3148	3276	3404	3532	3660	3788	3916	4044	4172	4300	4556
W x D x H 60.25 x 28.5 x 28.25 Arm Height: - Seat Height: 17.5 Inside Seat Depth: 17 Inside Seat Width: 29.5			Upholstery Requirements Fabric yds: 7 Leather Sq. Ft.: 126 Carton Weight: 84												

2 Select a finish  
[View finish details](#)

3 Combination Fabrics  
[View finish details](#)

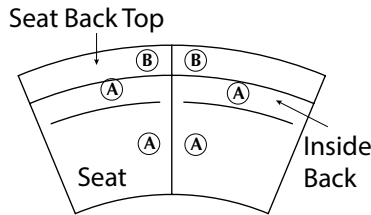
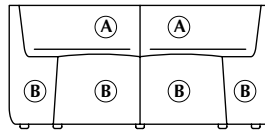

Node Power Placement Option

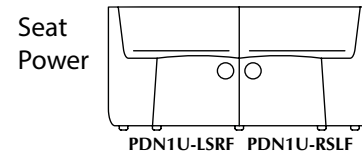
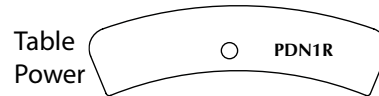

DARRAN is pleased to offer customers the design freedom of combination fabrics. When using fabric, vinyl or leather combinations, pricing/yardage requirements will be as follows:

A Inside Back & Seat 2 yds  
B Lounge Exterior 7 yds

- When combining two materials of the same grade, pricing will be specified grade + 5%
- If combining two materials of different grades or leather/fabric combination, use the highest grade/price + 5%
- If using COM or COL, pricing will be COM or COL + 5%.
- If both COM + COL are used in combination, use COL + 5%.

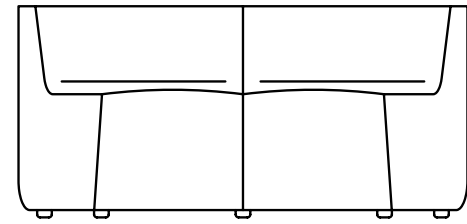

[View statement of line](#)

Product features.

- Horizontal back provides easy ganging capabilities.
- Utilizes elastic webbing suspension that conforms to individual's lumbar curvatures for adaptive support.
- All units are standard with 1" adjustable glides that allow for leveling

Options.

GANGING DEVICE

- GDEV-L: Left Facing Ganging Device - \$20
- GDEV-R: Right Facing Ganging Device - \$20
- GDEV-C: Center Ganging Device - \$40

POWER

- PDN1U-LSRF: Node in Left Seat Right Facing Seat Front; 1 Power/1 USB Charger - \$325
- PDN1U-RSLF: Node in Right Seat Left Facing Seat Front; 1 Power/1 USB Charger - \$325
- PDN1U-BC: Node in Both Left and Right Facing Center Seat Front; 1 Power/1 USB Charger per pod - \$650
- PDN1R- Node in Rear Mount Table Top; 1 Power/1 USB Charger - \$375
- Standard in White (Available in Silver and Black)

1/2" COMPACT MATTE LAMINATE REAR TABLE

- Matte Laminate RTD60: Rear Work Table - \$1,260, Specify LAW Alaska or LNB Nero Finish
- Rear table available on units that gang providing stability
- Rear table is mounted at 28.5"

1/2" COMPACT MATTE LAMINATE TABLET

- FFD: 1/2" Compact Matte Laminate Tablet - \$570, Specify LAW Alaska or LNB Nero Finish
- Tablet is center mount only

PREMIUM FINISH OPTION (STANDARD WHITE)

- Specify rear table bracket metal finish color - \$100 per unit
- Specify tablet metal finish color - \$100 per unit
- MFS: Silver, MFB: Black

bota.

45 Deg. Circllet - Double Seat Low Back With Privacy Screen  
 45 Degree Back Inside Radius - Low Back - 10.5" Privacy Screen

1 model	COM	COL	1	2	3	4	5	6	7	8	9	10	11/L1	12	13/L2
BOT0160LCL45	3485	3720	3818	3982	4146	4310	4474	4638	4802	4966	5130	5294	5458	5622	5950
W x D x H			Upholstery Requirements												
60.25 x 28.5 x 39			Fabric yds: 9 Leather Sq. Ft.: 162												
Arm Height: -			Carton Weight: 94												
Seat Height: 17.5															
Inside Seat Depth: 17															
Inside Seat Width: 29.5															

2 Select a finish  
[View finish details](#)

3 Combination Fabrics  
[View finish details](#)

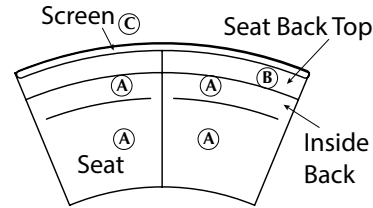
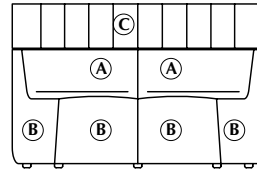

DARRAN is pleased to offer customers the design freedom of combination fabrics. When using fabric, vinyl or leather combinations, pricing/yardage requirements will be as follows:

- A Inside Back & Seat 2 yds
- B Lounge Exterior 7 yds
- C Privacy Screen 2.5 yds

- When combining two materials of the same grade, pricing will be specified grade + 5%
- If combining two materials of different grades or leather/fabric combination, use the highest grade/price + 5%
- If using COM or COL, pricing will be COM or COL + 5%.
- If both COM + COL are used in combination, use COL + 5%.

**Node Power Placement Option**

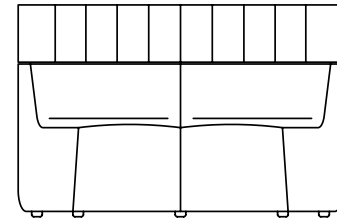
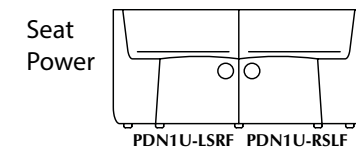

[View statement of line](#)

**Product features.**

- Horizontal back provides easy ganging capabilities.
- Utilizes elastic webbing suspension that conforms to individual's lumbar curvatures for adaptive support.
- Upholstered Privacy Screen
- Upholstered screens can be specified in contrasting fabrics, vinyl, or leathers.
- All units are standard with 1" adjustable glides that allow for leveling

**Options.**

**GANGING DEVICE**

- GDEV-L: Left Facing Ganging Device - \$20
- GDEV-R: Right Facing Ganging Device - \$20
- GDEV-C: Center Ganging Device - \$40

**POWER**

- PDN1U-LSRF: Node in Left Seat Right Facing Seat Front; 1 Power/1 USB Charger - \$325
- PDN1U-RSLF: Node in Right Seat Left Facing Seat Front; 1 Power/1 USB Charger - \$325
- PDN1U-BC: Node in Both Left and Right Facing Center Seat Front; 1 Power/1 USB Charger per pod - \$650
- PDN1R- Node in Rear Mount Table Top; 1 Power/1 USB Charger - \$375
- Standard in White (Available in Silver and Black)

**1/2" COMPACT MATTE LAMINATE REAR TABLE**

- Matte Laminate RTD60: Rear Work Table - \$1,260, Specify LAW Alaska or LNB Nero Finish
- Rear table available on units that gang providing stability
- Rear table is mounted at 28.5"

**1/2" COMPACT MATTE LAMINATE TABLET**

- FFD: 1/2" Compact Matte Laminate Tablet - \$570, Specify LAW Alaska or LNB Nero Finish
- Tablet is center mount only

**PREMIUM FINISH OPTION (STANDARD WHITE)**

- Specify rear table bracket metal finish color - \$100 per unit
- Specify tablet metal finish color - \$100 per unit
- MFS: Silver, MFB: Black

bota.

45 Deg. Circlet - Double Seat Low Back With Privacy Screen  
 45 Degree Back Inside Radius - Low Back - 24.75" Privacy Screen

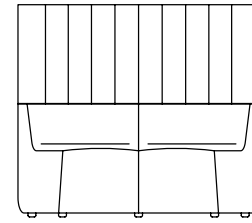

*View statement of line*

### Product features.

- Horizontal back provides easy ganging capabilities.
- Utilizes elastic webbing suspension that conforms to individual's lumbar curvatures for adaptive support.
- Upholstered Privacy Screen
- Upholstered screens can be specified in contrasting fabrics, vinyl, or leathers.
- All units are standard with 1" adjustable glides that allow for leveling

1 model	COM	COL	1	2	3	4	5	6	7	8	9	10	11/L1	12	13/L2
BOT0160LCH45	4018	4313	4425	4626	4827	5028	5229	5430	5631	5832	6033	6234	6435	6636	7038
W x D x H			Upholstery Requirements												
60.25 x 28.5 x 53.25			Fabric yds: 11 Leather Sq. Ft.: 198												
Arm Height: -			Carton Weight: 114												
Seat Height: 17.5															
Inside Seat Depth: 17															
Inside Seat Width: 29.5															

2 Select a finish  
*View finish details*

3 Combination Fabrics  
*View finish details*

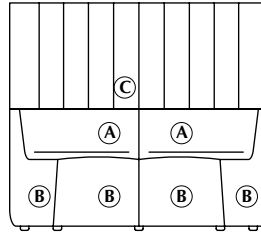

DARRAN is pleased to offer customers the design freedom of combination fabrics. When using fabric, vinyl or leather combinations, pricing/yardage requirements will be as follows:

- A** Inside Back & Seat 2 yds
- B** Lounge Exterior 7 yds
- C** Privacy Screen 5 yds

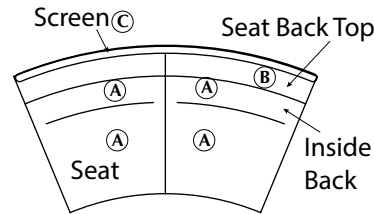

- When combining two materials of the same grade, pricing will be specified grade + 5%
- If combining two materials of different grades or leather/fabric combination, use the highest grade/price + 5%
- If using COM or COL, pricing will be COM or COL + 5%.
- If both COM + COL are used in combination, use COL + 5%.

#### Node Power Placement Option

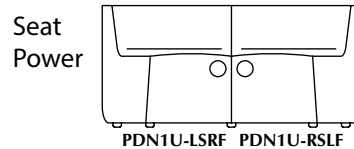
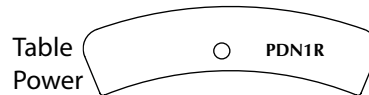

### Options.

#### GANGING DEVICE

- GDEV-L: Left Facing Ganging Device - \$20
- GDEV-R: Right Facing Ganging Device - \$20
- GDEV-C: Center Ganging Device - \$40

#### POWER

- PDN1U-LSRF: Node in Left Seat Right Facing Seat Front; 1 Power/1 USB Charger - \$325
- PDN1U-RSLF: Node in Right Seat Left Facing Seat Front; 1 Power/1 USB Charger - \$325
- PDN1U-BC: Node in Both Left and Right Facing Center Seat Front; 1 Power/1 USB Charger per pod - \$650
- PDN1R- Node in Rear Mount Table Top; 1 Power/1 USB Charger - \$375
- Standard in White (Available in Silver and Black)

#### 1/2" COMPACT MATTE LAMINATE REAR TABLE

- Matte Laminate RTD60: Rear Work Table - \$1,260, Specify LAW Alaska or LNB Nero Finish
- Rear table available on units that gang providing stability
- Rear table is mounted at 28.5"

#### 1/2" COMPACT MATTE LAMINATE TABLET

- FFD: 1/2" Compact Matte Laminate Tablet - \$570, Specify LAW Alaska or LNB Nero Finish
- Tablet is center mount only

#### PREMIUM FINISH OPTION (STANDARD WHITE)

- Specify rear table bracket metal finish color - \$100 per unit
- Specify tablet metal finish color - \$100 per unit
- MFS: Silver, MFB: Black

bota.

45 Deg. Circllet - Double Seat High Back  
45 Degree Back Inside Radius - High Back

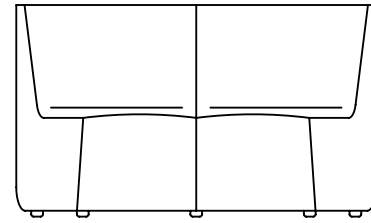

*View statement of line*

### Product features.

- Horizontal back provides easy ganging capabilities.
- Utilizes elastic webbing suspension that conforms to individual's lumbar curvatures for adaptive support.
- All units are standard with 1" adjustable glides that allow for leveling

1 model	COM	COL	1	2	3	4	5	6	7	8	9	10	11/L1	12	13/L2
BOT0160HCS45	3015	3213	3256	3375	3494	3613	3732	3851	3970	4089	4208	4327	4446	4565	4803
W x D x H			Upholstery Requirements												
60.25 x 28.5 x 35.5			Fabric yds: 6.5 Leather Sq. Ft.: 117												
Arm Height: -			Carton Weight: 89												
Seat Height: 17.5															
Inside Seat Depth: 17															
Inside Seat Width: 29.5															

2 Select a finish  
*View finish details*

3 Combination Fabrics  
*View finish details*

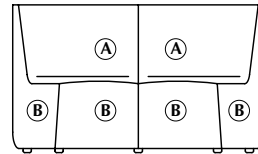

**DARRAN is pleased to offer customers the design freedom of combination fabrics. When using fabric, vinyl or leather combinations, pricing/yardage requirements will be as follows:**

**A Inside Back & Seat 3 yds**  
**B Lounge Exterior 7 yds**

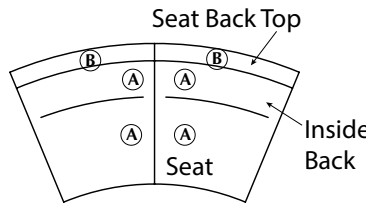

- When combining two materials of the same grade, pricing will be specified grade + 5%
- If combining two materials of different grades or leather/fabric combination, use the highest grade/price + 5%
- If using COM or COL, pricing will be COM or COL + 5%.
- If both COM + COL are used in combination, use COL + 5%.

### Node Power Placement Option

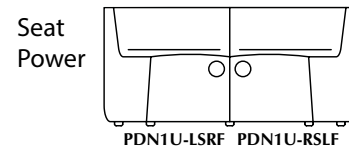
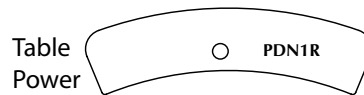

### Options.

#### GANGING DEVICE

- GDEV-L: Left Facing Ganging Device - \$20
- GDEV-R: Right Facing Ganging Device - \$20
- GDEV-C: Center Ganging Device - \$40

#### POWER

- PDN1U-LSRF: Node in Left Seat Right Facing Seat Front; 1 Power/1 USB Charger - \$325
- PDN1U-RSLF: Node in Right Seat Left Facing Seat Front; 1 Power/1 USB Charger - \$325
- PDN1U-BC: Node in Both Left and Right Facing Center Seat Front; 1 Power/1 USB Charger per pod - \$650
- PDN1R- Node in Rear Mount Table Top; 1 Power/1 USB Charger - \$375
- Standard in White (Available in Silver and Black)

#### 1/2" COMPACT MATTE LAMINATE REAR TABLE

- Matte Laminate RTD60: Rear Work Table - \$1,260, Specify LAW Alaska or LNB Nero Finish
- Rear table available on units that gang providing stability
- Rear table is mounted at 35.5"

#### 1/2" COMPACT MATTE LAMINATE TABLET

- FFD: 1/2" Compact Matte Laminate Tablet - \$570, Specify LAW Alaska or LNB Nero Finish
- Tablet is center mount only

#### PREMIUM FINISH OPTION (STANDARD WHITE)

- Specify rear table bracket metal finish color - \$100 per unit
- Specify tablet metal finish color - \$100 per unit
- MFS: Silver, MFB: Black



bota.

45 Deg. Circler - Double Seat High Back With Privacy Screen  
 45 Degree Back Inside Radius - High Back - 10.5" Privacy Screen

1 model	COM	COL	1	2	3	4	5	6	7	8	9	10	11/L1	12	13/L2
BOT0160HCL45	3940	4183	4181	4300	4419	4538	4657	4776	4895	5014	5133	5252	5371	5490	5728
W x D x H			Upholstery Requirements												
60.25 x 28.5 x 46			Fabric yds: 6.5 Leather Sq. Ft.: 117												
Arm Height: -			Carton Weight: 109												
Seat Height: 17.5															
Inside Seat Depth: 17															
Inside Seat Width: 29.5															

2 Select a finish  
[View finish details](#)

3 Combination Fabrics  
[View finish details](#)

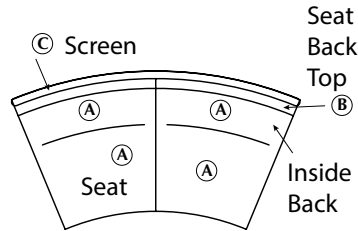
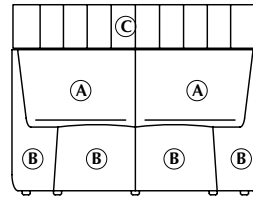

Node Power Placement Option

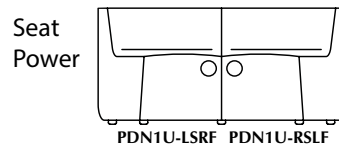

DARRAN is pleased to offer customers the design freedom of combination fabrics. When using fabric, vinyl or leather combinations, pricing/yardage requirements will be as follows:

- A Inside Back & Seat 3 yds
- B Lounge Exterior 7 yds
- C Privacy Screen 2.5 yds

- When combining two materials of the same grade, pricing will be specified grade + 5%
- If combining two materials of different grades or leather/fabric combination, use the highest grade/price + 5%
- If using COM or COL, pricing will be COM or COL + 5%.
- If both COM + COL are used in combination, use COL + 5%.

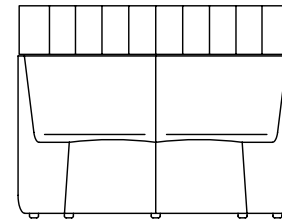

[View statement of line](#)

Product features.

- Horizontal back provides easy ganging capabilities.
- Utilizes elastic webbing suspension that conforms to individual's lumbar curvatures for adaptive support.
- Upholstered Privacy Screen
- Upholstered screens can be specified in contrasting fabrics, vinyl, or leathers.
- All units are standard with 1" adjustable glides that allow for leveling

Options.

GANGING DEVICE

- GDEV-L: Left Facing Ganging Device - \$20
- GDEV-R: Right Facing Ganging Device - \$20
- GDEV-C: Center Ganging Device - \$40

POWER

- PDN1U-LSRF: Node in Left Seat Right Facing Seat Front; 1 Power/1 USB Charger - \$325
- PDN1U-RSLF: Node in Right Seat Left Facing Seat Front; 1 Power/1 USB Charger - \$325
- PDN1U-BC: Node in Both Left and Right Facing Center Seat Front; 1 Power/1 USB Charger per pod - \$650
- PDN1R- Node in Rear Mount Table Top; 1 Power/1 USB Charger - \$375
- Standard in White (Available in Silver and Black)

1/2" COMPACT MATTE LAMINATE REAR TABLE

- Matte Laminate RTD60: Rear Work Table - \$1,260, Specify LAW Alaska or LNB Nero Finish
- Rear table available on units that gang providing stability
- Rear table is mounted at 35.5"

1/2" COMPACT MATTE LAMINATE TABLET

- FFD: 1/2" Compact Matte Laminate Tablet - \$570, Specify LAW Alaska or LNB Nero Finish
- Tablet is center mount only

PREMIUM FINISH OPTION (STANDARD WHITE)

- Specify rear table bracket metal finish color - \$100 per unit
- Specify tablet metal finish color - \$100 per unit
- MFS: Silver, MFB: Black

bota.

45 Deg. Circlet - Double Seat High Back With Privacy Screen  
 45 Degree Back Inside Radius - High Back - 17.5" Privacy Screen

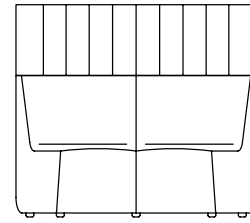

*View statement of line*

### Product features.

- Horizontal back provides easy ganging capabilities.
- Utilizes elastic webbing suspension that conforms to individual's lumbar curvatures for adaptive support.
- Upholstered Privacy Screen
- Upholstered screens can be specified in contrasting fabrics, vinyl, or leathers.
- All units are standard with 1" adjustable glides that allow for leveling

1 model	COM	COL	1	2	3	4	5	6	7	8	9	10	11/L1	12	13/L2
BOT0160HCH45	4230	4503	4545	4700	4855	5010	5165	5320	5475	5630	5785	5940	6095	6250	6560
W x D x H			Upholstery Requirements												
60.25 x 28.5 x 53			Fabric yds: 8.5 Leather Sq. Ft.: 153												
Arm Height: -			Carton Weight: 119												
Seat Height: 17.5															
Inside Seat Depth: 17															
Inside Seat Width: 29.5															

2 Select a finish  
*View finish details*

3 Combination Fabrics  
*View finish details*

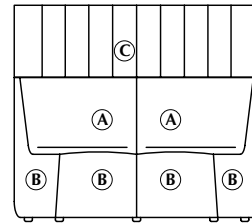

DARRAN is pleased to offer customers the design freedom of combination fabrics. When using fabric, vinyl or leather combinations, pricing/yardage requirements will be as follows:

- A** Inside Back & Seat 3 yds
- B** Lounge Exterior 7 yds
- C** Privacy Screen 5 yds

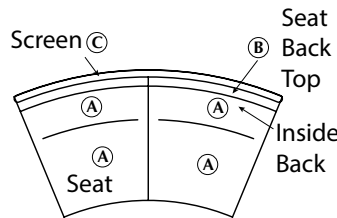

- When combining two materials of the same grade, pricing will be specified grade + 5%
- If combining two materials of different grades or leather/fabric combination, use the highest grade/price + 5%
- If using COM or COL, pricing will be COM or COL + 5%.
- If both COM + COL are used in combination, use COL + 5%.

### Node Power Placement Option

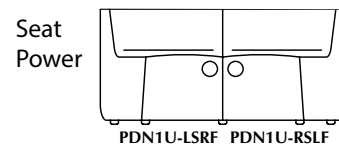
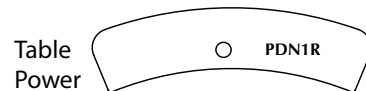

### Options.

#### GANGING DEVICE

- GDEV-L: Left Facing Ganging Device - \$20
- GDEV-R: Right Facing Ganging Device - \$20
- GDEV-C: Center Ganging Device - \$40

#### POWER

- PDN1U-LSRF: Node in Left Seat Right Facing Seat Front; 1 Power/1 USB Charger - \$325
- PDN1U-RSLF: Node in Right Seat Left Facing Seat Front; 1 Power/1 USB Charger - \$325
- PDN1U-BC: Node in Both Left and Right Facing Center Seat Front; 1 Power/1 USB Charger per pod - \$650
- PDN1R- Node in Rear Mount Table Top; 1 Power/1 USB Charger - \$375
- Standard in White (Available in Silver and Black)

#### 1/2" COMPACT MATTE LAMINATE REAR TABLE

- Matte Laminate RTD60: Rear Work Table - \$1,260, Specify LAW Alaska or LNB Nero Finish
- Rear table available on units that gang providing stability
- Rear table is mounted at 35.5"

#### 1/2" COMPACT MATTE LAMINATE TABLET

- FFTD: 1/2" Compact Matte Laminate Tablet - \$570, Specify LAW Alaska or LNB Nero Finish
- Tablet is center mount only

#### PREMIUM FINISH OPTION (STANDARD WHITE)

- Specify rear table bracket metal finish color - \$100 per unit
- Specify tablet metal finish color - \$100 per unit
- MFS: Silver, MFB: Black

bota.

Ottoman  
19" Ottoman



1 model	COM	COL	1	2	3	4	5	6	7	8	9	10	11/L1	12	13/L2
BOT0160SSO01	704	739	778	814	850	886	922	958	994	1030	1066	1102	1138	1174	1246
W x D x H 19 x 19 x 17.5			Upholstery Requirements												
Arm Height: -			Fabric yds: 2 Leather Sq. Ft.: 36												
Seat Height: 17.5			Carton Weight: 23												
Inside Seat Depth: 19															
Inside Seat Width: 19															

2 Select a finish  
[View finish details](#)

3 Combination Fabrics  
[View finish details](#)

DARRAN is pleased to offer customers the design freedom of combination fabrics. When using fabric, vinyl or leather combinations, pricing/yardage requirements will be as follows:

- A Seat 1 yd
- B Base 2 yds

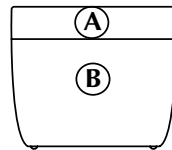

- When combining two materials of the same grade, pricing will be specified grade + 5%
- If combining two materials of different grades or leather/fabric combination, use the highest grade/price + 5%
- If using COM or COL, pricing will be COM or COL + 5%.
- If both COM + COL are used in combination, use COL + 5%.

[View statement of line](#)

### Product features.

- Utilizes elastic webbing suspension that conforms to individual's lumbar curvatures for adaptive support.
- Ottomans are standard with 1/4" nylon glides

### Options.

#### COMPRESSION CASTER

- Caster compresses when weight is applied to ottoman.
- CST30: Caster - \$195

bota.

Ottoman  
48" Ottoman

1 model	COM	COL	1	2	3	4	5	6	7	8	9	10	11/L1	12	13/L2
BOT0160MSO04	1953	2035	2101	2174	2247	2320	2393	2466	2539	2612	2685	2758	2831	2904	3050
W x D x H 47.5 x 47.5 x 17.5 Arm Height: n/a Seat Height: 17.5" Inside Seat Depth: 47.5" Inside Seat Width: 47.5"			Upholstery Requirements Fabric yds: 4 Leather Sq. Ft.: 72 Carton Weight: 75												

2 Select a finish  
[View finish details](#)

3 Combination Fabrics  
[View finish details](#)

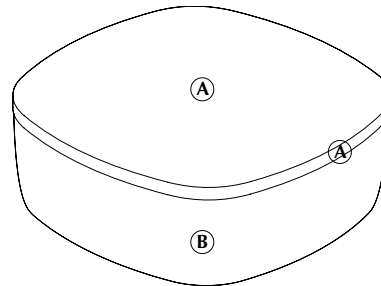

DARRAN is pleased to offer customers the design freedom of combination fabrics. When using fabric, vinyl or leather combinations, pricing/yardage requirements will be as follows:

A Seat 2.75 yds  
B Base 2.25 yds

Node Power Placement Option

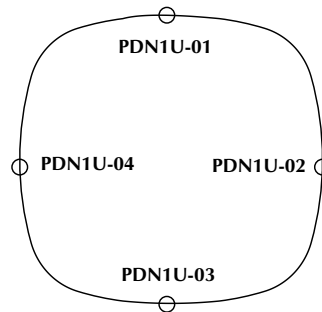

Top View

- When combining two materials of the same grade, pricing will be specified grade + 5%
- If combining two materials of different grades or leather/fabric combination, use the highest grade/price + 5%
- If using COM or COL, pricing will be COM or COL + 5%.
- If both COM + COL are used in combination, use COL + 5%.

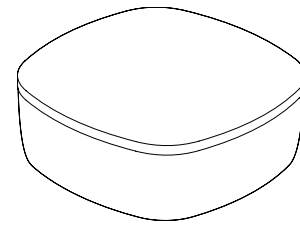

[View statement of line](#)

Product features.

- 360 Degree sitting surface for wide range of uses
- Ottomans are standard with 1" adjustable glides

Options.

OTTOMAN POWER

- PDN1U-01: Node in top face; 1 power/1 USB charger - \$325
- PDN1U-02: Node in right face; 1 power/1 USB charger - \$325
- PDN1U-03: Node in bottom face; 1 power/1 USB charger - \$325
- PDN1U-04: Node in left face; 1 power/1 USB charger - \$325

bota.

Ottoman  
70" Ottoman

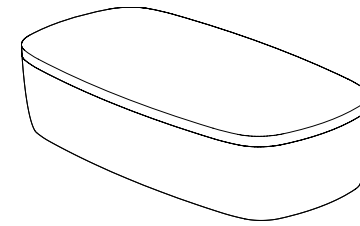

[View statement of line](#)

### Product features.

- 360 Degree sitting surface for wide range of uses
- Ottomans are standard with 1" adjustable glides

1 model	COM	COL	1	2	3	4	5	6	7	8	9	10	11/L1	12	13/L2
BOT0160MSO07	2747	2843	2923	3010	3097	3184	3271	3358	3445	3532	3619	3706	3793	3880	4054
W x D x H			Upholstery Requirements												
71 x 35.5 x 17.5			Fabric yds: 4.75 Leather Sq. Ft.: 85.5												
Arm Height: n/a			Carton Weight: 100												
Seat Height: 17.5"															
Inside Seat Depth: 35.5"															
Inside Seat Width: 71"															

2 Select a finish  
[View finish details](#)

3 Combination Fabrics  
[View finish details](#)

DARRAN is pleased to offer customers the design freedom of combination fabrics. When using fabric, vinyl or leather combinations, pricing/yardage requirements will be as follows:

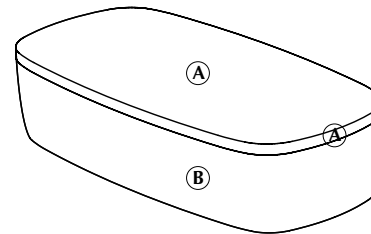

A Seat 2.75 yds  
B Base 2.5 yds

### Node Power Placement Option

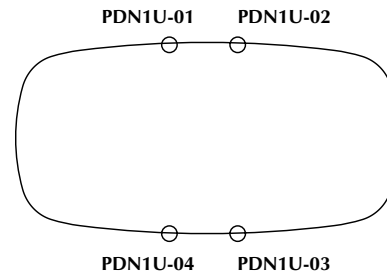

Top View

- When combining two materials of the same grade, pricing will be specified grade + 5%
- If combining two materials of different grades or leather/fabric combination, use the highest grade/price + 5%
- If using COM or COL, pricing will be COM or COL + 5%.
- If both COM + COL are used in combination, use COL + 5%.

### Options.

#### OTTOMAN POWER

- PDN1U-01: Node in top face; 1 power/1 USB charger - \$325
- PDN1U-02: Node in right face; 1 power/1 USB charger - \$325
- PDN1U-03: Node in bottom face; 1 power/1 USB charger - \$325
- PDN1U-04: Node in left face; 1 power/1 USB charger - \$325

bota.

Booth  
4 Person Meeting Booth

1 model	COM	COL	1	2	3	4	5	6	7	8	9	10	11/L1	12	13/L2
BOT0160BNT04	11503	12443	12428	12884	13340	13796	14252	14708	15164	15620	16076	16532	16988	17444	18356
W x D x H			Upholstery Requirements												
95 x 63 x 53			Fabric yds: 25 Leather Sq. Ft.: 450												
Arm Height: n/a			Carton Weight: 300												
Seat Height: 17.5"															
Inside Seat Depth: 17"															
Inside Seat Width: 29.5"															

2 Select a finish  
[View finish details](#)

3 Combination Fabrics  
[View finish details](#)

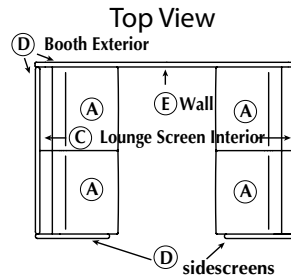
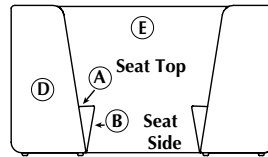

Node Power Placement Option

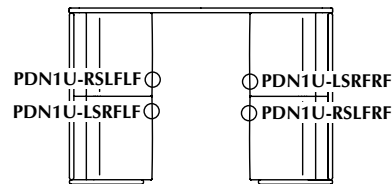

DARRAN is pleased to offer customers the design freedom of combination fabrics. When using fabric, vinyl or leather combinations, pricing/yardage requirements will be as follows:

- A Inside Back & Seat 5 yds
- B Seat Side 3 yds
- C Lounge Screen Interior 4 yds
- D Booth Side Walls and Exterior 10 yds
- E Booth Interior Wall 4 yds.

- When combining two materials of the same grade, pricing will be specified grade + 5%
- If combining two materials of different grades or leather/fabric combination, use the highest grade/price + 5%
- If using COM or COL, pricing will be COM or COL + 5%.
- If both COM + COL are used in combination, use COL + 5%.

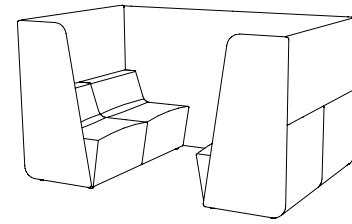

[View statement of line](#)

Product features.

- Utilizes elastic webbing suspension that conforms to individual's lumbar curvatures for adaptive support
- Horizontal back provides easy ganging capabilities
- Upholstered screens can be specified in contrasting fabrics, vinyl or leather
- The upholstered wall is structured so that a TV up to 32" can be mounted on the inside or outside back wall of the booth
- Wire management channels are built into the wall to conceal cords
- All units are standard with 1" adjustable glides that allow for leveling

NOTES

- Please consult customer service when specifying a table other than Bota to ensure adequacy of seat access

Options.

BOARDS

- MBOC3421: 34" x 21" Marker board - \$440 ea.
- GBOC3421: 34" x 21" Glassboard - \$1098 ea.
- Specify location: interior, exterior, or both

SEAT POWER

- PDN1U-RSLFLF: Node in right facing seat front, left facing seat - \$325
- PDN1U-LSRFLF: Node in left facing seat front, left facing seat - \$325
- PDN1U-LSRFRF: Node in left facing seat front, right facing seat - \$325
- PDN1U-RSLFRF: Node in right facing seat front, right facing seat - \$325

TV MOUNT

- TM-1732: Fixed TV mount supports 17" - 32" TV - \$225
- Specify interior or exterior fixed TV mount location (2) black or white grommets included for TV wire entry and exit

bota.

Booth  
6 Person Meeting Booth

1 model	COM	COL	1	2	3	4	5	6	7	8	9	10	11/L1	12	13/L2
BOTO160BNT06	14878	15848	16062	16646	17230	17814	18398	18982	19566	20150	20734	21318	21902	22486	23654
W x D x H			Upholstery Requirements												
95 x 91 x 53			Fabric yds: 32 Leather Sq. Ft.: 576												
Arm Height: n/a			Carton Weight: 450												
Seat Height: 17.5"															
Inside Seat Depth: 17"															
Inside Seat Width: 29.5"															

2 Select a finish  
[View finish details](#)

3 Combination Fabrics  
[View finish details](#)

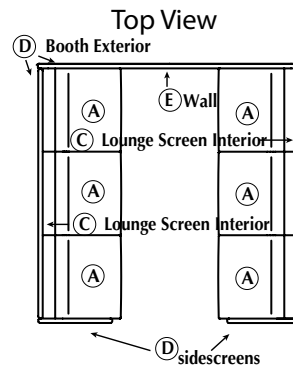
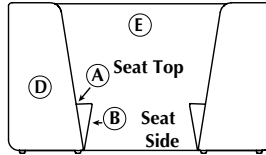

Node Power Placement Option

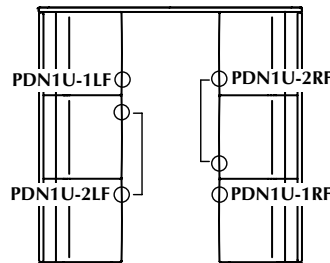

DARRAN is pleased to offer customers the design freedom of combination fabrics. When using fabric, vinyl or leather combinations, pricing/yardage requirements will be as follows:

- A Inside Back & Seat 7 yd(s).
- B Seat Side 4 yd(s).
- C Lounge Screen Interior 5.5 yd(s).
- D Booth Side Walls and Exterior 12 yd(s).
- E Booth Interior Wall 4 yds.

- When combining two materials of the same grade, pricing will be specified grade + 5%
- If combining two materials of different grades or leather/fabric combination, use the highest grade/price + 5%
- If using COM or COL, pricing will be COM or COL + 5%.
- If both COM + COL are used in combination, use COL + 5%.

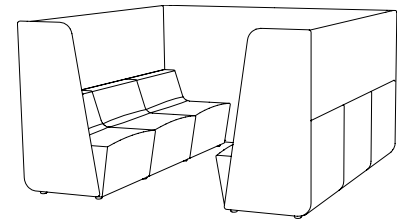

[View statement of line](#)

Product features.

- Utilizes elastic webbing suspension that conforms to individual's lumbar curvatures for adaptive support
- Horizontal back provides easy ganging capabilities
- Upholstered screens can be specified in contrasting fabrics, vinyl or leather
- The upholstered wall is structured so that a TV up to 32" can be mounted on the inside or outside back wall of the booth
- Wire management channels are built into the wall to conceal cords
- All units are standard with 1" adjustable glides that allow for leveling

NOTES

- Please consult customer service when specifying a table other than Bota to ensure adequacy of seat access

Options.

BOARDS

- MBOC3421: 34" x 21" Marker board - \$440 ea.
- GBOC3421: 34" x 21" Glassboard - \$1145 ea.
- Specify location: interior, exterior, or both

SEAT POWER

- PDN1U-1LF: Node is right facing seat front, left facing seat - \$325
- PDN1U-2LF: Node in left and center facing seat front, left facing seat - \$650
- PDN1U-1RF: Node in right facing seat front, right facing seat - \$325
- PDN1U-2RF: Node in left and center facing seat front, right facing seat - \$650

TV MOUNT



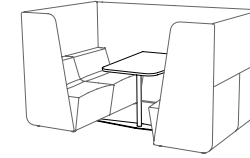

- TM-1732: Fixed TV mount supports 17"- 32" TV - \$225
- Specify interior or exterior fixed TV mount location (2) black or white grommets included for TV wire entry and exit

# Bota.

Booth Table  
4 Person Meeting Booth Table



[View statement of line](#)

1 Select a model w" x d" x h"	weight	Standard Veneer Top White Metal Base		Premium Veneer Top White Metal Base		High Pressure Laminate Top White Metal Base		Thermally Fused Laminate Top White Metal Base	
35 x 48 x 29	70	BOT4835MT500W	1711	BOT4835MT500P	1883	BOT4835MT500G	1711	BOT4835MT500M	1276
2 Select a finish <a href="#">View finish details</a>									
Metal finish MFW White. Additional metal finishes are available, see options.									
		WLA		WBO		GEC		MEC	
		WEC		WMO		GAM		MGW	
		WAM		WSO		GCM		MTW	
		WCM		TSTV		GWM		MSW	
		WWM		TSMV		GSTV		MWL	
		WGW		TSLV		GSLV			
		WBW				GNNW			
		WSW				GWL			
		WNW							
		WWP							
3 Select a edge <a href="#">View edge details</a>									
									
		Flat		Flat		Flat		Flat	
4 Select hardware <a href="#">View hardware details</a>									
		Hardware N/A		Hardware N/A		Hardware N/A		Hardware N/A	

## Product features.

- Table legs come standard in white (optional black or silver)

## Options.

### WORKSURFACE CLAMP MOUNT POWER

- PD-KENO-B: Keno power pod with clamp (includes 2 wire management grommets) - \$285 ea.
- Specify color and interior or exterior wire exit
- PD-TULLY-B: Tully power pod with clamp (includes 2 wire management grommets) - \$410 ea.
- Specify color and interior or exterior wire exit
- PD-TULLY-DATA: Tully data power pod with clamp (includes 2 wire management grommets) - \$400 ea.
- Specify color and interior or exterior wire exit

### PREMIUM FINISH OPTION

- Specify base metal finish color - \$160 per base
- MFS: Silver, MFB: Black





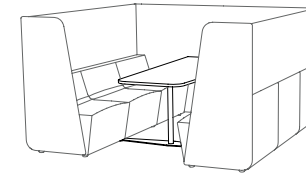

# Bota.

Booth Table  
6 Person Meeting Booth Table



[View statement of line](#)

1 Select a model w" x d" x h"	weight	Standard Veneer Top White Metal Base		Premium Veneer Top White Metal Base		High Pressure Laminate Top White Metal Base		Thermally Fused Laminate Top White Metal Base	
		35 x 78 x 29	95	BOT7835MT500W	2397	BOT7835MT500P	2637	BOT7835MT500G	2397
2 Select a finish <a href="#">View finish details</a>  Metal finish MFW White. Additional metal finishes are available, see options.	WLA WEC WAM WCM WWM WGW WBW WSW WNW WWP			WBO WMO WSO TSTV TSMV TSLV		GEC GAM GCM GWM GSTV GSLV GNW GWL		MEC MGW MTW MSW MWL	
3 Select a edge <a href="#">View edge details</a>	 Flat			 Flat		 Flat		 Flat	
4 Select hardware <a href="#">View hardware details</a>	Hardware N/A			Hardware N/A		Hardware N/A		Hardware N/A	

## Product features.

- Table legs come standard in white (optional black or silver)

## Options.

### WORKSURFACE CLAMP MOUNT POWER

- PD-KENO-B: Keno power pod with clamp (includes 2 wire management grommets) - \$285 ea.
- Specify color and interior or exterior wire exit
- PD-TULLY-B: Tully power pod with clamp (includes 2 wire management grommets) - \$410 ea.
- Specify color and interior or exterior wire exit
- PD-TULLY-DATA: Tully data power pod with clamp (includes 2 wire management grommets) - \$400 ea.
- Specify color and interior or exterior wire exit

### PREMIUM FINISH OPTION

- Specify base metal finish color - \$160 per base
- MFS: Silver, MFB: Black

# Bota.

Freestanding Table  
Freestanding Table



1 Select a model		Standard Veneer Top Black Metal Base		1/2" Compact Laminate Top Black Metal Base		View statement of line	
w" x d" x h"	weight						
12.5 x 13.75 x 24.5	15	BOT0160FST01W	698	BOT0160FST01M	675		
2 Select a finish		WLA	WBO	LAW			
<i>View finish details</i>		WEC	WMO	LNB			
Metal finish		WAM	WSO				
MFB Black. Additional metal finishes are available, see options.		WCM	TSTV				
		WWM	TSMV				
		WGW	TSLV				
		WBW					
		WSW					
		WNW					
		WWP					
3 Select a edge		Edge		Edge			
<i>View edge details</i>		N/A		N/A			
4 Select hardware		Hardware		Hardware			
<i>View hardware details</i>		N/A		N/A			

## Product features.

- Standard Black Base (optional White, Silver)

## Options.

### PREMIUM FINISH OPTION

- Specify base metal finish color - \$160 per base
- MFW: White, MFS: Silver

Bota.

Coat Stand  
Wire Coat Stand



1	Select a model	Black Metal Coat Stand
	w" x d" x h"	
	20.25 x 18.5 x 67	25 BOT0160WCS01 944

[View statement of line](#)

Product features.  
- Standard Black Finish

2	Select a finish	MFB
	<a href="#">View finish details</a>	
	Metal finish	
	MFB Black	

3	Select a edge	Edge
	<a href="#">View edge details</a>	N/A

4	Select hardware	Hardware
	<a href="#">View hardware details</a>	N/A

## power & data options.

### Keno power unit

#### Style Number



PD-KENO-B

Select power block to link workstations

#### List Price

\$285

## Specifications

- › Size 5.5" L x 2.125" W x 2.5" H
- › 2 TR AC Outlets
- › 1 4.2A USB module w/ 2 charging ports
- › 10' Power cord
- › Includes 2 wire management grommets

Available: Bota booth table

#### Telecom Plates

With 120" hardwire power cord.

Two Pack Power Block System: 2PPBS \$390

Four Pack Power Block System: 4PPBS \$750

Six Pack Power Block System: 6PPBS \$1100



White



Black

## power & data options.

### Node power unit

Style Number List Price



STARTER UNITS

PDN1U PLUG

\$325

Includes (1) node unit with plug infeed - includes 72" cord

\*See pod placement options below



## Specifications

- › Size: 4" Dia
- › (1) 15 Amp Receptacles and (1) USB duplex
- › Surface Mount
- › Standard White Finish, Available in Black or Silver Finish upon request
- › UL Approved

Available: Bota

## node power placement

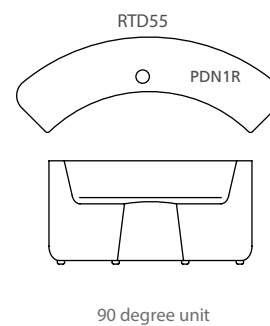
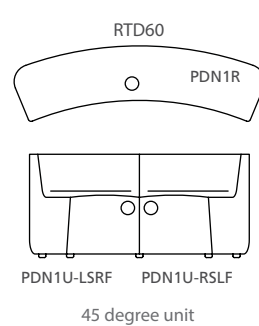
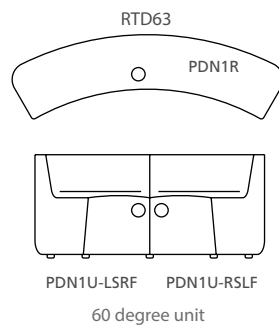
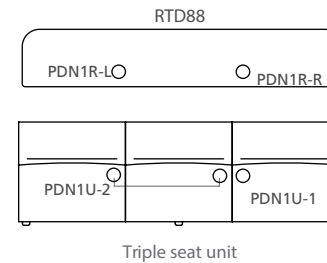
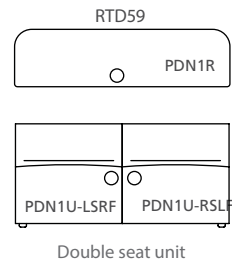
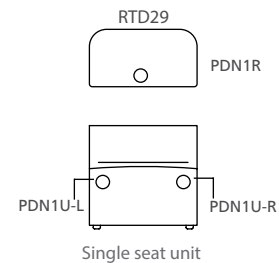

## power & data options.

Tully power unit

Style Number	List Price
PD-TULLY-B	\$410

Select power block to link workstations

### Specifications

- > 5.5" W x 3.2" H x 1.81" D
- > Finish: Smooth molded plastic integrated within a single piece cover
- > Mounts to the edge of your work surface, with no table cut outs or installation required.
- > (2) Power receptacles, (2) USB 2.1 Amp ports
- > 72" Cord (10' cord available, contact customer service).
- > Standard in White. Available in gray, black, neon red, harvest pumpkin, light green, daisy blue.
- > UL310, Class 2, FCC Part 15A approved
- > Clamp accessory accommodates table thickness from .75"-1.5"
- > Includes 2 wire management grommets

Available: Bota booth table

#### Power Block

With 120" hardwire power cord.

Two Pack Power Block System 2PPBS	\$390
Four Pack Power Block System 4PPBS	\$750
Six Pack Power Block System 6PPBS	\$1100

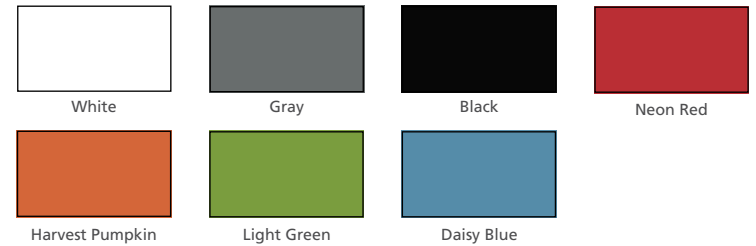

# Capitol park price list



## Capitol park table of contents

Statement of Line	
Features & Advantages .....	1
Finishes   Specifications .....	3
Edges   Pulls   Knobs.....	4
Grommets   Grommet Reference.....	5
Ganging   Height Reference .....	6
Modesty Reference   Doors   Grain Direction.....	7
Drawer Dimensions   Filing Reference.....	8
Double Pedestal Desk.....	9
Single Pedestal Desk .....	11
Conference Desk .....	13
Returns.....	14
Bridges .....	17
Freestanding Credenzas .....	18
Lateral File.....	22
Workstation Credenzas.....	23
Single Height Freestanding Overheads .....	26
Overhead Accessories .....	28
Single Height Wall Hung Overheads.....	32
Wall Hung Accessories .....	33
Overhead Half Towers.....	38
Overhead Bookcases.....	40
Vertical Half Towers.....	42
Vertical Full Towers.....	43
Bookcases.....	45
Options.....	47
Power & Data .....	61



# Capitol park statement of line

PAGE 9  
Double Pedestal Desks

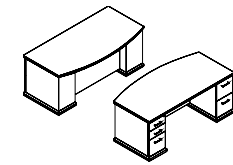

PAGE 10  
Double Pedestal Desks

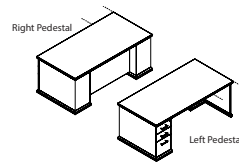

PAGE 11  
Workstation Desks

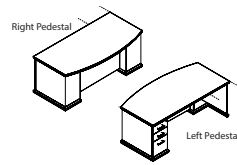

PAGE 12  
Workstation Desks

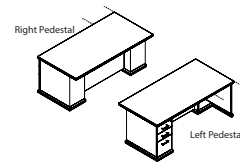

PAGE 13  
Workstation Desks

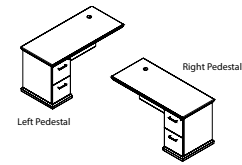

PAGE 14  
"L" Workstation Returns

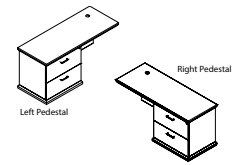

PAGE 15  
"L" Workstation Returns

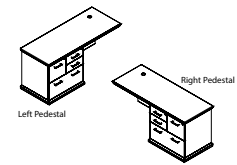

PAGE 16  
"L" Workstation Returns

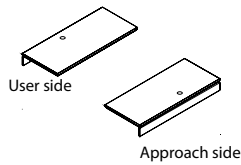

PAGE 17  
Workstation Bridges

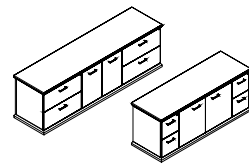

PAGE 18  
Credenzas

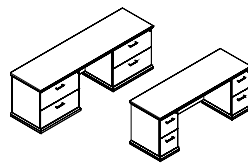

PAGE 19  
Credenzas

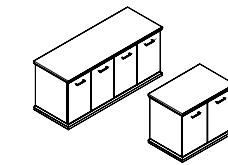

PAGE 20  
Credenzas

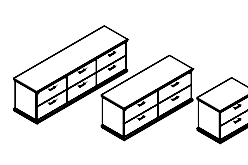

PAGE 21  
Lateral File Credenzas

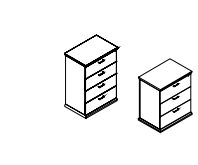

PAGE 22  
Lateral File

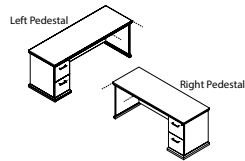

PAGE 23  
Workstation Credenzas

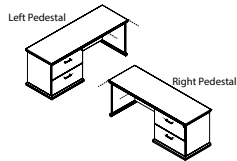

PAGE 24  
Workstation Credenzas

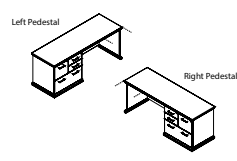

PAGE 25  
Workstation Credenzas

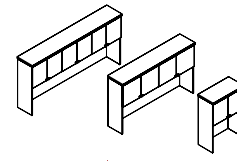

PAGE 26  
Single Storage Overhead Console

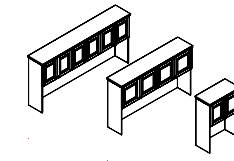

PAGE 27  
Single Storage Overhead Console

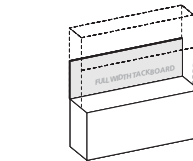

PAGE 28  
Overhead Tackboards

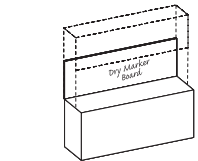

PAGE 29  
Overhead Dry Marker Boards

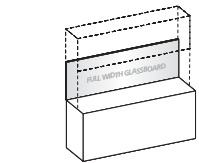

PAGE 30  
Ovehead Glassboards

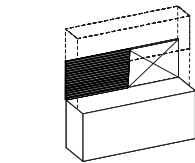

PAGE 31  
Overhead Slat Wall

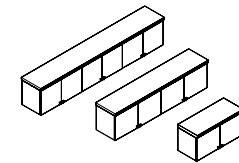

PAGE 32  
Single Height Wall Hung Overheads

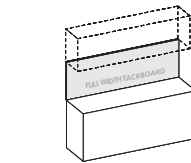

PAGE 33  
Wall Hung Tackboards

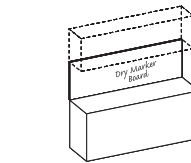

PAGE 34  
Wall Hung Dry Marker Boards

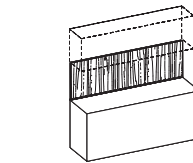

PAGE 35  
Wall Hung Veneer Panels

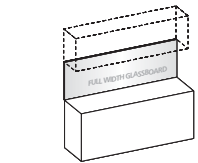

PAGE 36  
Wall Hung Glassboards

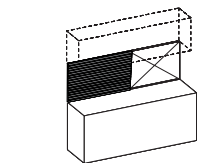

PAGE 37  
Wall Hung Slat Wall

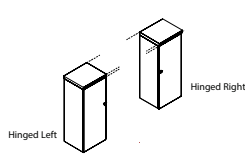

PAGE 38  
Sit-On Tower Extension

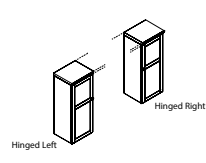

PAGE 39  
Sit-On Tower Extension

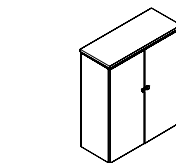

PAGE 40  
Sit-On Bookcase Console

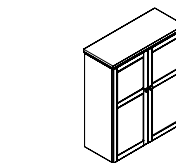

PAGE 41  
Sit-On Bookcase Console

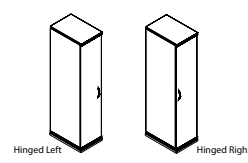

PAGE 42  
Half Towers

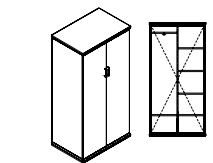

PAGE 43  
Full Towers

# Capitol park statement of line

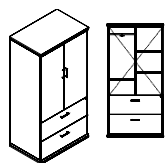

PAGE 44  
Full Towers

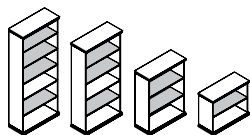

PAGE 45  
Freestanding Bookcases

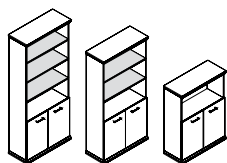

PAGE 46  
Freestanding Bookcases

## Capitol park features & advantages

### Veneer

DARRAN only uses HPVA AA Grade Flat Cut Cherry and Walnut Veneers. All veneers are selected and matched for balance and consistency.

### Veneer tops

Capitol park veneer tops feature a 45-pound density substrate with balanced 3-ply construction. Tops are 1-5/16" thick on MDF core comprised of 100% recycled and recovered wood fibers. All veneer tops are slipmatched and feature a 3mm external solid hardwood band or profile edge.

### Laminate tops

Capitol park high-pressure laminate tops feature a 45-pound density substrate with balanced 3-ply construction. Tops are 1-5/16" thick on MDF core comprised of 100% recycled and recovered wood fibers. All high pressure laminate tops are available with a profile edge, laminate self-edge or 2mm PVC edge band. Laminates in wood grain patterns feature a fine grain texture that features the polish and luxe of a real wood veneer with a subtle narrow grain structure.

### Cleaning wood & laminate

In addition to regular dusting, give your furniture an occasional cleaning in accordance with our cleaning instructions. DARRAN wood and laminate products can be cleaned with a soft cloth and a mild soap and water mixture. Use approximately 32 oz of water mixed with one tablespoon of dish soap, always wiping with the grain. Dry with a soft cloth, going with the grain, to avoid spotting or streaking.

Wood products should be waxed periodically using a non-wax liquid; please do not use any waxy polish or cleaner. Interior of drawers may also be cleaned with mild soap and water mixture, or any household cleaner that is not petroleum or thinner-based.

### Chassis & pedestal

Chassis components are 3/4" thick core of particle board or MDF rated EPP/SCS/CARB-II material with 3-ply balanced construction. Pedestal and Cabinets feature dowel construction reinforced with steel bracket plates, wood cleats, screws and glue. All units are standard with 1" adjustable glides that allow for leveling of units that are secured in solid wood glide blocks to prevent tearout.

### Overhead cabinet construction Freestanding & wall mount

Freestanding Overhead storage cabinets are constructed of 1" and 3/4" thick core of particle board or MDF rated EPP/SCS/CARB-II material with 3-ply balanced construction. Panels are attached with cam fasteners in conjunction with dowels securely adhered with glue. All surface mount cabinets connect to work surface with anti-slip tape. Wall mount cabinets are mounted to the wall with steel "z" bracket attach-

ment method using 5mm euro screws to attach to the back of the cabinet. All units ship with a steel "z" bracket. This bracket is mounted to the wall by field installers. Installers are responsible for selecting and supplying appropriate fasteners for wall conditions.

### Bookcase Construction

All chassis (sides, back, top and bottom panels) are constructed with 3/4" thick core of particle board or MDF rated EPP/SCS/CARB-II material with 3-ply balanced construction. Panels are attached with cam-lock fasteners in conjunction with dowels securely adhered with glue. Shelves on all units are 3/4" thick balance 3 ply panels. Optional heavy duty shelves are 1" thick lumber core balanced 5 ply construction.

### Tackboards

Wall mount tackboards are constructed of .75" thick fiberboard. The fabric is precisely aligned and fitted to the tackboard with a sock on cover. Overhead storage tackboards are constructed of .75" thick fiberboard. The fabric is precisely aligned and fitted to the tackboard and adhered to the rigid hardboard with staples. Wall mount cabinets are mounted to the wall with steel "z" bracket attachment method using 5mm euro screws to attach to the back of the cabinet. All units ship with a steel "z" bracket. This bracket is mounted to the wall by field installers. Installers are responsible for selecting and supplying appropriate fasteners for wall conditions.

### Adjustable glides

Glides provide 1" of vertical leveling adjustment. Glide bottom is durable metal. Glides are secured in solid wood blocks that are screwed and glued for durability.

### Drawers

All drawers are constructed with mitre joint/dowel construction in a natural maple finish with four sides and a bottom, which are attached to a drawer front with screws for easy removal. Drawer fronts are vertically matched in balanced sets. Pencil trays are standard in all box drawers. Drawers are constructed of 1/2" thick wood grained wrapped 5 sided miter-folded construction with 1/4" thick hardboard bottoms reinforced for heavy weight capacity. Drawers have been tested and pass BIFMA 50,000 cycle test. All drawers are guaranteed lifetime with free replacement warranty.

### Drawer fronts

Drawer fronts are vertically matched in balanced sets. Doors feature vertical veneer bookmatched horizontally in sets of 2 / 4 and 6 doors. All tower fronts matched in vertical sets.

### Optional wood drawers

Optional hardwood veneer plywood drawers feature banded top and bottom edges for smoothness. Drawers are dowel joint construction with a UV cured finish over

## Capitol park features & advantages

maple veneers, plus a lifetime free replacement guarantee.  
Optional Wood Drawer (Any Size) – Option Code P33...\$40 List Price Per Drawer

### Suspensions

All casegoods utilize cold rolled steel zinc plated high-grade drawer suspensions. Box and File drawers are full extension, featuring steel ball bearings for a smoother quieter range of motion with soft close operation and are rated 100lbs. Lateral file drawers are a progressive action full extension suspension with the soft close operation and is rated at 150lbs. Lateral files include anti tip mechanism that will allow only one drawer at a time to be opened. All suspensions are soft close and are warranted for the lifetime of the product.

### Hinges

Units with doors include 95 degree swing hinges.

### Filing

Capitol park features a highly durable black plastic extrusion that is securely fastened into a route on top of the drawer to support hanging files. An adjustable crossbar is provided for all file drawers that enables legal/letter filing front to back or side-to-side based on the drawer size.

### Locks

Locks are Standard on all drawers below the worksurface. Random lock cores are installed at the factory. Some units may be shipped with the same key number. Locks are Silver, Black or Bronze and match pull finish unless otherwise specified.

DARRAN will also send lock cores separately to the dealer at your request. These units will be send with an empty lock core and the Dealer will receive a shipment of the requested lock core/keys.

### Keying

Keying is available either factory or field installed. Factory installed keying is random.

### Wire management

Wire management capabilities include standard and optional worksurface grommets. Specify W-1 under surface wire channels for organization and management of all communication wires and cords. Horizontal J-Channel wire management (Sku: W-1) is sold separately to conceal wire under worksurfaces.

### Grommets

Metal grommets are provided to match the drawer pull selection. Grommet is available in black, silver, white or antique brass. Must specify standard or non-

standard location. Black plastic grommets are available as an option for vertical applications.

### Powerports

A large selection of power pods are available and handle power, data, docking stations and communication. See options section for selection.

### LED tasklights

LED task lighting provides high efficiency, low energy lighting with a long life. Recessed light is encased in silver aluminum channel with milk lense and rounded end caps. Lights are factory installed. Product specifications listed below:

- Diffuser creates a softer light and eliminates hot spots
- Touch dimmer switch
- Can be "daisy chained" up to 90W
- 4.6 watts per foot
- 120 LEDs per meter
- Certification: UL Listed
- 50,000 hour life span.

Color Temp is 4000K

## Capitol park finishes | specifications

STANDARD VENEER	PREMIUM VENEER	HIGH PRESSURE LAMINATE	THERMALLY FUSED LAMINATE
WAC Amber Cherry .....	N/A .....	GAC Amber Cherry.....	N/A
WRC Caramel Cherry.....	N/A .....	N/A .....	N/A
WIC Crimson Cherry .....	N/A .....	GIC Crimson Cherry .....	N/A
WHC Honey Cherry .....	N/A .....	GHC Honey Cherry .....	N/A
WOC Koko Cherry.....	N/A .....	GOC Koko Cherry.....	N/A
WEW Executive Walnut.....	N/A .....	GEW Executive Walnut.....	N/A
WGW Gunstock Walnut.....	N/A .....	N/A .....	N/A
WBW Henna Walnut.....	N/A .....	N/A .....	N/A
WSW Smokey Walnut.....	N/A .....	N/A .....	N/A
WNW Natural Walnut .....	N/A .....	GNW Natural Walnut .....	N/A

HPL TOPS ON TFL PRODUCTS Add 10% - Available with flat edge only

Send 3x3 or larger finish chip for color match. Custom finish upcharge is 3% or \$250 Net (whichever is greater).

### Finish

ENVI-CT Green Certified European Technology Coatings  
Finish.

# Capitol park edges | pulls | knobs

## "W" & "G" Standard profile

Capitol Park Edge for "W" & "G" Styles  
 Hardwood Rim Band Species Same As  
 Surface Veneer

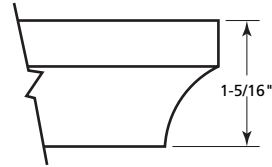

## Hookup edge profile

Coped Edge

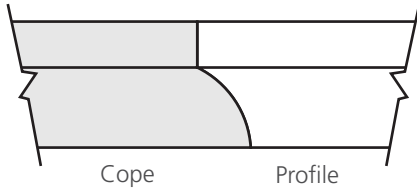

## "W" & "G" Base profile

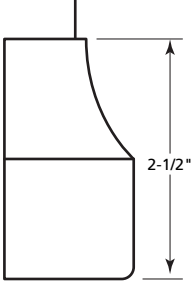

**Solid Hardwood Base:**  
 Bases are constructed of solid  
 hardwood lumber 2-1/2" x  
 1-5/8". Corners are precisely  
 mitred and joined with solid  
 hardwood corner blocks  
 screwed and glued for durability.  
 Non-mitred single end bases are  
 flushed to kneespace side to  
 allow modular cabinet use.

## Pulls/knobs

Factory Installed

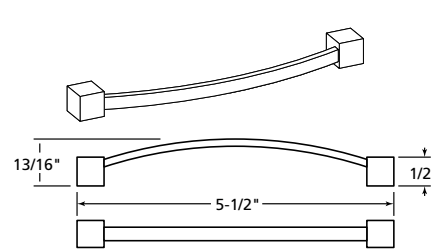

- PL-125 Antique Pewter
- PL-126 Antique English
- PL-127 Matte Black

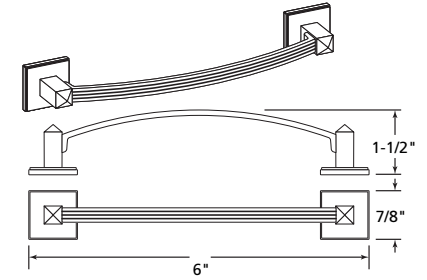

- PL-220 Antique Pewter
- PL-221 Matte Black

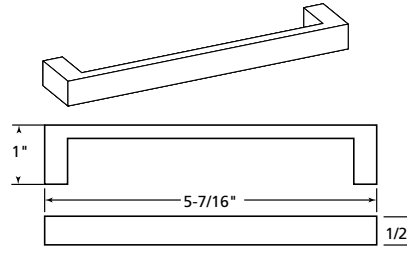

- PL-115 Matte Black
- PL-116 Matte Nickel

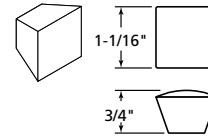

- DK-125 Antique Pewter
- DK-126 Antique English
- DK-127 Matte Black

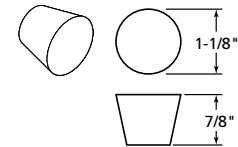

- DK-128 Antique Pewter

# Capitol park grommets | grommet reference

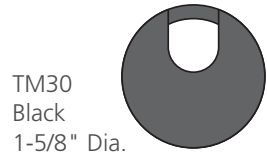

TM30  
Black  
1-5/8" Dia.

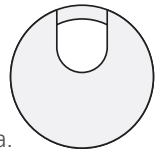

TM31  
Silver  
1-5/8" Dia.

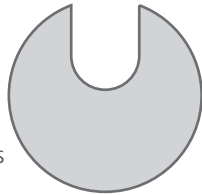

TM33  
Antique Brass  
2-1/2" Dia.

## Optional grommets

Factory Installed

Grommets (Standard Location)

Specify Color and Left/Right/Center - \$50 ea.

- Black: TM30-R (Right), TM30-L (Left), TM30-C (Center)

- Silver: TM31-R (Right), TM31-L (Left), TM31-C (Center)

- Antique Brass: TM33-R (Right), TM33-L (Left), TM33-C (Center)

Grommets (Non-Standard Location)

Provide drawing w/ Grommet Location and Specify Color - \$95 ea.

- Black: TM30-NS

- Silver: TM31-NS

- Antique Brass: TM33-NS

TM50  
Black  
1-5/8" Dia.



## Grommets (vertical surface)

Standard Location - \$50 ea.

- Black Plastic Vertical Surface: TM50-C (Bottom Center)

Non-Standard Location - \$95 ea.

- Black Plastic Vertical Surface: TM50-NS

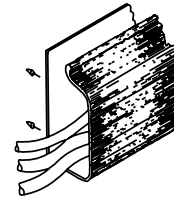

W1

## Horizontal J-channel

Horizontal J-Channel wire management (Sku: W-1) is sold separately to conceal wire under worksurfaces.

## Standard Grommet Location Reference



Desk  
Specify Right or Left Grommet

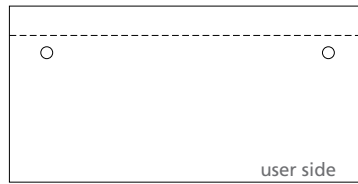

6" Overhang Desk  
Specify Right or Left Grommet

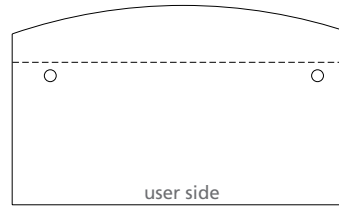

6"/12" Bow Front Desk  
Specify Right or Left Grommet



Bullet Conference Desk (Right Post)  
Center Grommet

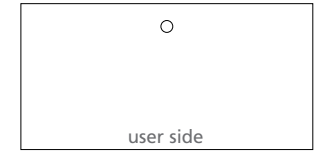

Bridge  
Center Grommet

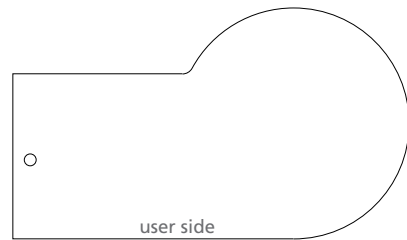

P Conference Desk (Right Post)  
Center Grommet



Return (Left Pedestal Shown)  
Right Pedestal - Left Grommet  
Left Pedestal - Right Grommet

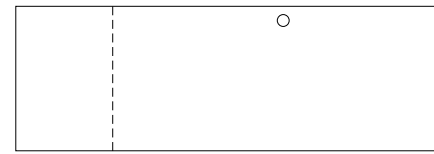

Workstation Credenza  
Center Kneespace Grommet

## Capitol park ganging | height reference

### Ganging – flush cut modification

30" H Casegood Worksurface & Base Ganging Modifications

To gang two casegood units, each unit end to be ganged must be flush cut modified for gapless surfaces and cabinet chassis.

Order Option:

- FC-B: Flush Unit Both Sides(Facing) for Ganging - \$100
- FC-L: Flush Unit Left (Facing) for Ganging - \$100
- FC-R: Flush Unit Right (Facing) for Ganging - \$100

Flush cut modification per unit includes all modifications to gang to one end or both ends when units are ganged. Modification includes tops, base and molding.

Modification reduces width size approximately 1" per end.

Example:

CAP3024CA104W Two Drawer Lateral File (Left) Flush Cut Right – FC-R...\$100

CAP7124CA054W Kneespace Credenza (Right) Flush Cut Left – FC-L...\$100

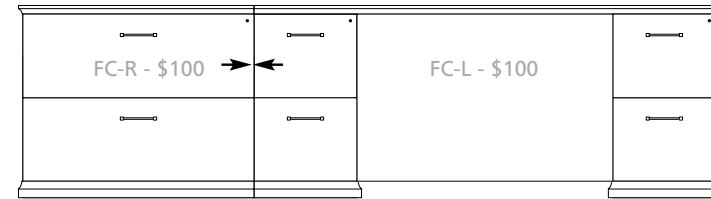

## Height reference

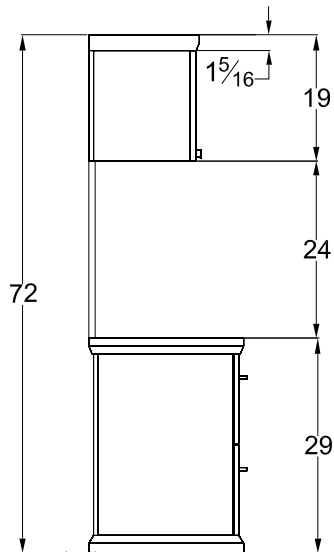

Typical Single Height Side Profile Wall Hung Overhead

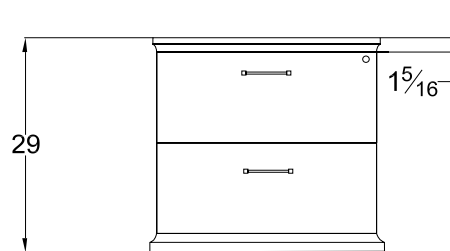

Pedestal Front Profile Lateral File

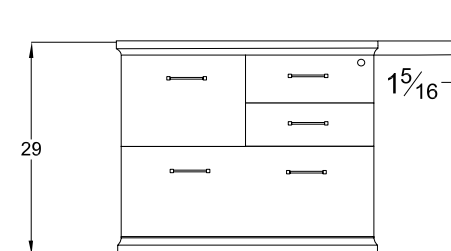

Pedestal Front Profile Multi-File



Capitol park modesty reference | door detail | grain direction

Modesty reference

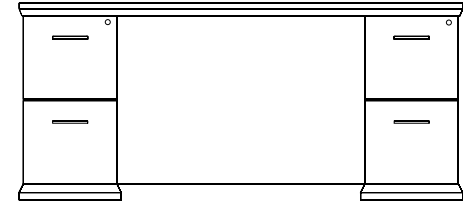
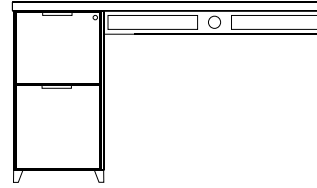
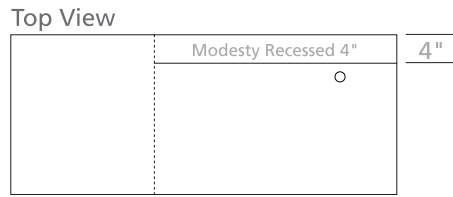
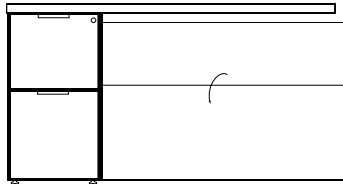

**M34**  
Drop Door Tech Modesty

**M5I**  
Open Back Modesty with 4" Wire Management Rail

**M37**  
Fixed Full Modesty

Overhead door detail

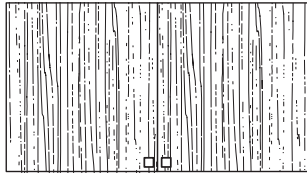

Panel Door

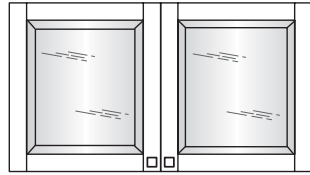

Beveled Glass Door

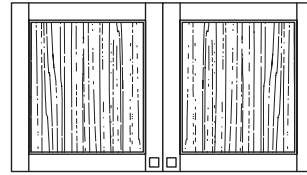

Solid Hardwood Frame Door  
w/ Veneer Insert - Only Available on "W" Styles

Grain direction

Veneer chassis parts are vertical grain. Doors feature vertical veneer bookmatched horizontally in sets of 2,4, and 6 doors. Tower fronts are matched in vertical sets.



Desk

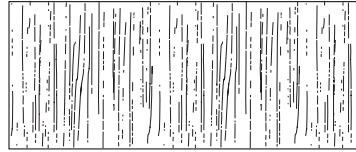

Runoff Desk

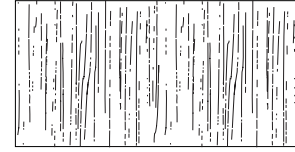

Bridge

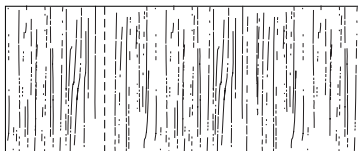

Return



Credenza

# Capitol park drawer dimensions | filing reference

## Interior drawer dimensions

UNIT DEPTH	DRAWER TYPE	OVERALL DIMENSIONS			INTERIOR DRAWER DIMENSIONS			NOTES
		W	D	H	W	D	H	
15-5/8" Letter	36" Box	13-1/8	19-11/16	4	12-1/8	18-11/16	3-7/16	Units less than 72"
	36" File	13-1/8	19-11/16	9-13/16	12-1/8	18-11/16	9-5/16	Units less than 72"
	30" Box	13-1/8	19-11/16	4	12-1/8	18-11/16	3-7/16	Units less than 72"
	30" File	13-1/8	19-11/16	9-13/16	12-1/8	18-11/16	9-5/16	Units less than 72"
	24" Box	13-1/8	16-1/16	4	12-1/8	15-1/16	3-7/16	Units less than 72"
	24" File	13-1/8	16-1/16	9-13/16	12-1/8	15-1/16	9-5/16	Units less than 72"
29" Lateral	24" File	26-1/2	16-1/16	9-13/16	25-1/2	15-1/16	9-5/16	Workstation Credenzas less than 82"
31" Lateral	24" File	28-9/16	16-1/16	9-13/16	27-9/16	15-1/16	9-5/16	Multi-File Lateral File
35" Lateral	24" File	32-1/2	16-1/16	9-13/16	31-1/2	15-1/16	9-5/16	Workstation Credenzas over 83"

## Filing reference

### Filing for 24" depth units

13 1/8" Wide File Drawer - 16 1/16" Deep

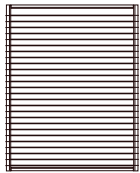

Letter Front to Back

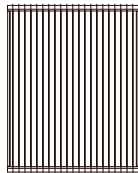

Legal Side to Side with File Rail

### 29" and 31" Lateral file drawer

26-1/2" Wide File Drawer - 16-1/16" Deep

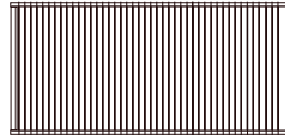

Legal Side to Side

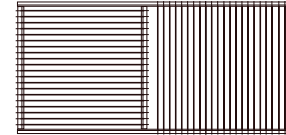

Legal Side to Side  
Letter Front to Back with File Rail

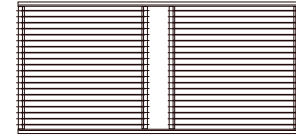

Letter Front to Back with File Rail

### Filing for 30" & 36" depth units

13 1/8" Wide File Drawer - 19 11/16" Deep

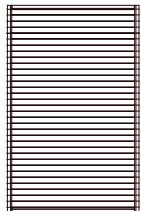

Letter Front to Back

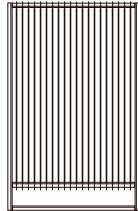

Legal Side to Side with File Rail

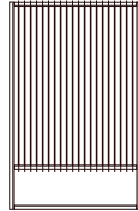

Letter Side to Side with File Rail

### 35" Lateral file drawer

32-1/2" Wide File Drawer - 16-1/16" Deep

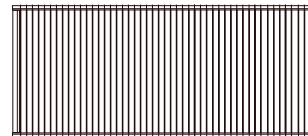

Legal Side to Side

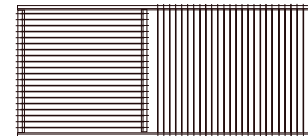

Legal Side to Side  
Letter Front to Back with File Rail

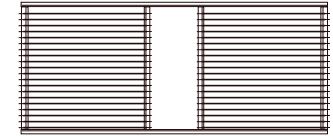

Letter Front to Back with File Rail

# Capitol park.

Double Pedestal Desks  
Executive / Breakfront

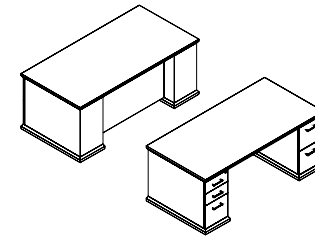

## 1 Select a model

w" x d" x h"

weight	Standard Veneer Top		Premium Veneer Top		High Pressure Laminate Top		Thermally Fused Laminate Top	
	Standard Veneer Chassis		Premium Veneer Chassis		Veneer Chassis		Thermally Fused Laminate Chassis	
84 x 36 x 29	350	CAP8436DD000W	4286	"P" Option N/A	CAP8436DD000G	4286	"M" Option N/A	
78 x 36 x 29	335	CAP7836DD000W	4144	"P" Option N/A	CAP7836DD000G	4144	"M" Option N/A	
72 x 36 x 29	315	CAP7236DD000W	4001	"P" Option N/A	CAP7236DD000G	4001	"M" Option N/A	
72 x 30 x 29	295	CAP7230DD000W	3860	"P" Option N/A	CAP7230DD000G	3860	"M" Option N/A	
66 x 30 x 29	270	CAP6630DD000W	3740	"P" Option N/A	CAP6630DD000G	3740	"M" Option N/A	
60 x 30 x 29	260	CAP6030DD000W	3511	"P" Option N/A	CAP6030DD000G	3511	"M" Option N/A	

[View statement of line](#)

## 2 Select a finish

[View finish details](#)

WAC  
WRC  
WIC  
WHC  
WOC  
WEW  
WGW  
WBW  
WSW  
WNW

GAC  
GIC  
GHC  
GOC  
GEW  
GNW

## 3 Select a edge

[View edge details](#)



## 4 Select hardware

[View hardware details](#)

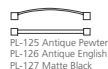

## Product features.

- Box/Box/File (left)
- File/File - Right
- Full extension drawers - locking
- Hardwood base w/ mitred corners
- Legal/Letter Filing
- Soft close suspension drawer(s)

### NOTES

- 6" Recessed Modesty

## Options.

### ACCESSORIES

- K28: Articulating keyboard w/ mouse pad - \$390
- K31: Center drawer - \$205
- PC10: Desk pedestal w/ wire cavity and access door - \$100

### DRAWER

- P6: Modify File/File to Box/Box/File - \$55
- P33: Wood Drawer Upgrade - \$45 per drawer

### GROMMETS (STANDARD LOCATION)

- Specify Color and Left/Right - \$50 ea.
- Black: TM30-R (Right), TM30-L (Left)
  - Silver: TM31-R (Right), TM31-L (Left)
  - Antique Brass: TM33-R (Right), TM33-L (Left)

### GROMMETS (NON-STANDARD LOCATION)

- Provide drawing w/ Grommet Location and Specify Color - \$95 ea.
- Black: TM30-NS
  - Silver: TM31-NS
  - Antique Brass: TM33-NS

### MODESTY

- M11: Breakfront Arch Modesty - \$205

# Capitol park.

Double Pedestal Desks  
Bowfront / Breakfront

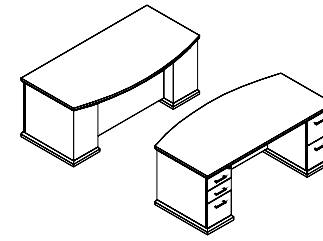

## 1 Select a model

w" x d" x h"

weight	Standard Veneer Top		Premium Veneer Top		High Pressure Laminate Top		Thermally Fused Laminate Top	
	Standard Veneer Chassis		Premium Veneer Chassis		Veneer Chassis		Thermally Fused Laminate Chassis	
84 x 36/42 x 29	375	CAP8442DD006W 4972	"P" Option N/A		CAP8442DD006G 4972		"M" Option N/A	
78 x 36/42 x 29	360	CAP7842DD006W 4659	"P" Option N/A		CAP7842DD006G 4659		"M" Option N/A	
72 x 36/42 x 29	335	CAP7242DD006W 4331	"P" Option N/A		CAP7242DD006G 4331		"M" Option N/A	
72 x 30/36 x 29	315	CAP7236DD006W 4162	"P" Option N/A		CAP7236DD006G 4162		"M" Option N/A	
66 x 30/36 x 29	300	CAP6636DD006W 4086	"P" Option N/A		CAP6636DD006G 4086		"M" Option N/A	

[View statement of line](#)

## 2 Select a finish

[View finish details](#)

- WAC
- WRC
- WIC
- WHC
- WOC
- WEW
- WGW
- WBW
- WSW
- WNW

- GAC
- GIC
- GHC
- GOC
- GEW
- GNW

## 3 Select a edge

[View edge details](#)



## 4 Select hardware

[View hardware details](#)

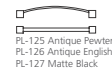
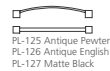

## Product features.

- Box/Box/File (left)
- File/File - Right
- Full extension drawers - locking
- Hardwood base w/ mitred corners
- Legal/Letter Filing
- Soft close suspension drawer(s)

### NOTES

- 12" Recessed Modesty

## Options.

### ACCESSORIES

- K28: Articulating keyboard w/ mouse pad - \$390
- K31: Center drawer - \$205
- PC10: Desk pedestal w/ wire cavity and access door - \$100

### DRAWER

- P6: Modify File/File to Box/Box/File - \$55
- P33: Wood Drawer Upgrade - \$45 per drawer

### GROMMETS (STANDARD LOCATION)

- Specify Color and Left/Right - \$50 ea.
- Black: TM30-R (Right), TM30-L (Left)
  - Silver: TM31-R (Right), TM31-L (Left)
  - Antique Brass: TM33-R (Right), TM33-L (Left)

### GROMMETS (NON-STANDARD LOCATION)

- Provide drawing w/ Grommet Location and Specify Color - \$95 ea.
- Black: TM30-NS
  - Silver: TM31-NS
  - Antique Brass: TM33-NS

### MODESTY

- M11: Breakfront Arch Modesty - \$205



# Capitol park.

Workstation Desks

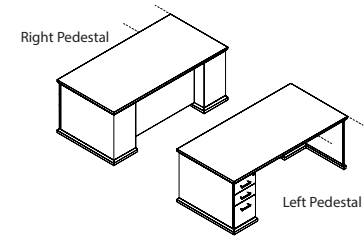
Breakfront - Single Pedestal

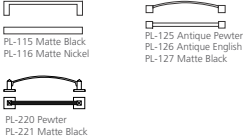
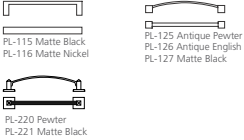

[View statement of line](#)

1 Select a model w" x d" x h"	weight	Standard Veneer Top	Premium Veneer Top	High Pressure Laminate Top	Thermally Fused Laminate Top
		Standard Veneer Chassis	Premium Veneer Chassis	Veneer Chassis	Thermally Fused Laminate Chassis
<b>Left Pedestal</b>					
72 x 36 x 29	275	CAP7236DS009W 3582	"P" Option N/A	CAP7236DS009G 3582	"M" Option N/A
72 x 30 x 29	255	CAP7230DS009W 3466	"P" Option N/A	CAP7230DS009G 3466	"M" Option N/A
66 x 30 x 29	225	CAP6630DS009W 3389	"P" Option N/A	CAP6630DS009G 3389	"M" Option N/A
<b>Right Pedestal</b>					
72 x 36 x 29	275	CAP7236DS010W 3582	"P" Option N/A	CAP7236DS010G 3582	"M" Option N/A
72 x 30 x 29	255	CAP7230DS010W 3466	"P" Option N/A	CAP7230DS010G 3466	"M" Option N/A
66 x 30 x 29	225	CAP6630DS010W 3389	"P" Option N/A	CAP6630DS010G 3389	"M" Option N/A
<b>2 Select a finish</b> <a href="#">View finish details</a>		WAC WRC WIC WHC WOC WEW WGW WBW WSW WNW		GAC GIC GHC GOC GEW GNW	
<b>3 Select a edge</b> <a href="#">View edge details</a>		 Capitol		 Capitol	
<b>4 Select hardware</b> <a href="#">View hardware details</a>					

## Product features.

- Box/Box/File
- Full extension drawers - locking
- Hardwood base w/ mitred corners
- Hookup hardware
- Legal/Letter Filing
- Soft close suspension drawer(s)

### NOTES

- 6" Recessed Modesty

## Options.

### ACCESSORIES

- K28: Articulating keyboard w/ mouse pad - \$390
- K31: Center drawer - \$205
- PC10: Desk pedestal w/ wire cavity and access door - \$100

### DRAWER

- P33: Wood Drawer Upgrade - \$45 per drawer

### GROMMETS (STANDARD LOCATION)

- Specify Color and Left/Right - \$50 ea.
- Black: TM30-R (Right), TM30-L (Left)
  - Silver: TM31-R (Right), TM31-L (Left)
  - Antique Brass: TM33-R (Right), TM33-L (Left)

### GROMMETS (NON-STANDARD LOCATION)

- Provide drawing w/ Grommet Location and Specify Color - \$95 ea.
- Black: TM30-NS
  - Silver: TM31-NS
  - Antique Brass: TM33-NS

### MODESTY

- M11: Breakfront Arch Modesty - \$205







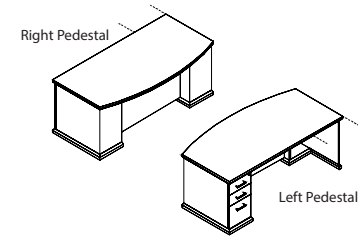

# Capitol park.

Workstation Desks

Bowfront Breakfront - Single Pedestal



[View statement of line](#)

1 Select a model w" x d" x h"	weight	Standard Veneer Top	Premium Veneer Top	High Pressure Laminate Top	Thermally Fused Laminate Top
		Standard Veneer Chassis	Premium Veneer Chassis	Veneer Chassis	Thermally Fused Laminate Chassis
<b>Left Pedestal</b>					
72 x 36/42 x 29	280	CAP7242DS017W 4189	"P" Option N/A	CAP7242DS017G 4189	"M" Option N/A
72 x 30/36 x 29	260	CAP7236DS017W 3962	"P" Option N/A	CAP7236DS017G 3962	"M" Option N/A
66 x 30/36 x 29	230	CAP6636DS017W 3895	"P" Option N/A	CAP6636DS017G 3895	"M" Option N/A
<b>Right Pedestal</b>					
72 x 36/42 x 29	280	CAP7242DS018W 4189	"P" Option N/A	CAP7242DS018G 4189	"M" Option N/A
72 x 30/36 x 29	260	CAP7236DS018W 3962	"P" Option N/A	CAP7236DS018G 3962	"M" Option N/A
66 x 30/36 x 29	230	CAP6636DS018W 3895	"P" Option N/A	CAP6636DS018G 3895	"M" Option N/A
<b>2 Select a finish</b> <a href="#">View finish details</a>		WAC WRC WIC WHC WOC WEW WGW WBW WSW WNW		GAC GIC GHC GOC GEW GNW	
<b>3 Select a edge</b> <a href="#">View edge details</a>		 Capitol		 Capitol	
<b>4 Select hardware</b> <a href="#">View hardware details</a>		 PL-115 Matte Black PL-116 Matte Nickel   FL-220 Pewter FL-221 Matte Black		 PL-115 Matte Black PL-116 Matte Nickel   FL-220 Pewter FL-221 Matte Black	 PL-125 Antique Pewter PL-126 Antique English PL-127 Matte Black   FL-220 Pewter FL-221 Matte Black

## Product features.

- Box/Box/File
- Full extension drawers - locking
- Hardwood base w/ mitred corners
- Hookup hardware
- Legal/Letter Filing
- Soft close suspension drawer(s)

### NOTES

- 12" Recessed Modesty

## Options.

### ACCESSORIES

- K28: Articulating keyboard w/ mouse pad - \$390
- K31: Center drawer - \$205
- PC10: Desk pedestal w/ wire cavity and access door - \$100

### DRAWER

- P33: Wood Drawer Upgrade - \$45 per drawer

### GROMMETS (STANDARD LOCATION)

- Specify Color and Left/Right - \$50 ea.
- Black: TM30-R (Right), TM30-L (Left)
  - Silver: TM31-R (Right), TM31-L (Left)
  - Antique Brass: TM33-R (Right), TM33-L (Left)

### GROMMETS (NON-STANDARD LOCATION)

Provide drawing w/ Grommet Location and Specify Color - \$95 ea.

- Black: TM30-NS
- Silver: TM31-NS
- Antique Brass: TM33-NS

### MODESTY

- M11: Breakfront Arch Modesty - \$205



# Capitol park.

Workstation Desks

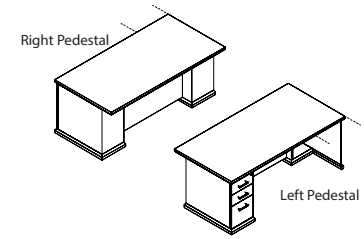
Conference Overhang Breakfront - Single Pedestal

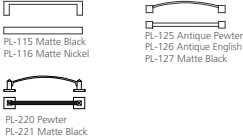
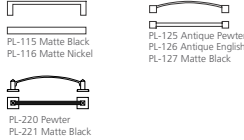

[View statement of line](#)

1 Select a model w" x d" x h"	weight	Standard Veneer Top	Premium Veneer Top	High Pressure Laminate Top	Thermally Fused Laminate Top
		Standard Veneer Chassis	Premium Veneer Chassis	Veneer Chassis	Thermally Fused Laminate Chassis
<b>Left Pedestal</b>					
72 x 36 x 29	255	CAP7236DS634W 3437	"P" Option N/A	CAP7236DS634G 3437	"M" Option N/A
66 x 36 x 29	245	CAP6636DS634W 3295	"P" Option N/A	CAP6636DS634G 3295	"M" Option N/A
<b>Right Pedestal</b>					
72 x 36 x 29	255	CAP7236DS633W 3437	"P" Option N/A	CAP7236DS633G 3437	"M" Option N/A
66 x 36 x 29	245	CAP6636DS633W 3295	"P" Option N/A	CAP6636DS633G 3295	"M" Option N/A
<b>2 Select a finish</b> <a href="#">View finish details</a>		WAC WRC WIC WHC WOC WEW WGW WBW WSW WNW		GAC GIC GHC GOC GEW GNW	
<b>3 Select a edge</b> <a href="#">View edge details</a>		 Capitol		 Capitol	
<b>4 Select hardware</b> <a href="#">View hardware details</a>		 FL-115 Matte Black FL-116 Matte Nickel FL-125 Antique Pewter FL-126 Antique English FL-127 Matte Black FL-220 Pewter FL-221 Matte Black		 FL-115 Matte Black FL-116 Matte Nickel FL-125 Antique Pewter FL-126 Antique English FL-127 Matte Black FL-220 Pewter FL-221 Matte Black	

## Product features.

- Box/Box/File
- Full extension drawers - locking
- Hardwood base w/ mitred corners
- Hookup hardware
- Legal/Letter Filing
- Soft close suspension drawer(s)

### NOTES

- 12" Recessed Modesty
- 66" wide unit - 66 x 30 Chassis
- 72" wide unit - 72 x 30 Chassis
- 84" wide unit - 84 x 30 Chassis

## Options.

### ACCESSORIES

- K28: Articulating keyboard w/ mouse pad - \$390
- K31: Center drawer - \$205
- PC10: Desk pedestal w/ wire cavity and access door - \$100

### DRAWER

- P33: Wood Drawer Upgrade - \$45 per drawer

### GROMMETS (STANDARD LOCATION)

Specify Color and Left/Right - \$50 ea.

- Black: TM30-R (Right), TM30-L (Left)
- Silver: TM31-R (Right), TM31-L (Left)
- Antique Brass: TM33-R (Right), TM33-L (Left)

### GROMMETS (NON-STANDARD LOCATION)

Provide drawing w/ Grommet Location and Specify Color - \$95 ea.

- Black: TM30-NS
- Silver: TM31-NS
- Antique Brass: TM33-NS

### MODESTY

- M11: Breakfront Arch Modesty - \$205

# Capitol park.

"L" Workstation Returns  
File/File

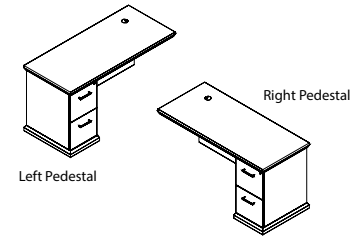

## 1 Select a model

w" x d" x h"

weight	Standard Veneer Top		Premium Veneer Top		High Pressure Laminate Top		Thermally Fused Laminate Top	
	Standard Veneer Chassis		Premium Veneer Chassis		Veneer Chassis		Thermally Fused Laminate Chassis	
<b>Left Pedestal</b>								
66 x 24 x 29	175	CAP6624RE195W	2757	"P" Option N/A	CAP6624RE195G	2757	"M" Option N/A	
60 x 24 x 29	165	CAP6024RE195W	2681	"P" Option N/A	CAP6024RE195G	2681	"M" Option N/A	
54 x 24 x 29	155	CAP5424RE195W	2612	"P" Option N/A	CAP5424RE195G	2612	"M" Option N/A	
48 x 24 x 29	145	CAP4824RE195W	2538	"P" Option N/A	CAP4824RE195G	2538	"M" Option N/A	
42 x 24 x 29	135	CAP4224RE195W	2470	"P" Option N/A	CAP4224RE195G	2470	"M" Option N/A	
<b>Right Pedestal</b>								
66 x 24 x 29	175	CAP6624RE196W	2757	"P" Option N/A	CAP6624RE196G	2757	"M" Option N/A	
60 x 24 x 29	165	CAP6024RE196W	2681	"P" Option N/A	CAP6024RE196G	2681	"M" Option N/A	
54 x 24 x 29	155	CAP5424RE196W	2612	"P" Option N/A	CAP5424RE196G	2612	"M" Option N/A	
48 x 24 x 29	145	CAP4824RE196W	2538	"P" Option N/A	CAP4824RE196G	2538	"M" Option N/A	
42 x 24 x 29	135	CAP4224RE196W	2470	"P" Option N/A	CAP4224RE196G	2470	"M" Option N/A	

[View statement of line](#)

## 2 Select a finish

[View finish details](#)

- WAC
- WRC
- WIC
- WHC
- WOC
- WEW
- WGW
- WBW
- WSW
- WNW

- GAC
- GIC
- GHC
- GOC
- GEW
- GNW

## 3 Select a edge

[View edge details](#)



## 4 Select hardware

[View hardware details](#)

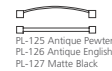
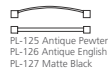

## Product features.

- 1 Standard grommet - matches pull finish or specify black TM30, silver TM31 or antique brass TM33
- Fixed full modesty
- Full extension drawers - locking
- Hardwood base w/ mitred corners
- Hookup hardware
- Soft close suspension drawer(s)

### NOTES

- Left pedestal gets right grommet
- Right pedestal gets left grommet

## Options.

### ACCESSORIES

- K28: Articulating keyboard w/ mouse pad - \$390

### DRAWER

- P6: Modify File/File to Box/Box/File - \$55
- P33: Wood Drawer Upgrade - \$45 per drawer

### FLUSH CUT

- FC-L: Flush Unit Left (Facing) for Ganging - \$100
- FC-R: Flush Unit Right(Facing) for Ganging - \$100

### GROMMETS (NON-STANDARD LOCATION)

- Provide drawing w/ Grommet Location and Specify Color - \$95 ea.
- Black: TM30-NS
  - Silver: TM31-NS
  - Antique Brass: TM33-NS

### MODESTY



- M34T: "W" "G" Style Drop Door Tech Modesty - \$130
- M51: Open Back Modesty with Wire Mgmt Rail - Deduct \$95

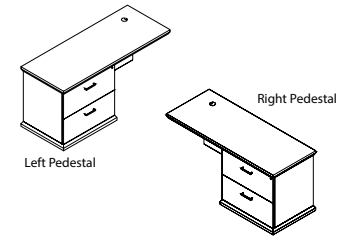

# Capitol park.

"L" Workstation Returns  
Lateral File

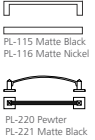
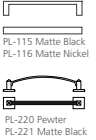
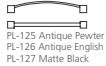

1 Select a model w" x d" x h"	weight	Standard Veneer Top	Premium Veneer Top	High Pressure Laminate Top	Thermally Fused Laminate Top
		Standard Veneer Chassis	Premium Veneer Chassis	Veneer Chassis	Thermally Fused Laminate Chassis
<b>Left Pedestal</b>					
72 x 24 x 29	200	CAP7224RE187W 3187	"P" Option N/A	CAP7224RE187G 3187	"M" Option N/A
66 x 24 x 29	190	CAP6624RE187W 3042	"P" Option N/A	CAP6624RE187G 3042	"M" Option N/A
60 x 24 x 29	185	CAP6024RE187W 2968	"P" Option N/A	CAP6024RE187G 2968	"M" Option N/A
54 x 24 x 29	180	CAP5424RE187W 2900	"P" Option N/A	CAP5424RE187G 2900	"M" Option N/A
48 x 24 x 29	175	CAP4824RE187W 2825	"P" Option N/A	CAP4824RE187G 2825	"M" Option N/A
<b>Right Pedestal</b>					
72 x 24 x 29	200	CAP7224RE188W 3187	"P" Option N/A	CAP7224RE188G 3187	"M" Option N/A
66 x 24 x 29	190	CAP6624RE188W 3042	"P" Option N/A	CAP6624RE188G 3042	"M" Option N/A
60 x 24 x 29	185	CAP6024RE188W 2968	"P" Option N/A	CAP6024RE188G 2968	"M" Option N/A
54 x 24 x 29	180	CAP5424RE188W 2900	"P" Option N/A	CAP5424RE188G 2900	"M" Option N/A
48 x 24 x 29	175	CAP4824RE188W 2825	"P" Option N/A	CAP4824RE188G 2825	"M" Option N/A
<b>2 Select a finish</b> <i>View finish details</i>		WAC WRC WIC WHC WOC WEW WGW WBW WSW WNW		GAC GIC GHC GOC GEW GNW	
<b>3 Select a edge</b> <i>View edge details</i>		 Capitol		 Capitol	
<b>4 Select hardware</b> <i>View hardware details</i>		 PL-115 Matte Black PL-116 Matte Nickel  PL-220 Pewter PL-221 Matte Black		 PL-115 Matte Black PL-116 Matte Nickel  PL-220 Pewter PL-221 Matte Black	 PL-125 Antique Pewter PL-126 Antique English PL-127 Matte Black

*View statement of line*

## Product features.

- 1 Standard grommet - matches pull finish or specify black TM30, silver TM31 or antique brass TM33
- Fixed full modesty
- Full extension drawers - locking
- Hardwood base w/ mitred corners
- Hookup hardware
- Soft close suspension drawer(s)

### NOTES

- K28 Keyboards not available on 48" units
- Left pedestal gets right grommet
- Right pedestal gets left grommet

## Options.

### ACCESSORIES

- K28: Articulating keyboard w/ mouse pad - \$390

### DRAWER

- P33: Wood Drawer Upgrade - \$45 per drawer

### FLUSH CUT

- FC-L: Flush Unit Left (Facing) for Ganging - \$100
- FC-R: Flush Unit Right(Facing) for Ganging - \$100

### GROMMETS (NON-STANDARD LOCATION)

Provide drawing w/ Grommet Location and Specify Color - \$95 ea.

- Black: TM30-NS
- Silver: TM31-NS
- Antique Brass: TM33-NS

### MODESTY

- M34T: "W" "G" Style Drop Door Tech Modesty - \$130
- M51: Open Back Modesty with Wire Mgmt Rail - Deduct \$95

# Capitol park.

"L" Workstation Returns  
Box/Box/File/Lateral

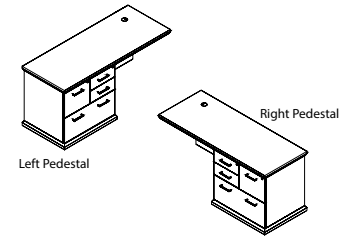

## 1 Select a model w" x d" x h"

weight	Standard Veneer Top		Premium Veneer Top		High Pressure Laminate Top		Thermally Fused Laminate Top	
	Standard Veneer Chassis		Premium Veneer Chassis		Veneer Chassis		Thermally Fused Laminate Chassis	
<b>Left Pedestal</b>								
72 x 24 x 29	225	CAP7224RE218W 3472	"P" Option N/A		CAP7224RE218G 3472	"M" Option N/A		
66 x 24 x 29	190	CAP6624RE218W 3329	"P" Option N/A		CAP6624RE218G 3329	"M" Option N/A		
60 x 24 x 29	185	CAP6024RE218W 3253	"P" Option N/A		CAP6024RE218G 3253	"M" Option N/A		
54 x 24 x 29	180	CAP5424RE218W 3187	"P" Option N/A		CAP5424RE218G 3187	"M" Option N/A		
48 x 24 x 29	175	CAP4824RE218W 3111	"P" Option N/A		CAP4824RE218G 3111	"M" Option N/A		
<b>Right Pedestal</b>								
72 x 24 x 29	225	CAP7224RE219W 3472	"P" Option N/A		CAP7224RE219G 3472	"M" Option N/A		
66 x 24 x 29	190	CAP6624RE219W 3329	"P" Option N/A		CAP6624RE219G 3329	"M" Option N/A		
60 x 24 x 29	185	CAP6024RE219W 3253	"P" Option N/A		CAP6024RE219G 3253	"M" Option N/A		
54 x 24 x 29	180	CAP5424RE219W 3187	"P" Option N/A		CAP5424RE219G 3187	"M" Option N/A		
48 x 24 x 29	175	CAP4824RE219W 3111	"P" Option N/A		CAP4824RE219G 3111	"M" Option N/A		

[View statement of line](#)

## 2 Select a finish [View finish details](#)

- WAC
- WRC
- WIC
- WHC
- WOC
- WEW
- WGW
- WBW
- WSW
- WNW

- GAC
- GIC
- GHC
- GOC
- GEW
- GNW

## 3 Select a edge [View edge details](#)



## 4 Select hardware [View hardware details](#)

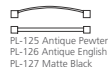

## Product features.

- 1 Standard grommet - matches pull finish or specify black TM30, silver TM31 or antique brass TM33
- Fixed full modesty
- Full extension drawers - locking
- Hardwood base w/ mitred corners
- Hookup hardware
- Soft close suspension drawer(s)

### NOTES

- K28 Keyboards not available on 48" units
- Left pedestal gets right grommet
- Right pedestal gets left grommet

## Options.

### ACCESSORIES

- K28: Articulating keyboard w/ mouse pad - \$390

### DRAWER

- P33: Wood Drawer Upgrade - \$45 per drawer

### FLUSH CUT

- FC-L: Flush Unit Left (Facing) for Ganging - \$100
- FC-R: Flush Unit Right(Facing) for Ganging - \$100

### GROMMETS (NON-STANDARD LOCATION)

Provide drawing w/ Grommet Location and Specify Color - \$95 ea.

- Black: TM30-NS
- Silver: TM31-NS
- Antique Brass: TM33-NS

### MODESTY

- M34T: "W" "G" Style Drop Door Tech Modesty - \$130
- M51: Open Back Modesty with Wire Mgmt Rail - Deduct \$95

# Capitol park.

Workstation Bridges  
Open Back

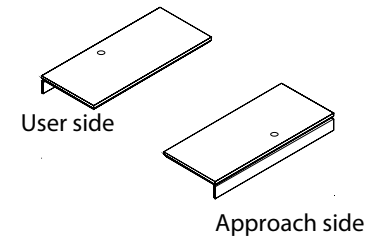

## 1 Select a model

w" x d" x h"

weight	Standard Veneer Top Standard Veneer Chassis		Premium Veneer Top Premium Veneer Chassis		High Pressure Laminate Top Veneer Chassis		Thermally Fused Laminate Top Thermally Fused Laminate Chassis	
	48 x 24 x 29	55	CAP4824BR151W	798	"P" Option N/A	CAP4824BR151G	798	"M" Option N/A
42 x 24 x 29	50	CAP4224BR151W	757	"P" Option N/A	CAP4224BR151G	757	"M" Option N/A	
36 x 24 x 29	45	CAP3624BR151W	718	"P" Option N/A	CAP3624BR151G	718	"M" Option N/A	

[View statement of line](#)

## 2 Select a finish

[View finish details](#)

WAC	GAC
WRC	GIC
WIC	GHC
WHC	GOC
WOC	GEW
WEW	GNW
WGW	
WBW	
WSW	
WNW	

## 3 Select a edge

[View edge details](#)



## 4 Select hardware

[View hardware details](#)

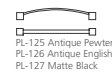
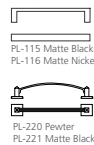
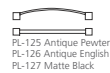
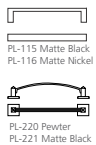

## Product features.

- 1 Standard grommet - matches pull finish or specify black TM30, silver TM31 or antique brass TM33

## Options.

### ACCESSORIES

- K28: Articulating keyboard w/ mouse pad - \$390

### GROMMETS (NON-STANDARD LOCATION)

Provide drawing w/ Grommet Location and Specify Color - \$95 ea.

- Black: TM30-NS
- Silver: TM31-NS
- Antique Brass: TM33-NS



### MODESTY

- M34T-O: "W" "G" Style Drop Door Tech Modesty - \$295
- M37: "W" "G" Style Fixed Full Modesty - \$130

# Capitol park.

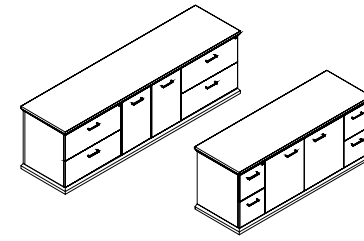
Credenzas  
File / Storage

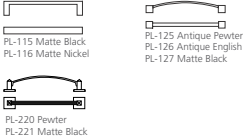
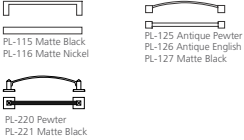

1 Select a model w" x d" x h"	weight	Standard Veneer Top	Premium Veneer Top	High Pressure Laminate Top	Thermally Fused Laminate Top
		Standard Veneer Chassis	Premium Veneer Chassis	Veneer Chassis	Thermally Fused Laminate Chassis
<b>Lateral File / Storage</b>					
94 x 24 x 29	350	CAP9424CA651W 6658	"P" Option N/A	CAP9424CA651G 6658	"M" Option N/A
88 x 24 x 29	320	CAP8824CA651W 6371	"P" Option N/A	CAP8824CA651G 6371	"M" Option N/A
<b>File / Storage</b>					
71 x 24 x 29	270	CAP7124CA050W 3935	"P" Option N/A	CAP7124CA050G 3935	"M" Option N/A
65 x 24 x 29	255	CAP6524CA050W 3677	"P" Option N/A	CAP6524CA050G 3677	"M" Option N/A
59 x 24 x 29	240	CAP5924CA050W 3535	"P" Option N/A	CAP5924CA050G 3535	"M" Option N/A
<b>2 Select a finish</b> <i>View finish details</i>		WAC WRC WIC WHC WOC WEW WGW WBW WSW WNW		GAC GIC GHC GOC GEW GNW	
<b>3 Select an edge</b> <i>View edge details</i>		 Capitol		 Capitol	
<b>4 Select hardware</b> <i>View hardware details</i>		 PL-115 Matte Black PL-116 Matte Nickel PL-220 Pewter PL-221 Matte Black		 PL-115 Matte Black PL-116 Matte Nickel PL-125 Antique Pewter PL-126 Antique English PL-127 Matte Black PL-220 Pewter PL-221 Matte Black	

*View statement of line*

## Product features.

- Black laminate adjustable shelf behind doors
- Full extension drawers - locking
- Hardwood base w/ mitred corners
- Soft close suspension drawer(s)
- Top shaped on 3 sides

### NOTES

- Unit not designed for open plan use, standard with unfinished back.
- Select OPB Option for Open Plan application.

## Options.

### DOOR

- D2: Door Lock - \$100 per door set
- D6A: "W"/"G" Styles - Delete Doors and replace black laminate shelf with finished shelf - n/c
- D9SC: Soft Close Door Hinges - \$20 per door

### DRAWER

- P6: Modify File/File to Box/Box/File - \$55 ea.
- P33: Wood Drawer Upgrade - \$45 per drawer

### FLUSH CUT

- FC-B: Flush Unit Both Sides(Facing) for Ganging - \$100
- FC-L: Flush Unit Left (Facing) for Ganging - \$100
- FC-R: Flush Unit Right(Facing) for Ganging - \$100

### GROMMETS (STANDARD LOCATION)

- Specify Color and Left/Right/Center - \$50 ea.
- Black: TM30-R (Right), TM30-L (Left), TM30-C (Center)
  - Silver: TM31-R (Right), TM31-L (Left), TM31-C (Center)
  - Antique Brass: TM33-R (Right), TM33-L (Left), TM33-C (Center)

### GROMMETS (NON-STANDARD LOCATION)

- Provide drawing w/ Grommet Location and Specify Color - \$95 ea.
- Black: TM30-NS
  - Silver: TM31-NS
  - Antique Brass: TM33-NS
- Open Plan – Finished Back
- OPB: "W" "G" Style - Modify Unit for Open Plan Application - \$295 Shelves
  - S25: Replace Black Laminate Shelves with Finished Shelves - \$80 per shelf

Capitol park.  
Credenzas  
Kneespace

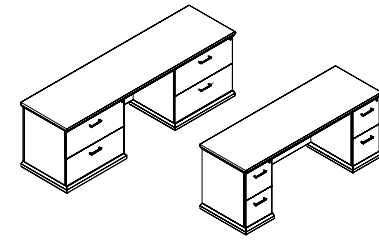

1 Select a model  
w" x d" x h"

weight

Standard Veneer Top Standard Veneer Chassis	Premium Veneer Top Premium Veneer Chassis	High Pressure Laminate Top Veneer Chassis	Thermally Fused Laminate Top Thermally Fused Laminate Chassis
--	--	--	--

**Lateral File / Lateral File**

94 x 24 x 29	325	CAP9424CA052W	4939
88 x 24 x 29	300	CAP8824CA052W	4652

**File / File**

78 x 24 x 29	250	CAP7824CA054W	3794
71 x 24 x 29	225	CAP7124CA054W	3649
65 x 24 x 29	210	CAP6524CA054W	3437
59 x 24 x 29	200	CAP5924CA054W	3363

"P" Option N/A  
"P" Option N/A  
"P" Option N/A  
"P" Option N/A  
"P" Option N/A

CAP9424CA052G	4939
CAP8824CA052G	4652
CAP7824CA054G	3794
CAP7124CA054G	3649
CAP6524CA054G	3437
CAP5924CA054G	3363

"M" Option N/A  
"M" Option N/A  
"M" Option N/A  
"M" Option N/A  
"M" Option N/A

[View statement of line](#)

2 Select a finish  
[View finish details](#)

- WAC
- WRC
- WIC
- WHC
- WOC
- WEW
- WGW
- WBW
- WSW
- WNW

- GAC
- GIC
- GHC
- GOC
- GEW
- GNW

3 Select a edge  
[View edge details](#)



4 Select hardware  
[View hardware details](#)

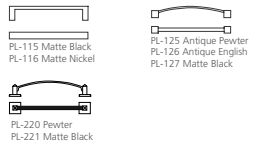
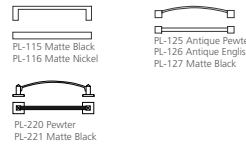

**Product features.**

- Fixed full modesty
- Full extension drawers - locking
- Hardwood base w/ mitred corners
- Soft close suspension drawer(s)
- Top shaped on 3 sides

**NOTES**

- Unit not designed for open plan use, standard with unfinished back.
- Select OPB Option for Open Plan application.

**Options.**

**ACCESSORIES**

- K28: Articulating keyboard w/ mouse pad - \$390

**DRAWER**

- P6: Modify File/File to Box/Box/File - \$55 ea.
- P33: Wood Drawer Upgrade - \$45 per drawer

**FLUSH CUT**

- FC-B: Flush Unit Both Sides(Facing) for Ganging - \$100
- FC-L: Flush Unit Left (Facing) for Ganging - \$100
- FC-R: Flush Unit Right(Facing) for Ganging - \$100

**GROMMETS (STANDARD LOCATION)**

- Specify Color - \$50 ea.
- Black: TM30-C (Center)
  - Silver: TM31-C (Center)
  - Antique Brass: TM33-C (Center)

**GROMMETS (NON-STANDARD LOCATION)**



- Provide drawing w/ Grommet Location and Specify Color - \$95 ea.
- Black: TM30-NS
  - Silver: TM31-NS
  - Antique Brass: TM33-NS
- Modesty
- M34T: "W" "G" Style Drop Door Tech Modesty - \$130
  - M51: Open Back Modesty with Wire Mgmt Rail - Deduct \$95
- Open Plan – Finished Back
- OPB: "W" "G" Style - Modify Unit for Open Plan Application - \$295

# Capitol park.

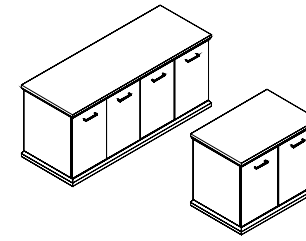
Credenzas  
4/2 Door Storage

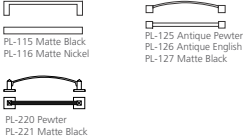
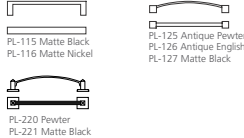

[View statement of line](#)

1 Select a model w" x d" x h"	weight	Standard Veneer Top	Premium Veneer Top	High Pressure Laminate Top	Thermally Fused Laminate Top
		Standard Veneer Chassis	Premium Veneer Chassis	Veneer Chassis	Thermally Fused Laminate Chassis
<b>4 Door</b>					
71 x 24 x 29	250	CAP7124CA125W 3794	"P" Option N/A	CAP7124CA125G 3794	"M" Option N/A
65 x 24 x 29	235	CAP6524CA125W 3535	"P" Option N/A	CAP6524CA125G 3535	"M" Option N/A
59 x 24 x 29	220	CAP5924CA125W 3389	"P" Option N/A	CAP5924CA125G 3389	"M" Option N/A
<b>2 Door</b>					
36 x 24 x 29	140	CAP3624CA125W 2074	"P" Option N/A	CAP3624CA125G 2074	"M" Option N/A
30 x 24 x 29	125	CAP3024CA125W 1931	"P" Option N/A	CAP3024CA125G 1931	"M" Option N/A
<b>2 Select a finish</b> <a href="#">View finish details</a>		WAC WRC WIC WHC WOC WEW WGW WBW WSW WNW		GAC GIC GHC GOC GEW GNW	
<b>3 Select a edge</b> <a href="#">View edge details</a>		 Capitol		 Capitol	
<b>4 Select hardware</b> <a href="#">View hardware details</a>		 PL-115 Matte Black PL-116 Matte Nickel PL-220 Pewter PL-221 Matte Black		 PL-115 Matte Black PL-116 Matte Nickel PL-125 Antique Pewter PL-126 Antique English PL-127 Matte Black PL-220 Pewter PL-221 Matte Black	

## Product features.

- Adjustable shelf per door section (black laminate)
- Anti-tilt safety feature
- Full extension drawers - locking
- Hardwood base w/ mitred corners
- Top shaped on 3 sides

### NOTES

- Unit not designed for open plan use, standard with unfinished back.
- Select OPB Option for Open Plan application.

## Options.

### DOOR

- D2: Door Lock - \$100 per door set
- D6A: "W"/"G" Styles - Delete Doors and replace black laminate shelf with finished shelf - n/c
- D9SC: Soft Close Door Hinges - \$20 per door

### FLUSH CUT

- FC-B: Flush Unit Both Sides(Facing) for Ganging - \$100
- FC-L: Flush Unit Left (Facing) for Ganging - \$100
- FC-R: Flush Unit Right(Facing) for Ganging - \$100

### GROMMETS (STANDARD LOCATION)

- Specify Color and Left/Right/Center - \$50 ea.
- Black: TM30-R (Right), TM30-L (Left), TM30-C (Center)
- Silver: TM31-R (Right), TM31-L (Left), TM31-C (Center)
- Antique Brass: TM33-R (Right), TM33-L (Left), TM33-C (Center)

### OPEN PLAN – FINISHED BACK

- OPB: "W" "G" Style - Modify Unit for Open Plan Application - \$295

### SHELVES



- S25: Replace Black Laminate Shelves with Finished Shelves - \$80 per shelf

# Capitol park.

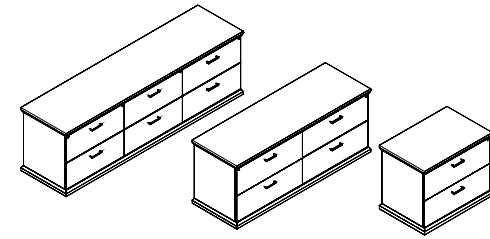
Lateral File Credenzas  
6/4/2 Drawers

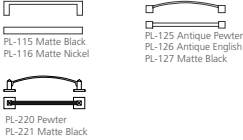
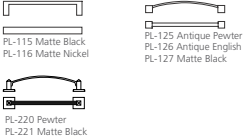

*View statement of line*

1 Select a model w" x d" x h"	weight	Standard Veneer Top Standard Veneer Chassis		Premium Veneer Top Premium Veneer Chassis		High Pressure Laminate Top Veneer Chassis		Thermally Fused Laminate Top Thermally Fused Laminate Chassis	
		<b>6 Drawer</b> 94 x 24 x 29 88 x 24 x 29 <b>4 Drawer</b> 71 x 24 x 29 59 x 24 x 29 <b>2 Drawer</b> 36 x 24 x 29 30 x 24 x 29	415 390 315 285 165 150	CAP9424CA104W CAP8824CA104W CAP7124CA104W CAP5924CA104W CAP3624CA104W CAP3024CA104W	6800 6512 4250 4108 2224 2108	"P" Option N/A "P" Option N/A "P" Option N/A "P" Option N/A "P" Option N/A "P" Option N/A "M" Option N/A	CAP9424CA104G CAP8824CA104G CAP7124CA104G CAP5924CA104G CAP3624CA104G CAP3024CA104G	6800 6512 4250 4108 2224 2108	"M" Option N/A "M" Option N/A "M" Option N/A "M" Option N/A "M" Option N/A "M" Option N/A
2 Select a finish <i>View finish details</i>	WAC WRC WIC WHC WOC WEW WGW WBW WSW WNW				GAC GIC GHC GOC GEW GNW				
3 Select a edge <i>View edge details</i>	 Capitol				 Capitol				
4 Select hardware <i>View hardware details</i>									

## Product features.

- Full extension drawers - locking
- Hardwood base w/ mitred corners
- Soft close suspension drawer(s)
- Top shaped on 3 sides

### NOTES

- Unit not designed for open plan use, standard with unfinished back.  
Select OPB Option for Open Plan application.

## Options.

### DRAWER

- P33: Wood Drawer Upgrade - \$45 per drawer

### FLUSH CUT

- FC-B: Flush Unit Both Sides(Facing) for Ganging - \$100
- FC-L: Flush Unit Left (Facing) for Ganging - \$100
- FC-R: Flush Unit Right(Facing) for Ganging - \$100

### OPEN PLAN – FINISHED BACK







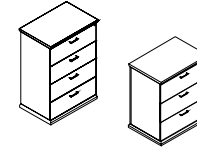

- OPB: "W" "G" Style - Modify Unit for Open Plan Application - \$295
- OPB: "M" Style - Modify Unit for Open Plan Application - \$195

# Capitol park.

Lateral File  
Vertical Lateral File



[View statement of line](#)

1 Select a model w" x d" x h"	weight	Standard Veneer Top	Premium Veneer Top	High Pressure Laminate Top	Thermally Fused Laminate Top
		Standard Veneer Chassis	Premium Veneer Chassis	Veneer Chassis	Thermally Fused Laminate Chassis
<b>4 Drawer</b>					
36 x 24 x 52	270	CAP3624FI111W 3677	"P" Option N/A	CAP3624FI111G 3677	"M" Option N/A
30 x 24 x 52	245	CAP3024FI111W 3582	"P" Option N/A	CAP3024FI111G 3582	"M" Option N/A
<b>3 Drawer</b>					
36 x 24 x 42	205	CAP3624FI112W 3206	"P" Option N/A	CAP3624FI112G 3206	"M" Option N/A
30 x 24 x 42	185	CAP3024FI112W 3122	"P" Option N/A	CAP3024FI112G 3122	"M" Option N/A
<b>2 Select a finish</b> <a href="#">View finish details</a>		WAC WRC WIC WHC WOC WEW WGW WBW WSW WNW		GAC GIC GHC GOC GEW GNW	
<b>3 Select a edge</b> <a href="#">View edge details</a>		 Capitol		 Capitol	
<b>4 Select hardware</b> <a href="#">View hardware details</a>		 PL-115 Matte Black PL-116 Matte Nickel   PL-220 Pewter PL-221 Matte Black		 PL-115 Matte Black PL-116 Matte Nickel   PL-220 Pewter PL-221 Matte Black	 PL-125 Antique Pewter PL-126 Antique English PL-127 Matte Black   PL-125 Antique Pewter PL-126 Antique English PL-127 Matte Black

## Product features.

- Anti-tilt safety feature
- Full extension drawers - locking
- Hardwood base w/ mitred corners
- Soft close suspension drawer(s)
- Top shaped on 3 sides

### NOTES

- Unit not designed for open plan use, standard with unfinished back.
- Select OPB Option for Open Plan application.

## Options.

### DRAWER

- P33: Wood Drawer Upgrade - \$45 per drawer

### FLUSH CUT

- FC-B: Flush Unit Both Sides(Facing) for Ganging - \$100
- FC-L: Flush Unit Left (Facing) for Ganging - \$100
- FC-R: Flush Unit Right(Facing) for Ganging - \$100

### OPEN PLAN – FINISHED BACK

- OPB: "W" "G" Style - Modify Unit for Open Plan Application - \$295



Capitol park.  
Workstation Credenzas  
File/File

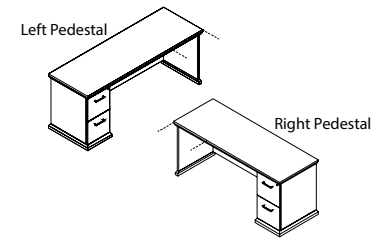

1 Select a model  
w" x d" x h"

weight	Standard Veneer Top Standard Veneer Chassis	Premium Veneer Top Premium Veneer Chassis	High Pressure Laminate Top Veneer Chassis	Thermally Fused Laminate Top Thermally Fused Laminate Chassis
<b>Left Pedestal</b>				
88 x 24 x 29	200 CAP8824CA086W 3253	"P" Option N/A	CAP8824CA086G 3253	"M" Option N/A
71 x 24 x 29	175 CAP7124CA086W 2941	"P" Option N/A	CAP7124CA086G 2941	"M" Option N/A
65 x 24 x 29	165 CAP6524CA086W 2872	"P" Option N/A	CAP6524CA086G 2872	"M" Option N/A
59 x 24 x 29	155 CAP5924CA086W 2798	"P" Option N/A	CAP5924CA086G 2798	"M" Option N/A
<b>Right Pedestal</b>				
88 x 24 x 29	200 CAP8824CA087W 3253	"P" Option N/A	CAP8824CA087G 3253	"M" Option N/A
71 x 24 x 29	175 CAP7124CA087W 2941	"P" Option N/A	CAP7124CA087G 2941	"M" Option N/A
65 x 24 x 29	165 CAP6524CA087W 2872	"P" Option N/A	CAP6524CA087G 2872	"M" Option N/A
59 x 24 x 29	155 CAP5924CA087W 2798	"P" Option N/A	CAP5924CA087G 2798	"M" Option N/A

[View statement of line](#)

2 Select a finish  
[View finish details](#)

- WAC
- WRC
- WIC
- WHC
- WOC
- WEW
- WGW
- WBW
- WSW
- WNW

- GAC
- GIC
- GHC
- GOC
- GEW
- GNW

3 Select a edge  
[View edge details](#)



4 Select hardware  
[View hardware details](#)

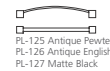
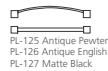

Product features.

- Fixed full modesty
- Full extension drawers - locking
- Hookup hardware
- Soft close suspension drawer(s)

NOTES

- Unit not designed for open plan use, standard with unfinished back.
- Select OPB Option for Open Plan application.

Options.

ACCESSORIES

- K28: Articulating keyboard w/ mouse pad - \$390

DRAWER

- P6: Modify File/File to Box/Box/File - \$55
- P33: Wood Drawer Upgrade - \$45 per drawer

FLUSH CUT

- FC-L: Flush Unit Left (Facing) for Ganging - \$100
- FC-R: Flush Unit Right(Facing) for Ganging - \$100

GROMMETS (STANDARD LOCATION)

- Specify Color - \$50 ea.
- Black: TM30-C (Center)
- Silver: TM31-C (Center)
- Antique Brass: TM33-C (Center)

GROMMETS (NON-STANDARD LOCATION)

Provide drawing w/ Grommet Location and Specify Color - \$95 ea.

- Black: TM30-NS
- Silver: TM31-NS
- Antique Brass: TM33-NS

Modesty

- M34T: "W" "G" Style Drop Door Tech Modesty - \$130
- M51: Open Back Modesty with Wire Mgmt Rail - Deduct \$95
- Open Plan – Finished Back
- OPB: "W" "G" Style - Modify Unit for Open Plan Application - \$295

# Capitol park.

Workstation Credenzas  
Lateral File

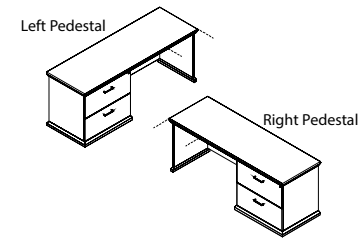

## 1 Select a model

w" x d" x h"

weight	Standard Veneer Top		Premium Veneer Top		High Pressure Laminate Top		Thermally Fused Laminate Top	
	Standard Veneer Chassis		Premium Veneer Chassis		Veneer Chassis		Thermally Fused Laminate Chassis	
<b>Left Pedestal</b>								
94 x 24 x 29	240	CAP9424CA066W 3794	"P" Option N/A		CAP9424CA066G 3794	"M" Option N/A		
88 x 24 x 29	220	CAP8824CA066W 3507	"P" Option N/A		CAP8824CA066G 3507	"M" Option N/A		
71 x 24 x 29	215	CAP7124CA066W 3219	"P" Option N/A		CAP7124CA066G 3219	"M" Option N/A		
65 x 24 x 29	200	CAP6524CA066W 3152	"P" Option N/A		CAP6524CA066G 3152	"M" Option N/A		
59 x 24 x 29	190	CAP5924CA066W 3077	"P" Option N/A		CAP5924CA066G 3077	"M" Option N/A		
<b>Right Pedestal</b>								
94 x 24 x 29	240	CAP9424CA067W 3794	"P" Option N/A		CAP9424CA067G 3794	"M" Option N/A		
88 x 24 x 29	220	CAP8824CA067W 3507	"P" Option N/A		CAP8824CA067G 3507	"M" Option N/A		
71 x 24 x 29	215	CAP7124CA067W 3219	"P" Option N/A		CAP7124CA067G 3219	"M" Option N/A		
65 x 24 x 29	200	CAP6524CA067W 3152	"P" Option N/A		CAP6524CA067G 3152	"M" Option N/A		
59 x 24 x 29	190	CAP5924CA067W 3077	"P" Option N/A		CAP5924CA067G 3077	"M" Option N/A		

[View statement of line](#)

## 2 Select a finish

[View finish details](#)

- WAC
- WRC
- WIC
- WHC
- WOC
- WEW
- WGW
- WBW
- WSW
- WNW

- GAC
- GIC
- GHC
- GOC
- GEW
- GNW

## 3 Select a edge

[View edge details](#)



## 4 Select hardware

[View hardware details](#)

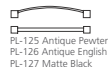

## Product features.

- Fixed full modesty
- Full extension drawers - locking
- Hookup hardware
- Soft close suspension drawer(s)

### NOTES

- K28 Keyboard not available on 71", 65", and 59" units
- Unit not designed for open plan use, standard with unfinished back. Select OPB Option for Open Plan application.

## Options.

### ACCESSORIES

- K28: Articulating keyboard w/ mouse pad - \$390

### DRAWER

- P33: Wood Drawer Upgrade - \$45 per drawer

### FLUSH CUT

- FC-L: Flush Unit Left (Facing) for Ganging - \$100
- FC-R: Flush Unit Right(Facing) for Ganging - \$100

### GROMMETS (STANDARD LOCATION)

- Specify Color - \$50 ea.
- Black: TM30-C (Center)
  - Silver: TM31-C (Center)
  - Antique Brass: TM33-C (Center)

### GROMMETS (NON-STANDARD LOCATION)

Provide drawing w/ Grommet Location and Specify Color - \$95 ea.

- Black: TM30-NS
- Silver: TM31-NS
- Antique Brass: TM33-NS

### Modesty

- M34T: "W" "G" Style Drop Door Tech Modesty - \$130
- M51: Open Back Modesty with Wire Mgmt Rail - Deduct \$95
- Open Plan – Finished Back
- OPB: "W" "G" Style - Modify Unit for Open Plan Application - \$295

# Capitol park.

Workstation Credenzas  
Box/Box/File/Lateral

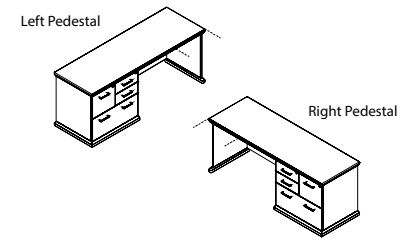

## 1 Select a model

w" x d" x h"

weight	Standard Veneer Top		Premium Veneer Top		High Pressure Laminate Top		Thermally Fused Laminate Top	
	Standard Veneer Chassis		Premium Veneer Chassis		Veneer Chassis		Thermally Fused Laminate Chassis	
<b>Left Pedestal</b>								
94 x 24 x 29	240	CAP9424CA667W	4079	"P" Option N/A	CAP9424CA667G	4079	"M" Option N/A	
88 x 24 x 29	220	CAP8824CA667W	3794	"P" Option N/A	CAP8824CA667G	3794	"M" Option N/A	
71 x 24 x 29	215	CAP7124CA667W	3507	"P" Option N/A	CAP7124CA667G	3507	"M" Option N/A	
65 x 24 x 29	200	CAP6524CA667W	3437	"P" Option N/A	CAP6524CA667G	3437	"M" Option N/A	
59 x 24 x 29	190	CAP5924CA667W	3363	"P" Option N/A	CAP5924CA667G	3363	"M" Option N/A	
<b>Right Pedestal</b>								
94 x 24 x 29	240	CAP9424CA668W	4079	"P" Option N/A	CAP9424CA668G	4079	"M" Option N/A	
88 x 24 x 29	220	CAP8824CA668W	3794	"P" Option N/A	CAP8824CA668G	3794	"M" Option N/A	
71 x 24 x 29	215	CAP7124CA668W	3507	"P" Option N/A	CAP7124CA668G	3507	"M" Option N/A	
65 x 24 x 29	200	CAP6524CA668W	3437	"P" Option N/A	CAP6524CA668G	3437	"M" Option N/A	
59 x 24 x 29	190	CAP5924CA668W	3363	"P" Option N/A	CAP5924CA668G	3363	"M" Option N/A	

[View statement of line](#)

## 2 Select a finish

[View finish details](#)

- WAC
- WRC
- WIC
- WHC
- WOC
- WEW
- WGW
- WBW
- WSW
- WNW

- GAC
- GIC
- GHC
- GOC
- GEW
- GNW

## 3 Select a edge

[View edge details](#)



## 4 Select hardware

[View hardware details](#)

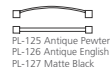

## Product features.

- Fixed full modesty
- Full extension drawers - locking
- Hookup hardware
- Soft close suspension drawer(s)

### NOTES

- K28 Keyboard not available on 71", 65", and 59" units
- Unit not designed for open plan use, standard with unfinished back. Select OPB Option for Open Plan application.

## Options.

### ACCESSORIES

- K28: Articulating keyboard w/ mouse pad - \$390

### DRAWER

- P33: Wood Drawer Upgrade - \$45 per drawer

### FLUSH CUT

- FC-L: Flush Unit Left (Facing) for Ganging - \$100
- FC-R: Flush Unit Right(Facing) for Ganging - \$100

### GROMMETS (STANDARD LOCATION)

- Specify Color - \$50 ea.
- Black: TM30-C (Center)
  - Silver: TM31-C (Center)
  - Antique Brass: TM33-C (Center)

### GROMMETS (NON-STANDARD LOCATION)

Provide drawing w/ Grommet Location and Specify Color - \$95 ea.

- Black: TM30-NS
- Silver: TM31-NS
- Antique Brass: TM33-NS

### Modesty

- M34T: "W" "G" Style Drop Door Tech Modesty - \$130
- M51: Open Back Modesty with Wire Mgmt Rail - Deduct \$95
- Open Plan – Finished Back
- OPB: "W" "G" Style - Modify Unit for Open Plan Application - \$295

# Capitol park.

Single Storage Overhead Console  
Panel Door - 6/4/2 Door

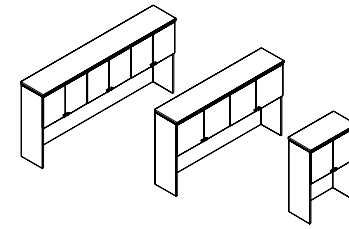

## 1 Select a model w" x d" x h"

weight	Standard Veneer Top		Premium Veneer Top		High Pressure Laminate Top		Thermally Fused Laminate Top	
	Standard Veneer Chassis		Premium Veneer Chassis		Veneer Chassis		Thermally Fused Laminate Chassis	
<b>6 Door</b>								
94 x 15 x 43	315	CAP9443OH325W	4063	"P" Option N/A	"G" Option N/A	"M" Option N/A		
88 x 15 x 43	285	CAP8843OH325W	3655	"P" Option N/A	"G" Option N/A	"M" Option N/A		
<b>4 Door</b>								
84 x 15 x 43	275	CAP8443OH325W	3516	"P" Option N/A	"G" Option N/A	"M" Option N/A		
77 x 15 x 43	255	CAP7743OH325W	3380	"P" Option N/A	"G" Option N/A	"M" Option N/A		
71 x 15 x 43	240	CAP7143OH325W	3105	"P" Option N/A	"G" Option N/A	"M" Option N/A		
65 x 15 x 43	225	CAP6543OH325W	3035	"P" Option N/A	"G" Option N/A	"M" Option N/A		
59 x 15 x 43	210	CAP5943OH325W	2969	"P" Option N/A	"G" Option N/A	"M" Option N/A		
48 x 15 x 43	105	CAP4843OH325W	2905	"P" Option N/A	"G" Option N/A	"M" Option N/A		
<b>2 Door</b>								
36 x 15 x 43	120	CAP3643OH325W	1882	"P" Option N/A	"G" Option N/A	"M" Option N/A		
30 x 15 x 43	105	CAP3043OH325W	1855	"P" Option N/A	"G" Option N/A			

[View statement of line](#)

## 2 Select a finish [View finish details](#)

- WAC
- WRC
- WIC
- WHC
- WOC
- WEW
- WGW
- WBW
- WSW
- WNW

## 3 Select a edge [View edge details](#)



Capitol

## 4 Select hardware [View hardware details](#)



DK-125 Antique Pewter  
DK-126 Antique English  
DK-127 Matte Black



DK-128 Antique Pewter

## Product features.

- Finished top
- Interior cabinet depth 12.5"
- Task light cord grommet
- Top shaped on front and sides

### NOTES

- Unit has black back panel and is not designed for Open Plan use.
- Select OPB Option for Open Plan application

## Options.

### DOOR

- D2: Door Lock - \$100 per door set
- D6: Delete Doors - n/c
- D9SC: Soft Close Door Hinges - \$20 per door

### FLUSH CUT

- FC-B: Flush Unit Both Sides(Facing) for Ganging - \$100
- FC-L: Flush Unit Left (Facing) for Ganging - \$100
- FC-R: Flush Unit Right(Facing) for Ganging - \$100

### GROMMETS (VERTICAL SURFACE)

- Standard Location - \$50 ea.
- Black Plastic Vertical Surface: TM50-C (Bottom Center)
- Non-Standard Location - \$95 ea.
- Black Plastic Vertical Surface: TM50-NS

### TASK LIGHTING (RECESSED)

Overhead tasklight cord is located on the right facing side. If the opposite location is required please contact customer service.

- LT-LED24R: 24" LED Task light - \$190
- LT-LED48R: 48" LED Task light - \$245
- LT-LED60R: 60" LED Task light - \$310
- LT-LED72R: 72" LED Task light - \$335

### OPEN PLAN – FINISHED BACK

- OPB: "W" "G" Style - Modify Unit for Open Plan Application - \$395

# Capitol park.

Single Storage Overhead Console  
Wood Frame Door With Clear Glass Inserts

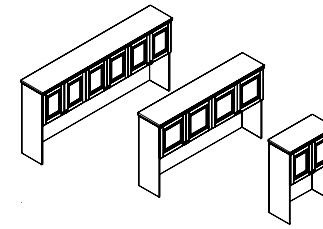

## 1 Select a model w" x d" x h"

weight	Standard Veneer Top Standard Veneer Chassis	Premium Veneer Top Premium Veneer Chassis	High Pressure Laminate Top Veneer Chassis	Thermally Fused Laminate Top Thermally Fused Laminate Chassis
<b>6 Door</b>				
94 x 15 x 43	315 CAP9443OH323W 4746	"P" Option N/A	"G" Option N/A	"M" Option N/A
88 x 15 x 43	285 CAP8843OH323W 4338	"P" Option N/A	"G" Option N/A	"M" Option N/A
<b>4 Door</b>				
71 x 15 x 43	240 CAP7143OH323W 3516	"P" Option N/A	"G" Option N/A	"M" Option N/A
65 x 15 x 43	225 CAP6543OH323W 3451	"P" Option N/A	"G" Option N/A	"M" Option N/A
59 x 15 x 43	210 CAP5943OH323W 3380	"P" Option N/A	"G" Option N/A	"M" Option N/A
<b>2 Door</b>				
36 x 15 x 43	120 CAP3643OH323W 2021	"P" Option N/A	"G" Option N/A	"M" Option N/A
30 x 15 x 43	105 CAP3043OH323W 1993	"P" Option N/A	"G" Option N/A	"M" Option N/A

[View statement of line](#)

## 2 Select a finish [View finish details](#)

- WAC
- WRC
- WIC
- WHC
- WOC
- WEW
- WGW
- WBW
- WSW
- WNW

## 3 Select an edge [View edge details](#)



Capitol

## 4 Select hardware [View hardware details](#)



DK-125 Antique Pewter  
DK-126 Antique English  
DK-127 Matte Black



DK-128 Antique Pewter

## Product features.

- Finished top
- Interior cabinet depth 12.5"
- Task light cord grommet
- Top shaped on front and sides

### NOTES

- Unit has black back panel and is not designed for Open Plan use.
- Select OPB Option for Open Plan application

## Options.

### DOOR

- D2-G: Door Lock for Glass Doors - \$205 per door set
- D9SC: Soft Close Door Hinges - \$20 per door

### FLUSH CUT

- FC-B: Flush Unit Both Sides(Facing) for Ganging - \$100
- FC-L: Flush Unit Left (Facing) for Ganging - \$100
- FC-R: Flush Unit Right(Facing) for Ganging - \$100

### GROMMETS (VERTICAL SURFACE)

- Standard Location - \$50 ea.
- Black Plastic Vertical Surface: TM50-C (Bottom Center)
- Non-Standard Location - \$95 ea.
- Black Plastic Vertical Surface: TM50-NS

### INTERIOR CABINET LIGHTING

- LEDPK starter kit includes Infeed, 1 Puck Interior Light and the ability to daisy chain up to 6 total Puck Lights
- LEDPK: LED Puck Starter Kit - \$310
- PK: 1 LED Interior Light - \$130

### TASK LIGHTING (RECESSED)

- Overhead tasklight cord is located on the right facing side. If the opposite location is required please contact customer service.
- LT-LED24R: 24" LED Task light - \$190
- LT-LED48R: 48" LED Task light - \$245
- LT-LED60R: 60" LED Task light - \$310
- LT-LED72R: 72" LED Task light - \$335
- Open Plan – Finished Back
- OPB: "W" "G" Style - Modify Unit for Open Plan Application - \$395

# Capitol park tackboards.

Overhead tackboard  
Full width tackboards

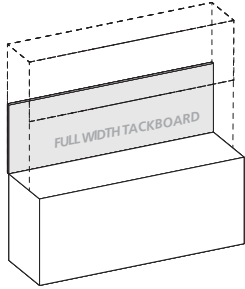

Product Width	Panel Dimension	SKU	COM	1	2	3	4	5	6	7	8	9	10	11/L1	12	13/L2
94	91 x .75 x 21	FTOC9121	379	480	531	582	633	684	735	786	837	888	939	990	1041	1143
88	85 x .75 x 21	FTOC8521	358	449	497	545	593	641	689	737	785	833	881	929	977	1073
84	81 x .75 x 21	FTOC8121	336	428	474	520	566	612	658	704	750	796	842	888	934	1026
77	74 x .75 x 21	FTOC7421	309	392	435	478	521	564	607	650	693	736	779	822	865	951
71	68 x .75 x 21	FTOC6821	282	361	401	441	481	521	561	601	641	681	721	761	801	881
65	62 x .75 x 21	FTOC6221	256	330	366	402	438	474	510	546	582	618	654	690	726	798
59	56 x .75 x 21	FTOC5621	234	299	331	363	395	427	459	491	523	555	587	619	651	715
48	45 x .75 x 21	FTOC4521	187	242	269	296	323	350	377	404	431	458	485	512	539	593
36	33 x .75 x 21	FTOC3321	141	180	200	220	240	260	280	300	320	340	360	380	400	440
30	27 x .75 x 21	FTOC2721	112	149	166	183	200	217	234	251	268	285	302	319	336	370

### Standard Features

- Constructed of .5" thick fiberboard
- Fabric is precisely aligned and fitted to the tackboard
- Adhered to the rigid hardboard with staples
- Hung with Z-Strip mounting system

### Notes

- Fabric Tack Panels are raised 3" from bottom edge when TM50 grommet is ordered

Overhead tackboard  
Half width tackboards

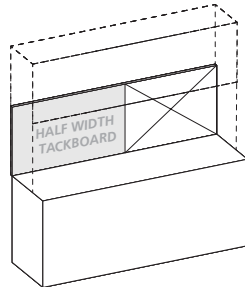

Product Width	Panel Dimension	SKU	COM	1	2	3	4	5	6	7	8	9	10	11/L1	12	13/L2
94 Half Width	45.5 x .75 x 21	FTOC4521	189	240	266	292	318	344	370	396	422	448	474	500	526	578
88 Half Width	42.5 x .75 x 21	FTOC4221	179	225	249	273	297	321	345	369	393	417	441	465	489	537
84 Half Width	40.5 x .75 x 21	FTOC4021	168	214	237	260	283	306	329	352	375	398	421	444	467	513
77 Half Width	37 x .75 x 21	FTOC3721	155	196	217	238	259	280	301	322	343	364	385	406	427	469
71 Half Width	34 x .75 x 21	FTOC3421	141	180	200	220	240	260	280	300	320	340	360	380	400	440
65 Half Width	31 x .75 x 21	FTOC3121	128	165	183	201	219	237	255	273	291	309	327	345	363	399

### Standard Features

- Constructed of .5" thick fiberboard
- Fabric is precisely aligned and fitted to the tackboard
- Adhered to the rigid hardboard with staples
- Hung with Z-Strip mounting system

### Notes

- Half width tackboards can be specified and combined with Marker Board, Slat Wall and Glass Board options. See "Half Width" items under product width.
- Specify right or left facing tackboard
- Fabric Tack Panels are raised 3" from bottom edge when TM50 grommet is ordered

## Capitol park tackboards.

Overhead dry marker board  
Full width dry marker board

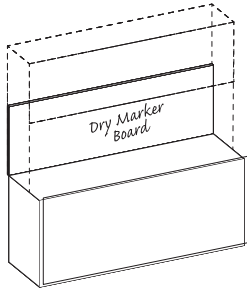

Product Width	Panel Dimension	SKU	List
94	91 x .5 x 21	DMOC9121	1136
88	85 x .5 x 21	DMOC8521	1061
84	81 x .5 x 21	DMOC8121	1011
77	74 x .5 x 21	DMOC7421	924
71	68 x .5 x 21	DMOC6821	849
65	62 x .5 x 21	DMOC6221	774
59	56 x .5 x 21	DMOC5621	699
48	45 x .5 x 21	DMOC4521	587
36	33 x .5 x 21	DMOC3321	437
30	27 x .5 x 21	DMOC2721	337

### Standard Features

- Dry marker panel has edge trim molding
- Standard magnetic surface
- Hung with Z-Strip mounting system

Overhead dry marker board  
Half width dry marker board

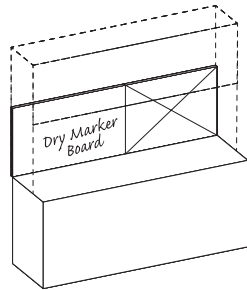

Product Width	Panel Dimension	SKU	List
94 Half Width	45.5 x .5 x 21	DMOC4521	555
88 Half Width	42.5 x .5 x 21	DMOC4221	518
84 Half Width	40.5 x .5 x 21	DMOC4021	493
77 Half Width	37 x .5 x 21	DMOC3721	449
71 Half Width	34 x .5 x 21	DMOC3421	437
65 Half Width	31 x .5 x 21	DMOC3121	374

### Standard Features

- Dry marker panel has edge trim molding
- Standard magnetic surface
- Hung with Z-Strip mounting system

### Notes

- Half width dry marker boards can be specified and combined with a Tackboard, Veneer Panel, Slat Wall or Glass Board. See "Half Width" items under product width.
- Specify right or left facing dry marker board

## Capitol park tackboards.

Overhead glassboard  
Full width glassboard

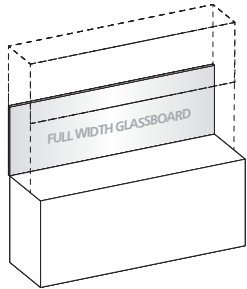

Product Width	Panel Dimension	SKU	List
94	91 x .5 x 21	GBOC9121	2382
88	85 x .5 x 21	GBOC8521	2236
84	81 x .5 x 21	GBOC8121	2138
77	74 x .5 x 21	GBOC7421	1969
71	68 x .5 x 21	GBOC6821	1822
65	62 x .5 x 21	GBOC6221	1676
59	56 x .5 x 21	GBOC5621	1531
48	45 x .5 x 21	GBOC4521	1264
36	33 x .5 x 21	GBOC3321	972
30	27 x .5 x 21	GBOC2721	826

### Standard Features

- 4 mm tempered glass
- Hung with Z-Strip mounting system

### Notes

- Use glass cleaner or alcohol to clean
- Standard dry erase markers may be used
- Earth magnets are required to hold items securely in place

Overhead glassboard  
Half width glassboard

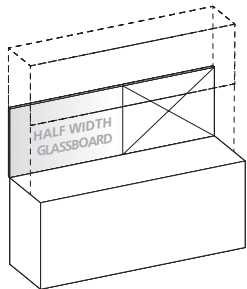

Product Width	Panel Dimension	SKU	List
94 Half Width	45.5 x .5 x 21	GBOC4521	1251
88 Half Width	42.5 x .5 x 21	GBOC4221	1178
84 Half Width	40.5 x .5 x 21	GBOC4021	1129
77 Half Width	37 x .5 x 21	GBOC3721	985
71 Half Width	34 x .5 x 21	GBOC3421	972
65 Half Width	31 x .5 x 21	GBOC3121	899

### Standard Features

- 4 mm tempered glass
- Hung with Z-Strip mounting system

### Notes

- Half width glassboards can be specified and combined with a Tackboard, Veneer panel, Marker Board or Slat Wall. See "Half Width" items under product width.
- Specify right or left facing glassboard
- Use glass cleaner or alcohol to clean
- Standard dry erase markers may be used
- Earth magnets are required to hold items securely in place



## Capitol park tackboards.

Overhead slat wall  
Half width slat wall

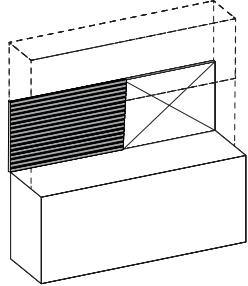

Product Width	Panel Dimension	SKU	List
94 Half Width	45.5 x .5 x 21	SWOC4521	463
88 Half Width	42.5 x .5 x 21	SWOC4221	432
84 Half Width	40.5 x .5 x 21	SWOC4021	411
77 Half Width	37 x .5 x 21	SWOC3721	374
71 Half Width	34 x .5 x 21	SWOC3421	343
65 Half Width	31 x .5 x 21	SWOC3121	312

### Standard Features

- Available in silver or black
- For use on 42"/43" height consoles
- Specify right or left facing slat wall
- Hung with Z-Strip mounting system

### Notes

- Half width slat walls can be specified and combined with a Tackboard, Veneer panel, Marker Board or Glassboard. See "Half Width" items under product width.
- Specify right or left facing slat wall
- For use on 42"/43" height consoles
- Specify right or left facing slat wall

# Capitol park.

Single Height Wall Hung Overheads  
Panel Doors - 6/4/2 Door

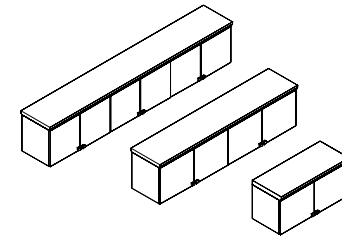

## 1 Select a model w" x d" x h"

weight	Standard Veneer Top Standard Veneer Chassis		Premium Veneer Top Premium Veneer Chassis		High Pressure Laminate Top Veneer Chassis		Thermally Fused Laminate Top Thermally Fused Laminate Chassis	
<b>6 Door</b>								
93 x 15 x 19	240	CAP9319WH330W 4166	"M" Option N/A	"P" Option N/A	"G" Option N/A	"M" Option N/A	"M" Option N/A	
87 x 15 x 19	225	CAP8719WH330W 3964	"P" Option N/A	"P" Option N/A	"G" Option N/A	"M" Option N/A	"M" Option N/A	
<b>4 Door</b>								
83 x 15 x 19	210	CAP8319WH330W 3444	"P" Option N/A	"P" Option N/A	"G" Option N/A	"M" Option N/A	"M" Option N/A	
76 x 15 x 19	195	CAP7619WH330W 3274	"P" Option N/A	"P" Option N/A	"G" Option N/A	"M" Option N/A	"M" Option N/A	
70 x 15 x 19	180	CAP7019WH330W 3105	"P" Option N/A	"P" Option N/A	"G" Option N/A	"M" Option N/A	"M" Option N/A	
64 x 15 x 19	160	CAP6419WH330W 2878	"P" Option N/A	"P" Option N/A	"G" Option N/A	"M" Option N/A	"M" Option N/A	
58 x 15 x 19	135	CAP5819WH330W 2591	"P" Option N/A	"P" Option N/A	"G" Option N/A	"M" Option N/A	"M" Option N/A	
47 x 15 x 19	125	CAP4719WH330W 2258	"P" Option N/A	"P" Option N/A	"G" Option N/A	"M" Option N/A	"M" Option N/A	
<b>2 Door</b>								
35 x 15 x 19	75	CAP3519WH330W 1686	"P" Option N/A	"P" Option N/A	"G" Option N/A	"M" Option N/A	"M" Option N/A	
29 x 15 x 19	65	CAP2919WH330W 1641	"P" Option N/A	"P" Option N/A	"G" Option N/A	"M" Option N/A	"M" Option N/A	
23 x 15 x 19	55	CAP2319WH330W 1601	"P" Option N/A	"P" Option N/A	"G" Option N/A	"M" Option N/A	"M" Option N/A	

[View statement of line](#)

## 2 Select a finish [View finish details](#)

- WAC
- WRC
- WIC
- WHC
- WOC
- WEW
- WGW
- WBW
- WSW
- WNW

## 3 Select an edge [View edge details](#)



Capitol

## 4 Select hardware [View hardware details](#)



DK-125 Antique Pewter  
DK-126 Antique English  
DK-127 Matte Black



DK-128 Antique Pewter

## Product features.

- Doors are a matched set
- Finished top
- Interior cabinet depth 12"
- Mounting rail included
- Top shaped on front only
- Veneer interior "W" Option only

## Options.

### DOOR

- D2: Door Lock - \$100 per door set
- D6: Delete Doors - n/c
- D9SC: Soft Close Door Hinges - \$20 per door

### TASK LIGHTING (RECESSED)

Overhead tasklight cord is located on the right facing side. If the opposite location is required please contact customer service.

- LT-LED24R: 24" LED Task light - \$190
- LT-LED48R: 48" LED Task light - \$245
- LT-LED60R: 60" LED Task light - \$310
- LT-LED72R: 72" LED Task light - \$335
- LC24: Linking Task light cable - \$25

## Capitol park tackboards.

Wall hung tackboard  
Full width tackboards

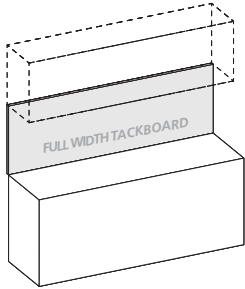

Product Width	Panel Dimension	SKU	COM	1	2	3	4	5	6	7	8	9	10	11/L1	12	13/L2
93	93 x .75 x 24	FTWH9324	465	576	627	678	729	780	831	882	933	984	1035	1086	1137	1239
87	87 x .75 x 24	FTWH8724	448	539	587	635	683	731	779	827	875	923	971	1019	1067	1163
83	83 x .75 x 24	FTWH8324	422	514	560	606	652	698	744	790	836	882	928	974	1020	1112
76	76 x .75 x 24	FTWH7624	388	471	514	557	600	643	686	729	772	815	858	901	944	1030
70	70 x .75 x 24	FTWH7024	355	434	474	514	554	594	634	674	714	754	794	834	874	954
64	64 x .75 x 24	FTWH6424	322	396	432	468	504	540	576	612	648	684	720	756	792	864
58	58 x .75 x 24	FTWH5824	294	359	391	423	455	487	519	551	583	615	647	679	711	775
47	47 x .75 x 24	FTWH4724	236	291	318	345	372	399	426	453	480	507	534	561	588	642
35	35 x .75 x 24	FTWH3524	176	217	237	257	277	297	317	337	357	377	397	417	437	477
29	29 x .75 x 24	FTWH2924	142	179	196	213	230	247	264	281	298	315	332	349	366	400

### Standard Features

- Constructed of .875" thick fiberboard
- Fabric is precisely aligned and fitted to the tackboard
- Adhered to the rigid hardboard with staples
- Hung with Z-Strip mounting system

Wall hung tackboard  
Half width tackboards

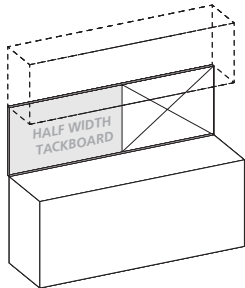

Product Width	Panel Dimension	SKU	COM	1	2	3	4	5	6	7	8	9	10	11/L1	12	13/L2
93 Half Width	46.5 x .75 x 24	FTWH4624	233	288	313	338	363	388	413	438	463	488	513	538	563	613
87 Half Width	43.5 x .75 x 24	FTWH4324	225	270	294	318	342	366	390	414	438	462	486	510	534	582
83 Half Width	41.5 x .75 x 24	FTWH4124	211	257	280	303	326	349	372	395	418	441	464	487	510	556
76 Half Width	38 x .75 x 24	FTWH3824	194	235	256	277	298	319	340	361	382	403	424	445	466	508
70 Half Width	35 x .75 x 24	FTWH3524	178	217	237	257	277	297	317	337	357	377	397	417	437	477
64 Half Width	32 x .75 x 24	FTWH3224	161	198	216	234	252	270	288	306	324	342	360	378	396	432

### Standard Features

- Constructed of .875" thick fiberboard
- Fabric is precisely aligned and fitted to the tackboard
- Adhered to the rigid hardboard with staples
- Hung with Z-Strip mounting system

### Notes

- Half width tackboards can be specified and combined with a Veneer Panel, Marker Board, Slat Wall or Glass Board. See "Half Width" items under product width.
- Specify right or left facing tackboard

## Capitol park tackboards.

Wall hung dry marker board  
Full width dry marker board

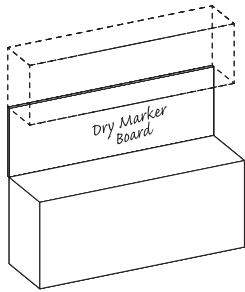

Product Width	Panel Dimension	SKU	List
93	93 x .75 x 24	DMWH9324	1161
87	87 x .75 x 24	DMWH8724	1086
83	83 x .75 x 24	DMWH8324	1023
76	76 x .75 x 24	DMWH7624	948
70	70 x .75 x 24	DMWH7024	874
64	64 x .75 x 24	DMWH6424	799
58	58 x .75 x 24	DMWH5824	724
47	47 x .75 x 24	DMWH4724	587
35	35 x .75 x 24	DMWH3524	437
29	29 x .75 x 24	DMWH2924	362

### Standard Features

- Dry marker panel has edge trim molding
- Standard magnetic surface
- Hung with Z-Strip mounting system

Wall hung dry marker board  
Half width dry marker board

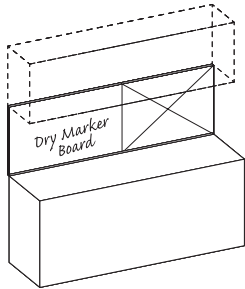

Product Width	Panel Dimension	SKU	List
93 Half Width	46.5 x .75 x 24	DMWH4624	580
87 Half Width	43.5 x .75 x 24	DMWH4324	543
83 Half Width	41.5 x .75 x 24	DMWH4124	518
76 Half Width	38 x .75 x 24	DMWH3824	474
70 Half Width	35 x .75 x 24	DMWH3524	437
64 Half Width	32 x .75 x 24	DMWH3224	399

### Standard Features

- Dry marker panel has edge trim molding
- Standard magnetic surface
- Hung with Z-Strip mounting system

### Notes

- Half width dry marker boards can be specified and combined with a Tackboard, Veneer Panel, Slat Wall or Glass Board. See "Half Width" items under product width.
- Specify right or left facing dry marker board

## Capitol park tackboards.

Wall hung veneer panel  
Full width veneer panel

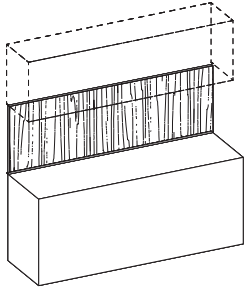

Product Width	Panel Dimension	SKU	List
93	93 x .75 x 24	VPWH9324	967
87	87 x .75 x 24	VPWH8724	905
83	83 x .75 x 24	VPWH8324	853
76	76 x .75 x 24	VPWH7624	790
70	70 x .75 x 24	VPWH7024	728
64	64 x .75 x 24	VPWH6424	666
58	58 x .75 x 24	VPWH5824	603
47	47 x .75 x 24	VPWH4724	489
35	35 x .75 x 24	VPWH3524	364
29	29 x .75 x 24	VPWH2924	302

### Standard Features

- Veneer edges
- Vertical wire channels on back for task light cords
- Hung with Z-Strip mounting system

### Notes

- Steel mounting wall channel is recessed for flush mounting
- Can be used with or without overhead cabinet
- Required for other accessory panels

Wall hung veneer panel  
Half width veneer panel

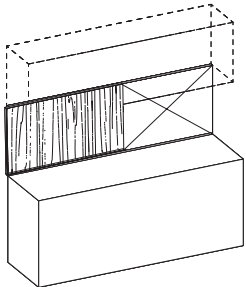

Product Width	Panel Dimension	SKU	List
93 Half Width	46.5 x .75 x 24	VPWH4624	484
87 Half Width	43.5 x .75 x 24	VPWH4324	452
83 Half Width	41.5 x .75 x 24	VPWH4124	432
76 Half Width	38 x .75 x 24	VPWH3824	395
70 Half Width	35 x .75 x 24	VPWH3524	364
64 Half Width	32 x .75 x 24	VPWH3224	333

### Standard Features

- Veneer edges.
- Vertical wire channels on back for task light cords
- Steel mounting wall channel is recessed for flush mounting
- Hung with Z-Strip mounting system

### Notes

- Half width veneer panels can be specified and combined with a Tackboard, Marker Board, Slat Wall or Glass Board. See "Half Width" items under product width.
- Specify right or left facing veneer panel
- Can be used with or without overhead cabinet
- Required for other accessory panels

## Capitol park tackboards.

Wall hung glassboard  
Full width glassboards

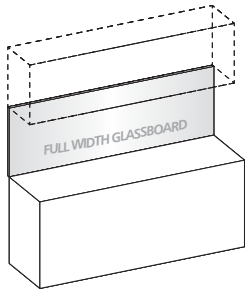

Product Width	Panel Dimension	SKU	List
93	93 x .75 x 24	GBWH9324	2753
87	87 x .75 x 24	GBWH8724	2586
83	83 x .75 x 24	GBWH8324	2475
76	76 x .75 x 24	GBWH7624	2281
70	70 x .75 x 24	GBWH7024	2114
64	64 x .75 x 24	GBWH6424	1948
58	58 x .75 x 24	GBWH5824	1780
47	47 x .75 x 24	GBWH4724	1476
35	35 x .75 x 24	GBWH3524	1142
29	29 x .75 x 24	GBWH2924	976

### Standard Features

- 4 mm tempered glass
- Hung with Z-Strip mounting system

### Notes

- Use glass cleaner or alcohol to clean
- Standard dry erase markers may be used
- Earth magnets are required to hold items securely in place

Wall hung glassboard  
Half width glassboards

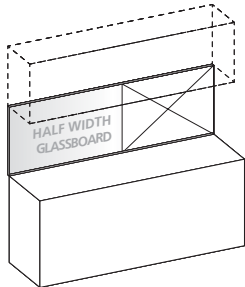

93 Half Width	46.5 x .75 x 24	GBWH4624	1461
87 Half Width	43.5 x .75 x 24	GBWH4324	1378
83 Half Width	41.5 x .75 x 24	GBWH4124	1323
76 Half Width	38 x .75 x 24	GBWH3824	1232
70 Half Width	35 x .75 x 24	GBWH3524	1142
64 Half Width	32 x .75 x 24	GBWH3224	1059

### Standard Features

- 4 mm tempered glass
- Hung with Z-Strip mounting system

### Notes

- Half width glassboards can be specified and combined with a Tackboard, Veneer panel, Marker Board or Slat Wall. See "Half Width" items under product width.
- Specify right or left facing glassboard
- Use glass cleaner or alcohol to clean
- Standard dry erase markers may be used
- Earth magnets are required to hold items securely in place

## Capitol park tackboards.

Wall hung slat wall  
*half width slat wall*

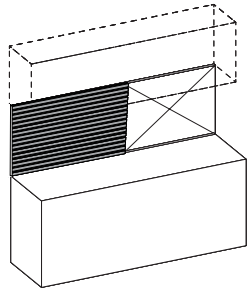

Product Width	Panel Dimension	SKU	List
93 Half Width	46.5 x .75 x 24	SWWH4624	484
87 Half Width	43.5 x .75 x 24	SWWH4324	452
83 Half Width	41.5 x .75 x 24	SWWH4124	432
76 Half Width	38 x .75 x 24	SWWH3824	395
70 Half Width	35 x .75 x 24	SWWH3524	364
64 Half Width	32 x .75 x 24	SWWH3224	333

### Standard Features

- Available in silver or black
- Hung with Z-Strip mounting system

### Notes

- Half width slat walls can be specified and combined with a Tackboard, Veneer panel, Marker Board or Glassboard. See "Half Width" items under product width.
- Specify right or left facing slat wall
- For use on 42"/43" height consoles

# Capitol park.

Sit-On Tower Extension  
Panel Door - Full Storage

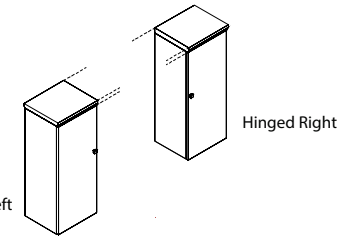





[View statement of line](#)

1 Select a model w" x d" x h"	weight	Standard Veneer Top Standard Veneer Chassis		Premium Veneer Top Premium Veneer Chassis		High Pressure Laminate Top Veneer Chassis		Thermally Fused Laminate Top Thermally Fused Laminate Chassis	
		<b>Hinged Left</b> 17.5 x 15 x 43 14.5 x 15 x 43	80 75	CAP1743OH340W CAP1443OH340W	1745 1682	"P" Option N/A "P" Option N/A		"G" Option N/A "G" Option N/A	
<b>Hinged Right</b> 17.5 x 15 x 43 14.5 x 15 x 43	80 75	CAP1743OH341W CAP1443OH341W	1745 1682	"P" Option N/A "P" Option N/A		"G" Option N/A "G" Option N/A		"M" Option N/A "M" Option N/A	

2 Select a finish <a href="#">View finish details</a>	WAC WRC WIC WHC WOC WEW WGW WBW WSW WNW	
		Capitol 

4 Select hardware <a href="#">View hardware details</a>	  			
		DK-125 Antique Pewter DK-126 Antique English DK-127 Matte Black		DK-128 Antique Pewter

## Product features.

- 2 adjustable wood shelves
- Finished top
- Interior shelf depth 12"
- Top shaped on front only

### NOTES

- Unit has black back panel and is not designed for Open Plan use.
- Select OPB Option for Open Plan application

## Options.

### DOOR

- D2: Door Lock - \$100 per door
- D6: Delete Doors - n/c
- D9SC: Soft Close Door Hinges - \$20 per door

### INTERIOR CABINET LIGHTING

- LEDPK starter kit includes Infeed, 1 Puck Interior Light and the ability to daisy chain up to 6 total Puck Lights
- LEDPK: LED Puck Starter Kit - \$310
- PK: 1 LED Interior Light - \$130

### OPEN PLAN – FINISHED BACK

- OPB: "W" "G" Style - Modify Unit for Open Plan Application - \$395

### SHELVES

- GS14H: Replace Standard Shelves with Glass Shelf - \$70 per shelf



# Capitol park.

Sit-On Tower Extension

Wood Framed Door/Clear Glass Insert - Full Storage

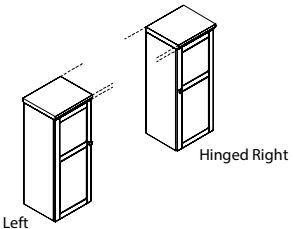

Hinged Left

Hinged Right

[View statement of line](#)

1 Select a model w" x d" x h"	weight	Standard Veneer Top Standard Veneer Chassis		Premium Veneer Top Premium Veneer Chassis		High Pressure Laminate Top Veneer Chassis		Thermally Fused Laminate Top Thermally Fused Laminate Chassis	
		<b>Hinged Left</b> 17.5 x 15 x 43 14.5 x 15 x 43	80 75	CAP1743OH342W CAP1443OH342W	1882 1817	"P" Option N/A "P" Option N/A	"G" Option N/A "G" Option N/A	"M" Option N/A "M" Option N/A	"M" Option N/A "M" Option N/A
<b>Hinged Right</b> 17.5 x 15 x 43 14.5 x 15 x 43	80 75	CAP1743OH343W CAP1443OH343W	1882 1817	"P" Option N/A "P" Option N/A	"G" Option N/A "G" Option N/A	"M" Option N/A "M" Option N/A	"M" Option N/A "M" Option N/A	"M" Option N/A "M" Option N/A	

2 Select a finish <a href="#">View finish details</a>	WAC WRC WIC WHC WOC WEW WGW WBW WSW WNW	
	3 Select a edge <a href="#">View edge details</a>	Capitol

4 Select hardware <a href="#">View hardware details</a>	DK-125 Antique Pewter DK-126 Antique English DK-127 Matte Black		DK-128 Antique Pewter	

## Product features.

- 2 adjustable wood shelves
- Finished top
- Interior shelf depth 12"
- Top shaped on front only

### NOTES

- Unit has black back panel and is not designed for Open Plan use.
- Select OPB Option for Open Plan application

## Options.

### DOOR

- D2-G: Door Lock for Glass Doors - \$205 per door set
- D9SC: Soft Close Door Hinges - \$20 per door

### INTERIOR CABINET LIGHTING

- LEDPK starter kit includes Infeed, 1 Puck Interior Light and the ability to daisy chain up to 6 total Puck Lights
- LEDPK: LED Puck Starter Kit - \$310
- PK: 1 LED Interior Light - \$130

### OPEN PLAN – FINISHED BACK

- OPB: "W" "G" Style - Modify Unit for Open Plan Application - \$395

### SHELVES

- GS14H: Replace Standard Shelves with Glass Shelf - \$70 per shelf

# Capitol park.

Sit-On Bookcase Console  
Panel Door

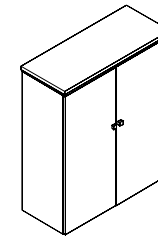





1 Select a model w" x d" x h"	weight	Standard Veneer Top Standard Veneer Chassis		Premium Veneer Top Premium Veneer Chassis		High Pressure Laminate Top Veneer Chassis		Thermally Fused Laminate Top Thermally Fused Laminate Chassis	
		36 x 15 x 43 30 x 15 x 43	150 130	CAP3643OH383W CAP3043OH383W	2286 2188	"P" Option N/A "P" Option N/A		"G" Option N/A "G" Option N/A	

2 Select a finish <a href="#">View finish details</a>	WAC WRC WIC WHC WOC WEW WGW WBW WSW WNW	
		 Capitol

4 Select hardware <a href="#">View hardware details</a>	 DK-125 Antique Pewter  DK-126 Antique English  DK-127 Matte Black		 DK-128 Antique Pewter	

[View statement of line](#)

## Product features.

- 2 adjustable wood shelves
- Finished top
- Interior shelf depth 12"
- Top shaped on 3 sides

### NOTES

- Unit has black back panel and is not designed for Open Plan use.
- Select OPB Option for Open Plan application

## Options.

### DOOR

- D2: Door Lock - \$100 per door set
- D6: Delete Doors - n/c
- D9SC: Soft Close Door Hinges - \$20 per door

### FLUSH CUT

- FC-B: Flush Unit Both Sides(Facing) for Ganging - \$100
- FC-L: Flush Unit Left (Facing) for Ganging - \$100
- FC-R: Flush Unit Right(Facing) for Ganging - \$100

### INTERIOR CABINET LIGHTING

- LEDPK starter kit includes Infeed, 1 Puck Interior Light and the ability to daisy chain up to 6 total Puck Lights
- LEDPK: LED Puck Starter Kit - \$310
- PK: 1 LED Interior Light - \$130

### OPEN PLAN – FINISHED BACK

- OPB: "W" "G" Style - Modify Unit for Open Plan Application - \$395



### SHELVES

- GS14F: Replace Standard Shelves with Glass Shelves - \$90 per shelf
- S714F: Heavy Duty Lumber 1" Shelves - \$80 per shelf ("M" Styles - n/a)

# Capitol park.

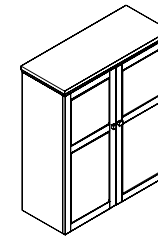
Sit-On Bookcase Console  
Frame Door With Clear Glass



1 Select a model w" x d" x h"	weight	Standard Veneer Top Standard Veneer Chassis		Premium Veneer Top Premium Veneer Chassis		High Pressure Laminate Top Veneer Chassis		Thermally Fused Laminate Top Thermally Fused Laminate Chassis	
		36 x 15 x 43 30 x 15 x 43	150 130	CAP3643OH381W CAP3043OH381W	2969 2870	"P" Option N/A "P" Option N/A		"G" Option N/A "G" Option N/A	
2 Select a finish <a href="#">View finish details</a>		WAC WRC WIC WHC WOC WEW WGW WBW WSW WNW							
3 Select a edge <a href="#">View edge details</a>		 Capitol							
4 Select hardware <a href="#">View hardware details</a>		 DK-125 Antique Pewter DK-126 Antique English DK-127 Matte Black							

[View statement of line](#)

## Product features.

- 2 adjustable wood shelves
- Finished top
- Interior shelf depth 12"
- Top shaped on 3 sides

### NOTES

- Unit has black back panel and is not designed for Open Plan use.
- Select OPB Option for Open Plan application

## Options.

### DOOR

- D2-G: Door Lock for Glass Doors - \$205 per door set
- D9SC: Soft Close Door Hinges - \$20 per door

### FLUSH CUT

- FC-B: Flush Unit Both Sides(Facing) for Ganging - \$100
- FC-L: Flush Unit Left (Facing) for Ganging - \$100
- FC-R: Flush Unit Right(Facing) for Ganging - \$100

### INTERIOR CABINET LIGHTING

- LEDPK starter kit includes Infeed, 1 Puck Interior Light and the ability to daisy chain up to 6 total Puck Lights
- LEDPK: LED Puck Starter Kit - \$310
- PK: 1 LED Interior Light - \$130

### OPEN PLAN – FINISHED BACK

- OPB: "W" "G" Style - Modify Unit for Open Plan Application - \$395

### SHELVES

- GS14F: Replace Standard Shelves with Glass Shelves - \$90 per shelf
- S714F: Heavy Duty Lumber 1" Shelves - \$80 per shelf ("M" Styles - n/a)

# Capitol park.

Half Towers

Half Wardrobe - Left/Right Hinge

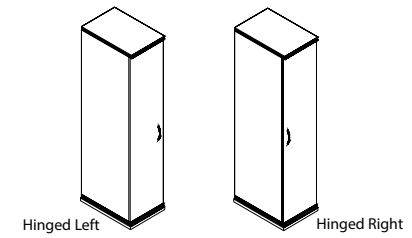

## 1 Select a model

weight	Standard Veneer Top Standard Veneer Chassis	Premium Veneer Top Premium Veneer Chassis	High Pressure Laminate Top Veneer Chassis	Thermally Fused Laminate Top Thermally Fused Laminate Chassis
<b>Hinged Left</b> 16 x 24 x 72	155 CAP1672TW283W 3073	"P" Option N/A	"G" Option N/A	"M" Option N/A
<b>Hinged Right</b> 16 x 24 x 72	155 CAP1672TW284W 3073	"P" Option N/A	"G" Option N/A	"M" Option N/A

[View statement of line](#)

## 2 Select a finish

[View finish details](#)

- WAC
- WRC
- WIC
- WHC
- WOC
- WEW
- WGW
- WBW
- WSW
- WNW

## 3 Select a edge

[View edge details](#)



## 4 Select hardware

[View hardware details](#)

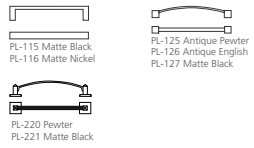

## Product features.

- 1 Fixed shelf
- 3 Adjustable shelves
- Finished top
- Top shaped on front and sides
- Wardrobe w/ coat rod & hook
- Panel door w/ pull
- Hardwood base w/ mitred corners

### NOTES

- Unit has black back panel and is not designed for Open Plan use.
- Select OPB Option for Open Plan application

## Options.

### DOOR

- D2: Door Lock - \$100 per door
- D6: Delete Doors - n/c
- D9SC: Soft Close Door Hinges - \$20 per door

### FLUSH CUT

- FC-B: Flush Unit Both Sides(Facing) for Ganging - \$100
- FC-L: Flush Unit Left (Facing) for Ganging - \$100
- FC-R: Flush Unit Right(Facing) for Ganging - \$100

### OPEN PLAN – FINISHED BACK

- OPB: "W" "G" Style - Modify Unit for Open Plan Application - \$395

Capitol park.  
Full Towers  
Full Wardrobe

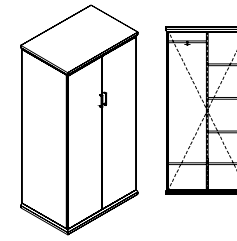

1 Select a model  
w" x d" x h"

weight

Standard Veneer Top Standard Veneer Chassis	Premium Veneer Top Premium Veneer Chassis	High Pressure Laminate Top Veneer Chassis	Thermally Fused Laminate Top Thermally Fused Laminate Chassis
--	--	--	--

36 x 24 x 72	285	CAP3672TW275W	4746	"P" Option N/A	"G" Option N/A	"M" Option N/A
30 x 24 x 72	240	CAP3072TW275W	4546	"P" Option N/A	"G" Option N/A	"M" Option N/A

[View statement of line](#)

2 Select a finish  
[View finish details](#)

- WAC
- WRC
- WIC
- WHC
- WOC
- WEW
- WGW
- WBW
- WSW
- WNW

3 Select a edge  
[View edge details](#)



4 Select hardware  
[View hardware details](#)

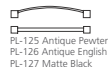

## Product features.

- 2 Fixed shelves
- 3 Adjustable shelves
- Finished top
- Hardwood base w/ mitred corners
- Top shaped on front and sides
- Wardrobe w/ coat rod & hook
- Panel doors w/ pulls

**NOTES**

- Unit has black back panel and is not designed for Open Plan use.
- Select OPB Option for Open Plan application

## Options.

**DELETE CENTER PARTITION**

- MOD31: Delete center partition & Add 3 full width shelves, 1 fixed - \$295

When deleting center partition (1) D2 Door lock should be specified

**DOOR**

- D2: Door Lock - \$100 per door
- D6: Delete Doors - n/c
- D9SC: Soft Close Door Hinges - \$20 per door

**FLUSH CUT**

- FC-B: Flush Unit Both Sides(Facing) for Ganging - \$100
- FC-L: Flush Unit Left (Facing) for Ganging - \$100
- FC-R: Flush Unit Right(Facing) for Ganging - \$100

**OPEN PLAN – FINISHED BACK**

- OPB: "W" "G" Style - Modify Unit for Open Plan Application - \$395

Capitol park.  
Full Towers  
2 Lateral File / Wardrobe

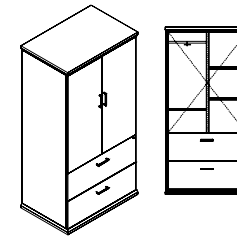



1 Select a model w" x d" x h"	weight	Standard Veneer Top Standard Veneer Chassis		Premium Veneer Top Premium Veneer Chassis		High Pressure Laminate Top Veneer Chassis		Thermally Fused Laminate Top Thermally Fused Laminate Chassis	
		36 x 24 x 72 30 x 24 x 72	310 280	CAP3672TW281W CAP3072TW281W	5019 4819	"P" Option N/A "P" Option N/A		"G" Option N/A "G" Option N/A	

2 Select a finish <i>View finish details</i>	WAC WRC WIC WHC WOC WEW WGW WBW WSW WNW	
	3 Select a edge <i>View edge details</i>	 Capitol

4 Select hardware <i>View hardware details</i>	 PL-115 Matte Black PL-116 Matte Nickel PL-125 Antique Pewter PL-126 Antique English PL-127 Matte Black	
		 PL-220 Pewter PL-221 Matte Black

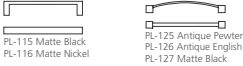
*View statement of line*

**Product features.**

- 3 Adjustable shelves
- Finished top
- Hardwood base w/ mitred corners
- Top shaped on front and sides
- Wardrobe w/ coat rod & hook
- Panel doors w/ pulls

**NOTES**

- Double letter filing front to back
- Legal filing side to side
- Unit has black back panel and is not designed for Open Plan use.  
Select OPB Option for Open Plan application

**Options.**

**DOOR**

- D2: Door Lock - \$100 per door
- D6: Delete Doors - n/c
- D9SC: Soft Close Door Hinges - \$20 per door

**DRAWER**

- P33: Wood Drawer Upgrade - \$45 per drawer

**FLUSH CUT**

- FC-B: Flush Unit Both Sides(Facing) for Ganging - \$100
- FC-L: Flush Unit Left (Facing) for Ganging - \$100
- FC-R: Flush Unit Right(Facing) for Ganging - \$100

**OPEN PLAN – FINISHED BACK**

- OPB: "W" "G" Style - Modify Unit for Open Plan Application - \$395

**SHELVES**

- MOD30: Delete center partition & Add 2 full width shelves - \$195

# Capitol park.

Freestanding Bookcases  
Open Bookcases

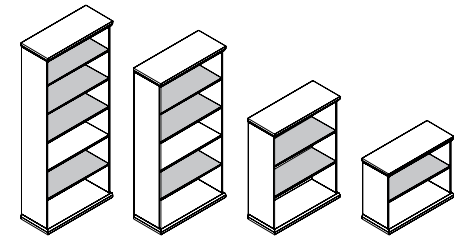

## 1 Select a model w" x d" x h"

weight	Standard Veneer Top Standard Veneer Chassis	Premium Veneer Top Premium Veneer Chassis	High Pressure Laminate Top Veneer Chassis	Thermally Fused Laminate Top Thermally Fused Laminate Chassis
<b>36" Width</b>				
36 x 15 x 84	200 CAP3684BK250W 2494	"P" Option N/A	"G" Option N/A	"M" Option N/A
36 x 15 x 72	175 CAP3672BK250W 2286	"P" Option N/A	"G" Option N/A	"M" Option N/A
36 x 15 x 48	120 CAP3648BK250W 2149	"P" Option N/A	"G" Option N/A	"M" Option N/A
36 x 15 x 30.75	95 CAP3630BK250W 1947	"P" Option N/A	"G" Option N/A	"M" Option N/A
<b>30" Width</b>				
30 x 15 x 84	180 CAP3084BK250W 2358	"P" Option N/A	"G" Option N/A	"M" Option N/A
30 x 15 x 72	155 CAP3072BK250W 2149	"P" Option N/A	"G" Option N/A	"M" Option N/A
30 x 15 x 48	105 CAP3048BK250W 2052	"P" Option N/A	"G" Option N/A	"M" Option N/A
30 x 15 x 30.75	85 CAP3030BK250W 1875	"P" Option N/A	"G" Option N/A	"M" Option N/A

[View statement of line](#)

## 2 Select a finish [View finish details](#)

- WAC
- WRC
- WIC
- WHC
- WOC
- WEW
- WGW
- WBW
- WSW
- WNW

## 3 Select a edge [View edge details](#)



## 4 Select hardware [View hardware details](#)

Hardware  
N/A

## Product features.

- 1 Fixed shelf on 84" & 72"
- Interior shelf depth 12"
- Hardwood base w/ mitred corners
- Top shaped 3 sides
- "W" styles - 30", 48", and 72" H units finished top, 84" H units black painted top

### NOTES

- \*29"H Open Bookcases are NOT meant to gang with desks, returns and credenzas.
- 12" Deep Shelves
- Unit has black back panel and is not designed for Open Plan use. Select OPB Option for Open Plan application
- 30.75"H Open Bookcases are NOT meant to gang with desks, returns and credenzas. Unit is higher than regular worksurfaces to allow double binder storage. If matching height is desired, choose CAP-3624CA125W or CAP3024CA125W with D6A option

## Options.

### FLUSH CUT

- FC-B: Flush Unit Both Sides(Facing) for Ganging - \$100
- FC-L: Flush Unit Left (Facing) for Ganging - \$100
- FC-R: Flush Unit Right(Facing) for Ganging - \$100

### INTERIOR CABINET LIGHTING

- LEDPK starter kit includes Infeed, 1 Puck Interior Light and the ability to daisy chain up to 6 total Puck Lights
- LEDPK: LED Puck Starter Kit - \$310
- PK: 1 LED Interior Light - \$130

### OPEN PLAN – FINISHED BACK

- OPB: "W" "G" Style - Modify Unit for Open Plan Application - \$395

### SHELVES

- GS14F: Replace Standard Shelves with Glass Shelves - \$90 per shelf
- S714F: Heavy Duty Lumber 1" Shelves - \$80 per shelf ("M" Styles - n/a)

# Capitol park.

Freestanding Bookcases  
Bookcases W/ Doors

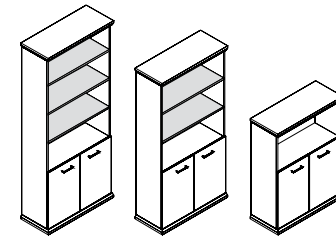

## 1 Select a model w" x d" x h"

weight	Standard Veneer Top Standard Veneer Chassis		Premium Veneer Top Premium Veneer Chassis		High Pressure Laminate Top Veneer Chassis		Thermally Fused Laminate Top Thermally Fused Laminate Chassis	
	<b>36" Width</b>							
36 x 15 x 84	210	CAP3684BK251W 2767	"P" Option N/A	"G" Option N/A	"M" Option N/A			
36 x 15 x 72	185	CAP3672BK251W 2558	"P" Option N/A	"G" Option N/A	"M" Option N/A			
36 x 15 x 48	130	CAP3648BK251W 2423	"P" Option N/A	"G" Option N/A	"M" Option N/A			
<b>30" Width</b>								
30 x 15 x 84	190	CAP3084BK251W 2630	"P" Option N/A	"G" Option N/A	"M" Option N/A			
30 x 15 x 72	165	CAP3072BK251W 2423	"P" Option N/A	"G" Option N/A	"M" Option N/A			
30 x 15 x 48	115	CAP3048BK251W 2324	"P" Option N/A	"G" Option N/A	"M" Option N/A			

[View statement of line](#)

## 2 Select a finish [View finish details](#)

- WAC
- WRC
- WIC
- WHC
- WOC
- WEW
- WGW
- WBW
- WSW
- WNW

## 3 Select a edge [View edge details](#)



## 4 Select hardware [View hardware details](#)

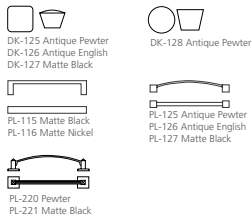

## Product features.

- 72" w/ 3 adj. shelves
- 84" w/ 4 adjustable shelves
- Hardwood base w/ mitered corners "W" option only.
- Interior shelf depth 12"
- Top shaped on 3 sides
- Panel doors w/ pulls
- "W" styles - 48", 72" H units finished top, 84" H units black painted top

### NOTES

- Unit has black back panel and is not designed for Open Plan use.
- Select OPB Option for Open Plan application

## Options.

### DOOR

- D2: Door Lock - \$100 per door set
- D9SC: Soft Close Door Hinges - \$20 per door

### FLUSH CUT

- FC-B: Flush Unit Both Sides(Facing) for Ganging - \$100
- FC-L: Flush Unit Left (Facing) for Ganging - \$100
- FC-R: Flush Unit Right(Facing) for Ganging - \$100

### INTERIOR CABINET LIGHTING

- LEDPK starter kit includes Infeed, 1 Puck Interior Light and the ability to daisy chain up to 6 total Puck Lights
- LEDPK: LED Puck Starter Kit - \$310
- PK: 1 LED Interior Light - \$130

### OPEN PLAN – FINISHED BACK

- OPB: "W" "G" Style - Modify Unit for Open Plan Application - \$395

### SHELVES

- GS14F: Replace Standard Shelves with Glass Shelves - \$90 per shelf
- S714F: Heavy Duty Lumber 1" Shelves - \$80 per shelf ("M" Styles - n/a)



## Capitol park options.



COMPUTER SUPPORT  
*single monitor arm*

Style Number	List Price
MA1	280

### Specifications

- Available in black or silver
- Desk clamp and mounting included
- Easy assembly and flexibility
- Elastic painting process for a durable and beautiful finish
- Gas spring tension adjustment for counter-balance height adjustment for monitors 1-8 KG
- Gas spring tested to 50,000 repetitions
- Hidden cable management



COMPUTER SUPPORT  
*double monitor arm*

Style Number	List Price
MA2	450

### Specifications

- Available in black or silver
- Desk clamp and mounting included
- Easy assembly and flexibility
- Elastic painting process for a durable and beautiful finish
- Gas spring tension adjustment for counter-balance height adjustment for monitors 1-8 KG
- Gas spring tested to 50,000 repetitions
- Hidden cable management



COMPUTER SUPPORT  
*triple monitor arm*

Style Number	List Price
MA3	530

### Specifications

- Available in black or silver
- Desk clamp and mounting included
- Easy assembly and flexibility
- Elastic painting process for a durable and beautiful finish
- Gas spring tension adjustment for counter-balance height adjustment for monitors 1-8 KG
- Gas spring tested to 50,000 repetitions
- Hidden cable management



COMPUTER SUPPORT  
*quadruple monitor arm*

Style Number	List Price
MA4	705

### Specifications

- Available in black
- Desk clamp and mounting included
- Easy assembly and flexibility
- Elastic painting process for a durable and beautiful finish
- Gas spring tension adjustment for counter-balance height adjustment for monitors 1-8 KG
- Gas spring tested to 50,000 repetitions
- Hidden cable management

## Capitol park options.

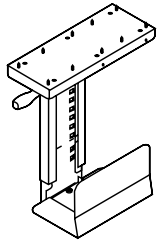

COMPUTER SUPPORT  
*cpu retractable cradle*

Style Number	List Price
K18	205

### Specifications

- Black Metal CPU Carriage
- Full 360° swivel capability allows easy access to rear of CPU for cables / wires
- Track allows 8- 1/2" extension
- Width Adjustment 5-1/2" to 9-1/4"
- Height adjustment 14- 5/8" to 20- 1/2"
- Black epoxy finish

- Notes
- Factory Installed

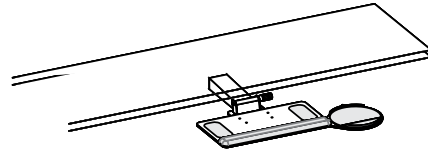

COMPUTER SUPPORT  
*articulating keyboard tray*

Style Number	List Price
Factory Installed K28	395
Field Installed K28F	415

### Specifications

- Adjusts effortlessly - A simple one-handed motion allows the keyboard to be repositioned instantly, without the use of locks or levers
- Encourages low-risk postures - Maximizes adjustability within a safe operating range.
- Will last a lifetime - Exceeds all applicable BIFMA Standards and comes with a lifetime guarantee.

- Notes
- Available on: Freestanding Desk
  - Factory Installed (standard)
  - FIELD INSTALL - \$415



DOOR MODIFICATIONS  
*soft close door hinge*

Style Number	List Price
D9SC	20 Per door

### Specifications

- Snap onto standard door hinge
- Requires (2) per door
- Max door height 43"
- Factory installed where specified
- Individually shipped for field installation

- Notes
- Specify Each Item To Have Slow Close Feature

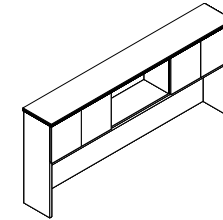

DOOR MODIFICATIONS  
*delete doors*

Style Number	List Price
D6	N/C

### Specifications

- Standard Door overheads and cabinets can have door deleted for open access. Modification of hinge rails and structural components are made face ready.

## Capitol park options.

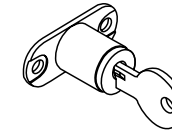
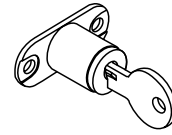
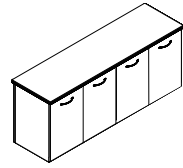
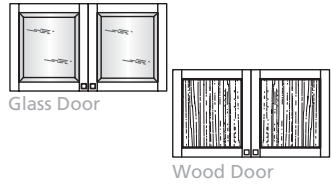

### DOOR MODIFICATIONS

*replace glass panel insert with veneer panel insert*

Style Number	List Price
D35	35 per door

### Specifications

- Replace glass panel insert with veneer panel insert

#### Notes

- Not Available on "M" skus
- Glass door has beveled glass
- Wood door w/ veneer insert - only available on "W" style

### DOOR MODIFICATIONS

*delete doors/replace black laminate shelf w/ finished shelf*

Style Number	List Price
D6A	N/C

### Specifications

- Delete doors and replace black laminate shelf with finished shelf

#### Notes

- Available on: All Storage "W"/"G" Style Credenzas.

### DOOR MODIFICATIONS

*panel door lock*

Style Number	List Price
D2	100 Per door set

### Specifications

- Door Locks - 1 Door w/ Lock, Other Door w/ Catch Latch  
 - Contact Customer Service regarding limited lock locations and keying.

#### Notes

- Available on: Panel Doors, Wood Frame Doors, and Silverluma doors

### DOOR MODIFICATIONS

*glass door lock*

Style Number	List Price
D2-G	205 Per door set

### Specifications

- Door Locks - 1 Door w/ Lock, Other Door w/ Catch Latch  
 - Contact Customer Service regarding limited lock locations and keying.

#### Notes

- Available on: Glass Doors

## Capitol park options.

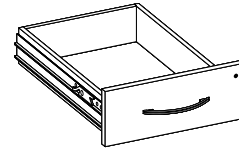
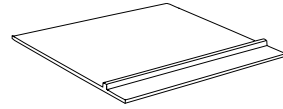
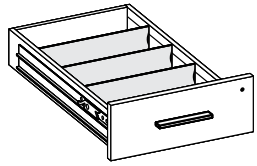

### DRAWER OPTIONS *box drawer accessories*

Style Number	List Price
Wood Drawer Dividers w/ Clips K-DIV	SET OF 3 - 30
Single Tray - Utility Tray K-Sut	35 ea.

### Specifications

- K-DIV Extra Wood Drawer Dividers with Clips, Top Box drawers standard with 1 divider
- K-SUT Single Tray - Utility Tray, Specify Legal or Letter drawer width

### DRAWER OPTIONS - BOTTOM COVER *felt bottom center drawer insert liner*

Style Number	List Price
K3	100

### Specifications

- Inserts into center drawer and features divider for open pen and pencil storage. Removable for easy cleaning.
- Adds a luxurious touch to center drawers.
- Color: Dark Brown Coal

### DRAWER OPTIONS - UPGRADE *wood drawer upgrade*

Style Number	List Price
P33	45 Per drawer

### Specifications

- Dowel joint construction
- Hardwood veneer multi-ply drawer
- UV finish
- 1/4" Wood veneer bottoms
- File drawer bottoms are five block reinforced for heavy weight capacity
- Lifetime guaranteed

### GLASSBOARD ACCESSORIES *glassboard accessory kit*

Style Number	List Price
GBKIT	290

### Specifications

- 8 Earth magnets, 1 magnetic marker cup holder and 1 magnetic dry eraser

## Capitol park options.

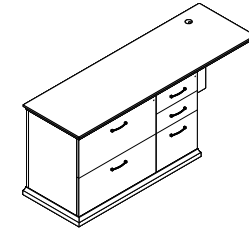
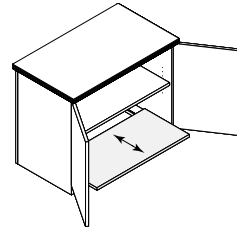
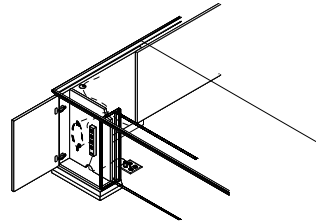
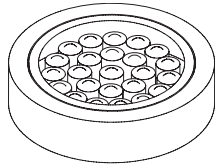

### LIGHTING

#### *led interior cabinet puck light*

Style Number	List Price
Starter Kit	
LEDPK	310
1 LED Interior Puck Light	
PK	130

### Specifications

- Starter kit includes Infeed, 1 Puck Interior Light and the ability to daisy chain up to 6 total Puck Lights
- (1) LED Puck Light with 30W power drive and switch
- Recessed fixture
- 12V linking cord 98"L
- Silver finish
- 50,000 hour life
- 2 watt per light

#### Notes

- Available on: Overhead/Tower Units with glass doors or no doors
- Power drive included, Light only

### PEDESTAL MODIFICATIONS

#### *breakfront pedestal with wire management cavity door*

Style Number	List Price
PC10	100
Power Supply Cordset	
PD717	100

### Specifications

- Hinged pedestal front door offers easy access for wire management
- Wire hooks provide wire coil storage
- Wire access openings allow access to floor, cabinets interior and kneespace
- Cabinet interior is black finish
- Top grommet is positioned over cavity for access ease
- (Power Strip Optional)

#### Notes

- Breakfront Chassis Only

### PEDESTAL MODIFICATIONS

#### *black laminate printer pullout bottom shelf*

Style Number	List Price
PPOS	225

### Specifications

- Black Laminate pullout shelf on suspension
- Black grommet in back
- Adjustable Shelf

### PEDESTAL MODIFICATIONS

#### *add veneer kneespace cabinets - base*

Style Number	List Price
Add Box/Box/File or File/File	
P40B	1025
Add Lateral File 29" W	
P41B	1255
Add Multi-File - 31"W	
P42B	1255
Add Storage With Doors 29"W	
P43B	1140
Add CPU /Printer Cabinet - Open	
P44B	1140

### Specifications

- Multi-file specify Box/Box Left or Right

#### Notes

- Add additional Standard Cabinets To Kneespace Area.

## Capitol park options.

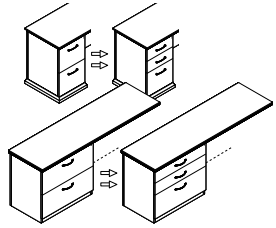

### PEDESTAL MODIFICATIONS *modify drawer configurations*

Style Number	List Price
File/File to Box/Box/File P6	55 Per ped
Box/Box/File to File/File P6	55 Per ped
Lateral File to 2 Box Drawers P8	100 Per ped

### Specifications

- Modify File/File To Box/Box/File - Any Unit

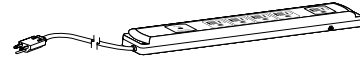

### POWER / DATA *power supply cordset*

Style Number	List Price
PD717	100

### Specifications

- SIZE: 10.75 "L x 2.0 "W x 1.06 "H
- (5) Outlets w/ 10' cord
- Surge suppression (720 Joules)
- 15 Amp breaker
- Available on: Vertical Panels, Cabinet Interiors, and under tops

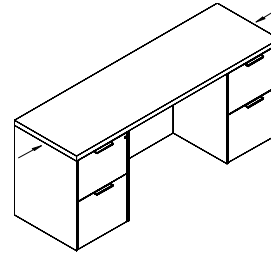

### PRODUCT MODIFICATIONS *modify width - open kneespace*

Style Number	List Price
MOD-1	125

### Specifications

- Modify width down on any unit with an open kneespace: desk, workstation credenza, bridge, return

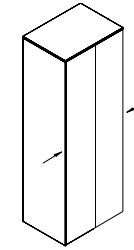

### PRODUCT MODIFICATIONS *modify width - open/closed storage*

Style Number	List Price
MOD-2	250

### Specifications

- Modify width down on any unit with open or closed storage section: overheads, wall hung units, storage credenzas, towers

# Capitol park options.

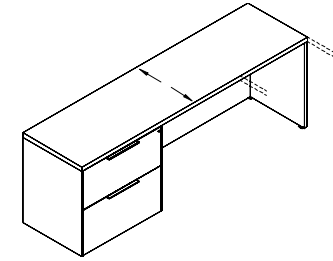
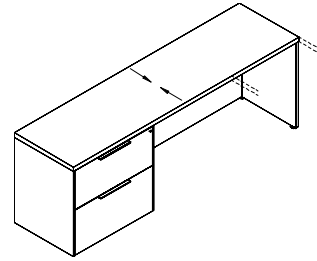
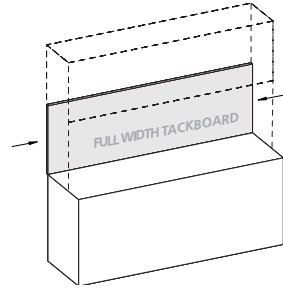

## PRODUCT MODIFICATIONS

*modify width - outside of mod-1, mod-2*

Style Number	List Price
MOD-3	Contact for pricing

## Specifications

- Width modification outside of MOD-1 & MOD-2

## PRODUCT MODIFICATIONS

*modify width - tackboard, slat wall, veneer panel, or a glassboard*

Style Number	List Price
MOD-4	50

## Specifications

- Modify width down on tackboard, slat wall, veneer panel, or a overhead glassboard

## PRODUCT MODIFICATIONS

*modify depth - decrease depth*

Style Number	List Price
MOD-5	125

## Specifications

- Modify depth down (minimum depth for a unit with drawers is 21" D)

Notes  
- Ex. 24" to 21", 30" to 24", and 36" to 30"

## PRODUCT MODIFICATIONS

*modify depth - increase depth*

Style Number	List Price
MOD-6	Add 10%

## Specifications

- Increase depth by no more than 6"

Notes  
- Ex. 24" to 30", 30" to 36", and 36" to 42"

# Capitol park options.

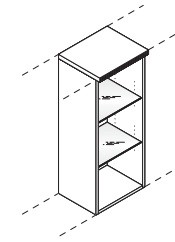
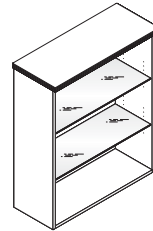
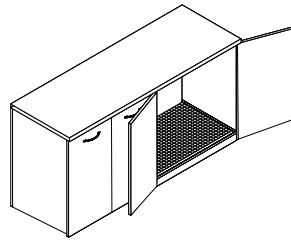

## PRODUCT MODIFICATIONS *modify height*

Style Number	List Price
MOD-7	Contact for pricing

### Specifications

- Modify height of a unit

## REFRIGERATOR MODIFICATION *refrigerator cabinet modification*

Style Number	List Price
REF01	205

### Specifications

- Open back cutout for venting
- Moisture sponge mat
- Contaminate ledge
- Contact customer service for maximum refrigerator size (Changes based on unit).

Notes  
- Available on: 36" and 42" Storage Credenzas

## SHELF MODIFICATIONS *glass shelves - tempered full width* 26" - 35"

Style Number	List Price
26"W - 35"W x 14"D Shelf GS14F	90

### Specifications

- Glass Shelves Replace Wood Shelf In Open Or Glass Door Cabinet. Also Order Interior Cabinet Lighting.

## SHELF MODIFICATIONS *tempered glass shelves for half cabinet* 17- 1/2" widths

Style Number	List Price
14-1/2"W - 17- 1/2"W x 14"D Shelf GS14H	70 ea.

### Specifications

- Glass Shelves Replace Wood Shelf In Open Or Glass Door Cabinet. Also Order Interior Cabinet Lighting.

Notes  
- Replace only adjustable shelves between cabinet light and fixed lower wood shelf.



## Capitol park options.

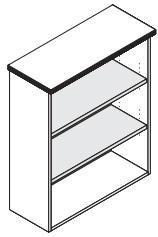

### SHELF MODIFICATIONS heavy duty solid wood bookcase replacement shelves

Style Number	List Price
1" Wood Shelf 14" Deep S714F	80 ea.
1" Wood Shelf 24" Deep S714FX	160 ea.

### Specifications

- 1" Solid Lumber Core Shelves Replace Standard 3/4" Plywood Adjustable And Fixed Shelves



### SLAT WALL ACCESSORIES slat wall accessory tray

Style Number	List Price
SWA9	50

### Specifications

- Specify Black Or Matte Silver

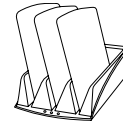

### SLAT WALL ACCESSORIES slat wall folder tray

Style Number	List Price
SWA7	50

### Specifications

- Specify Black Or Matte Silver

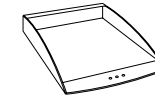

### SLAT WALL ACCESSORIES slat wall paper tray

Style Number	List Price
SWA2	40

### Specifications

- Specify Black Or Matte Silver

## Capitol park options.

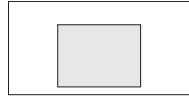

RECTANGLE INLAY

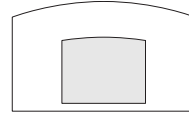

BOWFRONT INLAY

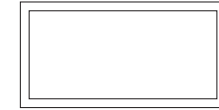

RECTANGLE INLAY

### SLAT WALL ACCESSORIES

*slat wall pencil holder*

Style Number	List Price
SWA4	30

### Specifications

- Specify Black Or Matte Silver

### SPECIALTY VENEER ACCENTS

*rectangle inlay - recesses dura-leather writing surface*

Style Number	List Price
RL-29A	935

### Specifications

- Recessed inlay desk pads are covered with Alomost Leather from Paul Brayton Designs.  
 - DARRAN will gladly custom quote other inlay materials ie: solid surfaces, biocomposites, metallic laminates, or genuine leather to match seating

### SPECIALTY VENEER ACCENTS

*bowfront inlay - recesses dura-leather writing surface*

Style Number	List Price
RL-31A	1035

### Specifications

- Recessed inlay desk pads are covered with Alomost Leather from Paul Brayton Designs.  
 - DARRAN will gladly custom quote other inlay materials ie: solid surfaces, biocomposites, metallic laminates, or genuine leather to match seating

### SPECIALTY VENEER ACCENTS

*rectangle inlay - ebony hardwood inlay detail*

Style Number	List Price
T10SA	935

### Specifications

- 3/16" x 3/16" thick hardwood ebony inlay is handfitted and glued into routed top and sanded flush with surface  
 - Inlay is finished over with all finish steps

**Notes**

- Ebony inlay not recommended in: Koko Cherry

## Capitol park options.

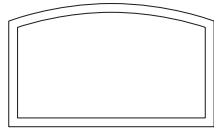

CURVED INLAY

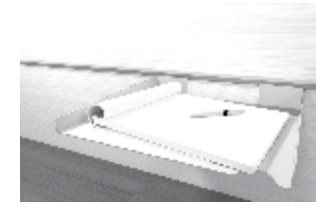
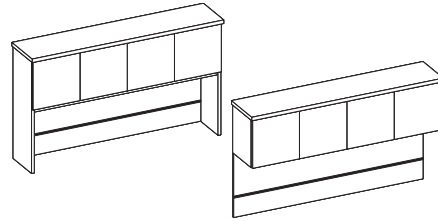

### SPECIALTY VENEER ACCENTS *bowfront inlay - ebony hardwood inlay detail*

Style Number	List Price
T115A	1035

### Specifications

- 3/16" x 3/16" thick hardwood ebony inlay is handfitted and glued into routed top and sanded flush with surface
- Inlay is finished over with all finish steps

Notes

- Ebony inlay not recommended in: Koko Cherry

### TOOL CHANNEL ACCESSORIES *recessed aluminum tool channel*

Style Number	List Price
ATB02	5 per 1"W

### Specifications

- Anodized aluminum finish
- Fully recessed
- Finish matches anodized aluminum accessories
- Can be specified with fabric tack surface mounted above channel

Notes

- If using tool channel with wallhung overhead, a veneer panel must be specified.

### TOOL CHANNEL ACCESSORIES *iphone holder*

Style Number	List Price
ATB31	125

### Specifications

- For Console/Wall Hung Back Panels With Optional Tool Bar
- 18 Gauge Steel - Stamp Formed
- Silver Powerdercoat Finish
- 5" x 3 -3/4"W
- Non-slip Neoprene pad

### TOOL CHANNEL ACCESSORIES *large shelf*

Style Number	List Price
ATB35	135

### Specifications

- 12"W x 10"D

## Capitol park options.

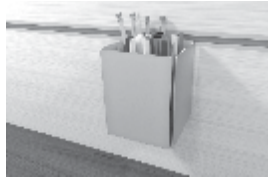

TOOL CHANNEL ACCESSORIES  
*pencil pen holder*

Style Number	List Price
ATB38	120

### Specifications

- For Console/Wall Hung Back Panels With Optional Tool Bar
- 18 Gauge Steel - Stamp Formed
- Silver Powdercoat Finish
- 5" H x 4" W x 4" D



TOOL CHANNEL ACCESSORIES  
*tablet holder*

Style Number	List Price
ATB30	145

### Specifications

- For Console/Wall Hung Back Panels With Optional Tool Bar
- 18 Gauge Steel - Stamp Formed
- Silver Powdercoat Finish
- 10" x 8" W
- Non-slip Neoprene pad

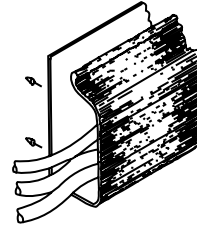

WIRE MANAGEMENT  
*horizontal j-channel wire management raceway*

Style Number	List Price
W1	80 Per 4' section

### Specifications

- 4" section for field installation.
- The "J" shape black thermoplastic wire raceway may be added to specified worksurface tops to provide concealed channeling of wires to and from worksurface grommets. For use in open kneespace areas, raceway is attachable to top of back panel with pan head screws. Interior dimensions are 1" x 1- 1/2" providing ample storage for multiple wires and excess cable. Front of raceway flexes out for easy cord insertion.

#### Notes

- Units w/ Wire Channel Standard.
- Field Installation

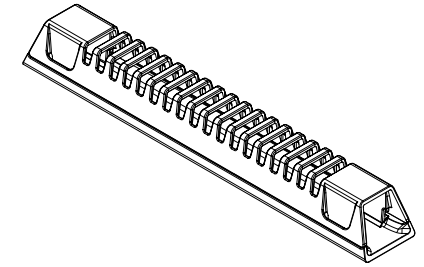

WIRE MANAGEMENT  
*horizontal wire management raceway*

Style Number	List Price
W21	35

### Specifications

- 10"W x 1.5"D x 1.25"H
- Grey Wire Manager (10.5")
- Power and data cables can be discretely housed and managed with the W21 Gray Wire Manager. This can be mounted in any location to metal frame or underside of conference tables and runs cables through a 1" channel from power module to hollow steel legs. This keeps cables organized under the table top. Release clips make it simple to snap on and off the Wire Manager for easy organization and access after attached to the table

#### Notes

- Field installed

# Capitol park options.

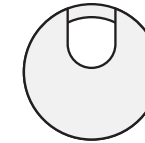
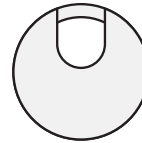

## WIRE MANAGEMENT *horizontal u-channel wire management raceway*

Style Number	List Price
W2A	80 Per 4' section

### Specifications

- 4' section for field installation.

**Notes**

- Units w/ Wire Channel Standard.
- Field Installation

## WIRE MANAGEMENT *coil wire manager*

Style Number	List Price
W18	160

### Specifications

- Weighted Base, Table attachment plate
- 39- 1/2" Length
- Black

**Notes**

- Location

## WIRE MANAGEMENT *standard location grommets - factory installed*

Style Number	List Price
Standard Location Grommet	
Black	
TM30	50
Silver	
TM31	50
Antique Brass	
TM33	50
White	
TM34	50

### Specifications

- 1 -5/8" Metal Grommet

**Notes**

- \*Units w/ Grommets Standard Are Noted Under Standard Features. Grommets Match Pull Finish - Standard (Unless Specified Otherwise)

## WIRE MANAGEMENT *non-standard location grommets - factory installed*

Style Number	List Price
Non-Standard Location Grommet	
Black	
TM30 -NS	95
Silver	
TM31 -NS	95
Antique Brass	
TM33 -NS	95
White	
TM34 -NS	95

### Specifications

- 1 -5/8" Metal Grommet

**Notes**

- \*Units w/ Grommets Standard Are Noted Under Standard Features. Grommets Match Pull Finish - Standard (Unless Specified Otherwise)

# Capitol park options.



## WIRE MANAGEMENT

*black plastic vertical surface grommets*  
*- factory installed*

Style Number	List Price
Standard Location Grommet TM50-C	50
Non-Standard Location Grommet TM50-NS	95

## Specifications

- 2 " Black Plastic Grommet

### Notes

- Standard Location is Bottom Center

## power & data options.

Aircharge wireless charging grommet

Style Number

List Price



ACWG WIRELESS GROMMET

\$195

## Specifications

- › When used with GROVE Tables an additional \$350 LIST will apply for the special cutout required.
- › AirCharge offers a convenient way to charge any Qi compatible smartphone or device without the need to carry charging cables or find an available power outlet.
- › The Aircharge is powered by the latest Qi compliant IC offering reliable and efficient wireless charging in a convenient 3" grommet hub. Simply place your phone on the Aircharge and an LED will confirm pairing and begin wireless charging.
- › Recess: Efficient space conservation and quick access
- › Input: DC 5V (with included AC power adapter), DC 9V, 1.67A (with optional QC 2.0 power adapter)
- › Output: 5 watts Max. with DC 5V, 2A power adapter, 10 watts Max. with QC 2.0 power adapter
- › Qi V1.2 compliant IC
- › Charging distance: 6mm Max.

Available: All DARRAN collections



## power & data options.

Cove power unit - non-linking

Style Number	List Price
 PD-COVE PLUG	\$550
Non-linking version	

### Specifications

- › Size 5.75" L x 2.5" W
- › (2) 15 Amp Receptacles and (2) USB charging ports
- › Surface Mount
- › 108" Cord
- › Standard Silver Finish, Available in White or Black Finish upon request
- › ETL Listed

Available: All DARRAN collections





## power & data options.

Cove corded series

Style Number

List Price



PD-COVE-PKO

\$800

## Specifications

- > Size 9.5"L x 2.5"W x 3.18"D
- > When used with GROVE Tables an additional \$350 LIST will apply for the special cutout required.
- > (2) Power Receptacles, (2) 2.1 Amp USB charging ports and (1) Telecom Plate Knockout
- > Surface Mount
- > 108" Cord
- > Standard Silver Finish, Available in White or Black Finish upon request
- > ETL Listed

Available: All DARRAN collections

### Telecom Plates

RJ45 (1)	\$35
RJ45 (2)	\$70
RJ45 (3)	\$105
USB (1)	\$70
USB (2)	\$140
RJ11/RJ45	\$70
RJ45/USB	\$105
RJ45/HDMI	\$190
HDMI/DVI	\$325
HDMI/USB	\$205
HDMI/VGA	\$240
VGA/MINI-STEREO	\$155
VGA/USB	\$175

This pod can have up to 1 total plates.

\*All telecom connectors sold separately.



## power & data options.

Soba wire manager

Style Number	List Price
STARTER UNITS	
SCDW	\$200
White wire manager	
SCDB	\$200
Black wire manager	

## Specifications

- › Dimensions: 9ft x 9in x 3.15in
- › Zips up, bundles and routes loose, messy cables into a single tube
- › Routes and guides cables behind desks, TVs, and anywhere cables tend to get messy
- › Accommodates large or small cables, up to three cables at once
- › Support channels, used to route cables, include powerful adhesive backing which allows easy attachment to surfaces.

Available: All DARRAN collections



## power & data options.

### VILLA Power unit - non-linking

Style Number	List Price
VIL-C PLUG Non-Linking	\$515

## Specifications

- › Size: Top Grommet 5.68" L X 3.39" W; Under Top 12" L x 3.13" W x 3.08" D
- › (2) Power receptacles; (2) USB charging ports and (1) Knockouts for RJ45 Data Ports
- › Surface Mount
- › 72" Cord (Longer cord available, contact Customer Service)
- › Standard Silver Finish, Black Finish available upon request
- › UL or ETL Certified

Available: All DARRAN collections, excludes Grove

RJ45 Knockout RJ45 (1)	\$35
---------------------------	------



# Central park price list



effective july 1, 2021

## Central park table of contents

Statement of Line	
Features & Advantages .....	1
Finishes   Specifications .....	3
Edges.....	4
Pulls   Knobs .....	5
Grommets   Grommet Reference.....	6
Height Reference .....	7
Modesty Reference .....	8
Doors   Grain Direction.....	9
Drawer Dimensions   FILING Reference .....	10
Double Pedestal Desk.....	11
Table Desk .....	18
Single Pedestal Desk .....	20
Non-Handed Desk Shells .....	28
Desk shell.....	29
Work Wall Desk.....	36
Height Adjustable Table Desk.....	37
Conference Desk .....	39
Service Desk.....	46
Runoff Desk.....	49
Returns .....	53
Bridges .....	60
Freestanding Credenzas .....	61
Workstation Credenzas .....	66
Workstation Shell.....	69
Bench Cabinets/Accessories .....	71
Pedestals.....	75
Single Height Freestanding Overheads .....	78
Double Height Freestanding Overheads.....	81
Overhead Accessories .....	83
Single Height Wall Hung Overheads .....	87
Double Height Wall Hung Overheads .....	90
Wall Hung Accessories .....	93
Overhead Half Towers.....	101
Overhead Bookcases .....	104
Vertical Half Towers.....	105
Vertical Full Towers.....	107
Bookcases.....	111
Reception .....	113
Options.....	127
Power & Data .....	144

statement of line.

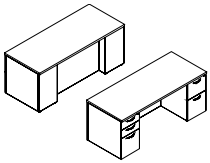

PAGE 11  
Breakfront Chassis Desks

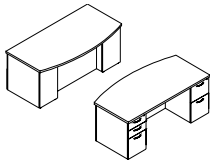

PAGE 12  
Breakfront Chassis Desks

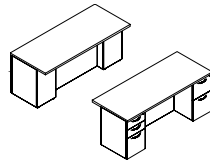

PAGE 13  
Breakfront Chassis Desks

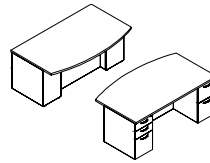

PAGE 14  
Breakfront Chassis Desks

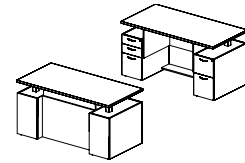

PAGE 15  
Breakfront Chassis Desks

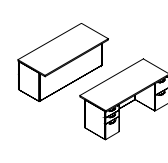

PAGE 16  
Flush Chassis Desks W/ Overhang

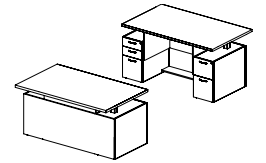

PAGE 17  
Flush Chassis Desks W/ Overhang

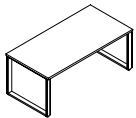

PAGE 18  
Table Desks With Sleigh Base

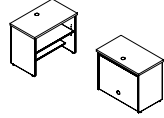

PAGE 19  
Desks

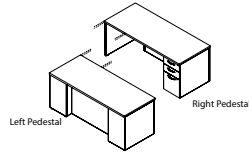

PAGE 20  
Double Breakfront / Single Pedestal Desks

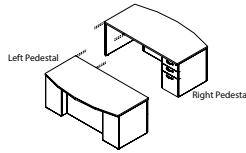

PAGE 21  
Double Breakfront / Single Pedestal Desks

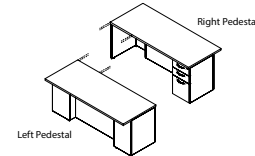

PAGE 22  
Double Breakfront / Single Pedestal Desks

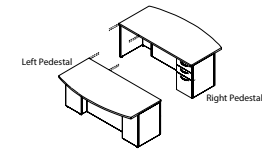

PAGE 23  
Double Breakfront / Single Pedestal Desks

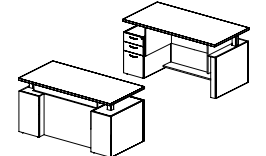

PAGE 24  
Double Breakfront / Single Pedestal Desks

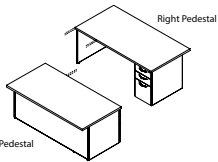

PAGE 25  
Flush Chassis Single Pedestal Desks W/ Overhang Top

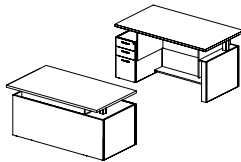

PAGE 26  
Flush Chassis Single Pedestal Desks W/ Overhang Top

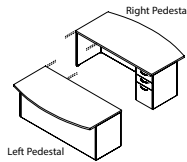

PAGE 27  
Flush Modesty Single Pedestal Desks

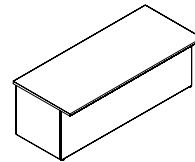

PAGE 28  
Non-Handed Desk Units

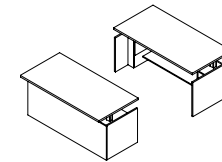

PAGE 29  
Desk Shell

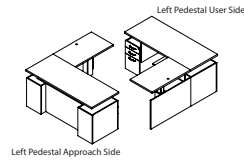

PAGE 30  
Height Adjustable Box/Box/File Pedestal With Bridge

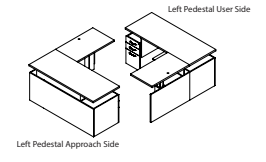

PAGE 31  
Height Adjustable Box/Box/File Pedestal With Bridge

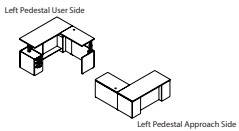

PAGE 32  
Double Breakfront Height Adjustable Box / Box / File Pedestal Desk

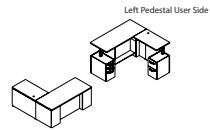

PAGE 33  
Double Breakfront Height Adjustable Box / Box / File Pedestal Desk

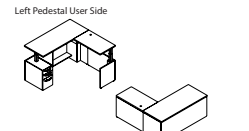

PAGE 34  
Flush Chassis Height Adjustable Box / Box / File Pedestal Desk

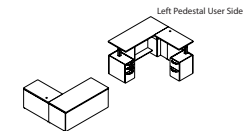

PAGE 35  
Flush Chassis Height Adjustable Box / Box / File Pedestal Desk

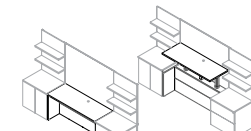

PAGE 36  
Height Adjustable Work Wall Desk

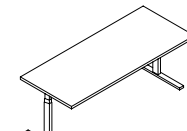

PAGE 37  
Height Adjustable Table Desk

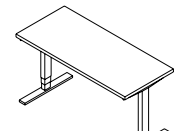

PAGE 38  
Height Adjustable Bridges

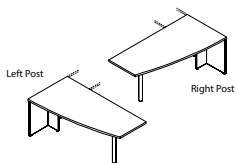

PAGE 39  
Conference Desks

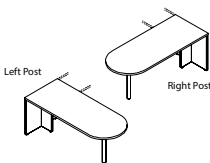

PAGE 40  
Conference Desks

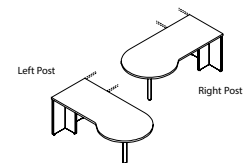

PAGE 41  
Conference Desks

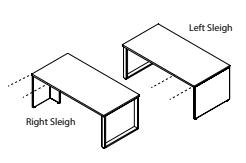

PAGE 42  
Conference Desks

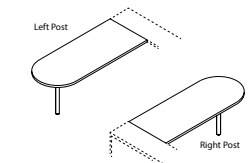

PAGE 43  
Conference Runoff Desks

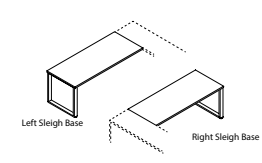

PAGE 44  
Conference Runoff Desks

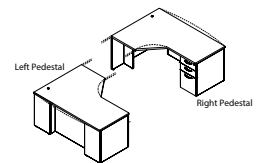

PAGE 45  
Service Workstation Desks

statement of line.

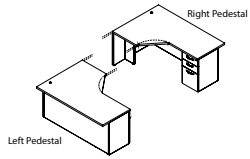

PAGE 46  
Service Workstation Desks

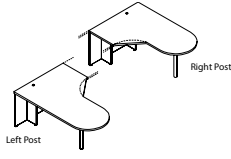

PAGE 47  
Service Workstation Desks

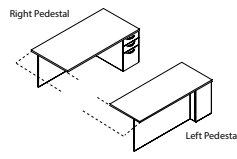

PAGE 48  
Workstation Runoff Desks Single Full Pedestal

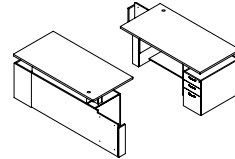

PAGE 49  
Height Adjustable Workstation Runoff Desks

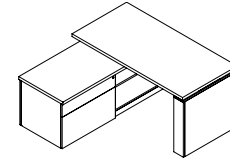

PAGE 50  
Height Adjustable Runoff Desk

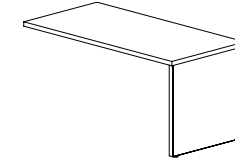

PAGE 51  
Runoff Desk

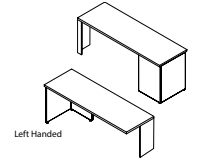

PAGE 52  
Workstation Shells - Used Next to Single Pedestal or Shell Lift Desk

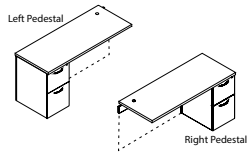

PAGE 53  
"L" Workstation Returns

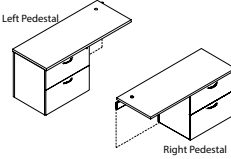

PAGE 54  
"L" Workstation Returns

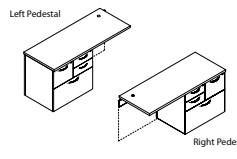

PAGE 55  
"L" Workstation Returns

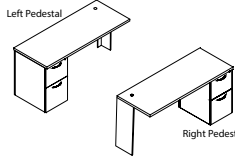

PAGE 56  
"L" Workstation Returns

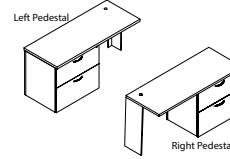

PAGE 57  
"L" Workstation Returns

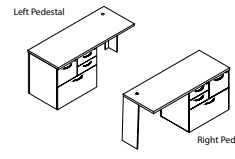

PAGE 58  
"L" Workstation Returns

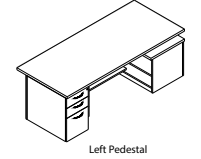

PAGE 59  
Conference Runoff Desk

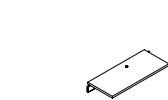

PAGE 60  
Bridges

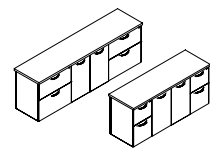

PAGE 61  
Full Pedestal Credenzas

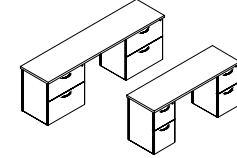

PAGE 62  
Full Pedestal Credenzas

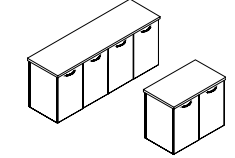

PAGE 63  
Full Pedestal Credenzas

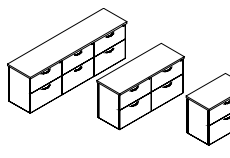

PAGE 64  
Full Pedestal Credenzas

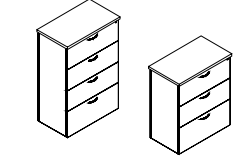

PAGE 65  
Full Pedestal Credenzas

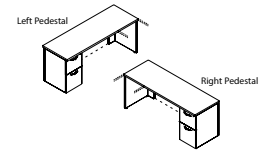

PAGE 66  
Workstation Credenzas

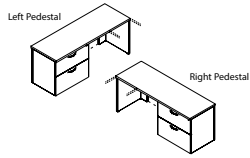

PAGE 67  
Workstation Credenzas

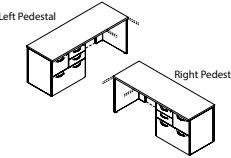

PAGE 68  
Workstation Credenzas

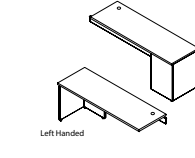

PAGE 69  
Workstation Shells

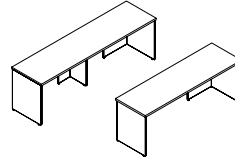

PAGE 70  
Workstation Freestanding Credenza Shells

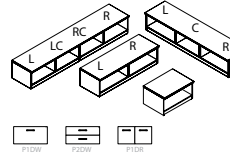

PAGE 71  
Single Height Bench Cabinets

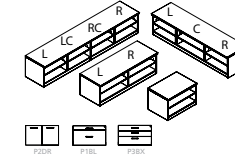

PAGE 72  
Double Height Bench Cabinets

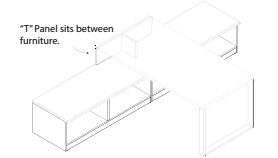

PAGE 73  
Bench Accessories

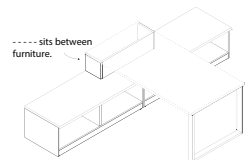

PAGE 74  
Bench Accessories

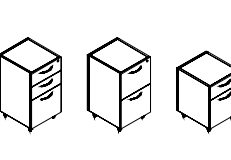

PAGE 75  
Mobile Pedestals



PAGE 76  
Modular Pedestals

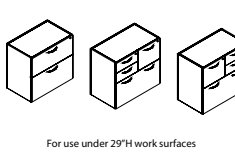

PAGE 77  
Pedestals

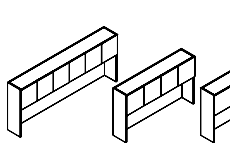

PAGE 78  
Single Storage Overhead Console

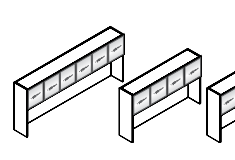

PAGE 79  
Single Storage Overhead Console

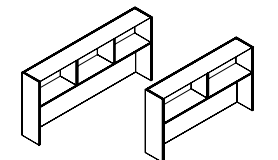

PAGE 80  
Single Storage Overhead Console

statement of line.

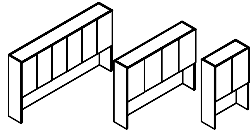

PAGE 81  
Central park  
Double Storage Overhead Console

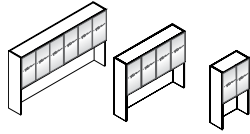

PAGE 82  
Central park  
Double Storage Overhead Console

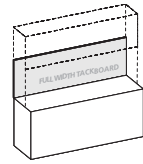

PAGE 83  
Central park  
Overhead Tackboards

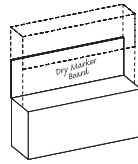

PAGE 84  
Central park  
Overhead Dry Marker Boards

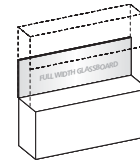

PAGE 85  
Central park  
Overhead Glassboards

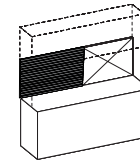

PAGE 86  
Central park  
Overhead Slat Wall

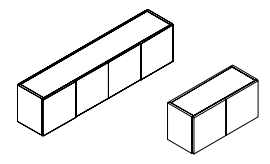

PAGE 87  
Central park  
Single Height Wall Hung Overheads

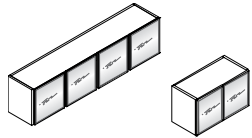

PAGE 88  
Central park  
Single Height Wall Hung Overheads

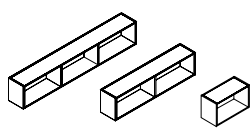

PAGE 89  
Central park  
Single Height Wall Hung Overheads

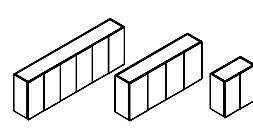

PAGE 90  
Central park  
Double Height Wall Hung Overheads

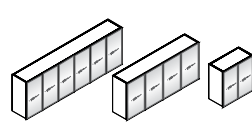

PAGE 91  
Central park  
Double Height Wall Hung Overheads

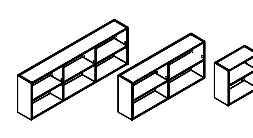

PAGE 92  
Central park  
Double Height Wall Hung Overheads

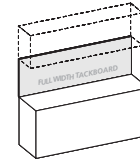

PAGE 93  
Central park  
Wall Hung Tackboards

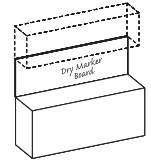

PAGE 94  
Central park  
Wall Hung Dry Marker Boards

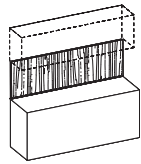

PAGE 95  
Central park  
Wall Hung Veneer Panels

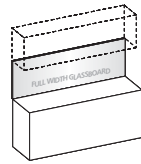

PAGE 96  
Central park  
Wall Hung Glassboards

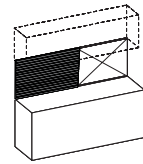

PAGE 97  
Central park  
Wall Hung Slat Wall

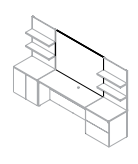

PAGE 98  
Central park  
Glass Wall Hung Board

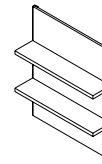

PAGE 99  
Central park  
Single Height Wall Hung Shelf

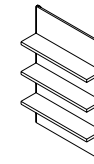

PAGE 100  
Central park  
Double Height Wall Hung Shelf

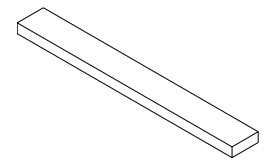

PAGE 101  
Central park  
Floating Wall Mounted Shelf

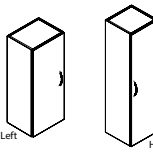

PAGE 102  
Central park  
Overhead Half Towers

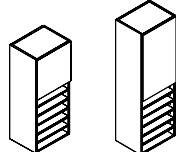

PAGE 103  
Central park  
Overhead Half Towers

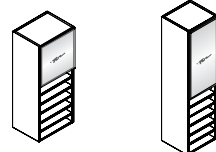

PAGE 104  
Central park  
Overhead Full Towers

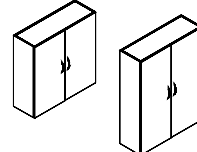

PAGE 105  
Central park  
Overhead Bookcases

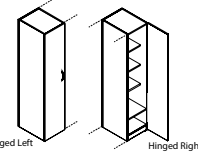

PAGE 106  
Central park  
Vertical Half Towers

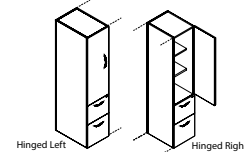

PAGE 107  
Central park  
Vertical Half Towers

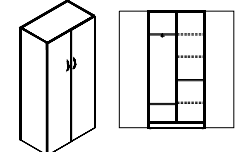

PAGE 108  
Central park  
Vertical Full Towers

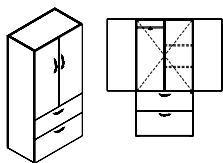

PAGE 109  
Central park  
Vertical Full Towers

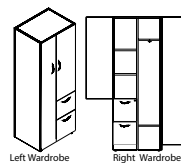

PAGE 110  
Central park  
Vertical Full Towers



PAGE 111  
Central park  
Workcenter 54" Full Tower  
Components

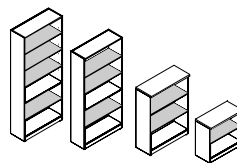

PAGE 112  
Central park  
Bookcases

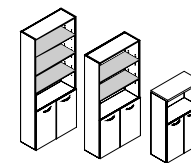

PAGE 113  
Central park  
Bookcases

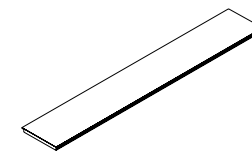

PAGE 114  
Central park  
Reception Desk Countertops

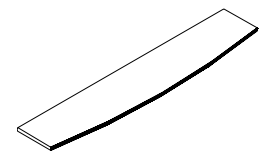

PAGE 115  
Central park  
Reception Desk Countertops



statement of line.

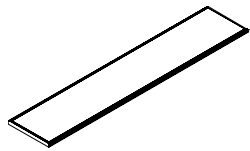

PAGE 116  
Central park  
Reception Desk Countertops

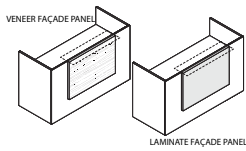

PAGE 117  
Central park  
Reception Facade Panel Counters

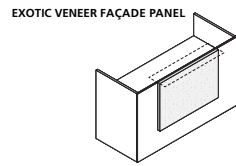

PAGE 118  
central park  
Reception Facade Panel Counters

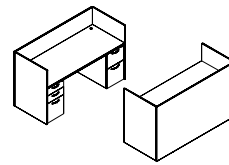

PAGE 119  
Central park  
Reception Desk

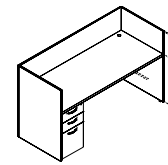

PAGE 120  
Central park  
Reception Desk

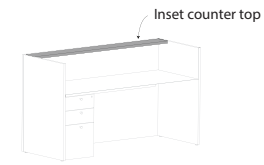

PAGE 121  
Central park  
Reception

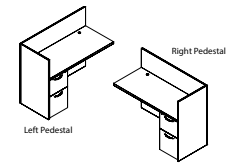

PAGE 122  
Central park  
Reception Return

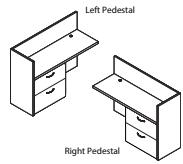

PAGE 123  
Central park  
Reception Return

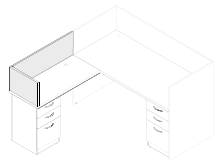

PAGE 124  
Central park  
Sit-On Reception Counters

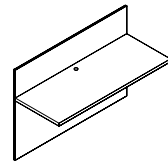

PAGE 125  
Central park  
Reception Bridge

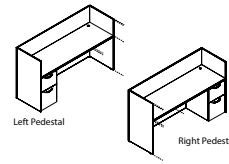

PAGE 126  
Central park  
Standard Reception "U" Credenzas

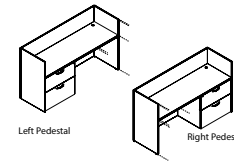

PAGE 127  
Central park  
Standard Reception "U" Credenzas

## Central park features & advantages

### Veneer

DARRAN only uses HPVA AA Grade Flat Cut Cherry, Maple, and Walnut Veneers and AA Grade Quartered Oak Veneers. Central Park is also available in double cut reconstituted walnut and oak patterns made from rapidly renewable wood veneer providing a repeatable consistent straight grain pattern. All veneers are selected and matched for balance and consistency.

### Veneer Tops

Central park veneer tops feature a 45-pound density substrate with balanced 3-ply construction. Tops are 1-5/16" thick on MDF core comprised of 100% recycled and recovered wood fibers. All veneer tops are slipmatched and feature a 3mm external solid hardwood band or profile edge.

### Laminate Tops

Central park high-pressure laminate tops feature a 45-pound density substrate with balanced 3-ply construction. Tops are 1-5/16" thick on MDF core comprised of 100% recycled and recovered wood fibers. All high pressure laminate tops are available with a profile edge, laminate self-edge or 2mm PVC edge band. Laminates in wood grain patterns feature a fine grain texture that features the polish and luxe of a real wood veneer with a subtle narrow grain structure.

### TFL tops

Thermally Fused Laminate tops feature a 45-pound density substrate with balanced 3-ply construction. Tops are 1-1/8" thick on MDF core that is comprised of 100% recycled and recovered wood fibers. All Thermally Fused Laminate tops are available with a 2mm flat PVC band. Laminates in wood grain patterns feature Timberline Texture providing the grain pattern of wood.

### Cleaning wood & laminate

In addition to regular dusting, give your furniture an occasional cleaning in accordance with our cleaning instructions. DARRAN wood and laminate products can be cleaned with a soft cloth and a mild soap and water mixture. Use approximately 32 oz of water mixed with one tablespoon of dish soap, always wiping with the grain. Dry with a soft cloth, going with the grain, to avoid spotting or streaking.

Wood products should be waxed periodically using a non-wax liquid; please do not use any waxy polish or cleaner. Interior of drawers may also be cleaned with mild soap and water mixture, or any household cleaner that is not petroleum or thinner-based.

### Chassis & pedestal

Chassis components are 3/4" thick core of particle board or MDF rated EPP/SCS/CARB-II material with 3-ply balanced construction. Pedestal and Cabinets feature dowel construction reinforced with steel bracket plates, wood cleats, screws and glue. All

units are standard with 1" adjustable glides that allow for leveling of units that are secured in solid wood glide blocks to prevent tearout.

### Overhead cabinet construction

Freestanding Overhead storage cabinets are constructed of 1" and 3/4" thick core of particle board or MDF rated EPP/SCS/CARB-II material with 3-ply balanced construction. Panels are attached with cam fasteners in conjunction with dowels securely adhered with PVAc glue. All surface mount cabinets connect to work surface with anti-slip tape. Wall mount cabinets are mounted to the wall with steel "z" bracket attachment method using 5mm euro screws to attach to the back of the cabinet. All units ship with a steel "z" bracket. This bracket is mounted to the wall by field installers. Installers are responsible for selecting and supplying appropriate fasteners for wall conditions.

### Bookcase construction

All chassis (sides, back, top and bottom panels) are constructed with 3/4" thick core of particle board or MDF rated EPP/SCS/CARB-II material with 3-ply balanced construction. Panels are attached with cam-lock fasteners in conjunction with dowels securely adhered with glue. Shelves on all units are 3/4" thick balance 3 ply panels. Optional heavy duty shelves are 1" thick lumber core balanced 5 ply construction.

### Tackboards

Wall mount tackboards are constructed of .75" thick fiberboard. The fabric is precisely aligned and fitted to the tackboard with a sock on cover. Overhead storage tackboards are constructed of .75" thick fiberboard. The fabric is precisely aligned and fitted to the tackboard and adhered to the rigid hardboard with staples. Wall mount cabinets are mounted to the wall with steel "z" bracket attachment method using 5mm euro screws to attach to the back of the cabinet. All units ship with a steel "z" bracket. This bracket is mounted to the wall by field installers. Installers are responsible for selecting and supplying appropriate fasteners for wall conditions.

### Adjustable glides

Glides provide 1" of vertical leveling adjustment. Glide bottom is durable metal. Glides are secured in solid wood blocks that are screwed and glued for durability. etal.

### Drawers

All drawers are constructed with mitre joint/dowel construction in a natural maple finish with four sides and a bottom, which are attached to a drawer front with screws for easy removal. Drawer fronts are vertically matched in balanced sets. Pencil trays are standard in all box drawers. Drawers are constructed of 1/2" thick wood grained wrapped 5 sided miter-folded construction with 1/4" thick hardboard bottoms reinforced for heavy weight capacity. Drawers have been tested and pass BIFMA 50,000 cycle test. All drawers are guaranteed lifetime with free replacement warranty.

## Central park features & advantages

### Drawer fronts

Drawer fronts are vertically matched in balanced sets. Doors feature vertical veneer bookmatched horizontally in sets of 2 / 4 and 6 doors. All drawers and doors have traditional scallop profile edge shape. All tower fronts matched in vertical sets.

### Optional wood drawers

Optional hardwood veneer plywood drawers feature banded top and bottom edges for smoothness. Drawers are dowel joint construction with a UV cured finish over maple veneers, plus a lifetime free replacement guarantee.

Optional Wood Drawer (Any Size) – Option Code P33...\$45 List Price Per Drawer

### Suspensions

All casegoods utilize cold rolled steel zinc plated high-grade drawer suspensions. All suspensions are warranted for the lifetime of the product. Box and File drawers are full extension, featuring steel ball bearings for a smoother quieter range of motion and are rated 100lbs. Lateral file drawers are a progressive action full extension suspension and is rated at 150lbs. Veneer and High Pressure laminate casegoods feature soft close suspension. Thermally Fused Laminate casegoods feature standard suspensions. Lateral files include anti tip mechanism that allow only one drawer to be opened at a time.

### Hinges

Units with doors include 95 degree swing hinges.

### Filing

Central park features a highly durable black plastic extrusion that is securely fastened into a route on top of the drawer to support hanging files. An adjustable crossbar is provided for all file drawers that enables legal/letter filing front to back or side-to-side based on the drawer size.

### Locks

Locks are Standard on all drawers below the worksurface. Random lock cores are installed at the factory. Some units may be shipped with the same key number. Locks are Silver, Black or Bronze and match pull finish unless otherwise specified.

DARRAN will also send lock cores separately to the dealer at your request. These units will be send with an empty lock core and the Dealer will receive a shipment of the requested lock core/keys.

### Keying

Keying is available either factory or field installed. Factory installed keying is random.

### Wire management

Wire management capabilities include standard and optional worksurface grommets. Specify W-1 under surface wire channels for organization and management of all communication wires and cords. Horizontal J-Channel wire management (Sku: W-1) is sold separately to conceal wire under worksurfaces.

### Grommets

Metal grommets are provided to match the drawer pull selection. Grommet is available in black, silver, white or antique brass. Must specify standard or non-standard location. Black plastic grommets are available as an option for vertical applications.

### Powerports

A large selection of power pods are available and handle power, data, docking stations and communication. See options section for selection.

### LED tasklights

LED task lighting provides high efficiency, low energy lighting with a long life. Recessed light is encased in silver aluminum channel with milk lense and rounded end caps. Lights are factory installed. Product specifications listed below:

- Diffuser creates a softer light and eliminates hot spots
- Touch dimmer switch
- Can be "daisy chained" up to 90W
- 4.6 watts per foot
- 120 LEDs per meter
- Certification: UL Listed
- 50,000 hour life span.

Color Temp is 4000K

## Central park finishes | specifications

STANDARD VENEER	PREMIUM VENEER	HIGH PRESSURE LAMINATE	THERMALLY FUSED LAMINATE
WAC Amber Cherry.....	N/A.....	GAC Amber Cherry.....	MAC Amber Cherry
WRC Caramel Cherry.....	N/A.....	N/A.....	N/A
WIC Crimson Cherry.....	N/A.....	GIC Crimson Cherry.....	N/A
WEC Ebony on Cherry.....	N/A.....	GEC Ebony.....	MEC Ebony
WHC Honey Cherry.....	N/A.....	GHC Honey Cherry.....	MHC Honey Cherry
WOC KoKo Cherry.....	N/A.....	GOC KoKo Cherry.....	MOC KoKo Cherry
WAM Alabaster Maple.....	N/A.....	GAM Alabaster Maple.....	N/A
WCM Clear Maple.....	N/A.....	GCM Clear Maple.....	N/A
WWM Wheat Maple.....	N/A.....	GWM Wheat Maple.....	N/A
WEW Executive Walnut.....	N/A.....	GEW Executive Walnut.....	N/A
WGW Gunstock Walnut.....	N/A.....	N/A.....	MGW Gunstock Walnut
WBW Henna Walnut.....	N/A.....	N/A.....	N/A
WSW Smokey Walnut.....	N/A.....	N/A.....	N/A
WNW Natural Walnut.....	N/A.....	GNW Natural Walnut.....	N/A
N/A.....	WBO Blush Oak.....	N/A.....	N/A
N/A.....	WMO Mocha Oak.....	N/A.....	N/A
N/A.....	WNO Natural Oak.....	N/A.....	N/A
N/A.....	WSO Salted Oak.....	N/A.....	N/A
N/A.....	TBCO Baby's Cheek.....	N/A.....	N/A
N/A.....	TBSW Brown Sugar.....	N/A.....	N/A
N/A.....	TOBW Organic Brown.....	N/A.....	N/A
N/A.....	TSTV Studio Teak Walnut.....	GSTV Studio Teak Walnut +10%.....	MTW Studio Teak Walnut
N/A.....	TSMV Seattle Mist.....	N/A.....	N/A
N/A.....	TSLV Skyline Walnut.....	GSLV Skyline Walnut +10%.....	MSW Skyline Walnut
WWP Designer White Paint.....	N/A.....	GWL Designer White.....	MWL Designer White

HPL TOPS ON TFL PRODUCTS Add 10% - Available with flat edge only  
 Send 3x3 or larger finish chip for color match. Custom finish upcharge is 3% or \$250 Net (whichever is greater).

### Finish

ENVI-CT Green Certified European Technology Coatings Finish.

## Central park edges

### Standard profile

Central Park Edge for "W" and "G" Styles

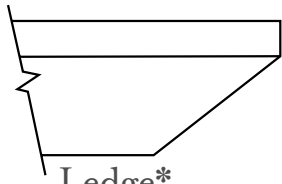

**Ledge\***

"W" 3mm Solid Hardwood Band  
 "P" 3mm Solid Hardwood Band  
 "G" HPL Self Edge

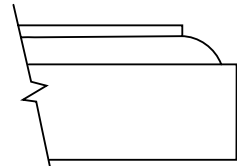

**Classic\***

"W" 3mm Solid Hardwood Band  
 "G" HPL Self Edge

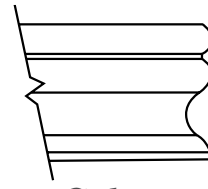

**Cobee**

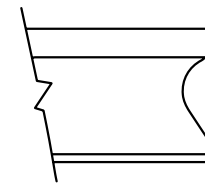

**Cove**

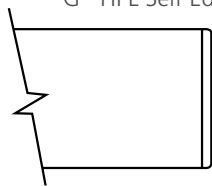

**Flat**

"W" 3mm Solid Hardwood Band  
 "P" 3mm Solid Hardwood Band  
 "G" HPL Self Edge

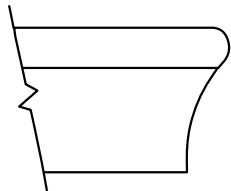

**Knife\***

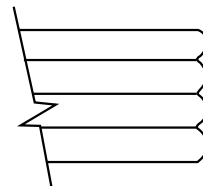

**Reed**

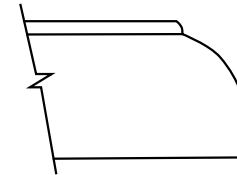

**Waterfall\***

### "W" Premium profile

3/4" Hardwood Rim Band Species Same As Surface Veneer



**Bullnose\***



**Ogee\***

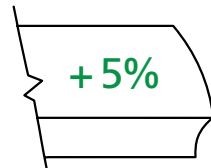

**Radius\***

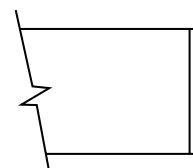

**Flat**

2 mm PVC Edge

### "M" Standard profile

Central Park Edges for "M" Styles

\* Coping edges

# Central park pulls | knobs

## Pulls/knobs

Factory Installed

\$15 per pull on Overhead and Wall Hung units

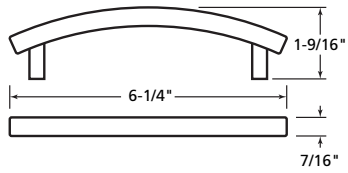

PL-112 Matte Black  
PL-113 Matte Nickel

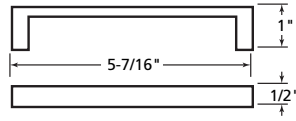

PL-115 Matte Black  
PL-116 Matte Nickel

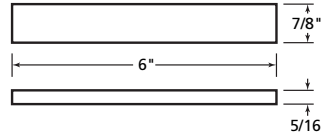

PL-210 Anodized Aluminum

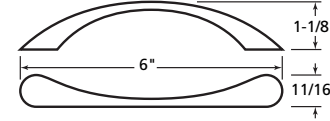

PL-105 Matte Black  
PL-106 Matte Nickel

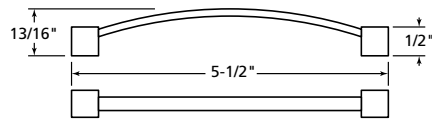

PL-125 Antique Pewter  
PL-126 Antique English  
PL-127 Matte Black

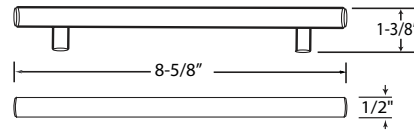

PL-310 Stainless Steel  
PL-311 Royal Brass

## Finger pulls

Arrow indicates finger pull location

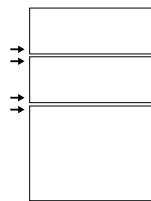

b/b/f



f/f

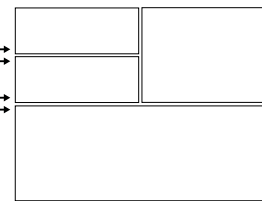

multi



lateral/lateral

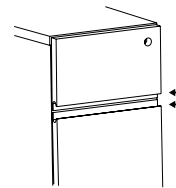

finger pull side view



### Silverluma frame doors

Open with touch latch assist - without pulls

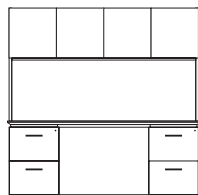

### Overhead doors

Open with door bottom overhang. Pulls available on request

## Central park grommets | grommet reference

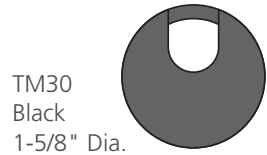

TM30  
Black  
1-5/8" Dia.

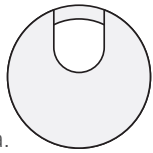

TM31  
Silver  
1-5/8" Dia.

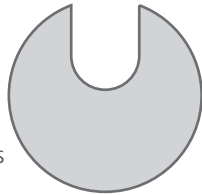

TM33  
Antique Brass  
2-1/2" Dia.

### Optional grommets

Factory Installed

Grommets (Standard Location)

Specify Color and Left/Right/Center - \$50 ea.

- Black: TM30-R (Right), TM30-L (Left), TM30-C (Center)

- Silver: TM31-R (Right), TM31-L (Left), TM31-C (Center)

- Antique Brass: TM33-R (Right), TM33-L (Left), TM33-C (Center)

Grommets (Non-Standard Location)

Provide drawing w/ Grommet Location and Specify Color - \$95 ea.

- Black: TM30-NS

- Silver: TM31-NS

- Antique Brass: TM33-NS

TM50  
Black  
1-5/8" Dia.



### Grommets (vertical surface)

Standard Location - \$50 ea.

- Black Plastic Vertical Surface: TM50-C (Bottom Center)

Non-Standard Location - \$95 ea.

- Black Plastic Vertical Surface: TM50-NS

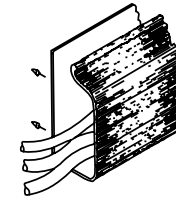

W1

### Horizontal J-Channel

Horizontal J-Channel wire management (Sku: W-1) is sold separately to conceal wire under worksurfaces.

## Standard grommet location reference



Desk  
Specify Right or Left Grommet

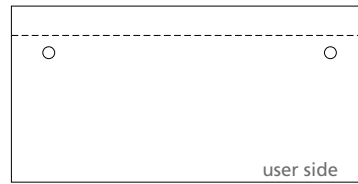

6" Overhang Desk  
Specify Right or Left Grommet

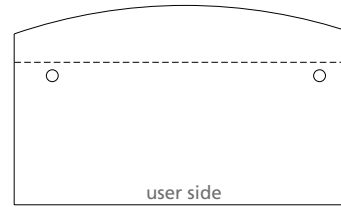

6"/12" Bow Front Desk  
Specify Right or Left Grommet



Bullet Conference Desk (Right Post)  
Center Grommet

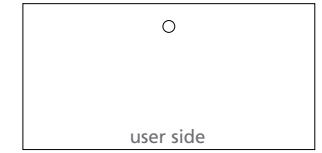

Bridge  
Center Grommet

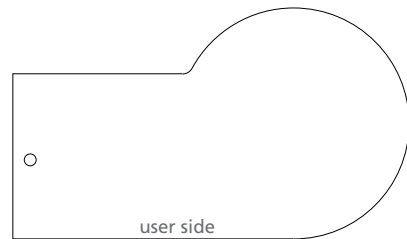

P Conference Desk (Right Post)  
Center Grommet

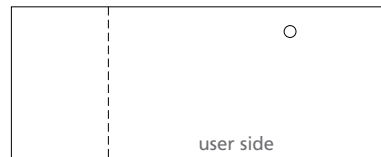

Return (Left Pedestal Shown)  
Right Pedestal - Left Grommet  
Left Pedestal - Right Grommet



Workstation Credenza  
Center Kneespace Grommet

Central park height reference

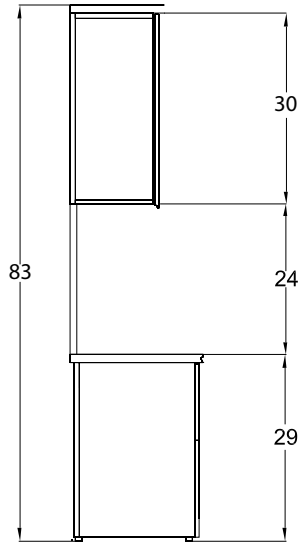

Typical Double Height Side Profile Wall Hung Overhead

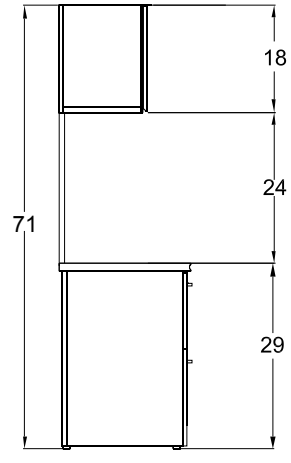

Typical Single Height Side Profile Wall Hung Overhead

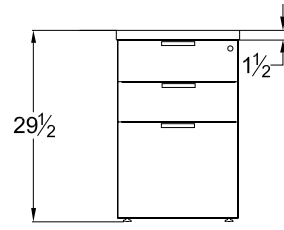

Pedestal Front Profile Box/Box/File

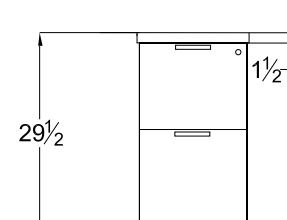

Pedestal Front Profile File/File

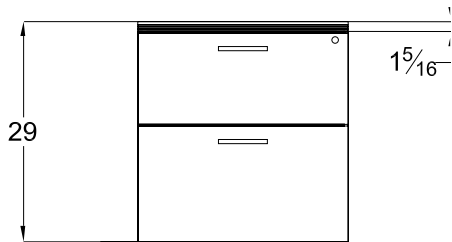

Pedestal Front Profile Lateral File

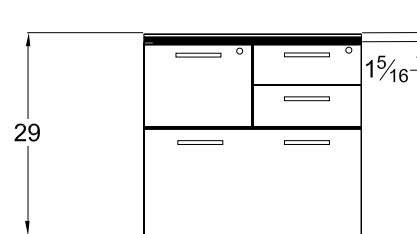

Pedestal Front Profile Multi-File



Central park modesty reference

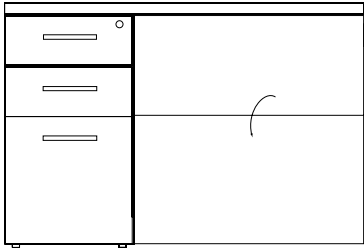

Top View

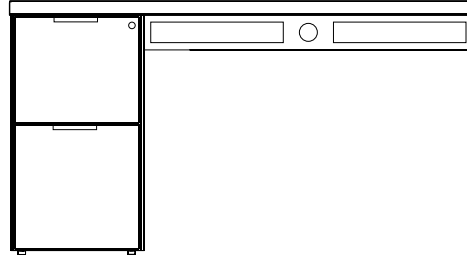

**M51**  
Open Back Modesty with 4"  
Wire Management Rail

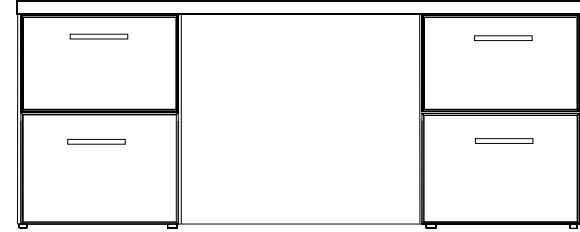

**M37**  
Fixed Full Modesty

**M34**  
Drop Door Tech Modesty

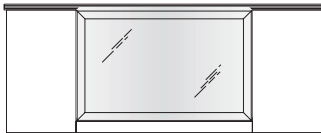

**M39**  
Full Modesty  
SilverLuma Frame w/ Frost Insert

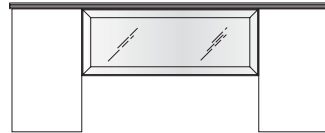

**HM39**  
Half Modesty  
SilverLuma Frame w/ Frost Insert

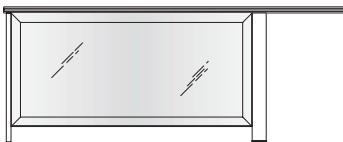

**M45**  
Full Modesty  
SilverLuma Frame w/ Frost Insert

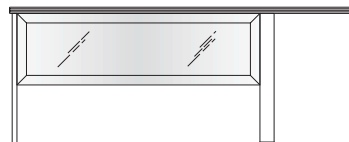

**HM45**  
Half Modesty  
SilverLuma Frame w/ Frost Insert

Central park door detail | grain direction

Panel doors

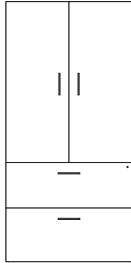

Silverluma frame with frosted panel

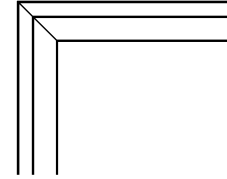
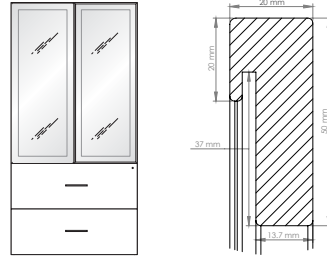

Grain direction

Veneer chassis parts are vertical grain with the exception of Rift chassis parts. The backs of Thermally Fused Laminate overheads, wall hungs, wall hung shelves and flush chassis desks are horizontal grain. Bridges, returns, and credenza kneespace Thermally Fused Laminate backs over 60" are horizontal grain.



Desk

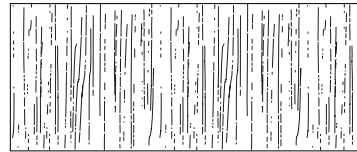

Runoff Desk  
Grain Direction on TFL  
Units Above 60" runs end to end

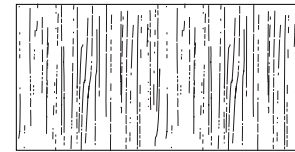

Bridge  
Grain Direction on TFL  
Units Above 60" runs end to end



Credenza

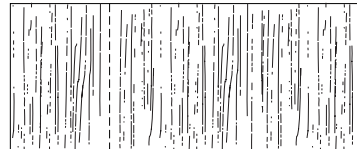

Return  
Grain Direction on TFL  
Units Above 60" runs end to end

## Central park drawer dimensions | filing reference

### Interior drawer dimensions

UNIT DEPTH	DRAWER TYPE	OVERALL DIMENSIONS			INTERIOR DRAWER DIMENSIONS			NOTES
		W	D	H	W	D	H	
15-5/8" Letter	36" Box	13-1/8	19-11/16	4	12-1/8	18-11/16	3-7/16	Units less than 72"
	36" File	13-1/8	19-11/16	9-13/16	12-1/8	18-11/16	9-5/16	Units less than 72"
	30" Box	13-1/8	19-11/16	4	12-1/8	18-11/16	3-7/16	Units less than 72"
	30" File	13-1/8	19-11/16	9-13/16	12-1/8	18-11/16	9-5/16	Units less than 72"
	24" Box	13-1/8	16-1/16	4	12-1/8	15-1/16	3-7/16	Units less than 72"
	24" File	13-1/8	16-1/16	9-13/16	12-1/8	15-1/16	9-5/16	Units less than 72"
29" Lateral	24" Box	26-1/2	16-1/16	4	25-1/2	15-1/16	3-7/16	Workstation Credenzas less than 82"
	24" File	26-1/2	16-1/16	9-13/16	25-1/2	15-1/16	9-5/16	Workstation Credenzas less than 82"
31" Lateral	24" File	28-9/16	16-1/16	9-13/16	27-9/16	15-1/16	9-5/16	Multi-File Lateral File
35" Lateral	24" Box	32-1/2	16-1/16	4	31-1/2	15-1/16	3-7/16	Workstation Credenzas over 83"
	24" File	32-1/2	16-1/16	9-13/16	31-1/2	15-1/16	9-5/16	Workstation Credenzas over 83"
41" Lateral	24" File	38-1/2	16-1/16	9-13/16	37-1/2	15-1/16	9-5/16	Wood Drawer Only

### Filing reference

#### Filing for 24" depth units

13 1/8" Wide File Drawer - 16 1/16" Deep

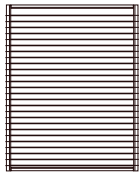

Letter Front to Back

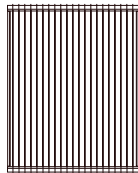

Legal Side to Side with File Rail

#### 29" and 31" Lateral file drawer

29" : 26-1/2" Wide File Drawer - 16-1/16" Deep

31" : 28 9/16" Wide File Drawer - 16-1/16" Deep

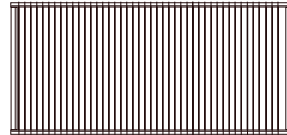

Legal Side to Side

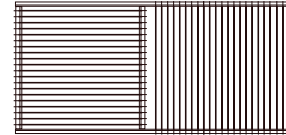

Legal Side to Side Letter Front to Back with File Rail



Letter Front to Back with File Rail

#### Filing for 30" & 36" depth units

13 1/8" Wide File Drawer - 19 11/16" Deep

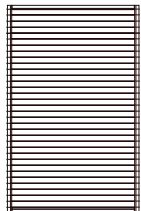

Letter Front to Back

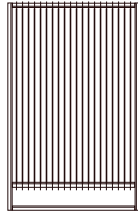

Legal Side to Side with File Rail

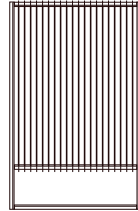

Letter Side to Side with File Rail

#### 35" and 41" Lateral file drawer

35" : 32-1/2" Wide File Drawer - 16-1/16" Deep

41" : 38-1/2" Wide File Drawer - 16 1/16" Deep

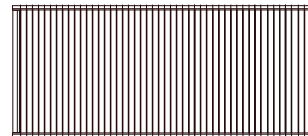

Legal Side to Side

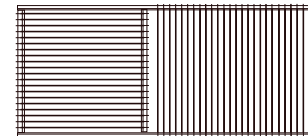

Legal Side to Side Letter Front to Back with File Rail

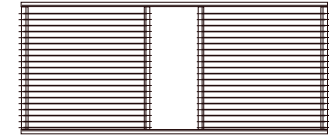

Letter Front to Back with File Rail

# Central park.

Breakfront Chassis Desks  
Double Pedestal Desk

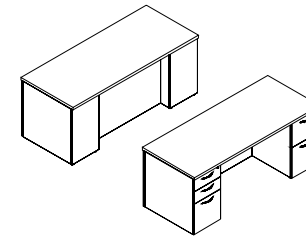

## 1 Select a model

w" x d" x h"

weight	Standard Veneer Top		Premium Veneer Top		High Pressure Laminate Top		Thermally Fused Laminate Top	
	Standard Veneer Chassis		Premium Veneer Chassis		Veneer Chassis		Thermally Fused Laminate Chassis	
84 x 36 x 29	345	CPC8436DD000W 4106	CPC8436DD000P 4517	CPC8436DD000G 4106	CPC8436DD000M 2286			
72 x 36 x 29	315	CPC7236DD000W 3703	CPC7236DD000P 4073	CPC7236DD000G 3703	CPC7236DD000M 2240			
72 x 30 x 29	300	CPC7230DD000W 3667	CPC7230DD000P 4034	CPC7230DD000G 3667	CPC7230DD000M 1941			
66 x 36 x 29	300	CPC6636DD000W 3678	CPC6636DD000P 4046	CPC6636DD000G 3678	CPC6636DD000M 2225			
66 x 30 x 29	270	CPC6630DD000W 3576	CPC6630DD000P 3934	CPC6630DD000G 3576	CPC6630DD000M 1916			
60 x 30 x 29	260	CPC6030DD000W 3365	CPC6030DD000P 3702	CPC6030DD000G 3365	CPC6030DD000M 1890			

[View statement of line](#)

## 2 Select a finish

[View finish details](#)

WAC	WGW	TBCO	WSO	GAC	GNW	MAC
WRC	WBW	TBSW		GIC	GSTV +10%	MEC
WIC	WSW	TSTV		GEC	GSLV +10%	MHC
WEC	WNW	TSMV		GHC	GWL	MOC
WHC	WWP	TSLV		GOC		MGW
WOC		TOBW		GAM		MTW
WAM		WBO		GCM		MSW
WCM		WMO		GWM		MWL
WWW		WNO		GEW		
WEW						

## 3 Select a edge

[View edge details](#)



## 4 Select hardware

[View hardware details](#)

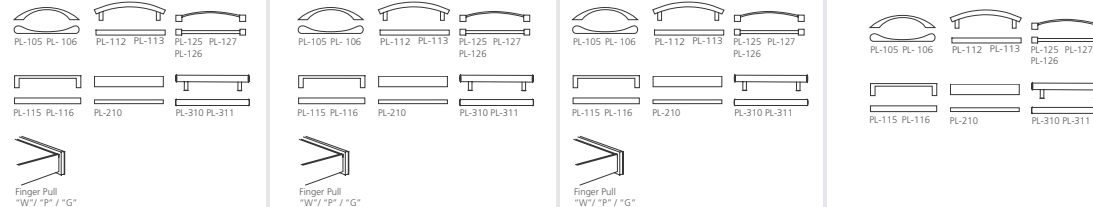

## Product features.

- Box/Box/File (left)
- Breakfront chassis
- File/File (right)
- Legal/Letter filing
- "W" & "G" SKUs feature soft close suspensions, "M" SKUs feature ball bearing suspensions. Both suspensions are full extension.

### NOTES

- All units are standard w/ flush ends
- Modesty is recessed 6"

## Options.

### ACCESSORIES

- K28: Articulating Keyboard w/ Mouse - \$390
- K31: Center drawer - \$205

### DRAWER

- P6: Modify File/File to Box/Box/File - \$55 per pedestal
- P33: Wood Drawer Upgrade - \$45 per drawer
- WPD3061: Designer White - \$80 per pedestal

### GROMMETS (STANDARD LOCATION)

- Specify Color and Left/Right - \$50 ea.
- Black: TM30-R (Right), TM30-L (Left)
  - Silver: TM31-R (Right), TM31-L (Left)
  - Antique Brass: TM33-R (Right), TM33-L (Left)

### GROMMETS (NON-STANDARD LOCATION)

- Provide drawing w/ Grommet Location and Specify Color - \$95 ea.
- Black: TM30-NS
  - Silver: TM31-NS
  - Antique Brass: TM33-NS

### MODESTY

- M39: SilverLuma frame/frost (Full Modesty) - \$650
- HM39: SilverLuma frame/frost (Half Modesty) - \$340

# Central park.

Breakfront Chassis Desks  
Bowfront Double Pedestal Desk

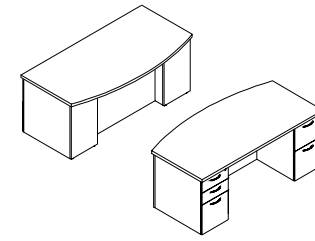

[View statement of line](#)

1 Select a model w" x d" x h"	weight	Standard Veneer Top		Premium Veneer Top		High Pressure Laminate Top		Thermally Fused Laminate Top	
		Standard Veneer Chassis		Premium Veneer Chassis		Veneer Chassis		Thermally Fused Laminate Chassis	
84 x 36/42 x 29	360	CPC8442DD006W	4581	CPC8442DD006P	5040	CPC8442DD006G	4581	CPC8442DD006M	2362
72 x 36/42 x 29	340	CPC7242DD006W	4179	CPC7242DD006P	4597	CPC7242DD006G	4179	CPC7242DD006M	2316
72 x 30/36 x 29	335	CPC7236DD006W	4120	CPC7236DD006P	4532	CPC7236DD006G	4120	CPC7236DD006M	2017
66 x 30/36 x 29	305	CPC6636DD006W	3949	CPC6636DD006P	4344	CPC6636DD006G	3949	CPC6636DD006M	1966

2 Select a finish <a href="#">View finish details</a>	Standard Veneer Top		Premium Veneer Top		High Pressure Laminate Top		Thermally Fused Laminate Top	
WAC	WGW	TBCO	WSO	GAC	GNW	MAC		
WRC	WBW	TBSW		GIC	GSTV +10%	MEC		
WIC	WSW	TSTV		GEC	GSLV +10%	MHC		
WEC	WNW	TSMV		GHC	GWL	MOC		
WHC	WWP	TSLV		GOC		MGW		
WOC		TOBW		GAM		MTW		
WAM		WBO		GCM		MSW		
WCM		WMO		GWM		MWL		
WWM		WNO		GEW				
WEW								

3 Select a edge <a href="#">View edge details</a>	Standard Veneer Top		Premium Veneer Top		High Pressure Laminate Top		Thermally Fused Laminate Top				
+5%						+5%					
Flat	Knife	Ledge	Ogee	Flat	Knife	Ledge	Ogee	Flat	Knife	Ledge	Ogee
Reed	Radius	Waterfall		Reed	Radius	Waterfall		Reed	Radius	Waterfall	

4 Select hardware <a href="#">View hardware details</a>	Standard Veneer Top		Premium Veneer Top		High Pressure Laminate Top		Thermally Fused Laminate Top				

## Product features.

- Box/Box/File (left)
- Breakfront chassis
- File/File (right)
- Legal/Letter filing
- "W" & "G" SKUs feature soft close suspensions, "M" SKUs feature ball bearing suspensions. Both suspensions are full extension.

### NOTES

- All units are standard w/ flush ends
- Modesty is recessed 12"
- Overhang 6"

## Options.

### ACCESSORIES

- K28: Articulating Keyboard w/ Mouse - \$390
- K31: Center drawer - \$205

### DRAWER

- P6: Modify File/File to Box/Box/File - \$55 per pedestal
- P33: Wood Drawer Upgrade - \$45 per drawer
- WPD3061: Designer White - \$80 per pedestal

### GROMMETS (STANDARD LOCATION)

- Specify Color and Left/Right - \$50 ea.
- Black: TM30-R (Right), TM30-L (Left)
- Silver: TM31-R (Right), TM31-L (Left)
- Antique Brass: TM33-R (Right), TM33-L (Left)

### GROMMETS (NON-STANDARD LOCATION)

- Provide drawing w/ Grommet Location and Specify Color - \$95 ea.
- Black: TM30-NS
- Silver: TM31-NS
- Antique Brass: TM33-NS

### MODESTY

- M39: SilverLuma frame/frost (Full Modesty) - \$650
- HM39: SilverLuma frame/frost (Half Modesty) - \$340

# Central park.

Breakfront Chassis Desks

Conference Overhang Double Pedestal Desk

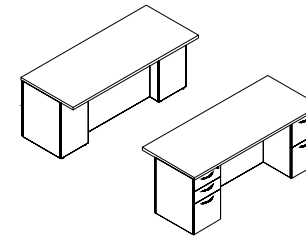

## 1 Select a model

w" x d" x h"

weight	Standard Veneer Top Standard Veneer Chassis		Premium Veneer Top Premium Veneer Chassis		High Pressure Laminate Top Veneer Chassis		Thermally Fused Laminate Top Thermally Fused Laminate Chassis	
	<b>72 x 30 Chassis</b> 72 x 36 x 29	315	CPC7236DD037W 3546	CPC7236DD037P 3901	CPC7236DD037G 3546	CPC7236DD037M 2017		
<b>72 x 24 Chassis</b> 72 x 30 x 29	300	CPC7230DD037W 3503	CPC7230DD037P 3853	CPC7230DD037G 3503	CPC7230DD037M 1909			
<b>66 x 30 Chassis</b> 66 x 36 x 29	300	CPC6636DD037W 3520	CPC6636DD037P 3872	CPC6636DD037G 3520	CPC6636DD037M 1966			
<b>66 x 24 Chassis</b> 66 x 30 x 29	280	CPC6630DD037W 3295	CPC6630DD037P 3625	CPC6630DD037G 3295	CPC6630DD037M 1884			

[View statement of line](#)

## 2 Select a finish

[View finish details](#)

WAC WGW  
WRC WBW  
WIC WSW  
WEC WNW  
WHC WWP  
WOC  
WAM  
WCM  
WWM  
WEW

TBCO WSO  
TBSW  
TSTV  
TSMV  
TSLV  
TOBW  
WBO  
WMO  
WNO

GAC GNW  
GIC GSTV +10%  
GEC GSLV +10%  
GHC GWL  
GOC  
GAM  
GCM  
GWM  
GEW

MAC  
MEC  
MHC  
MOC  
MGW  
MTW  
MSW  
MWL

## 3 Select a edge

[View edge details](#)



## 4 Select hardware

[View hardware details](#)

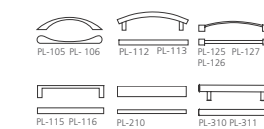
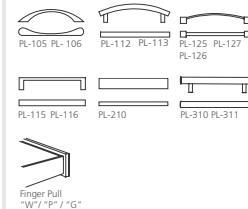
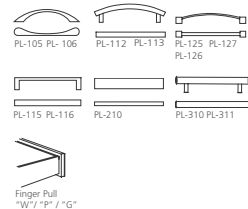
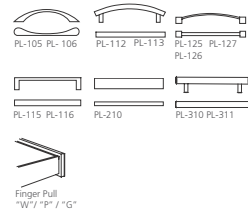

## Product features.

- Box/Box/File (left)
- Breakfront chassis
- File/File (right)
- Legal/Letter filing
- "W" & "G" SKUs feature soft close suspensions, "M" SKUs feature ball bearing suspensions. Both suspensions are full extension.

### NOTES

- All units are standard w/ flush ends
- Modesty is recessed 12"
- Overhang 6"

## Options.

### ACCESSORIES

- K28: Articulating Keyboard w/ Mouse - \$390
- K31: Center drawer - \$205

### DRAWER

- P6: Modify File/File to Box/Box/File - \$55 per pedestal
- P33: Wood Drawer Upgrade - \$45 per drawer
- WPD3061: Designer White - \$80 per pedestal

### GROMMETS (STANDARD LOCATION)

- Specify Color and Left/Right - \$50 ea.
- Black: TM30-R (Right), TM30-L (Left)
  - Silver: TM31-R (Right), TM31-L (Left)
  - Antique Brass: TM33-R (Right), TM33-L (Left)

### GROMMETS (NON-STANDARD LOCATION)

- Provide drawing w/ Grommet Location and Specify Color - \$95 ea.
- Black: TM30-NS
  - Silver: TM31-NS
  - Antique Brass: TM33-NS

### MODESTY

- M39: SilverLuma frame/frost (Full Modesty) - \$650
- HM39: SilverLuma frame/frost (Half Modesty) - \$340

# Central park.

Breakfront Chassis Desks

Bowfront Conference Overhang Double Pedestal Desk

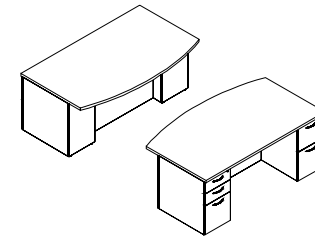

[View statement of line](#)

1 Select a model w" x d" x h"	weight	Standard Veneer Top Standard Veneer Chassis		Premium Veneer Top Premium Veneer Chassis		High Pressure Laminate Top Veneer Chassis		Thermally Fused Laminate Top Thermally Fused Laminate Chassis	
		72 x 30 Chassis 72 x 36/42 x 29	325	CPC7242DD043W	4048	CPC7242DD043P	4453	CPC7242DD043G	4048

2 Select a finish <a href="#">View finish details</a>	Standard Veneer Top		Premium Veneer Top		High Pressure Laminate Top		Thermally Fused Laminate Top	
		WAC	WGW	TBCO	WSO	GAC	GNW	MAC
	WRC	WBW	TBSW		GIC	GSTV +10%	MEC	
	WIC	WSW	TSTV		GEC	GSLV +10%	MHC	
	WEC	WNW	TSMV		GHC	GWL	MOC	
	WHC	WWP	TSLV		GOC		MGW	
	WOC		TOBW		GAM		MTW	
	WAM		WBO		GCM		MSW	
	WCM		WMO		GWM		MWL	
	WWM		WNO		GEW			
	WEW							

3 Select a edge <a href="#">View edge details</a>	Standard Veneer Top		Premium Veneer Top		High Pressure Laminate Top		Thermally Fused Laminate Top	
		Bullnose	Classic	Cobee	Cove	Flat	Ledge	Bullnose
	Reed	Radius	Waterfall		Flat	Knife	Ledge	Ogee

4 Select hardware <a href="#">View hardware details</a>	Standard Veneer Top		Premium Veneer Top		High Pressure Laminate Top		Thermally Fused Laminate Top	
		PL-105 PL-106	PL-112 PL-113	PL-125 PL-127	PL-126	PL-105 PL-106	PL-112 PL-113	PL-125 PL-127
	PL-115 PL-116	PL-210	PL-310 PL-311		PL-115 PL-116	PL-210	PL-310 PL-311	
	Finger Pull "W"/"P"/"G"				Finger Pull "W"/"P"/"G"			

## Product features.

- Box/Box/File (left)
- Breakfront chassis
- File/File (right)
- Full extension drawers - locking
- Legal/Letter filing
- "W" & "G" SKUs feature soft close suspensions, "M" SKUs feature ball bearing suspensions. Both suspensions are full extension.

### NOTES

- All units are standard w/ flush ends
- Modesty is recessed 18"
- Overhang 12"

## Options.

### ACCESSORIES

- K28: Articulating Keyboard w/ Mouse - \$390
- K31: Center drawer - \$205

### DRAWER

- P6: Modify File/File to Box/Box/File - \$55 per pedestal
- P33: Wood Drawer Upgrade - \$45 per drawer
- WPD3061: Designer White - \$80 per pedestal

### GROMMETS (STANDARD LOCATION)

- Specify Color and Left/Right - \$50 ea.
- Black: TM30-R (Right), TM30-L (Left)
  - Silver: TM31-R (Right), TM31-L (Left)
  - Antique Brass: TM33-R (Right), TM33-L (Left)

### GROMMETS (NON-STANDARD LOCATION)

- Provide drawing w/ Grommet Location and Specify Color - \$95 ea.
- Black: TM30-NS
  - Silver: TM31-NS
  - Antique Brass: TM33-NS

### MODESTY

- M39: SilverLuma frame/frost (Full Modesty) - \$650
- HM39: SilverLuma frame/frost (Half Modesty) - \$340

# Central park.

Breakfront Chassis Desks

Height Adjustable Double Pedestal Desk

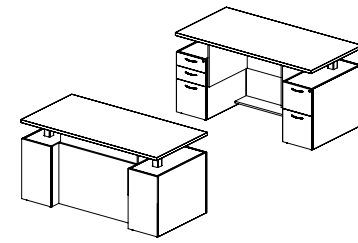

## 1 Select a model w" x d" x h"

weight	Standard Veneer Top		Premium Veneer Top		High Pressure Laminate Top		Thermally Fused Laminate Top	
	Standard Veneer Chassis		Premium Veneer Chassis		Veneer Chassis		Thermally Fused Laminate Chassis	
84 x 36 x 29	345	CPC8436DD004W 7638	CPC8436DD004P 8402	CPC8436DD004G 7638	CPC8436DD004M 5905			
72 x 36 x 29	315	CPC7236DD004W 7379	CPC7236DD004P 8117	CPC7236DD004G 7379	CPC7236DD004M 5827			
72 x 30 x 29	300	CPC7230DD004W 7109	CPC7230DD004P 7820	CPC7230DD004G 7109	CPC7230DD004M 5451			
66 x 36 x 29	300	CPC6636DD004W 7227	CPC6636DD004P 7950	CPC6636DD004G 7227	CPC6636DD004M 5730			
66 x 30 x 29	270	CPC6630DD004W 6963	CPC6630DD004P 7659	CPC6630DD004G 6963	CPC6630DD004M 5327			
60 x 30 x 29	260	CPC6030DD004W 6901	CPC6030DD004P 7591	CPC6030DD004G 6901	CPC6030DD004M 5293			

[View statement of line](#)

## 2 Select a finish

[View finish details](#)

WAC	WGW	TBCO	WSO	GAC	GNW	MAC
WRC	WBW	TBSW		GIC	GSTV +10%	MEC
WIC	WSW	TSTV		GEC	GSLV +10%	MHC
WEC	WNW	TSMV		GHC	GWL	MOC
WHC	WWP	TSLV		GOC		MGW
WOC		TOBW		GAM		MTW
WAM		WBO		GCM		MSW
WCM		WMO		GWM		MWL
WWM		WNO		GEW		
WEW						

## 3 Select a edge

[View edge details](#)

Bullnose	Classic	Cobee	Cove	Flat	Ledge	Bullnose	Classic	Cobee	Cove	Flat
Flat	Knife	Ledge	Ogee	Flat	Knife	Ledge	Ogee	Flat	Knife	Ledge
Reed	Radius	Waterfall		Reed	Radius	Waterfall		Reed	Radius	Waterfall

## 4 Select hardware

[View hardware details](#)

PL-105 PL-106	PL-112 PL-113	PL-125 PL-127 PL-126	PL-105 PL-106	PL-112 PL-113	PL-125 PL-127 PL-126	PL-105 PL-106	PL-112 PL-113	PL-125 PL-127 PL-126	PL-105 PL-106	PL-112 PL-113	PL-125 PL-127 PL-126
PL-115 PL-116	PL-210	PL-310 PL-311	PL-115 PL-116	PL-210	PL-310 PL-311	PL-115 PL-116	PL-210	PL-310 PL-311	PL-115 PL-116	PL-210	PL-310 PL-311
Finger Pull "W"/"P"/"G"			Finger Pull "W"/"P"/"G"			Finger Pull "W"/"P"/"G"			Finger Pull "W"/"P"/"G"		

## Product features.

- Adjustable height from 29" to 47.5" with a maximum weight capacity of 350 lbs.
- Box/Box/File (left)
- Breakfront chassis
- File/File (right)
- Lift available in MFS Silver (standard) or MFB Black (optional)
- Legal/Letter filing
- Metal parts include 5 year warranty
- Privacy surround panels
- Programmable height adjustable mechanism, motor includes 2 year warranty
- "W" & "G" SKUs feature soft close suspensions, "M" SKUs feature ball bearing suspensions. Both suspensions are full extension.

### NOTES

- All units are standard w/ flush ends
- Modesty is recessed 6"

## Options.

### ACCESSORIES

- K28: Articulating Keyboard w/ Mouse - \$390
- K31: Center drawer - \$205

### DRAWER

- P6: Modify File/File to Box/Box/File - \$55 per pedestal
- P33: Wood Drawer Upgrade - \$45 per drawer
- WPD3061: Designer White - \$80 per pedestal fronts

### GROMMETS (STANDARD LOCATION)

- Specify Color and Left/Right - \$50 ea.
- Black: TM30-R (Right), TM30-L (Left)
- Silver: TM31-R (Right), TM31-L (Left)
- Antique Brass: TM33-R (Right), TM33-L (Left)

### GROMMETS (NON-STANDARD LOCATION)

- Provide drawing w/ Grommet Location and Specify Color - \$95 ea.
- Black: TM30-NS
- Silver: TM31-NS
- Antique Brass: TM33-NS

### MODESTY

- M39: SilverLuma frame/frost (Full Modesty) - \$650
- Wire Management
- LWMB: Lift wire management box with flip down door - \$365
- Power strip with five outlets and 12' cord, mesh wire cover, 6" deep black box



# Central park.

Flush Chassis Desks W/ Overhang  
Full Double Pedestal Desk

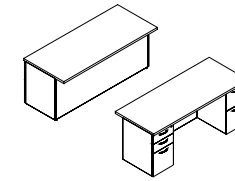

[View statement of line](#)

1 Select a model w" x d" x h"	weight	Standard Veneer Top Standard Veneer Chassis		Premium Veneer Top Premium Veneer Chassis		High Pressure Laminate Top Veneer Chassis		Thermally Fused Laminate Top Thermally Fused Laminate Chassis	
		84 x 36 x 29	365	CPC8436DD032W	3931	CPC8436DD032P	4325	CPC8436DD032G	3931
72 x 36 x 29	330	CPC7236DD032W	3546	CPC7236DD032P	3901	CPC7236DD032G	3546	CPC7236DD032M	2017
72 x 30 x 29	320	CPC7230DD032W	3426	CPC7230DD032P	3769	CPC7230DD032G	3426	CPC7230DD032M	1909
66 x 36 x 29	315	CPC6636DD032W	3520	CPC6636DD032P	3872	CPC6636DD032G	3520	CPC6636DD032M	1966
66 x 30 x 29	295	CPC6630DD032W	3295	CPC6630DD032P	3625	CPC6630DD032G	3295	CPC6630DD032M	1884
60 x 30 x 29	275	CPC6030DD032W	3086	CPC6030DD032P	3395	CPC6030DD032G	3086	CPC6030DD032M	1768

2 Select a finish <a href="#">View finish details</a>	3 Select a edge <a href="#">View edge details</a>	4 Select hardware <a href="#">View hardware details</a>
WAC    WGW WRC    WBW WIC    WSW WEC    WNW WHC    WWP WOC WAM WCM WWM WEW		
TBCO    WSO TBSW TSTV TSMV TSLV TOBW WBO WMO WNO		
GAC    GNW GIC    GSTV +10% GEC    GSLV +10% GHC    GWL GOC GAM GCM GWM GEW		
MAC MEC MHC MOC MGW MTW MSW MWL		

## Product features.

- Box/Box/File (left)
- File/File (right)
- Legal/Letter filing
- "W" & "G" SKUs feature soft close suspensions, "M" SKUs feature ball bearing suspensions. Both suspensions are full extension.

### NOTES

- All units are standard w/ flush ends
- Modesty is recessed 6"
- 36" units have 30" chassis
- 30" units have 24" chassis

## Options.

### ACCESSORIES

- K28: Articulating Keyboard w/ Mouse - \$390
- K31: Center drawer - \$205

### DRAWER

- P6: Modify File/File to Box/Box/File - \$55 per pedestal
- P33: Wood Drawer Upgrade - \$45 per drawer
- WPD3061: Designer White - \$80 per pedestal

### GROMMETS (STANDARD LOCATION)

- Specify Color and Left/Right - \$50 ea.
- Black: TM30-R (Right), TM30-L (Left)
  - Silver: TM31-R (Right), TM31-L (Left)
  - Antique Brass: TM33-R (Right), TM33-L (Left)

### GROMMETS (NON-STANDARD LOCATION)

- Provide drawing w/ Grommet Location and Specify Color - \$95 ea.
- Black: TM30-NS
  - Silver: TM31-NS
  - Antique Brass: TM33-NS

# Central park.

Flush Chassis Desks W/ Overhang

Height Adjustable Full Double Pedestal Desk

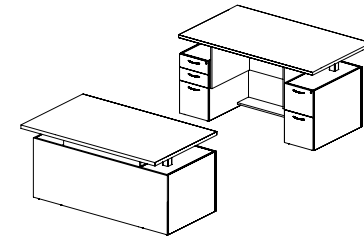

[View statement of line](#)

## 1 Select a model

w" x d" x h"

weight	Standard Veneer Top		Premium Veneer Top		High Pressure Laminate Top		Thermally Fused Laminate Top	
	Standard Veneer Chassis		Premium Veneer Chassis		Veneer Chassis		Thermally Fused Laminate Chassis	
84 x 36 x 29	365	CPC8436DD033W 7412	CPC8436DD033P 8154	CPC8436DD033G 7412	CPC8436DD033M 5680			
72 x 36 x 29	330	CPC7236DD033W 7154	CPC7236DD033P 7869	CPC7236DD033G 7154	CPC7236DD033M 5602			
72 x 30 x 29	320	CPC7230DD033W 6884	CPC7230DD033P 7572	CPC7230DD033G 6884	CPC7230DD033M 5225			
66 x 36 x 29	315	CPC6636DD033W 7002	CPC6636DD033P 7702	CPC6636DD033G 7002	CPC6636DD033M 5506			
66 x 30 x 29	295	CPC6630DD033W 6738	CPC6630DD033P 7412	CPC6630DD033G 6738	CPC6630DD033M 5102			
60 x 30 x 29	275	CPC6030DD033W 6677	CPC6030DD033P 7345	CPC6030DD033G 6677	CPC6030DD033M 5068			

## 2 Select a finish

[View finish details](#)

WAC	WGW	TBCO	WSO	GAC	GNW	MAC
WRC	WBW	TBSW		GIC	GSTV +10%	MEC
WIC	WSW	TSTV		GEC	GSLV +10%	MHC
WEC	WNW	TSMV		GHC	GWL	MOC
WHC	WWP	TSLV		GOC		MGW
WOC		TOBW		GAM		MTW
WAM		WBO		GCM		MSW
WCM		WMO		GWM		MWL
WWW		WNO		GEW		
WEW						

## 3 Select a edge

[View edge details](#)



## 4 Select hardware

[View hardware details](#)

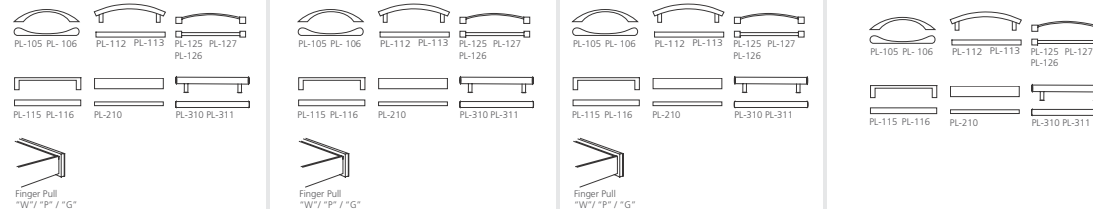

## Product features.

- Adjustable height from 29" to 47.5" with a maximum weight capacity of 350 lbs.
- Box/Box/File (left)
- File/File (right)
- Legal/Letter filing
- Lift available in MFS Silver (standard) or MFB Black (optional)
- Metal parts include 5 year warranty
- Privacy surround panels
- Programmable height adjustable mechanism, motor includes 2 year warranty
- "W" & "G" SKUs feature soft close suspensions, "M" SKUs feature ball bearing suspensions. Both suspensions are full extension.

### NOTES

- All units are standard w/ flush ends
- Modesty is recessed 6"
- 36" units have 30" chassis
- 30" units have 24" chassis

## Options.

### ACCESSORIES

- K28: Articulating Keyboard w/ Mouse - \$390
- K31: Center drawer - \$205

### DRAWER

- P6: Modify File/File to Box/Box/File - \$55 per pedestal
- P33: Wood Drawer Upgrade - \$45 per drawer
- WPD3061: Designer White - \$80 per pedestal fronts

### GROMMETS (STANDARD LOCATION)

- Specify Color and Left/Right - \$50 ea.
- Black: TM30-R (Right), TM30-L (Left)
- Silver: TM31-R (Right), TM31-L (Left)
- Antique Brass: TM33-R (Right), TM33-L (Left)

### GROMMETS (NON-STANDARD LOCATION)

- Provide drawing w/ Grommet Location and Specify Color - \$95 ea.
- Black: TM30-NS
- Silver: TM31-NS
- Antique Brass: TM33-NS

### WIRE MANAGEMENT

- LWMB: Lift wire management box with flip down door - \$365
- Power strip with five outlets and 12' cord, mesh wire cover, 6" deep black box

# Central park.

Table Desks With Sleigh Base  
Rectangle With Sleigh Legs

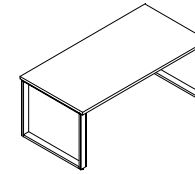

[View statement of line](#)

1 Select a model w" x d" x h"	weight	Standard Veneer Top Standard Veneer Chassis		Premium Veneer Top Premium Veneer Chassis		High Pressure Laminate Top Veneer Chassis		Thermally Fused Laminate Top Thermally Fused Laminate Chassis	
		72 x 36 x 29	150	CPC7236DT099W	2897	CPC7236DT099P	3187	CPC7236DT099G	2897
72 x 30 x 29	135	CPC7230DT099W	2779	CPC7230DT099P	3057	CPC7230DT099G	2779	CPC7230DT099M	1519
66 x 30 x 29	125	CPC6630DT099W	2739	CPC6630DT099P	3013	CPC6630DT099G	2739	CPC6630DT099M	1499
60 x 30 x 29	115	CPC6030DT099W	2706	CPC6030DT099P	2977	CPC6030DT099G	2706	CPC6030DT099M	1479

2 Select a finish <a href="#">View finish details</a>	Standard Veneer Top		Premium Veneer Top		High Pressure Laminate Top		Thermally Fused Laminate Top	
<b>Metal finish</b> MFS Silver. Additional metal finishes are available, see options.	WAC	WGW	TBCO	WSO	GAC	GNW	MAC	
	WRC	WBW	TBSW		GIC	GSTV +10%	MEC	
	WIC	WSW	TSTV		GEC	GSLV +10%	MHC	
	WEC	WNW	TSMV		GHC	GWL	MOC	
	WHC	WWP	TSLV		GOC		MGW	
	WOC		TOBW		GAM		MTW	
	WAM		WBO		GCM		MSW	
	WCM		WMO		GWM		MWL	
	WWM		WNO		GEW			
	WEW							

3 Select a edge <a href="#">View edge details</a>	Standard Veneer Top		Premium Veneer Top		High Pressure Laminate Top		Thermally Fused Laminate Top	
	+5%						+5%	
	Bullnose	Classic	Cobee	Cove	Flat	Ledge	Bullnose	Classic
				+5%				+5%
	Flat	Knife	Ledge	Ogee	Flat	Knife	Ledge	Ogee
		+5%				+5%		
	Reed	Radius	Waterfall		Reed	Radius	Waterfall	

4 Select hardware <a href="#">View hardware details</a>	Standard Veneer Top	Premium Veneer Top	High Pressure Laminate Top	Thermally Fused Laminate Top
	Hardware N/A	Hardware N/A	Hardware N/A	Hardware N/A

## Product features.

- Metal sleigh base - standard silver finish

### NOTES

- All units are standard w/ flush ends

## Options.

### ACCESSORIES

- K28: Articulating Keyboard w/ Mouse - \$390
- K31: Center drawer - \$205
- K31-SK: Center drawer w/ skirt - \$310

### GROMMETS (STANDARD LOCATION)

- Specify Color and Left/Right - \$50 ea.
- Black: TM30-R (Right), TM30-L (Left)
  - Silver: TM31-R (Right), TM31-L (Left)
  - Antique Brass: TM33-R (Right), TM33-L (Left)

### GROMMETS (NON-STANDARD LOCATION)

- Provide drawing w/ Grommet Location and Specify Color - \$95 ea.
- Black: TM30-NS
  - Silver: TM31-NS
  - Antique Brass: TM33-NS

### MODESTY

- HM45: SilverLuma frame/frost insert (half modesty) - \$415
- MC51: Half veneer/laminate modesty - \$130

### PREMIUM FINISH OPTION

- MFB: Black metal finish - \$160 per base

# Central park.

Desks

Crt Desk / Printer

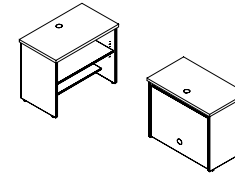

## 1 Select a model

w" x d" x h"

weight	Standard Veneer Top		Premium Veneer Top		High Pressure Laminate Top		Thermally Fused Laminate Top	
	Standard Veneer Chassis		Premium Veneer Chassis		Veneer Chassis		Thermally Fused Laminate Chassis	
48 x 24 x 29	150	CPC4824AU225W 1536	CPC4824AU225P 1690	CPC4824AU225G 1536	CPC4824AU225M 976			
35 x 24 x 29	110	CPC3524AU225W 1437	CPC3524AU225P 1581	CPC3524AU225G 1437	CPC3524AU225M 910			
29 x 24 x 29	95	CPC2924AU225W 1335	CPC2924AU225P 1469	CPC2924AU225G 1335	CPC2924AU225M 843			

[View statement of line](#)

## 2 Select a finish

[View finish details](#)

WAC	WGW	TBCO	WSO	GAC	GNW	MAC
WRC	WBW	TBSW		GIC	GSTV +10%	MEC
WIC	WSW	TSTV		GEC	GSLV +10%	MHC
WEC	WNW	TSMV		GHC	GWL	MOC
WHC	WWP	TSLV		GOC		MGW
WOC		TOBW		GAM		MTW
WAM		WBO		GCM		MSW
WCM		WMO		GWM		MWL
WWW		WNO		GEW		
WEW						

## 3 Select a edge

[View edge details](#)

Bullnose	Classic	Cobee	Cove	Flat	Ledge	Bullnose	Classic	Cobee	Cove	Flat
Flat	Knife	Ledge	Ogee	Flat	Knife	Ledge	Ogee	Flat	Knife	Ledge
Reed	Radius	Waterfall		Reed	Radius	Waterfall		Reed	Radius	Waterfall

## 4 Select hardware

[View hardware details](#)

Hardware	Hardware	Hardware	Hardware
N/A	N/A	N/A	N/A

## Product features.

- 1 Standard grommet - matches pull finish or specify black TM30, silver TM31 or antique brass TM33
- 6" D Foot rest/adjustable storage shelf
- Paper/wire access back
- Vertical surface grommet - TM50 Black

### NOTES

- All units are standard w/ flush ends

## Options.

### ACCESSORIES

- K28: Articulating Keyboard w/ Mouse - \$390

### GROMMETS (NON-STANDARD LOCATION)

Provide drawing w/ Grommet Location and Specify Color - \$95 ea.

- Black: TM30-NS

- Silver: TM31-NS

- Antique Brass: TM33-NS

### GROMMETS (VERTICAL SURFACE)

Non-Standard Location - \$95 ea.

- Black Plastic Vertical Surface: TM50-NS

# Central park.

Double Breakfront / Single Pedestal Desks  
Single Full Pedestal

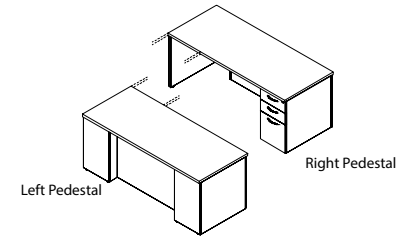

1 Select a model  
w" x d" x h"

weight	Standard Veneer Top Standard Veneer Chassis		Premium Veneer Top Premium Veneer Chassis		High Pressure Laminate Top Veneer Chassis		Thermally Fused Laminate Top Thermally Fused Laminate Chassis	
<b>Left Pedestal</b>								
72 x 36 x 29	275	CPC7236DS009W 3300	CPC7236DS009P 3630	CPC7236DS009G 3300	CPC7236DS009M 1920			
72 x 30 x 29	265	CPC7230DS009W 3187	CPC7230DS009P 3506	CPC7230DS009G 3187	CPC7230DS009M 1691			
66 x 36 x 29	265	CPC6636DS009W 3225	CPC6636DS009P 3548	CPC6636DS009G 3225	CPC6636DS009M 1904			
66 x 30 x 29	225	CPC6630DS009W 3112	CPC6630DS009P 3423	CPC6630DS009G 3112	CPC6630DS009M 1652			
<b>Right Pedestal</b>								
72 x 36 x 29	275	CPC7236DS010W 3300	CPC7236DS010P 3630	CPC7236DS010G 3300	CPC7236DS010M 1920			
72 x 30 x 29	265	CPC7230DS010W 3187	CPC7230DS010P 3506	CPC7230DS010G 3187	CPC7230DS010M 1691			
66 x 36 x 29	265	CPC6636DS010W 3225	CPC6636DS010P 3548	CPC6636DS010G 3225	CPC6636DS010M 1904			
66 x 30 x 29	225	CPC6630DS010W 3112	CPC6630DS010P 3423	CPC6630DS010G 3112	CPC6630DS010M 1652			

View statement of line

2 Select a finish  
View finish details

WAC	WGW	TBCO	WSO	GAC	GNW	MAC
WRC	WBW	TBSW		GIC	GSTV +10%	MEC
WIC	WSW	TSTV		GEC	GSLV +10%	MHC
WEC	WNW	TSMV		GHC	GWL	MOC
WHC	WWP	TSLV		GOC		MGW
WOC		TOBW		GAM		MTW
WAM		WBO		GCM		MSW
WCM		WMO		GWM		MWL
WWW		WNO		GEW		
WEW						

3 Select an edge  
View edge details



4 Select hardware  
View hardware details

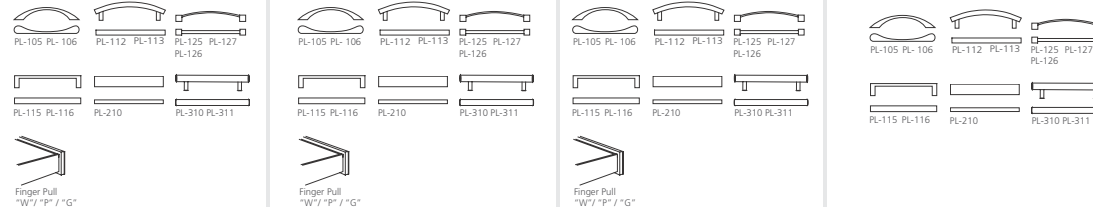

## Product features.

- Box/Box/File
- Full extension drawers - locking
- Hookup hardware
- Legal/Letter filing
- "W" & "G" SKUs feature soft close suspensions, "M" SKUs feature ball bearing suspensions. Both suspensions are full extension.

### NOTES

- 6" Recessed Modesty
- All units are standard w/ flush ends

## Options.

### ACCESSORIES

- K28: Articulating Keyboard w/ Mouse - \$390
- K31: Center drawer - \$205

### DRAWER

- P6: Modify Box/Box/File to File/File - \$55 per pedestal
- P33: Wood Drawer Upgrade - \$45 per drawer
- WPD3061: Designer White - \$80 per pedestal

### GROMMETS (STANDARD LOCATION)

- Specify Color and Left/Right - \$50 ea.
- Black: TM30-R (Right), TM30-L (Left)
- Silver: TM31-R (Right), TM31-L (Left)
- Antique Brass: TM33-R (Right), TM33-L (Left)

### GROMMETS (NON-STANDARD LOCATION)

- Provide drawing w/ Grommet Location and Specify Color - \$95 ea.
- Black: TM30-NS
- Silver: TM31-NS
- Antique Brass: TM33-NS

### MODESTY

- M39: SilverLuma frame/frost (Full Modesty) - \$650
- HM39: SilverLuma frame/frost (Half Modesty) - \$340

# Central park.

Double Breakfront / Single Pedestal Desks  
Bowfront Single Full Pedestal

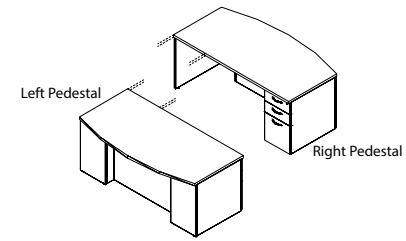

[View statement of line](#)

1 Select a model w" x d" x h"	weight	Standard Veneer Top Standard Veneer Chassis		Premium Veneer Top Premium Veneer Chassis		High Pressure Laminate Top Veneer Chassis		Thermally Fused Laminate Top Thermally Fused Laminate Chassis	
		<b>Left Pedestal</b>							
72 x 36/42 x 29	295	CPC7242DS017W	3739	CPC7242DS017P	4113	CPC7242DS017G	3739	CPC7242DS017M	1996
72 x 30/36 x 29	285	CPC7236DS017W	3686	CPC7236DS017P	4055	CPC7236DS017G	3686	CPC7236DS017M	1768
66 x 30/36 x 29	270	CPC6636DS017W	3631	CPC6636DS017P	3994	CPC6636DS017G	3631	CPC6636DS017M	1726
<b>Right Pedestal</b>									
72 x 36/42 x 29	295	CPC7242DS018W	3739	CPC7242DS018P	4113	CPC7242DS018G	3739	CPC7242DS018M	1996
72 x 30/36 x 29	285	CPC7236DS018W	3686	CPC7236DS018P	4055	CPC7236DS018G	3686	CPC7236DS018M	1768
66 x 30/36 x 29	270	CPC6636DS018W	3631	CPC6636DS018P	3994	CPC6636DS018G	3631	CPC6636DS018M	1726

2 Select a finish <a href="#">View finish details</a>	Standard Veneer Top		Premium Veneer Top		High Pressure Laminate Top		Thermally Fused Laminate Top	
WAC	WGW	TBCO	WSO	GAC	GNW	MAC		
WRC	WBW	TBSW		GIC	GSTV +10%	MEC		
WIC	WSW	TSTV		GEC	GSLV +10%	MHC		
WEC	WNW	TSMV		GHC	GWL	MOC		
WHC	WWP	TSLV		GOC		MGW		
WOC		TOBW		GAM		MTW		
WAM		WBO		GCM		MSW		
WCM		WMO		GWM		MWL		
WWW		WNO		GEW				
WEW								

3 Select a edge <a href="#">View edge details</a>	Standard Veneer Top		Premium Veneer Top		High Pressure Laminate Top		Thermally Fused Laminate Top				
+5%						+5%					
Flat	Knife	Ledge	Ogee	Flat	Knife	Ledge	Ogee	Flat	Knife	Ledge	Ogee
Reed	Radius	Waterfall		Reed	Radius	Waterfall		Reed	Radius	Waterfall	

4 Select hardware <a href="#">View hardware details</a>	Standard Veneer Top		Premium Veneer Top		High Pressure Laminate Top		Thermally Fused Laminate Top	

## Product features.

- Box/Box/File
- Full extension drawers - locking
- Hookup hardware
- Legal/Letter filing
- "W" & "G" SKUs feature soft close suspensions, "M" SKUs feature ball bearing suspensions. Both suspensions are full extension.

### NOTES

- 12" Recessed Modesty
- All units are standard w/ flush ends

## Options.

### ACCESSORIES

- K28: Articulating Keyboard w/ Mouse - \$390
- K31: Center drawer - \$205

### DRAWER

- P6: Modify Box/Box/File to File/File - \$55 per pedestal
- P33: Wood Drawer Upgrade - \$45 per drawer
- WPD3061: Designer White - \$80 per pedestal

### GROMMETS (STANDARD LOCATION)

- Specify Color and Left/Right - \$50 ea.
- Black: TM30-R (Right), TM30-L (Left)
  - Silver: TM31-R (Right), TM31-L (Left)
  - Antique Brass: TM33-R (Right), TM33-L (Left)

### GROMMETS (NON-STANDARD LOCATION)

- Provide drawing w/ Grommet Location and Specify Color - \$95 ea.
- Black: TM30-NS
  - Silver: TM31-NS
  - Antique Brass: TM33-NS

### MODESTY

- M39: SilverLuma Frame w/ Frost insert (full modesty) - \$650
- HM39: SilverLuma Frame w/ Frost insert (half modesty) - \$340

# Central park.

Double Breakfront / Single Pedestal Desks  
Conference Overhang Single Full Pedestal

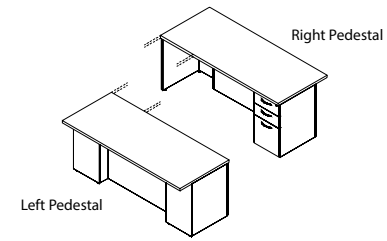

## 1 Select a model

w" x d" x h"

weight	Standard Veneer Top		Premium Veneer Top		High Pressure Laminate Top		Thermally Fused Laminate Top		
	Standard Veneer Chassis		Premium Veneer Chassis		Veneer Chassis		Thermally Fused Laminate Chassis		
<b>Left Pedestal</b>									
72 x 36 x 29	275	CPC7236DS634W	3193	CPC7236DS634P	3512	CPC7236DS634G	3193	CPC7236DS634M	1768
72 x 30 x 29	255	CPC7230DS634W	3001	CPC7230DS634P	3301	CPC7230DS634G	3001	CPC7230DS634M	1661
66 x 36 x 29	260	CPC6636DS634W	3118	CPC6636DS634P	3430	CPC6636DS634G	3118	CPC6636DS634M	1726
66 x 30 x 29	225	CPC6630DS634W	2934	CPC6630DS634P	3227	CPC6630DS634G	2934	CPC6630DS634M	1620
<b>Right Pedestal</b>									
72 x 36 x 29	275	CPC7236DS633W	3193	CPC7236DS633P	3512	CPC7236DS633G	3193	CPC7236DS633M	1768
72 x 30 x 29	255	CPC7230DS633W	3001	CPC7230DS633P	3301	CPC7230DS633G	3001	CPC7230DS633M	1661
66 x 36 x 29	260	CPC6636DS633W	3274	CPC6636DS633P	3601	CPC6636DS633G	3274	CPC6636DS633M	1726
66 x 30 x 29	225	CPC6630DS633W	2934	CPC6630DS633P	3227	CPC6630DS633G	2934	CPC6630DS633M	1620

View statement of line

## 2 Select a finish

View finish details

WAC	WGW	TBCO	WSO	GAC	GNW	MAC
WRC	WBW	TBSW		GIC	GSTV +10%	MEC
WIC	WSW	TSTV		GEC	GSLV +10%	MHC
WEC	WNW	TSMV		GHC	GWL	MOC
WHC	WWP	TSLV		GOC		MGW
WOC		TOBW		GAM		MTW
WAM		WBO		GCM		MSW
WCM		WMO		GWM		MWL
WWW		WNO		GEW		
WEW						

## 3 Select a edge

View edge details

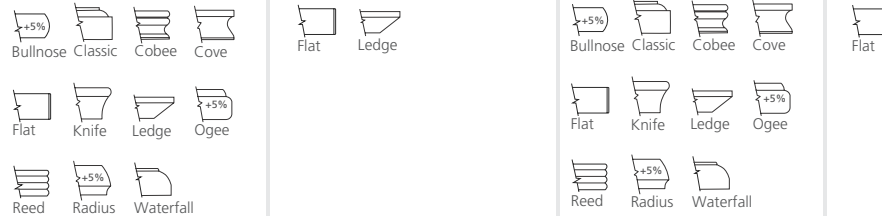

## 4 Select hardware

View hardware details

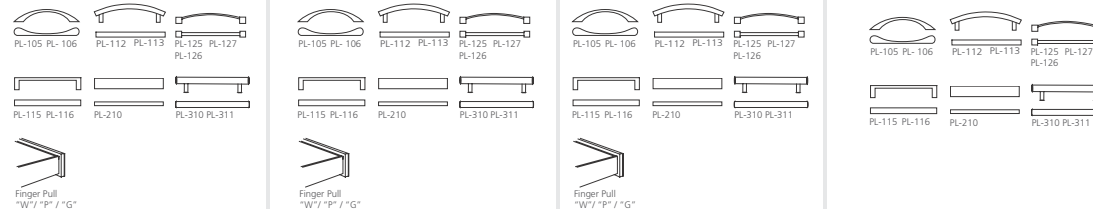

## Product features.

- Box/Box/File
- Full extension drawers - locking
- Hookup hardware
- Legal/Letter filing
- "W" & "G" SKUs feature soft close suspensions, "M" SKUs feature ball bearing suspensions. Both suspensions are full extension.

### NOTES

- 12" Recessed Modesty
- 30"D Has 24"D Chassis
- 36"D Has 30"D Chassis
- All units are standard w/ flush ends

## Options.

### ACCESSORIES

- K28: Articulating Keyboard w/ Mouse - \$390
- K31: Center drawer - \$205

### DRAWER

- P6: Modify Box/Box/File to File/File - \$55 per pedestal
- P33: Wood Drawer Upgrade - \$45 per drawer
- WPD3061: Designer White - \$80 per pedestal

### GROMMETS (STANDARD LOCATION)

- Specify Color and Left/Right - \$50 ea.
- Black: TM30-R (Right), TM30-L (Left)
  - Silver: TM31-R (Right), TM31-L (Left)
  - Antique Brass: TM33-R (Right), TM33-L (Left)

### GROMMETS (NON-STANDARD LOCATION)

- Provide drawing w/ Grommet Location and Specify Color - \$95 ea.
- Black: TM30-NS
  - Silver: TM31-NS
  - Antique Brass: TM33-NS

### MODESTY

- M39: SilverLuma Frame w/ Frost insert (full modesty) - \$650
- HM39: SilverLuma Frame w/ Frost insert (half modesty) - \$340

# Central park.

Double Breakfront / Single Pedestal Desks  
Bowfront Conference Overhang Single Full Pedestal

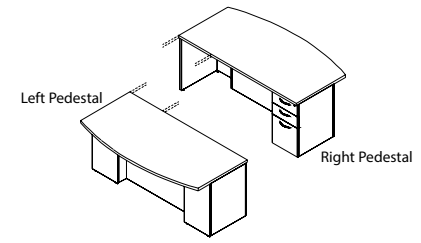

## 1 Select a model

w" x d" x h"

weight	Standard Veneer Top		Premium Veneer Top		High Pressure Laminate Top		Thermally Fused Laminate Top		
	Standard Veneer Chassis		Premium Veneer Chassis		Veneer Chassis		Thermally Fused Laminate Chassis		
<b>Left Pedestal</b>									
72 x 36/42 x 29	285	CPC7242DS636W	3486	CPC7242DS636P	3835	CPC7242DS636G	3486	CPC7242DS636M	1843
72 x 30/36 x 29	265	CPC7236DS636W	3412	CPC7236DS636P	3753	CPC7236DS636G	3412	CPC7236DS636M	1738
66 x 30/36 x 29	245	CPC6636DS636W	3363	CPC6636DS636P	3699	CPC6636DS636G	3363	CPC6636DS636M	1697
<b>Right Pedestal</b>									
72 x 36/42 x 29	285	CPC7242DS635W	3486	CPC7242DS635P	3835	CPC7242DS635G	3486	CPC7242DS635M	1843
72 x 30/36 x 29	265	CPC7236DS635W	3412	CPC7236DS635P	3753	CPC7236DS635G	3412	CPC7236DS635M	1738
66 x 30/36 x 29	245	CPC6636DS635W	3363	CPC6636DS635P	3699	CPC6636DS635G	3363	CPC6636DS635M	1697

[View statement of line](#)

## 2 Select a finish

[View finish details](#)

WAC	WGW	TBCO	WSO	GAC	GNW	MAC
WRC	WBW	TBSW		GIC	GSTV +10%	MEC
WIC	WSW	TSTV		GEC	GSLV +10%	MHC
WEC	WNW	TSMV		GHC	GWL	MOC
WHC	WWP	TSLV		GOC		MGW
WOC		TOBW		GAM		MTW
WAM		WBO		GCM		MSW
WCM		WMO		GWM		MWL
WWW		WNO		GEW		
WEW						

## 3 Select a edge

[View edge details](#)



## 4 Select hardware

[View hardware details](#)

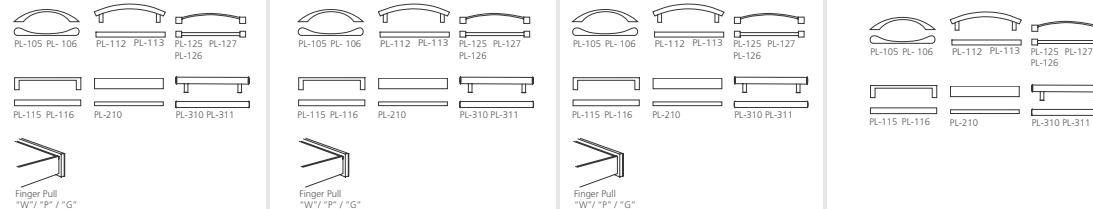

## Product features.

- Box/Box/File
- Full extension drawers - locking
- Hookup hardware
- Legal/Letter filing
- "W" & "G" SKUs feature soft close suspensions, "M" SKUs feature ball bearing suspensions. Both suspensions are full extension.

### NOTES

- 18" Recessed Modesty
- 36/42 has 30" D chassis
- 30/36 has 24" D chassis
- All units are standard w/ flush ends

## Options.

### ACCESSORIES

- K28: Articulating Keyboard w/ Mouse - \$390
- K31: Center drawer - \$205

### DRAWER

- P6: Modify Box/Box/File to File/File - \$55 per pedestal
- P33: Wood Drawer Upgrade - \$45 per drawer
- WPD3061: Designer White - \$80 per pedestal

### GROMMETS (STANDARD LOCATION)

- Specify Color and Left/Right - \$50 ea.
- Black: TM30-R (Right), TM30-L (Left)
  - Silver: TM31-R (Right), TM31-L (Left)
  - Antique Brass: TM33-R (Right), TM33-L (Left)

### GROMMETS (NON-STANDARD LOCATION)

- Provide drawing w/ Grommet Location and Specify Color - \$95 ea.
- Black: TM30-NS
  - Silver: TM31-NS
  - Antique Brass: TM33-NS

### MODESTY

- M39: SilverLuma Frame w/ Frost insert (full modesty) - \$650
- HM39: SilverLuma Frame w/ Frost insert (half modesty) - \$340



# Central park.

Double Breakfront / Single Pedestal Desks  
Height Adjustable Single Full Pedestal

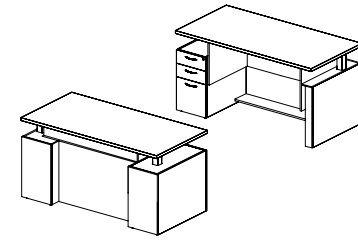

[View statement of line](#)

1 Select a model w" x d" x h"	weight	Standard Veneer Top Standard Veneer Chassis		Premium Veneer Top Premium Veneer Chassis		High Pressure Laminate Top Veneer Chassis		Thermally Fused Laminate Top Thermally Fused Laminate Chassis	
		<b>Left Pedestal</b>							
72 x 36 x 29-47.5	275	CPC7236DS742W	6793	CPC7236DS742P	7472	CPC7236DS742G	6793	CPC7236DS742M	5300
72 x 30 x 29-47.5	265	CPC7230DS742W	6535	CPC7230DS742P	7189	CPC7230DS742G	6535	CPC7230DS742M	4931
66 x 36 x 29-47.5	265	CPC6636DS742W	6646	CPC6636DS742P	7311	CPC6636DS742G	6646	CPC6636DS742M	5202
66 x 30 x 29-47.5	225	CPC6630DS742W	6393	CPC6630DS742P	7032	CPC6630DS742G	6393	CPC6630DS742M	4814
<b>Right Pedestal</b>									
72 x 36 x 29-47.5	275	CPC7236DS743W	6793	CPC7236DS743P	7472	CPC7236DS743G	6793	CPC7236DS743M	5300
72 x 30 x 29-47.5	265	CPC7230DS743W	6535	CPC7230DS743P	7189	CPC7230DS743G	6535	CPC7230DS743M	4931
66 x 36 x 29-47.5	265	CPC6636DS743W	6646	CPC6636DS743P	7311	CPC6636DS743G	6646	CPC6636DS743M	5202
66 x 30 x 29-47.5	225	CPC6630DS743W	6393	CPC6630DS743P	7032	CPC6630DS743G	6393	CPC6630DS743M	4814

2 Select a finish <a href="#">View finish details</a>	Standard Veneer Top		Premium Veneer Top		High Pressure Laminate Top		Thermally Fused Laminate Top	
WAC	WGW	TBCO	WSO	GAC	GNW	MAC		
WRC	WBW	TBSW		GIC	GSTV +10%	MEC		
WIC	WSW	TSTV		GEC	GSLV +10%	MHC		
WEC	WNW	TSMV		GHC	GWL	MOC		
WHC	WWP	TSLV		GOC		MGW		
WOC		TOBW		GAM		MTW		
WAM		WBO		GCM		MSW		
WCM		WMO		GWM		MWL		
WWM		WNO		GEW				
WEW								

3 Select a edge <a href="#">View edge details</a>	Standard Veneer Top		Premium Veneer Top		High Pressure Laminate Top		Thermally Fused Laminate Top			
+5%						+5%				
Bullnose	Classic	Cobee	Cove	Flat	Ledge	Bullnose	Classic	Cobee	Cove	Flat
			+5%				+5%			
Flat	Knife	Ledge	Ogee	Flat	Knife	Ledge	Ogee	Flat	Knife	Ledge
	+5%				+5%				+5%	
Reed	Radius	Waterfall		Reed	Radius	Waterfall		Reed	Radius	Waterfall

4 Select hardware <a href="#">View hardware details</a>	Standard Veneer Top		Premium Veneer Top		High Pressure Laminate Top		Thermally Fused Laminate Top	
PL-105 PL-106	PL-112 PL-113	PL-125 PL-127 PL-126	PL-105 PL-106	PL-112 PL-113	PL-125 PL-127 PL-126	PL-105 PL-106	PL-112 PL-113	PL-125 PL-127 PL-126
PL-115 PL-116	PL-210	PL-310 PL-311	PL-115 PL-116	PL-210	PL-310 PL-311	PL-115 PL-116	PL-210	PL-310 PL-311
Finger Pull "W"/"P"/"G"	Finger Pull "W"/"P"/"G"	Finger Pull "W"/"P"/"G"	Finger Pull "W"/"P"/"G"	Finger Pull "W"/"P"/"G"	Finger Pull "W"/"P"/"G"	Finger Pull "W"/"P"/"G"	Finger Pull "W"/"P"/"G"	Finger Pull "W"/"P"/"G"

## Product features.

- Adjustable height from 29" to 47.5" with a maximum weight capacity of 350 lbs.
- Box/Box/File
- Full extension drawers - locking
- Legal/Letter filing
- Lift available in MFS Silver (standard) or MFB Black (optional)
- Metal parts include 5 year warranty
- Privacy Surround Panels
- Programmable height adjustable mechanism, motor includes 2 year warranty
- "W" & "G" SKUs feature soft close suspensions, "M" SKUs feature ball bearing suspensions. Both suspensions are full extension.

### NOTES

- 6" Recessed Modesty
- All units are standard w/ flush ends
- Hookup hardware

## Options.

### ACCESSORIES

- K28: Articulating Keyboard w/ Mouse - \$390
- K31: Center drawer - \$205

### DRAWER

- P6: Modify Box/Box/File to File/File - \$55 per pedestal
- P33: Wood Drawer Upgrade - \$45 per drawer
- WPD3061: Designer White - \$80 per pedestal fronts

### GROMMETS (STANDARD LOCATION)

- Specify Color and Left/Right - \$50 ea.
- Black: TM30-R (Right), TM30-L (Left)
  - Silver: TM31-R (Right), TM31-L (Left)
  - Antique Brass: TM33-R (Right), TM33-L (Left)

### GROMMETS (NON-STANDARD LOCATION)

- Provide drawing w/ Grommet Location and Specify Color - \$95 ea.
- Black: TM30-NS
  - Silver: TM31-NS
  - Antique Brass: TM33-NS

### MODESTY

- M39: SilverLuma Frame w/ Frost insert (full modesty) - \$650 Wire Management
- LWMB: Lift wire management box with flip down door - \$365
- Power strip with five outlets and 12' cord, mesh wire cover, 6" deep black box

# Central park.

Flush Chassis Single Pedestal Desks W/ Overhang Top  
Single Full Pedestal

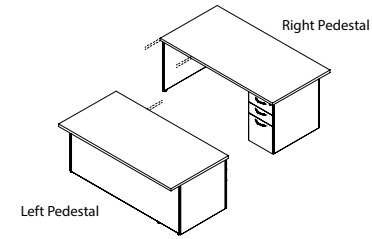

1 Select a model  
w" x d" x h"

weight	Standard Veneer Top Standard Veneer Chassis		Premium Veneer Top Premium Veneer Chassis		High Pressure Laminate Top Veneer Chassis		Thermally Fused Laminate Top Thermally Fused Laminate Chassis	
	<b>Left Pedestal</b>							
72 x 36 x 29	275	CPC7236DS640W 3035	CPC7236DS640P 3339	CPC7236DS640G 3035	CPC7236DS640M 1768			
72 x 30 x 29	255	CPC7230DS640W 3001	CPC7230DS640P 3301	CPC7230DS640G 3001	CPC7230DS640M 1661			
66 x 36 x 29	255	CPC6636DS640W 2987	CPC6636DS640P 3286	CPC6636DS640G 2987	CPC6636DS640M 1726			
66 x 30 x 29	220	CPC6630DS640W 2934	CPC6630DS640P 3227	CPC6630DS640G 2934	CPC6630DS640M 1620			
<b>Right Pedestal</b>								
72 x 36 x 29	275	CPC7236DS639W 3035	CPC7236DS639P 3339	CPC7236DS639G 3035	CPC7236DS639M 1768			
72 x 30 x 29	255	CPC7230DS639W 3001	CPC7230DS639P 3301	CPC7230DS639G 3001	CPC7230DS639M 1661			
66 x 36 x 29	255	CPC6636DS639W 2987	CPC6636DS639P 3451	CPC6636DS639G 2987	CPC6636DS639M 1726			
66 x 30 x 29	220	CPC6630DS639W 2934	CPC6630DS639P 3227	CPC6630DS639G 2934	CPC6630DS639M 1620			

View statement of line

2 Select a finish  
View finish details

WAC	WGW	TBCO	WSO	GAC	GNW	MAC
WRC	WBW	TBSW		GIC	GSTV +10%	MEC
WIC	WSW	TSTV		GEC	GSLV +10%	MHC
WEC	WNW	TSMV		GHC	GWL	MOC
WHC	WWP	TSLV		GOC		MGW
WOC		TOBW		GAM		MTW
WAM		WBO		GCM		MSW
WCM		WMO		GWM		MWL
WWW		WNO		GEW		
WEW						

3 Select a edge  
View edge details



4 Select hardware  
View hardware details

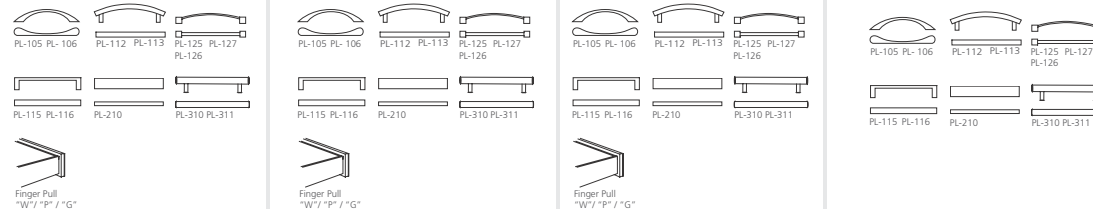

## Product features.

- 6" Overhang
- All units are standard w/ flush ends
- Box/Box/File
- Full extension drawers - locking
- Hookup hardware
- "W" & "G" SKUs feature soft close suspensions, "M" SKUs feature ball bearing suspensions. Both suspensions are full extension.

### NOTES

- 30"D Has 24"D Chassis
- 36"D Has 30"D Chassis

## Options.

### ACCESSORIES

- K28: Articulating Keyboard w/ Mouse - \$390
- K31: Center drawer - \$205

### DRAWER

- P6: Modify Box/Box/File to File/File - \$55 per pedestal
- P33: Wood Drawer Upgrade - \$45 per drawer
- WPD3061: Designer White - \$80 per pedestal

### GROMMETS (STANDARD LOCATION)

- Specify Color and Left/Right - \$50 ea.
- Black: TM30-R (Right), TM30-L (Left)
- Silver: TM31-R (Right), TM31-L (Left)
- Antique Brass: TM33-R (Right), TM33-L (Left)

### GROMMETS (NON-STANDARD LOCATION)

- Provide drawing w/ Grommet Location and Specify Color - \$95 ea.
- Black: TM30-NS
- Silver: TM31-NS
- Antique Brass: TM33-NS

### FLUSH TOP

- T6: Modify rectangle overhang top to flush top - N/C
- Unit will be 6" smaller when T6 flush top option is specified

# Central park.

Flush Chassis Single Pedestal Desks W/ Overhang Top  
Height Adjustable Single Full Pedestal

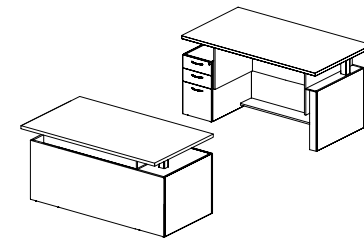

## 1 Select a model

w" x d" x h"

weight	Standard Veneer Top		Premium Veneer Top		High Pressure Laminate Top		Thermally Fused Laminate Top		
	Standard Veneer Chassis		Premium Veneer Chassis		Veneer Chassis		Thermally Fused Laminate Chassis		
<b>Left Pedestal</b>									
72 x 36 x 29	275	CPC7236DS642W	6816	CPC7236DS642P	7498	CPC7236DS642G	6816	CPC7236DS642M	5264
72 x 30 x 29	255	CPC7230DS642W	6547	CPC7230DS642P	7202	CPC7230DS642G	6547	CPC7230DS642M	4888
66 x 36 x 29	255	CPC6636DS642W	6664	CPC6636DS642P	7330	CPC6636DS642G	6664	CPC6636DS642M	5169
66 x 30 x 29	220	CPC6630DS642W	6400	CPC6630DS642P	7040	CPC6630DS642G	6400	CPC6630DS642M	4764
<b>Right Pedestal</b>									
72 x 36 x 29	275	CPC7236DS641W	6816	CPC7236DS641P	7498	CPC7236DS641G	6816	CPC7236DS641M	5264
72 x 30 x 29	255	CPC7230DS641W	6547	CPC7230DS641P	7202	CPC7230DS641G	6547	CPC7230DS641M	4888
66 x 36 x 29	255	CPC6636DS641W	6664	CPC6636DS641P	7330	CPC6636DS641G	6664	CPC6636DS641M	5169
66 x 30 x 29	220	CPC6630DS641W	6400	CPC6630DS641P	7040	CPC6630DS641G	6400	CPC6630DS641M	4764

View statement of line

## 2 Select a finish

View finish details

WAC	WGW	TBCO	WSO	GAC	GNW	MAC
WRC	WBW	TBSW		GIC	GSTV +10%	MEC
WIC	WSW	TSTV		GEC	GSLV +10%	MHC
WEC	WNW	TSMV		GHC	GWL	MOC
WHC	WWP	TSLV		GOC		MGW
WOC		TOBW		GAM		MTW
WAM		WBO		GCM		MSW
WCM		WMO		GWM		MWL
WWM		WNO		GEW		
WEW						

## 3 Select a edge

View edge details



## 4 Select hardware

View hardware details

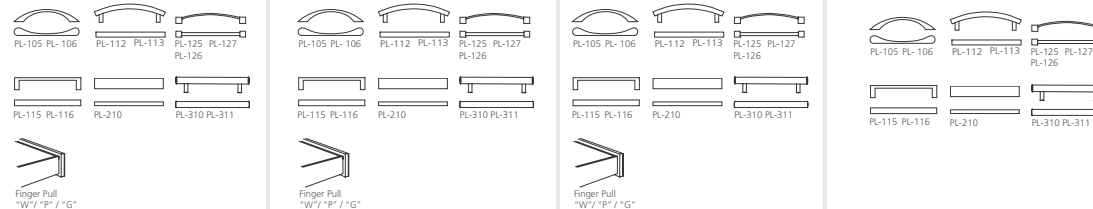

## Product features.

- Box/Box/File
- Full extension drawers - locking
- Hookup hardware
- Lift available in MFS Silver (standard) or MFB Black (optional)
- Metal parts include 5 year warranty
- Privacy surround panels
- Programmable height adjustable mechanism, motor includes 2 year warranty
- "W" & "G" SKUs feature soft close suspensions, "M" SKUs feature ball bearing suspensions. Both suspensions are full extension.

### NOTES

- 30"D Has 24"D Chassis
- 36"D Has 30"D Chassis
- 6" Overhang
- All units are standard w/ flush ends

## Options.

### ACCESSORIES

- K28: Articulating Keyboard w/ Mouse - \$390
- K31: Center drawer - \$205

### DRAWER

- P6: Modify Box/Box/File to File/File - \$55 per pedestal
- P33: Wood Drawer Upgrade - \$45 per drawer
- WPD3061: Designer White - \$80 per pedestal fronts

### GROMMETS (STANDARD LOCATION)

- Specify Color and Left/Right - \$50 ea.
- Black: TM30-R (Right), TM30-L (Left)
- Silver: TM31-R (Right), TM31-L (Left)
- Antique Brass: TM33-R (Right), TM33-L (Left)

### GROMMETS (NON-STANDARD LOCATION)

- Provide drawing w/ Grommet Location and Specify Color - \$95 ea.
- Black: TM30-NS
- Silver: TM31-NS
- Antique Brass: TM33-NS

### WIRE MANAGEMENT

- LWMB: Lift wire management box with flip down door - \$365
- Power strip with five outlets and 12' cord, mesh wire cover, 6" deep black box

# Central park.

Flush Modesty Single Pedestal Desks  
Bowfront Single Full Pedestal

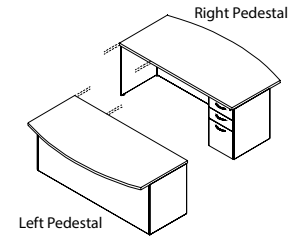

## 1 Select a model

w" x d" x h"

weight	Standard Veneer Top		Premium Veneer Top		High Pressure Laminate Top		Thermally Fused Laminate Top		
	Standard Veneer Chassis		Premium Veneer Chassis		Veneer Chassis		Thermally Fused Laminate Chassis		
<b>Left Pedestal</b>									
72 x 36/42 x 29	295	CPC7242DS749W	3739	CPC7242DS749P	4113	CPC7242DS749G	3739	CPC7242DS749M	1996
72 x 30/36 x 29	295	CPC7236DS749W	3686	CPC7236DS749P	4055	CPC7236DS749G	3686	CPC7236DS749M	1768
66 x 30/36 x 29	270	CPC6636DS749W	3631	CPC6636DS749P	3994	CPC6636DS749G	3631	CPC6636DS749M	1726
<b>Right Pedestal</b>									
72 x 36/42 x 29	295	CPC7242DS748W	3739	CPC7242DS748P	4113	CPC7242DS748G	3739	CPC7242DS748M	1996
72 x 30/36 x 29	285	CPC7236DS748W	3686	CPC7236DS748P	4055	CPC7236DS748G	3686	CPC7236DS748M	1768
66 x 30/36 x 29	270	CPC6636DS748W	3631	CPC6636DS748P	3994	CPC6636DS748G	3631	CPC6636DS748M	1726

[View statement of line](#)

## 2 Select a finish

[View finish details](#)

WAC	WGW	TBCO	WSO	GAC	GNW	MAC
WRC	WBW	TBSW		GIC	GSTV +10%	MEC
WIC	WSW	TSTV		GEC	GSLV +10%	MHC
WEC	WNW	TSMV		GHC	GWL	MOC
WHC	WWP	TSLV		GOC		MGW
WOC		TOBW		GAM		MTW
WAM		WBO		GCM		MSW
WCM		WMO		GWM		MWL
WWM		WNO		GEW		
WEW						

## 3 Select a edge

[View edge details](#)



## 4 Select hardware

[View hardware details](#)

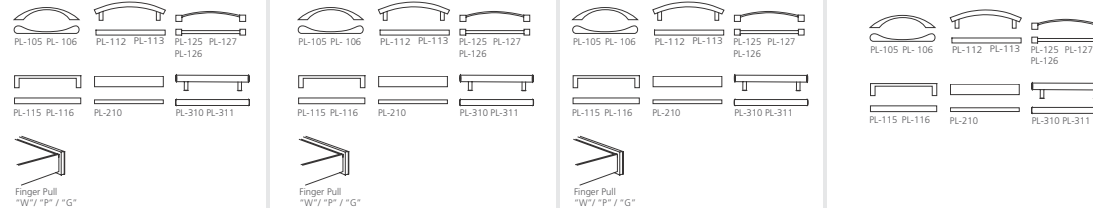

## Product features.

- Box/Box/File
- Full extension drawers - locking
- Hookup hardware
- "W" & "G" SKUs feature soft close suspensions, "M" SKUs feature ball bearing suspensions. Both suspensions are full extension.

### NOTES

- Modesty is recessed 12"
- All units are standard w/ flush ends
- 36/42 has 30" D chassis
- 30/36 has 24" D chassis

## Options.

### ACCESSORIES

- K28: Articulating Keyboard w/ Mouse - \$390
- K31: Center drawer - \$205

### DRAWER

- P6: Modify Box/Box/File to File/File - \$55 per pedestal
- P33: Wood Drawer Upgrade - \$45 per drawer
- WPD3061: Designer White - \$80 per pedestal

### GROMMETS (STANDARD LOCATION)

- Specify Color and Left/Right - \$50 ea.
- Black: TM30-R (Right), TM30-L (Left)
  - Silver: TM31-R (Right), TM31-L (Left)
  - Antique Brass: TM33-R (Right), TM33-L (Left)

### GROMMETS (NON-STANDARD LOCATION)

- Provide drawing w/ Grommet Location and Specify Color - \$95 ea.
- Black: TM30-NS
  - Silver: TM31-NS
  - Antique Brass: TM33-NS

# Central park.

Non-Handed Desk Units

Flush Modesty Shell W/ Overhang Top

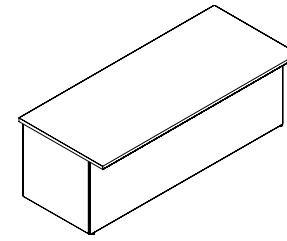

[View statement of line](#)

1 Select a model w" x d" x h"	weight	Standard Veneer Top		Premium Veneer Top		High Pressure Laminate Top		Thermally Fused Laminate Top	
		Standard Veneer Chassis		Premium Veneer Chassis		Veneer Chassis		Thermally Fused Laminate Chassis	
72 x 36 x 29	210	CPC7236DS896W	2860	CPC7236DS896P	3146	CPC7236DS896G	2860	CPC7236DS896M	1199
72 x 30 x 29	200	CPC7230DS896W	2621	CPC7230DS896P	2883	CPC7230DS896G	2621	CPC7230DS896M	1006
66 x 30 x 29	190	CPC6630DS896W	2574	CPC6630DS896P	2831	CPC6630DS896G	2574	CPC6630DS896M	976

2 Select a finish <a href="#">View finish details</a>	Standard Veneer Top		Premium Veneer Top		High Pressure Laminate Top		Thermally Fused Laminate Top	
	WAC	WGW	TBCO	WSO	GAC	GNW	MAC	
WRC	WBW	TBSW		GIC	GSTV +10%	MEC		
WIC	WSW	TSTV		GEC	GSLV +10%	MHC		
WEC	WNW	TSMV		GHC	GWL	MOC		
WHC	WWP	TSLV		GOC		MGW		
WOC		TOBW		GAM		MTW		
WAM		WBO		GCM		MSW		
WCM		WMO		GWM		MWL		
WWW		WNO		GEW				
WEW								

3 Select a edge <a href="#">View edge details</a>	Standard Veneer Top		Premium Veneer Top		High Pressure Laminate Top		Thermally Fused Laminate Top			
Flat	Knife	Ledge	Ogee			Flat	Knife	Ledge	Ogee	
Reed	Radius	Waterfall				Reed	Radius	Waterfall		

4 Select hardware <a href="#">View hardware details</a>	Standard Veneer Top		Premium Veneer Top		High Pressure Laminate Top		Thermally Fused Laminate Top	
	Hardware	N/A	Hardware	N/A	Hardware	N/A	Hardware	N/A

## Product features.

- 6" Overhang
- Fully Assembled
- Metal to metal fasteners

### NOTES

- All Top Edge Hookups Are Shape To Shape Only
- BUDGET TIP: Modular shell and non-attached pedestals reduce installation cost 50%-60% vs. pan/pedestal components requiring extensive assembly. Reconfiguration cost difference is 70%-80% vs. assembled units.
- Order freestanding pedestals under shell

## Options.

### ACCESSORIES

- K28: Articulating Keyboard w/ Mouse - \$390
- K31: Center drawer - \$205

### GROMMETS (STANDARD LOCATION)

- Specify Color and Left/Right - \$50 ea.
- Black: TM30-R (Right), TM30-L (Left)
  - Silver: TM31-R (Right), TM31-L (Left)
  - Antique Brass: TM33-R (Right), TM33-L (Left)

### GROMMETS (NON-STANDARD LOCATION)

- Provide drawing w/ Grommet Location and Specify Color - \$95 ea.
- Black: TM30-NS
  - Silver: TM31-NS
  - Antique Brass: TM33-NS

### FLUSH TOP

- T6: Modify rectangle overhang top to flush top - N/C
- Unit will be 6" smaller when T6 flush top option is specified

# Central park.

Desk Shell  
Height Adjustable Overhang

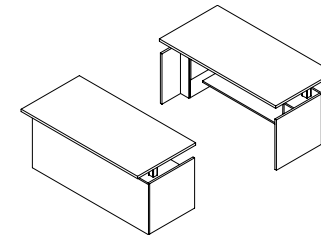

## 1 Select a model

w" x d" x h"

weight	Standard Veneer Top		Premium Veneer Top		High Pressure Laminate Top		Thermally Fused Laminate Top		
	Standard Veneer Chassis		Premium Veneer Chassis		Veneer Chassis		Thermally Fused Laminate Chassis		
72 x 36 x 29-47.5	225	CPC7236DS897W	5945	CPC7236DS897P	6540	CPC7236DS897G	5945	CPC7236DS897M	4746
72 x 30 x 29-47.5	205	CPC7230DS897W	5829	CPC7230DS897P	6412	CPC7230DS897G	5829	CPC7230DS897M	4492
66 x 36 x 29-47.5	205	CPC6636DS897W	5895	CPC6636DS897P	6485	CPC6636DS897G	5895	CPC6636DS897M	4700
66 x 30 x 29-47.5	185	CPC6630DS897W	5802	CPC6630DS897P	6382	CPC6630DS897G	5802	CPC6630DS897M	4497

[View statement of line](#)

## 2 Select a finish

[View finish details](#)

WAC	WGW	TBCO	WSO	GAC	GNW	MAC
WRC	WBW	TBSW		GIC	GSTV +10%	MEC
WIC	WSW	TSTV		GEC	GSLV +10%	MHC
WEC	WNW	TSMV		GHC	GWL	MOC
WHC	WWP	TSLV		GOC		MGW
WOC		TOBW		GAM		MTW
WAM		WBO		GCM		MSW
WCM		WMO		GWM		MWL
WWM		WNO		GEW		
WEW						

## 3 Select a edge

[View edge details](#)

Bullnose	Classic	Cobee	Cove	Flat	Ledge	Bullnose	Classic	Cobee	Cove	Flat
Flat	Knife	Ledge	Ogee	Flat	Knife	Ledge	Ogee	Flat	Knife	Ledge
Reed	Radius	Waterfall		Reed	Radius	Waterfall		Reed	Radius	Waterfall

## 4 Select hardware

[View hardware details](#)

Hardware	Hardware	Hardware	Hardware
N/A	N/A	N/A	N/A

## Product features.

- Adjustable height from 29" to 47.5" with a maximum weight capacity of 350 lbs.
- Fully assembled
- Height adjustable shells are finished all sides - open plan
- Lift available in MFS Silver (standard) or MFB Black (optional)
- Metal parts include 5 year warranty
- Programmable height adjustable mechanism, motor includes 2 year warranty
- Order freestanding pedestals under shell

### NOTES

- Lift mechanism is silver std
- Modesty surround lifts w/ work surface

## Options.

### ACCESSORIES

- K28: Articulating Keyboard w/ Mouse - \$390
- K31: Center drawer - \$205

### GROMMETS (STANDARD LOCATION)

- Specify Color and Left/Right - \$50 ea.
- Black: TM30-R (Right), TM30-L (Left)
- Silver: TM31-R (Right), TM31-L (Left)
- Antique Brass: TM33-R (Right), TM33-L (Left)

### GROMMETS (NON-STANDARD LOCATION)

- Provide drawing w/ Grommet Location and Specify Color - \$95 ea.
- Black: TM30-NS
- Silver: TM31-NS
- Antique Brass: TM33-NS

### WIRE MANAGEMENT

- LWMB: Lift wire management box with flip down door - \$365
- Power strip with five outlets and 12' cord, mesh wire cover, 6" deep black box

# Central park.

Height Adjustable Box/Box/File Pedestal With Bridge  
 "L" Double Breakfont / Single Pedestal Desks With 42" Bridge

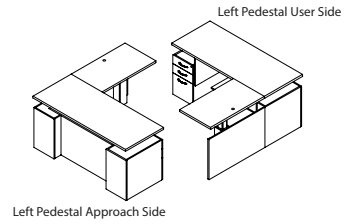

## 1 Select a model

w" x d" x h"

weight	Standard Veneer Top		Premium Veneer Top		High Pressure Laminate Top		Thermally Fused Laminate Top		
	Standard Veneer Chassis		Premium Veneer Chassis		Veneer Chassis		Thermally Fused Laminate Chassis		
<b>Left Pedestal</b>									
84 x 36/78 x 29-47.5	415	CPC8436DS739W	8638	CPC8436DS739P	9502	CPC8436DS739G	8638	CPC8436DS739M	6872
72 x 30/72 x 29-47.5	355	CPC7230DS739W	8209	CPC7230DS739P	9030	CPC7230DS739G	8209	CPC7230DS739M	6507
66 x 30/72 x 29-47.5	335	CPC6630DS739W	8141	CPC6630DS739P	8955	CPC6630DS739G	8141	CPC6630DS739M	6079
<b>Right Pedestal</b>									
84 x 36/78 x 29-47.5	415	CPC8436DS738W	8638	CPC8436DS738P	9502	CPC8436DS738G	8638	CPC8436DS738M	6872
72 x 30/72 x 29-47.5	355	CPC7230DS738W	8209	CPC7230DS738P	9030	CPC7230DS738G	8209	CPC7230DS738M	6507
66 x 30/72 x 29-47.5	335	CPC6630DS738W	8141	CPC6630DS738P	8955	CPC6630DS738G	8141	CPC6630DS738M	6079

View statement of line

## 2 Select a finish

View finish details

WAC	WGW	TBCO	WSO	GAC	GNW	MAC
WRC	WBW	TBSW		GIC	GSTV +10%	MEC
WIC	WSW	TSTV		GEC	GSLV +10%	MHC
WEC	WNW	TSMV		GHC	GWL	MOC
WHC	WWP	TSLV		GOC		MGW
WOC		TOBW		GAM		MTW
WAM		WBO		GCM		MSW
WCM		WMO		GWM		MWL
WWM		WNO		GEW		
WEW						

## 3 Select a edge

View edge details

+5%						+5%				
Bullnose	Classic	Cobee	Cove	Flat	Ledge	Bullnose	Classic	Cobee	Cove	Flat
			+5%				+5%			
Flat	Knife	Ledge	Ogee	Flat	Knife	Ledge	Ogee	Flat	Knife	Ledge
	+5%				+5%				+5%	
Reed	Radius	Waterfall		Reed	Radius	Waterfall		Reed	Radius	Waterfall

## 4 Select hardware

View hardware details

PL-105 PL-106	PL-112 PL-113	PL-125 PL-127 PL-126	PL-105 PL-106	PL-112 PL-113	PL-125 PL-127 PL-126	PL-105 PL-106	PL-112 PL-113	PL-125 PL-127 PL-126	PL-105 PL-106	PL-112 PL-113	PL-125 PL-127 PL-126
PL-115 PL-116	PL-210	PL-310 PL-311	PL-115 PL-116	PL-210	PL-310 PL-311	PL-115 PL-116	PL-210	PL-310 PL-311	PL-115 PL-116	PL-210	PL-310 PL-311
Finger Pull "W"/"P"/"G"	Finger Pull "W"/"P"/"G"	Finger Pull "W"/"P"/"G"	Finger Pull "W"/"P"/"G"	Finger Pull "W"/"P"/"G"	Finger Pull "W"/"P"/"G"	Finger Pull "W"/"P"/"G"	Finger Pull "W"/"P"/"G"	Finger Pull "W"/"P"/"G"	Finger Pull "W"/"P"/"G"	Finger Pull "W"/"P"/"G"	Finger Pull "W"/"P"/"G"

Left Pedestal Approach Side

## Product features.

- 1 Standard grommet - matches pull finish or specify black TM30, silver TM31 or antique brass TM33
- Adjustable height from 29" to 47.5" with a maximum weight capacity of 375 lbs.
- Box/Box/File
- Lift available in MFS Silver (standard) or MFB Black (optional)
- Metal parts include 5 year warranty
- Programmable height adjustable mechanism, motor includes 2 year warranty

### NOTES

- Modesty surround lifts w/ work surface

## Options.

### ACCESSORIES

- K31: Center drawer - \$205

### BRIDGE

- MOD48: Modify 42" bridge to 48" - \$75

### DRAWER

- P6: Modify Box/Box/File to File/File - \$55 per pedestal
- P33: Wood Drawer Upgrade - \$45 per drawer
- WPD3061: Designer White - \$80 per pedestal fronts

### GROMMETS (NON-STANDARD LOCATION)

- Provide drawing w/ Grommet Location and Specify Color - \$95 ea.
- Black: TM30-NS
- Silver: TM31-NS
- Antique Brass: TM33-NS

### WIRE MANAGEMENT

- LWMB: Lift wire management box with flip down door - \$365
- Power strip with five outlets and 12' cord, mesh wire cover, 6" deep black box

# Central park.

Height Adjustable Box/Box/File Pedestal With Bridge  
 "L" Flush Front / Single Pedestal Desks With 42" Bridge

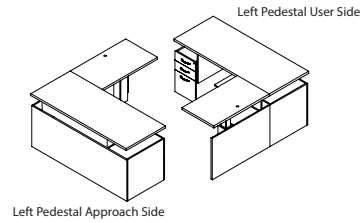

## 1 Select a model

w" x d" x h"

weight	Standard Veneer Top		Premium Veneer Top		High Pressure Laminate Top		Thermally Fused Laminate Top		
	Standard Veneer Chassis		Premium Veneer Chassis		Veneer Chassis		Thermally Fused Laminate Chassis		
<b>Left Pedestal</b>									
84 x 36/78 x 29-47.5	415	CPC8436DS644W	8745	CPC8436DS644P	9620	CPC8436DS644G	8745	CPC8436DS644M	6895
72 x 30/72 x 29-47.5	355	CPC7230DS644W	8284	CPC7230DS644P	9112	CPC7230DS644G	8284	CPC7230DS644M	6518
66 x 30/72 x 29-47.5	335	CPC6630DS644W	8211	CPC6630DS644P	9032	CPC6630DS644G	8211	CPC6630DS644M	6074
<b>Right Pedestal</b>									
84 x 36/78 x 29-47.5	415	CPC8436DS643W	8745	CPC8436DS643P	9620	CPC8436DS643G	8745	CPC8436DS643M	6895
72 x 30/72 x 29-47.5	355	CPC7230DS643W	8284	CPC7230DS643P	9112	CPC7230DS643G	8284	CPC7230DS643M	6518
66 x 30/72 x 29-47.5	335	CPC6630DS643W	8211	CPC6630DS643P	9032	CPC6630DS643G	8211	CPC6630DS643M	6074

View statement of line

## 2 Select a finish

View finish details

WAC	WGW	TBCO	WSO	GAC	GNW	MAC
WRC	WBW	TBSW		GIC	GSTV +10%	MEC
WIC	WSW	TSTV		GEC	GSLV +10%	MHC
WEC	WNW	TSMV		GHC	GWL	MOC
WHC	WWP	TSLV		GOC		MGW
WOC		TOBW		GAM		MTW
WAM		WBO		GCM		MSW
WCM		WMO		GWM		MWL
WWM		WNO		GEW		
WEW						

## 3 Select a edge

View edge details

+5%						+5%					
Bullnose	Classic	Cobee	Cove	Flat	Ledge	Bullnose	Classic	Cobee	Cove	Flat	
			+5%				+5%				
Flat	Knife	Ledge	Ogee	Flat	Knife	Ledge	Ogee	Flat	Knife	Ledge	Ogee
	+5%				+5%				+5%		
Reed	Radius	Waterfall		Reed	Radius	Waterfall		Reed	Radius	Waterfall	

## 4 Select hardware

View hardware details

PL-105 PL-106	PL-112 PL-113	PL-125 PL-127 PL-126	PL-105 PL-106	PL-112 PL-113	PL-125 PL-127 PL-126	PL-105 PL-106	PL-112 PL-113	PL-125 PL-127 PL-126	PL-105 PL-106	PL-112 PL-113	PL-125 PL-127 PL-126
PL-115 PL-116	PL-210	PL-310 PL-311	PL-115 PL-116	PL-210	PL-310 PL-311	PL-115 PL-116	PL-210	PL-310 PL-311	PL-115 PL-116	PL-210	PL-310 PL-311
Finger Pull "W"/"P"/"G"	Finger Pull "W"/"P"/"G"	Finger Pull "W"/"P"/"G"	Finger Pull "W"/"P"/"G"	Finger Pull "W"/"P"/"G"	Finger Pull "W"/"P"/"G"	Finger Pull "W"/"P"/"G"	Finger Pull "W"/"P"/"G"	Finger Pull "W"/"P"/"G"	Finger Pull "W"/"P"/"G"	Finger Pull "W"/"P"/"G"	Finger Pull "W"/"P"/"G"

## Product features.

- 1 Standard grommet - matches pull finish or specify black TM30, silver TM31 or antique brass TM33
- Adjustable height from 29" to 47.5" with a maximum weight capacity of 375 lbs.
- Box/Box/File
- Lift available in MFS Silver (standard) or MFB Black (optional)
- Metal parts include 5 year warranty
- Programmable height adjustable mechanism, motor includes 2 year warranty

### NOTES

- Modesty surround lifts w/ work surface

## Options.

### ACCESSORIES

- K31: Center drawer - \$205

### BRIDGE

- MOD48: Modify 42" bridge to 48" - \$75

### DRAWER

- P6: Modify Box/Box/File to File/File - \$55 per pedestal
- P33: Wood Drawer Upgrade - \$45 per drawer
- WPD3061: Designer White - \$80 per pedestal fronts

### GROMMETS (NON-STANDARD LOCATION)

- Provide drawing w/ Grommet Location and Specify Color - \$95 ea.
- Black: TM30-NS
- Silver: TM31-NS
- Antique Brass: TM33-NS

### WIRE MANAGEMENT

- LWMB: Lift wire management box with flip down door - \$365
- Power strip with five outlets and 12' cord, mesh wire cover, 6" deep black box



# Central park.

Double Breakfront Height Adjustable Box / Box / File Pedestal Desk  
42" Return Shell

Left Pedestal User Side

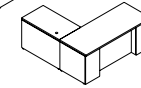
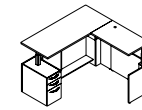

Left Pedestal Approach Side

[View statement of line](#)

1 Select a model w" x d" x h"	weight	Standard Veneer Top		Premium Veneer Top		High Pressure Laminate Top		Thermally Fused Laminate Top	
		Standard Veneer Chassis		Premium Veneer Chassis		Veneer Chassis		Thermally Fused Laminate Chassis	
<b>Left Pedestal</b>									
84 x 36/78 x 29-47.5	420	CPC8436DS789W	8846	CPC8436DS789P	9731	CPC8436DS789G	8846	CPC8436DS789M	7028
72 x 30/72 x 29-47.5	360	CPC7230DS789W	8417	CPC7230DS789P	9259	CPC7230DS789G	8417	CPC7230DS789M	6663
66 x 30/72 x 29-47.5	340	CPC6630DS789W	8349	CPC6630DS789P	9184	CPC6630DS789G	8349	CPC6630DS789M	6235
<b>Right Pedestal</b>									
84 x 36/78 x 29-47.5	420	CPC8436DS788W	8846	CPC8436DS788P	9731	CPC8436DS788G	8846	CPC8436DS788M	7028
72 x 30/72 x 29-47.5	360	CPC7230DS788W	8417	CPC7230DS788P	9259	CPC7230DS788G	8417	CPC7230DS788M	6663
66 x 30/72 x 29-47.5	340	CPC6630DS788W	8349	CPC6630DS788P	9184	CPC6630DS788G	8349	CPC6630DS788M	6235

2 Select a finish <a href="#">View finish details</a>	Standard Veneer Top		Premium Veneer Top		High Pressure Laminate Top		Thermally Fused Laminate Top	
WAC	WGW	TBCO	WSO	GAC	GNW	MAC		
WRC	WBW	TBSW		GIC	GSTV +10%	MEC		
WIC	WSW	TSTV		GEC	GSLV +10%	MHC		
WEC	WNW	TSMV		GHC	GWL	MOC		
WHC	WWP	TSLV		GOC		MGW		
WOC		TOBW		GAM		MTW		
WAM		WBO		GCM		MSW		
WCM		WMO		GWM		MWL		
WWM		WNO		GEW				
WEW								

3 Select a edge <a href="#">View edge details</a>	Standard Veneer Top		Premium Veneer Top		High Pressure Laminate Top		Thermally Fused Laminate Top			
+5%						+5%				
Bullnose	Classic	Cobee	Cove	Flat	Ledge	Bullnose	Classic	Cobee	Cove	Flat
			+5%				+5%			
Flat	Knife	Ledge	Ogee	Flat	Knife	Ledge	Ogee	Flat	Knife	Ledge
	+5%				+5%				+5%	
Reed	Radius	Waterfall		Reed	Radius	Waterfall		Reed	Radius	Waterfall

4 Select hardware <a href="#">View hardware details</a>	Standard Veneer Top		Premium Veneer Top		High Pressure Laminate Top		Thermally Fused Laminate Top	
PL-105 PL-106	PL-112 PL-113	PL-125 PL-127 PL-126	PL-105 PL-106	PL-112 PL-113	PL-125 PL-127 PL-126	PL-105 PL-106	PL-112 PL-113	PL-125 PL-127 PL-126
PL-115 PL-116	PL-210	PL-310 PL-311	PL-115 PL-116	PL-210	PL-310 PL-311	PL-115 PL-116	PL-210	PL-310 PL-311
Finger Pull "W"/"P"/"G"	Finger Pull "W"/"P"/"G"	Finger Pull "W"/"P"/"G"	Finger Pull "W"/"P"/"G"	Finger Pull "W"/"P"/"G"	Finger Pull "W"/"P"/"G"	Finger Pull "W"/"P"/"G"	Finger Pull "W"/"P"/"G"	Finger Pull "W"/"P"/"G"

## Product features.

- 1 Standard grommet - matches pull finish or specify black TM30, silver TM31 or antique brass TM33
- Adjustable height from 29" to 47.5" with a maximum weight capacity of 375 lbs.
- Box/Box/File
- Lift available in MFS Silver (standard) or MFB Black (optional)
- Metal parts include 5 year warranty
- Programmable height adjustable mechanism, motor includes 2 year warranty

### NOTES

- Modesty surround lifts w/ work surface

## Options.

### ACCESSORIES

- K31: Center drawer - \$205

### RETURN

- MOD48: Modify 42" return to 48" - \$75

### DRAWER

- P6: Modify Box/Box/File to File/File - \$55 per pedestal
- P33: Wood Drawer Upgrade - \$45 per drawer
- WPD3061: Designer White - \$80 per pedestal fronts

### GROMMETS (NON-STANDARD LOCATION)

- Provide drawing w/ Grommet Location and Specify Color - \$95 ea.
- Black: TM30-NS
- Silver: TM31-NS
- Antique Brass: TM33-NS

### WIRE MANAGEMENT

- LWMB: Lift wire management box with flip down door - \$365
- Power strip with five outlets and 12' cord, mesh wire cover, 6" deep black box

# Central park.

Double Breakfront Height Adjustable Box / Box / File Pedestal Desk  
42" File / File Pedestal Return

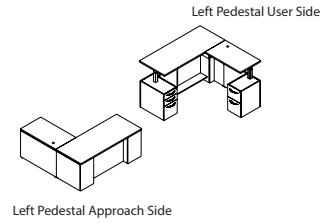

## 1 Select a model

w" x d" x h"

weight	Standard Veneer Top		Premium Veneer Top		High Pressure Laminate Top		Thermally Fused Laminate Top		
	Standard Veneer Chassis		Premium Veneer Chassis		Veneer Chassis		Thermally Fused Laminate Chassis		
<b>Left Desk Pedestal</b>									
84 x 36/78 x 29-47.5	480	CPC8436DS791W	9548	CPC8436DS791P	10503	CPC8436DS791G	9548	CPC8436DS791M	7588
72 x 30/72 x 29-47.5	420	CPC7230DS791W	9119	CPC7230DS791P	10031	CPC7230DS791G	9119	CPC7230DS791M	7223
66 x 30/72 x 29-47.5	400	CPC6630DS791W	9051	CPC6630DS791P	9956	CPC6630DS791G	9051	CPC6630DS791M	6794
<b>Right Desk Pedestal</b>									
84 x 36/78 x 29-47.5	480	CPC8436DS790W	9548	CPC8436DS790P	10503	CPC8436DS790G	9548	CPC8436DS790M	7588
72 x 30/72 x 29-47.5	420	CPC7230DS790W	9119	CPC7230DS790P	10031	CPC7230DS790G	9119	CPC7230DS790M	7223
66 x 30/72 x 29-47.5	400	CPC6630DS790W	9051	CPC6630DS790P	9956	CPC6630DS790G	9051	CPC6630DS790M	6794

View statement of line

## 2 Select a finish

View finish details

WAC	WGW	TBCO	WSO	GAC	GNW	MAC
WRC	WBW	TBSW		GIC	GSTV +10%	MEC
WIC	WSW	TSTV		GEC	GSLV +10%	MHC
WEC	WNW	TSMV		GHC	GWL	MOC
WHC	WWP	TSLV		GOC		MGW
WOC		TOBW		GAM		MTW
WAM		WBO		GCM		MSW
WCM		WMO		GWM		MWL
WWM		WNO		GEW		
WEW						

## 3 Select a edge

View edge details

+5%						+5%					
Bullnose	Classic	Cobee	Cove	Flat	Ledge	Bullnose	Classic	Cobee	Cove	Flat	
			+5%				+5%				
Flat	Knife	Ledge	Ogee	Flat	Knife	Ledge	Ogee	Flat	Knife	Ledge	Ogee
	+5%				+5%				+5%		
Reed	Radius	Waterfall		Reed	Radius	Waterfall		Reed	Radius	Waterfall	

## 4 Select hardware

View hardware details

PL-105 PL-106	PL-112 PL-113	PL-125 PL-127 PL-126	PL-105 PL-106	PL-112 PL-113	PL-125 PL-127 PL-126	PL-105 PL-106	PL-112 PL-113	PL-125 PL-127 PL-126	PL-105 PL-106	PL-112 PL-113	PL-125 PL-127 PL-126
PL-115 PL-116	PL-210	PL-310 PL-311	PL-115 PL-116	PL-210	PL-310 PL-311	PL-115 PL-116	PL-210	PL-310 PL-311	PL-115 PL-116	PL-210	PL-310 PL-311
Finger Pull "W"/"P"/"G"	Finger Pull "W"/"P"/"G"	Finger Pull "W"/"P"/"G"	Finger Pull "W"/"P"/"G"	Finger Pull "W"/"P"/"G"	Finger Pull "W"/"P"/"G"	Finger Pull "W"/"P"/"G"	Finger Pull "W"/"P"/"G"	Finger Pull "W"/"P"/"G"	Finger Pull "W"/"P"/"G"	Finger Pull "W"/"P"/"G"	Finger Pull "W"/"P"/"G"

## Product features.

- 1 Standard grommet - matches pull finish or specify black TM30, silver TM31 or antique brass TM33
- Adjustable height from 29" to 47.5" with a maximum weight capacity of 375 lbs.
- Box/Box/File
- Lift available in MFS Silver (standard) or MFB Black (optional)
- Metal parts include 5 year warranty
- Programmable height adjustable mechanism, motor includes 2 year warranty

### NOTES

- Modesty surround lifts w/ work surface

## Options.

### ACCESSORIES

- K31: Center drawer - \$205

### RETURN

- MOD48: Modify 42" return to 48" - \$75

### DRAWER

- P6: Modify Box/Box/File to File/File - \$55 per pedestal
- P33: Wood Drawer Upgrade - \$45 per drawer
- WPD3061: Designer White - \$80 per pedestal fronts

### GROMMETS (NON-STANDARD LOCATION)

- Provide drawing w/ Grommet Location and Specify Color - \$95 ea.
- Black: TM30-NS
- Silver: TM31-NS
- Antique Brass: TM33-NS

### WIRE MANAGEMENT

- LWMB: Lift wire management box with flip down door - \$365
- Power strip with five outlets and 12' cord, mesh wire cover, 6" deep black box

# Central park.

Flush Chassis Height Adjustable Box / Box / File Pedestal Desk  
42" Return Shell

Left Pedestal User Side

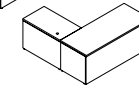
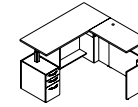

Left Pedestal Approach Side

## 1 Select a model

w" x d" x h"

weight	Standard Veneer Top		Premium Veneer Top		High Pressure Laminate Top		Thermally Fused Laminate Top		
	Standard Veneer Chassis		Premium Veneer Chassis		Veneer Chassis		Thermally Fused Laminate Chassis		
<b>Left Pedestal</b>									
84 X 36 x 29	420	CPC8436DS646W	8953	CPC8436DS646P	9848	CPC8436DS646G	8953	CPC8436DS646M	9131
72 x 30 x 29	360	CPC7230DS646W	8492	CPC7230DS646P	9341	CPC7230DS646G	8492	CPC7230DS646M	6674
66 x 30 x 29	340	CPC6630DS646W	8419	CPC6630DS646P	9261	CPC6630DS646G	8419	CPC6630DS646M	6230
<b>Right Pedestal</b>									
84 x 36 x 29	420	CPC8436DS645W	8953	CPC8436DS645P	9848	CPC8436DS645G	8953	CPC8436DS645M	9131
72 x 30 x 29	360	CPC7230DS645W	8492	CPC7230DS645P	9341	CPC7230DS645G	8492	CPC7230DS645M	6674
66 x 30 x 29	340	CPC6630DS645W	8419	CPC6630DS645P	9261	CPC6630DS645G	8419	CPC6630DS645M	6230

View statement of line

## 2 Select a finish

View finish details

WAC	WGW	TBCO	WSO	GAC	GNW	MAC
WRC	WBW	TBSW		GIC	GSTV +10%	MEC
WIC	WSW	TSTV		GEC	GSLV +10%	MHC
WEC	WNW	TSMV		GHC	GWL	MOC
WHC	WWP	TSLV		GOC		MGW
WOC		TOBW		GAM		MTW
WAM		WBO		GCM		MSW
WCM		WMO		GWM		MWL
WWM		WNO		GEW		
WEW						

## 3 Select a edge

View edge details

+5%						+5%					
Bullnose	Classic	Cobee	Cove	Flat	Ledge	Bullnose	Classic	Cobee	Cove	Flat	
			+5%				+5%				+5%
Flat	Knife	Ledge	Ogee	Flat	Knife	Ledge	Ogee	Flat	Knife	Ledge	Ogee
	+5%				+5%				+5%		
Reed	Radius	Waterfall		Reed	Radius	Waterfall		Reed	Radius	Waterfall	

## 4 Select hardware

View hardware details

PL-105 PL-106	PL-112 PL-113	PL-125 PL-127 PL-126	PL-105 PL-106	PL-112 PL-113	PL-125 PL-127 PL-126	PL-105 PL-106	PL-112 PL-113	PL-125 PL-127 PL-126	PL-105 PL-106	PL-112 PL-113	PL-125 PL-127 PL-126
PL-115 PL-116	PL-210	PL-310 PL-311	PL-115 PL-116	PL-210	PL-310 PL-311	PL-115 PL-116	PL-210	PL-310 PL-311	PL-115 PL-116	PL-210	PL-310 PL-311
Finger Pull "W"/"P"/"G"	Finger Pull "W"/"P"/"G"	Finger Pull "W"/"P"/"G"	Finger Pull "W"/"P"/"G"	Finger Pull "W"/"P"/"G"	Finger Pull "W"/"P"/"G"	Finger Pull "W"/"P"/"G"	Finger Pull "W"/"P"/"G"	Finger Pull "W"/"P"/"G"	Finger Pull "W"/"P"/"G"	Finger Pull "W"/"P"/"G"	Finger Pull "W"/"P"/"G"

## Product features.

- 1 Standard grommet - matches pull finish or specify black TM30, silver TM31 or antique brass TM33
- Adjustable height from 29" to 47.5" with a maximum weight capacity of 375 lbs.
- Box/Box/File
- Lift available in MFS Silver (standard) or MFB Black (optional)
- Metal parts include 5 year warranty
- Programmable height adjustable mechanism, motor includes 2 year warranty

### NOTES

- Modesty surround lifts w/ work surface

## Options.

### ACCESSORIES

- K31: Center drawer - \$205

### RETURN

- MOD48: Modify 42" return to 48" - \$75

### DRAWER

- P6: Modify Box/Box/File to File/File - \$55 per pedestal
- P33: Wood Drawer Upgrade - \$45 per drawer
- WPD3061: Designer White - \$80 per pedestal fronts

### GROMMETS (NON-STANDARD LOCATION)

- Provide drawing w/ Grommet Location and Specify Color - \$95 ea.
- Black: TM30-NS
- Silver: TM31-NS
- Antique Brass: TM33-NS

### WIRE MANAGEMENT

- LWMB: Lift wire management box with flip down door - \$365
- Power strip with five outlets and 12' cord, mesh wire cover, 6" deep black box

# Central park.

Flush Chassis Height Adjustable Box / Box / File Pedestal Desk  
42" File / File Pedestal Return

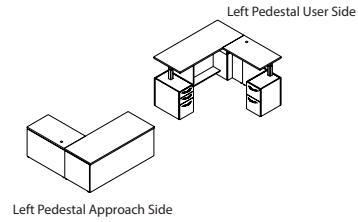

## 1 Select a model

w" x d" x h"

weight	Standard Veneer Top		Premium Veneer Top		High Pressure Laminate Top		Thermally Fused Laminate Top		
	Standard Veneer Chassis		Premium Veneer Chassis		Veneer Chassis		Thermally Fused Laminate Chassis		
<b>Left Desk Pedestal</b>									
84 x 36/78 x 29-47.5	480	CPC8436DS648W	9655	CPC8436DS648P	10621	CPC8436DS648G	9655	CPC8436DS648M	7611
72 x 30/72 x 29-47.5	420	CPC7230DS648W	9194	CPC7230DS648P	10113	CPC7230DS648G	9194	CPC7230DS648M	7233
66 x 30/72 x 29-47.5	400	CPC6630DS648W	9121	CPC6630DS648P	10033	CPC6630DS648G	9121	CPC6630DS648M	6789
<b>Right Desk Pedestal</b>									
84 x 36/78 x 29-47.5	480	CPC8436DS647W	9655	CPC8436DS647P	10621	CPC8436DS647G	9655	CPC8436DS647M	7611
72 x 30/72 x 29-47.5	420	CPC7230DS647W	9194	CPC7230DS647P	10113	CPC7230DS647G	9194	CPC7230DS647M	7233
66 x 30/72 x 29-47.5	400	CPC6630DS647W	9121	CPC6630DS647P	10033	CPC6630DS647G	9121	CPC6630DS647M	6789

View statement of line

## 2 Select a finish

View finish details

WAC	WGW	TBCO	WSO	GAC	GNW	MAC
WRC	WBW	TBSW		GIC	GSTV +10%	MEC
WIC	WSW	TSTV		GEC	GSLV +10%	MHC
WEC	WNW	TSMV		GHC	GWL	MOC
WHC	WWP	TSLV		GOC		MGW
WOC		TOBW		GAM		MTW
WAM		WBO		GCM		MSW
WCM		WMO		GWM		MWL
WWM		WNO		GEW		
WEW						

## 3 Select a edge

View edge details

Bullnose	Classic	Cobee	Cove	Flat	Ledge	Bullnose	Classic	Cobee	Cove	Flat	Ledge	Ogee
Reed	Radius	Waterfall		Reed	Radius	Waterfall						

## 4 Select hardware

View hardware details

PL-105 PL-106	PL-112 PL-113	PL-125 PL-127 PL-126	PL-105 PL-106	PL-112 PL-113	PL-125 PL-127 PL-126	PL-105 PL-106	PL-112 PL-113	PL-125 PL-127 PL-126	PL-105 PL-106	PL-112 PL-113	PL-125 PL-127 PL-126
PL-115 PL-116	PL-210	PL-310 PL-311	PL-115 PL-116	PL-210	PL-310 PL-311	PL-115 PL-116	PL-210	PL-310 PL-311	PL-115 PL-116	PL-210	PL-310 PL-311
Finger Pull "W"/"P"/"G"			Finger Pull "W"/"P"/"G"			Finger Pull "W"/"P"/"G"			Finger Pull "W"/"P"/"G"		

## Product features.

- 1 Standard grommet - matches pull finish or specify black TM30, silver TM31 or antique brass TM33
- Adjustable height from 29" to 47.5" with a maximum weight capacity of 375 lbs.
- Box/Box/File
- Lift available in MFS Silver (standard) or MFB Black (optional)
- Metal parts include 5 year warranty
- Programmable height adjustable mechanism, motor includes 2 year warranty

### NOTES

- Modesty surround lifts w/ work surface

## Options.

### ACCESSORIES

- K31: Center drawer - \$205

### RETURN

- MOD48: Modify 42" return to 48" - \$75

### DRAWER

- P6: Modify Box/Box/File to File/File - \$55 per pedestal
- P33: Wood Drawer Upgrade - \$45 per drawer
- WPD3061: Designer White - \$80 per pedestal fronts

### GROMMETS (NON-STANDARD LOCATION)

- Provide drawing w/ Grommet Location and Specify Color - \$95 ea.
- Black: TM30-NS
- Silver: TM31-NS
- Antique Brass: TM33-NS

### WIRE MANAGEMENT

- LWMB: Lift wire management box with flip down door - \$365
- Power strip with five outlets and 12' cord, mesh wire cover, 6" deep black box

# Central park.

Height Adjustable Work Wall Desk  
Work Wall Shell

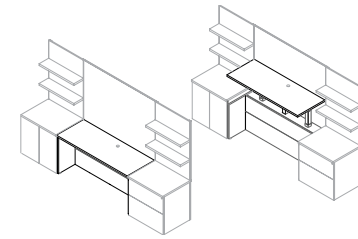

## 1 Select a model

w" x d" x h"

weight	Standard Veneer Top		Premium Veneer Top		High Pressure Laminate Top		Thermally Fused Laminate Top	
	Standard Veneer Chassis		Premium Veneer Chassis		Veneer Chassis		Thermally Fused Laminate Chassis	
42 x 24 x 29	CPC4224DS005W	4160	CPC4224DS005P	4576	CPC4224DS005G	4160	CPC4224DS005M	3328
48 x 24 x 29	CPC4824DS005W	4368	CPC4824DS005P	4805	CPC4824DS005G	4368	CPC4824DS005M	3494
60 x 24 x 29	CPC6024DS005W	4576	CPC6024DS005P	5034	CPC6024DS005G	4576	CPC6024DS005M	3661
72 x 24 x 29	CPC7224DS005W	4784	CPC7224DS005P	5262	CPC7224DS005G	4784	CPC7224DS005M	3827

[View statement of line](#)

## 2 Select a finish

[View finish details](#)

WAC	WGW	TBCO	WSO	GAC	GNW	MAC
WRC	WBW	TBSW		GIC	GSTV +10%	MEC
WIC	WSW	TSTV		GEC	GSLV +10%	MHC
WEC	WNW	TSMV		GHC	GWL	MOC
WHC	WWP	TSLV		GOC		MGW
WOC		TOBW		GAM		MTW
WAM		WBO		GCM		MSW
WCM		WMO		GWM		MWL
WWM		WNO		GEW		
WEW						

## 3 Select a edge

[View edge details](#)

Bullnose	Classic	Cobee	Cove	Bullnose	Classic	Cobee	Cove	Flat
Flat	Knife	Ledge	Ogee	Flat	Knife	Ledge	Ogee	
Reed	Radius	Waterfall		Reed	Radius	Waterfall		

## 4 Select hardware

[View hardware details](#)

Hardware		Hardware		Hardware		Hardware
N/A		N/A		N/A		N/A

## Product features.

- Metal column with grommet for wire management
- Full depth end panels, wall attachment not required
- 1 Standard grommet - matches pull finish or specify black TM30, silver TM31 or antique brass TM33
- Adjustable height from 29" to 47.5" with a maximum weight capacity of 350 lbs.
- Lift available in MFS Silver (standard) or MFB Black (optional)
- Metal parts include 5 year warranty
- Programmable height adjustable mechanism, motor includes 2 year warranty

### NOTES

- Top is 1/2" shorter each side, 1-1/2" short in depth.
- 60" - 70" work wall shell comes with double modesty doors.

### GROMMETS (STANDARD LOCATION)

Specify Color and Left/Right - \$50 ea.

- Black: TM30-R (Right), TM30-L (Left)
- Silver: TM31-R (Right), TM31-L (Left)
- Antique Brass: TM33-R (Right), TM33-L (Left)

### GROMMETS (NON-STANDARD LOCATION)

Provide drawing w/ Grommet Location and Specify Color - \$95 ea.

- Black: TM30-NS
- Silver: TM31-NS
- Antique Brass: TM33-NS

# Central park.

Height Adjustable Table Desk  
Table Desks

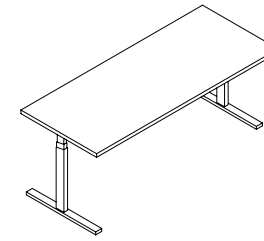

## 1 Select a model

w" x d" x h"

weight	Standard Veneer Top		Premium Veneer Top		High Pressure Laminate Top		Thermally Fused Laminate Top				
	Standard Veneer Chassis		Premium Veneer Chassis		Veneer Chassis		Thermally Fused Laminate Chassis				
72 x 36 x 1.125	245	CPC7236DT090W 3104	CPC7236DT090P 3414	CPC7236DT090G 2953	CPC7236DT090M 2700	72 x 30 x 1.125	230	CPC7230DT090W 3043	CPC7230DT090P 3347	CPC7230DT090G 2897	CPC7230DT090M 2667
66 x 30 x 1.125	215	CPC6630DT090W 3026	CPC6630DT090P 3329	CPC6630DT090G 2885	CPC6630DT090M 2655	60 x 30 x 1.125	200	CPC6030DT090W 3010	CPC6030DT090P 3311	CPC6030DT090G 2875	CPC6030DT090M 2581

[View statement of line](#)

## 2 Select a finish

[View finish details](#)

WAC	WGW	TBCO	WSO	GAC	GNW	MAC
WRC	WBW	TBSW		GIC	GSTV +10%	MEC
WIC	WSW	TSTV		GEC	GSLV +10%	MHC
WEC	WNW	TSMV		GHC	GWL	MOC
WHC	WWP	TSLV		GOC		MGW
WOC		TOBW		GAM		MTW
WAM		WBO		GCM		MSW
WCM		WMO		GWM		MWL
WWW		WNO		GEW		
WEW						

## 3 Select a edge

[View edge details](#)

+5%											
Flat	Knife	Ledge	Ogee	Flat	Knife	Ledge	Ogee	Flat	Knife	Ledge	Ogee
Reed	Radius	Waterfall		Reed	Radius	Waterfall		Reed	Radius	Waterfall	

## 4 Select hardware

[View hardware details](#)

Hardware	Hardware	Hardware	Hardware
N/A	N/A	N/A	N/A

## Product features.

- Adjustable height from 29" to 47.5" with a maximum weight capacity of 220 lbs.
- Lift available in MFS Silver (standard) or MFB Black (optional)
- Metal parts include 5 year warranty
- Programmable height adjustable mechanism, motor includes 2 year warranty

## Options.

### GROMMETS (STANDARD LOCATION)

- Specify Color and Location (Right/Left/Center) - \$50 ea.
- Black: TM30-R (Right), TM30-L (Left), TM30-C (Center)
  - Silver: TM31-R (Right), TM31-L (Left), TM31-C (Center)
  - White: TM34-R (Right), TM34-L (Left), TM34-C (Center)

### GROMMETS (NON-STANDARD LOCATION)

- Provide drawing w/ Grommet Location and Specify Color - \$95 ea.
- Black: TM30-NS
  - Silver: TM32-NS
  - White: TM34-NS

### EXPOSED PLYWOOD EDGE

- WEPB: Exposed Plywood Edge w/ Baltic Birch Veneer - n/c
- Only available with WCF - Clear Coat Finish

### MODESTY

- HM3: Veneer Half Modesty - \$260 (For "W" and "G")
- HM3M: Melamine Half Modesty - \$205 (For "M")

# Central park.

Height Adjustable Bridges

Open Back With 4"H Wire Management Rail

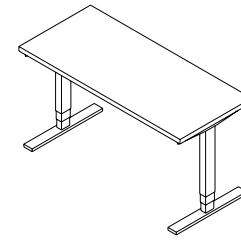

[View statement of line](#)

1 Select a model w" x d" x h"	weight	Standard Veneer Top Standard Veneer Chassis		Premium Veneer Top Premium Veneer Chassis		High Pressure Laminate Top Veneer Chassis		Thermally Fused Laminate Top Thermally Fused Laminate Chassis	
		60 x 24 x 29	105	CPC6024LB151W	2826	CPC6024LB151P	3109	CPC6024LB151G	2826
54 x 24 x 29	100	CPC5424LB151W	2718	CPC5424LB151P	2990	CPC5424LB151G	2718	CPC5424LB151M	2511
48 x 24 x 29	95	CPC4824LB151W	2619	CPC4824LB151P	2881	CPC4824LB151G	2619	CPC4824LB151M	2489
42 x 24 x 29	90	CPC4224LB151W	2582	CPC4224LB151P	2840	CPC4224LB151G	2582	CPC4224LB151M	2466

2 Select a finish <a href="#">View finish details</a>	Standard Veneer Top		Premium Veneer Top		High Pressure Laminate Top		Thermally Fused Laminate Top	
	WAC	WGW	TBCO	WSO	GAC	GNW	MAC	
	WRC	WBW	TBSW		GIC	GSTV +10%	MEC	
	WIC	WSW	TSTV		GEC	GSLV +10%	MHC	
	WEC	WNW	TSMV		GHC	GWL	MOC	
	WHC	WWP	TSLV		GOC		MGW	
	WOC		TOBW		GAM		MTW	
	WAM		WBO		GCM		MSW	
	WCM		WMO		GWM		MWL	
	WWW		WNO		GEW			
	WEW							

3 Select a edge <a href="#">View edge details</a>	Standard Veneer Top		Premium Veneer Top		High Pressure Laminate Top		Thermally Fused Laminate Top	
	Bullnose	Classic	Cobee	Cove	Flat	Ledge	Bullnose	Classic
	Cobee	Cove	Flat	Knife	Ledge	Ogee	Flat	Knife
	Ledge	Ogee	Reed	Radius	Waterfall		Flat	Ledge
	Reed	Radius	Waterfall				Flat	Ogee
							Reed	Radius
							Radius	Waterfall

4 Select hardware <a href="#">View hardware details</a>	Standard Veneer Top	Premium Veneer Top	High Pressure Laminate Top	Thermally Fused Laminate Top
	Hardware N/A	Hardware N/A	Hardware N/A	Hardware N/A

## Product features.

- 1 Standard grommet - matches pull finish or specify black TM30, silver TM31 or antique brass TM33
- Adjustable height from 29" to 47.5" with a maximum weight capacity of 220 lbs.
- Metal parts include 5 year warranty
- Lift available in MFS Silver (standard) or MFB Black (optional)
- Programmable height adjustable mechanism, motor includes 2 year warranty

## Options.

### CURVED BRIDGE

- CBT1: Modify to Curved Bridge - \$55

### GROMMETS (NON-STANDARD LOCATION)

Provide drawing w/ Grommet Location and Specify Color - \$95 ea.

- Black: TM30-NS
- Silver: TM31-NS
- Antique Brass: TM33-NS

# Central park.

Conference Desks  
Elliptical Conference Desk

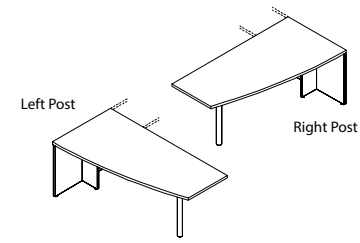

1 Select a model w" x d" x h"	weight	Standard Veneer Top Standard Veneer Chassis		Premium Veneer Top Premium Veneer Chassis		High Pressure Laminate Top Veneer Chassis		Thermally Fused Laminate Top Thermally Fused Laminate Chassis	
		<b>Left Post</b> 72 x 36/24 x 29 66 x 36/24 x 29 66 x 30/24 x 29	155 145 110	CPC7236DC720W CPC6636DC720W CPC6630DC720W	2734 2692 2599	CPC7236DC720P CPC6636DC720P CPC6630DC720P	3007 2961 2859	CPC7236DC720G CPC6636DC720G CPC6630DC720G	2734 2692 2599
<b>Right Post</b> 72 x 36/24 x 29 66 x 36/24 x 29 66 x 30/24 x 29	155 145 110	CPC7236DC719W CPC6636DC719W CPC6630DC719W	2734 2692 2599	CPC7236DC719P CPC6636DC719P CPC6630DC719P	3007 2961 2859	CPC7236DC719G CPC6636DC719G CPC6630DC719G	2734 2692 2599	CPC7236DC719M CPC6636DC719M CPC6630DC719M	1199 1163 1002
<b>2 Select a finish</b> <i>View finish details</i>		WAC WRC WIC	WGW WBW WSW	TBCO TBSW TSTV	WSO	GAC GIC GEC GHC	GNW GSTV +10% GSLV +10% GWL	MAC MEC MHC MOC	
<b>Metal finish</b> MFS Silver (standard), MFB Black (optional)		WEC WHC WOC WAM WCM WWM WEW	WNW WWP	TSMV TSLV TOBW WBO WMO WNO		GOC GAM GCM GWM GEW		MGW MTW MSW MWL	
<b>3 Select a edge</b> <i>View edge details</i>		Bullnose Classic Cobee Cove Flat Knife Ledge Ogee Reed Radius Waterfall		Flat Ledge		Bullnose Classic Cobee Cove Flat Knife Ledge Ogee Reed Radius Waterfall		Flat	
<b>4 Select hardware</b> <i>View hardware details</i>		Hardware N/A		Hardware N/A		Hardware N/A		Hardware N/A	

*View statement of line*

## Product features.

- 3" Silver anodized aluminum post leg standard (Optional black leg - n/c)
- Hookup hardware
- "T" Panel end

### NOTES

- All units are standard w/ flush ends
- Not Recommended for Freestanding Use
- See Options Sections for Additional Bases Available.

## Options.

### ACCESSORIES

- K31: Center drawer - \$205
- K31-SK: Center drawer w/ skirt - \$310

### BASE

- SSB24: 24" Silver metal sleigh base - \$470
- SSB30: 30" metal sleigh base - \$495

### GROMMETS (STANDARD LOCATION)

- Specify Color - \$50 ea.
- Black: TM30-C (Center)
  - Silver: TM31-C (Center)
  - Antique Brass: TM33-C (Center)

### GROMMETS (NON-STANDARD LOCATION)

- Provide drawing w/ Grommet Location and Specify Color - \$95 ea.
- Black: TM30-NS
  - Silver: TM31-NS
  - Antique Brass: TM33-NS

### MODESTY

- HM45: SilverLuma frame/frost insert (half modesty) - \$415
- MC51: Half veneer/laminate modesty - \$130



# Central park.

Conference Desks  
Bullet Conference Desk

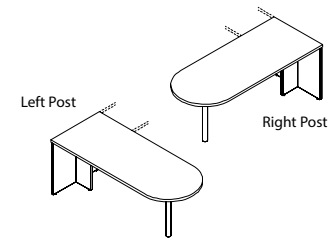

[View statement of line](#)

1 Select a model w" x d" x h"	weight	Standard Veneer Top Standard Veneer Chassis		Premium Veneer Top Premium Veneer Chassis		High Pressure Laminate Top Veneer Chassis		Thermally Fused Laminate Top Thermally Fused Laminate Chassis	
		<b>Left Post</b> 72 x 36 x 29 72 x 30 x 29 66 x 30 x 29 60 x 30 x 29 <b>Right Post</b> 72 x 36 x 29 72 x 30 x 29 66 x 30 x 29 60 x 30 x 29							
		160	CPC7236DC716W 2892	CPC7236DC716P 3181	CPC7236DC716G 2892	CPC7236DC715M 1451			
		150	CPC7230DC716W 2779	CPC7230DC716P 3057	CPC7230DC716G 2779	CPC7230DC715M 1430			
		125	CPC6630DC716W 2734	CPC6630DC716P 3007	CPC6630DC716G 2734	CPC6630DC715M 1404			
		110	CPC6030DC716W 2692	CPC6030DC716P 2961	CPC6030DC716G 2692	CPC6030DC715M 1352			
		160	CPC7236DC715W 2892	CPC7236DC715P 3181	CPC7236DC715G 2892	CPC7236DC715M 1451			
		150	CPC7230DC715W 2779	CPC7230DC715P 3057	CPC7230DC715G 2779	CPC7230DC715M 1430			
		125	CPC6630DC715W 2734	CPC6630DC715P 3007	CPC6630DC715G 2734	CPC6630DC715M 1404			
		110	CPC6030DC715W 2692	CPC6030DC715P 2961	CPC6030DC715G 2692	CPC6030DC715M 1352			
2 Select a finish <a href="#">View finish details</a>									
Metal finish MFS Silver (standard), MFB Black (optional)	WAC WGW WRC WBW WIC WSW WEC WNW WHC WWP WOC WAM WCM WWM WEW			TBCO WSO TBSW TSTV TSMV TSLV TOBW WBO WMO WNO		GAC GNW GIC GSTV +10% GEC GSLV +10% GHC GWL GOC GAM GCM GWM GEW		MAC MEC MHC MOC MGW MTW MSW MWL	
3 Select a edge <a href="#">View edge details</a>									
4 Select hardware <a href="#">View hardware details</a>									
	Hardware N/A			Hardware N/A		Hardware N/A		Hardware N/A	

## Product features.

- 3" Silver anodized aluminum post leg standard (Optional black leg - n/c)
- Hookup hardware
- "T" Panel end

### NOTES

- All units are standard w/ flush ends
- Not Recommended for Freestanding Use
- "P" Tops and Bullets are not intended to be freestanding
- See Options Sections for Additional Bases Available.

## Options.

### ACCESSORIES

- K28: Articulating Keyboard w/ Mouse - \$390
- K31: Center drawer - \$205
- K31-SK: Center drawer w/ skirt - \$310

### GROMMETS (STANDARD LOCATION)

- Specify Color - \$50 ea.
- Black: TM30-C (Center)
  - Silver: TM31-C (Center)
  - Antique Brass: TM33-C (Center)

### GROMMETS (NON-STANDARD LOCATION)

- Provide drawing w/ Grommet Location and Specify Color - \$95 ea.
- Black: TM30-NS
  - Silver: TM31-NS
  - Antique Brass: TM33-NS

### MODESTY

- HM45: SilverLuma frame/frost insert (half modesty) - \$415
- MC51: Half veneer/laminate modesty - \$130

# Central park.

Conference Desks

"P" Conference Desk

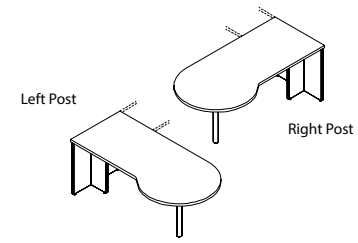

1 Select a model w" x d" x h"	weight	Standard Veneer Top		Premium Veneer Top		High Pressure Laminate Top		Thermally Fused Laminate Top	
		Standard Veneer Chassis		Premium Veneer Chassis		Veneer Chassis		Thermally Fused Laminate Chassis	
<b>Left Post</b>									
72 x 36/42 x 29	185	CPC7242DC028W	3030	CPC7242DC028P	3333	CPC7242DC028G	3030	CPC7242DC028M	1690
72 x 30/36 x 29	165	CPC7236DC028W	2944	CPC7236DC028P	3238	CPC7236DC028G	2944	CPC7236DC028M	1659
66 x 30/36 x 29	155	CPC6636DC028W	2864	CPC6636DC028P	3150	CPC6636DC028G	2864	CPC6636DC028M	1638
<b>Right Post</b>									
72 x 36/42 x 29	185	CPC7242DC027W	3030	CPC7242DC027P	3333	CPC7242DC027G	3030	CPC7242DC027M	1690
72 x 30/36 x 29	165	CPC7236DC027W	2944	CPC7236DC027P	3238	CPC7236DC027G	2944	CPC7236DC027M	1659
66 x 30/36 x 29	155	CPC6636DC027W	2864	CPC6636DC027P	3150	CPC6636DC027G	2864	CPC6636DC027M	1638
<b>2 Select a finish</b> <i>View finish details</i>		WAC	WGW	TBCO	WSO	GAC	GNW	MAC	
		WRC	WBW	TBSW		GIC	GSTV +10%	MEC	
		WIC	WSW	TSTV		GEC	GSLV +10%	MHC	
<b>Metal finish</b>		WEC	WNW	TSMV		GHC	GWL	MOC	
MFS Silver (standard),		WHC	WWP	TSLV		GOC		MGW	
MFB Black (optional)		WOC		TOBW		GAM		MTW	
		WAM		WBO		GCM		MSW	
		WCM		WMO		GWM		MWL	
		WWW		WNO		GEW			
		WEW							
<b>3 Select a edge</b> <i>View edge details</i>									
		Bullnose	Classic	Cobee	Cove	Flat	Ledge	Flat	
		Flat	Knife	Ledge	Ogee	Flat	Knife	Ledge	Ogee
		Reed	Radius	Waterfall		Reed	Radius	Waterfall	
<b>4 Select hardware</b> <i>View hardware details</i>		Hardware		Hardware		Hardware		Hardware	
		N/A		N/A		N/A		N/A	

*View statement of line*

## Product features.

- 3" Silver anodized aluminum post leg standard (Optional black leg - n/c)
- Hookup hardware
- "T" Panel end

### NOTES

- All units are standard w/ flush ends
- Not Recommended for Freestanding Use
- "P" Tops and Bullets are not intended to be freestanding
- See Options Sections for Additional Bases Available.

## Options.

### ACCESSORIES

- K28: Articulating Keyboard w/ Mouse - \$390
- K31: Center drawer - \$205
- K31-SK: Center drawer w/ skirt - \$310

### GROMMETS (STANDARD LOCATION)

- Specify Color - \$50 ea.
- Black: TM30-C (Center)
  - Silver: TM31-C (Center)
  - Antique Brass: TM33-C (Center)

### GROMMETS (NON-STANDARD LOCATION)

- Provide drawing w/ Grommet Location and Specify Color - \$95 ea.
- Black: TM30-NS
  - Silver: TM31-NS
  - Antique Brass: TM33-NS

### MODESTY

- HM45: SilverLuma frame/frost insert (half modesty) - \$415
- MC51: Half veneer/laminate modesty - \$130

# Central park.

Conference Desks

Rectangle Conference Desk With Sleigh Base

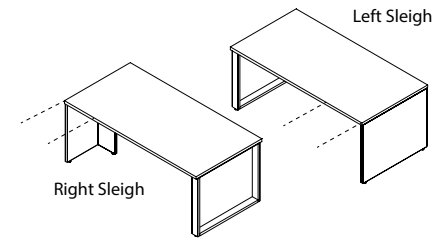

## 1 Select a model

w" x d" x h"

weight	Standard Veneer Top		Premium Veneer Top		High Pressure Laminate Top		Thermally Fused Laminate Top		
	Standard Veneer Chassis		Premium Veneer Chassis		Veneer Chassis		Thermally Fused Laminate Chassis		
<b>Left Sleigh Leg</b>									
72 x 36 x 29	160	CPC7236DC767W	2872	CPC7236DC767P	3159	CPC7236DC767G	2872	CPC7236DC767M	1412
72 x 30 x 29	150	CPC7230DC767W	2757	CPC7230DC767P	3033	CPC7230DC767G	2757	CPC7230DC767M	1249
66 x 36 x 29	155	CPC6636DC767W	2757	CPC6636DC767P	3033	CPC6636DC767G	2757	CPC6636DC767M	1249
60 x 30 x 29	110	CPC6030DC767W	2671	CPC6030DC767P	2938	CPC6030DC767G	2671	CPC6030DC767M	1189
<b>Right Sleigh Leg</b>									
72 x 36 x 29	160	CPC7236DC766W	2872	CPC7236DC766P	3159	CPC7236DC766G	2872	CPC7236DC766M	1412
72 x 30 x 29	150	CPC7230DC766W	2757	CPC7230DC766P	3033	CPC7230DC766G	2757	CPC7230DC766M	1249
66 x 36 x 29	155	CPC6636DC766W	2757	CPC6636DC766P	3033	CPC6636DC766G	2757	CPC6636DC766M	1249
60 x 30 x 29	110	CPC6030DC766W	2671	CPC6030DC766P	2938	CPC6030DC766G	2671	CPC6030DC766M	1189

[View statement of line](#)

## 2 Select a finish

[View finish details](#)

**Metal finish**  
MFS Silver. Additional metal finishes are available, see options.

WAC	WGW	TBCO	WSO	GAC	GNW	MAC
WRC	WBW	TBSW		GIC	GSTV +10%	MEC
WIC	WSW	TSTV		GEC	GSLV +10%	MHC
WEC	WNW	TSMV		GHC	GWL	MOC
WHC	WWP	TSLV		GOC		MGW
WOC		TOBW		GAM		MTW
WAM		WBO		GCM		MSW
WCM		WMO		GWM		MWL
WWM		WNO		GEW		
WEW						

## 3 Select a edge

[View edge details](#)

Bullnose	Classic	Cobee	Cove	Flat	Ledge	Bullnose	Classic	Cobee	Cove	Flat	
Flat	Knife	Ledge	Ogee	Flat	Knife	Ledge	Ogee	Flat	Knife	Ledge	Ogee
Reed	Radius	Waterfall		Reed	Radius	Waterfall		Reed	Radius	Waterfall	

## 4 Select hardware

[View hardware details](#)

Hardware	Hardware	Hardware	Hardware
N/A	N/A	N/A	N/A

## Product features.

- Hookup hardware
- Metal sleigh base - standard silver finish
- "T" Panel end

### NOTES

- All units are standard w/ flush ends

## Options.

### ACCESSORIES

- K28: Articulating Keyboard w/ Mouse - \$390
- K31: Center drawer - \$205
- K31-SK: Center drawer w/ skirt - \$310

### BASE

- RDL-S: Silver round post leg - deduct \$260
- RDL-S: Silver round post leg - deduct \$260
- SQL-S: Silver square post leg - deduct \$260
- SQL-B: Black square post leg - deduct \$260

### GROMMETS (STANDARD LOCATION)

- Specify Color - \$50 ea.
- Black: TM30-C (Center)
- Silver: TM31-C (Center)
- Antique Brass: TM33-C (Center)

### GROMMETS (NON-STANDARD LOCATION)

- Provide drawing w/ Grommet Location and Specify Color - \$95 ea.
- Black: TM30-NS
- Silver: TM31-NS
- Antique Brass: TM33-NS

### MODESTY

- HM45: SilverLuma frame/frost insert (half modesty) - \$415
- MC51: Half veneer/laminate modesty - \$130
- Premium Finish Option
- MFB: Black metal finish - \$160 per base

# Central park.

Conference Runoff Desks  
Bullet Runoff Desk

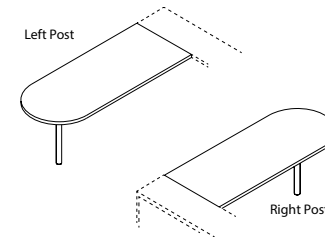

View statement of line

1 Select a model w" x d" x h"	weight	Standard Veneer Top Standard Veneer Chassis		Premium Veneer Top Premium Veneer Chassis		High Pressure Laminate Top Veneer Chassis		Thermally Fused Laminate Top Thermally Fused Laminate Chassis				
		<b>Left Post</b>										
72 x 30 x 29	155	CPC7230DR745W	2025	CPC7230DR745P	2228	CPC7230DR745G	2025	CPC7230DR745M	951			
66 x 30 x 29	145	CPC6630DR745W	1924	CPC6630DR745P	2116	CPC6630DR745G	1924	CPC6630DR745M	919			
60 x 30 x 29	135	CPC6030DR745W	1860	CPC6030DR745P	2046	CPC6030DR745G	1860	CPC6030DR745M	889			
54 x 30 x 29	125	CPC5430DR745W	1794	CPC5430DR745P	1973	CPC5430DR745G	1794	CPC5430DR745M	858			
<b>Right Post</b>												
72 x 30 x 29	155	CPC7230DR744W	2025	CPC7230DR744P	2228	CPC7230DR744G	2025	CPC7230DR744M	951			
66 x 30 x 29	145	CPC6630DR744W	1924	CPC6630DR744P	2116	CPC6630DR744G	1924	CPC6630DR744M	919			
60 x 30 x 29	135	CPC6030DR744W	1860	CPC6030DR744P	2046	CPC6030DR744G	1860	CPC6030DR744M	889			
54 x 30 x 29	125	CPC5430DR744W	1794	CPC5430DR744P	1973	CPC5430DR744G	1794	CPC5430DR744M	858			
<b>2 Select a finish</b> <i>View finish details</i>		WAC	WGW	TBCO	WSO	GAC	GNW	MAC				
		WRC	WBW	TBSW		GIC	GSTV +10%	MEC				
		WIC	WSW	TSTV		GEC	GSLV +10%	MHC				
<b>Metal finish</b>		WEC	WNW	TSMV		GHC	GWL	MOC				
MFS Silver (standard),		WHC	WWP	TSLV		GOC		MGW				
MFB Black (optional)		WOC		TOBW		GAM		MTW				
		WAM		WBO		GCM		MSW				
		WCM		WMO		GWM		MWL				
		WWM		WNO		GEW						
		WEW										
<b>3 Select a edge</b> <i>View edge details</i>												
<b>4 Select hardware</b> <i>View hardware details</i>		Hardware	N/A	Hardware	N/A	Hardware	N/A	Hardware	N/A			

## Product features.

- 3" Silver anodized aluminum post leg standard (Optional black leg - r/c)
- Hookup hardware

### NOTES

- "P" Tops and Bullets are not intended to be freestanding
- Verify Desk Kneespace On Sizes Under 66"W
- See Bench Runoff Supports when using with Bench Credenza

## Options.

### ACCESSORIES

- K28: Articulating Keyboard w/ Mouse - \$390
- K31: Center drawer - \$205
- K31-SK: Center drawer w/ skirt - \$310

### GROMMETS (STANDARD LOCATION)

- Specify Color - \$50 ea.
- Black: TM30-C (Center)
  - Silver: TM31-C (Center)
  - Antique Brass: TM33-C (Center)

### GROMMETS (NON-STANDARD LOCATION)

- Provide drawing w/ Grommet Location and Specify Color - \$95 ea.
- Black: TM30-NS
  - Silver: TM31-NS
  - Antique Brass: TM33-NS

### MODESTY

- HM45: SilverLuma frame/frost insert (half modesty) - \$415
- MC51: Half veneer/laminate modesty - \$130

# Central park.

Conference Runoff Desks  
Rectangle Runoff Desk

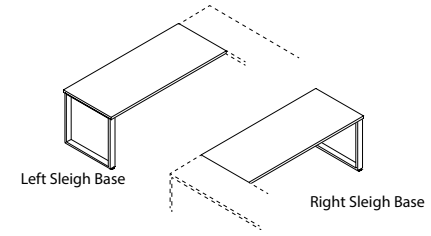

1 Select a model w" x d" x h"	weight	Standard Veneer Top		Premium Veneer Top		High Pressure Laminate Top		Thermally Fused Laminate Top				
		Standard Veneer Chassis		Premium Veneer Chassis		Veneer Chassis		Thermally Fused Laminate Chassis				
<b>Left Sleigh</b>												
72 x 30 x 29	155	CPC7230DR771W	2199	CPC7230DR771P	2419	CPC7230DR771G	2199	CPC7230DR771M	1163			
66 x 30 x 29	145	CPC6630DR771W	2125	CPC6630DR771P	2338	CPC6630DR771G	2125	CPC6630DR771M	1133			
60 x 30 x 29	135	CPC6030DR771W	2049	CPC6030DR771P	2254	CPC6030DR771G	2049	CPC6030DR771M	1103			
54 x 30 x 29	125	CPC5430DR771W	1975	CPC5430DR771P	2173	CPC5430DR771G	1975	CPC5430DR771M	1072			
<b>Right Sleigh</b>												
72 x 30 x 29	155	CPC7230DR770W	2199	CPC7230DR770P	2419	CPC7230DR770G	2199	CPC7230DR770M	1163			
66 x 30 x 29	145	CPC6630DR770W	2125	CPC6630DR770P	2338	CPC6630DR770G	2125	CPC6630DR770M	1133			
60 x 30 x 29	135	CPC6030DR770W	2049	CPC6030DR770P	2254	CPC6030DR770G	2049	CPC6030DR770M	1103			
54 x 30 x 29	125	CPC5430DR770W	1975	CPC5430DR770P	2173	CPC5430DR770G	1975	CPC5430DR770M	1072			
<b>2 Select a finish</b> <i>View finish details</i>		WAC	WGW	TBCO	WSO	GAC	GNW	MAC				
		WRC	WBW	TBSW		GIC	GSTV +10%	MEC				
		WIC	WSW	TSTV		GEC	GSLV +10%	MHC				
<b>Metal finish</b> MFS Silver. Additional metal finishes are available, see options.		WEC	WNW	TSMV		GHC	GWL	MOC				
		WHC	WWP	TSLV		GOC		MGW				
		WOC		TOBW		GAM		MTW				
		WAM		WBO		GCM		MSW				
		WCM		WMO		GWM		MWL				
		WWW		WNO		GEW						
		WEW										
<b>3 Select an edge</b> <i>View edge details</i>												
<b>4 Select hardware</b> <i>View hardware details</i>		Hardware	N/A	Hardware	N/A	Hardware	N/A	Hardware	N/A			

*View statement of line*

## Product features.

- Hookup hardware
- Metal sleigh base - standard silver finish

### NOTES

- See Bench Runoff Supports when using with Bench Credenza

## Options.

### ACCESSORIES

- K28: Articulating Keyboard w/ Mouse - \$390
- K31: Center drawer - \$205
- K31-SK: Center drawer w/ skirt - \$310

### BASE

- RDL-S: Silver round post leg - deduct \$260
- RDL-S: Silver round post leg - deduct \$260
- SQL-S: Silver square post leg - deduct \$260
- SQL-B: Black square post leg - deduct \$260

### GROMMETS (STANDARD LOCATION)

Specify Color and Left/Right/Center - \$50 ea.

- Black: TM30-R (Right), TM30-L (Left), TM30-C (Center)
- Silver: TM31-R (Right), TM31-L (Left), TM31-C (Center)
- Antique Brass: TM33-R (Right), TM33-L (Left), TM33-C (Center)

### GROMMETS (NON-STANDARD LOCATION)

Provide drawing w/ Grommet Location and Specify Color - \$95 ea.

- Black: TM30-NS
- Silver: TM31-NS
- Antique Brass: TM33-NS

### MODESTY

- HM45: SilverLuma frame/frost insert (half modesty) - \$415
- MC51: Half veneer/laminate modesty - \$130
- Premium Finish Option
- MFB: Black metal finish - \$160 per base

# Central park.

Service Workstation Desks  
Breakfront Modesty Full Pedestal

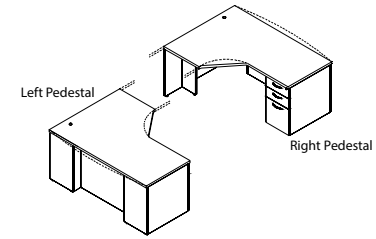

## 1 Select a model

w" x d" x h"

weight	Standard Veneer Top		Premium Veneer Top		High Pressure Laminate Top		Thermally Fused Laminate Top		
	Standard Veneer Chassis		Premium Veneer Chassis		Veneer Chassis		Thermally Fused Laminate Chassis		
<b>Left Pedestal</b>									
72 x 30/48 x 29	310	CPC7248DS754W	4056	CPC7248DS754P	4462	CPC7248DS754G	4056	CPC7248DS754M	1986
66 x 30/48 x 29	290	CPC6648DS754W	3976	CPC6648DS754P	4374	CPC6648DS754G	3976	CPC6648DS754M	1945
66 x 24/42 x 29	260	CPC6642DS754W	3589	CPC6642DS754P	3948	CPC6642DS754G	3589	CPC6642DS754M	1916
<b>Right Pedestal</b>									
72 x 30/48 x 29	310	CPC7248DS753W	4056	CPC7248DS753P	4462	CPC7248DS753G	4056	CPC7248DS753M	1986
66 x 30/48 x 29	290	CPC6648DS753W	3976	CPC6648DS753P	4374	CPC6648DS753G	3976	CPC6648DS753M	1945
66 x 24/42 x 29	260	CPC6642DS753W	3589	CPC6642DS753P	3948	CPC6642DS753G	3589	CPC6642DS753M	1916

[View statement of line](#)

## 2 Select a finish

[View finish details](#)

WAC	WGW	TBCO	WSO	GAC	GNW	MAC
WRC	WBW	TBSW		GIC	GSTV +10%	MEC
WIC	WSW	TSTV		GEC	GSLV +10%	MHC
WEC	WNW	TSMV		GHC	GWL	MOC
WHC	WWP	TSLV		GOC		MGW
WOC		TOBW		GAM		MTW
WAM		WBO		GCM		MSW
WCM		WMO		GWM		MWL
WWM		WNO		GEW		
WEW						

## 3 Select a edge

[View edge details](#)



## 4 Select hardware

[View hardware details](#)

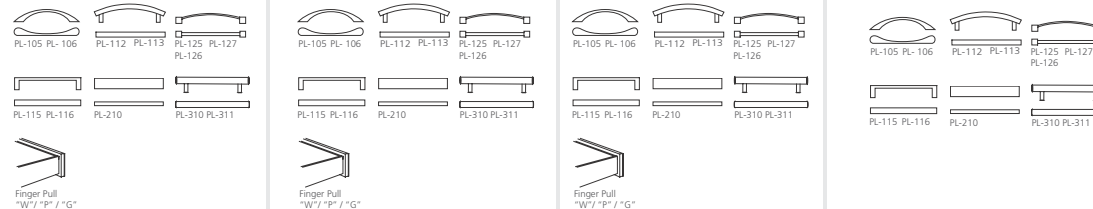

## Product features.

- 1 Standard grommet - matches pull finish or specify black TM30, silver TM31 or antique brass TM33
- Box/Box/File
- Full extension drawers - locking
- "W" & "G" SKUs feature soft close suspensions, "M" SKUs feature ball bearing suspensions. Both suspensions are full extension.

### NOTES

- All units are standard w/ flush ends
- Modesty is recessed 6"

## Options.

### ACCESSORIES

- K28: Articulating Keyboard w/ Mouse - \$390
- K31: Center drawer - \$205
- N/A with T80 or T90 options

### DRAWER

- P6: Modify Box/Box/File to File/File - \$55 per pedestal
- P33: Wood Drawer Upgrade - \$45 per drawer
- WPD3061: Designer White - \$80 per pedestal

### GROMMETS (NON-STANDARD LOCATION)

Provide drawing w/ Grommet Location and Specify Color - \$95 ea.

- Black: TM30-NS
- Silver: TM31-NS
- Antique Brass: TM33-NS

### MODESTY

- M39: SilverLuma Frame w/ Frost insert (full modesty) - \$650
- HM39: SilverLuma Frame w/ Frost insert (half modesty) - \$340

### SERVICE DESKS

- For Ledge, Classic, Cobee, Cove, Flat, Knife, Reed, and Waterfall edges, specify T80 or T81
- T80: Edge Curve User Side - n/c
- T81: Edge Approach Side Bowfront Edge - \$80
- For Bullnose, Ogee and Radius edges, Specify T90 or T91
- T90: Hardwood Edge Curve User Side - \$620
- T91: Hardwood Edge Approach Side Bowfront Edge - \$310

# Central park.

Service Workstation Desks

Flush Modesty Full Pedestal W/ Overhang Top

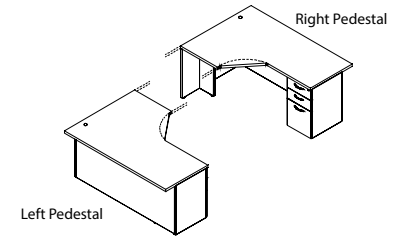

## 1 Select a model

w" x d" x h"

weight	Standard Veneer Top		Premium Veneer Top		High Pressure Laminate Top		Thermally Fused Laminate Top		
	Standard Veneer Chassis		Premium Veneer Chassis		Veneer Chassis		Thermally Fused Laminate Chassis		
<b>Left Pedestal</b>									
72 x 30/48 x 29	300	CPC7248DS760W	3936	CPC7248DS760P	4330	CPC7248DS760G	3936	CPC7248DS760M	1909
66 x 30/48 x 29	280	CPC6648DS760W	3858	CPC6648DS760P	4244	CPC6648DS760G	3858	CPC6648DS760M	1870
66 x 24/42 x 29	250	CPC6642DS760W	3487	CPC6642DS760P	3836	CPC6642DS760G	3487	CPC6642DS760M	1839
<b>Right Pedestal</b>									
72 x 30/48 x 29	300	CPC7248DS759W	3936	CPC7248DS759P	4330	CPC7248DS759G	3936	CPC7248DS759M	1909
66 x 30/48 x 29	280	CPC6648DS759W	3858	CPC6648DS759P	4244	CPC6648DS759G	3858	CPC6648DS759M	1870
66 x 24/42 x 29	250	CPC6642DS759W	3487	CPC6642DS759P	3836	CPC6642DS759G	3487	CPC6642DS759M	1839

View statement of line

## 2 Select a finish

View finish details

WAC	WGW	TBCO	WSO	GAC	GNW	MAC
WRC	WBW	TBSW		GIC	GSTV +10%	MEC
WIC	WSW	TSTV		GEC	GSLV +10%	MHC
WEC	WNW	TSMV		GHC	GWL	MOC
WHC	WWP	TSLV		GOC		MGW
WOC		TOBW		GAM		MTW
WAM		WBO		GCM		MSW
WCM		WMO		GWM		MWL
WWW		WNO		GEW		
WEW						

## 3 Select a edge

View edge details

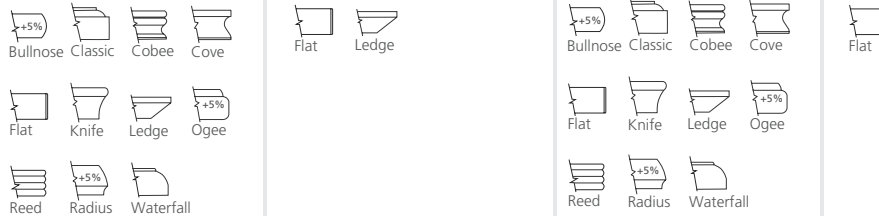

## 4 Select hardware

View hardware details

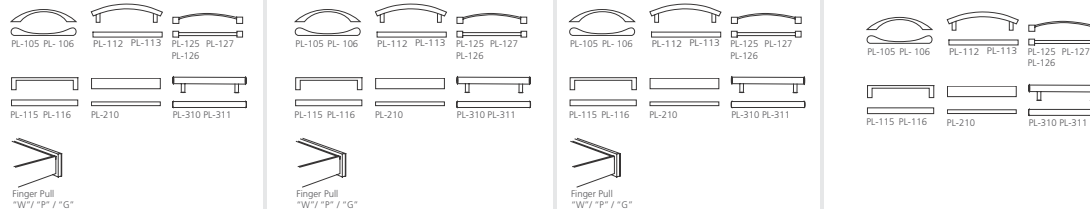

## Product features.

- 1 Standard grommet - matches pull finish or specify black TM30, silver TM31 or antique brass TM33
- Box/Box/File
- Full extension drawers - locking
- "W" & "G" SKUs feature soft close suspensions, "M" SKUs feature ball bearing suspensions. Both suspensions are full extension.

### NOTES

- 24"/42" D Have 18" Pedestal
- 30"/48" D Have 24" Pedestal
- 6" Overhang on Approach
- All units are standard w/ flush ends

## Options.

### ACCESSORIES

- K28: Articulating Keyboard w/ Mouse - \$390
- K31: Center drawer - \$205

### DRAWER

- P6: Modify Box/Box/File to File/File - \$55 per pedestal
- P33: Wood Drawer Upgrade - \$45 per drawer
- WPD3061: Designer White - \$80 per pedestal

### GROMMETS (NON-STANDARD LOCATION)

- Provide drawing w/ Grommet Location and Specify Color - \$95 ea.
- Black: TM30-NS
- Silver: TM31-NS
- Antique Brass: TM33-NS

### SERVICE DESKS

- For Ledge, Classic, Cobee, Cove, Flat, Knife, Reed, and Waterfall edges, specify T80 or T81
- T80: Edge Curve User Side - n/c
- T81: Edge Approach Side Bowfront Edge - \$80
- For Bullnose, Ogee and Radius edges, Specify T90 or T91
- T90: Hardwood Edge Curve User Side - \$620
- T91: Hardwood Edge Approach Side Bowfront Edge - \$310

# Central park.

Service Workstation Desks  
Bullet Service Desk

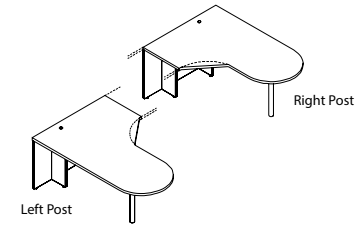

[View statement of line](#)

1 Select a model w" x d" x h"	weight	Standard Veneer Top Standard Veneer Chassis		Premium Veneer Top Premium Veneer Chassis		High Pressure Laminate Top Veneer Chassis		Thermally Fused Laminate Top Thermally Fused Laminate Chassis	
		<b>Left Post</b> 72 x 30/48 x 29 66 x 30/48 x 29 66 x 24/42 x 29	200 190 160	CPC7248DS737W CPC6648DS737W CPC6642DS737W	3365 3274 3124	CPC7248DS737P CPC6648DS737P CPC6642DS737P	3702 3601 3436	CPC7248DS737G CPC6648DS737G CPC6642DS737G	3365 3274 3124
<b>Right Post</b> 72 x 30/48 x 29 66 x 30/48 x 29 66 x 24/42 x 29	200 190 160	CPC7248DS736W CPC6648DS736W CPC6642DS736W	3365 3274 3124	CPC7248DS736P CPC6648DS736P CPC6642DS736P	3702 3601 3436	CPC7248DS736G CPC6648DS736G CPC6642DS736G	3365 3274 3124	CPC7248DS736M CPC6648DS736M CPC6642DS736M	1285 1265 1245
<b>2 Select a finish</b> <a href="#">View finish details</a>		WAC WRC WIC WEC WHC WOC WAM WCM WWM WEW	WGW WBW WSW WNW WVP	TBCO TBSW TSTV TSMV TSLV TOBW WBO WMO WNO	WSO	GAC GIC GEC GHC GOC GAM GCM GWM GEW	GNW GSTV +10% GSLV +10% GWL	MAC MEC MHC MOC MGW MTW MSW MWL	
<b>3 Select a edge</b> <a href="#">View edge details</a>		Bullnose Classic Cobee Cove Flat Knife Ledge Ogee Reed Radius Waterfall	Bullnose Classic Cobee Cove Flat Knife Ledge Ogee Reed Radius Waterfall	Flat Ledge		Bullnose Classic Cobee Cove Flat Knife Ledge Ogee Reed Radius Waterfall		Flat	
<b>4 Select hardware</b> <a href="#">View hardware details</a>		Hardware N/A		Hardware N/A		Hardware N/A		Hardware N/A	

## Product features.

- 1 Standard grommet - matches pull finish or specify black TM30, silver TM31 or antique brass TM33
- 3" Silver anodized aluminum post leg standard (Optional black leg - n/c)

### NOTES

- All units are standard w/ flush ends
- See Options Sections For Additional Support Legs Available.

## Options.

### ACCESSORIES

- K28: Articulating Keyboard w/ Mouse - \$390
- K31: Center drawer - \$205
- K31-SK: Center drawer w/ skirt - \$310
- N/A with T80 or T90 options

### GROMMETS (NON-STANDARD LOCATION)

Provide drawing w/ Grommet Location and Specify Color - \$95 ea.

- Black: TM30-NS
- Silver: TM31-NS
- Antique Brass: TM33-NS

### MODESTY

- M45: SilverLuma frame/frost insert (Full Modesty) - \$755
- HM45: SilverLuma frame/frost insert (half modesty) - \$415
- MC50: Full veneer/Laminate modesty - \$185
- MC51: Half veneer/laminate modesty - \$130

### SERVICE DESKS

- For Ledge, Classic, Cobee, Cove, Flat, Knife, Reed, and Waterfall edges, specify T80 or T81
- T80: Edge Curve User Side - n/c
- T81: Edge Approach Side Bowfront Edge - \$80
- For Bullnose, Ogee and Radius edges, Specify T90 or T91
- T90: Hardwood Edge Curve User Side - \$620
- T91: Hardwood Edge Approach Side Bowfront Edge - \$310



# Central park.

Workstation Runoff Desks Single Full Pedestal  
Breakfront Runoff

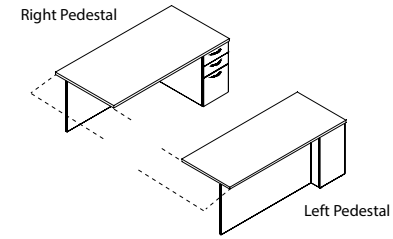

## 1 Select a model

w" x d" x h"

weight	Standard Veneer Top		Premium Veneer Top		High Pressure Laminate Top		Thermally Fused Laminate Top		
	Standard Veneer Chassis		Premium Veneer Chassis		Veneer Chassis		Thermally Fused Laminate Chassis		
<b>Left Pedestal</b>									
84 x 36 x 29	260	CPC8436DR019W	3503	CPC8436DR019P	3853	CPC8436DR019G	3503	CPC8436DR019M	1818
78 x 36 x 29	245	CPC7836DR019W	3202	CPC7836DR019P	3522	CPC7836DR019G	3202	CPC7836DR019M	1803
72 x 36 x 29	250	CPC7236DR019W	2979	CPC7236DR019P	3277	CPC7236DR019G	2979	CPC7236DR019M	1788
72 x 30 x 29	230	CPC7230DR019W	2901	CPC7230DR019P	3191	CPC7230DR019G	2901	CPC7230DR019M	1585
66 x 30 x 29	210	CPC6630DR019W	2779	CPC6630DR019P	3057	CPC6630DR019G	2779	CPC6630DR019M	1559
60 x 30 x 29	200	CPC6030DR019W	2692	CPC6030DR019P	2961	CPC6030DR019G	2692	CPC6030DR019M	1534
54 x 30 x 29	180	CPC5430DR019W	2612	CPC5430DR019P	2873	CPC5430DR019G	2612	CPC5430DR019M	1509
<b>Right Pedestal</b>									
84 x 36 x 29	260	CPC8436DR020W	3503	CPC8436DR020P	3853	CPC8436DR020G	3503	CPC8436DR020M	1818
78 x 36 x 29	245	CPC7836DR020W	3202	CPC7836DR020P	3522	CPC7836DR020G	3202	CPC7836DR020M	1803
72 x 36 x 29	250	CPC7236DR020W	2979	CPC7236DR020P	3277	CPC7236DR020G	2979	CPC7236DR020M	1788
72 x 30 x 29	230	CPC7230DR020W	2901	CPC7230DR020P	3191	CPC7230DR020G	2901	CPC7230DR020M	1585
66 x 30 x 29	210	CPC6630DR020W	2779	CPC6630DR020P	3057	CPC6630DR020G	2779	CPC6630DR020M	1559
60 x 30 x 29	200	CPC6030DR020W	2692	CPC6030DR020P	2961	CPC6030DR020G	2692	CPC6030DR020M	1534
54 x 30 x 29	180	CPC5430DR020W	2612	CPC5430DR020P	2873	CPC5430DR020G	2612	CPC5430DR020M	1509

View statement of line

## 2 Select a finish

View finish details

WAC	WGW	TBCO	WSO	GAC	GNW	MAC
WRC	WBW	TBSW		GIC	GSTV +10%	MEC
WIC	WSW	TSTV		GEC	GSLV +10%	MHC
WEC	WNW	TSMV		GHC	GWL	MOC
WHC	WWP	TSLV		GOC		MGW
WOC		TOBW		GAM		MTW
WAM		WBO		GCM		MSW
WCM		WMO		GWM		MWL
WWW		WNO		GEW		
WEW						

## 3 Select a edge

View edge details



## 4 Select hardware

View hardware details

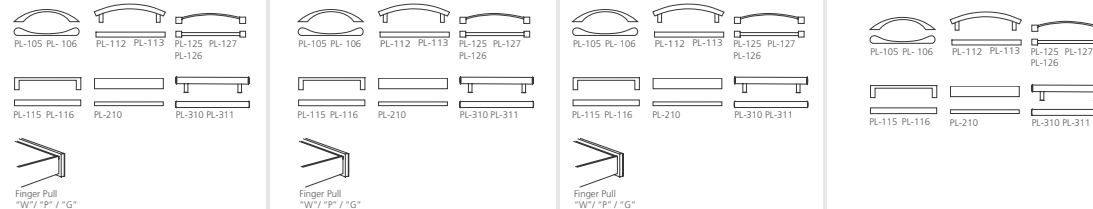

## Product features.

- Box/Box/File
- Full fixed modesty w/ "L" support end
- Full extension drawers - locking
- Hookup hardware
- "W" & "G" SKUs feature soft close suspensions, "M" SKUs feature ball bearing suspensions. Both suspensions are full extension.

### NOTES

- 6" Recessed Modesty
- All units are standard w/ flush ends
- Hooks to credenzas
- See Bench Runoff Supports when using with Bench Credenza

## Options.

### ACCESSORIES

- K28: Articulating Keyboard w/ Mouse - \$390
- K31: Center drawer - \$205

### DRAWER

- P6: Modify Box/Box/File to File/File - \$55 per pedestal
- P33: Wood Drawer Upgrade - \$45 per drawer
- WPD3061: Designer White - \$80 per pedestal

### GROMMETS (STANDARD LOCATION)

- Specify Color and Left/Right - \$50 ea.
- Black: TM30-R (Right), TM30-L (Left)
  - Silver: TM31-R (Right), TM31-L (Left)
  - Antique Brass: TM33-R (Right), TM33-L (Left)

### GROMMETS (NON-STANDARD LOCATION)

- Provide drawing w/ Grommet Location and Specify Color - \$95 ea.
- Black: TM30-NS
  - Silver: TM31-NS
  - Antique Brass: TM33-NS

### MODESTY

- DM55: Delete Modesty Panel - Deduct \$75

# Central park.

Height Adjustable Workstation Runoff Desks  
Height Adjustable Runoff Desk

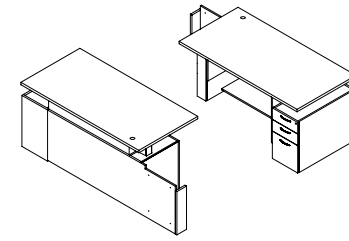

## 1 Select a model w" x d" x h"

weight	Standard Veneer Top Standard Veneer Chassis		Premium Veneer Top Premium Veneer Chassis		High Pressure Laminate Top Veneer Chassis		Thermally Fused Laminate Top Thermally Fused Laminate Chassis	
<b>Left Pedestal</b>								
72 x 36 x 29-47.5	275	CPC7236DR710W 6397	CPC7236DR710P 7037	CPC7236DR710G 6397	CPC7236DR710M 5179			
72 x 30 x 29-47.5	255	CPC7230DR710W 6171	CPC7230DR710P 6788	CPC7230DR710G 6171	CPC7230DR710M 4839			
66 x 36 x 29-47.5	255	CPC6636DR710W 6268	CPC6636DR710P 6895	CPC6636DR710G 6268	CPC6636DR710M 5082			
66 x 30 x 29-47.5	235	CPC6630DR710W 5990	CPC6630DR710P 6589	CPC6630DR710G 5990	CPC6630DR710M 4733			
<b>Right Pedestal</b>								
72 x 36 x 29-47.5	275	CPC7236DR709W 6397	CPC7236DR709P 7037	CPC7236DR709G 6397	CPC7236DR709M 5179			
72 x 30 x 29-47.5	255	CPC7230DR709W 6171	CPC7230DR709P 6788	CPC7230DR709G 6171	CPC7230DR709M 4839			
66 x 36 x 29-47.5	255	CPC6636DR709W 6268	CPC6636DR709P 6895	CPC6636DR709G 6268	CPC6636DR709M 5082			
66 x 30 x 29-47.5	235	CPC6630DR709W 5990	CPC6630DR709P 6589	CPC6630DR709G 5990	CPC6630DR709M 4733			

View statement of line

## 2 Select a finish View finish details

WAC	WGW	TBCO	WSO	GAC	GNW	MAC
WRC	WBW	TBSW		GIC	GSTV +10%	MEC
WIC	WSW	TSTV		GEC	GSLV +10%	MHC
WEC	WNW	TSMV		GHC	GWL	MOC
WHC	WWP	TSLV		GOC		MGW
WOC		TOBW		GAM		MTW
WAM		WBO		GCM		MSW
WCM		WMO		GWM		MWL
WWW		WNO		GEW		
WEW						

## 3 Select a edge View edge details

+5%						+5%					
Bullnose	Classic	Cobee	Cove	Flat	Ledge	Bullnose	Classic	Cobee	Cove	Flat	
			+5%				+5%				
Flat	Knife	Ledge	Ogee	Flat	Knife	Ledge	Ogee	Flat	Knife	Ledge	Ogee
	+5%				+5%				+5%		
Reed	Radius	Waterfall		Reed	Radius	Waterfall		Reed	Radius	Waterfall	

## 4 Select hardware View hardware details

PL-105 PL-106	PL-112 PL-113 PL-126	PL-125 PL-127 PL-126	PL-105 PL-106	PL-112 PL-113 PL-126	PL-125 PL-127 PL-126	PL-105 PL-106	PL-112 PL-113 PL-126	PL-125 PL-127 PL-126	PL-105 PL-106	PL-112 PL-113 PL-126	PL-125 PL-127 PL-126
PL-115 PL-116 PL-210 PL-310 PL-311	PL-115 PL-116 PL-210 PL-310 PL-311	PL-115 PL-116 PL-210 PL-310 PL-311	PL-115 PL-116 PL-210 PL-310 PL-311	PL-115 PL-116 PL-210 PL-310 PL-311	PL-115 PL-116 PL-210 PL-310 PL-311	PL-115 PL-116 PL-210 PL-310 PL-311	PL-115 PL-116 PL-210 PL-310 PL-311	PL-115 PL-116 PL-210 PL-310 PL-311	PL-115 PL-116 PL-210 PL-310 PL-311	PL-115 PL-116 PL-210 PL-310 PL-311	PL-115 PL-116 PL-210 PL-310 PL-311
Finger Pull "W"/"P"/"G"	Finger Pull "W"/"P"/"G"	Finger Pull "W"/"P"/"G"	Finger Pull "W"/"P"/"G"	Finger Pull "W"/"P"/"G"	Finger Pull "W"/"P"/"G"	Finger Pull "W"/"P"/"G"	Finger Pull "W"/"P"/"G"	Finger Pull "W"/"P"/"G"	Finger Pull "W"/"P"/"G"	Finger Pull "W"/"P"/"G"	Finger Pull "W"/"P"/"G"

## Product features.

- 1 Standard grommet - matches pull finish or specify black TM30, silver TM31 or antique brass TM33
- Adjustable height from 29" to 47.5" with a maximum weight capacity of 350 lbs.
- Box/Box/File
- Fully assembled
- Full fixed modesty
- Hookup hardware
- Lift available in MFS Silver (standard) or MFB Black (optional)
- Metal parts include 5 year warranty
- Programmable height adjustable mechanism, motor includes 2 year warranty

### NOTES

- Modesty surround lifts w/ work surface
- Extended section slides under credenza

## Options.

### ACCESSORIES

- K31: Center drawer - \$205

### DRAWER

- P6: Modify Box/Box/File to File/File - \$55 per pedestal
- P33: Wood Drawer Upgrade - \$45 per drawer
- WPD3061: Designer White - \$80 per pedestal fronts

### GROMMETS (STANDARD LOCATION)

- Specify Color - \$50 ea.
- Black: TM30-C (Center)
- Silver: TM31-C (Center)
- Antique Brass: TM33-C (Center)

### GROMMETS (NON-STANDARD LOCATION)

- Provide drawing w/ Grommet Location and Specify Color - \$95 ea.
- Black: TM30-NS
- Silver: TM31-NS
- Antique Brass: TM33-NS

### WIRE MANAGEMENT

- LWMB: Lift wire management box with flip down door - \$365
- Power strip with five outlets and 12' cord, mesh wire cover, 6" deep black box

# Central park.

Height Adjustable Runoff Desk  
Workstation with Adjustable Column Box

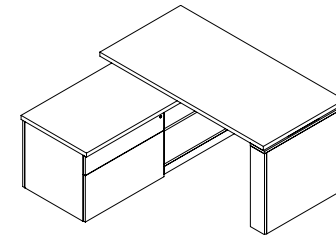

## 1 Select a model w" x d" x h"

weight	Standard Veneer Top Standard Veneer Chassis		Premium Veneer Top Premium Veneer Chassis		High Pressure Laminate Top Veneer Chassis		Thermally Fused Laminate Top Thermally Fused Laminate Chassis	
	<b>Left Pedestal</b>							
72 x 30 x 29-47.5	210	CPC7230DR034W 4315	CPC7230DR034P 4747	CPC7230DR034G 4315	CPC7230DR034M 3545			
66 x 30 x 29-47.5	190	CPC6630DR034W 4280	CPC6630DR034P 4708	CPC6630DR034G 4280	CPC6630DR034M 3520			
60 x 30 x 29-47.5	170	CPC6030DR034W 4245	CPC6030DR034P 4670	CPC6030DR034G 4245	CPC6030DR034M 3495			
54 x 30 x 29-47.5	150	CPC5430DR034W 4210	CPC5430DR034P 4631	CPC5430DR034G 4210	CPC5430DR034M 3470			
<b>Right Pedestal</b>								
72 x 30 x 29-47.5	210	CPC7230DR035W 4315	CPC7230DR035P 4747	CPC7230DR035G 4315	CPC7230DR035M 3545			
66 x 30 x 29-47.5	190	CPC6630DR035W 4280	CPC6630DR035P 4708	CPC6630DR035G 4280	CPC6630DR035M 3520			
60 x 30 x 29-47.5	170	CPC6030DR035W 4245	CPC6030DR035P 4670	CPC6030DR035G 4245	CPC6030DR035M 3495			
54 x 30 x 29-47.5	150	CPC5430DR035W 4210	CPC5430DR035P 4631	CPC5430DR035G 4210	CPC5430DR035M 3470			

View statement of line

## 2 Select a finish View finish details

WAC	WGW	TBCO	WSO	GAC	GNW	MAC
WRC	WBW	TBSW		GIC	GSTV +10%	MEC
WIC	WSW	TSTV		GEC	GSLV +10%	MHC
WEC	WNW	TSMV		GHC	GWL	MOC
WHC	WWP	TSLV		GOC		MGW
WOC		TOBW		GAM		MTW
WAM		WBO		GCM		MSW
WCM		WMO		GWM		MWL
WWW		WNO		GEW		
WEW						

## 3 Select a edge View edge details



## 4 Select hardware View hardware details

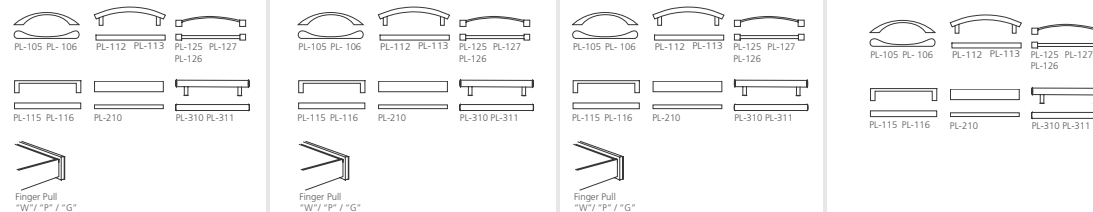

## Product features.

- Adjustable height from 29" to 47.5" with a maximum weight capacity of 350 lbs.
- Programmable height adjustable mechanism, motor includes 2 year warranty
- Standard 20" high suspended privacy panel
- Metal column with grommet for wire management

### NOTES

- Unit only used with 90 degrees bench credenza

## Options.

### ACCESSORIES

- K31: Center drawer - \$205

### GROMMETS (STANDARD LOCATION)

Specify Color - \$50 ea.

- Black: TM30-C (Center)
- Silver: TM31-C (Center)
- Antique Brass: TM33-C (Center)

### GROMMETS (NON-STANDARD LOCATION)

Provide drawing w/ Grommet Location and Specify Color - \$95 ea.

- Black: TM30-NS
- Silver: TM31-NS
- Antique Brass: TM33-NS

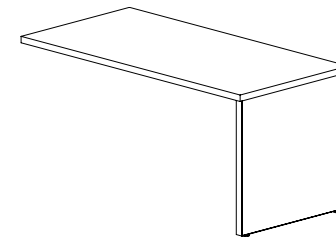

# Central park.

Runoff Desk  
Shell Unit

1 Select a model  
w" x d" x h"

weight	Standard Veneer Top Standard Veneer Chassis		Premium Veneer Top Premium Veneer Chassis		High Pressure Laminate Top Veneer Chassis		Thermally Fused Laminate Top Thermally Fused Laminate Chassis	
<b>Left Pedestal</b>								
72 x 30 x 29	155	CPC7230DR021W 2260	CPC7230DR021P 2486	CPC7230DR021G 2260	CPC7230DR021M 1340			
66 x 30 x 29	145	CPC6030DR021W 2225	CPC6030DR021P 2448	CPC6030DR021G 2225	CPC6030DR021M 1320			
60 x 30 x 29	135	CPC6030DR021W 2190	CPC6030DR021P 2409	CPC6030DR021G 2190	CPC6030DR021M 1300			
54 x 30 x 29	125	CPC5430DR021W 2155	CPC5430DR021P 2371	CPC5430DR021G 2155	CPC5430DR021M 1280			
<b>Right Pedestal</b>								
72 x 30 x 29	155	CPC7230DR022W 2260	CPC7230DR022P 2486	CPC7230DR022G 2260	CPC7230DR022M 1340			
66 x 30 x 29	145	CPC6630DR022W 2225	CPC6630DR022P 2448	CPC6630DR022G 2225	CPC6630DR022M 1320			
60 x 30 x 29	135	CPC6030DR022W 2190	CPC6030DR022P 2409	CPC6030DR022G 2190	CPC6030DR022M 1300			
54 x 30 x 29	125	CPC5430DR022W 2155	CPC5430DR022P 2371	CPC5430DR022G 2155	CPC5430DR022M 1280			

View statement of line

2 Select a finish  
View finish details

WAC WGW  
WRC WBW  
WIC WSW  
WEC WNW  
WHC WWP  
WOC  
WAM  
WCM  
WWM  
WEW

TBCO WSO  
TBSW  
TSTV  
TSMV  
TSLV  
TOBW  
WBO  
WMO  
WNO

GAC GNW  
GIC GSTV +10%  
GEC GSLV +10%  
GHC GWL  
GOC  
GAM  
GCM  
GWM  
GEW

MAC  
MEC  
MHC  
MOC  
MGW  
MTW  
MSW  
MWL

3 Select a edge  
View edge details

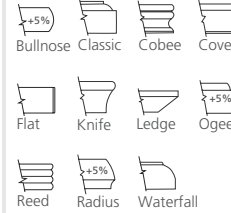
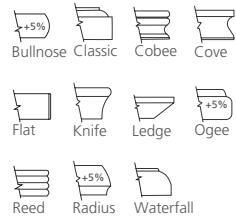

4 Select hardware  
View hardware details

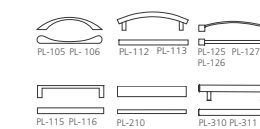
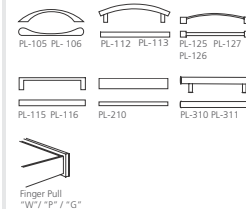
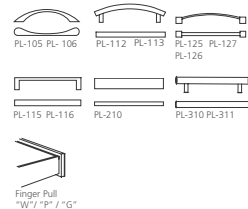
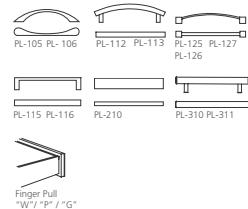

## Product features.

- No visible hardware

### NOTES

- Unit only for credenzas and bench credenzas
- See bench runoff supports when using bench credenzas

## Options.

### ACCESSORIES

- K31: Center drawer - \$205

### GROMMETS (STANDARD LOCATION)

- Specify Color - \$50 ea.
- Black: TM30-C (Center)
- Silver: TM31-C (Center)
- Antique Brass: TM33-C (Center)

### GROMMETS (NON-STANDARD LOCATION)

Provide drawing w/ Grommet Location and Specify Color - \$95 ea.

- Black: TM30-NS
- Silver: TM31-NS
- Antique Brass: TM33-NS

### MODESTY

- HM45L: Silverluma half modesty - \$515
- M45L: Silverluma full modesty - \$830
- ML51: Half Veneer/Laminate Modesty - \$185
- ML50: Full Veneer/Laminate Modesty - \$195

# Central park.

Workstation Shells - Used Next to Single Pedestal or Shell Lift Desk  
Open Back

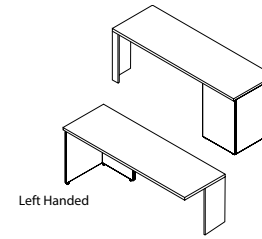

1 Select a model w" x d" x h"	weight	Standard Veneer Top		Premium Veneer Top		High Pressure Laminate Top		Thermally Fused Laminate Top				
		Standard Veneer Chassis		Premium Veneer Chassis		Veneer Chassis		Thermally Fused Laminate Chassis				
<b>Left Handed Return Shell</b>												
72 x 24 x 29	110	CPC7224RE691W	1855	CPC7224RE691P	2041	CPC7224RE691G	1855	CPC7224RE691M	973			
66 x 24 x 29	100	CPC6624RE691W	1778	CPC6624RE691P	1956	CPC6624RE691G	1778	CPC6624RE691M	953			
60 x 24 x 29	95	CPC6024RE691W	1699	CPC6024RE691P	1869	CPC6024RE691G	1699	CPC6024RE691M	882			
54 x 24 x 29	90	CPC5424RE691W	1618	CPC5424RE691P	1780	CPC5424RE691G	1618	CPC5424RE691M	866			
48 x 24 x 29	85	CPC4824RE691W	1533	CPC4824RE691P	1686	CPC4824RE691G	1533	CPC4824RE691M	851			
<b>Right Handed Return Shell</b>												
72 x 24 x 29	110	CPC7224RE693W	1855	CPC7224RE693P	2041	CPC7224RE693G	1855	CPC7224RE693M	973			
66 x 24 x 29	100	CPC6624RE693W	1778	CPC6624RE693P	1956	CPC6624RE693G	1778	CPC6624RE693M	953			
60 x 24 x 29	95	CPC6024RE693W	1699	CPC6024RE693P	1869	CPC6024RE693G	1699	CPC6024RE693M	882			
54 x 24 x 29	90	CPC5424RE693W	1618	CPC5424RE693P	1780	CPC5424RE693G	1618	CPC5424RE693M	866			
48 x 24 x 29	85	CPC4824RE693W	1533	CPC4824RE693P	1686	CPC4824RE693G	1533	CPC4824RE693M	851			
<b>2 Select a finish</b> <i>View finish details</i>												
		WAC	WGW	TBCO	WSO	GAC	GNW	MAC				
		WRC	WBW	TBSW		GIC	GSTV +10%	MEC				
		WIC	WSW	TSTV		GEC	GSLV +10%	MHC				
		WEC	WNW	TSMV		GHC	GWL	MOC				
		WHC	WWP	TSLV		GOC		MGW				
		WOC		TOBW		GAM		MTW				
		WAM		WBO		GCM		MSW				
		WCM		WMO		GWM		MWL				
		WWW		WNO		GEW						
		WEW										
<b>3 Select a edge</b> <i>View edge details</i>												
		Bullnose	Classic	Cobee	Cove	Flat	Ledge	Bullnose	Classic	Cobee	Cove	Flat
		Flat	Knife	Ledge	Ogee			Flat	Knife	Ledge	Ogee	
		Reed	Radius	Waterfall				Reed	Radius	Waterfall		
<b>4 Select hardware</b> <i>View hardware details</i>												
		Hardware	N/A	Hardware	N/A	Hardware	N/A	Hardware	N/A			

[View statement of line](#)

## Product features.

- 4"H back rail - open back

### NOTES

- All units are standard w/ flush ends
- Grain Direction Runs Front To Back On All "W" Units and Up to 60" on "G" and "M" Units
- Grain Runs End To End On 66"/72" Sizes on "G" and "M" styles
- If grommet is added then unit will become handed
- Unit ships assembled

## Options.

### ACCESSORIES

- K28: Articulating Keyboard w/ Mouse - \$390
- K31: Center drawer - \$205

### GROMMETS (STANDARD LOCATION)

Specify Color and Left/Right - \$50 ea.

- Black: TM30-R (Right), TM30-L (Left)
- Silver: TM31-R (Right), TM31-L (Left)
- Antique Brass: TM33-R (Right), TM33-L (Left)

### GROMMETS (NON-STANDARD LOCATION)

Provide drawing w/ Grommet Location and Specify Color - \$95 ea.

- Black: TM30-NS
- Silver: TM31-NS
- Antique Brass: TM33-NS

### MODESTY

- M34T-O: "W" "G" Style Drop Door Tech Modesty - \$310
- M34TM-O: "M" Style Drop Door Tech Modesty - \$235
- M37: "W" "G" Style Fixed Full Modesty - \$130
- M37M: "M" Style Fixed Full Modesty - \$80

# Central park.

"L" Workstation Returns  
 "L" Workstation Return - File/File

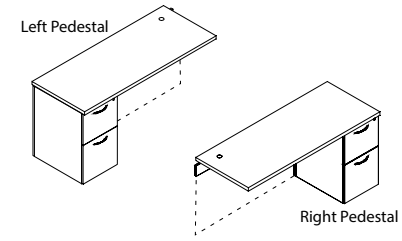

## 1 Select a model

w" x d" x h"

weight	Standard Veneer Top		Premium Veneer Top		High Pressure Laminate Top		Thermally Fused Laminate Top		
	Standard Veneer Chassis		Premium Veneer Chassis		Veneer Chassis		Thermally Fused Laminate Chassis		
<b>Left Pedestal</b>									
60 x 24 x 29	130	CPC6024RE222W	2246	CPC6024RE222P	2471	CPC6024RE222G	2246	CPC6024RE222M	1215
48 x 24 x 29	125	CPC4824RE222W	2125	CPC4824RE222P	2338	CPC4824RE222G	2125	CPC4824RE222M	1194
42 x 24 x 29	120	CPC4224RE222W	2068	CPC4224RE222P	2275	CPC4224RE222G	2068	CPC4224RE222M	1178
<b>Right Pedestal</b>									
60 x 24 x 29	130	CPC6024RE223W	2246	CPC6024RE223P	2471	CPC6024RE223G	2246	CPC6024RE223M	1215
48 x 24 x 29	125	CPC4824RE223W	2125	CPC4824RE223P	2338	CPC4824RE223G	2125	CPC4824RE223M	1194
42 x 24 x 29	120	CPC4224RE223W	2068	CPC4224RE223P	2275	CPC4224RE223G	2068	CPC4224RE223M	1178

[View statement of line](#)

## 2 Select a finish

[View finish details](#)

WAC	WGW	TBCO	WSO	GAC	GNW	MAC
WRC	WBW	TBSW		GIC	GSTV +10%	MEC
WIC	WSW	TSTV		GEC	GSLV +10%	MHC
WEC	WNW	TSMV		GHC	GWL	MOC
WHC	WWP	TSLV		GOC		MGW
WOC		TOBW		GAM		MTW
WAM		WBO		GCM		MSW
WCM		WMO		GWM		MWL
WWW		WNO		GEW		
WEW						

## 3 Select a edge

[View edge details](#)



## 4 Select hardware

[View hardware details](#)

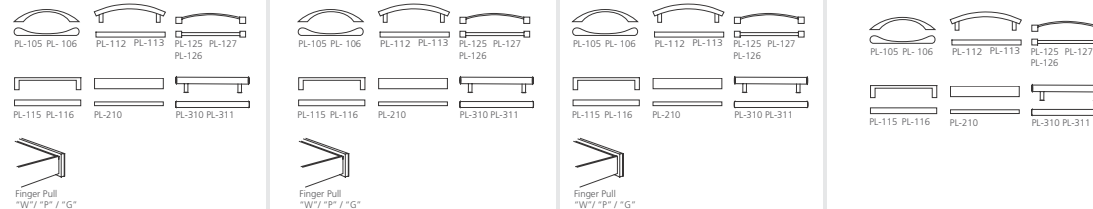

## Product features.

- 1 Standard grommet - matches pull finish or specify black TM30, silver TM31 or antique brass TM33
- 4"H back rail - open back
- Full extension drawers - locking
- "W" & "G" SKUs feature soft close suspensions, "M" SKUs feature ball bearing suspensions. Both suspensions are full extension.

### NOTES

- All units are standard w/ flush ends
- Grain Direction Runs Front To Back On All "W" Units and Up to 60" on "G" and "M" Units

## Options.

### ACCESSORIES

- K28: Articulating Keyboard w/ Mouse - \$390

### DRAWER

- P6: Modify File/File to Box/Box/File - \$55 per pedestal
- P33: Wood Drawer Upgrade - \$45 per drawer
- P40W: extra Box/Box/File or File/File to Kneespace - \$910 (W,G)
- P40M: extra Box/Box/File or File/File to Kneespace - \$720 (M)
- WPD3061: Designer White - \$80 per pedestal

### GROMMETS (NON-STANDARD LOCATION)

- Provide drawing w/ Grommet Location and Specify Color - \$95 ea.
- Black: TM30-NS
- Silver: TM31-NS
- Antique Brass: TM33-NS

### MODESTY

- M34T-O: "W" "G" Style Drop Door Tech Modesty - \$310
- M34TM-O: "M" Style Drop Door Tech Modesty - \$235
- M37: "W" "G" Style Fixed Full Modesty - \$130
- M37M: "M" Style Fixed Full Modesty - \$80

# Central park.

"L" Workstation Returns

"L" Workstation Return - Lateral File

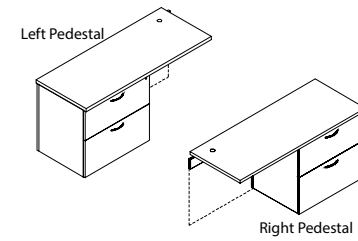

## 1 Select a model w" x d" x h"

weight	Standard Veneer Top Standard Veneer Chassis		Premium Veneer Top Premium Veneer Chassis		High Pressure Laminate Top Veneer Chassis		Thermally Fused Laminate Top Thermally Fused Laminate Chassis	
	<b>Left Pedestal</b>							
72 x 24 x 29	200	CPC7224RE206W 2929	CPC7224RE206P 3222	CPC7224RE206G 2929	CPC7224RE206M 1418			
66 x 24 x 29	190	CPC6624RE206W 2786	CPC6624RE206P 3065	CPC6624RE206G 2786	CPC6624RE206M 1387			
60 x 24 x 29	175	CPC6024RE206W 2656	CPC6024RE206P 2922	CPC6024RE206G 2656	CPC6024RE206M 1320			
48 x 24 x 29	165	CPC4824RE206W 2520	CPC4824RE206P 2772	CPC4824RE206G 2520	CPC4824RE206M 1291			
<b>Right Pedestal</b>								
72 x 24 x 29	200	CPC7224RE208W 2929	CPC7224RE208P 3222	CPC7224RE208G 2929	CPC7224RE208M 1418			
66 x 24 x 29	190	CPC6624RE208W 2786	CPC6624RE208P 3065	CPC6624RE208G 2786	CPC6624RE208M 1387			
60 x 24 x 29	175	CPC6024RE208W 2656	CPC6024RE208P 2922	CPC6024RE208G 2656	CPC6024RE208M 1320			
48 x 24 x 29	165	CPC4824RE208W 2520	CPC4824RE208P 2772	CPC4824RE208G 2520	CPC4824RE208M 1291			

View statement of line

## 2 Select a finish View finish details

WAC	WGW	TBCO	WSO	GAC	GNW	MAC
WRC	WBW	TBSW		GIC	GSTV +10%	MEC
WIC	WSW	TSTV		GEC	GSLV +10%	MHC
WEC	WNW	TSMV		GHC	GWL	MOC
WHC	WWP	TSLV		GOC		MGW
WOC		TOBW		GAM		MTW
WAM		WBO		GCM		MSW
WCM		WMO		GWM		MWL
WWM		WNO		GEW		
WEW						

## 3 Select a edge View edge details



## 4 Select hardware View hardware details

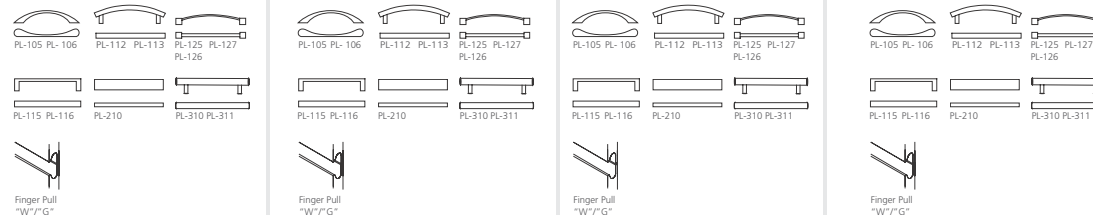

## Product features.

- 1 Standard grommet - matches pull finish or specify black TM30, silver TM31 or antique brass TM33
- 4" H back rail - open back
- Full extension drawers - locking
- Legal/Double letter filing
- "W" & "G" SKUs feature soft close suspensions, "M" SKUs feature ball bearing suspensions. Both suspensions are full extension.

### NOTES

- All units are standard w/ flush ends
- Grain Direction Runs Front To Back On All "W" Units and Up to 60" on "G" and "M" Units
- Grain Runs End To End On 66"/72" Sizes on "G" and "M" styles
- Keyboard N/A on 48" return

## Options.

### ACCESSORIES

- K28: Articulating Keyboard w/ Mouse - \$390

### DRAWER

- P33: Wood Drawer Upgrade - \$45 per drawer
- P40W: extra Box/Box/File or File/File to Kneespace - \$910 (N/A on 48") (W,G)
- P40M: extra Box/Box/File or File/File to Kneespace - \$720 (N/A on 48") (M)
- WPD3061: Designer White - \$160 per lateral pedestal

### GROMMETS (NON-STANDARD LOCATION)

- Provide drawing w/ Grommet Location and Specify Color - \$95 ea.
- Black: TM30-NS
- Silver: TM31-NS
- Antique Brass: TM33-NS

### MODESTY

- M34T-O: "W" "G" Style Drop Door Tech Modesty - \$310
- M34TM-O: "M" Style Drop Door Tech Modesty - \$235
- M37: "W" "G" Style Fixed Full Modesty - \$130
- M37M: "M" Style Fixed Full Modesty - \$80

# Central park.

"L" Workstation Returns  
 "L" Workstation Return - Multi-File

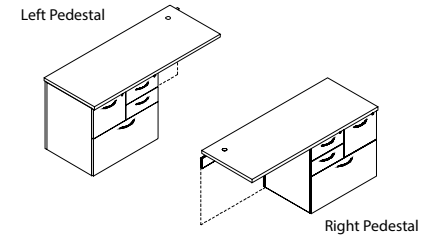

## 1 Select a model w" x d" x h"

weight	Standard Veneer Top Standard Veneer Chassis		Premium Veneer Top Premium Veneer Chassis		High Pressure Laminate Top Veneer Chassis		Thermally Fused Laminate Top Thermally Fused Laminate Chassis		
<b>Left Pedestal</b>									
72 x 24 x 29	200	CPC7224RE197W	3100	CPC7224RE197P	3410	CPC7224RE197G	3100	CPC7224RE197M	1493
66 x 24 x 29	190	CPC6624RE197W	2965	CPC6624RE197P	3262	CPC6624RE197G	2965	CPC6624RE197M	1463
60 x 24 x 29	175	CPC6024RE197W	2835	CPC6024RE197P	3119	CPC6024RE197G	2835	CPC6024RE197M	1418
48 x 24 x 29	165	CPC4824RE197W	2692	CPC4824RE197P	2961	CPC4824RE197G	2692	CPC4824RE197M	1367
<b>Right Pedestal</b>									
72 x 24 x 29	200	CPC7224RE198W	3100	CPC7224RE198P	3410	CPC7224RE198G	3100	CPC7224RE198M	1493
66 x 24 x 29	190	CPC6624RE198W	2965	CPC6624RE198P	3262	CPC6624RE198G	2965	CPC6624RE198M	1463
60 x 24 x 29	175	CPC6024RE198W	2835	CPC6024RE198P	3119	CPC6024RE198G	2835	CPC6024RE198M	1418
48 x 24 x 29	165	CPC4824RE198W	2692	CPC4824RE198P	2961	CPC4824RE198G	2692	CPC4824RE198M	1367

View statement of line

## 2 Select a finish View finish details

WAC	WGW	TBCO	WSO	GAC	GNW	MAC
WRC	WBW	TBSW		GIC	GSTV +10%	MEC
WIC	WSW	TSTV		GEC	GSLV +10%	MHC
WEC	WNW	TSMV		GHC	GWL	MOC
WHC	WWP	TSLV		GOC		MGW
WOC		TOBW		GAM		MTW
WAM		WBO		GCM		MSW
WCM		WMO		GWM		MWL
WWW		WNO		GEW		
WEW						

## 3 Select a edge View edge details



## 4 Select hardware View hardware details

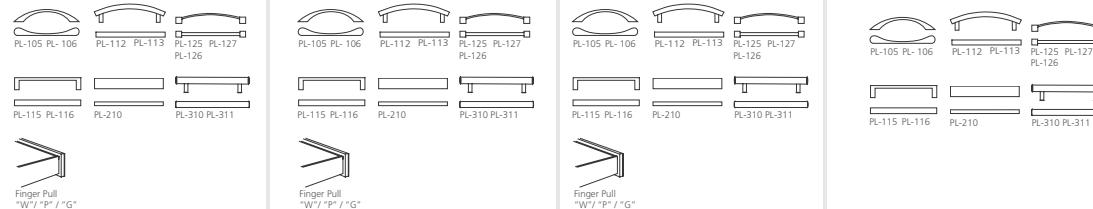

## Product features.

- 1 Standard grommet - matches pull finish or specify black TM30, silver TM31 or antique brass TM33
- 4"H back rail - open back
- Full extension drawers - locking
- Legal/Double letter filing
- "W" & "G" SKUs feature soft close suspensions, "M" SKUs feature ball bearing suspensions. Both suspensions are full extension.

### NOTES

- All units are standard w/ flush ends
- Grain Direction Runs Front To Back On All "W" Units and Up to 60" on "G" and "M" Units
- Grain Runs End To End On 66"/72" Sizes on "G" and "M" styles
- Keyboard N/A on 48" return

## Options.

### ACCESSORIES

- K28: Articulating Keyboard w/ Mouse - \$390

### DRAWER

- P33: Wood Drawer Upgrade - \$45 per drawer
- P40W: extra Box/Box/File or File/File to Kneespace - \$910 (N/A on 48")
- P40M: extra Box/Box/File or File/File to Kneespace - \$720 (N/A on 48")
- WPD3061: Designer White - \$80 per pedestal

### GROMMETS (NON-STANDARD LOCATION)

- Provide drawing w/ Grommet Location and Specify Color - \$95 ea.
- Black: TM30-NS
- Silver: TM31-NS
- Antique Brass: TM33-NS

### MODESTY

- M34T-O: "W" "G" Style Drop Door Tech Modesty - \$310
- M34TM-O: "M" Style Drop Door Tech Modesty - \$235
- M37: "W" "G" Style Fixed Full Modesty - \$130
- M37M: "M" Style Fixed Full Modesty - \$80



# Central park.

"L" Workstation Returns

"L" Workstation Return - File/File

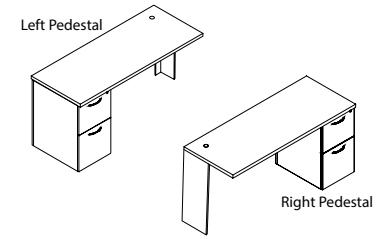

## 1 Select a model

w" x d" x h"

weight	Standard Veneer Top Standard Veneer Chassis		Premium Veneer Top Premium Veneer Chassis		High Pressure Laminate Top Veneer Chassis		Thermally Fused Laminate Top Thermally Fused Laminate Chassis	
	<b>Left Pedestal</b>							
60 x 24 x 29	130	CPC6024RE694W 2402	CPC6024RE694P 2642	CPC6024RE694G 2402	CPC6024RE694M 1319			
48 x 24 x 29	125	CPC4824RE694W 2281	CPC4824RE694P 2509	CPC4824RE694G 2281	CPC4824RE694M 1298			
42 x 24 x 29	120	CPC4224RE694W 2224	CPC4224RE694P 2446	CPC4224RE694G 2224	CPC4224RE694M 1282			
<b>Right Pedestal</b>								
60 x 24 x 29	130	CPC6024RE695W 2402	CPC6024RE695P 2642	CPC6024RE695G 2402	CPC6024RE695M 1319			
48 x 24 x 29	125	CPC4824RE695W 2281	CPC4824RE695P 2509	CPC4824RE695G 2281	CPC4824RE695M 1298			
42 x 24 x 29	120	CPC4224RE695W 2224	CPC4224RE695P 2446	CPC4224RE695G 2224	CPC4224RE695M 1282			

[View statement of line](#)

## 2 Select a finish

[View finish details](#)

WAC	WGW	TBCO	WSO	GAC	GNW	MAC
WRC	WBW	TBSW		GIC	GSTV +10%	MEC
WIC	WSW	TSTV		GEC	GSLV +10%	MHC
WEC	WNW	TSMV		GHC	GWL	MOC
WHC	WWP	TSLV		GOC		MGW
WOC		TOBW		GAM		MTW
WAM		WBO		GCM		MSW
WCM		WMO		GWM		MWL
WWW		WNO		GEW		
WEW						

## 3 Select a edge

[View edge details](#)



## 4 Select hardware

[View hardware details](#)

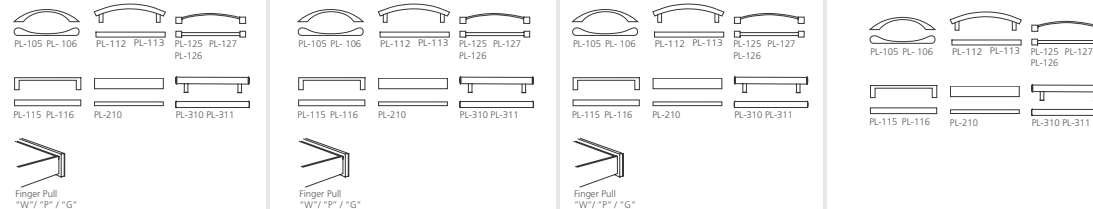

## Product features.

- 1 Standard grommet - matches pull finish or specify black TM30, silver TM31 or antique brass TM33
- 4"H back rail - open back
- Full extension drawers - locking
- "W" & "G" SKUs feature soft close suspensions, "M" SKUs feature ball bearing suspensions. Both suspensions are full extension.

### NOTES

- All units are standard w/ flush ends
- Grain Direction Runs Front To Back On All "W" Units and Up to 60" on "G" and "M" Units
- Unit is to be used with height adjustable desk

## Options.

### ACCESSORIES

- K28: Articulating Keyboard w/ Mouse - \$390

### DRAWER

- P6: Modify File/File to Box/Box/File - \$55 per pedestal
- P33: Wood Drawer Upgrade - \$45 per drawer
- P40W: extra Box/Box/File or File/File to Kneespace - \$910 (W,G)
- P40M: extra Box/Box/File or File/File to Kneespace - \$720 (M)
- WPD3061: Designer White - \$80 per pedestal

### GROMMETS (NON-STANDARD LOCATION)

- Provide drawing w/ Grommet Location and Specify Color - \$95 ea.
- Black: TM30-NS
- Silver: TM31-NS
- Antique Brass: TM33-NS

### MODESTY

- M34T-O: "W" "G" Style Drop Door Tech Modesty - \$310
- M34TM-O: "M" Style Drop Door Tech Modesty - \$235
- M37: "W" "G" Style Fixed Full Modesty - \$130
- M37M: "M" Style Fixed Full Modesty - \$80

# Central park.

"L" Workstation Returns

"L" Workstation Return - Lateral File

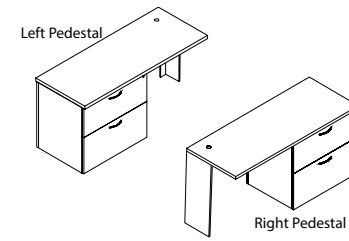

## 1 Select a model w" x d" x h"

weight	Standard Veneer Top Standard Veneer Chassis		Premium Veneer Top Premium Veneer Chassis		High Pressure Laminate Top Veneer Chassis		Thermally Fused Laminate Top Thermally Fused Laminate Chassis	
<b>Left Pedestal</b>								
72 x 24 x 29	200	CPC7224RE696W 3085	CPC7224RE696P 3394	CPC7224RE696G 3085	CPC7224RE696M 1522			
66 x 24 x 29	190	CPC6624RE696W 2942	CPC6624RE696P 3236	CPC6624RE696G 2942	CPC6624RE696M 1491			
60 x 24 x 29	175	CPC6024RE696W 2812	CPC6024RE696P 3093	CPC6024RE696G 2812	CPC6024RE696M 1424			
48 x 24 x 29	165	CPC4824RE696W 2676	CPC4824RE696P 2944	CPC4824RE696G 2676	CPC4824RE696M 1395			
<b>Right Pedestal</b>								
72 x 24 x 29	200	CPC7224RE697W 3085	CPC7224RE697P 3394	CPC7224RE697G 3085	CPC7224RE697M 1522			
66 x 24 x 29	190	CPC6624RE697W 2942	CPC6624RE697P 3236	CPC6624RE697G 2942	CPC6624RE697M 1491			
60 x 24 x 29	175	CPC6024RE697W 2812	CPC6024RE697P 3093	CPC6024RE697G 2812	CPC6024RE697M 1424			
48 x 24 x 29	165	CPC4824RE697W 2676	CPC4824RE697P 2944	CPC4824RE697G 2676	CPC4824RE697M 1395			

[View statement of line](#)

## 2 Select a finish [View finish details](#)

WAC	WGW	TBCO	WSO	GAC	GNW	MAC
WRC	WBW	TBSW		GIC	GSTV +10%	MEC
WIC	WSW	TSTV		GEC	GSLV +10%	MHC
WEC	WNW	TSMV		GHC	GWL	MOC
WHC	WWP	TSLV		GOC		MGW
WOC		TOBW		GAM		MTW
WAM		WBO		GCM		MSW
WCM		WMO		GWM		MWL
WWW		WNO		GEW		
WEW						

## 3 Select a edge [View edge details](#)

Bullnose	Classic	Cobee	Cove	Flat	Ledge	Bullnose	Classic	Cobee	Cove	Flat
Flat	Knife	Ledge	Ogee	Flat	Knife	Ledge	Ogee	Flat	Knife	Ledge
Reed	Radius	Waterfall		Reed	Radius	Waterfall		Reed	Radius	Waterfall

## 4 Select hardware [View hardware details](#)

PL-105 PL-106	PL-112 PL-113 PL-125 PL-127 PL-126	PL-105 PL-106 PL-112 PL-113 PL-125 PL-127 PL-126	PL-105 PL-106 PL-112 PL-113 PL-125 PL-127 PL-126	PL-105 PL-106 PL-112 PL-113 PL-125 PL-127 PL-126	PL-105 PL-106 PL-112 PL-113 PL-125 PL-127 PL-126
PL-115 PL-116 PL-210 PL-310 PL-311	PL-115 PL-116 PL-210 PL-310 PL-311	PL-115 PL-116 PL-210 PL-310 PL-311	PL-115 PL-116 PL-210 PL-310 PL-311	PL-115 PL-116 PL-210 PL-310 PL-311	PL-115 PL-116 PL-210 PL-310 PL-311
Finger Pull "W"/"G"	Finger Pull "W"/"P"/"G"	Finger Pull "W"/"G"	Finger Pull "W"/"G"	Finger Pull "W"/"G"	Finger Pull "W"/"G"

## Product features.

- 1 Standard grommet - matches pull finish or specify black TM30, silver TM31 or antique brass TM33
- 4"H back rail - open back
- Full extension drawers - locking
- Legal/Double letter filing
- "W" & "G" SKUs feature soft close suspensions, "M" SKUs feature ball bearing suspensions. Both suspensions are full extension.

### NOTES

- All units are standard w/ flush ends
- Grain Direction Runs Front To Back On All "W" Units and Up to 60" on "G" and "M" Units
- Grain Runs End To End On 66"/72" Sizes on "G" and "M" styles
- Keyboard N/A on 48" return
- Unit is to be used with height adjustable desk

## Options.

### ACCESSORIES

- K28: Articulating Keyboard w/ Mouse - \$390

### DRAWER

- P33: Wood Drawer Upgrade - \$45 per drawer
- P40W: extra Box/Box/File or File/File to Kneespace - \$910 (N/A on 48") (W,G)
- P40M: extra Box/Box/File or File/File to Kneespace - \$720 (N/A on 48") (M)
- WPD3061: Designer White - \$160 per lateral pedestal

### GROMMETS (NON-STANDARD LOCATION)

- Provide drawing w/ Grommet Location and Specify Color - \$95 ea.
- Black: TM30-NS
- Silver: TM31-NS
- Antique Brass: TM33-NS

### MODESTY

- M34T-O: "W" "G" Style Drop Door Tech Modesty - \$310
- M34TM-O: "M" Style Drop Door Tech Modesty - \$235
- M37: "W" "G" Style Fixed Full Modesty - \$130
- M37M: "M" Style Fixed Full Modesty - \$80

# Central park.

"L" Workstation Returns  
 "L" Workstation Return - Multi-File

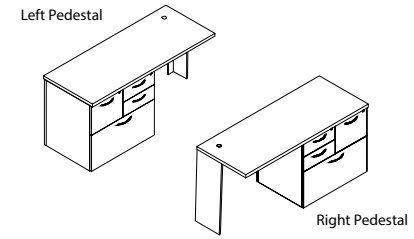

## 1 Select a model w" x d" x h"

weight	Standard Veneer Top		Premium Veneer Top		High Pressure Laminate Top		Thermally Fused Laminate Top		
	Standard Veneer Chassis		Premium Veneer Chassis		Veneer Chassis		Thermally Fused Laminate Chassis		
<b>Left Pedestal</b>									
72 x 24 x 29	200	CPC7224RE698W	3256	CPC7224RE698P	3582	CPC7224RE698G	3256	CPC7224RE698M	1597
66 x 24 x 29	190	CPC6624RE698W	3121	CPC6624RE698P	3433	CPC6624RE698G	3121	CPC6624RE698M	1567
60 x 24 x 29	175	CPC6024RE698W	2991	CPC6024RE698P	3290	CPC6024RE698G	2991	CPC6024RE698M	1522
48 x 24 x 29	165	CPC4824RE698W	2848	CPC4824RE698P	3133	CPC4824RE698G	2848	CPC4824RE698M	1471
<b>Right Pedestal</b>									
72 x 24 x 29	200	CPC7224RE699W	3256	CPC7224RE699P	3582	CPC7224RE699G	3256	CPC7224RE699M	1597
66 x 24 x 29	190	CPC6624RE699W	3121	CPC6624RE699P	3433	CPC6624RE699G	3121	CPC6624RE699M	1567
60 x 24 x 29	175	CPC6024RE699W	2991	CPC6024RE699P	3290	CPC6024RE699G	2991	CPC6024RE699M	1522
48 x 24 x 29	165	CPC4824RE699W	2848	CPC4824RE699P	3133	CPC4824RE699G	2848	CPC4824RE699M	1471

[View statement of line](#)

## 2 Select a finish [View finish details](#)

WAC	WGW	TBCO	WSO	GAC	GNW	MAC
WRC	WBW	TBSW		GIC	GSTV +10%	MEC
WIC	WSW	TSTV		GEC	GSLV +10%	MHC
WEC	WNW	TSMV		GHC	GWL	MOC
WHC	WWP	TSLV		GOC		MGW
WOC		TOBW		GAM		MTW
WAM		WBO		GCM		MSW
WCM		WMO		GWM		MWL
WWM		WNO		GEW		
WEW						

## 3 Select a edge [View edge details](#)



## 4 Select hardware [View hardware details](#)

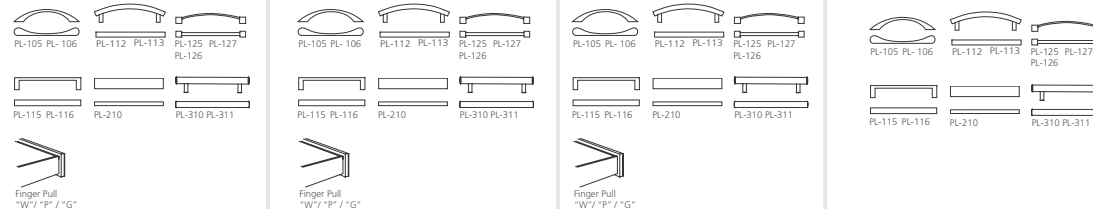

## Product features.

- 1 Standard grommet - matches pull finish or specify black TM30, silver TM31 or antique brass TM33
- 4"H back rail - open back
- Full extension drawers - locking
- Legal/Double letter filing
- "W" & "G" SKUs feature soft close suspensions, "M" SKUs feature ball bearing suspensions. Both suspensions are full extension.

### NOTES

- All units are standard w/ flush ends
- Grain Direction Runs Front To Back On All "W" Units and Up to 60" on "G" and "M" Units
- Grain Runs End To End On 66"/72" Sizes on "G" and "M" styles
- Keyboard N/A on 48" return
- Unit is to be used with height adjustable desk

## Options.

### ACCESSORIES

- K28: Articulating Keyboard w/ Mouse - \$390

### DRAWER

- P33: Wood Drawer Upgrade - \$45 per drawer
- P40W: extra Box/Box/File or File/File to Kneespace - \$910 (N/A on 48")
- P40M: extra Box/Box/File or File/File to Kneespace - \$720 (N/A on 48")
- WPD3061: Designer White - \$80 per pedestal

### GROMMETS (NON-STANDARD LOCATION)

- Provide drawing w/ Grommet Location and Specify Color - \$95 ea.
- Black: TM30-NS
- Silver: TM31-NS
- Antique Brass: TM33-NS

### MODESTY

- M34T-O: "W" "G" Style Drop Door Tech Modesty - \$310
- M34TM-O: "M" Style Drop Door Tech Modesty - \$235
- M37: "W" "G" Style Fixed Full Modesty - \$130
- M37M: "M" Style Fixed Full Modesty - \$80

# Central park.

Conference Runoff Desk

Height Adjustable Bench Credenza Conference Runoff Desk

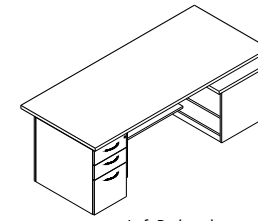

Left Pedestal

[View statement of line](#)

1 Select a model w" x d" x h"	weight	Standard Veneer Top		Premium Veneer Top		High Pressure Laminate Top		Thermally Fused Laminate Top	
		<b>Left Pedestal</b> 84 x 36 x 29 72 x 36 x 29 72 x 30 x 29	425 405 375	CPC8436DR723W CPC7236DR723W CPC7230DR723W	9277 8719 8392	CPC8436DR723P CPC7236DR723P CPC7230DR723P	10205 9591 9231	CPC8436DR723G CPC7236DR723G CPC7230DR723G	9277 8719 8392
<b>Right Pedestal</b> 84 x 36 x 29 72 x 36 x 29 72 x 30 x 29	425 405 375	CPC8436DR722W CPC7236DR722W CPC7230DR722W	9277 8719 8392	CPC8436DR722P CPC7236DR722P CPC7230DR722P	10205 9591 9231	CPC8436DR722G CPC7236DR722G CPC7230DR722G	9277 8719 8392	CPC8436DR722M CPC7236DR722M CPC7230DR722M	7143 6713 6629

2 Select a finish <a href="#">View finish details</a>	Standard Veneer Top	Premium Veneer Top	High Pressure Laminate Top	Thermally Fused Laminate Top
WAC WRC WIC WEC WHC WOC WAM WCM WWM WEW	WGW WBW WSW WNW WWP	TBCO TBSW TSTV TSMV TSLV TOBW WBO WMO WNO	WSO GNW GSTV +10% GSLV +10% GNW GSLV +10% GWL GOC GAM GCM GWM GEW	MAC MEC MHC MOC MGW MTW MSW MWL

3 Select an edge <a href="#">View edge details</a>	Standard Veneer Top	Premium Veneer Top	High Pressure Laminate Top	Thermally Fused Laminate Top
+5% Bullnose Classic Cobee Cove Flat Knife Ledge Ogee Reed Radius Waterfall	+5% Bullnose Classic Cobee Cove Flat Knife Ledge Ogee Reed Radius Waterfall	Flat Ledge	+5% Bullnose Classic Cobee Cove Flat Knife Ledge Ogee Reed Radius Waterfall	Flat

4 Select hardware <a href="#">View hardware details</a>	Standard Veneer Top	Premium Veneer Top	High Pressure Laminate Top	Thermally Fused Laminate Top
PL-105 PL-106 PL-112 PL-113 PL-125 PL-127 PL-126 PL-115 PL-116 PL-210 PL-310 PL-311 Finger Pull "W"/"P"/"G"	PL-105 PL-106 PL-112 PL-113 PL-125 PL-127 PL-126 PL-115 PL-116 PL-210 PL-310 PL-311 Finger Pull "W"/"P"/"G"	PL-105 PL-106 PL-112 PL-113 PL-125 PL-127 PL-126 PL-115 PL-116 PL-210 PL-310 PL-311 Finger Pull "W"/"P"/"G"	PL-105 PL-106 PL-112 PL-113 PL-125 PL-127 PL-126 PL-115 PL-116 PL-210 PL-310 PL-311 Finger Pull "W"/"P"/"G"	PL-105 PL-106 PL-112 PL-113 PL-125 PL-127 PL-126 PL-115 PL-116 PL-210 PL-310 PL-311 Finger Pull "W"/"P"/"G"

## Product features.

- Adjustable height from 29" to 47.5" with a maximum weight capacity of 350 lbs
- Lift available in MFS Silver (standard) or MFB Black (optional)
- Metal parts include 5 year warranty
- Programmable height adjustable mechanism, motor includes 2 year warranty
- Box/Box/File
- Legal/letter filing
- "W" & "G" SKUs feature soft close suspensions, "M" SKUs feature ball bearing suspensions. Both suspensions are full extension.
- Flush front chassis (recessed 6")
- Privacy surround panels with concealed wire management box and pole

### NOTES

- For use with 24" deep benches (23" height)
- Ships KD in 3 boxes

## Options.

### ACCESSORIES

- K28: Articulating Keyboard w/ Mouse - \$390
- K31: Center drawer - \$205

### DRAWER

- P6: Modify Box/Box/File to File/File - \$55 per pedestal
- P33: Wood Drawer Upgrade - \$45 per drawer
- WPD3061: Designer White painted drawer fronts - \$80 per pedestal front

### GROMMETS (STANDARD LOCATION)

- Specify Color and Left/Right - \$50 ea.
- Black: TM30-R (Right), TM30-L (Left)
- Silver: TM31-R (Right), TM31-L (Left)
- Antique Brass: TM33-R (Right), TM33-L (Left)

### GROMMETS (NON-STANDARD LOCATION)

- Provide drawing w/ Grommet Location and Specify Color - \$95 ea.
- Black: TM30-NS
- Silver: TM31-NS
- Antique Brass: TM33-NS

### WIRE MANAGEMENT

- LWMB: Lift wire management box with flip down door - \$365
- Power strip with five outlets and 12' cord, mesh wire cover, 6" deep black box

# Central park.

Bridges  
Open Back With 4"H Wire Management Rail

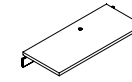

[View statement of line](#)

1 Select a model w" x d" x h"	weight	Standard Veneer Top Standard Veneer Chassis		Premium Veneer Top Premium Veneer Chassis		High Pressure Laminate Top Veneer Chassis		Thermally Fused Laminate Top Thermally Fused Laminate Chassis	
		<b>24"D</b> 48 x 24 x 29 42 x 24 x 29 36 x 24 x 29	55 50 45	CPC4824BR151W CPC4224BR151W CPC3624BR151W	626 590 561	CPC4824BR151P CPC4224BR151P CPC3624BR151P	689 649 617	CPC4824BR151G CPC4224BR151G CPC3624BR151G	626 590 561
2 Select a finish <a href="#">View finish details</a>		WAC WRC WIC WEC WHC WOC WAM WCM WWM WEW	WGW WBW WSW WNW WWP	TBCO TBSW TSTV TSMV TSLV TOBW WBO WMO WNO	WSO	GAC GIC GEC GHC GOC GAM GCM GWM GEW	GNW GSTV +10% GSLV +10% GWL	MAC MEC MHC MOC MGW MTW MSW MWL	
3 Select an edge <a href="#">View edge details</a>		Bullnose Classic Cobee Cove Flat Knife Ledge Ogee Reed Radius Waterfall	Bullnose Classic Cobee Cove Flat Ledge	Bullnose Classic Cobee Cove Flat Ledge Ogee Reed Radius Waterfall	Flat Ledge	Flat			
4 Select hardware <a href="#">View hardware details</a>		Hardware N/A		Hardware N/A		Hardware N/A		Hardware N/A	

## Product features.

- 1 Standard grommet - matches pull finish or specify black TM30, silver TM31 or antique brass TM33

## Options.

### ACCESSORIES

- K28: Articulating Keyboard w/ Mouse - \$390
- K31: Center drawer - \$205

### CURVED BRIDGE

- CBT1: Modify to Curved Bridge - \$55

### GROMMETS (NON-STANDARD LOCATION)

Provide drawing w/ Grommet Location and Specify Color - \$95 ea.

- Black: TM30-NS
- Silver: TM31-NS
- Antique Brass: TM33-NS

### MODESTY

- M34T-O: "W" "G" Style Drop Door Tech Modesty - \$310
- M34TM-O: "M" Style Drop Door Tech Modesty - \$235
- M37: "W" "G" Style Fixed Full Modesty - \$130
- M37M: "M" Style Fixed Full Modesty - \$80

# Central park.

Full Pedestal Credenzas  
File Storage Credenza

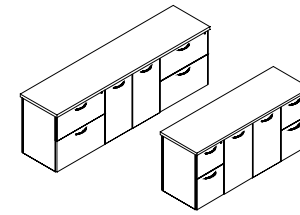

**1 Select a model**  
w" x d" x h"

**weight**

Standard Veneer Top Standard Veneer Chassis	Premium Veneer Top Premium Veneer Chassis	High Pressure Laminate Top Veneer Chassis	Thermally Fused Laminate Top Thermally Fused Laminate Chassis
93 x 24 x 29 320 CPC9324CA651W 4839	CPC9324CA651P 5323	CPC9324CA651G 4839	CPC9324CA651M 2671
87 x 24 x 29 310 CPC8724CA651W 4536	CPC8724CA651P 4990	CPC8724CA651G 4536	CPC8724CA651M 2611
<b>File/ File Storage Credenza</b>			
70 x 24 x 29 270 CPC7024CA050W 3437	CPC7024CA050P 3781	CPC7024CA050G 3437	CPC7024CA050M 2027
64 x 24 x 29 255 CPC6424CA050W 3106	CPC6424CA050P 3417	CPC6424CA050G 3106	CPC6424CA050M 2002
58 x 24 x 29 240 CPC5824CA050W 3065	CPC5824CA050P 3372	CPC5824CA050G 3065	CPC5824CA050M 1975

**2 Select a finish**  
View finish details

WAC	WGW
WRC	WBW
WIC	WSW
WEC	WNW
WHC	WWP
WOC	
WAM	
WCM	
WWW	
WEW	

**3 Select a edge**  
View edge details

Bullnose	Classic	Cobee	Cove
Flat	Knife	Ledge	Ogee
Reed	Radius	Waterfall	

**4 Select hardware**  
View hardware details

PL-105 PL-106	PL-112 PL-113	PL-125 PL-127 PL-126
PL-115 PL-116	PL-210	PL-310 PL-311
Finger Pull "W"/"P"/"G"	Touch Latch Doors	

**Premium Veneer Top  
Premium Veneer Chassis**

CPC9324CA651P 5323	CPC8724CA651P 4990
CPC7024CA050P 3781	CPC6424CA050P 3417
CPC5824CA050P 3372	

**TBCO WSO**

TBSW	WSO
TSTV	
TSMV	
TSLV	
TOBW	
WBO	
WMO	
WNO	

**Flat Ledge**

Flat	Ledge
------	-------

**PL-105 PL-106 PL-112 PL-113 PL-125 PL-127 PL-126 PL-115 PL-116 PL-210 PL-310 PL-311**

Finger Pull "W"/"P"/"G"	Touch Latch Doors
-------------------------	-------------------

**High Pressure Laminate Top  
Veneer Chassis**

CPC9324CA651G 4839	CPC8724CA651G 4536
CPC7024CA050G 3437	CPC6424CA050G 3106
CPC5824CA050G 3065	

**GAC GNW GIC GSTV +10% GEC GSLV +10% GHC GWL GOC GAM GCM GWM GEW**

Bullnose	Classic	Cobee	Cove
Flat	Knife	Ledge	Ogee
Reed	Radius	Waterfall	

**PL-105 PL-106 PL-112 PL-113 PL-125 PL-127 PL-126 PL-115 PL-116 PL-210 PL-310 PL-311**

Finger Pull "W"/"P"/"G"	Touch Latch Doors
-------------------------	-------------------

**View statement of line**

**Thermally Fused Laminate Top  
Thermally Fused Laminate Chassis**

CPC9324CA651M 2671	CPC8724CA651M 2611
CPC7024CA050M 2027	CPC6424CA050M 2002
CPC5824CA050M 1975	

**MAC MEC MHC MOC MGW MTW MSW MWL**

Flat
------

**PL-105 PL-106 PL-112 PL-113 PL-125 PL-127 PL-126 PL-115 PL-116 PL-210 PL-310 PL-311**

Touch Latch Doors
-------------------

## Product features.

- Black adjustable shelf behind door set ("W", "P" & "G" styles)
- File/File
- Full extension drawers - locking
- Lateral File anti-tilt
- "W" & "G" SKUs feature soft close suspensions, "M" SKUs feature ball bearing suspensions. Both suspensions are full extension.

### NOTES

- "M" Styles have matching "M" Finish Shelf
- All units are standard w/ flush ends
- Unit not designed for open plan use, standard with unfinished back. Select OPB Option for Open Plan application.

## Options.

### DOOR

- D2: Wood Door Lock - \$100 per door set
- D6A: "W"/"G" Styles - Delete Doors and replace black laminate shelf with finished shelf - n/c
- D9SC: Soft Close Door Hinges - \$20 per door
- WPD3061: Designer White - \$80 per door

### DRAWER

- P6: Modify File/File to Box/Box/File - \$55 per pedestal (CA050 only)
- P33: Wood Drawer Upgrade - \$45 per drawer
- WPD3061: Designer White - \$80 per pedestal F/F pedestal
- WPD3061: Designer White - \$160 per lateral pedestal

### GROMMETS (STANDARD LOCATION)

- Specify Color and Left/Right/Center - \$50 ea.
- Black: TM30-R (Right), TM30-L (Left), TM30-C (Center)
  - Silver: TM31-R (Right), TM31-L (Left), TM31-C (Center)
  - Antique Brass: TM33-R (Right), TM33-L (Left), TM33-C (Center)

### GROMMETS (NON-STANDARD LOCATION)

- Provide drawing w/ Grommet Location and Specify Color - \$95 ea.
- Black: TM30-NS
  - Silver: TM31-NS
  - Antique Brass: TM33-NS

### GROMMETS (VERTICAL SURFACE)

- Standard Location - \$50 ea.
- Black Plastic Vertical Surface: TM50-C (Bottom Center)
  - Non-Standard Location - \$95 ea.
  - Black Plastic Vertical Surface: TM50-NS
- Open Plan - Finished Back
- OPB: "W" "G" Style - Modify Unit for Open Plan Application - \$195
  - OPBM: "M" Style - Modify Unit for Open Plan Application - \$95 Shelf
  - S25: Replace Black Laminate Shelf with Finished Shelf - \$80 per shelf ("W", "P" & "G" styles)

# Central park.

Full Pedestal Credenzas  
Kneespace Credenza

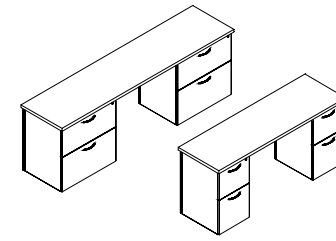

**1 Select a model**  
w" x d" x h"

	weight	Standard Veneer Top	
		Standard Veneer Top	Standard Veneer Chassis
<b>Lateral File Kneespace Credenza</b>			
93 x 24 x 29	300	CPC9324CA052W	3955
87 x 24 x 29	290	CPC8724CA052W	3877
<b>File/File Kneespace Credenza</b>			
70 x 24 x 29	220	CPC7024CA054W	3173
64 x 24 x 29	210	CPC6424CA054W	3095
58 x 24 x 29	200	CPC5824CA054W	3015

Premium Veneer Top	
Premium Veneer Top	Premium Veneer Chassis
CPC9324CA052P	4351
CPC8724CA052P	4265
CPC7024CA054P	3490
CPC6424CA054P	3405
CPC5824CA054P	3317

High Pressure Laminate Top	
Veneer Chassis	
CPC9324CA052G	3955
CPC8724CA052G	3877
CPC7024CA054G	3173
CPC6424CA054G	3095
CPC5824CA054G	3015

View statement of line

Thermally Fused Laminate Top	
Thermally Fused Laminate Chassis	
CPC9324CA052M	2184
CPC8724CA052M	2163
CPC7024CA054M	1809
CPC6424CA054M	1784
CPC5824CA054M	1747

**2 Select a finish**  
View finish details

WAC	WGW
WRC	WBW
WIC	WSW
WEC	WNW
WHC	WWP
WOC	
WAM	
WCM	
WWW	
WEW	

TBCO	WSO
TBSW	
TSTV	
TSMV	
TSLV	
TOBW	
WBO	
WMO	
WNO	

GAC	GNW
GIC	GSTV +10%
GEC	GSLV +10%
GHC	GWL
GOC	
GAM	
GCM	
GWM	
GEW	

MAC
MEC
MHC
MOC
MGW
MTW
MSW
MWL

**3 Select a edge**  
View edge details

Flat	Knife	Ledge	Ogee
Reed	Radius	Waterfall	

Flat	Ledge

Flat	Knife	Ledge	Ogee
Reed	Radius	Waterfall	

Flat

**4 Select hardware**  
View hardware details

PL-105 PL-106	PL-112 PL-113	PL-125 PL-127 PL-126
PL-115 PL-116	PL-210	PL-310 PL-311
Finger Pull "W"/"P"/"G"	Touch Latch Doors	

PL-105 PL-106	PL-112 PL-113	PL-125 PL-127 PL-126
PL-115 PL-116	PL-210	PL-310 PL-311
Finger Pull "W"/"P"/"G"	Touch Latch Doors	

PL-105 PL-106	PL-112 PL-113	PL-125 PL-127 PL-126
PL-115 PL-116	PL-210	PL-310 PL-311
Finger Pull "W"/"P"/"G"	Touch Latch Doors	

PL-105 PL-106	PL-112 PL-113	PL-125 PL-127 PL-126
PL-115 PL-116	PL-210	PL-310 PL-311
Touch Latch Doors		

## Product features.

- Anti-tilt safety feature 93"/87" units
- Full extension drawers - locking
- Kneespace w/ 4" H rail - Open back
- Lateral file or File/File
- "W" & "G" SKUs feature soft close suspensions, "M" SKUs feature ball bearing suspensions. Both suspensions are full extension.

### NOTES

- All units are standard w/ flush ends
- Unit not designed for open plan use, standard with unfinished back. Select OPB Option for Open Plan application.

## Options.

### ACCESSORIES

- K28: Articulating Keyboard w/ Mouse - \$390

### DRAWER

- P6: Modify File/File to Box/Box/File - \$55 per pedestal (CA054 only)
- P33: Wood Drawer Upgrade - \$45 per drawer
- WPD3061: Designer White - \$80 per pedestal F/F pedestal
- WPD3061: Designer White - \$160 per lateral pedestal

### GROMMETS (STANDARD LOCATION)

- Specify Color - \$50 ea.
- Black: TM30-C (Center)
  - Silver: TM31-C (Center)
  - Antique Brass: TM33-C (Center)

### GROMMETS (NON-STANDARD LOCATION)

- Provide drawing w/ Grommet Location and Specify Color - \$95 ea.
- Black: TM30-NS
  - Silver: TM31-NS
  - Antique Brass: TM33-NS

### MODESTY

- M34T-O: "W" "G" Style Drop Door Tech Modesty - \$310
- M34TM-O: "M" Style Drop Door Tech Modesty - \$235
- M37: "W" "G" Style Fixed Full Modesty - \$130
- M37M: "M" Style Fixed Full Modesty - \$80
- Open Plan - Finished Back
- OPB: "W" "G" Style - Modify Unit for Open Plan Application - \$250 (includes modesty)
- OPBM: "M" Style - Modify Unit for Open Plan Application - \$195 (includes modesty)

# Central park.

Full Pedestal Credenzas  
Storage Credenza

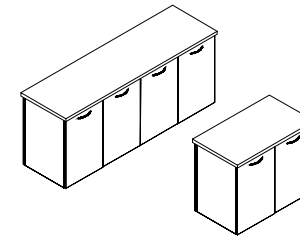

## 1 Select a model

w" x d" x h"

weight	Standard Veneer Top		Premium Veneer Top		High Pressure Laminate Top		Thermally Fused Laminate Top	
	Standard Veneer Chassis		Premium Veneer Chassis		Veneer Chassis		Thermally Fused Laminate Chassis	
70 x 24 x 29	225	CPC7024CA125W 3357	CPC7024CA125P 3693	CPC7024CA125G 3357	CPC7024CA125M 1828			
58 x 24 x 29	195	CPC5824CA125W 3019	CPC5824CA125P 3321	CPC5824CA125G 3019	CPC5824CA125M 1722			
35 x 24 x 29	130	CPC3524CA125W 1837	CPC3524CA125P 2021	CPC3524CA125G 1837	CPC3524CA125M 1108			
29 x 24 x 29	115	CPC2924CA125W 1710	CPC2924CA125P 1881	CPC2924CA125G 1710	CPC2924CA125M 1031			

View statement of line

## 2 Select a finish

View finish details

WAC	WGW	TBCO	WSO	GAC	GNW	MAC
WRC	WBW	TBSW		GIC	GSTV +10%	MEC
WIC	WSW	TSTV		GEC	GSLV +10%	MHC
WEC	WNW	TSMV		GHC	GWL	MOC
WHC	WWP	TSLV		GOC		MGW
WOC		TOBW		GAM		MTW
WAM		WBO		GCM		MSW
WCM		WMO		GWM		MWL
WWW		WNO		GEW		
WEW						

## 3 Select a edge

View edge details

+5%						+5%					
Bullnose	Classic	Cobee	Cove	Flat	Ledge	Bullnose	Classic	Cobee	Cove	Flat	
			+5%				+5%				
Flat	Knife	Ledge	Ogee	Flat	Knife	Ledge	Ogee	Flat	Knife	Ledge	Ogee
	+5%				+5%				+5%		
Reed	Radius	Waterfall		Reed	Radius	Waterfall		Reed	Radius	Waterfall	

## 4 Select hardware

View hardware details

PL-105 PL-106	PL-112 PL-113	PL-125 PL-127 PL-126	PL-105 PL-106	PL-112 PL-113	PL-125 PL-127 PL-126	PL-105 PL-106	PL-112 PL-113	PL-125 PL-127 PL-126	PL-105 PL-106	PL-112 PL-113	PL-125 PL-127 PL-126
PL-115 PL-116	PL-210	PL-310 PL-311	PL-115 PL-116	PL-210	PL-310 PL-311	PL-115 PL-116	PL-210	PL-310 PL-311	PL-115 PL-116	PL-210	PL-310 PL-311
Finger Pull "W"/"P"/"G"	Touch Latch Doors	Finger Pull "W"/"P"/"G"	Touch Latch Doors	Finger Pull "W"/"P"/"G"	Touch Latch Doors	Finger Pull "W"/"P"/"G"	Touch Latch Doors	Finger Pull "W"/"P"/"G"	Touch Latch Doors	Touch Latch Doors	Touch Latch Doors

## Product features.

- Black adjustable shelf behind door set ("W", "P" & "G" styles)

### NOTES

- "M" Styles have matching "M" Finish Shelf
- All units are standard w/ flush ends
- Unit not designed for open plan use, standard with unfinished back. Select OPB Option for Open Plan application.

## Options.

### DOOR

- D2: Wood Door Lock - \$100 per door set
- D6A: "W"/"G" Styles - Delete Doors and replace black laminate shelf with finished shelf - n/c
- D9SC: Soft Close Door Hinges - \$20 per door
- WPD3061: Designer White - \$80 per door

### GROMMETS (STANDARD LOCATION)

Specify Color and Left/Right/Center - \$50 ea.

- Black: TM30-R (Right), TM30-L (Left), TM30-C (Center)
- Silver: TM31-R (Right), TM31-L (Left), TM31-C (Center)

### GROMMETS (NON-STANDARD LOCATION)

Provide drawing w/ Grommet Location and Specify Color - \$95 ea.

- Black: TM30-NS
- Silver: TM31-NS
- Antique Brass: TM33-NS

### GROMMETS (VERTICAL SURFACE)

Standard Location - \$50 ea.

- Black Plastic Vertical Surface: TM50-C (Bottom Center)

Non-Standard Location - \$95 ea.

- Black Plastic Vertical Surface: TM50-NS

### OPEN PLAN - FINISHED BACK

- OPB: "W" "G" Style - Modify Unit for Open Plan Application - \$195
- OPB: "M" Style - Modify Unit for Open Plan Application - \$95 Shelf
- S25: Replace Black Laminate Shelf with Finished Shelf - \$80 per shelf ("W", "P" & "G" styles)



# Central park.

Full Pedestal Credenzas  
Horizontal Lateral File

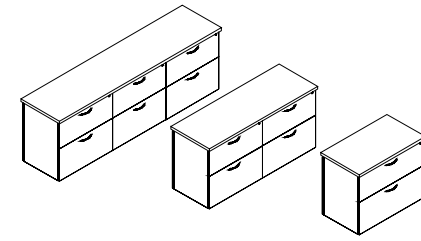

## 1 Select a model

w" x d" x h"

weight	Standard Veneer Top		Premium Veneer Top		High Pressure Laminate Top		Thermally Fused Laminate Top	
	Standard Veneer Chassis		Premium Veneer Chassis		Veneer Chassis		Thermally Fused Laminate Chassis	
93 x 24 x 29	415	CPC9324CA104W 5333	CPC9324CA104P 5866	CPC9324CA104G 5333	CPC9324CA104M 2869			
87 x 24 x 29	400	CPC8724CA104W 5030	CPC8724CA104P 5533	CPC8724CA104G 5030	CPC8724CA104M 2814			
70 x 24 x 29	310	CPC7024CA104W 3819	CPC7024CA104P 4201	CPC7024CA104G 3819	CPC7024CA104M 2184			
58 x 24 x 29	280	CPC5824CA104W 3726	CPC5824CA104P 4099	CPC5824CA104G 3726	CPC5824CA104M 2043			
41 x 24 x 29	180	CPC4124CA104W 2270	CPC4124CA104P 2497	CPC4124CA104G 2270	CPC4124CA104M 1442			
35 x 24 x 29	160	CPC3524CA104W 2025	CPC3524CA104P 2228	CPC3524CA104G 2025	CPC3524CA104M 1270			
29 x 24 x 29	145	CPC2924CA104W 1844	CPC2924CA104P 2028	CPC2924CA104G 1844	CPC2924CA104M 1178			

View statement of line

## 2 Select a finish

View finish details

WAC	WGW	TBCO	WSO	GAC	GNW	MAC
WRC	WBW	TBSW		GIC	GSTV +10%	MEC
WIC	WSW	TSTV		GEC	GSLV +10%	MHC
WEC	WNW	TSMV		GHC	GWL	MOC
WHC	WWP	TSLV		GOC		MGW
WOC		TOBW		GAM		MTW
WAM		WBO		GCM		MSW
WCM		WMO		GWM		MWL
WWW		WNO		GEW		
WEW						

## 3 Select a edge

View edge details

+5%						+5%				
Bullnose	Classic	Cobee	Cove	Flat	Ledge	Bullnose	Classic	Cobee	Cove	Flat
			+5%				+5%			
Flat	Knife	Ledge	Ogee	Flat	Knife	Ledge	Ogee	Reed	Radius	Waterfall
	+5%				+5%					
Reed	Radius	Waterfall		Reed	Radius	Waterfall				

## 4 Select hardware

View hardware details

PL-105 PL-106	PL-112 PL-113	PL-125 PL-127 PL-126	PL-105 PL-106	PL-112 PL-113	PL-125 PL-127 PL-126	PL-105 PL-106	PL-112 PL-113	PL-125 PL-127 PL-126	PL-105 PL-106	PL-112 PL-113	PL-125 PL-127 PL-126
PL-115 PL-116	PL-210	PL-310 PL-311	PL-115 PL-116	PL-210	PL-310 PL-311	PL-115 PL-116	PL-210	PL-310 PL-311	PL-115 PL-116	PL-210	PL-310 PL-311
Finger Pull "W"/"P"/"G"	Touch Latch Doors	Finger Pull "W"/"P"/"G"	Touch Latch Doors	Finger Pull "W"/"P"/"G"	Touch Latch Doors	Finger Pull "W"/"P"/"G"	Touch Latch Doors	Finger Pull "W"/"P"/"G"	Touch Latch Doors	Touch Latch Doors	Touch Latch Doors

## Product features.

- Anti-tilt safety feature
- Full extension drawers - locking
- Legal/Double letter filing
- "W" & "G" SKUs feature soft close suspensions, "M" SKUs feature ball bearing suspensions. Both suspensions are full extension.

### NOTES

- All units are standard w/ flush ends
- Unit not designed for open plan use, standard with unfinished back. Select OPB Option for Open Plan application.

## Options.

### DRAWER

- P33: Wood Drawer Upgrade - \$45 per drawer
- WPD3061: Designer White - \$160 per lateral pedestal

### OPEN PLAN - FINISHED BACK

- OPB: "W" "G" Style - Modify Unit for Open Plan Application - \$195
- OPB: "M" Style - Modify Unit for Open Plan Application - \$95

# Central park.

Full Pedestal Credenzas  
Vertical Lateral File

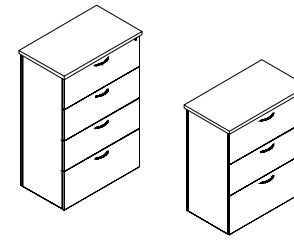

## 1 Select a model

w" x d" x h"

weight	Standard Veneer Top Standard Veneer Chassis		Premium Veneer Top Premium Veneer Chassis		High Pressure Laminate Top Veneer Chassis		Thermally Fused Laminate Top Thermally Fused Laminate Chassis	
<b>4 Drawer</b>								
35 x 24 x 54	270	CPC3524FI111W 3354	CPC3524FI111P 3689	CPC3524FI111G 3354	CPC3524FI111M 2057			
29 x 24 x 54	245	CPC2924FI111W 2885	CPC2924FI111P 3174	CPC2924FI111G 2885	CPC2924FI111M 1757			
<b>3 Drawer</b>								
35 x 24 x 42	205	CPC3524FI112W 2994	CPC3524FI112P 3293	CPC3524FI112G 2994	CPC3524FI112M 1909			
29 x 24 x 42	185	CPC2924FI112W 2611	CPC2924FI112P 2872	CPC2924FI112G 2611	CPC2924FI112M 1640			

*View statement of line*

## 2 Select a finish

*View finish details*

WAC	WGW	TBCO	WSO	GAC	GNW	MAC
WRC	WBW	TBSW		GIC	GSTV +10%	MEC
WIC	WSW	TSTV		GEC	GSLV +10%	MHC
WEC	WNW	TSMV		GHC	GWL	MOC
WHC	WWP	TSLV		GOC		MGW
WOC		TOBW		GAM		MTW
WAM		WBO		GCM		MSW
WCM		WMO		GWM		MWL
WWW		WNO		GEW		
WEW						































## 3 Select a edge

*View edge details*

 +5%						 +5%				
Bullnose	Classic	Cobee	Cove	Flat	Ledge	Bullnose	Classic	Cobee	Cove	Flat
			 +5%				 +5%			
Flat	Knife	Ledge	Ogee	Flat	Knife	Ledge	Ogee			
	 +5%				 +5%					
Reed	Radius	Waterfall		Reed	Radius	Waterfall				

## 4 Select hardware

*View hardware details*

											
PL-105 PL-106	PL-112 PL-113	PL-125 PL-127 PL-126	PL-105 PL-106	PL-112 PL-113	PL-125 PL-127 PL-126	PL-105 PL-106	PL-112 PL-113	PL-125 PL-127 PL-126	PL-105 PL-106	PL-112 PL-113	PL-125 PL-127 PL-126
											
PL-115 PL-116	PL-210	PL-310 PL-311	PL-115 PL-116	PL-210	PL-310 PL-311	PL-115 PL-116	PL-210	PL-310 PL-311	PL-115 PL-116	PL-210	PL-310 PL-311
											
Finger Pull "W"/"P"/"G"	Touch Latch Doors		Finger Pull "W"/"P"/"G"	Touch Latch Doors		Finger Pull "W"/"P"/"G"	Touch Latch Doors		Touch Latch Doors		

## Product features.

- Anti-tilt safety feature
- Full extension drawers - locking
- Legal/Double letter filing
- "W" & "G" SKUs feature soft close suspensions, "M" SKUs feature ball bearing suspensions. Both suspensions are full extension.

### NOTES

- All units are standard w/ flush ends
- Unit not designed for open plan use, standard with unfinished back. Select OPB Option for Open Plan application.

## Options.

### DRAWER

- P33: Wood Drawer Upgrade - \$45 per drawer
- WPD3061: Designer White - \$160 per lateral pedestal

### OPEN PLAN – FINISHED BACK

- OPB: "W" "G" Style - Modify Unit for Open Plan Application - \$195
- OPB: "M" Style - Modify Unit for Open Plan Application - \$95

# Central park.

Workstation Credenzas

"U" Workstation Credenza - File / File

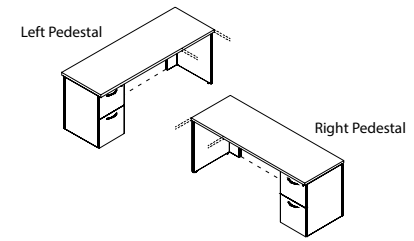

## 1 Select a model

w" x d" x h"

weight	Standard Veneer Top Standard Veneer Chassis		Premium Veneer Top Premium Veneer Chassis		High Pressure Laminate Top Veneer Chassis		Thermally Fused Laminate Top Thermally Fused Laminate Chassis	
<b>Left Pedestal</b>								
87 x 24 x 29	200	CPC8724CA086W 2792	CPC8724CA086P 3071	CPC8724CA086G 2792	CPC8724CA086M 1442			
83 x 24 x 29	190	CPC8324CA086W 2628	CPC8324CA086P 2891	CPC8324CA086G 2628	CPC8324CA086M 1427			
70 x 24 x 29	180	CPC7024CA086W 2313	CPC7024CA086P 2544	CPC7024CA086G 2313	CPC7024CA086M 1367			
64 x 24 x 29	170	CPC6424CA086W 2276	CPC6424CA086P 2504	CPC6424CA086G 2276	CPC6424CA086M 1351			
58 x 24 x 29	160	CPC5824CA086W 2240	CPC5824CA086P 2464	CPC5824CA086G 2240	CPC5824CA086M 1335			
<b>Right Pedestal</b>								
87 x 24 x 29	200	CPC8724CA087W 2792	CPC8724CA087P 3071	CPC8724CA087G 2792	CPC8724CA087M 1442			
83 x 24 x 29	190	CPC8324CA087W 2628	CPC8324CA087P 2891	CPC8324CA087G 2628	CPC8324CA087M 1427			
70 x 24 x 29	180	CPC7024CA087W 2313	CPC7024CA087P 2544	CPC7024CA087G 2313	CPC7024CA087M 1367			
64 x 24 x 29	170	CPC6424CA087W 2276	CPC6424CA087P 2504	CPC6424CA087G 2276	CPC6424CA087M 1351			
58 x 24 x 29	160	CPC5824CA087W 2240	CPC5824CA087P 2464	CPC5824CA087G 2240	CPC5824CA087M 1335			

View statement of line

## 2 Select a finish

View finish details

WAC	WGW	TBCO	WSO	GAC	GNW	MAC
WRC	WBW	TBSW		GIC	GSTV +10%	MEC
WIC	WSW	TSTV		GEC	GSLV +10%	MHC
WEC	WNW	TSMV		GHC	GWL	MOC
WHC	WWP	TSLV		GOC		MGW
WOC		TOBW		GAM		MTW
WAM		WBO		GCM		MSW
WCM		WMO		GWM		MWL
WWW		WNO		GEW		
WEW						

## 3 Select a edge

View edge details



## 4 Select hardware

View hardware details

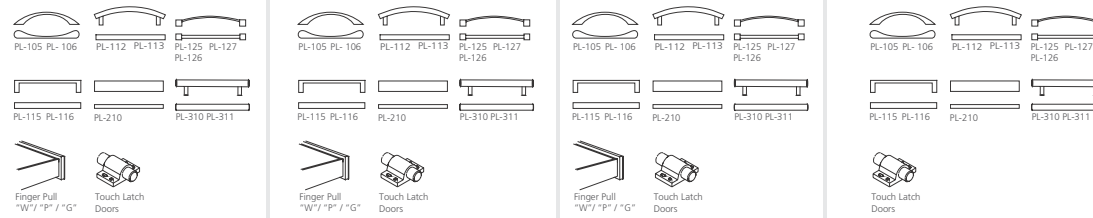

## Product features.

- 4"H back rail - open back
- Full extension drawers - locking
- Hookup hardware
- Legal/Double letter filing
- "W" & "G" SKUs feature soft close suspensions, "M" SKUs feature ball bearing suspensions. Both suspensions are full extension.

### NOTES

- All units are standard w/ flush ends
- Unit not designed for open plan use, standard with unfinished back. Select OPB Option for Open Plan application.

## Options.

### ACCESSORIES

- K28: Articulating Keyboard w/ Mouse - \$390

### DRAWER

- P6: Modify File/File to Box/Box/File - \$55 per pedestal
- P33: Wood Drawer Upgrade - \$45 per drawer
- P40W: extra Box/Box/File or File/File to Kneespace - \$910 (W, G)
- P40M: extra Box/Box/File or File/File to Kneespace - \$720 (M)
- WPD3061: Designer White - \$80 per F/F pedestal

### GROMMETS (STANDARD LOCATION)

- Specify Color - \$50 ea.
- Black: TM30-C (Center)
  - Silver: TM31-C (Center)
  - Antique Brass: TM33-C (Center)

### GROMMETS (NON-STANDARD LOCATION)

- Provide drawing w/ Grommet Location and Specify Color - \$95 ea.
- Black: TM30-NS
  - Silver: TM31-NS
  - Antique Brass: TM33-NS

### MODESTY

- M34T-O: "W" "G" Style Drop Door Tech Modesty - \$310
- M34TM-O: "M" Style Drop Door Tech Modesty - \$235
- M37: "W" "G" Style Fixed Full Modesty - \$130
- M37M: "M" Style Fixed Full Modesty - \$80
- Open Plan - Finished Back
- OPB: "W" "G" Style - Modify Unit for Open Plan Application - \$250 (includes modesty)
- OPB: "M" Style - Modify Unit for Open Plan Application - \$195 (includes modesty)

# Central park.

Workstation Credenzas

"U" Workstation Credenza - Lateral File

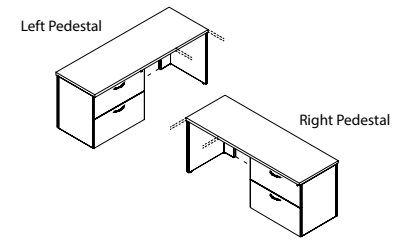

## 1 Select a model

w" x d" x h"

weight	Standard Veneer Top Standard Veneer Chassis		Premium Veneer Top Premium Veneer Chassis		High Pressure Laminate Top Veneer Chassis		Thermally Fused Laminate Top Thermally Fused Laminate Chassis	
	<b>Left Pedestal</b>							
93 x 24 x 29	240	CPC9324CA066W 3144	CPC9324CA066P 3458	CPC9324CA066G 3144	CPC9324CA066M 1671			
87x 24 x 29	225	CPC8724CA066W 3080	CPC8724CA066P 3388	CPC8724CA066G 3080	CPC8724CA066M 1645			
83 x 24 x 29	220	CPC8324CA066W 2929	CPC8324CA066P 3222	CPC8324CA066G 2929	CPC8324CA066M 1631			
* 70 x 24 x 29	215	CPC7024CA066W 2612	CPC7024CA066P 2873	CPC7024CA066G 2612	CPC7024CA066M 1504			
* 64 x 24 x 29	200	CPC6424CA066W 2578	CPC6424CA066P 2836	CPC6424CA066G 2578	CPC6424CA066M 1488			
* 58 x 24 x 29	190	CPC5824CA066W 2562	CPC5824CA066P 2818	CPC5824CA066G 2562	CPC5824CA066M 1473			
<b>Right Pedestal</b>								
93 x 24 x 29	240	CPC9324CA067W 3144	CPC9324CA067P 3458	CPC9324CA067G 3144	CPC9324CA067M 1671			
87 x 24 x 29	225	CPC8724CA067W 3080	CPC8724CA067P 3388	CPC8724CA067G 3080	CPC8724CA067M 1645			
83 x 24 x 29	220	CPC8324CA067W 2929	CPC8324CA067P 3222	CPC8324CA067G 2929	CPC8324CA067M 1631			
* 70 x 24 x 29	215	CPC7024CA067W 2612	CPC7024CA067P 2873	CPC7024CA067G 2612	CPC7024CA067M 1504			
* 64 x 24 x 29	200	CPC6424CA067W 2578	CPC6424CA067P 2836	CPC6424CA067G 2578	CPC6424CA067M 1488			
* 58 x 24 x 29	190	CPC5824CA067W 2562	CPC5824CA067P 2818	CPC5824CA067G 2562	CPC5824CA067M 1473			

View statement of line

## 2 Select a finish

View finish details

WAC	WGW	TBCO	WSO	GAC	GNW	MAC
WRC	WBW	TBSW		GIC	GSTV +10%	MEC
WIC	WSW	TSTV		GEC	GSLV +10%	MHC
WEC	WNW	TSMV		GHC	GWL	MOC
WHC	WWP	TSLV		GOC		MGW
WOC		TOBW		GAM		MTW
WAM		WBO		GCM		MSW
WCM		WMO		GWM		MWL
WWW		WNO		GEW		
WEW						

## 3 Select a edge

View edge details

+5%						+5%					
Bullnose	Classic	Cobee	Cove	Flat	Ledge	Bullnose	Classic	Cobee	Cove	Flat	
			+5%				+5%				+5%
Flat	Knife	Ledge	Ogee	Flat	Knife	Ledge	Ogee	Flat	Knife	Ledge	Ogee
	+5%				+5%				+5%		
Reed	Radius	Waterfall		Reed	Radius	Waterfall		Reed	Radius	Waterfall	

## 4 Select hardware

View hardware details

PL-105 PL-106	PL-112 PL-113	PL-125 PL-127	PL-105 PL-106	PL-112 PL-113	PL-125 PL-127	PL-105 PL-106	PL-112 PL-113	PL-125 PL-127	PL-105 PL-106	PL-112 PL-113	PL-125 PL-127
PL-115 PL-116	PL-210	PL-310 PL-311	PL-115 PL-116	PL-210	PL-310 PL-311	PL-115 PL-116	PL-210	PL-310 PL-311	PL-115 PL-116	PL-210	PL-310 PL-311
Finger Pull "W"/"P"/"G"	Touch Latch Doors	Finger Pull "W"/"P"/"G"	Touch Latch Doors	Finger Pull "W"/"P"/"G"	Touch Latch Doors	Finger Pull "W"/"P"/"G"	Touch Latch Doors	Finger Pull "W"/"P"/"G"	Touch Latch Doors	Touch Latch Doors	Touch Latch Doors

## Product features.

- 4"H back rail - open back
- Full extension drawers - locking
- Hookup hardware
- Legal/Double letter filing
- "W" & "G" SKUs feature soft close suspensions, "M" SKUs feature ball bearing suspensions. Both suspensions are full extension.

### NOTES

- (\*) Denotes Units w/ Kneespace Not Sufficient For Keyboard
- All units are standard w/ flush ends
- Unit not designed for open plan use, standard with unfinished back. Select OPB Option for Open Plan application.

## Options.

### ACCESSORIES

- K28: Articulating Keyboard w/ Mouse - \$390

### DRAWER

- P33: Wood Drawer Upgrade - \$45 per drawer
- P40W: extra Box/Box/File or File/File to Kneespace - \$910 (N/A on 58") (W,G)
- P40M: extra Box/Box/File or File/File to Kneespace - \$720 (N/A on 58") (M)
- WPD3061: Designer White - \$160 per lateral pedestal

### GROMMETS (STANDARD LOCATION)

- Specify Color - \$50 ea.
- Black: TM30-C (Center)
- Silver: TM31-C (Center)
- Antique Brass: TM33-C (Center)

### GROMMETS (NON-STANDARD LOCATION)

- Provide drawing w/ Grommet Location and Specify Color - \$95 ea.
- Black: TM30-NS
- Silver: TM31-NS
- Antique Brass: TM33-NS

### MODESTY

- M34T-O: "W" "G" Style Drop Door Tech Modesty - \$310
- M34TM-O: "M" Style Drop Door Tech Modesty - \$235
- M37: "W" "G" Style Fixed Full Modesty - \$130
- M37M: "M" Style Fixed Full Modesty - \$80
- Open Plan - Finished Back
- OPB: "W" "G" Style - Modify Unit for Open Plan Application - \$250 (includes modesty)
- OPB: "M" Style - Modify Unit for Open Plan Application - \$195 (includes modesty)

# Central park.

Workstation Credenzas

"U" Workstation Credenza - Multi-File

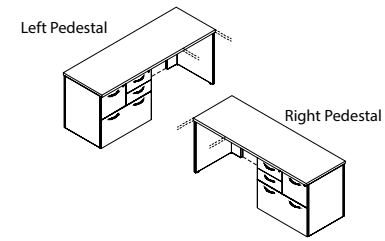

## 1 Select a model

w" x d" x h"

weight	Standard Veneer Top		Premium Veneer Top		High Pressure Laminate Top		Thermally Fused Laminate Top	
	Standard Veneer Chassis		Premium Veneer Chassis		Veneer Chassis		Thermally Fused Laminate Chassis	
<b>Left Pedestal</b>								
93 x 24 x 29	240	CPC9324CA667W 3524	CPC9324CA667P 3876	CPC9324CA667G 3524	CPC9324CA667M 1747			
87 x 24 x 29	225	CPC8724CA667W 3453	CPC8724CA667P 3798	CPC8724CA667G 3453	CPC8724CA667M 1722			
83 x 24 x 29	220	CPC8324CA667W 3302	CPC8324CA667P 3632	CPC8324CA667G 3302	CPC8324CA667M 1707			
* 70 x 24 x 29	215	CPC7024CA667W 2987	CPC7024CA667P 3286	CPC7024CA667G 2987	CPC7024CA667M 1580			
* 64 x 24 x 29	200	CPC6424CA667W 2950	CPC6424CA667P 3245	CPC6424CA667G 2950	CPC6424CA667M 1565			
* 58 x 24 x 29	190	CPC5824CA667W 2935	CPC5824CA667P 3229	CPC5824CA667G 2935	CPC5824CA667M 1550			
<b>Right Pedestal</b>								
93 x 24 x 29	240	CPC9324CA668W 3524	CPC9324CA668P 3876	CPC9324CA668G 3524	CPC9324CA668M 1747			
87 x 24 x 29	225	CPC8724CA668W 3453	CPC8724CA668P 3798	CPC8724CA668G 3453	CPC8724CA668M 1722			
83 x 24 x 29	220	CPC8324CA668W 3302	CPC8324CA668P 3632	CPC8324CA668G 3302	CPC8324CA668M 1707			
* 70 x 24 x 29	215	CPC7024CA668W 2987	CPC7024CA668P 3286	CPC7024CA668G 2987	CPC7024CA668M 1580			
* 64 x 24 x 29	200	CPC6424CA668W 2950	CPC6424CA668P 3245	CPC6424CA668G 2950	CPC6424CA668M 1565			
* 58 x 24 x 29	190	CPC5824CA668W 2935	CPC5824CA668P 3229	CPC5824CA668G 2935	CPC5824CA668M 1550			

View statement of line

## 2 Select a finish

View finish details

WAC	WGW	TBCO	WSO	GAC	GNW	MAC
WRC	WBW	TBSW		GIC	GSTV +10%	MEC
WIC	WSW	TSTV		GEC	GSLV +10%	MHC
WEC	WNW	TSMV		GHC	GWL	MOC
WHC	WWP	TSLV		GOC		MGW
WOC		TOBW		GAM		MTW
WAM		WBO		GCM		MSW
WCM		WMO		GWM		MWL
WWW		WNO		GEW		
WEW						

## 3 Select a edge

View edge details



## 4 Select hardware

View hardware details

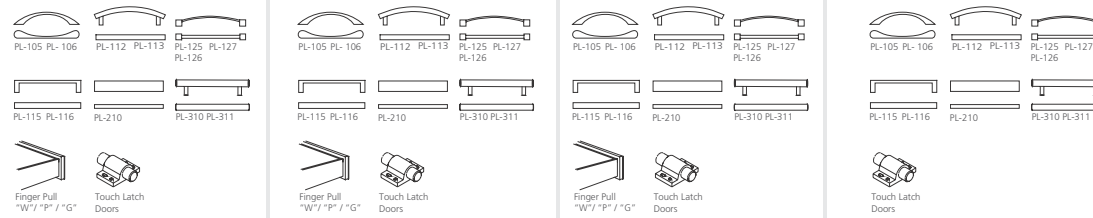

## Product features.

- 4"H back rail - open back
- Full extension drawers - locking
- Hookup hardware
- Multi-file provides legal-double letter filing
- "W" & "G" SKUs feature soft close suspensions, "M" SKUs feature ball bearing suspensions. Both suspensions are full extension.

### NOTES

- (\*) Denotes Units w/ Kneespace Not Sufficient For Keyboard
- All units are standard w/ flush ends
- Unit not designed for open plan use, standard with unfinished back. Select OPB Option for Open Plan application.

## Options.

### ACCESSORIES

- K28: Articulating Keyboard w/ Mouse - \$390

### DRAWER

- P33: Wood Drawer Upgrade - \$45 per drawer
- P40W: extra Box/Box/File or File/File to Kneespace - \$910 (N/A on 58") (W,G)
- P40M: extra Box/Box/File or File/File to Kneespace - \$720 (N/A on 58") (M)
- WPD3061: Designer White - \$80 per F/F pedestal
- WPD3061: Designer White - \$160 per lateral pedestal

### GROMMETS (STANDARD LOCATION)

- Specify Color - \$50 ea.
- Black: TM30-C (Center)
- Silver: TM31-C (Center)
- Antique Brass: TM33-C (Center)

### GROMMETS (NON-STANDARD LOCATION)

- Provide drawing w/ Grommet Location and Specify Color - \$95 ea.
- Black: TM30-NS
- Silver: TM31-NS
- Antique Brass: TM33-NS

### MODESTY

- M34T-O: "W" "G" Style Drop Door Tech Modesty - \$310
- M34TM-O: "M" Style Drop Door Tech Modesty - \$235
- M37: "W" "G" Style Fixed Full Modesty - \$130
- M37M: "M" Style Fixed Full Modesty - \$80
- Open Plan - Finished Back
- OPB: "W" "G" Style - Modify Unit for Open Plan Application - \$250 (includes modesty)
- OPB: "M" Style - Modify Unit for Open Plan Application - \$195 (includes modesty)

# Central park.

Workstation Shells  
Open Back

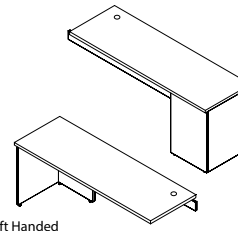

Left Handed

1 Select a model  
w" x d" x h"

weight

	Standard Veneer Top Standard Veneer Chassis	Premium Veneer Top Premium Veneer Chassis	High Pressure Laminate Top Veneer Chassis	Thermally Fused Laminate Top Thermally Fused Laminate Chassis
<b>Left Handed Return Shell</b>				
72 x 24 x 29	110 CPC7224RE213W 1699	CPC7224RE213P 1869	CPC7224RE213G 1699	CPC7224RE213M 869
66 x 24 x 29	100 CPC6624RE213W 1622	CPC6624RE213P 1784	CPC6624RE213G 1622	CPC6624RE213M 849
60 x 24 x 29	95 CPC6024RE213W 1543	CPC6024RE213P 1697	CPC6024RE213G 1543	CPC6024RE213M 778
54 x 24 x 29	90 CPC5424RE213W 1462	CPC5424RE213P 1608	CPC5424RE213G 1462	CPC5424RE213M 762
48 x 24 x 29	85 CPC4824RE213W 1377	CPC4824RE213P 1515	CPC4824RE213G 1377	CPC4824RE213M 747
<b>Right Handed Return Shell</b>				
72 x 24 x 29	110 CPC7224RE214W 1699	CPC7224RE214P 1869	CPC7224RE214G 1699	CPC7224RE214M 869
66 x 24 x 29	100 CPC6624RE214W 1622	CPC6624RE214P 1784	CPC6624RE214G 1622	CPC6624RE214M 849
60 x 24 x 29	95 CPC6024RE214W 1543	CPC6024RE214P 1697	CPC6024RE214G 1543	CPC6024RE214M 778
54 x 24 x 29	90 CPC5424RE214W 1462	CPC5424RE214P 1608	CPC5424RE214G 1462	CPC5424RE214M 762
48 x 24 x 29	85 CPC4824RE214W 1377	CPC4824RE214P 1515	CPC4824RE214G 1377	CPC4824RE214M 747

View statement of line

2 Select a finish  
View finish details

WAC WGW  
WRC WBW  
WIC WSW  
WEC WNW  
WHC WWP  
WOC  
WAM  
WCM  
WWW  
WEW

TBCO WSO  
TBSW  
TSTV  
TSMV  
TSLV  
TOBW  
WBO  
WMO  
WNO

GAC GNW  
GIC GSTV +10%  
GEC GSLV +10%  
GHC GWL  
GOC  
GAM  
GCM  
GWM  
GEW

MAC  
MEC  
MHC  
MOC  
MGW  
MTW  
MSW  
MWL

3 Select a edge  
View edge details



4 Select hardware  
View hardware details

Hardware  
N/A

Hardware  
N/A

Hardware  
N/A

Hardware  
N/A

## Product features.

- 4"H back rail - open back
- Standard with grommet

### NOTES

- All units are standard w/ flush ends
- Grain Direction Runs Front To Back On All "W" Units and Up to 60" on "G" and "M" Units
- Grain Runs End To End On 66"/72" Sizes on "G" and "M" styles
- If grommet is added then unit will become handed
- Unit ships assembled

## Options.

### ACCESSORIES

- K28: Articulating Keyboard w/ Mouse - \$390
- K31: Center drawer - \$205

### GROMMETS (NON-STANDARD LOCATION)

Provide drawing w/ Grommet Location and Specify Color - \$95 ea.

- Black: TM30-NS
- Silver: TM31-NS
- Antique Brass: TM33-NS

### MODESTY

- M34T-O: "W" "G" Style Drop Door Tech Modesty - \$310
- M34TM-O: "M" Style Drop Door Tech Modesty - \$235
- M37: "W" "G" Style Fixed Full Modesty - \$130
- M37M: "M" Style Fixed Full Modesty - \$80

### RETURN SHELL

- RE202: Non-Handed/Reconfigurable Return Shell - n/c

# Central park.

Workstation Freestanding Credenza Shells  
Open Back

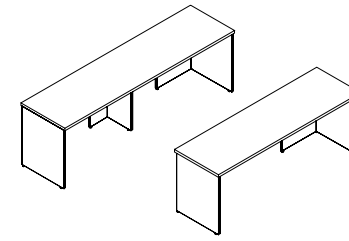

## 1 Select a model

w" x d" x h"

weight	Standard Veneer Top		Premium Veneer Top		High Pressure Laminate Top		Thermally Fused Laminate Top	
	Standard Veneer Chassis		Premium Veneer Chassis		Veneer Chassis		Thermally Fused Laminate Chassis	
105 x 24 x 29	250	CPC10524CA082W 3424	CPC10524CA082P 3766	CPC10524CA082G 3424	"M" Option N/A			
99 x 24 x 29	235	CPC9924CA082W 2972	CPC9924CA082P 3269	CPC9924CA082G 2972	"M" Option N/A			
93 x 24 x 29	225	CPC9324CA082W 2663	CPC9324CA082P 2929	CPC9324CA082G 2663	CPC9324CA082M 1148			
87 x 24 x 29	205	CPC8724CA082W 2370	CPC8724CA082P 2607	CPC8724CA082G 2370	CPC8724CA082M 1088			
83 x 24 x 29	175	CPC8324CA082W 2053	CPC8324CA082P 2258	CPC8324CA082G 2053	CPC8324CA082M 1067			
77 x 24 x 29	165	CPC7724CA082W 1981	CPC7724CA082P 2179	CPC7724CA082G 1981	CPC7724CA082M 1036			
70 x 24 x 29	155	CPC7024CA082W 1909	CPC7024CA082P 2100	CPC7024CA082G 1909	CPC7024CA082M 1006			
64 x 24 x 29	145	CPC6424CA082W 1866	CPC6424CA082P 2053	CPC6424CA082G 1866	CPC6424CA082M 976			
58 x 24 x 29	135	CPC5824CA082W 1824	CPC5824CA082P 2006	CPC5824CA082G 1824	CPC5824CA082M 944			

[View statement of line](#)

## Product features.

### NOTES

- 93" /99"/105" Units w/ Center "T" Support
- All units are standard w/ flush ends
- Can Be Used Freestanding Or Create "L" And "U" Workstations Using Runoff Desk, With Bench Credenza, Return, or Bridge.
- Half support end when runoff is attached w/ modesty
- When ganging multiple modular pedestals together (without kneespace) under shell units, contact factory to confirm size availability.

## Options.

### ACCESSORIES

- K28: Articulating Keyboard w/ Mouse - \$390

### GROMMETS (STANDARD LOCATION)

Specify Color and Left/Right/Center - \$50 ea.

- Black: TM30-R (Right), TM30-L (Left), TM30-C (Center)
- Silver: TM31-R (Right), TM31-L (Left), TM31-C (Center)
- Antique Brass: TM33-R (Right), TM33-L (Left), TM33-C (Center)

### GROMMETS (NON-STANDARD LOCATION)

Provide drawing w/ Grommet Location and Specify Color - \$95 ea.

- Black: TM30-NS
- Silver: TM31-NS
- Antique Brass: TM33-NS

### MODESTY

- M34T-O: "W" "G" Style Drop Door Tech Modesty - \$310
- M34TM-O: "M" Style Drop Door Tech Modesty - \$235
- M37: "W" "G" Style Fixed Full Modesty - \$130
- M37M: "M" Style Fixed Full Modesty - \$80

## 2 Select a finish

[View finish details](#)

WAC	WGW	TBCO	WSO	GAC	GNW	MAC
WRC	WBW	TBSW		GIC	GSTV +10%	MEC
WIC	WSW	TSTV		GEC	GSLV +10%	MHC
WEC	WNW	TSMV		GHC	GWL	MOC
WHC	WWP	TSLV		GOC		MGW
WOC		TOBW		GAM		MTW
WAM		WBO		GCM		MSW
WCM		WMO		GWM		MWL
WWW		WNO		GEW		
WEW						

## 3 Select a edge

[View edge details](#)

 Bullnose	 Classic	 Cobee	 Cove	 Flat	 Ledge	 Bullnose	 Classic	 Cobee	 Cove	 Flat
 Flat	 Knife	 Ledge	 Ogee	 Flat	 Knife	 Ledge	 Ogee			
 Reed	 Radius	 Waterfall		 Reed	 Radius	 Waterfall				

## 4 Select hardware

[View hardware details](#)

Hardware N/A	Hardware N/A	Hardware N/A	Hardware N/A
-----------------	-----------------	-----------------	-----------------

# Central park.

Single Height Bench Cabinets

One, Two, Three And Four Section Storage

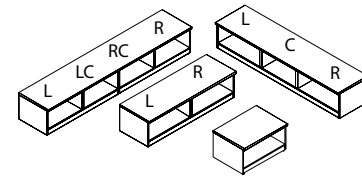

1 Select a model w" x d" x h"	weight	Standard Veneer Top Standard Veneer Chassis		Premium Veneer Top Premium Veneer Chassis		High Pressure Laminate Top Veneer Chassis		Thermally Fused Laminate Top Thermally Fused Laminate Chassis	
		<b>Four Section Storage</b> 116 x 24 x 19	395	CPC11624CA062W	4587	CPC11624CA062P	5046	CPC11624CA062G	4587
<b>Three Section Storage</b> 105 x 24 x 19	275	CPC10524CA062W	3353	CPC10524CA062P	3688	CPC10524CA062G	3353	"M" Option N/A	
99 x 24 x 19	245	CPC9924CA062W	3080	CPC9924CA062P	3388	CPC9924CA062G	3080	"M" Option N/A	
93 x 24 x 19	235	CPC9324CA062W	2929	CPC9324CA062P	3222	CPC9324CA062G	2929	CPC9324CA062M	1772
87 x 24 x 19	225	CPC8724CA062W	2849	CPC8724CA062P	3134	CPC8724CA062G	2849	CPC8724CA062M	1600
<b>Two Section Storage</b> 70 x 24 x 19	185	CPC7024CA062W	1983	CPC7024CA062P	2181	CPC7024CA062G	1983	CPC7024CA062M	1335
58 x 24 x 19	165	CPC5824CA062W	1916	CPC5824CA062P	2108	CPC5824CA062G	1916	CPC5824CA062M	1240
<b>One Section Storage</b> 35 x 24 x 19	80	CPC3524CA062W	991	CPC3524CA062P	1090	CPC3524CA062G	991	CPC3524CA062M	544
29 x 24 x 19	75	CPC2924CA062W	958	CPC2924CA062P	1054	CPC2924CA062G	958	CPC2924CA062M	523

[View statement of line](#)

## 2 Select a finish

[View finish details](#)

- WAC
- WRC
- WIC
- WEC
- WHC
- WOC
- WAM
- WCM
- WWW
- WEW



- TBCO
- TBSW
- TSTV
- TSMV
- TSLV
- TOBW
- WBO
- WMO
- WNO



- GAC
- GIC
- GEC
- GHC
- GOC
- GAM
- GCM
- GWM
- GEW



- MAC
- MEC
- MHC
- MOC
- MGW
- MTW
- MSW
- MWL



## 3 Select a edge

[View edge details](#)

## 4 Select hardware

[View hardware details](#)

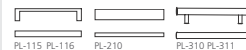
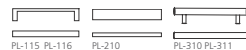
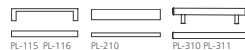

## Product features.

- 6 Wire dividers per open cabinet
- Finished back - open plan
- Top w/ flat edges

### NOTES

- All units are standard w/ flush ends
- To Use Runoff Desk With Bench Cabinets, Order Bench Runoff Support Ends: See Bench Accessory Page 71-72

## Options.

### CUSHION

- BC24: Bench Cushion
- Specify location, number of cushions and fabric grade.
- Cushions sold individually w/a max width 35" (to match storage section depth). 29" W requires .75 yd, 35" W requires 1 yd.

### GROMMETS (STANDARD LOCATION)

- Specify Color and Left/Right/Center - \$50 ea.
- Black: TM30-R (Right), TM30-L (Left), TM30-C (Center)
- Silver: TM31-R (Right), TM31-L (Left), TM31-C (Center)
- Antique Brass: TM33-R (Right), TM33-L (Left), TM33-C (Center)

### GROMMETS (NON-STANDARD LOCATION)

- Provide drawing w/ Grommet Location and Specify Color - \$95 ea.
- Black: TM30-NS
- Silver: TM31-NS
- Antique Brass: TM33-NS

### GROMMETS (VERTICAL SURFACE)

- Standard Location - \$50 ea.
- Black Plastic Vertical Surface: TM50-C (Bottom Center)
- Non-Standard Location - \$95 ea.
- Black Plastic Vertical Surface: TM50-NS

### STORAGE

- Specify pull with storage option/ Specify location of each cabinet
- Lateral file - P1DW: \$515 for "W" and "G" / P1DM: \$260 for "M"
- Two Box - P2DW: \$515 for "W" and "G" / P1DM: \$260 for "M"
- Two Door Storage - P1DR: \$205 for "W" and "G" / P1DM: \$130 for "M"

## BC24 Bench Cushion fabric grades.

COM	COL	1	2	3
270	289	298	312	326
4	5	6	7	8
340	354	368	382	396
9	10	11/ L1	12	13/ L2
410	424	438	452	480

true to craft



# Central park.

Double Height Bench Cabinets

One, Two, Three And Four Section Storage

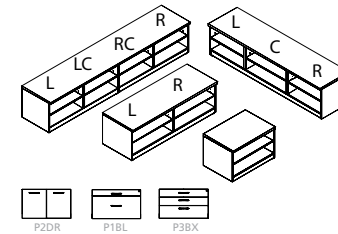

[View statement of line](#)

1 Select a model w" x d" x h"	weight	Standard Veneer Top Standard Veneer Chassis		Premium Veneer Top Premium Veneer Chassis		High Pressure Laminate Top Veneer Chassis		Thermally Fused Laminate Top Thermally Fused Laminate Chassis	
		<b>Four Section Storage</b> 116 x 24 x 23	450	CPC11624CA063W	5133	CPC11624CA063P	5646	CPC11624CA063G	5133
<b>Three Section Storage</b> 105 x 24 x 23	325	CPC10524CA063W	3930	CPC10524CA063P	4323	CPC10524CA063G	3930	"M" Option N/A	
99 x 24 x 23	315	CPC9924CA063W	3794	CPC9924CA063P	4173	CPC9924CA063G	3794	"M" Option N/A	
93 x 24 x 23	300	CPC9324CA063W	3630	CPC9324CA063P	3993	CPC9324CA063G	3630	CPC9324CA063M	2082
87 x 24 x 23	290	CPC8724CA063W	3357	CPC8724CA063P	3693	CPC8724CA063G	3357	CPC8724CA063M	1879
<b>Two Section Storage</b> 70 x 24 x 23	225	CPC7024CA063W	2399	CPC7024CA063P	2639	CPC7024CA063G	2399	CPC7024CA063M	1569
58 x 24 x 23	210	CPC5824CA063W	2264	CPC5824CA063P	2490	CPC5824CA063G	2264	CPC5824CA063M	1458
<b>One Section Storage</b> 35 x 24 x 23	95	CPC3524CA063W	1266	CPC3524CA063P	1393	CPC3524CA063G	1266	CPC3524CA063M	640
29 x 24 x 23	90	CPC2924CA063W	1230	CPC2924CA063P	1353	CPC2924CA063G	1230	CPC2924CA063M	615

2 Select a finish <a href="#">View finish details</a>	Standard Veneer Top		Premium Veneer Top		High Pressure Laminate Top		Thermally Fused Laminate Top	
WAC	WGW	TBCO	WSO	GAC	GNW	MAC		
WRC	WBW	TBSW		GIC	GSTV +10%	MEC		
WIC	WSW	TSTV		GEC	GSLV +10%	MHC		
WEC	WNW	TSMV		GHC	GWL	MOC		
WHC	WWP	TSLV		GOC		MGW		
WOC		TOBW		GAM		MTW		
WAM		WBO		GCM		MSW		
WCM		WMO		GWM		MWL		
WWW		WNO		GEW				
WEW								

3 Select a edge <a href="#">View edge details</a>	Standard Veneer Top		Premium Veneer Top		High Pressure Laminate Top		Thermally Fused Laminate Top	
Flat	Flat	Flat	Flat	Flat	Flat	Flat	Flat	

4 Select hardware <a href="#">View hardware details</a>	Standard Veneer Top		Premium Veneer Top		High Pressure Laminate Top		Thermally Fused Laminate Top	
 PL-105 PL-106 PL-112 PL-113 PL-125 PL-127 PL-126 PL-115 PL-116 PL-210 PL-310 PL-311 Finger Pull "W"/"P"/"G"	 PL-105 PL-106 PL-112 PL-113 PL-125 PL-127 PL-126 PL-115 PL-116 PL-210 PL-310 PL-311 Finger Pull "W"/"P"/"G"	 PL-105 PL-106 PL-112 PL-113 PL-125 PL-127 PL-126 PL-115 PL-116 PL-210 PL-310 PL-311 Finger Pull "W"/"P"/"G"	 PL-105 PL-106 PL-112 PL-113 PL-125 PL-127 PL-126 PL-115 PL-116 PL-210 PL-310 PL-311 Finger Pull "W"/"P"/"G"					

## Product features.

- Finished back - open plan
- Top w/ flat edges

### NOTES

- All units are standard w/ flush ends
- To Use Runoff Desk With Bench Cabinets, Order Bench Runoff Support Ends: See Bench Accessory Page 71-72

## Options.

### CUSHION

- BC24: Bench Cushion
- Specify location, number of cushions and fabric grade.
- Cushions sold individually w/a max width 35" (to match storage section depth). 29" W requires .75 yd, 35" W requires 1 yd.

### GROMMETS (STANDARD LOCATION)

- Specify Color and Left/Right/Center - \$50 ea.
- Black: TM30-R (Right), TM30-L (Left), TM30-C (Center)
- Silver: TM31-R (Right), TM31-L (Left), TM31-C (Center)
- Antique Brass: TM33-R (Right), TM33-L (Left), TM33-C (Center)

### GROMMETS (NON-STANDARD LOCATION)

- Provide drawing w/ Grommet Location and Specify Color - \$95 ea.
- Black: TM30-NS
- Silver: TM31-NS
- Antique Brass: TM33-NS

### GROMMETS (VERTICAL SURFACE)

- Standard Location - \$50 ea.
- Black Plastic Vertical Surface: TM50-C (Bottom Center)
- Non-Standard Location - \$95 ea.
- Black Plastic Vertical Surface: TM50-NS

### STORAGE

- Specify pull with storage option/ Specify location of each cabinet
- P1BL: Box/Lateral File - \$315 M / \$620 W
- P2DR: Storage Door - \$185 M / \$290 W
- P2PP: Open Printer Pullout - \$235 M / \$340 W
- P3BX: Three Box Drawers - \$315 M / \$620 W

## BC24 Bench Cushion fabric grades.

COM	COL	1	2	3
270	289	298	312	326
4	5	6	7	8
340	354	368	382	396
9	10	11/ L1	12	13/ L2
410	424	438	452	480

# Central park.

Bench Accessories

Bench Runoff Support Wood "T" Panel

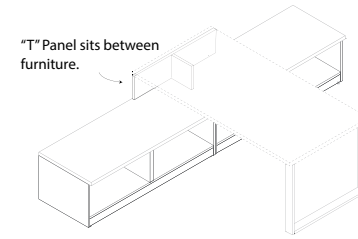

*View statement of line*

1 Select a model w" x d" x h"	weight	Standard Veneer Top Standard Veneer Chassis		Premium Veneer Top Premium Veneer Chassis		High Pressure Laminate Top Veneer Chassis		Thermally Fused Laminate Top Thermally Fused Laminate Chassis	
		<b>For 19" Bench</b> 36" Runoff 30" Runoff <b>For 23" Bench</b> 36" Runoff 30" Runoff	20 15 25 20	19BRT36W 19BRT30W 23BRT36W 23BRT30W	499 459 433 392	19BRT36P 19BRT30P 23BRT36P 23BRT30P	549 505 476 431	"G" Option N/A "G" Option N/A "G" Option N/A "G" Option N/A	19BRT36M 19BRT30M 23BRT36M 23BRT30M
2 Select a finish <i>View finish details</i>		WAC WRC WIC WEC WHC WOC WAM WCM WWM WEW	WGW WBW WSW WNW WWP	TBCO TBSW TSTV TSMV TSLV TOBW WBO WMO WNO	WSO		MAC MEC MHC MOC MGW MTW MSW MWL		
3 Select a edge <i>View edge details</i>		Edge N/A		Edge N/A			Edge N/A		
4 Select hardware <i>View hardware details</i>		Hardware N/A		Hardware N/A			Hardware N/A		

## Product features.

**NOTES**

- Used when specifying runoff desk for use with bench credenzas
- Wood "T" Panel (Factory Installed) on runoff

# Central park.

Bench Accessories

Bench Runoff Technology Support

1 Select a model w" x d" x h"	weight	Standard Veneer Top Standard Veneer Chassis		Premium Veneer Top Premium Veneer Chassis		High Pressure Laminate Top Veneer Chassis		Thermally Fused Laminate Top Thermally Fused Laminate Chassis		
		<b>For 19" Bench</b>								
36" Runoff	20	19BRN36W	591	19BRN36P	650	"G" Option N/A		19BRN36M	371	
30" Runoff	15	19BRN30W	566	19BRN30P	623	"G" Option N/A		19BRN30M	350	
<b>For 23" Bench</b>										
36" Runoff	25	23BRN36W	524	23BRN36P	576	"G" Option N/A		23BRN36M	331	
30" Runoff	20	23BRN30W	499	23BRN30P	549	"G" Option N/A		23BRN30M	310	
<b>2 Select a finish</b> <i>View finish details</i>										
		WAC	WGW	TBCO	WSO			MAC		
		WRC	WBW	TBSW				MEC		
		WIC	WSW	TSTV				MHC		
		WEC	WNW	TSMV				MOC		
		WHC	WWP	TSLV				MGW		
		WOC		TOBW				MTW		
		WAM		WBO				MSW		
		WCM		WMO				MWL		
		WWW		WNO						
		WEW								
<b>3 Select an edge</b> <i>View edge details</i>										
		Edge		Edge				Edge		
		N/A		N/A				N/A		
<b>4 Select hardware</b> <i>View hardware details</i>										
		Hardware		Hardware				Hardware		
		N/A		N/A				N/A		

[View statement of line](#)

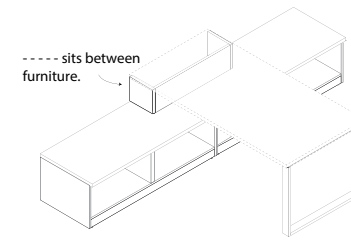

## Product features.

### NOTES

- Cavity is 7.75" D X 8.25" I x 5" H
- Order Power/Data Modules Separately - See Option Page

# Central park.

Mobile Pedestals

Open Plan Mobile Desk Pedestal With Casters

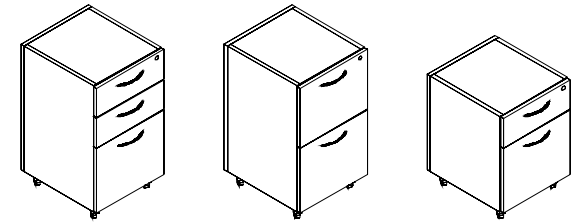

DARRAN

## 1 Select a model w" x d" x h"

weight	Standard Veneer Top Standard Veneer Chassis		Premium Veneer Top Premium Veneer Chassis		High Pressure Laminate Top Veneer Chassis	Thermally Fused Laminate Top Thermally Fused Laminate Chassis	
	<b>Box/Box/File</b> 16 x 18 x 27	70	CPC1618PD424W 1427	CPC1618PD424P 1570	"G" Option N/A	CPC1618PD424M 1037	
<b>File/File</b> 16 x 18 x 27	70	CPC1618PD425W 1427	CPC1618PD425P 1570	"G" Option N/A	CPC1618PD425M 1037		
<b>Box/File</b> 16 x 18 x 23	55	CPC1618PD423W 1341	CPC1618PD423P 1475	"G" Option N/A	CPC1618PD423M 969		

View statement of line

## 2 Select a finish View finish details

WAC	WGW	TBCO	WSO	MAC
WRC	WBW	TBSW		MEC
WIC	WSW	TSTV		MHC
WEC	WNW	TSMV		MOC
WHC	WWP	TSLV		MGW
WOC		TOBW		MTW
WAM		WBO		MSW
WCM		WMO		MWL
WWW		WNO		
WEW				
Edge		Edge		Edge
N/A		N/A		N/A

## 3 Select a edge View edge details

## 4 Select hardware View hardware details

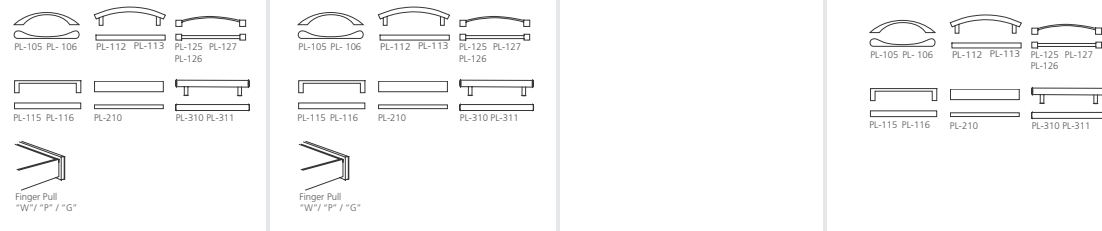

## Product features.

- Anti-tilt safety feature
- Finished all sides and top - open plan
- Full extension drawers - locking
- "W" & "G" SKUs feature soft close suspensions, "M" SKUs feature ball bearing suspensions. Both suspensions are full extension.

### NOTES

- Pedestal Cushion can be specified on all pedestals, but on Box/ Box/ File and File/File unit will not fit under work surface w/ cushion.

## Options.

### CUSHION

- BC16: Bench Cushion
- Specify fabric grade (1 yd. required)

### DRAWER

- P33: Wood Drawer Upgrade - \$45 per drawer
- WPD3061: Designer White - \$80 per pedestal

## BC16 Cushion fabric grades.

COM	COL	1	2	3
224	N/A	261	279	297
4	5	6	7	8
315	333	351	369	387
9	10	11/ L1	12	13/ L2
405	423	441	459	495

# Central park.

Modular Pedestals  
Undersurface Pedestal

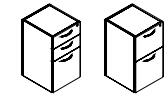

For use under 29"H work surfaces

## 1 Select a model w" x d" x h"

weight	Standard Veneer Top Standard Veneer Chassis		Premium Veneer Top Premium Veneer Chassis		High Pressure Laminate Top Veneer Chassis	Thermally Fused Laminate Top Thermally Fused Laminate Chassis	
	<b>Box/Box/File</b> 16 x 18 x 27	70	CPC1618PD440W 1114	CPC1618PD440P 1225	"G" Option N/A	CPC1618PD440M 858	
<b>File/File</b> 16 x 18 x 27	70	CPC1618PD441W 1114	CPC1618PD441P 1225	"G" Option N/A	CPC1618PD441M 858		

[View statement of line](#)

## 2 Select a finish [View finish details](#)

WAC	WGW	TBCO	WSO	MAC
WRC	WBW	TBSW		MEC
WIC	WSW	TSTV		MHC
WEC	WNW	TSMV		MOC
WHC	WWP	TSLV		MGW
WOC		TOBW		MTW
WAM		WBO		MSW
WCM		WMO		MWL
WWW		WNO		
WEW				

## 3 Select a edge [View edge details](#)

Edge	Edge	Edge
N/A	N/A	N/A

## 4 Select hardware [View hardware details](#)

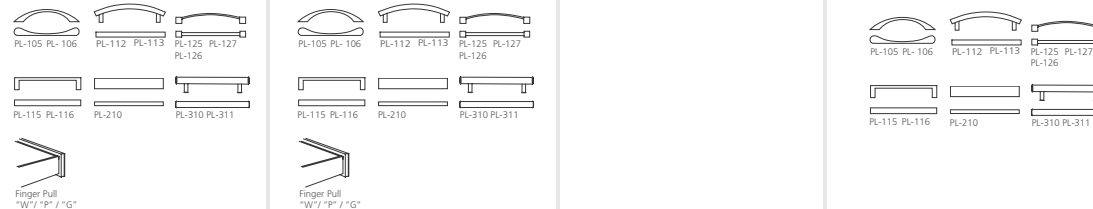

## Product features.

- Anti-tilt safety feature
- Finished all sides and top - open plan
- Full extension drawers - locking
- "W" & "G" SKUs feature soft close suspensions, "M" SKUs feature ball bearing suspensions. Both suspensions are full extension.

## Options.

### DRAWER

- P33: Wood Drawer Upgrade - \$45 per drawer
- WPD3061: Designer White - \$80 per pedestal

# Central park.

Pedestals

Undersurface Lateral File Pedestals

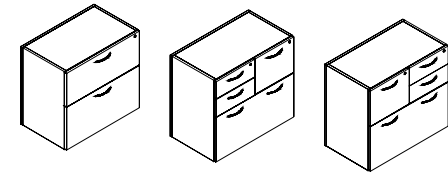

DARRAN

For use under 29"H work surfaces

*View statement of line*

1 Select a model w" x d" x h"	weight	Standard Veneer Top Standard Veneer Chassis		Premium Veneer Top Premium Veneer Chassis		High Pressure Laminate Top Veneer Chassis		Thermally Fused Laminate Top Thermally Fused Laminate Chassis	
		<p><b>2 Drawer Lateral File Pedestal</b></p> <p>29 x 18 x 27    135    CPC2918PD433W    1368    CPC2918PD433P    1505    "G" Option N/A    CPC2918PD433M    1072</p> <p><b>Box/Box/File - Lateral (Box/Box-Left)</b></p> <p>31 x 18 x 27    145    CPC3118PD443W    1446    CPC3118PD443P    1591    "G" Option N/A    CPC3118PD443M    1133</p> <p><b>Box/Box/File-Lateral (Box/Box-Right)</b></p> <p>31 x 18 x 27    145    CPC3118PD444W    1446    CPC3118PD444P    1591    "G" Option N/A    CPC3118PD444M    1133</p>							
2 Select a finish <i>View finish details</i>		WAC	WGW	TBCO	WSO			MAC	
		WRC	WBW	TBSW				MEC	
		WIC	WSW	TSTV				MHC	
		WEC	WNW	TSMV				MOC	
		WHC	WWP	TSLV				MGW	
		WOC		TOBW				MTW	
		WAM		WBO				MSW	
		WCM		WMO				MWL	
		WWW		WNO					
		WEW							
3 Select a edge <i>View edge details</i>		Edge		Edge			Edge		
		N/A		N/A			N/A		
4 Select hardware <i>View hardware details</i>		  		  		  		  	

## Product features.

- Anti-tilt safety feature
- Legal/Letter filing
- Finished all sides and top - open plan
- Full extension drawers - locking
- "W" & "G" SKUs feature soft close suspensions, "M" SKUs feature ball bearing suspensions. Both suspensions are full extension.

## Options.

### DRAWER





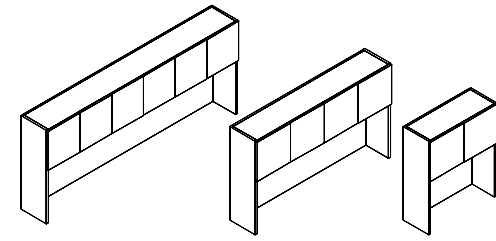

- P33: Wood Drawer Upgrade - \$45 per drawer
- WPD3061: Designer White - \$80 per pedestal

# Central park.

Single Storage Overhead Console  
14" D Panel Door - 2/4/6 Section



[View statement of line](#)

1 Select a model w" x d" x h"	weight	Standard Veneer Top		Premium Veneer Top		High Pressure Laminate Top		Thermally Fused Laminate Top	
		Standard Veneer Chassis		Premium Veneer Chassis		Veneer Chassis		Thermally Fused Laminate Chassis	
<b>6 Door / 3 Section</b>									
105 x 14 x 42	375	CPC10542OH325W	4046	CPC10542OH325P	4451	"G" Option N/A		"M" Option N/A	
99 x 14 x 42	345	CPC9942OH325W	3919	CPC9942OH325P	4311	"G" Option N/A		"M" Option N/A	
93 x 14 x 42	315	CPC9342OH325W	3307	CPC9342OH325P	3638	"G" Option N/A		CPC9342OH325M	2159
87 x 14 x 42	285	CPC8742OH325W	3123	CPC8742OH325P	3435	"G" Option N/A		CPC8742OH325M	2043
<b>4 Door / 2 Section</b>									
83 x 14 x 42	275	CPC8342OH325W	2995	CPC8342OH325P	3295	"G" Option N/A		CPC8342OH325M	1661
76 x 14 x 42	255	CPC7642OH325W	2772	CPC7642OH325P	3049	"G" Option N/A		CPC7642OH325M	1595
70 x 14 x 42	240	CPC7042OH325W	2562	CPC7042OH325P	2818	"G" Option N/A		CPC7042OH325M	1367
64 x 14 x 42	225	CPC6442OH325W	2537	CPC6442OH325P	2791	"G" Option N/A		CPC6442OH325M	1306
58 x 14 x 42	210	CPC5842OH325W	2479	CPC5842OH325P	2727	"G" Option N/A		CPC5842OH325M	1254
47 x 14 x 42	190	CPC4742OH325W	2416	CPC4742OH325P	2658	"G" Option N/A		CPC4742OH325M	1143
<b>2 Door / 1 Section</b>									
35 x 14 x 42	120	CPC3542OH325W	1792	CPC3542OH325P	1971	"G" Option N/A		CPC3542OH325M	1009
29 x 14 x 42	105	CPC2942OH325W	1765	CPC2942OH325P	1942	"G" Option N/A		CPC2942OH325M	976
<b>2 Select a finish</b> <a href="#">View finish details</a>		WAC	WGW	TBCO	WSO			MAC	
		WRC	WBW	TBSW				MEC	
		WIC	WSW	TSTV				MHC	
		WEC	WNW	TSMV				MOC	
		WHC	WWP	TSLV				MGW	
		WOC		TOBW				MTW	
		WAM		WBO				MSW	
		WCM		WMO				MWL	
		WWW		WNO					
		WEW							
<b>3 Select a edge</b> <a href="#">View edge details</a>		Edge		Edge				Edge	
		N/A		N/A				N/A	
<b>4 Select hardware</b> <a href="#">View hardware details</a>		 		 				 	
		Finger Pull "W"/"G"		Finger Pull "W"/"G"				Finger Pull "W"/"G"	

## Product features.

- Finished top
- Interior cabinet depth 12.5"
- Panel doors with concealed finger pull

### NOTES

- All units are standard w/ flush ends
- Unit has black back panel and is not designed for Open Plan use.  
Select OPB Option for Open Plan application

## Options.

### DOOR

- D2: Door Lock - \$100 per door set
- D6: Delete doors - n/c
- D9SC: Soft Close Door Hinges - \$20 per door
- RF375AW: Aluminum/White Glass - \$395 per door
- WPD3061: Designer White - \$80 per door

### GROMMETS (VERTICAL SURFACE)

- Standard Location - \$50 ea.
- Black Plastic Vertical Surface: TM50-C (Bottom Center)
- Non-Standard Location - \$95 ea.
- Black Plastic Vertical Surface: TM50-NS

### LEGAL DEPTH

- MLD1: Modify to legal depth 18" - 10% upcharge

### OPEN PLAN – FINISHED BACK

- OPB: "W" "G" Style - Modify Unit for Open Plan Application - \$310
- OPB: "M" Style - Modify Unit for Open Plan Application - \$100

### TASK LIGHTING (RECESSED)

- Overhead tasklight cord is located on the right facing side. If the opposite location is required please contact customer service.
- LT-LED24R: 24" LED Task light - \$190
- LT-LED48R: 48" LED Task light - \$245
- LT-LED60R: 60" LED Task light - \$310
- LT-LED72R: 72" LED Task light - \$335

# Central park.

Single Storage Overhead Console

14" D Silverluma Frame Doors / Frosted Inserts - 2/4/6 Section

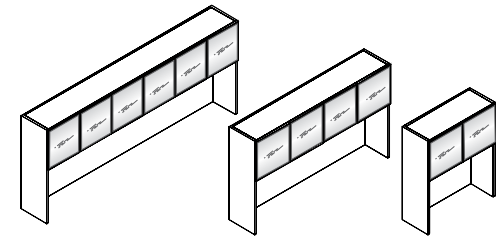

[View statement of line](#)

1 Select a model w" x d" x h"	weight	Standard Veneer Top		Premium Veneer Top		High Pressure Laminate Top		Thermally Fused Laminate Top	
		Standard Veneer Chassis		Premium Veneer Chassis		Veneer Chassis		Thermally Fused Laminate Chassis	
<b>6 Door / 3 Section</b>									
105 x 14 x 42	375	CPC10542OH321W	4811	CPC10542OH321P	5292	"G" Option N/A		"M" Option N/A	
99 x 14 x 42	345	CPC9942OH321W	4683	CPC9942OH321P	5151	"G" Option N/A		"M" Option N/A	
93 x 14 x 42	315	CPC9342OH321W	4072	CPC9342OH321P	4479	"G" Option N/A		CPC9342OH321M	2494
87 x 14 x 42	285	CPC8742OH321W	3888	CPC8742OH321P	4277	"G" Option N/A		CPC8742OH321M	2377
<b>4 Door / 2 Section</b>									
83 x 14 x 42	275	CPC8342OH321W	3506	CPC8342OH321P	3857	"G" Option N/A		CPC8342OH321M	1884
76 x 14 x 42	255	CPC7642OH321W	3281	CPC7642OH321P	3609	"G" Option N/A		CPC7642OH321M	1818
70 x 14 x 42	240	CPC7042OH321W	3071	CPC7042OH321P	3378	"G" Option N/A		CPC7042OH321M	1590
64 x 14 x 42	225	CPC6442OH321W	3047	CPC6442OH321P	3352	"G" Option N/A		CPC6442OH321M	1529
58 x 14 x 42	210	CPC5842OH321W	2989	CPC5842OH321P	3288	"G" Option N/A		CPC5842OH321M	1479
47 x 14 x 42	190	CPC4742OH321W	2924	CPC4742OH321P	3216	"G" Option N/A		CPC4742OH321M	1367
<b>2 Door / 1 Section</b>									
35 x 14 x 42	120	CPC3542OH321W	2034	CPC3542OH321P	2237	"G" Option N/A		CPC3542OH321M	1120
29 x 14 x 42	105	CPC2942OH321W	2008	CPC2942OH321P	2209	"G" Option N/A		CPC2942OH321M	1082
<b>2 Select a finish</b> <a href="#">View finish details</a>		WAC	WGW	TBCO	WSO			MAC	
		WRC	WBW	TBSW				MEC	
		WIC	WSW	TSTV				MHC	
		WEC	WNW	TSMV				MOC	
		WHC	WWP	TSLV				MGW	
		WOC		TOBW				MTW	
		WAM		WBO				MSW	
		WCM		WMO				MWL	
		WWM		WNO					
		WEW							
<b>3 Select a edge</b> <a href="#">View edge details</a>		Edge		Edge				Edge	
		N/A		N/A				N/A	
<b>4 Select hardware</b> <a href="#">View hardware details</a>		Hardware		Hardware				Hardware	
		N/A		N/A				N/A	

## Product features.

- Finished top
- Interior cabinet depth 12.5"
- SilverLuma frame doors with frosted inserts

### NOTES

- Unit has black back panel and is not designed for Open Plan use.
- Select OPB Option for Open Plan application

## Options.

### DOOR

- D2: Door Lock - \$100 per door set
- D9SC: Soft Close Door Hinges - \$20 per door
- DWF1: 2" Wood frame replaces SilverLuma Frame - n/c ("W" only)
- DWF2: 2" Wood frame w/ pull replaces SilverLuma Frame - \$20 per door ("W" only)

### GROMMETS (VERTICAL SURFACE)

- Standard Location - \$50 ea.
- Black Plastic Vertical Surface: TM50-C (Bottom Center)
- Non-Standard Location - \$95 ea.
- Black Plastic Vertical Surface: TM50-NS

### INTERIOR CABINET LIGHT

- LEDPK starter kit includes Infeed, 1 Puck Interior Light and the ability to daisy chain up to 6 total Puck Lights
- LEDPK: LED Puck Starter Kit - \$310
- PK: 1 LED Interior Light - \$130 ea.

### LEGAL DEPTH

- MLD1: Modify to legal depth 18" - 10% upcharge

### TASK LIGHTING (RECESSED)

- Overhead tasklight cord is located on the right facing side. If the opposite location is required please contact customer service.
- LT-LED24R: 24" LED Task light - \$190
- LT-LED48R: 48" LED Task light - \$245
- LT-LED60R: 60" LED Task light - \$310
- LT-LED72R: 72" LED Task light - \$335
- Open Plan - Finished Back
- OPB: "W" "G" Style - Modify Unit for Open Plan Application - \$295
- OPB: "M" Style - Modify Unit for Open Plan Application - \$95



# Central park.

Single Storage Overhead Console

14" D Open Storage Console - 2/3 Section

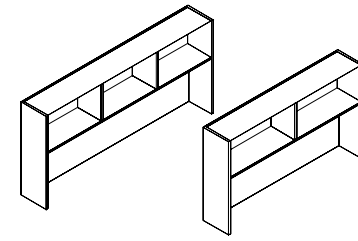

[View statement of line](#)

1 Select a model w" x d" x h"	weight	Standard Veneer Top Standard Veneer Chassis		Premium Veneer Top Premium Veneer Chassis		High Pressure Laminate Top Veneer Chassis		Thermally Fused Laminate Top Thermally Fused Laminate Chassis	
		<b>3 Section</b>							
105 x 14 x 42	355	CPC10542OH346W	3664	CPC10542OH346P	4030	"G" Option N/A		"M" Option N/A	
99 x 14 x 42	335	CPC9942OH346W	3537	CPC9942OH346P	3891	"G" Option N/A		"M" Option N/A	
93 x 14 x 42	310	CPC9342OH346W	2924	CPC9342OH346P	3216	"G" Option N/A		CPC9342OH346M	1874
87 x 14 x 42	280	CPC8742OH346W	2742	CPC8742OH346P	3016	"G" Option N/A		CPC8742OH346M	1757
83 x 14 x 42	265	CPC8342OH346W	2677	CPC8342OH346P	2945	"G" Option N/A		CPC8342OH346M	1372
76 x 14 x 42	250	CPC7642OH346W	2517	CPC7642OH346P	2769	"G" Option N/A		CPC7642OH346M	1310
<b>2 Section</b>									
70 x 14 x 42	240	CPC7042OH346W	2508	CPC7042OH346P	2759	"G" Option N/A		CPC7042OH346M	1434
64 x 14 x 42	225	CPC6442OH346W	2485	CPC6442OH346P	2734	"G" Option N/A		CPC6442OH346M	1376
58 x 14 x 42	205	CPC5842OH346W	2430	CPC5842OH346P	2673	"G" Option N/A		CPC5842OH346M	1328
<b>2 Select a finish</b> <a href="#">View finish details</a>		WAC	WGW	TBCO	WSO			MAC	
		WRC	WBW	TBSW				MEC	
		WIC	WSW	TSTV				MHC	
		WEC	WNW	TSMV				MOC	
		WHC	WWP	TSLV				MGW	
		WOC		TOBW				MTW	
		WAM		WBO				MSW	
		WCM		WMO				MWL	
		WWW		WNO					
		WEW							
<b>3 Select a edge</b> <a href="#">View edge details</a>		Edge		Edge				Edge	
		N/A		N/A				N/A	
<b>4 Select hardware</b> <a href="#">View hardware details</a>		Hardware		Hardware				Hardware	
		N/A		N/A				N/A	

## Product features.

- Finished top
- Interior cabinet depth 12.5"

### NOTES

- 2 section overhead available w/ 1 sliding door
- 3 Section Overhead Available w/ 1 or 2 Sliding Doors
- Unit has black back panel and is not designed for Open Plan use. Select OPB Option for Open Plan application

## Options.

### DOOR

- RF550AW: Aluminum/White Glass - \$575 per door
- SLD17WD: Panel Door ("W" only) - \$260 per door
- SLD17LD: White Laminate Door ("W" only) - \$205 per door
- SLD17FD: SilverLuma / Frost Door ("W", "M" only) - \$365 per door
- SLD17MD: Panel Door ("M" only) - \$160

### INTERIOR CABINET LIGHT

- LEDPK starter kit includes Infeed, 1 Puck Interior Light and the ability to daisy chain up to 6 total Puck Lights
- LEDPK: LED Puck Starter Kit - \$310
- PK: 1 LED Interior Light - \$130 ea.

### LEGAL DEPTH

- MLD1: Modify to legal depth 18" - 10% upcharge

### TASK LIGHTING (RECESSED)

Overhead tasklight cord is located on the right facing side. If the opposite location is required please contact customer service.

- LT-LED24R: 24" LED Task light - \$190
- LT-LED48R: 48" LED Task light - \$245
- LT-LED60R: 60" LED Task light - \$310
- LT-LED72R: 72" LED Task light - \$335

### OPEN PLAN – FINISHED BACK

- OPB: "W" "G" Style - Modify Unit for Open Plan Application - \$295
- OPB: "M" Style - Modify Unit for Open Plan Application - \$95

# Central park.

Double Storage Overhead Console  
14" D Panel Door - 2/4/6 Section

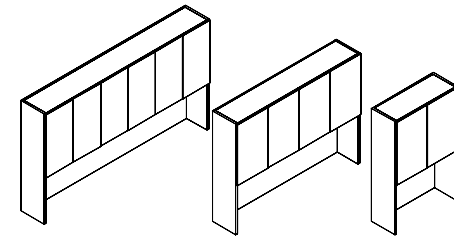

1 Select a model w" x d" x h"	weight	Standard Veneer Top Standard Veneer Chassis		Premium Veneer Top Premium Veneer Chassis		High Pressure Laminate Top Veneer Chassis		Thermally Fused Laminate Top Thermally Fused Laminate Chassis	
		<b>6 Door / 3 Section</b> 93 x 14 x 54 87 x 14 x 54 <b>4 Door / 2 Section</b> 70 x 14 x 54 64 x 14 x 54 58 x 14 x 54 <b>2 Door / 1 Section</b> 35 x 14 x 54 29 x 14 x 54	300 300 250 230 215 160 150	CPC9354OH325W CPC8754OH325W CPC7054OH325W CPC6454OH325W CPC5854OH325W CPC3554OH325W CPC2954OH325W	4072 3818 3218 3123 3059 2155 2129	CPC9354OH325P CPC8754OH325P CPC7054OH325P CPC6454OH325P CPC5854OH325P CPC3554OH325P CPC2954OH325P	4479 4200 3540 3435 3365 2371 2342	"G" Option N/A "G" Option N/A "G" Option N/A "G" Option N/A "G" Option N/A "G" Option N/A	CPC9354OH325M CPC8754OH325M CPC7054OH325M CPC6454OH325M CPC5854OH325M CPC3554OH325M CPC2954OH325M
<b>2 Select a finish</b> View finish details	WAC WRC WIC WEC WHC WOC WAM WCM WWM WEW	WGW WBW WSW WNW WWP	TBCO TBSW TSTV TSMV TSLV TOBW WBO WMO WNO	WSO	MAC MEC MHC MOC MGW MTW MSW MWL	Edge N/A	Edge N/A		
<b>3 Select an edge</b> View edge details	Edge N/A	Edge N/A	Edge N/A	Edge N/A	Edge N/A	Edge N/A	Edge N/A		
<b>4 Select hardware</b> View hardware details	Finger Pull "W"/"G"	Finger Pull "W"/"G"	Finger Pull "W"/"G"	Finger Pull "W"/"G"	Finger Pull "W"/"G"	Finger Pull "W"/"G"	Finger Pull "W"/"G"		

View statement of line

## Product features.

- Adjustable finished shelf behind each door section
- Black painted top
- Interior cabinet depth 12.5"
- Panel doors with concealed finger pull

### NOTES

- "M" Styles have matching "M" Finish Shelf
- Unit has black back panel and is not designed for Open Plan use. Select OPB Option for Open Plan application

## Options.

### ACCESSORIES

- D2: Door Lock - \$100 per door set
- D9SC: Soft Close Door Hinges - \$20 per door
- RF475AW: Aluminum/White Glass - \$495 per door
- WPD3061: Designer White - \$80 per door

### DOOR

- D6: Delete doors - n/c

### GROMMETS (VERTICAL SURFACE)

- Standard Location - \$50 ea.
- Black Plastic Vertical Surface: TM50-C (Bottom Center)
- Non-Standard Location - \$95 ea.
- Black Plastic Vertical Surface: TM50-NS

### LEGAL DEPTH

- MLD1: Modify to legal depth 18" - 10% upcharge

### OPEN PLAN – FINISHED BACK

- OPB: "W" "G" Style - Modify Unit for Open Plan Application - \$295
- OPB: "M" Style - Modify Unit for Open Plan Application - \$95
- Shelves
- S714F: Heavy Duty Lumber 1" Shelves - \$80 per shelf ("M" Styles - n/a)

### Task Lighting (Recessed)

Overhead tasklight cord is located on the right facing side. If the opposite location is required please contact customer service.

- LT-LED24R: 24" LED Task light - \$190
- LT-LED48R: 48" LED Task light - \$245
- LT-LED60R: 60" LED Task light - \$310
- LT-LED72R: 72" LED Task light - \$335

# Central park.

Double Storage Overhead Console

14" D SilverLuma Frame Doors / Frosted Inserts - 2/4/6 Section

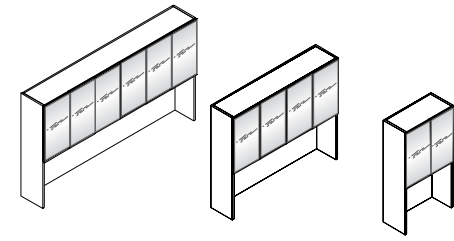

1 Select a model w" x d" x h"	weight	Standard Veneer Top		Premium Veneer Top		High Pressure Laminate Top		Thermally Fused Laminate Top	
		Standard Veneer Chassis		Premium Veneer Chassis		Veneer Chassis		Thermally Fused Laminate Chassis	
<b>6 Door / 3 Section</b>									
93 x 14 x 54	300	CPC9354OH321W	4836	CPC9354OH321P	5320	"G" Option N/A		CPC9354OH321M	3190
87 x 14 x 54	300	CPC8754OH321W	4582	CPC8754OH321P	5040	"G" Option N/A		CPC8754OH321M	3085
<b>4 Door / 2 Section</b>									
70 x 14 x 54	250	CPC7054OH321W	3728	CPC7054OH321P	4101	"G" Option N/A		CPC7054OH321M	2209
64 x 14 x 54	230	CPC6454OH321W	3633	CPC6454OH321P	3996	"G" Option N/A		CPC6454OH321M	2148
58 x 14 x 54	215	CPC5854OH321W	3568	CPC5854OH321P	3925	"G" Option N/A		CPC5854OH321M	1904
<b>2 Door / 1 Section</b>									
35 x 14 x 54	160	CPC3554OH321W	2398	CPC3554OH321P	2638	"G" Option N/A		CPC3554OH321M	1445
29 x 14 x 54	150	CPC2954OH321W	2372	CPC2954OH321P	2609	"G" Option N/A		CPC2954OH321M	1410
2 Select a finish <i>View finish details</i>		WAC	WGW	TBCO	WSO			MAC	
		WRC	WBW	TBSW				MEC	
		WIC	WSW	TSTV				MHC	
		WEC	WNW	TSMV				MOC	
		WHC	WWP	TSLV				MGW	
		WOC		TOBW				MTW	
		WAM		WBO				MSW	
		WCM		WMO				MWL	
		WWW		WNO					
		WEW							
3 Select a edge <i>View edge details</i>		Edge		Edge				Edge	
		N/A		N/A				N/A	
4 Select hardware <i>View hardware details</i>		Hardware		Hardware				Hardware	
		N/A		N/A				N/A	

[View statement of line](#)

## Product features.

- Adjustable finished shelf behind each door section
- Black painted top
- Interior cabinet depth 12.5"
- SilverLuma frame doors with frosted inserts

### NOTES

- "M" Styles have matching "M" Finish Shelf
- Unit has black back panel and is not designed for Open Plan use. Select OPB Option for Open Plan application

## Options.

### DOOR

- D2: Door Lock - \$100 per door set
- D9SC: Soft Close Door Hinges - \$20 per door
- DWF1: 2" Wood frame replaces SilverLuma Frame - n/c ("W" only)
- DWF2: 2" Wood frame w/ pull replaces SilverLuma Frame - \$20 per door ("W" only)

### GROMMETS (VERTICAL SURFACE)

- Standard Location - \$50 ea.
- Black Plastic Vertical Surface: TM50-C (Bottom Center)
- Non-Standard Location - \$95 ea.
- Black Plastic Vertical Surface: TM50-NS

### INTERIOR CABINET LIGHT

- LEDPK starter kit includes Infeed, 1 Puck Interior Light and the ability to daisy chain up to 6 total Puck Lights
- LEDPK: LED Puck Starter Kit - \$310
- PK: 1 LED Interior Light - \$130 ea.

### LEGAL DEPTH

- MLD1: Modify to legal depth 18" - 10% upcharge

### TASK LIGHTING (RECESSED)

Overhead tasklight cord is located on the right facing side. If the opposite location is required please contact customer service.

- LT-LED24R: 24" LED Task light - \$190
- LT-LED48R: 48" LED Task light - \$245
- LT-LED60R: 60" LED Task light - \$310
- LT-LED72R: 72" LED Task light - \$335

Open Plan – Finished Back

- OPB: "W" "G" Style - Modify Unit for Open Plan Application - \$295
- OPB: "M" Style - Modify Unit for Open Plan Application - \$95

Shelves

- GS14F: Replace Standard Shelves with Glass Shelves - \$90 per shelf
- S714F: Heavy Duty Lumber 1" Shelves - \$80 per shelf ("M" Styles - n/a)

## Central park tackboards.

Overhead tackboards  
Full width tackboards

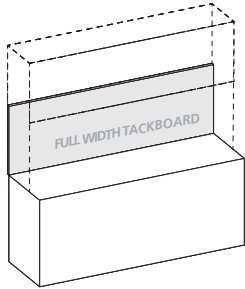

Product Width	Panel Dimension	SKU	COM	1	2	3	4	5	6	7	8	9	10	11/L1	12	13/L2
105"	103 x .5 x 21	FTOC10321	421	541	600	659	718	777	836	895	954	1013	1072	1131	1190	1308
99"	97 x .5 x 21	FTOC9721	399	510	565	620	675	730	785	840	895	950	1005	1060	1115	1225
93"	91 x .75 x 21	FTOC9121	379	480	531	582	633	684	735	786	837	888	939	990	1041	1143
87"	85 x .75 x 21	FTOC8521	358	449	497	545	593	641	689	737	785	833	881	929	977	1073
83"	81 x .75 x 21	FTOC8121	336	428	474	520	566	612	658	704	750	796	842	888	934	1026
76"	74 x .75 x 21	FTOC7421	309	392	435	478	521	564	607	650	693	736	779	822	865	951
70"	68 x .75 x 21	FTOC6821	282	361	401	441	481	521	561	601	641	681	721	761	801	881
64"	62 x .75 x 21	FTOC6221	256	330	366	402	438	474	510	546	582	618	654	690	726	798
58"	56 x .75 x 21	FTOC5621	234	299	331	363	395	427	459	491	523	555	587	619	651	715
47"	45 x .75 x 21	FTOC4521	187	242	269	296	323	350	377	404	431	458	485	512	539	593
35"	33 x .75 x 21	FTOC3321	141	180	200	220	240	260	280	300	320	340	360	380	400	440
29"	27 x .75 x 21	FTOC2721	112	149	166	183	200	217	234	251	268	285	302	319	336	370

Overhead tackboards  
Half width tackboards

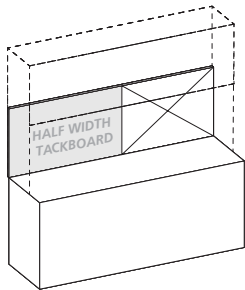

### Standard Features

- Constructed of .5" thick fiberboard
- Hung with Z-Strip mounting system

- Fabric is precisely aligned and fitted to the tackboard
- Adhered to the rigid hardboard with glue

Product Width	Panel Dimension	SKU	COM	1	2	3	4	5	6	7	8	9	10	11/L1	12	13/L2
105 Half Width	52.5 x .75 x 21	FTOC5221	211	271	301	331	361	391	421	451	481	511	541	571	601	661
99 Half Width	49.5 x .75 x 21	FTOC4921	200	256	284	312	340	368	396	424	452	480	508	536	564	620
93 Half Width	46.5 x .75 x 21	FTOC4621	189	240	266	292	318	344	370	396	422	448	474	500	526	578
87 Half Width	43.5 x .75 x 21	FTOC4321	179	225	249	273	297	321	345	369	393	417	441	465	489	537
83 Half Width	41.5 x .75 x 21	FTOC4121	168	214	237	260	283	306	329	352	375	398	421	444	467	513
76 Half Width	38 x .75 x 21	FTOC3821	155	196	217	238	259	280	301	322	343	364	385	406	427	469
70 Half Width	35 x .75 x 21	FTOC3521	141	180	200	220	240	260	280	300	320	340	360	380	400	440
64 Half Width	32 x .75 x 21	FTOC3221	128	165	183	201	219	237	255	273	291	309	327	345	363	399

### Standard Features

- Constructed of .5" thick fiberboard
- Fabric is precisely aligned and fitted to the tackboard
- Adhered to the rigid hardboard with glue
- Hung with Z-Strip mounting system

### Notes

- Half width tackboards can be specified and combined with Marker Board, Slat Wall and Glass Board options. See "Half Width" items under product width.
- Must specify right or left facing tackboard

## Central park tackboards.

Overhead dry marker board  
Full width dry marker boards

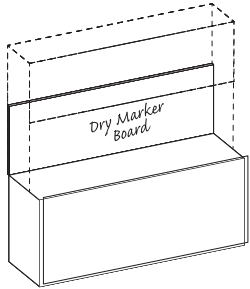

Product Width	Panel Dimension	SKU	List
105"	103 x .5 x 21	DMOC10321	1285
99"	97 x .5 x 21	DMOC9721	1211
93"	91 x .5 x 21	DMOC9121	1136
87"	85 x .5 x 21	DMOC8521	1061
83"	81 x .5 x 21	DMOC8121	1011
76"	74 x .5 x 21	DMOC7421	924
70"	68 x .5 x 21	DMOC6821	849
64"	62 x .5 x 21	DMOC6221	774
58"	56 x .5 x 21	DMOC5621	699
47"	45 x .5 x 21	DMOC4521	587
35"	33 x .5 x 21	DMOC3321	437
29"	27 x .5 x 21	DMOC2721	337

Overhead dry marker board  
Half width dry marker boards

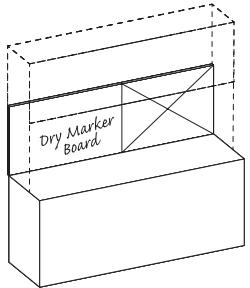

### Standard Features

- Dry marker panel has edge trim molding
- Standard magnetic surface
- Hung with Z-Strip mounting system

Product Width	Panel Dimension	SKU	List
105 Half Width	51.5 x .5 x 21	DMOC5121	655
99 Half Width	48.5 x .5 x 21	DMOC4821	618
93 Half Width	45.5 x .5 x 21	DMOC4521	555
87 Half Width	42.5 x .5 x 21	DMOC4221	518
83 Half Width	40.5 x .5 x 21	DMOC4021	493
76 Half Width	37 x .5 x 21	DMOC3721	449
70 Half Width	34 x .5 x 21	DMOC3421	437
64 Half Width	31 x .5 x 21	DMOC3121	374

### Standard Features

- Dry marker panel has edge trim molding
- Standard magnetic surface
- Hung with Z-Strip mounting system

### Notes

- Half width dry marker boards can be specified and combined with a Tackboard, Veneer Panel, Slat Wall or Glass Board. See "Half Width" items under product width.
- Specify right or left facing dry marker board

## Central park tackboards.

Overhead glassboard  
Full width glassboards

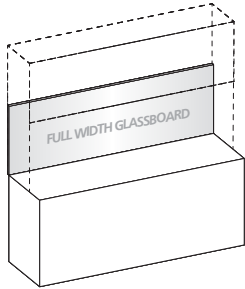

Product Width	Panel Dimension	SKU	List
105"	103 x .5 x 21	GBOC10321	2673
99"	97 x .5 x 21	GBOC9721	2527
93"	91 x .5 x 21	GBOC9121	2382
87"	85 x .5 x 21	GBOC8521	2236
83"	81 x .5 x 21	GBOC8121	2138
76"	74 x .5 x 21	GBOC7421	1969
70"	68 x .5 x 21	GBOC6821	1822
64"	62 x .5 x 21	GBOC6221	1676
58"	56 x .5 x 21	GBOC5621	1531
47"	45 x .5 x 21	GBOC4521	1264
35"	33 x .5 x 21	GBOC3321	972
29"	27 x .5 x 21	GBOC2721	826

### Standard Features

- 4 mm tempered glass
- Hung with Z-Strip mounting system

### Notes

- Standard dry erase markers may be used
- Earth magnets are required to hold items securely in place
- Use glass cleaner or alcohol to clean

Overhead glassboard  
Half width glassboards

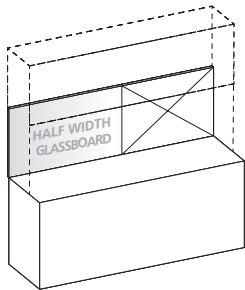

Product Width	Panel Dimension	SKU	List
105 Half Width	51.5 x .5 x 21	GBOC5121	1397
99 Half Width	48.5 x .5 x 21	GBOC4821	1324
93 Half Width	45.5 x .5 x 21	GBOC4521	1251
87 Half Width	42.5 x .5 x 21	GBOC4221	1178
83 Half Width	40.5 x .5 x 21	GBOC4021	1129
76 Half Width	37 x .5 x 21	GBOC3721	985
70 Half Width	34 x .5 x 21	GBOC3421	972
64 Half Width	31 x .5 x 21	GBOC3121	899

### Standard Features

- 4 mm tempered glass
- Hung with Z-Strip mounting system

### Notes

- Half width glassboards can be specified and combined with a Tackboard, Veneer panel, Marker Board or Slat Wall. See "Half Width" items under product width.
- Specify right or left facing glassboard
- Use glass cleaner or alcohol to clean
- Standard dry erase markers may be used
- Earth magnets are required to hold items securely in place

## Central park tackboards.

Overhead slat wall  
*Half width slat wall*

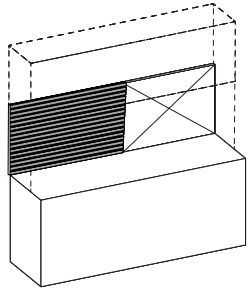

Product Width	Panel Dimension	SKU	List
105 Half Width	52.5 x .5 x 21	SWOC5221	546
99 Half Width	49.5 x .5 x 21	SWOC4921	515
93 Half Width	44.5 x .5 x 21	SWOC4421	463
87 Half Width	41.5 x .5 x 21	SWOC4121	432
83 Half Width	39.5 x .5 x 21	SWOC3921	411
76 Half Width	36 x .5 x 21	SWOC3621	374
70 Half Width	33 x .5 x 21	SWOC3321	343
64 Half Width	30 x .5 x 21	SWOC3021	312

### Standard Features

- Available in silver or black
- Hung with Z-Strip mounting system

### Notes

- Half width slat walls can be specified and combined with a Tackboard, Veneer panel, Marker Board or Glassboard. See "Half Width" items under product width.
- Must specify right or left facing slat wall

# Central park.

Single Height Wall Hung Overheads  
14" D Panel Doors - 1/2/3 Section

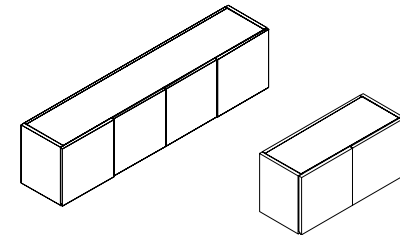

## 1 Select a model

w" x d" x h"

weight	Standard Veneer Top		Premium Veneer Top		High Pressure Laminate Top		Thermally Fused Laminate Top	
	Standard Veneer Chassis		Premium Veneer Chassis		Veneer Chassis		Thermally Fused Laminate Chassis	
<b>6 Door / 3 Section</b>								
105 x 14 x 18	275	CPC10518WH330W 3543	CPC10518WH330P 3897	"G" Option N/A	"M" Option N/A			
99 x 14 x 18	255	CPC9918WH330W 3414	CPC9918WH330P 3755	"G" Option N/A	"M" Option N/A			
93 x 14 x 18	240	CPC9318WH330W 3347	CPC9318WH330P 3682	"G" Option N/A	CPC9318WH330M 2128			
87 x 14 x 18	225	CPC8718WH330W 3217	CPC8718WH330P 3539	"G" Option N/A	CPC8718WH330M 2011			
<b>4 Door / 2 Section</b>								
83 x 14 x 18	210	CPC8318WH330W 3144	CPC8318WH330P 3458	"G" Option N/A	CPC8318WH330M 1585			
76 x 14 x 18	195	CPC7618WH330W 3088	CPC7618WH330P 3397	"G" Option N/A	CPC7618WH330M 1467			
70 x 14 x 18	180	CPC7018WH330W 2581	CPC7018WH330P 2839	"G" Option N/A	CPC7018WH330M 1356			
64 x 14 x 18	160	CPC6418WH330W 2542	CPC6418WH330P 2796	"G" Option N/A	CPC6418WH330M 1316			
58 x 14 x 18	135	CPC5818WH330W 2503	CPC5818WH330P 2753	"G" Option N/A	CPC5818WH330M 1275			
47 x 14 x 18	125	CPC4718WH330W 1913	CPC4718WH330P 2104	"G" Option N/A	CPC4718WH330M 1215			
<b>2 Door / 1 Section</b>								
35 x 14 x 18	75	CPC3518WH330W 1435	CPC3518WH330P 1579	"G" Option N/A	CPC3518WH330M 864			
29 x 14 x 18	65	CPC2918WH330W 1412	CPC2918WH330P 1553	"G" Option N/A	CPC2918WH330M 828			

View statement of line

## 2 Select a finish

View finish details

WAC	WGW	TBCO	WSO
WRC	WBW	TBSW	
WIC	WSW	TSTV	
WEC	WNW	TSMV	
WHC	WWP	TSLV	
WOC		TOBW	
WAM		WBO	
WCM		WMO	
WWW		WNO	
WEW			
Edge		Edge	
N/A		N/A	

## 3 Select a edge

View edge details

## 4 Select hardware

View hardware details



## Product features.

- Doors fully matched set
- Finished top
- Interior cabinet depth 12"
- Mounting wall rail included
- Panel doors with concealed finger pull

### NOTES

- All units are standard w/ flush ends
- Proper installation is critical to ensure safety from possible falling cabinets. The factory assumes no liability for damage or injury from the following: installation into non-load bearing or unlevel walls. Improper fasteners used in installation. Overloading of cabinets resulting in failures of wall and surrounding structures, fasteners, or cabinet construction. Misuse of cabinets for intended purposes.

## Options.

### DOOR

- D2: Door Lock - \$100 per door set
- D6: Delete doors - n/c
- D9SC: Soft Close Door Hinges - \$20 per door
- RF375AW: Aluminum/White Glass - \$395 per door
- WPD3061: Designer White - \$80 per door

### LEGAL DEPTH

- MLD1: Modify to legal depth 18" - 10% upcharge

### TASK LIGHTING (RECESSED)

Overhead tasklight cord is located on the right facing side. If the opposite location is required please contact customer service.

- LT-LED24R: 24" LED Task light - \$190
- LT-LED48R: 48" LED Task light - \$245
- LT-LED60R: 60" LED Task light - \$310
- LT-LED72R: 72" LED Task light - \$335
- LC24: Linking Task light cable - \$25



# Central park.

Single Height Wall Hung Overheads

14" D Silverluma Frame / Frosted Doors - 1/2/3 Section

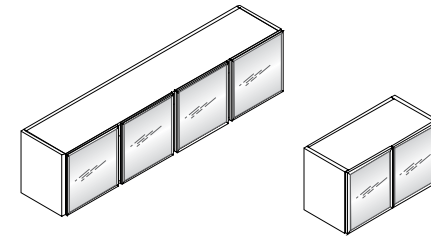

1 Select a model w" x d" x h"	weight	Standard Veneer Top		Premium Veneer Top		High Pressure Laminate Top		Thermally Fused Laminate Top	
		Standard Veneer Chassis		Premium Veneer Chassis		Veneer Chassis		Thermally Fused Laminate Chassis	
<b>6 Door / 3 Section</b>									
105 x 14 x 18	275	CPC10518WH331W	4078	CPC10518WH331P	4486	"G" Option N/A		"M" Option N/A	
99 x 14 x 18	255	CPC9918WH331W	3886	CPC9918WH331P	4275	"G" Option N/A		"M" Option N/A	
93 x 14 x 18	240	CPC9318WH331W	3785	CPC9318WH331P	4164	"G" Option N/A		CPC9318WH331M	2498
87 x 14 x 18	225	CPC8718WH331W	3712	CPC8718WH331P	4083	"G" Option N/A		CPC8718WH331M	2382
<b>4 Door / 2 Section</b>									
83 x 14 x 18	210	CPC8318WH331W	3633	CPC8318WH331P	3996	"G" Option N/A		CPC8318WH331M	1834
76 x 14 x 18	195	CPC7618WH331W	3583	CPC7618WH331P	3941	"G" Option N/A		CPC7618WH331M	1717
70 x 14 x 18	180	CPC7018WH331W	2992	CPC7018WH331P	3291	"G" Option N/A		CPC7018WH331M	1600
64 x 14 x 18	160	CPC6418WH331W	2897	CPC6418WH331P	3187	"G" Option N/A		CPC6418WH331M	1559
58 x 14 x 18	135	CPC5818WH331W	2807	CPC5818WH331P	3088	"G" Option N/A		CPC5818WH331M	1519
47 x 14 x 18	125	CPC4718WH331W	2147	CPC4718WH331P	2362	"G" Option N/A		CPC4718WH331M	1463
<b>2 Door / 1 Section</b>									
35 x 14 x 18	75	CPC3518WH331W	1637	CPC3518WH331P	1801	"G" Option N/A		CPC3518WH331M	965
29 x 14 x 18	65	CPC2918WH331W	1564	CPC2918WH331P	1720	"G" Option N/A		CPC2918WH331M	930
<b>2 Select a finish</b> <i>View finish details</i>		WAC	WGW	TBCO	WSO			MAC	
		WRC	WBW	TBSW				MEC	
		WIC	WSW	TSTV				MHC	
		WEC	WNW	TSMV				MOC	
		WHC	WWP	TSLV				MGW	
		WOC		TOBW				MTW	
		WAM		WBO				MSW	
		WCM		WMO				MWL	
		WWW		WNO					
		WEW							
<b>3 Select a edge</b> <i>View edge details</i>		Edge		Edge				Edge	
		N/A		N/A				N/A	
<b>4 Select hardware</b> <i>View hardware details</i>		Hardware		Hardware				Hardware	
		N/A		N/A				N/A	

View statement of line

## Product features.

- Finished top
- Interior cabinet depth 12"
- Mounting wall rail included

### NOTES

- All units are standard w/ flush ends
- Proper installation is critical to ensure safety from possible falling cabinets. The factory assumes no liability for damage or injury from the following: installation into non-load bearing or unlevel walls. Improper fasteners used in installation. Overloading of cabinets resulting in failures of wall and surrounding structures, fasteners, or cabinet construction. Misuse of cabinets for intended purposes.

## Options.

### DOOR

- D2: Door Lock - \$100 per door set
- D9SC: Soft Close Door Hinges - \$20 per door
- DWF1: 2" Wood frame replaces SilverLuma Frame - n/c ("W" only)
- DWF2: 2" Wood frame w/ pull replaces SilverLuma Frame - \$20 per door ("W" only)

### INTERIOR CABINET LIGHT

- LEDPK starter kit includes Infeed, 1 Puck Interior Light and the ability to daisy chain up to 6 total Puck Lights
- LEDPK: LED Puck Starter Kit - \$310
- PK: 1 LED Interior Light - \$130 ea.

### LEGAL DEPTH

- MLD1: Modify to legal depth 18" - 10% upcharge

### TASK LIGHTING (RECESSED)

- Overhead tasklight cord is located on the right facing side. If the opposite location is required please contact customer service.
- LT-LED24R: 24" LED Task light - \$190
- LT-LED48R: 48" LED Task light - \$245
- LT-LED60R: 60" LED Task light - \$310
- LT-LED72R: 72" LED Task light - \$335
- LC24: Linking Task light cable - \$25

# Central park.

Single Height Wall Hung Overheads

14" D Open Storage Cabinet - 1/2/3 Section

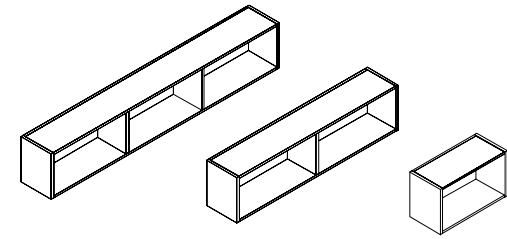

[View statement of line](#)

1 Select a model w" x d" x h"	weight	Standard Veneer Top Standard Veneer Chassis		Premium Veneer Top Premium Veneer Chassis		High Pressure Laminate Top Veneer Chassis		Thermally Fused Laminate Top Thermally Fused Laminate Chassis																																																													
		<p><b>3 Section</b></p> <p>105 x 14 x 18 260 CPC10518WH332W 3256 CPC10518WH332P 3582 "G" Option N/A "M" Option N/A</p> <p>99 x 14 x 18 240 CPC9918WH332W 3122 CPC9918WH332P 3434 "G" Option N/A "M" Option N/A</p> <p>93 x 14 x 18 225 CPC9318WH332W 3083 CPC9318WH332P 3391 "G" Option N/A CPC9318WH332M 1803</p> <p>87 x 14 x 18 210 CPC8718WH332W 3054 CPC8718WH332P 3359 "G" Option N/A CPC8718WH332M 1691</p> <p>83 x 14 x 18 200 CPC8318WH332W 3026 CPC8318WH332P 3329 "G" Option N/A CPC8318WH332M 1270</p> <p>76 x 14 x 18 185 CPC7618WH332W 2992 CPC7618WH332P 3291 "G" Option N/A CPC7618WH332M 1204</p> <p><b>2 Section</b></p> <p>70 x 14 x 18 170 CPC7018WH332W 2447 CPC7018WH332P 2692 "G" Option N/A CPC7018WH332M 1138</p> <p>64 x 14 x 18 150 CPC6418WH332W 2408 CPC6418WH332P 2649 "G" Option N/A CPC6418WH332M 1103</p> <p>58 x 14 x 18 125 CPC5818WH332W 2374 CPC5818WH332P 2611 "G" Option N/A CPC5818WH332M 1062</p> <p>47 x 14 x 18 115 CPC4718WH332W 1772 CPC4718WH332P 1949 "G" Option N/A CPC4718WH332M 1002</p> <p><b>1 Section</b></p> <p>35 x 14 x 18 60 CPC3518WH332W 1333 CPC3518WH332P 1466 "G" Option N/A CPC3518WH332M 747</p> <p>29 x 14 x 18 50 CPC2918WH332W 1317 CPC2918WH332P 1449 "G" Option N/A CPC2918WH332M 711</p>																																																																			
<p><b>2 Select a finish</b> <a href="#">View finish details</a></p> <table border="0"> <tr> <td>WAC</td><td>WGW</td><td>TBCO</td><td>WSO</td><td>MAC</td><td></td></tr> <tr> <td>WRC</td><td>WBW</td><td>TBSW</td><td></td><td>MEC</td><td></td></tr> <tr> <td>WIC</td><td>WSW</td><td>TSTV</td><td></td><td>MHC</td><td></td></tr> <tr> <td>WEC</td><td>WNW</td><td>TSMV</td><td></td><td>MOC</td><td></td></tr> <tr> <td>WHC</td><td>WWP</td><td>TSLV</td><td></td><td>MGW</td><td></td></tr> <tr> <td>WOC</td><td></td><td>TOBW</td><td></td><td>MTW</td><td></td></tr> <tr> <td>WAM</td><td></td><td>WBO</td><td></td><td>MSW</td><td></td></tr> <tr> <td>WCM</td><td></td><td>WMO</td><td></td><td>MWL</td><td></td></tr> <tr> <td>WWM</td><td></td><td>WNO</td><td></td><td></td><td></td></tr> <tr> <td>WEW</td><td></td><td></td><td></td><td></td><td></td></tr> </table>										WAC	WGW	TBCO	WSO	MAC		WRC	WBW	TBSW		MEC		WIC	WSW	TSTV		MHC		WEC	WNW	TSMV		MOC		WHC	WWP	TSLV		MGW		WOC		TOBW		MTW		WAM		WBO		MSW		WCM		WMO		MWL		WWM		WNO				WEW					
WAC	WGW	TBCO	WSO	MAC																																																																	
WRC	WBW	TBSW		MEC																																																																	
WIC	WSW	TSTV		MHC																																																																	
WEC	WNW	TSMV		MOC																																																																	
WHC	WWP	TSLV		MGW																																																																	
WOC		TOBW		MTW																																																																	
WAM		WBO		MSW																																																																	
WCM		WMO		MWL																																																																	
WWM		WNO																																																																			
WEW																																																																					
<p><b>3 Select a edge</b> <a href="#">View edge details</a></p> <table border="0"> <tr> <td>Edge</td><td></td><td>Edge</td><td></td><td>Edge</td><td></td></tr> <tr> <td>N/A</td><td></td><td>N/A</td><td></td><td>N/A</td><td></td></tr> </table>										Edge		Edge		Edge		N/A		N/A		N/A																																																	
Edge		Edge		Edge																																																																	
N/A		N/A		N/A																																																																	
<p><b>4 Select hardware</b> <a href="#">View hardware details</a></p> <table border="0"> <tr> <td>Hardware</td><td></td><td>Hardware</td><td></td><td>Hardware</td><td></td></tr> <tr> <td>N/A</td><td></td><td>N/A</td><td></td><td>N/A</td><td></td></tr> </table>										Hardware		Hardware		Hardware		N/A		N/A		N/A																																																	
Hardware		Hardware		Hardware																																																																	
N/A		N/A		N/A																																																																	

## Product features.

- Finished top
- Interior cabinet depth 12"
- Mounting wall rail included

### NOTES

- 3 Section Overhead Available w/ 1 or 2 Sliding Doors
- 2 Section available w/ 1 sliding door
- All units are standard w/ flush ends
- Proper installation is critical to ensure safety from possible falling cabinets. The factory assumes no liability for damage or injury from The following: installation into non-load bearing or unlevel walls. Im-proper fasteners used in installation. Overloading of cabinets resulting in failures of wall and surrounding structures, fasteners, or cabinet construction. Misuse of cabinets for intended purposes.

## Options.

### DOOR

- Not available in 29" and 35"
- RF550AW: Aluminum/White Glass - \$575 per door
- SLD17WD: Panel Door ("W" only) - \$250 per door
- SLD17LD: White Laminate Door ("W" only) - \$205 per door
- SLD17FD: SilverLuma / Frost Door ("W", "M" only) - \$365 per door
- SLD17MD: Panel Door ("M" only) - \$160

### INTERIOR CABINET LIGHT

- LEDPK starter kit includes Infeed, 1 Puck Interior Light and the ability to daisy chain up to 6 total Puck Lights
- LEDPK: LED Puck Starter Kit - \$310
- PK: 1 LED Interior Light - \$130 ea.

### LEGAL DEPTH

- MLD1: Modify to legal depth 18" - 10% upcharge

### TASK LIGHTING (RECESSED)

- Overhead tasklight cord is located on the right facing side. If the oppo-site location is required please contact customer service.
- LT-LED24R: 24" LED Task light - \$190
- LT-LED48R: 48" LED Task light - \$245
- LT-LED60R: 60" LED Task light - \$310
- LT-LED72R: 72" LED Task light - \$335
- LC24: Linking Task light cable - \$25

# Central park.

Double Height Wall Hung Overheads  
14" D Panel Doors - 2/4/6 Section

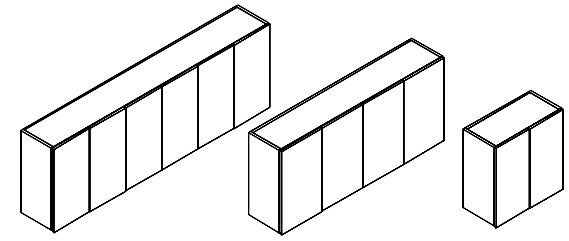

## 1 Select a model w" x d" x h"

weight	Standard Veneer Top		Premium Veneer Top		High Pressure Laminate Top		Thermally Fused Laminate Top	
	Standard Veneer Chassis		Premium Veneer Chassis		Veneer Chassis		Thermally Fused Laminate Chassis	
<b>6 Door / 3 Section</b>								
93 x 14 x 29	265	CPC9329WH330W 3892	CPC9329WH330P 4281		"G" Option N/A		CPC9329WH330M 2616	
87 x 14 x 29	220	CPC8729WH330W 3830	CPC8729WH330P 4213		"G" Option N/A		CPC8729WH330M 2498	
<b>4 Door / 2 Section</b>								
70 x 14 x 29	220	CPC7029WH330W 3183	CPC7029WH330P 3501		"G" Option N/A		CPC7029WH330M 1752	
64 x 14 x 29	200	CPC6429WH330W 3156	CPC6429WH330P 3472		"G" Option N/A		CPC6429WH330M 1717	
58 x 14 x 29	180	CPC5829WH330W 3094	CPC5829WH330P 3403		"G" Option N/A		CPC5829WH330M 1645	
<b>2 Door / 1 Section</b>								
35 x 14 x 29	85	CPC3529WH330W 1671	CPC3529WH330P 1838		"G" Option N/A		CPC3529WH330M 1178	
29 x 14 x 29	75	CPC2929WH330W 1632	CPC2929WH330P 1795		"G" Option N/A		CPC2929WH330M 1143	

*View statement of line*

## 2 Select a finish *View finish details*

WAC	WGW	TBCO	WSO	MAC
WRC	WBW	TBSW		MEC
WIC	WSW	TSTV		MHC
WEC	WNW	TSMV		MOC
WHC	WWP	TSLV		MGW
WOC		TOBW		MTW
WAM		WBO		MSW
WCM		WMO		MWL
WWW		WNO		
WEW				
Edge		Edge		Edge
N/A		N/A		N/A

## 3 Select a edge *View edge details*

## 4 Select hardware *View hardware details*



## Product features.

- Adjustable finished shelf behind each door section
- Black painted top
- Doors fully matched set
- Interior cabinet depth 12"
- Mounting wall rail included

### NOTES

- "M" Styles have matching "M" Finish Shelf
- Proper installation is critical to ensure safety from possible falling cabinets. The factory assumes no liability for damage or injury from The following: installation into non-load bearing or unlevel walls. Improper fasteners used in installation. Overloading of cabinets resulting in failures of wall and surrounding structures, fasteners, or cabinet construction. Misuse of cabinets for intended purposes.

## Options.

### DOOR

- D2: Door Lock - \$100 per door set
- D9SC: Soft Close Door Hinges - \$20 per door
- RF475AW: Aluminum/White Glass - \$495 per door
- WPD3061: Designer White - \$80 per door

### LEGAL DEPTH

- MLD1: Modify to legal depth 18" - 10% upcharge

### SHELVES

- S714F: Heavy Duty Lumber 1" Shelves - \$80 per shelf ("M" Styles - n/a)

### TASK LIGHTING (RECESSED)

- Overhead tasklight cord is located on the right facing side. If the opposite location is required please contact customer service.
- LT-LED24R: 24" LED Task light - \$190
  - LT-LED48R: 48" LED Task light - \$245
  - LT-LED60R: 60" LED Task light - \$310
  - LT-LED72R: 72" LED Task light - \$335
  - LC24: Linking Task light cable - \$25

# Central park.

Double Height Wall Hung Overheads

14" D Silverluma Frame / Frosted Doors - 2/4/6 Section

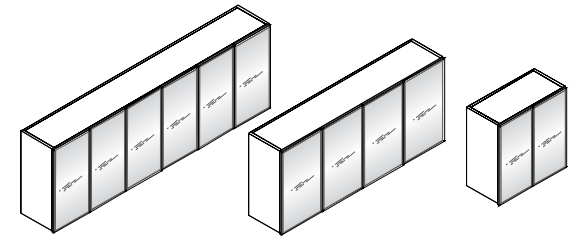

[View statement of line](#)

1 Select a model w" x d" x h"	weight	Standard Veneer Top Standard Veneer Chassis		Premium Veneer Top Premium Veneer Chassis		High Pressure Laminate Top Veneer Chassis		Thermally Fused Laminate Top Thermally Fused Laminate Chassis	
		<b>6 Door / 3 Section</b> 93 x 14 x 29 87 x 14 x 29 <b>4 Door / 2 Section</b> 70 x 14 x 29 64 x 14 x 29 58 x 14 x 29 <b>2 Door / 1 Section</b> 35 x 14 x 29 29 x 14 x 29	265 250 220 200 180 85 75	CPC9329WH331W CPC8729WH331W CPC7029WH331W CPC6429WH331W CPC5829WH331W CPC3529WH331W CPC2929WH331W	4809 4663 3819 3718 3572 2025 1913	CPC9329WH331P CPC8729WH331P CPC7029WH331P CPC6429WH331P CPC5829WH331P CPC3529WH331P CPC2929WH331P	5290 5129 4201 4090 3929 2228 2104	"G" Option N/A "G" Option N/A "G" Option N/A "G" Option N/A "G" Option N/A "G" Option N/A "G" Option N/A	CPC9329WH331M CPC8729WH331M CPC7029WH331M CPC6429WH331M CPC5829WH331M CPC3529WH331M CPC2929WH331M
2 Select a finish <a href="#">View finish details</a>	WAC WRC WIC WEC WHC WOC WAM WCM WWM WEW	WGW WBW WSW WNW WWP	TBCO TBSW TSTV TSMV TSLV TOBW WBO WMO WNO	WSO	MAC MEC MHC MOC MGW MTW MSW MWL	Edge N/A	Edge N/A	Hardware N/A	Hardware N/A
3 Select an edge <a href="#">View edge details</a>	Edge N/A	Edge N/A	Edge N/A	Edge N/A	Edge N/A	Edge N/A	Edge N/A	Hardware N/A	Hardware N/A
4 Select hardware <a href="#">View hardware details</a>	Hardware N/A	Hardware N/A	Hardware N/A	Hardware N/A	Hardware N/A	Hardware N/A	Hardware N/A	Hardware N/A	Hardware N/A

## Product features.

- Adjustable finished shelf behind each door section
- Black painted top
- Interior cabinet depth 12"
- Mounting wall rail included

### NOTES

- Proper installation is critical to ensure safety from possible falling cabinets. The factory assumes no liability for damage or injury from the following: installation into non-load bearing or unlevel walls. Improper fasteners used in installation. Overloading of cabinets resulting in failures of wall and surrounding structures, fasteners, or cabinet construction. Misuse of cabinets for intended purposes.

## Options.

### DOOR

- D2: Door Lock - \$100 per door set
- D9SC: Soft Close Door Hinges - \$20 per door
- DWF1: 2" Wood frame replaces SilverLuma Frame - n/c ("W" only)
- DWF2: 2" Wood frame w/ pull replaces SilverLuma Frame - \$20 per door ("W" only)

### INTERIOR CABINET LIGHT

LEDPK starter kit includes Infeed, 1 Puck Interior Light and the ability to daisy chain up to 6 total Puck Lights

- LEDPK: LED Puck Starter Kit - \$310
- PK: 1 LED Interior Light - \$130 ea.

### LEGAL DEPTH

- MLD1: Modify to legal depth 18" - 10% upcharge

### TASK LIGHTING (RECESSED)

Overhead tasklight cord is located on the right facing side. If the opposite location is required please contact customer service.

- LT-LED24R: 24" LED Task light - \$190
- LT-LED48R: 48" LED Task light - \$245
- LT-LED60R: 60" LED Task light - \$310
- LT-LED72R: 72" LED Task light - \$335
- LC24: Linking Task light cable - \$25

### SHELVES

- GS14F: Replace Standard Shelves with Glass Shelves - \$90 per shelf
- S714F: Heavy Duty Lumber 1" Shelves - \$80 per shelf ("M" Styles - n/a)

# Central park.

Double Height Wall Hung Overheads

14" D Open Storage Cabinet - 1/2/3 Section

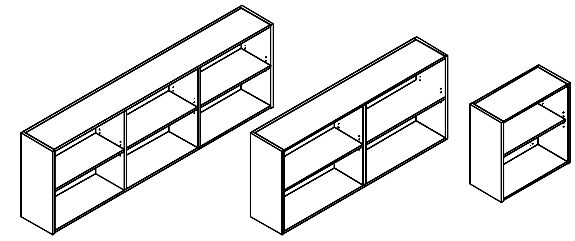

1 Select a model w" x d" x h"	weight	Standard Veneer Top Standard Veneer Chassis		Premium Veneer Top Premium Veneer Chassis		High Pressure Laminate Top Veneer Chassis		Thermally Fused Laminate Top Thermally Fused Laminate Chassis	
		<b>3 Section</b> 93 x 14 x 29 87 x 14 x 29 <b>2 Section</b> 70 x 14 x 29 64 x 14 x 29 58 x 14 x 29 <b>1 Section</b> 35 x 14 x 29 29 x 14 x 29							
		205	CPC9329WH332W 3520	3872	CPC9329WH332P 3872	"G" Option N/A		CPC9329WH332M 2108	
		190	CPC8729WH332W 3454	3799	CPC8729WH332P 3799	"G" Option N/A		CPC8729WH332M 1996	
		190	CPC7029WH332W 2958	3254	CPC7029WH332P 3254	"G" Option N/A		CPC7029WH332M 1412	
		170	CPC6429WH332W 2891	3180	CPC6429WH332P 3180	"G" Option N/A		CPC6429WH332M 1381	
		150	CPC5829WH332W 2773	3050	CPC5829WH332P 3050	"G" Option N/A		CPC5829WH332M 1310	
		70	CPC3529WH332W 1548	1703	CPC3529WH332P 1703	"G" Option N/A		CPC3529WH332M 1011	
		60	CPC2929WH332W 1513	1664	CPC2929WH332P 1664	"G" Option N/A		CPC2929WH332M 976	
2 Select a finish <i>View finish details</i>		WAC	WGW	TBCO	WSO			MAC	
		WRC	WBW	TBSW				MEC	
		WIC	WSW	TSTV				MHC	
		WEC	WNW	TSMV				MOC	
		WHC	WWP	TSLV				MGW	
		WOC		TOBW				MTW	
		WAM		WBO				MSW	
		WCM		WMO				MWL	
		WWW		WNO					
		WEW							
3 Select a edge <i>View edge details</i>		Edge		Edge				Edge	
		N/A		N/A				N/A	
4 Select hardware <i>View hardware details</i>		Hardware		Hardware				Hardware	
		N/A		N/A				N/A	

*View statement of line*

## Product features.

- Adjustable finished shelf
- Black painted top
- Interior cabinet depth 12"

### NOTES

- 2 section overhead available w/ 1 sliding door
- 3 Section Overhead Available w/ 1 or 2 Sliding Doors
- Proper installation is critical to ensure safety from possible falling cabinets. The factory assumes no liability for damage or injury from the following: installation into non-load bearing or unlevel walls. Improper fasteners used in installation. Overloading of cabinets resulting in failures of wall and surrounding structures, fasteners, or cabinet construction. Misuse of cabinets for intended purposes.

## Options.

### DOOR

- Not available on one section units
- RF850AW: Aluminum/White Glass - \$1090
- SLD29WD: Wood/Laminate Panel Door ("W" only) - \$310 per door
- SLD29LD: White Laminate Door ("W" only) - \$260 per door
- SLD29FD: SilverLuma / Frost Door ("W", "M" only) - \$415 per door
- SLD29MD: Panel Door ("M" only) - \$205

### INTERIOR CABINET LIGHT

- LEDPK starter kit includes Infeed, 1 Puck Interior Light and the ability to daisy chain up to 6 total Puck Lights
- LEDPK: LED Puck Starter Kit - \$310
- PK: 1 LED Interior Light - \$130 ea.

### LEGAL DEPTH

- MLD1: Modify to legal depth 18" - 10% upcharge

### TASK LIGHTING (RECESSED)

- Overhead tasklight cord is located on the right facing side. If the opposite location is required please contact customer service.
- LT-LED24R: 24" LED Task light - \$190
- LT-LED48R: 48" LED Task light - \$245
- LT-LED60R: 60" LED Task light - \$310
- LT-LED72R: 72" LED Task light - \$335
- LC24: Linking Task light cable - \$25

### SHELVES

- GS14F: Replace Standard Shelves with Glass Shelves - \$90 per shelf
- S714F: Heavy Duty Lumber 1" Shelves - \$80 per shelf ("M" Styles - n/a)

# Central park tackboards.

Wall hung tackboards  
Full width tackboards

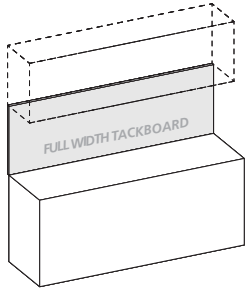

Product Width	Panel Dimension	SKU	COM	1	2	3	4	5	6	7	8	9	10	11/L1	12	13/L2
105	105 x .75 x 24	FTWH10524	530	650	709	768	827	886	945	1004	1063	1122	1181	1240	1299	1417
99	99 x .75 x 24	FTWH9924	502	613	668	723	778	833	888	943	998	1053	1108	1163	1218	1328
93	93 x .75 x 24	FTWH9324	465	576	627	678	729	780	831	882	933	984	1035	1086	1137	1239
87	87 x .75 x 24	FTWH8724	448	539	587	635	683	731	779	827	875	923	971	1019	1067	1163
83	83 x .75 x 24	FTWH8324	422	514	560	606	652	698	744	790	836	882	928	974	1020	1112
76	76 x .75 x 24	FTWH7624	388	471	514	557	600	643	686	729	772	815	858	901	944	1030
70	70 x .75 x 24	FTWH7024	355	434	474	514	554	594	634	674	714	754	794	834	874	954
64	64 x .75 x 24	FTWH6424	322	396	432	468	504	540	576	612	648	684	720	756	792	864
58	58 x .75 x 24	FTWH5824	294	359	391	423	455	487	519	551	583	615	647	679	711	775
47	47 x .75 x 24	FTWH4724	236	291	318	345	372	399	426	453	480	507	534	561	588	642
35	35 x .75 x 24	FTWH3524	176	217	237	257	277	297	317	337	357	377	397	417	437	477
29	29 x .75 x 24	FTWH2924	142	179	196	213	230	247	264	281	298	315	332	349	366	400

**Standard Features**

- Constructed of .5" thick fiberboard
- Fabric is precisely aligned and fitted to the tackboard
- Hung with Z-Strip mounting system

- Adhered to the rigid hardboard with glue

Wall hung tackboards  
Half width tackboards

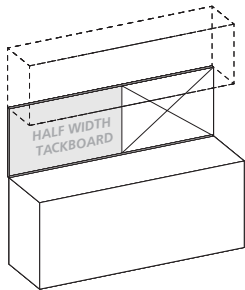

Product Width	Panel Dimension	SKU	COM	1	2	3	4	5	6	7	8	9	10	11/L1	12	13/L2
105 Half Width	52.5 x .75 x 24	FTWH5224	265	325	354	383	412	441	470	499	528	557	586	615	644	702
99 Half Width	49.5 x .75 x 24	FTWH4924	252	307	334	361	388	415	442	469	496	523	550	577	604	658
93 Half Width	46.5 x .75 x 24	FTWH4624	233	288	313	338	363	388	413	438	463	488	513	538	563	613
87 Half Width	43.5 x .75 x 24	FTWH4324	225	270	294	318	342	366	390	414	438	462	486	510	534	582
83 Half Width	41.5 x .75 x 24	FTWH4124	211	257	280	303	326	349	372	395	418	441	464	487	510	556
76 Half Width	38 x .75 x 24	FTWH3824	194	235	256	277	298	319	340	361	382	403	424	445	466	508
70 Half Width	35 x .75 x 24	FTWH3524	178	217	237	257	277	297	317	337	357	377	397	417	437	477
64 Half Width	32 x .75 x 24	FTWH3224	161	198	216	234	252	270	288	306	324	342	360	378	396	432

**Standard Features**

- Constructed of .5" thick fiberboard
- Fabric is precisely aligned and fitted to the tackboard
- Adhered to the rigid hardboard with glue
- Hung with Z-Strip mounting system

**Notes**

- Half width tackboards can be specified and combined with a Veneer Panel, Marker Board, Slat Wall or Glass Board. See "Half Width" items under product width.
- Specify right or left facing tackboard

## Central park tackboards.

Wall hung dry marker board  
Full width dry marker board

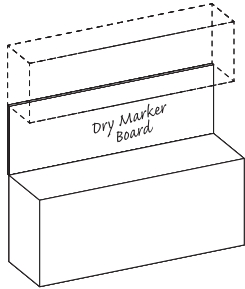

Product Width	Panel Dimension	SKU	List
105	105 x .75 x 24	DMWH10524	1310
99	99 x .75 x 24	DMWH9924	1236
93	93 x .75 x 24	DMWH9324	1161
87	87 x .75 x 24	DMWH8724	1086
83	83 x .75 x 24	DMWH8324	1023
76	76 x .75 x 24	DMWH7624	948
70	70 x .75 x 24	DMWH7024	874
64	64 x .75 x 24	DMWH6424	799
58	58 x .75 x 24	DMWH5824	724
47	47 x .75 x 24	DMWH4724	587
35	35 x .75 x 24	DMWH3524	437
29	29 x .75 x 24	DMWH2924	362

### Standard Features

- Dry marker panel has edge trim molding
- Standard magnetic surface
- Hung with Z-Strip mounting system

Wall hung dry marker board  
Half width dry marker board

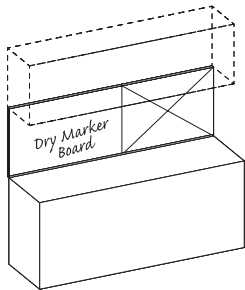

Product Width	Panel Dimension	SKU	List
105 Half Width	52.5 x .75 x 24	DMWH5224	630
99 Half Width	49.5 x .75 x 24	DMWH4924	593
93 Half Width	46.5 x .75 x 24	DMWH4624	580
87 Half Width	43.5 x .75 x 24	DMWH4324	543
83 Half Width	41.5 x .75 x 24	DMWH4124	518
76 Half Width	38 x .75 x 24	DMWH3824	474
70 Half Width	35 x .75 x 24	DMWH3524	437
64 Half Width	32 x .75 x 24	DMWH3224	399

### Standard Features

- Dry marker panel has edge trim molding
- Standard magnetic surface
- Hung with Z-Strip mounting system

### Notes

- Half width dry marker boards can be specified and combined with a Tackboard, Veneer Panel, Slat Wall or Glass Board. See "Half Width" items under product width.
- Specify right or left facing dry marker board

## Central park tackboards.

Wall hung veneer panel  
Full width veneer panel

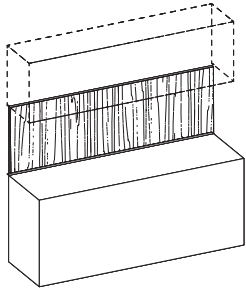

Product Width	Panel Dimension	SKU	List
105	105 x .75 x 24	VPWH10524	1092
99	99 x .75 x 24	VPWH9924	1030
93	93 x .75 x 24	VPWH9324	967
87	87 x .75 x 24	VPWH8724	905
83	83 x .75 x 24	VPWH8324	853
76	76 x .75 x 24	VPWH7624	790
70	70 x .75 x 24	VPWH7024	728
64	64 x .75 x 24	VPWH6424	666
58	58 x .75 x 24	VPWH5824	603
47	47 x .75 x 24	VPWH4724	489
35	35 x .75 x 24	VPWH3524	364
29	29 x .75 x 24	VPWH2924	302

### Standard Features

- Veneer edges
- Hung with Z-Strip mounting system

### Notes

- Vertical wire channels on back for task light cords
- Steel mounting wall channel is recessed for flush mounting
- Can be used with or without overhead cabinet
- Required for other accessory panels

Wall hung veneer panel  
Half width veneer panel

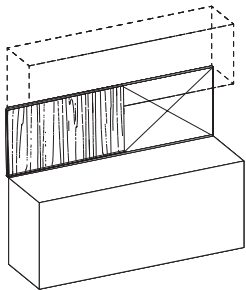

Product Width	Panel Dimension	SKU	List
105 Half Width	52.5 x .75 x 24	VPWH5224	546
99 Half Width	49.5 x .75 x 24	VPWH4924	515
93 Half Width	46.5 x .75 x 24	VPWH4624	484
87 Half Width	43.5 x .75 x 24	VPWH4324	452
83 Half Width	41.5 x .75 x 24	VPWH4124	432
76 Half Width	38 x .75 x 24	VPWH3824	395
70 Half Width	35 x .75 x 24	VPWH3524	364
64 Half Width	32 x .75 x 24	VPWH3224	333

### Standard Features

- Veneer edges
- Vertical wire channels on back for task light cords
- Steel mounting wall channel is recessed for flush mounting
- Hung with Z-Strip mounting system

### Notes

- Half width veneer panels can be specified and combined with a Tackboard, Marker Board, Slat Wall or Glass Board. See "Half Width" items under product width.
- Specify right or left facing veneer panel
- Can be used with or without overhead cabinet
- Required for other accessory panels



## Central park tackboards.

Wall hung glassboard  
Full width tackboard

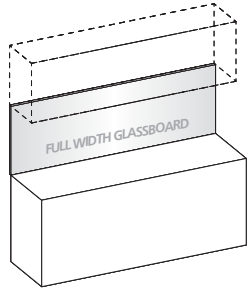

Product Width	Panel Dimension	SKU	List
105	105 x .75 x 24	GBWH10524	2928
99	99 x .75 x 24	GBWH9924	2919
93	93 x .75 x 24	GBWH9324	2753
87	87 x .75 x 24	GBWH8724	2586
83	83 x .75 x 24	GBWH8324	2475
76	76 x .75 x 24	GBWH7624	2281
70	70 x .75 x 24	GBWH7024	2114
64	64 x .75 x 24	GBWH6424	1948
58	58 x .75 x 24	GBWH5824	1780
47	47 x .75 x 24	GBWH4724	1476
35	35 x .75 x 24	GBWH3524	1142
29	29 x .75 x 24	GBWH2924	976

Standard Features  
- 4 mm tempered glass

Notes  
- Earth magnets are required to hold items securely in place  
- Hung with Z-Strip mounting system  
- Use glass cleaner or alcohol to clean  
- Standard dry erase markers may be used

Wall hung glassboard  
Half width tackboard

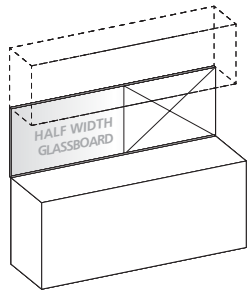

Product Width	Panel Dimension	SKU	List
105 Half Width	52.5 x .75 x 24	GBWH5224	1628
99 Half Width	49.5 x .75 x 24	GBWH4924	1544
93 Half Width	46.5 x .75 x 24	GBWH4624	1461
87 Half Width	43.5 x .75 x 24	GBWH4324	1378
83 Half Width	41.5 x .75 x 24	GBWH4124	1323
76 Half Width	38 x .75 x 24	GBWH3824	1232
70 Half Width	35 x .75 x 24	GBWH3524	1142
64 Half Width	32 x .75 x 24	GBWH3224	1059

Standard Features  
- 4 mm tempered glass

Notes  
- Half width glassboards can be specified and combined with a Tackboard, Veneer panel, Marker Board or Slat Wall. See "Half Width" items under product width.  
- Specify right or left facing glassboard  
- Use glass cleaner or alcohol to clean  
- Standard dry erase markers may be used  
- Earth magnets are required to hold items securely in place  
- Hung with Z-Strip mounting system

## Central park tackboards.

Wall hung slat wall  
Half width slat wall

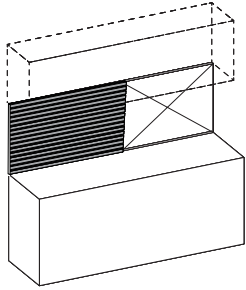

Product Width	Panel Dimension	SKU	List
105 Half Width	52.5 x .75 x 24	SWWH5224	546
99 Half Width	49.5 x .75 x 24	SWWH4924	515
93 Half Width	46.5 x .75 x 24	SWWH4624	484
87 Half Width	43.5 x .75 x 24	SWWH4324	452
83 Half Width	41.5 x .75 x 24	SWWH4124	432
76 Half Width	38 x .75 x 24	SWWH3824	395
70 Half Width	35 x .75 x 24	SWWH3524	364
64 Half Width	32 x .75 x 24	SWWH3224	333

### Standard Features

- Available in silver or black
- Hung with Z-Strip mounting system

### Notes

- Half width slat walls can be specified and combined with a Tackboard, Veneer panel, Marker Board or Glassboard. See "Half Width" items under product width.
- Specify right or left facing slat wall

# Central park.

Glass Wall Hung Board

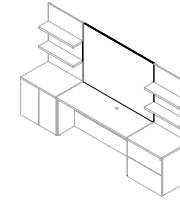

## 1 Select a model

w" x d" x h"

weight

White Glass Wall Hung Board

72 x .75 x 42	GBWH7242	3175
60 x .75 x 42	GBWH6042	2805
48 x .75 x 42	GBWH4842	2350
42 x .75 x 42	GBWH4242	2165

[View statement of line](#)

## Product features.

- 4 mm tempered glass
- Hung with Z-Strip mounting system

### NOTES

- Standard dry erase markers may be used
- Earth magnets are required to hold items securely in place
- Use glass cleaner or alcohol to clean

## 2 Select a finish

[View finish details](#)

Finishes  
N/A

## 3 Select a edge

[View edge details](#)

Edge  
N/A

## 4 Select hardware

[View hardware details](#)

Hardware  
N/A

# Central park.

Single Height Wall Hung Shelf  
Open Endless Shelf - 2 Shelves

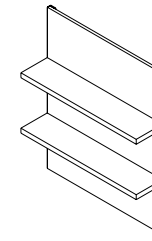

1 Select a model w" x d" x h"	weight	Standard Veneer Top Standard Veneer Chassis		Premium Veneer Top Premium Veneer Chassis		High Pressure Laminate Top Veneer Chassis		Thermally Fused Laminate Top Thermally Fused Laminate Chassis	
		29 x 9 x 42 35 x 9 x 42		CPC2942WH337W 1144 CPC3542WH337W 1347		CPC2942WH337P 1258 CPC3542WH337P 1482		"G" Option N/A "G" Option N/A	
2 Select a finish <i>View finish details</i>		WAC WRC WIC WEC WHC WOC WAM WCM WWW WEW	WGW WBW WSW WNW WWP	TBCO TBSW TSTV TSMV TSLV TOBW WBO WMO WNO	WSO			MAC MEC MHC MOC MGW MTW MSW MWL	
	3 Select an edge <i>View edge details</i>	Edge N/A		Edge N/A			Edge N/A		
4 Select hardware <i>View hardware details</i>		Hardware N/A		Hardware N/A			Hardware N/A		

[View statement of line](#)

## Product features.

- Mounting rails included
- Wall hung panels are 13-1/4"
- Shelving will not align with other wall shelf or cabinet units

### NOTES

- Proper installation is critical to ensure safety from possible falling cabinets. The factory assumes no liability for damage or injury from The following: installation into non-load bearing or unlevel walls. Improper fasteners used in installation. Overloading of cabinets resulting in failures of wall and surrounding structures, fasteners, or cabinet construction. Misuse of cabinets for intended purposes.
- Max load per inch is 3lbs

## Options.

### TASK LIGHTING (RECESSED)

- Overhead tasklight cord is located on the right facing side. If the opposite location is required please contact customer service.
- LT-LED24R: 24" LED Task light - \$190

# Central park.

Double Height Wall Hung Shelf  
Open Endless Shelf - 3 Shelves

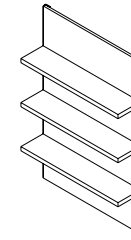

1 Select a model w" x d" x h"	weight	Standard Veneer Top Standard Veneer Chassis		Premium Veneer Top Premium Veneer Chassis		High Pressure Laminate Top Veneer Chassis		Thermally Fused Laminate Top Thermally Fused Laminate Chassis	
		29 x 9 x 54 35 x 9 x 54		CPC2954WH337W 1267 CPC3554WH337W 1491	CPC2954WH337P 1394 CPC3554WH337P 1640	"G" Option N/A "G" Option N/A		CPC2954WH337M 1017 CPC3554WH337M 1198	
2 Select a finish <a href="#">View finish details</a>		WAC WGW WRC WBW WIC WSW WEC WNW WHC WWP WOC WAM WCM WWW WEW	TBCO WSO TBSW TSTV TSMV TSLV TOBW WBO WMO WNO			MAC MEC MHC MOC MGW MTW MSW MWL			
	3 Select a edge <a href="#">View edge details</a>	Edge N/A	Edge N/A			Edge N/A			
4 Select hardware <a href="#">View hardware details</a>		Hardware N/A	Hardware N/A			Hardware N/A			

[View statement of line](#)

## Product features.

- Mounting rails included
- Wall hung panels are 12-1/2"
- Shelving will not align with other wall shelf or cabinet units

### NOTES

- Proper installation is critical to ensure safety from possible falling cabinets. The factory assumes no liability for damage or injury from The following: installation into non-load bearing or unlevel walls. Improper fasteners used in installation. Overloading of cabinets resulting in failures of wall and surrounding structures, fasteners, or cabinet construction. Misuse of cabinets for intended purposes.
- Max load per inch is 6lbs

## Options.

### TASK LIGHTING (RECESSED)

- Overhead tasklight cord is located on the right facing side. If the opposite location is required please contact customer service.
- LT-LED24R: 24" LED Task light - \$190

# Central park.

Floating Wall Mounted Shelf  
Single Shelf

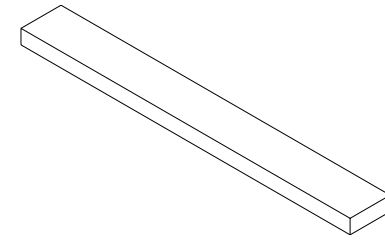

*View statement of line*

1 Select a model w" x d" x h"	weight	Standard Veneer Top		Premium Veneer Top		High Pressure Laminate Top		Thermally Fused Laminate Top	
		Standard Veneer Chassis		Premium Veneer Chassis		Veneer Chassis		Thermally Fused Laminate Chassis	
93 x 3 x 8	22	CPC9308WH338W	700	CPC9308WH338P	770	"G" Option N/A		CPC9308WH338M	462
87 x 3 x 8	21	CPC8708WH338W	662	CPC8708WH338P	728	"G" Option N/A		CPC8708WH338M	444
83 x 3 x 8	19	CPC8308WH338W	638	CPC8308WH338P	702	"G" Option N/A		CPC8308WH338M	432
76 x 3 x 8	18	CPC7608WH338W	602	CPC7608WH338P	662	"G" Option N/A		CPC7608WH338M	411
70 x 3 x 8	16	CPC7008WH338W	566	CPC7008WH338P	623	"G" Option N/A		CPC7008WH338M	393
64 x 3 x 8	15	CPC6408WH338W	530	CPC6408WH338P	583	"G" Option N/A		CPC6408WH338M	375
58 x 3 x 8	14	CPC5808WH338W	494	CPC5808WH338P	543	"G" Option N/A		CPC5808WH338M	375
47 x 3 x 8	12	CPC4708WH338W	428	CPC4708WH338P	471	"G" Option N/A		CPC4708WH338M	324
35 x 3 x 8	8	CPC3508WH338W	356	CPC3508WH338P	392	"G" Option N/A		CPC3508WH338M	288
29 x 3 x 8	7	CPC2908WH338W	320	CPC2908WH338P	352	"G" Option N/A		CPC2908WH338M	270
2 Select a finish <i>View finish details</i>		WAC	WGW	TBCO	WSO			MAC	
		WRC	WBW	TBSW				MEC	
		WIC	WSW	TSTV				MHC	
		WEC	WNW	TSMV				MOC	
		WHC	WWP	TSLV				MGW	
		WOC		TOBW				MTW	
		WAM		WBO				MSW	
		WCM		WMO				MWL	
		WWW		WNO					
		WEW							
3 Select an edge <i>View edge details</i>		Edge		Edge				Edge	
		N/A		N/A				N/A	
4 Select hardware <i>View hardware details</i>		Hardware		Hardware				Hardware	
		N/A		N/A				N/A	

## Product features.

- Wall brackets included
- Wall brackets provide horizontal and vertical adjustments

### NOTES

- Proper installation is critical to ensure safety from possible falling wall mounted shelves. The factory assumes no liability for damage or injury from The following: installation into non-load bearing or unlevel walls. Improper fasteners used in installation. Overloading of wall mounted shelves, resulting in failures of wall and surrounding structures, fasteners, or wall mounted shelf construction. Misuse of the wall mounted shelves for intended purposes.
- 93" shelf will support 28lbs of additional weight, 87" shelf will support 29lbs, 83" shelf will support 31lbs, 76" shelf will support 22lbs, 70"shelf will support 24lbs, 64" shelf will support 25lbs, 58" shelf will support 16lbs, 47" shelf will support 18lbs, 35" shelf will support 22lbs, 29" shelf will support 23lbs.

# Central park.

Overhead Half Towers  
14" D Panel Doors / Storage

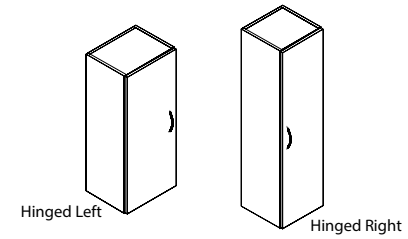

## 1 Select a model

w" x d" x h"

weight	Standard Veneer Top		Premium Veneer Top		High Pressure Laminate Top		Thermally Fused Laminate Top	
	Standard Veneer Chassis		Premium Veneer Chassis		Veneer Chassis		Thermally Fused Laminate Chassis	
<b>Hinged Left</b>								
17.5 x 14 x 42	80	CPC1742OH340W	1371	CPC1742OH340P	1508	"G" Option N/A	CPC1742OH340M	778
14.5 x 14 x 42	75	CPC1442OH340W	1307	CPC1442OH340P	1438	"G" Option N/A	CPC1442OH340M	752
17.5 x 14 x 54	90	CPC1754OH340W	1594	CPC1754OH340P	1753	"G" Option N/A	CPC1754OH340M	833
14.5 x 14 x 54	85	CPC1454OH340W	1530	CPC1454OH340P	1683	"G" Option N/A	CPC1454OH340M	808
<b>Hinged Right</b>								
17.5 x 14 x 42	80	CPC1742OH341W	1371	CPC1742OH341P	1508	"G" Option N/A	CPC1742OH341M	778
14.5 x 14 x 42	75	CPC1442OH341W	1307	CPC1442OH341P	1438	"G" Option N/A	CPC1442OH341M	752
17.5 x 14 x 54	90	CPC1754OH341W	1594	CPC1754OH341P	1753	"G" Option N/A	CPC1754OH341M	833
14.5 x 14 x 54	85	CPC1454OH341W	1530	CPC1454OH341P	1683	"G" Option N/A	CPC1454OH341M	808

*View statement of line*

## 2 Select a finish

*View finish details*

WAC	WGW	TBCO	WSO	MAC
WRC	WBW	TBSW		MEC
WIC	WSW	TSTV		MHC
WEC	WNW	TSMV		MOC
WHC	WWP	TSLV		MGW
WOC		TOBW		MTW
WAM		WBO		MSW
WCM		WMO		MWL
WWW		WNO		
WEW				
Edge		Edge		Edge
N/A		N/A		N/A

## 3 Select a edge

*View edge details*

## 4 Select hardware

*View hardware details*

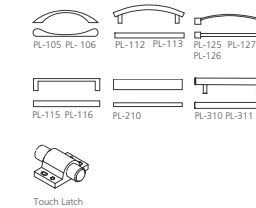
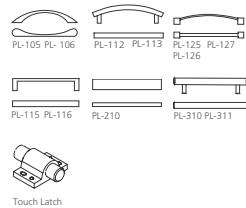
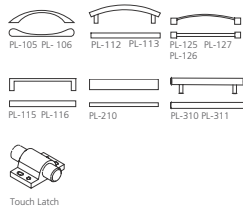

## Product features.

- 42" H Storage w/ 2 Finished adjustable shelves
- 54" H Storage w/ 3 Finished adjustable shelves
- "W" styles - 42" H units finished top, 54" H units black painted top
- Interior cabinet depth 12.5"

### NOTES

- Unit has black back panel and is not designed for Open Plan use.
- Select OPB Option for Open Plan application

## Options.

### DOOR

- D2: Door lock - \$100
- D6: Delete doors - n/c
- D9SC: Soft Close Door Hinges - \$20 per door
- WPD3061: Designer White - \$80 per door

### LEGAL DEPTH

- MLD1: Modify to legal depth 18" - 10% upcharge

### OPEN PLAN – FINISHED BACK

- OPB: "W" "G" Style - Modify Unit for Open Plan Application - \$310
- OPB: "M" Style - Modify Unit for Open Plan Application - \$100

# Central park.

Overhead Half Towers

14" D Panel Door - Storage / Organizer

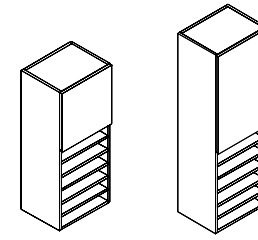

## 1 Select a model w" x d" x h"

weight	Standard Veneer Top		Premium Veneer Top		High Pressure Laminate Top		Thermally Fused Laminate Top	
	Standard Veneer Chassis		Premium Veneer Chassis		Veneer Chassis		Thermally Fused Laminate Chassis	
<b>Hinged Left</b>								
17.5 x 14 x 42	80	CPC1742OH408W	1562	CPC1742OH408P	1718	"G" Option N/A	CPC1742OH408M	879
14.5 x 14 x 42	75	CPC1442OH408W	1498	CPC1442OH408P	1648	"G" Option N/A	CPC1442OH408M	849
17.5 x 14 x 54	90	CPC1754OH408W	1785	CPC1754OH408P	1964	"G" Option N/A	CPC1754OH408M	935
14.5 x 14 x 54	85	CPC1454OH408W	1721	CPC1454OH408P	1893	"G" Option N/A	CPC1454OH408M	910
<b>Hinged Right</b>								
17.5 x 14 x 42	80	CPC1742OH409W	1562	CPC1742OH409P	1718	"G" Option N/A	CPC1742OH409M	879
14.5 x 14 x 42	75	CPC1442OH409W	1498	CPC1442OH409P	1648	"G" Option N/A	CPC1442OH409M	849
17.5 x 14 x 54	90	CPC1754OH409W	1785	CPC1754OH409P	1964	"G" Option N/A	CPC1754OH409M	935
14.5 x 14 x 54	85	CPC1454OH409W	1721	CPC1454OH409P	1893	"G" Option N/A	CPC1454OH409M	910

*View statement of line*

## 2 Select a finish *View finish details*

WAC	WGW	TBCO	WSO
WRC	WBW	TBSW	
WIC	WSW	TSTV	
WEC	WNW	TSMV	
WHC	WWP	TSLV	
WOC		TOBW	
WAM		WBO	
WCM		WMO	
WWM		WNO	
WEW			
Edge		Edge	
N/A		N/A	

## 3 Select an edge *View edge details*

Edge		Edge	
N/A		N/A	

## 4 Select hardware *View hardware details*

Hardware		Hardware	
N/A		N/A	

MAC			
MEC			
MHC			
MOC			
MGW			
MTW			
MSW			
MWL			
Edge		Edge	
N/A		N/A	

Hardware		Hardware	
N/A		N/A	

## Product features.

- 54" H has finished adjustable shelf behind door
- Interior cabinet depth 12.5"
- Organizer w/ 5 shelves (wood)
- "W" styles - 42" H units finished top, 54" H units black painted top

### NOTES

- Unit has black back panel and is not designed for Open Plan use.
- Select OPB Option for Open Plan application

## Options.

### DOOR

- D2: Door lock - \$100
- D6: Delete doors - n/c
- D9SC: Soft Close Door Hinges - \$20 per door
- WPD3061: Designer White - \$80 per door

### LEGAL DEPTH

- MLD1: Modify to legal depth 18" - 10% upcharge

### OPEN PLAN - FINISHED BACK

- OPB: "W" "G" Style - Modify Unit for Open Plan Application - \$310
- OPB: "M" Style - Modify Unit for Open Plan Application - \$100



# Central park.

Overhead Half Towers

14" D Silverluma Frame Door/Frosted Insert - Storage/Organizer

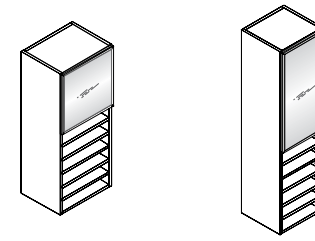

1 Select a model w" x d" x h"	weight	Standard Veneer Top Standard Veneer Chassis		Premium Veneer Top Premium Veneer Chassis		High Pressure Laminate Top Veneer Chassis		Thermally Fused Laminate Top Thermally Fused Laminate Chassis	
		<b>Hinged Left</b>							
17.5 x 14 x 42	85	CPC1742OH416W	1690	CPC1742OH416P	1859	"G" Option N/A		CPC1742OH416M	956
14.5 x 14 x 42	80	CPC1442OH416W	1624	CPC1442OH416P	1786	"G" Option N/A		CPC1442OH416M	930
17.5 x 14 x 54	95	CPC1754OH416W	1913	CPC1754OH416P	2104	"G" Option N/A		CPC1754OH416M	1016
14.5 x 14 x 54	90	CPC1454OH416W	1849	CPC1454OH416P	2034	"G" Option N/A		CPC1454OH416M	990
<b>Hinged Right</b>									
17.5 x 14 x 42	85	CPC1742OH417W	1690	CPC1742OH417P	1859	"G" Option N/A		CPC1742OH417M	956
14.5 x 14 x 42	80	CPC1442OH417W	1624	CPC1442OH417P	1786	"G" Option N/A		CPC1442OH417M	930
17.5 x 14 x 54	95	CPC1754OH417W	1913	CPC1754OH417P	2104	"G" Option N/A		CPC1754OH417M	1016
14.5 x 14 x 54	90	CPC1454OH417W	1849	CPC1454OH417P	2034	"G" Option N/A		CPC1454OH417M	990
2 Select a finish <i>View finish details</i>		WAC	WGW	TBCO	WSO			MAC	
		WRC	WBW	TBSW				MEC	
		WIC	WSW	TSTV				MHC	
		WEC	WNW	TSMV				MOC	
		WHC	WWP	TSLV				MGW	
		WOC		TOBW				MTW	
		WAM		WBO				MSW	
		WCM		WMO				MWL	
		WWM		WNO					
		WEW							
3 Select a edge <i>View edge details</i>		Edge		Edge				Edge	
		N/A		N/A				N/A	
4 Select hardware <i>View hardware details</i>		Hardware		Hardware				Hardware	
		N/A		N/A				N/A	

*View statement of line*

## Product features.

- 54" H has finished adjustable shelf behind door
- Interior cabinet depth 16.5"
- Organizer w/ 5 shelves (wood or laminate)
- "W" styles - 42" H units finished top, 54" H units black painted top

### NOTES

- Unit has black back panel and is not designed for Open Plan use.
- Select OPB Option for Open Plan application

## Options.

### DOOR

- D2: Door Lock - \$100 per door
- D9SC: Soft Close Door Hinges - \$20 per door
- DWF1: 2" Wood frame replaces SilverLuma Frame - n/c ("W" only)
- DWF2: 2" Wood frame w/ pull replaces SilverLuma Frame - \$20 per door ("W" only)

### INTERIOR CABINET LIGHT

- LEDPK starter kit includes Infeed, 1 Puck Interior Light and the ability to daisy chain up to 6 total Puck Lights
- LEDPK: LED Puck Starter Kit - \$310
- PK: 1 LED Interior Light - \$130 ea.

### LEGAL DEPTH

- MLD1: Modify to legal depth 18" - 10% upcharge

### OPEN PLAN – FINISHED BACK

- OPB: "W" "G" Style - Modify Unit for Open Plan Application - \$295
- OPB: "M" Style - Modify Unit for Open Plan Application - \$95

### SHELVES

- GS14H: Replace Standard Shelves with Glass Shelves - \$90 per shelf
- (behind silverluma door only)

# Central park.

Overhead Bookcases  
14" D Panel Doors / Storage

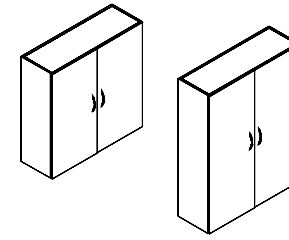

## 1 Select a model

w" x d" x h"

weight	Standard Veneer Top		Premium Veneer Top		High Pressure Laminate Top		Thermally Fused Laminate Top	
	Standard Veneer Chassis		Premium Veneer Chassis		Veneer Chassis		Thermally Fused Laminate Chassis	
<b>42" Height</b>								
41 x 14 x 42	150	CPC4142OH383W 2192	CPC4142OH383P 2411		"G" Option N/A		CPC4142OH383M 1076	
35 x 14 x 42	130	CPC3542OH383W 1901	CPC3542OH383P 2091		"G" Option N/A		CPC3542OH383M 1011	
29 x 14 x 42	120	CPC2942OH383W 1827	CPC2942OH383P 2010		"G" Option N/A		CPC2942OH383M 981	
<b>54" Height</b>								
41 x 14 x 54	165	CPC4154OH383W 2466	CPC4154OH383P 2713		"G" Option N/A		CPC4154OH383M 1184	
35 x 14 x 54	145	CPC3554OH383W 2284	CPC3554OH383P 2512		"G" Option N/A		CPC3554OH383M 1117	
29 x 14 x 54	135	CPC2954OH383W 2209	CPC2954OH383P 2430		"G" Option N/A		CPC2954OH383M 1088	

[View statement of line](#)

## 2 Select a finish

[View finish details](#)

WAC	WGW	TBCO	WSO	MAC
WRC	WBW	TBSW		MEC
WIC	WSW	TSTV		MHC
WEC	WNW	TSMV		MOC
WHC	WWP	TSLV		MGW
WOC		TOBW		MTW
WAM		WBO		MSW
WCM		WMO		MWL
WWW		WNO		
WEW				
Edge		Edge		Edge
N/A		N/A		N/A

## 3 Select a edge

[View edge details](#)

## 4 Select hardware

[View hardware details](#)

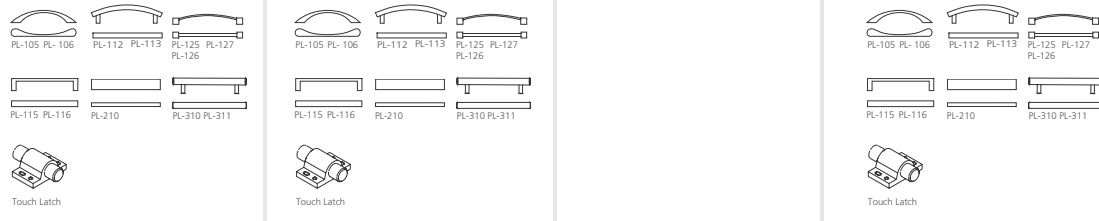

## Product features.

- 42" H Storage w/ 2 Finished adjustable shelves
- 54" H Storage w/ 3 Finished adjustable shelves
- Interior cabinet depth 12.5"
- "W" styles - 42" H units finished top, 54" H units black painted top

### NOTES

- Unit has black back panel and is not designed for Open Plan use.
- Select OPB Option for Open Plan application

## Options.

### DOOR

- D2: Door Lock - \$100 per door
- D6: Delete doors - n/c
- D9SC: Soft Close Door Hinges - \$20 per door
- WPD3061: Designer White - \$80 per door

### LEGAL DEPTH

- MLD1: Modify to legal depth 18" - 10% upcharge

### OPEN PLAN - FINISHED BACK

- OPB: "W" "G" Style - Modify Unit for Open Plan Application - \$295
- OPB: "M" Style - Modify Unit for Open Plan Application - \$95

### SHELVES

- S714F: Replace Standard Shelf with Heavy Duty Lumber 1" Shelf - \$80 per shelf ("M" Styles - n/a)

# Central park.

Vertical Half Towers  
Storage Wardrobe - Panel Door

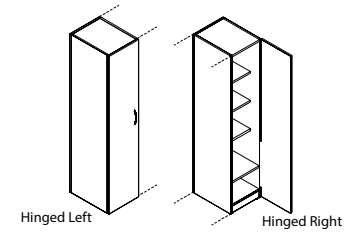

1 Select a model w" x d" x h"	weight	Standard Veneer Top Standard Veneer Chassis		Premium Veneer Top Premium Veneer Chassis		High Pressure Laminate Top Veneer Chassis		Thermally Fused Laminate Top Thermally Fused Laminate Chassis	
		<b>Door Hinged Left</b> 16 x 24 x 71 16 x 24 x 83	175 190	CPC1671TW283W CPC1683TW283W	2683 2875	CPC1671TW283P CPC1683TW283P	2951 3163	"G" Option N/A "G" Option N/A	CPC1671TW283M CPC1683TW283M
<b>Door Hinged Right</b> 16 x 24 x 71 16 x 24 x 83	175 190	CPC1671TW284W CPC1683TW284W	2683 2875	CPC1671TW284P CPC1683TW284P	2951 3163	"G" Option N/A "G" Option N/A	CPC1671TW284M CPC1683TW284M	1335 1485	
<b>2 Select a finish</b> <i>View finish details</i>		WAC WRC WIC WEC WHC WOC WAM WCM WWW WEW	WGW WBW WSW WNW WWP	TBCO TBSW TSTV TSMV TSLV TOBW WBO WMO WNO	WSO		MAC MEC MHC MOC MGW MTW MSW MWL		
<b>3 Select a edge</b> <i>View edge details</i>		Edge N/A		Edge N/A			Edge N/A		
<b>4 Select hardware</b> <i>View hardware details</i>									

*View statement of line*

## Product features.

- 71" has 3 finished adjustable shelves/1 fixed
- 83" has 4 finished adjustable shelves/1 fixed
- Wardrobe w/ coat rod & hook
- "W" styles - 71" H units finished top, 83" H units black painted top

### NOTES

- Unit has black back panel and is not designed for Open Plan use.
- Select OPB Option for Open Plan application

## Options.

### DOOR

- D2: Door lock - \$100
- D6: Delete doors - n/c
- D9SC: Soft Close Door Hinges - \$20 per door
- WPD3061: Designer White - \$80 per door

### OPEN PLAN – FINISHED BACK

- OPB: "W" "G" Style - Modify Unit for Open Plan Application - \$295
- OPB: "M" Style - Modify Unit for Open Plan Application - \$95

# Central park.

Vertical Half Towers  
Storage / File - Panel Door

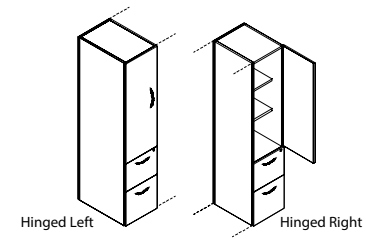

## 1 Select a model

w" x d" x h"

weight	Standard Veneer Top Standard Veneer Chassis		Premium Veneer Top Premium Veneer Chassis		High Pressure Laminate Top Veneer Chassis	Thermally Fused Laminate Top Thermally Fused Laminate Chassis	
<b>Door Hinged Left</b>							
16 x 24 x 71	195	CPC1671TW291W 3145	CPC1671TW291P 3460	"G" Option N/A	CPC1671TW291M 1606		
16 x 24 x 83	210	CPC1683TW291W 3338	CPC1683TW291P 3672	"G" Option N/A	CPC1683TW291M 1761		
<b>Door Hinged Right</b>							
16 x 24 x 71	195	CPC1671TW292W 3145	CPC1671TW292P 3460	"G" Option N/A	CPC1671TW292M 1606		
16 x 24 x 83	210	CPC1683TW292W 3338	CPC1683TW292P 3672	"G" Option N/A	CPC1683TW292M 1761		

*View statement of line*

## 2 Select a finish

*View finish details*

WAC	WGW	TBCO	WSO	MAC
WRC	WBW	TBSW		MEC
WIC	WSW	TSTV		MHC
WEC	WNW	TSMV		MOC
WHC	WWP	TSLV		MGW
WOC		TOBW		MTW
WAM		WBO		MSW
WCM		WMO		MWL
WWW		WNO		
WEW				

## 3 Select a edge

*View edge details*

Edge	Edge	Edge
N/A	N/A	N/A

## 4 Select hardware

*View hardware details*

--	--	--

## Product features.

- 71" has 2 finished adjustable shelves
- 83" has 3 finished adjustable shelves
- Full extension drawers - locking
- "W" & "G" SKUs feature soft close suspensions, "M" SKUs feature ball bearing suspensions. Both suspensions are full extension.
- "W" styles - 71" H units finished top, 83" H units black painted top

### NOTES

- All units are standard w/ flush ends
- Unit has black back panel and is not designed for Open Plan use.
- Select OPB Option for Open Plan application

## Options.

### DOOR

- D2: Door lock - \$100
- D6: Delete doors - n/c
- D9SC: Soft Close Door Hinges - \$20 per door
- WPD3061: Designer White - \$80 per door

### DRAWER

- P6: Modify File/File to Box/Box/File - \$55 per pedestal
- P33: Wood Drawer Upgrade - \$45 per drawer
- WPD3061: Designer White - \$80 per pedestal

### OPEN PLAN – FINISHED BACK

- OPB: "W" "G" Style - Modify Unit for Open Plan Application - \$295
- OPB: "M" Style - Modify Unit for Open Plan Application - \$95

# Central park.

Vertical Full Towers  
Wardrobe

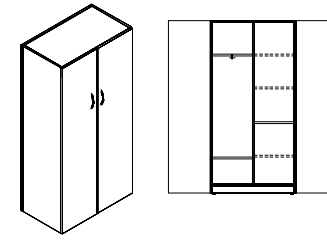

## 1 Select a model

w" x d" x h"

weight	Standard Veneer Top Standard Veneer Chassis		Premium Veneer Top Premium Veneer Chassis		High Pressure Laminate Top Veneer Chassis		Thermally Fused Laminate Top Thermally Fused Laminate Chassis																
	35 x 24 x 71	285	CPC3571TW275W 4006	CPC3571TW275P 4407	"G" Option N/A	CPC3571TW275M 1884	29 x 24 x 71	240	CPC2971TW275W 3727	CPC2971TW275P 4100	"G" Option N/A	CPC2971TW275M 1831	35 x 24 x 83	310	CPC3583TW275W 4261	CPC3583TW275P 4687	"G" Option N/A	CPC3583TW275M 2087	29 x 24 x 83	265	CPC2983TW275W 3982	CPC2983TW275P 4380	"G" Option N/A

View statement of line

## 2 Select a finish

View finish details

WAC	WGW	TBCO	WSO
WRC	WBW	TBSW	
WIC	WSW	TSTV	
WEC	WNW	TSMV	
WHC	WWP	TSLV	
WOC		TOBW	
WAM		WBO	
WCM		WMO	
WWW		WNO	
WEW			

## 3 Select a edge

View edge details

Edge	Edge
N/A	N/A

## 4 Select hardware

View hardware details

<p>Touch Latch</p>	<p>Touch Latch</p>	<p>Touch Latch</p>

## Product features.

- 71" has 3 finished adjustable shelves, 2 fixed shelves
- 83" has 4 finished adjustable shelves, 2 fixed shelves
- Wardrobe w/ coat rod & hook
- "W" styles - 71" H units finished top, 83" H units black painted top

### NOTES

- Unit has black back panel and is not designed for Open Plan use.
- Select OPB Option for Open Plan application

## Options.

### DOOR

- D2: Door Lock - \$100 per door
- D6: Delete doors - n/c
- D9SC: Soft Close Door Hinges - \$20 per door
- WPD3061: Designer White - \$80 per door

### OPEN PLAN – FINISHED BACK

- OPB: "W" "G" Style - Modify Unit for Open Plan Application - \$295
- OPB: "M" Style - Modify Unit for Open Plan Application - \$95

### SHELVES

- MOD31: 83" Delete center partition & add 1 fixed shelf, 4 adjustable shelves - \$295
- MOD31: 71" Delete center partition & add 1 fixed shelf, 3 adjustable shelves - \$295

# Central park.

Vertical Full Towers  
Storage / File

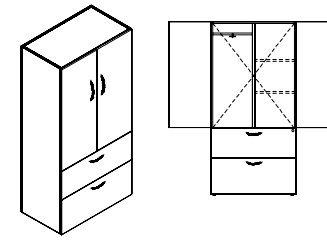

## 1 Select a model

w" x d" x h"

weight	Standard Veneer Top		Premium Veneer Top		High Pressure Laminate Top		Thermally Fused Laminate Top	
	Standard Veneer Chassis		Premium Veneer Chassis		Veneer Chassis		Thermally Fused Laminate Chassis	
35 x 24 x 71	325	CPC3571TW281W 4435	CPC3571TW281P 4879	"G" Option N/A	CPC3571TW281M 2140			
29 x 24 x 71	295	CPC2971TW281W 4235	CPC2971TW281P 4659	"G" Option N/A	CPC2971TW281M 2097			
35 x 24 x 83	350	CPC3583TW281W 4690	CPC3583TW281P 5159	"G" Option N/A	CPC3583TW281M 2339			
29 x 24 x 83	325	CPC2983TW281W 4491	CPC2983TW281P 4940	"G" Option N/A	CPC2983TW281M 2300			

*View statement of line*

## 2 Select a finish

*View finish details*

WAC	WGW	TBCO	WSO	MAC
WRC	WBW	TBSW		MEC
WIC	WSW	TSTV		MHC
WEC	WNW	TSMV		MOC
WHC	WWP	TSLV		MGW
WOC		TOBW		MTW
WAM		WBO		MSW
WCM		WMO		MWL
WWW		WNO		
WEW				
Edge		Edge		Edge
N/A		N/A		N/A

## 3 Select an edge

*View edge details*

## 4 Select hardware

*View hardware details*

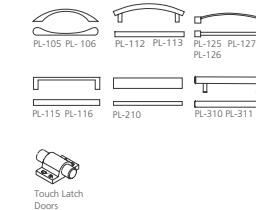
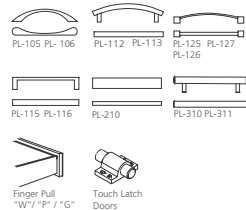
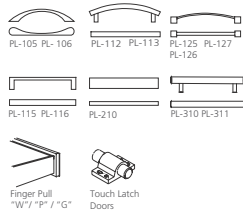

## Product features.

- 71" has 2 finished adjustable shelves
- 83" has 3 finished adjustable shelves
- Full extension drawers - locking, legal-letter filing
- "W" & "G" SKUs feature soft close suspensions, "M" SKUs feature ball bearing suspensions. Both suspensions are full extension.
- Wardrobe w/ coat rod & hook
- "W" styles - 71" H units finished top, 83" H units black painted top

### NOTES

- Unit has black back panel and is not designed for Open Plan use.
- Select OPB Option for Open Plan application

## Options.

### DOOR

- D2: Door Lock - \$100 per door
- D6: Delete doors - n/c
- D9SC: Soft Close Door Hinges - \$20 per door
- WPD3061: Designer White - \$80 per door

### DRAWER

- P33: Wood Drawer Upgrade - \$45 per drawer
- WPD3061: Designer White - \$80 per door

### OPEN PLAN - FINISHED BACK

- OPB: "W" "G" Style - Modify Unit for Open Plan Application - \$295
- OPB: "M" Style - Modify Unit for Open Plan Application - \$95

### SHELVES

- MOD30: 83" Delete center partition & Add 3 full width shelves - \$295
- MOD30: 71" Delete center partition & Add 2 full width shelves - \$295

# Central park.

Vertical Full Towers

Storage / File - Mini-Wardrobe

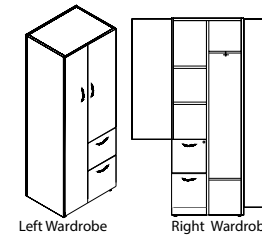

Left Wardrobe

Right Wardrobe

## 1 Select a model

w" x d" x h"

weight	Standard Veneer Top Standard Veneer Chassis		Premium Veneer Top Premium Veneer Chassis		High Pressure Laminate Top Veneer Chassis	Thermally Fused Laminate Top Thermally Fused Laminate Chassis	
<b>Wardrobe Left</b>							
26 x 24 x 71	250	CPC2671TW293W 3951	CPC2671TW293P 4346	4346	"G" Option N/A	CPC2671TW293M 1894	1894
26 x 24 x 83	275	CPC2683TW293W 4207	CPC2683TW293P 4628	4628	"G" Option N/A	CPC2683TW293M 2095	2095
<b>Wardrobe Right</b>							
26 x 24 x 71	250	CPC2671TW294W 3951	CPC2671TW294P 4346	4346	"G" Option N/A	CPC2671TW294M 1894	1894
26 x 24 x 83	275	CPC2683TW294W 4207	CPC2683TW294P 4628	4628	"G" Option N/A	CPC2683TW294M 2095	2095

[View statement of line](#)

## 2 Select a finish

[View finish details](#)

WAC	WGW	TBCO	WSO	MAC
WRC	WBW	TBSW		MEC
WIC	WSW	TSTV		MHC
WEC	WNW	TSMV		MOC
WHC	WWP	TSLV		MGW
WOC		TOBW		MTW
WAM		WBO		MSW
WCM		WMO		MWL
WWW		WNO		
WEW				

## 3 Select a edge

[View edge details](#)

Edge	Edge	Edge
N/A	N/A	N/A

## 4 Select hardware

[View hardware details](#)

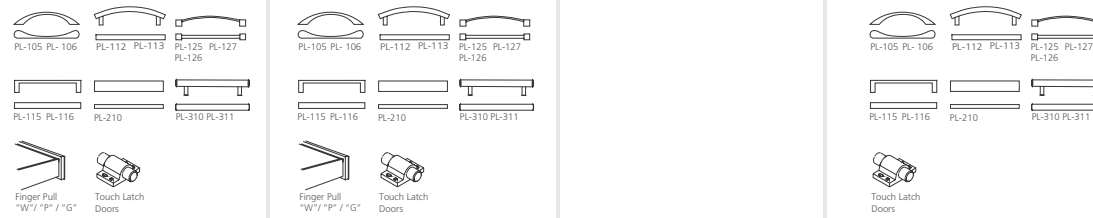

## Product features.

- 71" has 2 finished adjustable shelves
- 83" has 3 finished adjustable shelves
- Full extension drawers - locking
- "W" & "G" SKUs feature soft close suspensions, "M" SKUs feature ball bearing suspensions. Both suspensions are full extension.
- Wardrobe w/ coat rod & hook
- "W" styles - 71" H units finished top, 83" H units black painted top

### NOTES

- Unit has black back panel and is not designed for Open Plan use.
- Select OPB Option for Open Plan application

## Options.

### DOOR

- D2: Door Lock - \$100 per door
- D6: Delete doors - n/c
- D9SC: Soft Close Door Hinges - \$20 per door
- WPD3061: Designer White - \$80 per door

### DRAWER

- P6: Modify File/File to Box/Box/File - \$55 per pedestal
- P33: Wood Drawer Upgrade - \$45 per drawer
- WPD3061: Designer White - \$80 per door

### OPEN PLAN – FINISHED BACK

- OPB: "W" "G" Style - Modify Unit for Open Plan Application - \$295
- OPB: "M" Style - Modify Unit for Open Plan Application - \$95

# Central park.

Workcenter 54" Full Tower Components  
Lateral File X2 / Open Storage

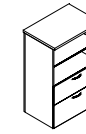

[View statement of line](#)

1 Select a model w" x d" x h"	weight	Standard Veneer Top Standard Veneer Chassis		Premium Veneer Top Premium Veneer Chassis		High Pressure Laminate Top Veneer Chassis		Thermally Fused Laminate Top Thermally Fused Laminate Chassis	
		35 x 24 x 54	200	CPC3554WC282W	2479	CPC3554WC282P	2727	CPC3554WC282G	2479
31 x 24 x 54	195	CPC3154WC282W	2416	CPC3154WC282P	2658	CPC3154WC282G	2416	CPC3154WC282M	1534
29 x 24 x 54	185	CPC2954WC282W	2359	CPC2954WC282P	2595	CPC2954WC282G	2359	CPC2954WC282M	1499

## Product features.

- Anti-tilt safety feature
- Finished back - open plan
- Finished top
- Legal/Letter filing
- "W" & "G" SKUs feature soft close suspensions, "M" SKUs feature ball bearing suspensions. Both suspensions are full extension.

### NOTES

- All units are standard w/ flush ends

## Options.

### DOOR

- D12: PANEL DOOR for upper section- \$200

### DRAWER

- P33: Wood Drawer Upgrade - \$45 per drawer
- WPD3061: Designer White - \$80 per door

### SHELF

- S721F: 1" wood shelf 24" deep - \$100 each

## 2 Select a finish

[View finish details](#)

WAC WGW  
WRC WBW  
WIC WSW  
WEC WNW  
WHC WWP  
WOC  
WAM  
WCM  
WWW  
WEW

TBCO WSO  
TBSW  
TSTV  
TSMV  
TSLV  
TOBW  
WBO  
WMO  
WNO

GAC GNW  
GIC GSTV +10%  
GEC GSLV +10%  
GHC GWL  
GOC  
GAM  
GCM  
GWM  
GEW

MAC  
MEC  
MHC  
MOC  
MGW  
MTW  
MSW  
MWL

## 3 Select a edge

[View edge details](#)



## 4 Select hardware

[View hardware details](#)

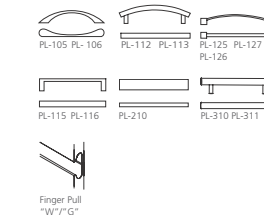
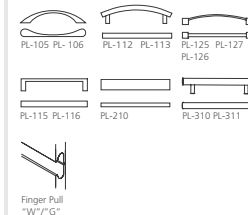
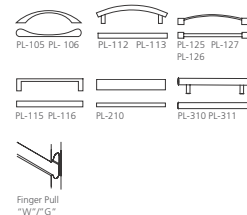
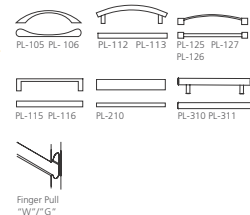



# Central park.

Bookcases  
14" D Open Bookcase

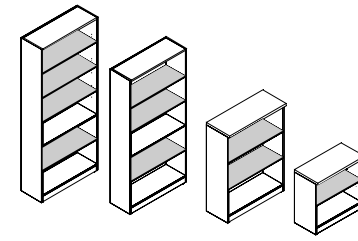

## 1 Select a model

w" x d" x h"

weight	Standard Veneer Top		Premium Veneer Top		High Pressure Laminate Top		Thermally Fused Laminate Top		
	Standard Veneer Chassis		Premium Veneer Chassis		Veneer Chassis		Thermally Fused Laminate Chassis		
<b>35" Width</b>									
35 x 14 x 83	180	CPC3583BK250W	2227	CPC3583BK250P	2450	"G" Option N/A	CPC3583BK250M	1219	
35 x 14 x 71	160	CPC3571BK250W	2038	CPC3571BK250P	2242	"G" Option N/A	CPC3571BK250M	1123	
35 x 14 x 48	125	CPC3548BK250W	1659	CPC3548BK250P	1825	CPC3548BK250G	1659	CPC3548BK250M	947
35 x 14 x 30.75	115	CPC3530BK250W	1487	CPC3530BK250P	1636	CPC3530BK250G	1487	CPC3530BK250M	724
<b>29" Width</b>									
29 x 14 x 83	160	CPC2983BK250W	2075	CPC2983BK250P	2283	"G" Option N/A	CPC2983BK250M	1192	
29 x 14 x 71	140	CPC2971BK250W	1888	CPC2971BK250P	2077	"G" Option N/A	CPC2971BK250M	1101	
29 x 14 x 48	105	CPC2948BK250W	1508	CPC2948BK250P	1659	CPC2948BK250G	1508	CPC2948BK250M	927
29 x 14 x 30.75	90	CPC2930BK250W	1335	CPC2930BK250P	1469	CPC2930BK250G	1335	CPC2930BK250M	682

[View statement of line](#)















## 2 Select a finish

[View finish details](#)

WAC	WGW	TBCO	WSO	GAC	GNW	MAC
WRC	WBW	TBSW		GIC	GSTV +10%	MEC
WIC	WSW	TSTV		GEC	GSLV +10%	MHC
WEC	WNW	TSMV		GHC	GWL	MOC
WHC	WWP	TSLV		GOC		MGW
WOC		TOBW		GAM		MTW
WAM		WBO		GCM		MSW
WCM		WMO		GWM		MWL
WWM		WNO		GEW		
WEW						

## 3 Select a edge

[View edge details](#)

 +5%						
Bullnose	Classic	Cobee	Cove	Flat	Ledge	Flat
			 +5%			
Flat	Knife	Ledge	Ogee			
	 +5%					
Reed	Radius	Waterfall				

## 4 Select hardware

[View hardware details](#)

Hardware	Hardware	Hardware
N/A	N/A	N/A

## Product features.

- 3/4" Thick finished shelves standard
- Interior cabinet depth 12.5"
- "W" styles - 29", 48", and 71" H units finished top, 83" H units black painted top

### NOTES

- 30.75"H Open Bookcases are NOT meant to gang with desks, returns and credenzas. Unit is higher than regular worksurfaces to allow double binder storage. If matching height is desired, choose CPC-3524CA125W or CPC2924CA125W with D6A option
- Adjustable shelves shaded
- Only 30.75" and 48"H units have profile edge/ shaped top
- Unit has black back panel and is not designed for Open Plan use. Select OPB Option for Open Plan application

## Options.

### INTERIOR CABINET LIGHT

- LEDPK starter kit includes Infeed, 1 Puck Interior Light and the ability to daisy chain up to 6 total Puck Lights
- LEDPK: LED Puck Starter Kit - \$310
  - PK: 1 LED Interior Light - \$130 ea.

### LEGAL DEPTH

- MLD1: Modify to legal depth 18" - 10% upcharge

### OPEN PLAN – FINISHED BACK

- OPB: "W" "G" Style - Modify Unit for Open Plan Application - \$295
- OPB: "M" Style - Modify Unit for Open Plan Application - \$95

### SHELVES

- GS14F: Replace Standard Shelves with Glass Shelves - \$90 per shelf
- S714F: Heavy Duty Lumber 1" Shelves - \$80 per shelf ("M" Styles - n/a)

# Central park.

Bookcases

14" D Bookcase W/ Doors

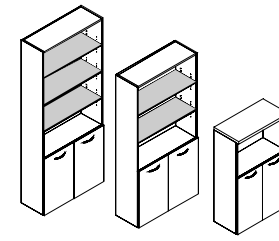

## 1 Select a model

w" x d" x h"

weight	Standard Veneer Top Standard Veneer Chassis		Premium Veneer Top Premium Veneer Chassis		High Pressure Laminate Top Veneer Chassis		Thermally Fused Laminate Top Thermally Fused Laminate Chassis	
	<b>35" Width</b>							
35 x 14 x 83	200	CPC3583BK251W 2583	CPC3583BK251P 2841	"G" Option N/A	CPC3583BK251M 1367			
35 x 14 x 71	180	CPC3571BK251W 2389	CPC3571BK251P 2628	"G" Option N/A	CPC3571BK251M 1275			
35 x 14 x 48	145	CPC3548BK251W 2010	CPC3548BK251P 2211	CPC3548BK251G 2010	CPC3548BK251M 1108			
<b>29" Width</b>								
29 x 14 x 83	180	CPC2983BK251W 2433	CPC2983BK251P 2676	"G" Option N/A	CPC2983BK251M 1341			
29 x 14 x 71	160	CPC2971BK251W 2240	CPC2971BK251P 2464	"G" Option N/A	CPC2971BK251M 1254			
29 x 14 x 48	125	CPC2948BK251W 1860	CPC2948BK251P 2046	CPC2948BK251G 1860	CPC2948BK251M 1088			

*View statement of line*

## 2 Select a finish

*View finish details*

WAC	WGW	TBCO	WSO	GAC	GNW	MAC
WRC	WBW	TBSW		GIC	GSTV +10%	MEC
WIC	WSW	TSTV		GEC	GSLV +10%	MHC
WEC	WNW	TSMV		GHC	GWL	MOC
WHC	WWP	TSLV		GOC		MGW
WOC		TOBW		GAM		MTW
WAM		WBO		GCM		MSW
WCM		WMO		GWM		MWL
WWW		WNO		GEW		
WEW						

## 3 Select a edge

*View edge details*

Bullnose	Classic	Cobee	Cove	Flat	Ledge	Flat
Flat	Knife	Ledge	Ogee			
Reed	Radius	Waterfall				

## 4 Select hardware

*View hardware details*

PL-105 PL-106	PL-112 PL-113	PL-125 PL-127 PL-126	PL-105 PL-106	PL-112 PL-113	PL-125 PL-127 PL-126	PL-105 PL-106
PL-115 PL-116	PL-210	PL-310 PL-311	PL-115 PL-116	PL-210	PL-310 PL-311	PL-115 PL-116
Touch Latch			Touch Latch			Touch Latch

## Product features.

- 3/4" Thick finished adjustable shelves standard
- Finished shelves
- Interior cabinet depth 12.5"
- Pulls standard
- "W" styles - 48", 71" H units finished top, 83" H units black painted top

### NOTES

- Only 48"H units have profile edge/ shaped top
- Unit has black back panel and is not designed for Open Plan use.
- Select OPB Option for Open Plan application

## Options.

### DOOR

- D2: Door lock - \$100 per door set
- D9SC: Soft Close Door Hinges - \$20 per door
- WPD3061: Designer White - \$80 per door

### INTERIOR CABINET LIGHT

- LEDPK starter kit includes Infeed, 1 Puck Interior Light and the ability to daisy chain up to 6 total Puck Lights
- LEDPK: LED Puck Starter Kit - \$310
- PK: 1 LED Interior Light - \$130 ea.

### LEGAL DEPTH

- MLD1: Modify to legal depth 18" - 10% upcharge

### OPEN PLAN – FINISHED BACK

- OPB: "W" "G" Style - Modify Unit for Open Plan Application - \$295
- OPB: "M" Style - Modify Unit for Open Plan Application - \$95

### SHELVES

- GS14F: Replace Standard Shelves with Glass Shelves - \$90 per shelf
- S714F: Heavy Duty Lumber 1" Shelves - \$80 per shelf ("M" Styles - n/a)

# Central park.

Reception Desk Countertops  
12" Rectangle Overhang Counter

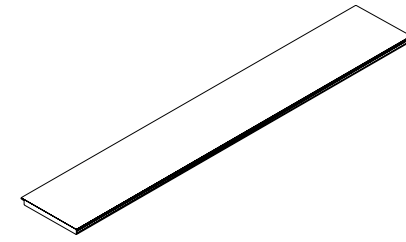

[View statement of line](#)

1 Select a model w" x d" x h"	weight	Standard Veneer Top		Premium Veneer Top		High Pressure Laminate Top		Thermally Fused Laminate Top	
		Standard Veneer Chassis		Premium Veneer Chassis		Veneer Chassis		Thermally Fused Laminate Chassis	
<b>Full Width Counter Top</b>									
84 x 12	40	CPC8412TC510W	1128	CPC8412TC510P	1241	CPC8412TC510G	1128	CPC8412TC510M	528
72 x 12	35	CPC7212TC510W	977	CPC7212TC510P	1075	CPC7212TC510G	977	CPC7212TC510M	514
66 x 12	30	CPC6612TC510W	942	CPC6612TC510P	1036	CPC6612TC510G	942	CPC6612TC510M	498
2 Select a finish <a href="#">View finish details</a>		WAC	WGW	TBCO	WSO	GAC	GNW	MAC	
		WRC	WBW	TBSW		GIC	GSTV +10%	MEC	
		WIC	WSW	TSTV		GEC	GSLV +10%	MHC	
		WEC	WNW	TSMV		GHC	GWL	MOC	
		WHC	WWP	TSLV		GOC		MGW	
		WOC		TOBW		GAM		MTW	
		WAM		WBO		GCM		MSW	
		WCM		WMO		GWM		MWL	
		WWW		WNO		GEW			
		WEW							
3 Select an edge <a href="#">View edge details</a>		+5%						+5%	
		+5%							
4 Select hardware <a href="#">View hardware details</a>		Hardware		Hardware		Hardware		Hardware	
		N/A		N/A		N/A		N/A	

## Product features.

- Ships assembled on desk
- Profile edge two long edges

### NOTES

- 3" Overhang
- For use on 42" H reception desk

## Options.

### PLANK MATCH VENEER

- RPMV: Random Walnut Plank Match Veneer (Horizontal Grain with 25%+ Sap) - Add 10%. Clear coat only.

# Central park.

Reception Desk Countertops  
Bowfront Overhang Counter

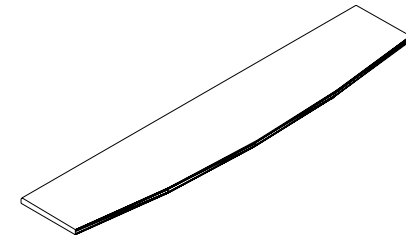

[View statement of line](#)

1 Select a model w" x d" x h"	weight	Standard Veneer Top Standard Veneer Chassis		Premium Veneer Top Premium Veneer Chassis		High Pressure Laminate Top Veneer Chassis		Thermally Fused Laminate Top Thermally Fused Laminate Chassis	
		<b>Full Bowfront Top</b> 84 x 12/15 72 x 12/15 66 x 12/15	50 45 40	CPC8415TC511W CPC7215TC511W CPC6615TC511W	1328 1178 1128	CPC8415TC511P CPC7215TC511P CPC6615TC511P	1461 1296 1241	CPC8415TC511G CPC7215TC511G CPC6615TC511G	1328 1178 1128
2 Select a finish <a href="#">View finish details</a>		WAC WRC WIC WEC WHC WOC WAM WCM WWM WEW	WGW WBW WSW WNW WWP	TBCO TBSW TSTV TSMV TSLV TOBW WBO WMO WNO	WSO	GAC GIC GEC GHC GOC GAM GCM GWM GEW	GNW GSTV +10% GSLV +10% GWL	MAC MEC MHC MOC MGW MTW MSW MWL	
3 Select an edge <a href="#">View edge details</a>		 Bullnose  Classic  Cobee  Cove  Flat  Knife  Ledge  Ogee  Reed  Radius  Waterfall	 Flat  Ledge	 Bullnose  Classic  Cobee  Cove  Flat  Knife  Ledge  Ogee  Reed  Radius  Waterfall	 Flat	Hardware N/A	Hardware N/A	Hardware N/A	Hardware N/A
4 Select hardware <a href="#">View hardware details</a>									

## Product features.

- Ships assembled on desk
- Profile edge two long edges

### NOTES

- 3" /6" Overhang
- For use on 42" H reception desk

## Options.

### PLANK MATCH VENEER

- RPMV: Random Walnut Plank Match Veneer (Horizontal Grain with 25%+ Sap) - Add 10%. Clear coat only.

# Central park.

Reception Desk Countertops  
Floating Overhang Counter

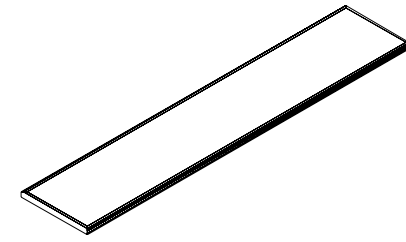

[View statement of line](#)

1 Select a model w" x d" x h"	weight	Standard Veneer Top		Premium Veneer Top		High Pressure Laminate Top		Thermally Fused Laminate Top	
		Standard Veneer Chassis		Premium Veneer Chassis		Veneer Chassis		Thermally Fused Laminate Chassis	
72 x 12	50	CPC7212TC512W	977	CPC7212TC512P	1075	CPC7212TC512G	977	CPC7212TC512M	609
66 x 12	45	CPC6612TC512W	942	CPC6612TC512P	1036	CPC6612TC512G	942	CPC6612TC512M	595
60 x 12	40	CPC6012TC512W	907	CPC6012TC512P	998	CPC6012TC512G	907	CPC6012TC512M	580
54 x 12	35	CPC5412TC512W	861	CPC5412TC512P	947	CPC5412TC512G	861	CPC5412TC512M	565
48 x 12	30	CPC4812TC512W	790	CPC4812TC512P	869	CPC4812TC512G	790	CPC4812TC512M	549
42 x 12	25	CPC4212TC512W	755	CPC4212TC512P	831	CPC4212TC512G	755	CPC4212TC512M	534
2 Select a finish <a href="#">View finish details</a>		WAC	WGW	TBCO	WSO	GAC	GNW	MAC	
		WRC	WBW	TBSW		GIC	GSTV +10%	MEC	
		WIC	WSW	TSTV		GEC	GSLV +10%	MHC	
		WEC	WNW	TSMV		GHC	GWL	MOC	
		WHC	WWP	TSLV		GOC		MGW	
		WOC		TOBW		GAM		MTW	
		WAM		WBO		GCM		MSW	
		WCM		WMO		GWM		MWL	
		WWW		WNO		GEW			
		WEW							
3 Select an edge <a href="#">View edge details</a>		+5%						+5%	
					+5%				+5%
			+5%				+5%		
4 Select hardware <a href="#">View hardware details</a>		Hardware		Hardware		Hardware		Hardware	
		N/A		N/A		N/A		N/A	

## Product features.

- Ships assembled on desk or return
- Profile edge two long edges

### NOTES

- 3" Overhang
- For use on 42" H reception desk

## Options.

### PLANK MATCH VENEER

- RPMV: Random Walnut Plank Match Veneer (Horizontal Grain with 25%+ Sap) - Add 10%. Clear coat only.

# Central park.

Reception Facade Panel Counters  
Facade Panel

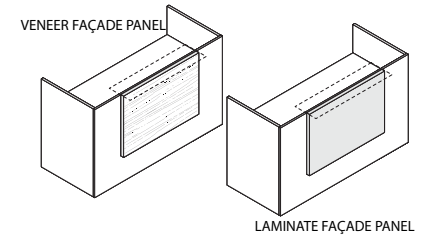

1 Select a model w" x d" x h"	weight	Standard Veneer Top Standard Veneer Chassis		Premium Veneer Top Premium Veneer Chassis		High Pressure Laminate Top Veneer Chassis		Thermally Fused Laminate Top Thermally Fused Laminate Chassis	
		72 x 1 x 30	130	CPC7230FP700W	1028	CPC7230FP700P	1131	"G" Option N/A	CPC7230FP700M
66 x 1 x 30	120	CPC6630FP700W	955	CPC6630FP700P	1051	"G" Option N/A	CPC6630FP700M	615	
60 x 1 x 30	110	CPC6030FP700W	877	CPC6030FP700P	965	"G" Option N/A	CPC6030FP700M	605	
54 x 1 x 30	100	CPC5430FP700W	805	CPC5430FP700P	886	"G" Option N/A	CPC5430FP700M	595	
48 x 1 x 30	90	CPC4830FP700W	725	CPC4830FP700P	798	"G" Option N/A	CPC4830FP700M	584	
42 x 1 x 30	80	CPC4230FP700W	654	CPC4230FP700P	719	"G" Option N/A	CPC4230FP700M	574	
2 Select a finish <i>View finish details</i>		WAC	WGW	TBCO	WSO			MAC	
		WRC	WBW	TBSW				MEC	
		WIC	WSW	TSTV				MHC	
		WEC	WNW	TSMV				MOC	
		WHC	WWP	TSLV				MGW	
		WOC		TOBW				MTW	
		WAM		WBO				MSW	
		WCM		WMO				MWL	
		WWW		WNO					
		WEW							
3 Select a edge <i>View edge details</i>		Edge							
		N/A							
4 Select hardware <i>View hardware details</i>		Hardware		Hardware				Hardware	
		N/A		N/A				N/A	

*View statement of line*

## Product features.

- Horizontal reverse slip pattern

### NOTES

- Facade Panels Can Be Attached To Desks, Bridges, Returns and Credenzas
- For use on 42" H reception desk

# central park.

Reception Facade Panel Counters  
Exotic Facade Panel

EXOTIC VENEER FAÇADE PANEL

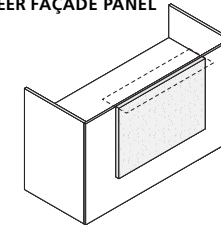

## 1 Select a model

w" x d" x h"

weight

Standard Veneer Top Standard Veneer Chassis	Premium Veneer Top Premium Veneer Chassis	High Pressure Laminate Top Veneer Chassis	Thermally Fused Laminate Top Thermally Fused Laminate Chassis
72 x 1 x 30 130 CPC7230EP700W 1621	"P" Option N/A	"G" Option N/A	"M" Option N/A
66 x 1 x 30 120 CPC6630EP700W 1538	"P" Option N/A	"G" Option N/A	"M" Option N/A
60 x 1 x 30 110 CPC6030EP700W 1437	"P" Option N/A	"G" Option N/A	"M" Option N/A
54 x 1 x 30 100 CPC5430EP700W 1361	"P" Option N/A	"G" Option N/A	"M" Option N/A
48 x 1 x 30 90 CPC4830EP700W 1218	"P" Option N/A	"G" Option N/A	"M" Option N/A
42 x 1 x 30 80 CPC4230EP700W 1129	"P" Option N/A	"G" Option N/A	"M" Option N/A

[View statement of line](#)

## 2 Select a finish

[View finish details](#)

WCF

## 3 Select a edge

[View edge details](#)

Edge  
N/A

## 4 Select hardware

[View hardware details](#)

Hardware  
N/A

## Product features.

- Horizontal reverse slip pattern

### NOTES

- Choose from Mottled Makore, Birdseye Maple, Figured Sycamore, Figured Eucalyptus and Zebra wood
- Facade Panels Can Be Attached To Desks, Bridges, Returns and Credenzas

# Central park.

Reception Desk

Freestanding - Double Pedestal

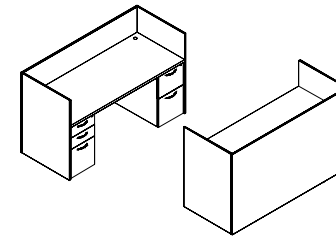

## 1 Select a model w" x d" x h"

weight	Standard Veneer Top		Premium Veneer Top		High Pressure Laminate Top		Thermally Fused Laminate Top	
	Standard Veneer Chassis		Premium Veneer Chassis		Veneer Chassis		Thermally Fused Laminate Chassis	
84 x 30 x 42	425	CPC8442RP921W 5233	CPC8442RP921P 5756	CPC8442RP921G 5233	CPC8442RP921M 2397			
72 x 30 x 42	385	CPC7242RP921W 4714	CPC7242RP921P 5185	CPC7242RP921G 4714	CPC7242RP921M 2341			
66 x 30 x 42	350	CPC6642RP921W 4623	CPC6642RP921P 5085	CPC6642RP921G 4623	CPC6642RP921M 2311			

[View statement of line](#)

## 2 Select a finish [View finish details](#)

WAC WGW  
WRC WBW  
WIC WSW  
WEC WNW  
WHC WWP  
WOC  
WAM  
WCM  
WWW  
WEW

TBCO  
TBSW  
TSTV  
TSMV  
TSLV  
TOBW  
WBO  
WMO  
WSO

GAC GNW  
GIC GSTV +10%  
GEC GSLV +10%  
GHC GWL  
GOC  
GAM  
GCM  
GWM  
GEW

MAC  
MEC  
MHC  
MOC  
MGW  
MTW  
MSW  
MWL

## 3 Select a edge [View edge details](#)



## 4 Select hardware [View hardware details](#)

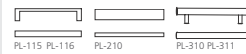
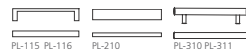
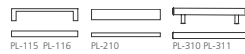

## Product features.

- 2 standard grommet - matches pull finish or specify black TM30, silver TM31 or antique brass TM33
- Box/Box/File (left)
- File/File (right)
- Full extension drawers - locking
- "W" & "G" SKUs feature soft close suspensions, "M" SKUs feature ball bearing suspensions. Both suspensions are full extension.

### NOTES

- All units are standard w/ flush ends
- Optional Countertops & Facade Panels Available On Following Pages

## Options.

### ACCESSORIES

- K28: Articulating Keyboard w/ Mouse - \$390
- K31: Center drawer - \$205

### DRAWER

- P6: Modify File/File to Box/Box/File - \$55 per pedestal
- P33: Wood Drawer Upgrade - \$45 per drawer
- WPD3061: Designer White - \$80 per door

### GROMMETS (NON-STANDARD LOCATION)

Provide drawing w/ Grommet Location and Specify Color - \$95 ea.

- Black: TM30-NS
- Silver: TM31-NS
- Antique Brass: TM33-NS

### PLANK MATCH VENEER

- RPMV: Random Walnut Plank Match Veneer (Horizontal Grain with 25%+ Sap) - Add 10%. Clear coat only.

## C157R: Reception counter fabric grades. Pricing Applies to All Sizes.

COM	COL	1	2	3
217	N/A	297	337	377
4	5	6	7	8
417	457	497	537	577
9	10	11/ L1	12	13/ L2
617	657	697	737	817



# Central park.

Reception Desk

Single Pedestal Box/Box/File

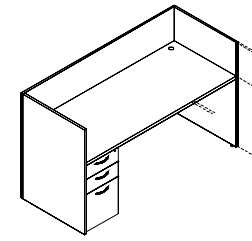

[View statement of line](#)

1 Select a model w" x d" x h"	weight	Standard Veneer Top		Premium Veneer Top		High Pressure Laminate Top		Thermally Fused Laminate Top	
		Standard Veneer Chassis		Premium Veneer Chassis		Veneer Chassis		Thermally Fused Laminate Chassis	
<b>Left Pedestal</b>									
84 x 30 x 42	395	CPC8442RP925W	4932	CPC8442RP925P	5425	CPC8442RP925G	4932	CPC8442RP925M	1975
72 x 30 x 42	350	CPC7242RP925W	4478	CPC7242RP925P	4926	CPC7242RP925G	4478	CPC7242RP925M	1920
66 x 30 x 42	320	CPC6642RP925W	4328	CPC6642RP925P	4761	CPC6642RP925G	4328	CPC6642RP925M	1890
<b>Right Pedestal</b>									
84 x 30 x 42	395	CPC8442RP924W	4932	CPC8442RP924P	5425	CPC8442RP924G	4932	CPC8442RP924M	1975
72 x 30 x 42	350	CPC7242RP924W	4478	CPC7242RP924P	4926	CPC7242RP924G	4478	CPC7242RP924M	1920
66 x 30 x 42	320	CPC6642RP924W	4328	CPC6642RP924P	4761	CPC6642RP924G	4328	CPC6642RP924M	1890

2 Select a finish <a href="#">View finish details</a>	Standard Veneer Top		Premium Veneer Top		High Pressure Laminate Top		Thermally Fused Laminate Top	
WAC	WGW	TBCO	WSO	GAC	GNW	MAC		
WRC	WBW	TBSW		GIC	GSTV +10%	MEC		
WIC	WSW	TSTV		GEC	GSLV +10%	MHC		
WEC	WNW	TSMV		GHC	GWL	MOC		
WHC	WWP	TSLV		GOC		MGW		
WOC		TOBW		GAM		MTW		
WAM		WBO		GCM		MSW		
WCM		WMO		GWM		MWL		
WWW		WNO		GEW				
WEW								

3 Select a edge <a href="#">View edge details</a>	Standard Veneer Top		Premium Veneer Top		High Pressure Laminate Top		Thermally Fused Laminate Top	
Flat	Flat	Flat	Flat	Flat	Flat	Flat	Flat	

4 Select hardware <a href="#">View hardware details</a>	Standard Veneer Top		Premium Veneer Top		High Pressure Laminate Top		Thermally Fused Laminate Top	

## Product features.

- 2 standard grommet - matches pull finish or specify black TM30, silver TM31 or antique brass TM33
- Full extension drawers - locking
- "W" & "G" SKUs feature soft close suspensions, "M" SKUs feature ball bearing suspensions. Both suspensions are full extension.

### NOTES

- All units are standard w/ flush ends
- Optional Countertops & Facade Panels Available On Following Pages

## Options.

### ACCESSORIES

- K28: Articulating Keyboard w/ Mouse - \$390
- K31: Center drawer - \$205

### DRAWER

- P6: Modify File/File to Box/Box/File - \$55 per pedestal
- P33: Wood Drawer Upgrade - \$45 per drawer
- WPD3061: Designer White - \$80 per door

### GROMMETS (NON-STANDARD LOCATION)

- Provide drawing w/ Grommet Location and Specify Color - \$95 ea.
- Black: TM30-NS
  - Silver: TM31-NS
  - Antique Brass: TM33-NS

### PLANK MATCH VENEER

- RPMV: Random Walnut Plank Match Veneer (Horizontal Grain with 25%+ Sap) - Add 10%. Clear coat only.

## C157R: Reception counter fabric grades. Pricing Applies to All Sizes.

COM	COL	1	2	3
217	N/A	297	337	377
4	5	6	7	8
417	457	497	537	577
9	10	11/ L1	12	13/ L2
617	657	697	737	817

Central park.  
Reception  
Inset Reception Counter Top

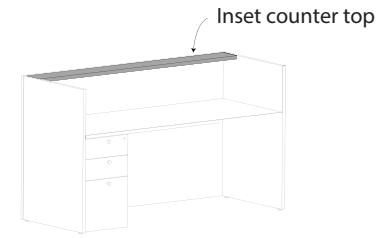

1 Select a model w" x d" x h"	weight	Standard Veneer Top		Premium Veneer Top		High Pressure Laminate Top		Thermally Fused Laminate Top	
		Standard Veneer Chassis		Premium Veneer Chassis		Veneer Chassis		Thermally Fused Laminate Chassis	
<b>Counter Top for 84" Reception Desk</b>									
82 x 9 x 1.25	35	CPC8209TC513W	1125	CPC8209TC513P	1238	CPC8209TC513G	1125	CPC8209TC513M	528
<b>Counter Top for 72" Reception Desk</b>									
70 x 9 x 1.25	30	CPC7009TC513W	973	CPC7009TC513P	1070	CPC7009TC513G	973	CPC7009TC513M	514
<b>Counter Top for 66" Reception Desk</b>									
64 x 9 x 1.25	25	CPC6409TC513W	940	CPC6409TC513P	1034	CPC6409TC513G	940	CPC6409TC513M	498
<b>2 Select a finish</b> <i>View finish details</i>		WAC	WGW	TBCO	WSO	GAC	GNW	MAC	
		WRC	WBW	TBSW		GIC	GSTV +10%	MEC	
		WIC	WSW	TSTV		GEC	GSLV +10%	MHC	
		WEC	WNW	TSMV		GHC	GWL	MOC	
		WHC	WWP	TSLV		GOC		MGW	
		WOC		TOBW		GAM		MTW	
		WAM		WBO		GCM		MSW	
		WCM		WMO		GWM		MWL	
		WWW		WNO		GEW			
		WEW							
<b>3 Select a edge</b> <i>View edge details</i>									
		Flat		Flat		Flat		Flat	
<b>4 Select hardware</b> <i>View hardware details</i>		Hardware		Hardware		Hardware		Hardware	
		N/A		N/A		N/A		N/A	

[View statement of line](#)

Product features.

**NOTES**

- Customer must specify counter top in order to specify cliff counter
- Resessed counter

Options.

**GLASS COUNTER**

Soft etch back painted white glass

- SEGW8209 82" Glass counter - \$1190
- SEGW7009 70" Glass Counter - \$1135
- SEGW6409 64" Glass Counter - \$1105
- Glass pricing option in addition to product pricing

**PLANK MATCH VENEER**

- RPMV: Random Walnut Plank Match Veneer (Horizontal Grain with 25%+ Sap) - Add 10%. Clear coat only.

# Central park.

Reception Return  
File / File

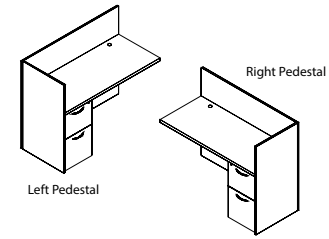

## 1 Select a model

w" x d" x h"

weight	Standard Veneer Top		Premium Veneer Top		High Pressure Laminate Top		Thermally Fused Laminate Top		
	Standard Veneer Chassis		Premium Veneer Chassis		Veneer Chassis		Thermally Fused Laminate Chassis		
<b>Left Pedestal</b>									
60 x 24 x 42	155	CPC6042RP930W	3001	CPC6042RP930P	3301	CPC6042RP930G	3001	CPC6042RP930M	1422
54 x 24 x 42	145	CPC5442RP930W	2944	CPC5442RP930P	3238	CPC5442RP930G	2944	CPC5442RP930M	1397
48 x 24 x 42	140	CPC4842RP930W	2878	CPC4842RP930P	3166	CPC4842RP930G	2878	CPC4842RP930M	1372
42 x 24 x 42	135	CPC4242RP930W	2822	CPC4242RP930P	3104	CPC4242RP930G	2822	CPC4242RP930M	1347
<b>Right Pedestal</b>									
60 x 24 x 42	155	CPC6042RP931W	3001	CPC6042RP931P	3301	CPC6042RP931G	3001	CPC6042RP931M	1422
54 x 24 x 42	145	CPC5442RP931W	2944	CPC5442RP931P	3238	CPC5442RP931G	2944	CPC5442RP931M	1397
48 x 24 x 42	140	CPC4842RP931W	2878	CPC4842RP931P	3166	CPC4842RP931G	2878	CPC4842RP931M	1372
42 x 24 x 42	135	CPC4242RP931W	2822	CPC4242RP931P	3104	CPC4242RP931G	2822	CPC4242RP931M	1347

[View statement of line](#)

## 2 Select a finish

[View finish details](#)

WAC    WGW  
WRC    WBW  
WIC    WSW  
WEC    WNW  
WHC    WWP  
WOC  
WAM  
WCM  
WWM  
WEW

TBCO    WSO  
TBSW  
TSTV  
TSMV  
TSLV  
TOBW  
WBO  
WMO  
WNO

GAC    GNW  
GIC    GSTV +10%  
GEC    GSLV +10%  
GHC    GWL  
GOC  
GAM  
GCM  
GWM  
GEW

MAC  
MEC  
MHC  
MOC  
MGW  
MTW  
MSW  
MWL

## 3 Select a edge

[View edge details](#)



## 4 Select hardware

[View hardware details](#)

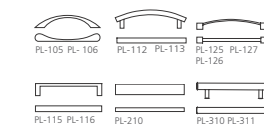
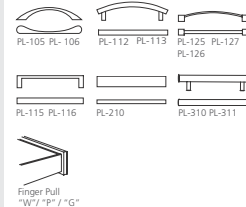
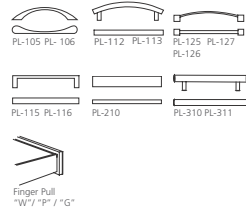
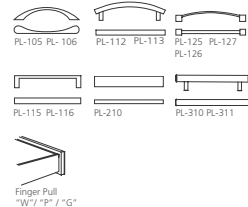

## Product features.

- 1 Standard grommet - matches pull finish or specify black TM30, silver TM31 or antique brass TM33
- Finished back - open plan
- Full extension drawers - locking
- "W" & "G" SKUs feature soft close suspensions, "M" SKUs feature ball bearing suspensions. Both suspensions are full extension.

## Options.

### ACCESSORIES

- K28: Articulating Keyboard w/ Mouse - \$390

### CHASSIS

- HE1-WG: Modify for connection to lift desk unit with 1/2 depth end support ("W"/"G" units) - \$160
- HE1-M: Modify for connection to lift desk unit with 1/2 depth end support ("M" units) - \$105

### DRAWER

- P6: Modify File/File to Box/Box/File - \$55 per pedestal
- P33: Wood Drawer Upgrade - \$45 per drawer
- P40W: extra Box/Box/File or File/File to Kneespace - \$910 (N/A on 58") (W,G)
- P40M: extra Box/Box/File or File/File to Kneespace - \$720 (N/A on 58") (M)
- WPD3061: Designer White - \$80 per door

### GROMMETS (NON-STANDARD LOCATION)

- Provide drawing w/ Grommet Location and Specify Color - \$95 ea.
- Black: TM30-NS
- Silver: TM31-NS
- Antique Brass: TM33-NS

### PLANK MATCH VENEER

- RPMV: Random Walnut Plank Match Veneer (Horizontal Grain with 25%+ Sap) - Add 10%. Clear coat only.

## C154R: Reception counter fabric grades. Pricing Applies to All Sizes.

COM	COL	1	2	3
214	N/A	246	262	278
4	5	6	7	8
294	310	326	342	358
9	10	11/ L1	12	13/ L2
374	390	406	422	454

# Central park.

Reception Return  
Lateral File

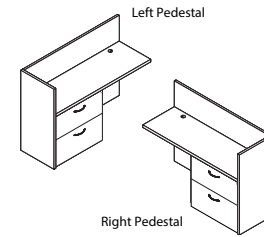

## 1 Select a model

w" x d" x h"

weight	Standard Veneer Top		Premium Veneer Top		High Pressure Laminate Top		Thermally Fused Laminate Top		
	Standard Veneer Chassis		Premium Veneer Chassis		Veneer Chassis		Thermally Fused Laminate Chassis		
<b>Left Pedestal</b>									
72 x 24 x 42	270	CPC7242RP932W	3683	CPC7242RP932P	4051	CPC7242RP932G	3683	"M" Option N/A	
66 x 24 x 42	250	CPC6642RP932W	3539	CPC6642RP932P	3893	CPC6642RP932G	3539	"M" Option N/A	
60 x 24 x 42	235	CPC6042RP932W	3404	CPC6042RP932P	3744	CPC6042RP932G	3404	CPC6042RP932M	1624
54 x 24 x 42	205	CPC5442RP932W	3338	CPC5442RP932P	3672	CPC5442RP932G	3338	CPC5442RP932M	1600
48 x 24 x 42	195	CPC4842RP932W	3274	CPC4842RP932P	3601	CPC4842RP932G	3274	CPC4842RP932M	1575
<b>Right Pedestal</b>									
72 x 24 x 42	270	CPC7242RP933W	3683	CPC7242RP933P	4051	CPC7242RP933G	3683	"M" Option N/A	
66 x 24 x 42	250	CPC6642RP933W	3539	CPC6642RP933P	3893	CPC6642RP933G	3539	"M" Option N/A	
60 x 24 x 42	235	CPC6042RP933W	3404	CPC6042RP933P	3744	CPC6042RP933G	3404	CPC6042RP933M	1624
54 x 24 x 42	205	CPC5442RP933W	3338	CPC5442RP933P	3672	CPC5442RP933G	3338	CPC5442RP933M	1600
48 x 24 x 42	195	CPC4842RP933W	3274	CPC4842RP933P	3601	CPC4842RP933G	3274	CPC4842RP933M	1575

View statement of line

## 2 Select a finish

View finish details

WAC WGW  
WRC WBW  
WIC WSW  
WEC WNW  
WHC WWP  
WOC  
WAM  
WCM  
WWW  
WEW

TBCO WSO  
TBSW  
TSTV  
TSMV  
TSLV  
TOBW  
WBO  
WMO  
WNO

GAC GNW  
GIC GSTV +10%  
GEC GSLV +10%  
GHC GWL  
GOC  
GAM  
GCM  
GWM  
GEW

MAC  
MEC  
MHC  
MOC  
MGW  
MTW  
MSW  
MWL

## 3 Select a edge

View edge details



## 4 Select hardware

View hardware details

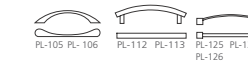

## Product features.

- 1 Standard grommet - matches pull finish or specify black TM30, silver TM31 or antique brass TM33
- Finished back - open plan
- Full extension drawers - locking
- "W" & "G" SKUs feature soft close suspensions, "M" SKUs feature ball bearing suspensions. Both suspensions are full extension.

## Options.

### ACCESSORIES

- K28: Articulating Keyboard w/ Mouse - \$390

### DRAWER

- P33: Wood Drawer Upgrade - \$45 per drawer
- P40W: extra Box/Box/File or File/File to Kneespace - \$910 (N/A on 58") (W,G)
- P40M: extra Box/Box/File or File/File to Kneespace - \$720 (N/A on 58") (M)
- WPD3061: Designer White - \$160 per lateral door

### GROMMETS (NON-STANDARD LOCATION)

- Provide drawing w/ Grommet Location and Specify Color - \$95 ea.
- Black: TM30-NS
  - Silver: TM31-NS
  - Antique Brass: TM33-NS

### PLANK MATCH VENEER

- RPMV: Random Walnut Plank Match Veneer (Horizontal Grain with 25%+ Sap) - Add 10%. Clear coat only.

## C154R: Reception counter fabric grades. Pricing Applies to All Sizes.

COM	COL	1	2	3
217	N/A	297	337	377
4	5	6	7	8
417	457	497	537	577
9	10	11/ L1	12	13/ L2
617	657	697	737	817

# Central park.

Sit-On Reception Counters  
Return Gallery

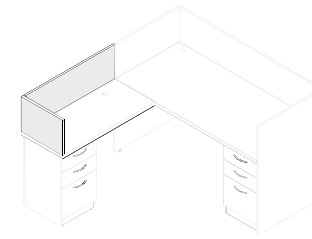

[View statement of line](#)

1 Select a model w" x d" x h"	weight	Standard Veneer Top Standard Veneer Chassis		Premium Veneer Top Premium Veneer Chassis		High Pressure Laminate Top Veneer Chassis		Thermally Fused Laminate Top Thermally Fused Laminate Chassis																																																																																																																									
		<p><b>Left Hookup</b></p> <table border="1"> <tr><td>72 x 22 x 14</td><td>65</td><td>CPC7222AU598W</td><td>1631</td><td>CPC7222AU598P</td><td>1794</td><td>"G" Option N/A</td><td>"M" Option N/A</td><td></td><td></td></tr> <tr><td>66 x 22 x 14</td><td>60</td><td>CPC6622AU598W</td><td>1480</td><td>CPC6622AU598P</td><td>1628</td><td>"G" Option N/A</td><td>"M" Option N/A</td><td></td><td></td></tr> <tr><td>60 x 22 x 14</td><td>55</td><td>CPC6022AU598W</td><td>1328</td><td>CPC6022AU598P</td><td>1461</td><td>"G" Option N/A</td><td>CPC6022AU598M</td><td>722</td><td></td></tr> <tr><td>54 x 22 x 14</td><td>50</td><td>CPC5422AU598W</td><td>1178</td><td>CPC5422AU598P</td><td>1296</td><td>"G" Option N/A</td><td>CPC5422AU598M</td><td>640</td><td></td></tr> <tr><td>48 x 22 x 14</td><td>45</td><td>CPC4822AU598W</td><td>1028</td><td>CPC4822AU598P</td><td>1131</td><td>"G" Option N/A</td><td>CPC4822AU598M</td><td>560</td><td></td></tr> <tr><td>42 x 22 x 14</td><td>40</td><td>CPC4222AU598W</td><td>877</td><td>CPC4222AU598P</td><td>965</td><td>"G" Option N/A</td><td>CPC4222AU598M</td><td>478</td><td></td></tr> </table> <p><b>Right Hookup</b></p> <table border="1"> <tr><td>72 x 22 x 14</td><td>65</td><td>CPC7222AU599W</td><td>1631</td><td>CPC7222AU599P</td><td>1794</td><td>"G" Option N/A</td><td>"M" Option N/A</td><td></td><td></td></tr> <tr><td>66 x 22 x 14</td><td>60</td><td>CPC6622AU599W</td><td>1480</td><td>CPC6622AU599P</td><td>1628</td><td>"G" Option N/A</td><td>"M" Option N/A</td><td></td><td></td></tr> <tr><td>60 x 22 x 14</td><td>55</td><td>CPC6022AU599W</td><td>1178</td><td>CPC6022AU599P</td><td>1296</td><td>"G" Option N/A</td><td>CPC6022AU599M</td><td>722</td><td></td></tr> <tr><td>54 x 22 x 14</td><td>50</td><td>CPC5422AU599W</td><td>1178</td><td>CPC5422AU599P</td><td>1296</td><td>"G" Option N/A</td><td>CPC5422AU599M</td><td>640</td><td></td></tr> <tr><td>48 x 22 x 14</td><td>45</td><td>CPC4822AU599W</td><td>1028</td><td>CPC4822AU599P</td><td>1131</td><td>"G" Option N/A</td><td>CPC4822AU599M</td><td>560</td><td></td></tr> <tr><td>42 x 22 x 14</td><td>40</td><td>CPC4222AU599W</td><td>877</td><td>CPC4222AU599P</td><td>965</td><td>"G" Option N/A</td><td>CPC4222AU599M</td><td>478</td><td></td></tr> </table>										72 x 22 x 14	65	CPC7222AU598W	1631	CPC7222AU598P	1794	"G" Option N/A	"M" Option N/A			66 x 22 x 14	60	CPC6622AU598W	1480	CPC6622AU598P	1628	"G" Option N/A	"M" Option N/A			60 x 22 x 14	55	CPC6022AU598W	1328	CPC6022AU598P	1461	"G" Option N/A	CPC6022AU598M	722		54 x 22 x 14	50	CPC5422AU598W	1178	CPC5422AU598P	1296	"G" Option N/A	CPC5422AU598M	640		48 x 22 x 14	45	CPC4822AU598W	1028	CPC4822AU598P	1131	"G" Option N/A	CPC4822AU598M	560		42 x 22 x 14	40	CPC4222AU598W	877	CPC4222AU598P	965	"G" Option N/A	CPC4222AU598M	478		72 x 22 x 14	65	CPC7222AU599W	1631	CPC7222AU599P	1794	"G" Option N/A	"M" Option N/A			66 x 22 x 14	60	CPC6622AU599W	1480	CPC6622AU599P	1628	"G" Option N/A	"M" Option N/A			60 x 22 x 14	55	CPC6022AU599W	1178	CPC6022AU599P	1296	"G" Option N/A	CPC6022AU599M	722		54 x 22 x 14	50	CPC5422AU599W	1178	CPC5422AU599P	1296	"G" Option N/A	CPC5422AU599M	640		48 x 22 x 14	45	CPC4822AU599W	1028	CPC4822AU599P	1131	"G" Option N/A	CPC4822AU599M	560		42 x 22 x 14	40	CPC4222AU599W	877	CPC4222AU599P	965	"G" Option N/A	CPC4222AU599M
72 x 22 x 14	65	CPC7222AU598W	1631	CPC7222AU598P	1794	"G" Option N/A	"M" Option N/A																																																																																																																										
66 x 22 x 14	60	CPC6622AU598W	1480	CPC6622AU598P	1628	"G" Option N/A	"M" Option N/A																																																																																																																										
60 x 22 x 14	55	CPC6022AU598W	1328	CPC6022AU598P	1461	"G" Option N/A	CPC6022AU598M	722																																																																																																																									
54 x 22 x 14	50	CPC5422AU598W	1178	CPC5422AU598P	1296	"G" Option N/A	CPC5422AU598M	640																																																																																																																									
48 x 22 x 14	45	CPC4822AU598W	1028	CPC4822AU598P	1131	"G" Option N/A	CPC4822AU598M	560																																																																																																																									
42 x 22 x 14	40	CPC4222AU598W	877	CPC4222AU598P	965	"G" Option N/A	CPC4222AU598M	478																																																																																																																									
72 x 22 x 14	65	CPC7222AU599W	1631	CPC7222AU599P	1794	"G" Option N/A	"M" Option N/A																																																																																																																										
66 x 22 x 14	60	CPC6622AU599W	1480	CPC6622AU599P	1628	"G" Option N/A	"M" Option N/A																																																																																																																										
60 x 22 x 14	55	CPC6022AU599W	1178	CPC6022AU599P	1296	"G" Option N/A	CPC6022AU599M	722																																																																																																																									
54 x 22 x 14	50	CPC5422AU599W	1178	CPC5422AU599P	1296	"G" Option N/A	CPC5422AU599M	640																																																																																																																									
48 x 22 x 14	45	CPC4822AU599W	1028	CPC4822AU599P	1131	"G" Option N/A	CPC4822AU599M	560																																																																																																																									
42 x 22 x 14	40	CPC4222AU599W	877	CPC4222AU599P	965	"G" Option N/A	CPC4222AU599M	478																																																																																																																									
2 Select a finish <a href="#">View finish details</a>		WAC	WGW	TBCO	WSO		MAC																																																																																																																										
		WRC	WBW	TBSW			MEC																																																																																																																										
		WIC	WSW	TSTV			MHC																																																																																																																										
		WEC	WNW	TSMV			MOC																																																																																																																										
		WHC	WWP	TSLV			MGW																																																																																																																										
		WOC		TOBW			MTW																																																																																																																										
		WAM		WBO			MSW																																																																																																																										
		WCM		WMO			MWL																																																																																																																										
		WWW		WNO																																																																																																																													
		WEW																																																																																																																															
3 Select a edge <a href="#">View edge details</a>		Edge		Edge			Edge																																																																																																																										
		N/A		N/A			N/A																																																																																																																										
4 Select hardware <a href="#">View hardware details</a>		Hardware		Hardware			Hardware																																																																																																																										
		N/A		N/A			N/A																																																																																																																										

## Product features.

- Alignment pins in unit below

### NOTES

- For use on standard 29" H desks

## C157R: Reception counter fabric grades. Pricing Applies to All Sizes.

COM	COL	1	2	3
217	N/A	297	337	377
4	5	6	7	8
417	457	497	537	577
9	10	11/ L1	12	13/ L2
617	657	697	737	817

# Central park.

Reception Bridge  
Standard "U" Bridge

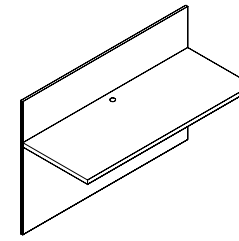

1 Select a model w" x d" x h"	weight	Standard Veneer Top Standard Veneer Chassis		Premium Veneer Top Premium Veneer Chassis		High Pressure Laminate Top Veneer Chassis		Thermally Fused Laminate Top Thermally Fused Laminate Chassis	
		48 x 24 x 42	140	CPC4842RP164W	1011	CPC4842RP164P	1112	CPC4842RP164G	1011

2 Select a finish <i>View finish details</i>	Standard Veneer Top		Premium Veneer Top		High Pressure Laminate Top		Thermally Fused Laminate Top	
	<i>View finish details</i>	WAC	WGW	TBCO	WSO	GAC	GNW	MAC
	WRC	WBW	TBSW		GIC	GSTV +10%	MEC	
	WIC	WSW	TSTV		GEC	GSLV +10%	MHC	
	WEC	WNW	TSMV		GHC	GWL	MOC	
	WHC	WWP	TSLV		GOC		MGW	
	WOC		TOBW		GAM		MTW	
	WAM		WBO		GCM		MSW	
	WCM		WMO		GWM		MWL	
	WWW		WNO		GEW			
	WEW							

3 Select an edge <i>View edge details</i>	Standard Veneer Top		Premium Veneer Top		High Pressure Laminate Top		Thermally Fused Laminate Top	
	<i>View edge details</i>	Flat		Flat		Flat		Flat

4 Select hardware <i>View hardware details</i>	Standard Veneer Top		Premium Veneer Top		High Pressure Laminate Top		Thermally Fused Laminate Top	
	<i>View hardware details</i>	Hardware N/A		Hardware N/A		Hardware N/A		Hardware N/A

[View statement of line](#)

## Product features.

- 1 Standard grommet - matches pull finish or specify black TM30, silver TM31 or antique brass TM33
- Finished back - open plan

## Options.

### GROMMETS (NON-STANDARD LOCATION)

- Provide drawing w/ Grommet Location and Specify Color - \$95 ea.
- Black: TM30-NS
  - Silver: TM31-NS
  - Antique Brass: TM33-NS

### PLANK MATCH VENEER

- RPMV: Random Walnut Plank Match Veneer (Horizontal Grain with 25%+ Sap) - Add 10%. Clear coat only.

## C157R: Reception counter fabric grades. Pricing Applies to All Sizes.

COM	COL	1	2	3
217	N/A	297	337	377
4	5	6	7	8
417	457	497	537	577
9	10	11/ L1	12	13/ L2
617	657	697	737	817

# Central park.

Standard Reception "U" Credenzas  
File / File

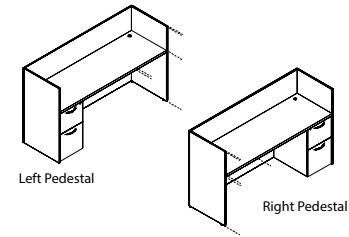

## 1 Select a model

w" x d" x h"

weight	Standard Veneer Top Standard Veneer Chassis		Premium Veneer Top Premium Veneer Chassis		High Pressure Laminate Top Veneer Chassis		Thermally Fused Laminate Top Thermally Fused Laminate Chassis				
	<b>Left Pedestal</b> 72 x 24 x 42	275	CPC7242RP938W 3401	CPC7242RP938P 3741	CPC7242RP938G 3401	CPC7242RP938M 1839	<b>Right Pedestal</b> 72 x 24 x 42	275	CPC7242RP939W 3401	CPC7242RP939P 3741	CPC7242RP939G 3401

[View statement of line](#)

## 2 Select a finish

[View finish details](#)

WAC WGW  
WRC WBW  
WIC WSW  
WEC WNW  
WHC WWP  
WOC  
WAM  
WCM  
WWW  
WEW

TBCO WSO  
TBSW  
TSTV  
TSMV  
TSLV  
TOBW  
WBO  
WMO  
WNO

GAC GNW  
GIC GSTV +10%  
GEC GSLV +10%  
GHC GWL  
GOC  
GAM  
GCM  
GWM  
GEW

MAC  
MEC  
MHC  
MOC  
MGW  
MTW  
MSW  
MWL

## 3 Select a edge

[View edge details](#)



## 4 Select hardware

[View hardware details](#)

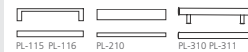
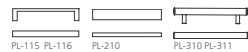
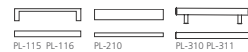

## Product features.

- 2 standard grommet - matches pull finish or specify black TM30, silver TM31 or antique brass TM33
- Finished back - open plan
- Full extension drawers - locking
- "W" & "G" SKUs feature soft close suspensions, "M" SKUs feature ball bearing suspensions. Both suspensions are full extension.

## Options.

### ACCESSORIES

- K28: Articulating Keyboard w/ Mouse - \$390

### DRAWER

- P33: Wood Drawer Upgrade - \$45 per drawer
- WPD3061: Designer White - \$80 per door

### GROMMETS (NON-STANDARD LOCATION)

Provide drawing w/ Grommet Location and Specify Color - \$95 ea.

- Black: TM30-NS
- Silver: TM31-NS
- Antique Brass: TM33-NS

### PLANK MATCH VENEER

- RPMV: Random Walnut Plank Match Veneer (Horizontal Grain with 25%+ Sap) - Add 10%. Clear coat only.

### STORAGE

- P6: Modify File/File to Box/Box/File - \$55 per pedestal
- P33: Wood Drawer Upgrade - \$45 per drawer
- P40W: extra Box/Box/File or File/File to Kneespace - \$910 (N/A on 58") (W,G)
- P40M: extra Box/Box/File or File/File to Kneespace - \$720 (N/A on 58") (M)

## C154R: Reception counter fabric grades. Pricing Applies to All Sizes.

COM	COL	1	2	3
217	N/A	297	337	377
4	5	6	7	8
417	457	497	537	577
9	10	11/ L1	12	13/ L2
617	657	697	737	817

# Central park.

Standard Reception "U" Credenzas  
Lateral File

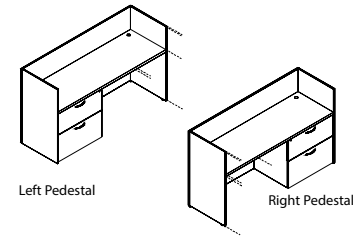

## 1 Select a model

w" x d" x h"

weight	Standard Veneer Top		Premium Veneer Top		High Pressure Laminate Top		Thermally Fused Laminate Top		
	Standard Veneer Chassis		Premium Veneer Chassis		Veneer Chassis		Thermally Fused Laminate Chassis		
<b>Left Pedestal</b>									
89 x 24 x 42	395	CPC8942RP940W	3924	CPC8942RP940P	4316	CPC8942RP940G	3924	CPC8942RP940M	2098
72 x 24 x 42	300	CPC7242RP940W	3541	CPC7242RP940P	3895	CPC7242RP940G	3541	CPC7242RP940M	2043
66 x 24 x 42	285	CPC6642RP940W	3411	CPC6642RP940P	3752	CPC6642RP940G	3411	CPC6642RP940M	2011
<b>Right Pedestal</b>									
89 x 24 x 42	395	CPC8942RP941W	3924	CPC8942RP941P	4316	CPC8942RP941G	3924	CPC8942RP941M	2098
72 x 24 x 42	300	CPC7242RP941W	3541	CPC7242RP941P	3895	CPC7242RP941G	3541	CPC7242RP941M	2043
66 x 24 x 42	285	CPC6642RP941W	3411	CPC6642RP941P	3752	CPC6642RP941G	3411	CPC6642RP941M	2011

View statement of line

## 2 Select a finish

View finish details

WAC WGW  
WRC WBW  
WIC WSW  
WEC WNW  
WHC WWP  
WOC  
WAM  
WCM  
WWM  
WEW

TBCO WSO  
TBSW  
TSTV  
TSMV  
TSLV  
TOBW  
WBO  
WMO  
WNO

GAC GNW  
GIC GSTV +10%  
GEC GSLV +10%  
GHC GWL  
GOC  
GAM  
GCM  
GWM  
GEW

MAC  
MEC  
MHC  
MOC  
MGW  
MTW  
MSW  
MWL

## 3 Select a edge

View edge details



## 4 Select hardware

View hardware details

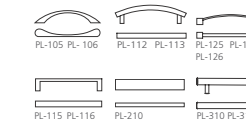
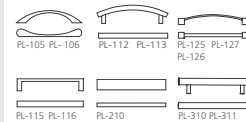
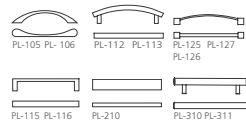
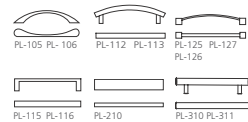

## Product features.

- 2 standard grommet - matches pull finish or specify black TM30, silver TM31 or antique brass TM33
- Finished back - open plan
- Full extension drawers - locking
- "W" & "G" SKUs feature soft close suspensions, "M" SKUs feature ball bearing suspensions. Both suspensions are full extension.

## Options.

### ACCESSORIES

- K28: Articulating Keyboard w/ Mouse - \$390

### DRAWER

- P33: Wood Drawer Upgrade - \$45 per drawer
- WPD3061: Designer White - \$160 per lateral door

### GROMMETS (NON-STANDARD LOCATION)

Provide drawing w/ Grommet Location and Specify Color - \$95 ea.

- Black: TM30-NS
- Silver: TM31-NS
- Antique Brass: TM33-NS

### PLANK MATCH VENEER

- RPMV: Random Walnut Plank Match Veneer (Horizontal Grain with 25%+ Sap) - Add 10%. Clear coat only.

### STORAGE

- P6: Modify File/File to Box/Box/File - \$55 per pedestal
- P33: Wood Drawer Upgrade - \$45 per drawer
- P40W: extra Box/Box/File or File/File to Kneespace - \$910 (N/A on 58") (W,G)
- P40M: extra Box/Box/File or File/File to Kneespace - \$720 (N/A on 58") (M)

## C154R: Reception counter fabric grades. Pricing Applies to All Sizes.

COM	COL	1	2	3
217	N/A	297	337	377
4	5	6	7	8
417	457	497	537	577
9	10	11/ L1	12	13/ L2
617	657	697	737	817



Central park options.

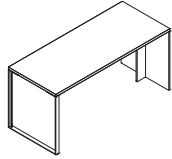

BASE MODIFICATIONS  
*runoff sleigh base*

Style Number	List Price
24" Metal Sleigh Base SSB24	450
30" Metal Sleigh Base SSB30	475
36" Metal Sleigh Base SSB36	495

Specifications

- Metal Sleigh base - standard in silver finish

COMPUTER SUPPORT  
*single monitor arm*

Style Number	List Price
MA1	280

Specifications

- Available in black or silver
- Desk clamp and mounting included
- Easy assembly and flexibility
- Elastic painting process for a durable and beautiful finish
- Gas spring tension adjustment for counter-balance height adjustment for monitors 1-8 KG
- Gas spring tested to 50,000 repetitions
- Hidden cable management
- Monitor arm will hold 15"-27" monitors and up to 18lbs

COMPUTER SUPPORT  
*double monitor arm*

Style Number	List Price
MA2	450

Specifications

- Available in black or silver
- Desk clamp and mounting included
- Easy assembly and flexibility
- Elastic painting process for a durable and beautiful finish
- Gas spring tension adjustment for counter-balance height adjustment for monitors 1-8 KG
- Gas spring tested to 50,000 repetitions
- Hidden cable management
- Monitor arm will hold 15"-27" monitors and up to 18lbs

COMPUTER SUPPORT  
*triple monitor arm*

Style Number	List Price
MA3	530

Specifications

- Available in black or silver
- Desk clamp and mounting included
- Easy assembly and flexibility
- Elastic painting process for a durable and beautiful finish
- Gas spring tension adjustment for counter-balance height adjustment for monitors 1-8 KG
- Gas spring tested to 50,000 repetitions
- Hidden cable management
- Monitor arm will hold 15"-27" monitors and up to 18lbs

Central park options.



COMPUTER SUPPORT  
*quadruple monitor arm*

Style Number	List Price
MA4	705

Specifications

- Available in black
- Desk clamp and mounting included
- Easy assembly and flexibility
- Elastic painting process for a durable and beautiful finish
- Gas spring tension adjustment for counter-balance height adjustment for monitors 1-8 KG
- Gas spring tested to 50,000 repetitions
- Hidden cable management
- Monitor arm will hold 15"-27" monitors and up to 18lbs

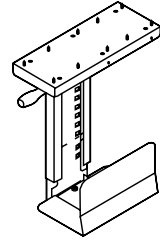

COMPUTER SUPPORT  
*cpu retractable cradle*

Style Number	List Price
K18	205

Specifications

- Black Metal CPU Carriage
- Full 360° swivel capability allows easy access to rear of CPU for cables / wires
- Track allows 8- 1/2" extension
- Width Adjustment 5-1/2" to 9-1/4"
- Height adjustment 14- 5/8" to 20- 1/2"
- Black epoxy finish

- Notes
- Factory Installed

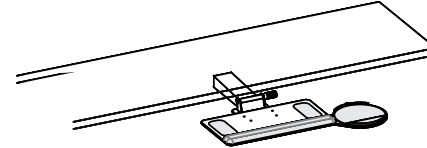

COMPUTER SUPPORT  
*articulating keyboard tray*

Style Number	List Price
Factory Installed K28	395
Field Installed K28F	415

Specifications

- Adjusts effortlessly - A simple one-handed motion allows the keyboard to be repositioned instantly, without the use of locks or levers
- Encourages low-risk postures - Maximizes adjustability within a safe operating range.
- Will last a lifetime - Exceeds all applicable BIFMA Standards and comes with a lifetime guarantee.

- Notes
- Available on: Freestanding Desk
  - Factory Installed (standard)
  - FIELD INSTALL - \$415

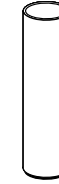

CONFERENCE DESK SUPPORT POST  
*wood drum*

Style Number	List Price
6" Diameter Drum B6	415

Specifications

- Available in Walnut / Cherry / Maple
- Adjustable levelers
- Replaces standard metal round legs

- Notes
- Specify Finish
  - Not available in Thermally Fused Laminate

Central park options.

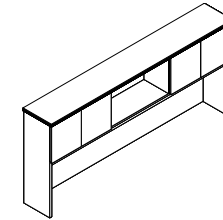
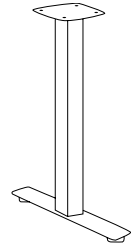
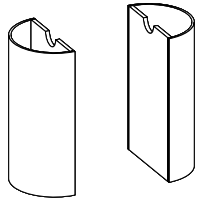

CONFERENCE DESK SUPPORT POST  
*wood half drum*

CONFERENCE DESK SUPPORT POST  
*metal column t-leg*

DOOR MODIFICATIONS  
*soft close door hinge*

DOOR MODIFICATIONS  
*delete doors*

Style Number	List Price
8" Half Drum HC08	725
16" Diameter Drum HC16	935

Style Number	List Price
Silver 32MOTS	485
Black 32MOTB	485

Style Number	List Price
D9SC	20 Per door

Style Number	List Price
D6	N/C

**Specifications**

- Available in Walnut / Cherry / Maple
- Adjustable levelers

- Notes
- Specify Finish

**Specifications**

- Available with casters
- Recommended top size: 36"D-42"D
- Single column: 2-3/4" x 2-3/4" with 32" foot
- Standard Silver base (optional Black)

**Specifications**

- Snap onto standard door hinge
- Requires (2) per door
- Max door height 43"
- Factory installed where specified
- Individually shipped for field installation

- Notes
- Specify Each Item To Have Slow Close Feature

**Specifications**

- Standard Door overheads and cabinets can have door deleted for open access. Modification of hinge rails and structural components are made face ready.

Central park options.

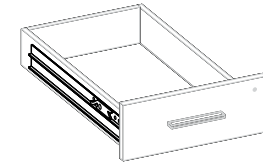
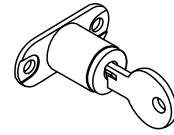
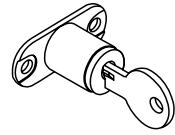
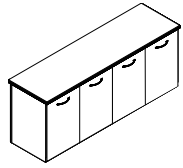

**DOOR MODIFICATIONS**  
*delete doors/replace black laminate shelf w/ finished shelf*

Style Number	List Price
D6A	N/C

**Specifications**

- Delete doors and replace black laminate shelf with finished shelf

Notes  
 - Available on: All Storage "W"/"G" Style Credenzas.

**DOOR MODIFICATIONS**  
*panel door lock*

Style Number	List Price
D2	100 Per door set

**Specifications**

- Door Locks - 1 Door w/ Lock, Other Door w/ Catch Latch  
 - Contact Customer Service regarding limited lock locations and keying.

Notes  
 - Available on: Panel Doors, Wood Frame Doors, and Silverluma doors

**DOOR MODIFICATIONS**  
*glass door lock*

Style Number	List Price
D2-G	205 Per door set

**Specifications**

- Door Locks - 1 Door w/ Lock, Other Door w/ Catch Latch  
 - Contact Customer Service regarding limited lock locations and keying.

Notes  
 - Available on: Glass Doors

**DRAWER OPTIONS**  
*soft close suspension*

Style Number	List Price
SCS1	25 Per drawer

**Specifications**

- Factory installed where specified

Notes  
 - Not recommended for field installation

Central park options.

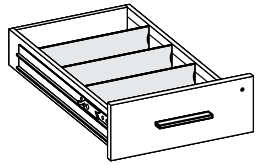

**DRAWER OPTIONS**  
*box drawer accessories*

Style Number	List Price
Wood Drawer Dividers w/ Clips K-DIV	SET OF 3 - 30
Single Tray - Utility Tray K-SUT	35 ea.

**Specifications**

- K-DIV Extra Wood Drawer Dividers with Clips, Top Box drawers standard with 1 divider
- K-SUT Single Tray - Utility Tray, Specify Legal or Letter drawer width

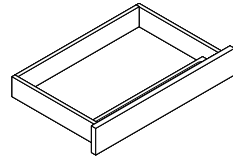

**DRAWER OPTIONS**  
*finished center drawer*

Style Number	List Price
K31	205
Add Skirt Option K31-SK	310

**Specifications**

- Veneer drawer front finished to match unit W or G style veneer.
- Ball bearing smooth operation
- Drawer has lifetime guarantee
- Standard with matching wood grain pencil tray
- Laminate drawer front to match laminate unit (M style)

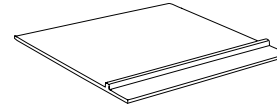

**DRAWER OPTIONS - BOTTOM COVER**  
*felt bottom center drawer insert liner*

Style Number	List Price
K3	100

**Specifications**

- Inserts into center drawer and features divider for open pen and pencil storage. Removable for easy cleaning.
- Adds a luxurious touch to center drawers.
- Color: Dark Brown Coal

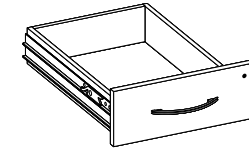

**DRAWER OPTIONS - UPGRADE**  
*wood drawer upgrade*

Style Number	List Price
P33	45 Per drawer

**Specifications**

- Dowel joint construction
- Hardwood veneer multi-ply drawer
- UV finish
- 1/4" Wood veneer bottoms
- File drawer bottoms are five block reinforced for heavy weight capacity
- Lifetime guaranteed

## Central park options.

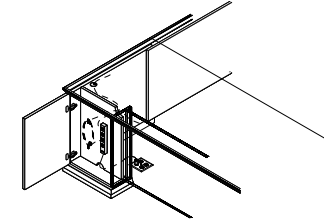
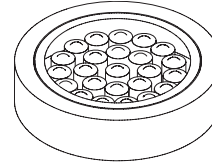

### GLASSBOARD ACCESSORIES *glassboard accessory kit*

Style Number	List Price
GBKIT	290

### Specifications

- 8 Earth magnets, 1 magnetic marker cup holder and 1 magnetic dry eraser

### RECESSED LIGHTING *lt-led task light*

Style Number	List Price
24" Task light LT-LED24R	190
48" Task light LT-LED48R	245
60" Task light LT-LED60R	310
72" Task light LT-LED72R	335
Recessed strip light OCG Occupancy Switch for recessed LED light 50	

### Specifications

- 6.5' Power cord. Switch with touch dimmer
- 36 LEDs per foot
- 4.6 Watts per foot
- 91 Lumens per watt
- Please note when ganging.
- Overhead tasklight cord is located on the right facing side. If the opposite location is required please contact customer service.

### LIGHTING *led interior cabinet puck light*

Style Number	List Price
Starter Kit LEDPK	310
1 LED Interior Puck Light PK	130

### Specifications

- Starter kit includes Infeed, 1 Puck Interior Light and the ability to daisy chain up to 6 total Puck Lights
- (1) LED Puck Light with 30W power drive and switch
- Recessed fixture
- 12V linking cord 98"L
- Silver finish
- 50,000 hour life
- 2 watt per light

#### Notes

- Available on: Overhead/Tower Units with glass doors or no doors
- Power drive included, Light only

### PEDESTAL MODIFICATIONS *breakfront pedestal with wire management cavity door*

Style Number	List Price
PC10 Power Supply Cordset PD717	100
	100

### Specifications

- Hinged pedestal front door offers easy access for wire management
- Wire hooks provide wire coil storage
- Wire access openings allow access to floor, cabinets interior and kneespace
- Cabinet interior is black finish
- Top grommet is positioned over cavity for access ease
- (Power Strip Optional)

#### Notes

- Breakfront Chassis Only

Central park options.

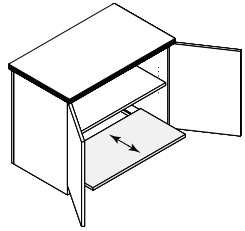

PEDESTAL MODIFICATIONS  
black laminate printer pullout bottom shelf

Style Number	List Price
PPOS	225

Specifications

- Black Laminate pullout shelf on suspension
- Black grommet in back
- Adjustable Shelf

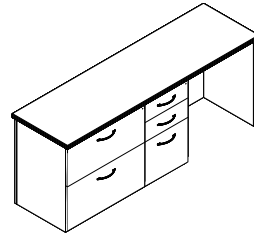

PEDESTAL MODIFICATIONS  
add veneer kneespace cabinets - no base

Style Number	List Price
Add Box/Box/File or File/File P40W	910
Add Lateral File 29" W P41W	1025
Add Multi-File - 31"W P42W	1140
Add Storage With Doors 29"W P43W	1025
Add CPU /Printer Cabinet - Open P44W	1025

Specifications

- Multi-file specify Box/Box Left or Right
- Notes
- Add additional Standard Cabinets To Kneespace Area.

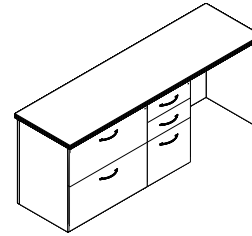

PEDESTAL MODIFICATIONS  
add melamine (tfl) kneespace cabinets - no base

Style Number	List Price
Add Box/Box/File or File/File P40M	720
Add Lateral File 29" W P41M	890
Add Multi-File - 31"W P42M	1005
Add Storage With Doors 29"W P43M	800
Add CPU /Printer Cabinet - Open P44M	915

Specifications

- Multi-file specify Box/Box Left or Right
- Notes
- Available on: TFL products
  - Add additional Standard Cabinets To Kneespace Area.

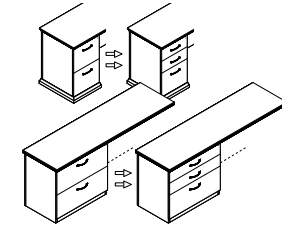

PEDESTAL MODIFICATIONS  
modify drawer configurations

Style Number	List Price
File/File to Box/Box/File P6	55 Per ped
Box/Box/File to File/File P6	55 Per ped
Lateral File to 2 Box Drawers P8	100 Per ped

Specifications

- Modify File/File To Box/Box/File - Any Unit

Central park options.

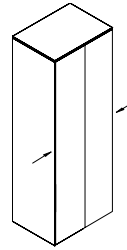
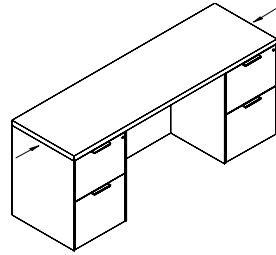
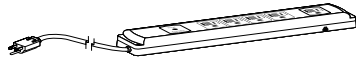

POWER / DATA  
*power supply cordset*

Style Number	List Price
PD717	100

Specifications

- SIZE: 10.75"L x 2.0"W x 1.06"H
- (5) Outlets w/ 10' cord
- Surge suppression (720 Joules)
- 15 Amp breaker
- Available on: Vertical Panels, Cabinet Interiors, and under tops

PRODUCT MODIFICATIONS  
*modify width - open kneespace*

Style Number	List Price
MOD-1	125

Specifications

- Modify width down on any unit with an open kneespace: desk, workstation credenza, bridge, return

PRODUCT MODIFICATIONS  
*modify width - open/closed storage*

Style Number	List Price
MOD-2	250

Specifications

- Modify width down on any unit with open or closed storage section: overheads, wall hung units, storage credenzas, towers

PRODUCT MODIFICATIONS  
*modify width - outside of mod-1, mod-2*

Style Number	List Price
MOD-3	Contact for pricing

Specifications

- Width modification outside of MOD-1 & MOD-2



Central park options.

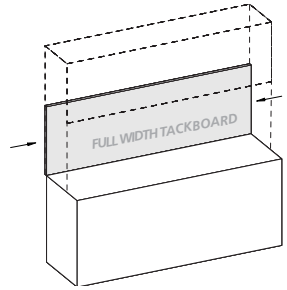

PRODUCT MODIFICATIONS  
 modify width - tackboard, slat wall,  
 veneer panel, or a glassboard

Style Number	List Price
MOD-4	50

Specifications

- Modify width down on tackboard, slat wall, veneer panel, or a overhead glassboard

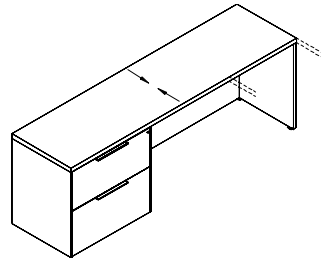

PRODUCT MODIFICATIONS  
 modify depth - decrease depth

Style Number	List Price
MOD-5	125

Specifications

- Modify depth down (minimum depth for a unit with drawers is 21"D)

Notes  
 - Ex. 24" to 21", 30" to 24", and 36" to 30"

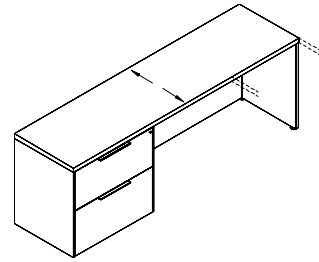

PRODUCT MODIFICATIONS  
 modify depth - increase depth

Style Number	List Price
MOD-6	Add 10%

Specifications

- Increase depth by no more than 6"

Notes  
 - Ex. 24" to 30", 30" to 36", and 36" to 42"  
 - Add 10% to the unit you want to increase the depth of by no more than 6"

PRODUCT MODIFICATIONS  
 modify height

Style Number	List Price
MOD-7	Contact for pricing

Specifications

- Modify height of a unit

## Central park options.

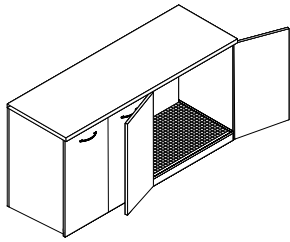

### REFRIGERATOR MODIFICATION *refrigerator cabinet modification*

Style Number	List Price
REF01	205

#### Specifications

- Open back cutout for venting
- Moisture sponge mat
- Contaminate ledge
- Contact customer service for maximum refrigerator size (Changes based on unit).

#### Notes

- Available on: 36" and 42" Storage Credenzas

### SHAPED TOPS *overhead/wall hung shaped top*

Style Number	List Price
99"W - 105"W TOH-1	425
58"W - 93"W TOH-2	330
29"W - 47"W TOH-3	215

#### Specifications

- Shaped tops for overheads and wall hungs

### SHAPED TOPS *bookcase shaped top*

Style Number	List Price
29"W - 35"W x 15"D TOH-4	215

#### Specifications

- 15" D Shaped tops for bookcases
- Shaped on front

### SHAPED TOPS *tower shaped top*

Style Number	List Price
16" Single Width Tower TOH-5	165
29"W - 46"W Tower TOH-6	215

#### Specifications

- 24" deep shaped tops for towers
- Shaped on front

# Central park options.

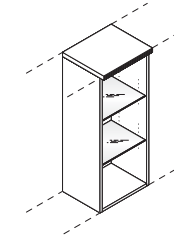
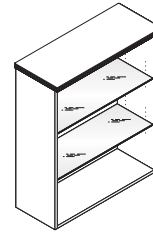

## SHAPED TOPS

*worksurface shaped top*

Style Number	List Price
Shape Four Sides S4S	55
Shape Three Sides S3S	55

## Specifications

- S4S Applies to desk, bridge or any freestanding unit. This adds shapes or copes to two sides (desk, bridges) or one side and back of units (returns).
- S3S Applies to credenza units. This adds shapes to the two sides.
- Credenzas are shaped front standard with flat back

### Notes

- Desk, Freestanding and Credenza units will grow 1" in width due to adding shapes on ends of units.

## SHAPED TOPS

*premium edge - shaped worksurface top*

Style Number	List Price
Shape Four Sides Premium Edge S4S-PE	Add 10%
Shape Three Sides Premium Edge S3S-PE	Add 10%

## Specifications

- S4S-PE Applies to desk, bridge or any freestanding unit. This adds shapes or copes to two sides (desk, bridges) or one side and back with hardwood rims (returns).
- S3S-PE Shape Three Sides Premium Edge. Applies to credenza units. This adds shape to the two sides with hardwood rims.

### Notes

- Desk, Freestanding and Credenza units will grow 1" in width due to adding shapes on ends of units.
- \* 10% Upcharge includes 5% for premium edge

## SHELF MODIFICATIONS

*glass shelves - tempered full width  
26" - 35"*

Style Number	List Price
26"W - 35"W x 14"D Shelf GS14F	90

## Specifications

- Glass Shelves Replace Wood Shelf In Open Or Glass Door Cabinet. Also Order Interior Cabinet Lighting.

## SHELF MODIFICATIONS

*tempered glass shelves for half  
cabinet 17- 1/2" widths*

Style Number	List Price
14-1/2"W - 17- 1/2"W x 14"D Shelf GS14H	70 ea.

## Specifications

- Glass Shelves Replace Wood Shelf In Open Or Glass Door Cabinet. Also Order Interior Cabinet Lighting.

### Notes

- Replace only adjustable shelves between cabinet light and fixed lower wood shelf.

Central park options.

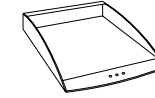
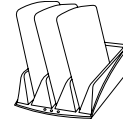
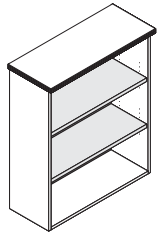

**SHELF MODIFICATIONS**  
*heavy duty solid wood bookcase  
 replacement shelves*

Style Number	List Price
1" Wood Shelf 14" Deep S714F	80 ea.
1" Wood Shelf 24" Deep S714FX	160 ea.

**Specifications**

- 1" Solid Lumber Core Shelves Replace Standard 3/4" Plywood Adjustable And Fixed Shelves

**SLAT WALL ACCESSORIES**  
*slat wall accessory tray*

Style Number	List Price
SWA9	50

**Specifications**

- Specify Black Or Matte Silver

**SLAT WALL ACCESSORIES**  
*slat wall folder tray*

Style Number	List Price
SWA7	50

**Specifications**

- Specify Black Or Matte Silver

**SLAT WALL ACCESSORIES**  
*slat wall paper tray*

Style Number	List Price
SWA2	40

**Specifications**

- Specify Black Or Matte Silver

## Central park options.

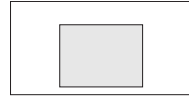

RECTANGLE INLAY

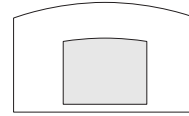

BOWFRONT INLAY

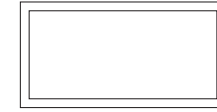

RECTANGLE INLAY

### SLAT WALL ACCESSORIES *slat wall pencil holder*

Style Number	List Price
SWA4	30

### Specifications

- Specify Black Or Matte Silver

### SPECIALTY VENEER ACCENTS *rectangle inlay - recesses dura-leather writing surface*

Style Number	List Price
RL-29A	935

### Specifications

- Recessed inlay desk pads are covered with Alomost Leather from Paul Brayton Designs.  
- DARRAN will gladly custom quote other inlay materials ie: solid surfaces, biocomposites, metallic laminates, or genuine leather to match seating

### SPECIALTY VENEER ACCENTS *bowfront inlay - recesses dura-leather writing surface*

Style Number	List Price
RL-31A	1035

### Specifications

- Recessed inlay desk pads are covered with Alomost Leather from Paul Brayton Designs.  
- DARRAN will gladly custom quote other inlay materials ie: solid surfaces, biocomposites, metallic laminates, or genuine leather to match seating

### SPECIALTY VENEER ACCENTS *rectangle inlay - ebony hardwood inlay detail*

Style Number	List Price
T10SA	935

### Specifications

- 3/16" x 3/16" thick hardwood ebony inlay is handfitted and glued into routed top and sanded flush with surface  
- Inlay is finished over with all finish steps

#### Notes

- Ebony inlay not recommended in: Koko Cherry

## Central park options.

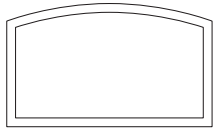

CURVED INLAY

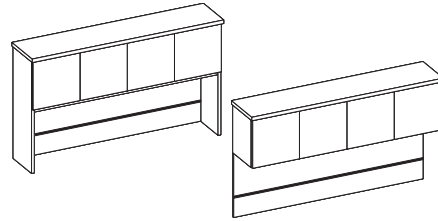

### SPECIALTY VENEER ACCENTS *bowfront inlay - ebony hardwood inlay detail*

Style Number	List Price
T11SA	1035

### Specifications

- 3/16" x 3/16" thick hardwood ebony inlay is handfitted and glued into routed top and sanded flush with surface
- Inlay is finished over with all finish steps

#### Notes

- Ebony inlay not recommended in: Koko Cherry

### TOOL CHANNEL ACCESSORIES *recessed aluminum tool channel*

Style Number	List Price
ATB02	5 per 1"W

### Specifications

- Anodized aluminum finish
- Fully recessed
- Finish matches anodized aluminum accessories
- Can be specified with fabric tack surface mounted above channel

#### Notes

- If using tool channel with wallhung overhead, a veneer panel must be specified.

### TOOL CHANNEL ACCESSORIES *iphone holder*

Style Number	List Price
ATB31	125

### Specifications

- For Console/Wall Hung Back Panels With Optional Tool Bar
- 18 Gauge Steel - Stamp Formed
- Silver Powerdercoat Finish
- 5" x 3 -3/4"W
- Non-slip Neoprene pad

### TOOL CHANNEL ACCESSORIES *large shelf*

Style Number	List Price
ATB35	135

### Specifications

- 12"W x 10"D

## Central park options.



TOOL CHANNEL ACCESSORIES  
*pencil pen holder*

Style Number	List Price
ATB38	120

### Specifications

- For Console/Wall Hung Back Panels With Optional Tool Bar
- 18 Gauge Steel - Stamp Formed
- Silver Powdercoat Finish
- 5" H x 4" W x 4" D



TOOL CHANNEL ACCESSORIES  
*tablet holder*

Style Number	List Price
ATB30	145

### Specifications

- For Console/Wall Hung Back Panels With Optional Tool Bar
- 18 Gauge Steel - Stamp Formed
- Silver Powdercoat Finish
- 10" x 8" W
- Non-slip Neoprene pad

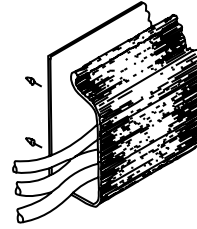

WIRE MANAGEMENT  
*horizontal j-channel wire management raceway*

Style Number	List Price
W1	80 Per 4' section

### Specifications

- 4" section for field installation.
- The "J" shape black thermoplastic wire raceway may be added to specified worksurface tops to provide concealed channeling of wires to and from worksurface grommets. For use in open kneespace areas, raceway is attachable to top of back panel with pan head screws. Interior dimensions are 1" x 1- 1/2" providing ample storage for multiple wires and excess cable. Front of raceway flexes out for easy cord insertion.

#### Notes

- Units w/ Wire Channel Standard.
- Field Installation

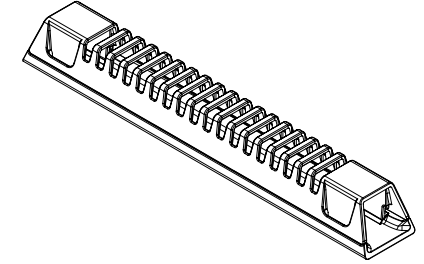

WIRE MANAGEMENT  
*horizontal wire management raceway*

Style Number	List Price
W21	35

### Specifications

- 10"W x 1.5"D x 1.25"H
- Grey Wire Manager (10.5")
- Power and data cables can be discretely housed and managed with the W21 Gray Wire Manager. This can be mounted in any location to metal frame or underside of conference tables and runs cables through a 1" channel from power module to hollow steel legs. This keeps cables organized under the table top. Release clips make it simple to snap on and off the Wire Manager for easy organization and access after attached to the table

#### Notes

- Field installed

Central park options.

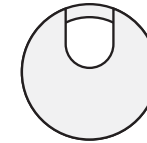
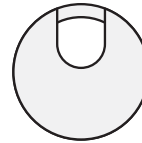

WIRE MANAGEMENT  
*horizontal u-channel wire management raceway*

Style Number	List Price
W2A	80 Per 4' section

Specifications

- 4' section for field installation.

Notes

- Units w/ Wire Channel Standard.
- Field Installation

WIRE MANAGEMENT  
*coil wire manager*

Style Number	List Price
W18	160

Specifications

- Weighted Base, Table attachment plate
- 39- 1/2" Length
- Black

Notes

- Location

WIRE MANAGEMENT  
*standard location grommets - factory installed*

Style Number	List Price
Standard Location Grommet	
Black	
TM30	50
Silver	
TM31	50
Antique Brass	
TM33	50
White	
TM34	50

Specifications

- 1 -5/8" Metal Grommet

Notes

- \*Units w/ Grommets Standard Are Noted Under Standard Features. Grommets Match Pull Finish - Standard (Unless Specified Otherwise)

WIRE MANAGEMENT  
*non-standard location grommets - factory installed*

Style Number	List Price
Non-Standard Location Grommet	
Black	
TM30 -NS	95
Silver	
TM31 -NS	95
Antique Brass	
TM33 -NS	95
White	
TM34 -NS	95

Specifications

- 1 -5/8" Metal Grommet

Notes

- \*Units w/ Grommets Standard Are Noted Under Standard Features. Grommets Match Pull Finish - Standard (Unless Specified Otherwise)



## Central park options.



### WIRE MANAGEMENT

*black plastic vertical surface grommets  
- factory installed*

Style Number	List Price
Standard Location Grommet TM50-C	50
Non-Standard Location Grommet TM50-NS	95

### Specifications

- 2 " Black Plastic Grommet

#### Notes

- Standard Location is Bottom Center

## power & data options.

Aircharge wireless charging grommet

Style Number	List Price
 ACWG WIRELESS GROMMET	\$195

## Specifications

- › When used with GROVE Tables an additional \$350 LIST will apply for the special cutout required.
- › AirCharge offers a convenient way to charge any Qi compatible smartphone or device without the need to carry charging cables or find an available power outlet.
- › The Aircharge is powered by the latest Qi compliant IC offering reliable and efficient wireless charging in a convenient 3" grommet hub. Simply place your phone on the Aircharge and an LED will confirm pairing and begin wireless charging.
- › Recess: Efficient space conservation and quick access
- › Input: DC 5V (with included AC power adapter), DC 9V, 1.67A (with optional QC 2.0 power adapter)
- › Output: 5 watts Max. with DC 5V, 2A power adapter, 10 watts Max. with QC 2.0 power adapter
- › Qi V1.2 compliant IC
- › Charging distance: 6mm Max.

Available: All DARRAN collections



## power & data options.

Cove power unit - non-linking

Style Number

List Price



PD-COVE PLUG

\$550

Non-linking version

### Specifications

- › Size 5.75" L x 2.5" W
- › (2) 15 Amp Receptacles and (2) USB charging ports
- › Surface Mount
- › 108" Cord
- › Standard Silver Finish, Available in White or Black Finish upon request
- › ETL Listed

Available: All DARRAN collections



## power & data options.

Cove corded series

Style Number

List Price



PD-COVE-PKO

\$800

## Specifications

- › Size 9.5" L x 2.5" W x 3.18" D
- › When used with GROVE Tables an additional \$350 LIST will apply for the special cutout required.
- › (2) Power Receptacles, (2) 2.1 Amp USB charging ports and (1) Telecom Plate Knockout
- › Surface Mount
- › 108" Cord
- › Standard Silver Finish, Available in White or Black Finish upon request
- › ETL Listed

Available: All DARRAN collections

### Telecom Plates

RJ45 (1)	\$35
RJ45 (2)	\$70
RJ45 (3)	\$105
USB (1)	\$70
USB (2)	\$140
RJ11/RJ45	\$70
RJ45/USB	\$105
RJ45/HDMI	\$190
HDMI/DVI	\$325
HDMI/USB	\$205
HDMI/VGA	\$240
VGA/MINI-STEREO	\$155
VGA/USB	\$175

This pod can have up to 1 total plates.  
\*All telecom connectors sold separately.



## power & data options.

### FPDB flush power/data bay

Style Number	List Price
	
Hardwired	
FPDB-H72 72" Cord	\$1250
FPDB-H108 108" Cord	\$1300
FPDB-H144 144" Cord	\$1350
FPDB-H180 180" Cord	\$1400
	
Power/Plug	
FPDB-C72 72" Cord	\$1250
FPDB-C108 108" Cord	\$1300
FPDB-C144 144" Cord	\$1350
FPDB-C180 180" Cord	\$1400

## Specifications

- > Size 14.19"L x 6.39"W x 3.38"H
- > (4) 15 Amp receptacles
- > Available in white, silver or black
- > (3) telecom plate cutouts standard
- > (1) Dual USB ports
- > Corded units are UL Listed and CSA Certified. Hardwired Units are CSA Certified
- > Select 72", 108", 144", or 180" power cord or hardwire whip cord

Available: All DARRAN collections, excludes rail and grove

Telecom Plates	
RJ45 (1)	\$35
RJ45 (2)	\$70
RJ45 (3)	\$105
USB (1)	\$70
USB (2)	\$140
RJ11/RJ45	\$70
RJ45/USB	\$105
RJ45/HDMI	\$190
HDMI/DVI	\$325
HDMI/USB	\$205
HDMI/VGA	\$240
VGA/MINI-STEREO	\$155
VGA/USB	\$175

This pod can have up to 3 total plates.  
\*All telecom connectors sold separately.



Standard underside Convenience plug. Can be used for Daisy Chaining up to (4) total units. Specify hardwired or plug for the first unit in series, daisy chained units will have a plug for connection through convenience plug.

## power & data options.

Reef power unit with daisylink

Style Number	List Price
 REF310 PLUG	\$1100

## Specifications

- › Size 16.1”L x 6.25”W x 4.89”D
- › When used with GROVE Tables an additional \$350 LIST will apply for the special cutout required.
- › (3) 120V Receptacles, (2) USB charging ports, 1 Data Plate Knockout, (2) Knockouts for RJ45 Data Ports
- › Surface Mount
- › 108” Cord
- › Features Convenience Plug on bottom of unit that allows for max (3) Daisy Chain
- › Standard Black Finish, Available in White or Silver Finish upon request
- › Additional Telecom Plate Knockout
- › RJ45 for Knockouts not required. If not ordered a small hole will be present in the pod in this this location
- › ETL Listed

Available: Conferencing

Telecom Plates	
RJ45 (1)	\$35
RJ45 (2)	\$70
RJ45 (3)	\$105
USB (1)	\$70
USB (2)	\$140
RJ11/RJ45	\$70
RJ45/USB	\$105
RJ45/HDMI	\$190
HDMI/DVI	\$325
HDMI/USB	\$205
HDMI/VGA	\$240
VGA/MINI-STEREO	\$155
VGA/USB	\$175

This pod can have up to 1 total plates.  
\*All telecom connectors sold separately.



## power & data options.

### Soba wire manager

Style Number	List Price
STARTER UNITS	
SCDW	\$200
White wire manager	
SCDB	\$200
Black wire manager	

## Specifications

- › Dimensions: 9ft x 9in x 3.15in
- › Zips up, bundles and routes loose, messy cables into a single tube
- › Routes and guides cables behind desks, TVs, and anywhere cables tend to get messy
- › Accommodates large or small cables, up to three cables at once
- › Support channels, used to route cables, include powerful adhesive backing which allows easy attachment to surfaces.

Available: All DARRAN collections



## power & data options.

VILLA Power unit - non-linking

Style Number	List Price
 VIL-C PLUG	\$515
Non-Linking	

## Specifications

- › Size: Top Grommet 5.68" L X 3.39"W; Under Top 12"L x 3.13"W x 3.08"D
- › (2) Power receptacles; (2) USB charging ports and (1) Knockouts for RJ45 Data Ports
- › Surface Mount
- › 72" Cord (Longer cord available, contact Customer Service)
- › Standard Silver Finish, Black Finish available upon request
- › UL or ETL Certified

Available: All DARRAN collections, excludes Grove

RJ45 Knockout	
RJ45 (1)	\$35





# Chameleon price list



## Chameleon table of contents

Features & Advantages .....	1
Finishes   Specifications .....	2
Edges   Pulls .....	7
Configured Storage .....	9
Ganging.....	11
Stacking.....	13
Power Guide.....	14
Grommets   Wire management .....	15
Power Options.....	16
Chameleon Grain Direction.....	19
Drawer Dimensions   Filing Reference.....	20
Table Desk .....	21
Height Adjustable Table Desk .....	23
Conference Table .....	24
Ganging Credenzas .....	26
Freestanding Credenzas .....	30
Sit-On Storage .....	40
Mobile Pedestals.....	43
Wall hung .....	44
Freestanding Screens .....	47
Towers.....	51
Bookcases.....	56
Privacy Screens.....	58
Power & data options.....	68

# Chameleon statement of line



PAGE 21  
Table desks with Solid Wood Legs



PAGE 22  
Table desks with Solid Wood Legs



PAGE 23  
Height Adjustable Table Desk



PAGE 24  
Conference Table



PAGE 25  
Swivel Conference Table



PAGE 26  
30" Ganging Credenza

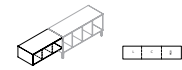

PAGE 27  
45" Ganging Credenza



PAGE 28  
60" Ganging Credenza

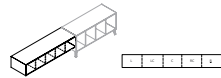

PAGE 29  
75" Ganging Credenza



PAGE 30  
30" Wide Freestanding Credenza



PAGE 31  
30" Wide Freestanding Credenza



PAGE 32  
30" Wide Freestanding Credenza



PAGE 33  
45" Wide Freestanding Credenza



PAGE 34  
45" Wide Freestanding Credenza



PAGE 35  
60" Wide Freestanding Credenza

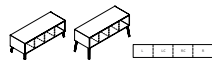

PAGE 36  
60" Wide Freestanding Credenza

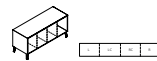

PAGE 37  
60" Wide Freestanding Credenza

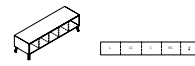

PAGE 38  
75" Wide Freestanding Credenza

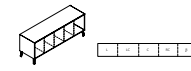

PAGE 39  
75" Wide Freestanding Credenza

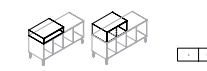

PAGE 40  
30" Sit-On Storage

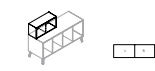

PAGE 41  
30" Sit-On Storage



PAGE 42  
45" Sit-On Storage



PAGE 43  
Mobile Pedestals

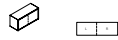

PAGE 44  
30" Single Height Wall Hung Overheads



PAGE 45  
45" Single Height Wall Hung Overheads



PAGE 46  
60" Single Height Wall Hung Overheads



PAGE 47  
Freestanding Screen - 40"W x 56"H



PAGE 48  
Freestanding Screen - 54"W x 56"H



PAGE 49  
Freestanding Screen - 40"W x 66"H



PAGE 50  
Freestanding Screen - 54"W x 66"H



PAGE 51  
Vertical Half Tower



PAGE 52  
Vertical Half Tower



PAGE 53  
Vertical Full Tower



PAGE 54  
Vertical Full Tower



PAGE 55  
Vertical Full Tower

# Chameleon statement of line

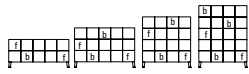

PAGE 56  
Open Plan Bookcase

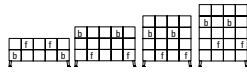

PAGE 57  
Open Plan Bookcase



PAGE 58  
Interpersonal Screen

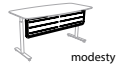

PAGE 59  
Privacy Screen



PAGE 60  
Privacy Screen

## Chameleon features & advantages

### Veneer and HPL tops

Veneer tops and high-pressure laminate tops feature a 45-pound density substrate with balanced 3-ply construction. Tops are 1" thick with soft rectangle shape. DARRAN only uses Quartered Ash, Oak and Walnut Veneers. Tops feature a sealed and polished MDF edge standard, or 2mm Veneer edge, or 1mm PVC band to match HPL top, or 3mm PVC black or white band. Tops are finished in 5-sheen matte finish.

### Forbo Tops

Forbo is a durable, sustainable surface linoleum manufactured from natural bio-based raw materials that contributes to a healthy indoor environment inspired by nature. Solid color Forbo is available on table tops in a selection of hues.

### Cleaning wood & laminate

In addition to regular dusting, give your furniture an occasional cleaning in accordance with our cleaning instructions. DARRAN wood and laminate products can be cleaned with a soft cloth and a mild soap and water mixture. Use approximately 32 oz of water mixed with one tablespoon of dish soap, always wiping with the grain. Dry with a soft cloth, going with the grain, to avoid spotting or streaking.

Wood products should be waxed periodically using a non-wax liquid; please do not use any waxy polish or cleaner. Interior of drawers may also be cleaned with mild soap and water mixture, or any household cleaner that is not petroleum or thinner-based.

### Cases

Mitered corner and dowel construction means cases are not re-configurable.

### Drawer fronts

Drawer fronts are vertically matched in balanced sets

### Adjustable glides

Glides provide 5/8" of vertical leveling adjustment. Glide bottom is durable plastic.

### Suspensions

All casegoods utilize cold rolled steel zinc plated high-grade drawer suspensions. All suspensions are warranted for the lifetime of the product. Box and File drawers are full extension, featuring steel ball bearings for a smoother quieter range of motion with soft close operation and are rated 100lbs. Lateral file drawers are a progressive action full extension suspension with the soft close operation and is rated at 150lbs.

### Filing park

Chameleon features a highly durable black plastic extrusion that is securely fastened into a route on top of the drawer to support hanging files. An adjustable crossbar is

provided for all file drawers that enables legal/letter filing front to back or side-to-side based on the drawer size.

### Locks

Locks are optional on pedestals and doors. Each drawer pedestal is independently locked. Lock plugs are factory or field installed.

### Keying

Keying is available either factory or field installed. Factory installed keying offers two options: random or designated. When the random keying option is selected an arbitrary key number will be assigned to the unit. When the designated keying option is selected a key number must be specified between 101 and 110. Higher numbers may be specified if noted on the purchase order and may be factory or field installed. Black and silver face lock have silver keys.

### Wire management

Wire management capabilities include standard and optional worksurface grommets. Specify W21 under surface wire channels for organization and management of all communication wires and cords. Sold separately to conceal wire under worksurfaces.

### Grommets

Metal grommets are provided to match the drawer pull selection. Grommet is available in black, silver or white. Must specify standard or non-standard location. Black plastic grommets are available as an option for vertical applications.

### Powerports

A large selection of power options are available to handle power, data, docking stations and communication. See options section for selection.

### LED tasklights

LED task lighting provides high efficiency, low energy lighting with a long life. Recessed light is encased in silver aluminum channel with milk lense and rounded end caps. Lights are factory installed. Product specifications listed below:

- Diffuser creates a softer light and eliminates hot spots
- Touch dimmer switch
- Can be "daisy chained" up to 90W
- 4.6 watts per foot
- 120 LEDs per meter
- Certification: UL Listed
- 50,000 hour life span.

Color Temp is 4000K

# Chameleon finishes | specifications

## STANDARD VENEER

- Finishes on Red Oak
- PO01 Olive
- PO02 Aquavert
- PO03 Mushroom
- PO04 Burgundy
- PO05 Ash
- PO06 Powder
- PO07 Pebble
- PO08 Vapour
- PO09 Verde



visible wood grain

### Paint Finishes on MDF

- PM01 Olive
- PM02 Aquavert
- PM03 Mushroom
- PM04 Burgundy
- PM05 Ash
- PM06 Powder
- PM07 Pebble
- PM08 Vapour
- PM10 Verde
- WWP Designer White



printed full coverage

## PREMIUM VENEER

- WLA Lofty Ash
- WOW Clear Walnut
- WNO Natural Oak
- WSO Salted Oak

## HIGH PRESSURE LAMINATE

- GWL Designer White
- LP01 Surfin USA
- LP02 Royal Blue Suede
- LF01 New Burgundy
- LF02 Just Rose
- LF03 Folkstone
- LN01 Cafe Sienna
- LA01 Bleu Spazio (20% upcharge)
- LA02 Verde Chairò (20% upcharge)
- LW01 Neo Walnut
- LW02 Fawn Cypress
- LW04 Phantom Pearl
- LW05 Phantom Ecru
- LW06 Phantom Cocoa
- LW07 Stickley Oak

## FORBO

- FR01 Salsa
- FR02 Midnight Blue
- FR03 Nero
- FR04 Olive
- FR05 Aquavert
- FR06 Mushroom
- FR07 Burgundy
- FR08 Ash
- FR09 Powder
- FR10 Pebble
- FR11 Vapour

\*Forbo is only available on table tops

\*Send 3x3 or larger finish chip for color match. Custom finish upcharge is 3% or \$250 Net (whichever is greater).

## Finish

ENVI-CT Green Certified European Technology Coatings Finish.

# Chameleon finishes | materials

## Felts

Performance felt is a unique blend of non-dyed wool and man made fibers. This felt can fulfill the most critical design requirements and is a sustainable LEED contributing product. Color variation will occur due to natural fibers.

Felts are available on Screen Inserts, mobile Seat Pads and Bookcase Inserts.



FL07  
Vanilla



FL06  
Burnt Orange



FL08  
Mango



FL12  
Burgundy



FL10  
Meadow Green



FL05  
Sky Blue



FL11  
Light Blue



FL09  
Teal



FL01  
Sand



FL04  
Pebble Grey



FL03  
Light Grey



FL02  
Charcoal



Screen inserts can be felt or veneer



Bookcase inserts

# Chameleon finishes | materials

## Acoustic material

Felt-like acoustic material is fabricated from compressed recycled plastic bottles, and gives warmth to contemporary design.

Acoustic material is available on privacy and modesty panels.

### STANDARD



Charcoal gray  
17



Heather gray  
3

### PREMIUM



Midnight blue  
21



Olive  
35

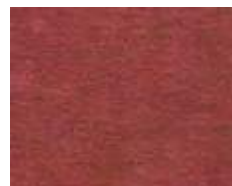

Burgundy  
29



Spring green  
39



Orange blast  
31



Amber  
18

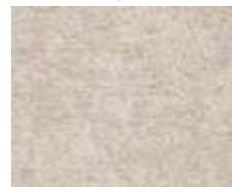

Ash  
2



Powder  
37



Royal blue  
16



Slate  
34



Privacy panel

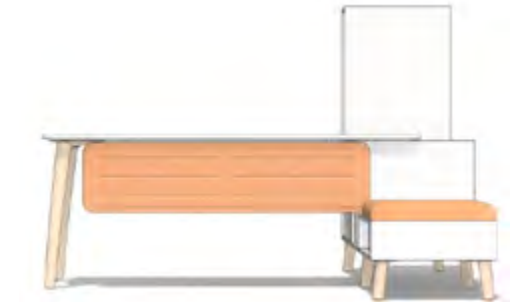

Modesty panel



Modesty panel



## Chameleon finishes | materials

### Forbo Tops

Forbo is a durable, sustainable surface linoleum manufactured from natural bio-based raw materials that contributes to a healthy indoor environment inspired by nature. Solid color Forbo is available on table tops in a selection of hues.



## Chameleon metal finishes | specifications

Chameleon metal finishes give the appearance of minimalistic designs that are adaptable in all changing work environments. Metal finishes available on table desk legs, modesty panels and privacy panels.

Metal is standard in MFW White. Premium Metal Finish: Priced per unit on product page.

### STANDARD

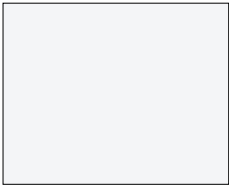

MFW  
White  
(Standard)

### PREMIUM



MFGG  
Graphite Gray  
(Premium)



MFS  
Silver  
(Premium)



MFMB  
Matte Black  
(Premium)



MFNA  
Navy  
(Premium)

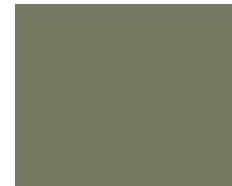

MFOL  
Olive  
(Premium)



MFGB  
Grey Beige  
(Premium)



MFSA  
Surfin Aquavert  
(Premium)

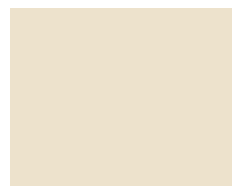

MFOS  
Oyster  
(Premium)







MFPS  
Pistachio  
(Premium)



MFSS  
Salmon Sienna  
(Premium)

# Chameleon edges | pulls

## STANDARD PROFILE

			
Cliff-1	Cliff-2	Cliff-3	Cliff-4
Sealed	Black	White	Veneer/
MDF	2mm	2mm	Laminate
Edge	PVC	PVC	Band
	Band	Band	

## PREMIUM PROFILE



Only available on veneer and Forbo tops.

Chameleon features a polished MDF edge standard. 2mm Veneer or 3mm PVC banding is available. Veneer edge is not available with Forbo top. Contact customer service for pricing

## PULLS

Push to Open Standard: Optional Hardware Below



PL - 406 Gloss White  
PL - 407 Matte Chrome



PL - 506 Gloss White  
PL - 507 Matte Chrome

## Chameleon configured storage

Specify each section of configured storage from left, left center, center, right center and right, each section must be specified. Please note: 15" storage units take up one section and 30" storage units take up two sections.



# Chameleon configured storage options

## 15" storage options



P1BF2115: 15" Width Box/File Drawer - \$350



SLD2115: 15" Width Sliding Door - \$290



P1HD2115: 15" Width Hinged Door - \$250



OPS2115: 15" Width Open Storage - \$125

## 30" storage options



P1BL2130: 30" Width Box/Lateral File Drawer - \$425



OPLF2130: 30" Width Open Upper/Lateral Lower File - \$400



OPDD2130: 30" Width Open Upper/Drop Door Lower - \$650



P1DD2130: 30" Width Drop Door - \$600



SLD2130: 30" Width Sliding Door - \$350



OPS2130: 30" Width Open Storage - \$125

## Optional Shelf



P1S2115: 15" Width Adjustable Shelf - \$95



P1S2130: 30" Width Adjustable Shelf - \$125

## Accent Finish

Configured storage matches the case finish. To bring in color specify an accent finish per configured storage section.

- AFO: Accent finish option per case - \$200

## Chameleon configured storage finish options

To specify finish, insert finish code before storage option. Please note, each storage section must include an AFO: Accent Finish Option.



All Chameleon finishes are available for configured storage options, vertical towers and wall hung doors except Forbo material. Please specify finish with AFO: Accent Font option with storage option.

# Chameleon ganging



## Vertical grommet sleeve TM60 - \$50

The aesthetic of Chameleon is found in its diverse layout options for ganging and stacking. Credenzas gang with an optional Vertical Grommet Sleeve TM60 - \$50. Grommets are field installed, a template will be provided when a TM60 is specified. The template details the location of 3 grommets for the installer.



## Chameleon ganging

To gang credenzas, bore pilot holes to connect units together. Bore four 5/16" holes with provided template. Squeeze clamp both units together to align. Bore four additional 5/16" holes in the connecting credenza end panel. Use connector bolts and sleeve to connect.

Backs are fixed, image below is for illustration purposes to show how units gang and wire management.

**Ganging**  
Front View



**Ganging**  
Back View



## Infeed

Concealed 4" wire channel and fixed back  
Bottom panel exit for floor plug



## Infeed

Back panel exit for wall plug





## Chameleon stacking

Chameleon stacking units can have up to one unit stacked on another. Chameleon units can not be stacked more than two units high with a max height of 42".



## Chameleon power guide

All chameleon cases are constructed with a concealed 4" wire channel and a fixed back panel. Power runs through concealed 4" wire channel, and exits the case at the bottom to a floor or wall power source.



### Top View

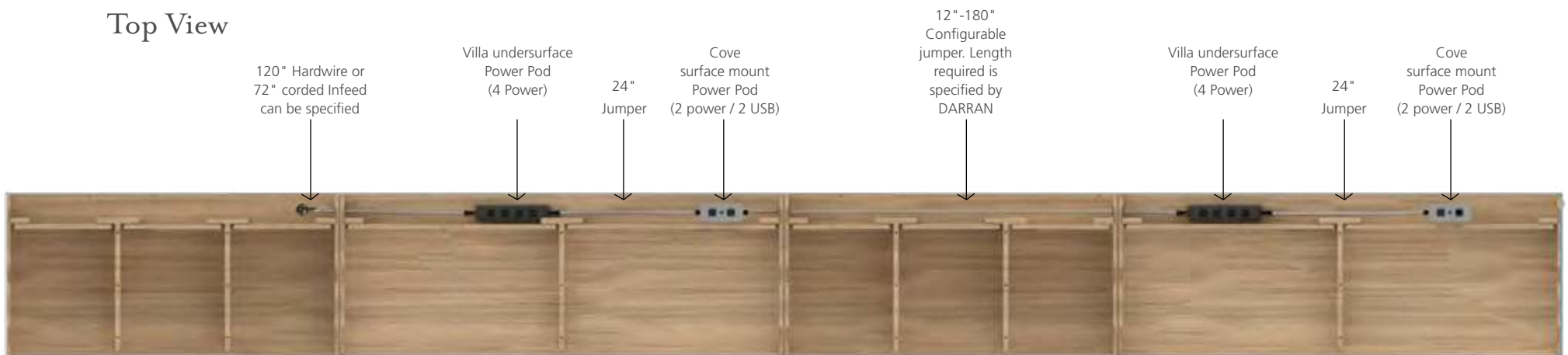

## Chameleon Grommets | Wire management

TM30  
Black  
1-5/8" Dia.

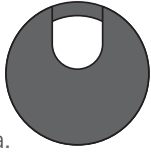

TM31  
Silver  
1-5/8" Dia.

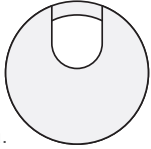

TM34  
White  
1-5/8" Dia.

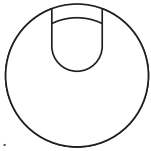

### Optional Grommets

Factory Installed

Grommets (Standard Location)

Specify Color and Left/Right/Center - \$50 ea.

- Black: TM30-R (Right), TM30-L (Left), TM30-C (Center)

- Silver: TM31-R (Right), TM31-L (Left), TM31-C (Center)

- White: TM34-R (Right), TM34-L (Left), TM34-C (Center)

Grommets (Non-Standard Location)

Provide drawing w/ Grommet Location and Specify Color - \$95 ea.

- Black: TM30-NS

- Silver: TM31-NS

- White: TM33-NS

TM60  
Black  
1-5/8" Dia..

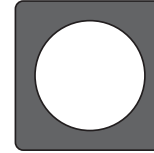

### Grommets (Vertical Surface)

Field Installed - \$50 ea.

- Black Plastic Vertical Surface: TM60

## Conference Wire Management

Power and data cables can be discretely housed and managed.

10"W x 1.5"D x 1.25"H

W21: Grey Wire Manager (10.5") - \$35

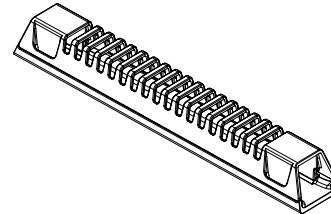

## Coil Wire management

W18 - Coil (Black) - \$160

\*Field Installed

- Weighted base, table top attachment plate

- 39-1/2" Length



## Vertebrae Wire management

W22 - Vertebrae (Clear) - \$135

W23 - Vertebrae (Gray) - \$140

\*Field Installed



## Chameleon power options

Configure Chameleon power based on project specification. The Daisy Chain starter power unit is required first, then specify the number of Daisy Chain Linking Units needed. For Hardwire Systems the max number of Linking Units to be daisy chained off of a Starter Power Unit is 11. For Corded Systems the max number of Linking Units to be daisy chained off of a Starter Power Unit is 2.

### Chameleon Daisy Chain Starter Power Unit



CHM-DCH HARDWIRED  \$975  
 Includes (1) cove pod with top 2 power and 2 USB ports, (1) 24" Jumper (1) Villa under mount pod with 4 power with 120" Hardwire Infeed

+

### Chameleon Daisy Chain Linking Unit



CHM-DCL \$950  
 Includes (1) 24" Jumper, (1) Villa under mount pod with 4 power, (1) 24" Jumper, (1) Cove pod with top 2 power and 2 USB ports

# Chameleon power options

Style Number                      List Price

## Chameleon Daisy Chain Starter Power Unit

CHM-DCH HARDWIRED  \$975

Includes (1) cove pod with top 2 power and 2 USB ports, (1) 24" Jumper (1) Villa under mount pod with 4 power with 120" Hardwire Infeed

CHM-DCP PLUG  \$975

Includes (1) cove pod with top 2 power and 2 USB ports, (1) 24" Jumper (1) Villa under mount pod with 4 power with 72" Plug Infeed

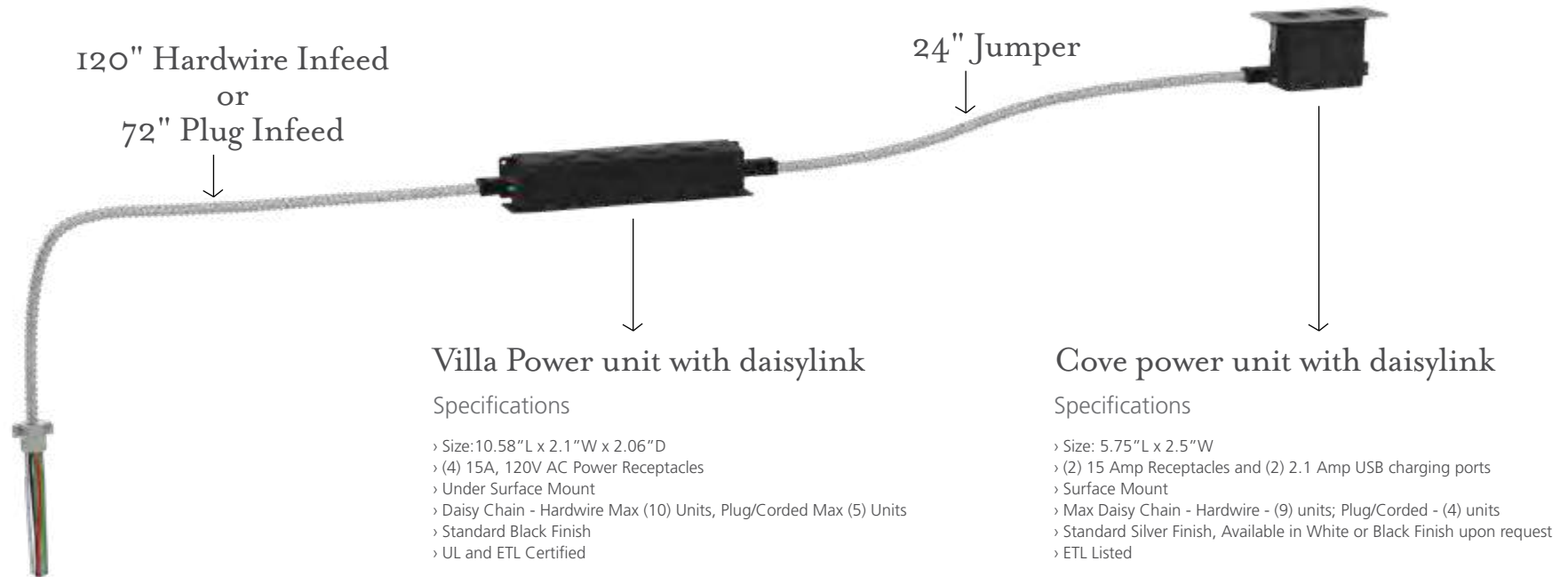

# Chameleon power options

Style Number	List Price
LINKING UNIT	
CHM-DCL	\$950
Includes (1) 24" Jumper, (1) Villa under mount pod with 4 power, (1) 24" Jumper, (1) Cove pod with top 2 power and 2 USB ports	

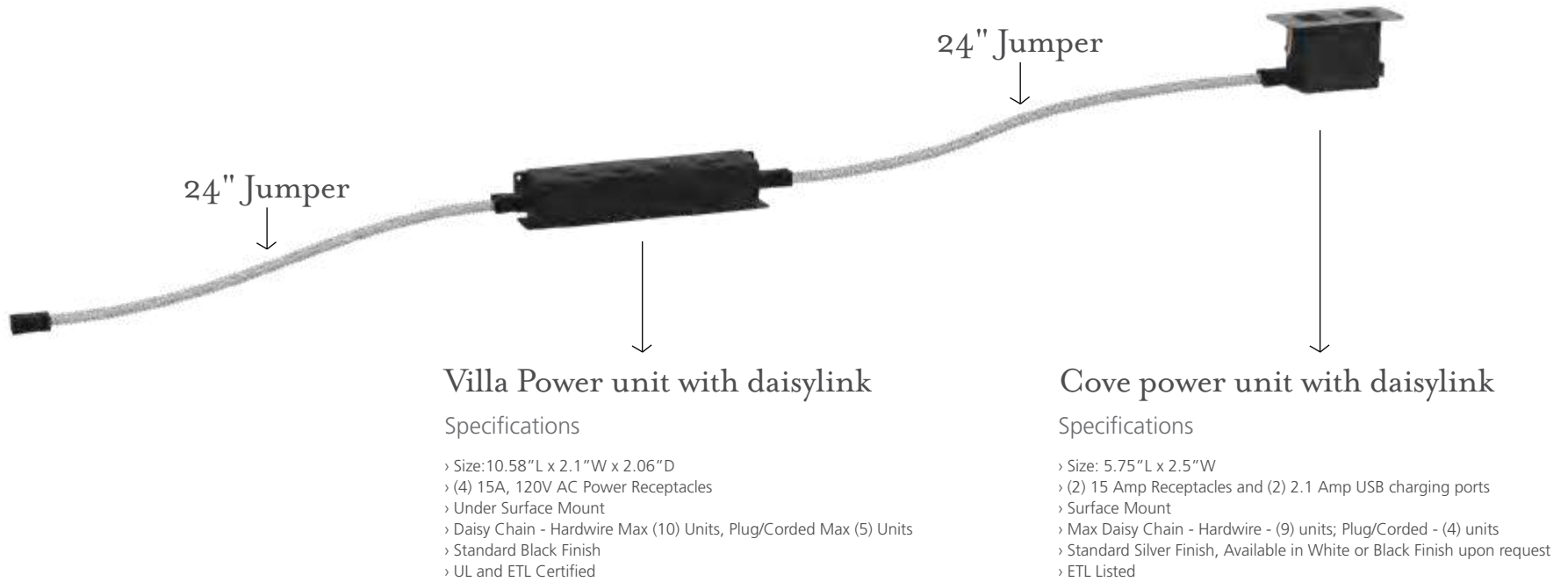

## Chameleon grain direction

### Grain direction

Veneer and laminate chassis parts are vertical grain. Veneer and laminate backs over 75" are horizontal grain.



Desk

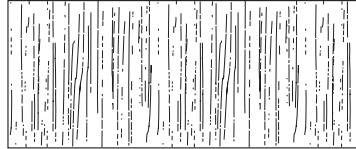

Runoff Desk  
Grain Direction on  
Laminate Units Above 75"  
runs end to end

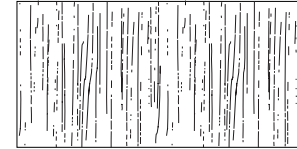

Bridge  
Grain Direction on  
Laminate Units Above 75"  
runs end to end



Credenza

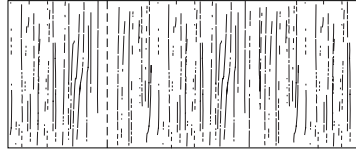

Return  
Grain Direction on  
Laminate Units Above 75"  
runs end to end

## Chameleon drawer dimensions | filing reference

### Interior drawer dimensions

UNIT DEPTH	DRAWER TYPE	OVERALL DIMENSIONS			INTERIOR DRAWER DIMENSIONS			NOTES
		W	D	H	W	D	H	
15-5/8" Letter	22" Box	13-1/8	16-1/16	4	12-1/8	15-1/16	3-7/16	Units less than 72"
	22" File	13-1/8	16-1/16	9-13/16	12-1/8	15-1/16	9-5/16	Units less than 72"
29" Lateral	22" Box	27-3/4	16-1/16	4	26-3/4	15-1/16	3-7/16	Workstation Credenzas less than 82"
	22" File	27-3/4	16-1/16	9-13/16	26-3/4	15-1/16	9-5/16	Workstation Credenzas less than 82"

### Filing reference

#### Filing for 22" depth units

13 1/8" Wide File Drawer - 16 1/16" Deep

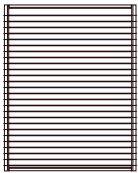

Letter Front to Back

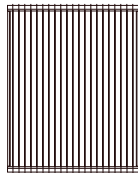

Legal Side to Side with File Rail

#### 30" Lateral file drawer

30" : 27-3/4" Wide File Drawer - 16-1/16" Deep

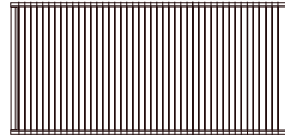

Legal Side to Side

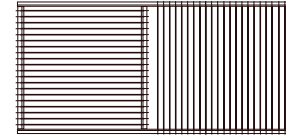

Legal Side to Side Letter Front to Back with File Rail

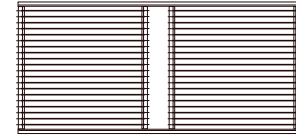

Letter Front to Back with File Rail



# Chameleon.

Table desks with Solid Wood Legs  
Soft Rectangle Table Top with Solid Wood Legs

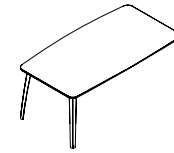

[View statement of line](#)

1 Select a model w" x d" x h"	weight	Standard Veneer Top Solid Wood Legs		Premium Veneer Top Solid Wood Legs		High Pressure Laminate Top Solid Wood Legs		Forbo Marmoleum Top Solid Wood Legs	
		72 x 36 x 29		CHM7236DT097W	3527	CHM7236DT097P	3880	CHM7236DT097G	3510
72 x 30 x 29		CHM7230DT097W	3511	CHM7230DT097P	3863	CHM7230DT097G	3494	CHM7230DT097F	4181
66 x 33 x 29		CHM6633DT097W	3516	CHM6633DT097P	3868	CHM6633DT097G	3500	CHM6633DT097F	4186
66 x 30 x 29		CHM6630DT097W	3466	CHM6630DT097P	3813	CHM6630DT097G	3448	CHM6630DT097F	4132
60 x 30 x 29		CHM6030DT097W	3441	CHM6030DT097P	3786	CHM6030DT097G	3412	CHM6030DT097F	4104

2 Select a finish <a href="#">View finish details</a>	Top Finishes		Leg Finishes		Top Finishes	Leg Finishes		Top Finishes	Leg Finishes		Top Finishes	Leg Finishes	
	WVP	PO01	WOW	PO06		WOW	WOW		PO06	WOW		PO06	FR01
PM01	PO02	WNO	PO07	WNO	WNO	PO07	WNO	PO07	FR02	FR11	WNO	PO07	
PM02	PO03	WSO	PO08	WSO	WSO	PO08	WSO	PO08	FR03		WSO	PO08	
PM03	PO04	WLA	PO09	WLA	WLA	PO09	WLA	PO09	FR04		WLA	PO09	
PM04	PO05								FR05				
PM05	PO06								FR06				
PM06	PO07								FR07				
PM07	PO08								FR08				
PM08	PO09								FR09				
PM10													

3 Select an edge <a href="#">View edge details</a>	Cliff				Cliff				Cliff				Plateau	
	Cliff-1	Cliff-2	Cliff-3	Cliff-4	Cliff-1	Cliff-2	Cliff-3	Cliff-4	Cliff-1	Cliff-2	Cliff-3	Cliff-4	Cliff-1	Plateau
Sealed	Black	White	Veneer/	Sealed	Black	White	Veneer/	Sealed	Black	White	Veneer/	Sealed	+\$600	
MDF	2mm	2mm	Laminate	MDF	2mm	2mm	Laminate	MDF	2mm	2mm	Laminate	MDF	Sealed	
Edge	PVC	PVC	Band	Edge	PVC	PVC	Band	Edge	PVC	PVC	Band	Edge	MDF	
	Band	Band			Band	Band			Band	Band			Edge	
Plateau				Plateau										
+\$600				+\$600										
Sealed				Sealed										
MDF Edge				MDF Edge										

4 Select hardware <a href="#">View hardware details</a>

## Product features.

- 1" Thick top
- ENVI-CT Finish \*Environmental Coatings Technology
- Solid wood legs
- Ships KD

## Options.

### ACCESSORIES

- K28: Articulating Keyboard w/ Mouse - \$390
- K31: Center drawer - \$205
- K31-SK: Center drawer w/ skirt - \$310

### GROMMETS (STANDARD LOCATION)

- Specify Color and Left/Right - \$50 ea.
- Black: TM30-R (Right), TM30-L (Left)
  - Silver: TM31-R (Right), TM31-L (Left)
  - White: TM34-R (Right), TM34-L (Left)

### GROMMETS (NON-STANDARD LOCATION)

- Provide drawing w/ grommet location and specify color - \$95 ea.
- Black: TM30-NS
  - Silver: TM31-NS
  - White: TM34-NS

### MODESTY

- HMAP14: Acoustic Panel Modesty - \$450

### PRIVACY SCREEN

- FAPS14: Acoustic Privacy Screen (Approach Privacy) - \$450
- SAPS14: Acoustic Privacy Screen (Side Privacy) - \$400

### MODIFY LEG

- M-1: Modify one 28" height leg to 7" height leg - no charge
- M-2: Modify two 28" height leg to 7" height leg - no charge
- M-3: Modify one 28" height leg to 14" height leg - no charge
- M-4: Modify two 28" height leg to 14" height leg - no charge

# Chameleon.

Table desks with Solid Wood Legs  
Soft rectangle Runoff with solid wood legs

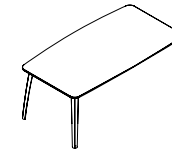

[View statement of line](#)

1 Select a model w" x d" x h"	weight	Standard Veneer Top Solid Wood Legs		Premium Veneer Top Solid Wood Legs		High Pressure Laminate Top Solid Wood Legs		Forbo Marmoleum Top Solid Wood Legs	
		<b>Legs left, right hookup</b> 72 x 36 x 29 72 x 30 x 29 66 x 33 x 29 66 x 30 x 29 60 x 30 x 29 <b>Legs right, left hookup</b> 72 x 36 x 29 72 x 30 x 29 66 x 33 x 29 66 x 30 x 29 60 x 30 x 29		CHM7236DR774W 2893 CHM7230DR774W 2853 CHM6633DR774W 2883 CHM6630DR774W 2828 CHM6030DR774W 2803 CHM7236DR775W 2893 CHM7230DR775W 2853 CHM6633DR775W 2883 CHM6630DR775W 2828 CHM6030DR775W 2803	CHM7236DR774P 3183 CHM7230DR774P 3138 CHM6633DR774P 3172 CHM6630DR774P 3111 CHM6030DR774P 3084 CHM7236DR775P 3183 CHM7230DR775P 3139 CHM6633DR775P 3172 CHM6630DR775P 3111 CHM6030DR775P 3084	CHM7236DR774G 2878 CHM7230DR774G 2779 CHM6633DR774G 2866 CHM6630DR774G 2768 CHM6030DR774G 2757 CHM7236DR775G 2878 CHM7230DR775G 2779 CHM6633DR775G 2866 CHM6630DR775G 2768 CHM6030DR775G 2757	CHM7236DR774F 3509 CHM7230DR774F 3465 CHM6633DR774F 3499 CHM6630DR774F 3438 CHM6030DR774F 3411 CHM7236DR775F 3509 CHM7230DR775F 3465 CHM6633DR775F 3499 CHM6630DR775F 3438 CHM6030DR775F 3411		
2 Select a finish <a href="#">View finish details</a>		Top Finishes Leg Finishes WVP PO01 WOW PO06 PM01 PO02 WNO PO07 PM02 PO03 WSO PO08 PM03 PO04 WLA PO09 PM04 PO05 PO01 PM05 PO06 PO02 PM06 PO07 PO03 PM07 PO08 PO04 PM08 PO09 PO05 PM10	Top Finishes Leg Finishes WOW WOW PO06 WNO WNO PO07 WSO WSO PO08 WLA WLA PO09 PO01 PO02 PO03 PO04 PO05	Top Finishes Leg Finishes GWL LW01 WOW PO06 LP01 LW02 WNO PO07 LP02 LW04 WSO PO08 LF01 LW05 WLA PO09 LF02 LW06 PO01 LF03 LW07 PO02 LN01 PO03 LA01 PO04 LA02 PO05	Top Finishes Leg Finishes FR01 FR10 WOW PO06 FR02 FR11 WNO PO07 FR03 WSO PO08 FR04 WLA PO09 FR05 PO01 FR06 PO02 FR07 PO03 FR08 PO04 FR09 PO05				
3 Select a edge <a href="#">View edge details</a>		 Cliff-1 Sealed MDF Edge PVC Band  Cliff-2 Black 2mm PVC Band  Cliff-3 White 2mm PVC Band  Cliff-4 Veneer/Laminate Band  Plateau Sealed MDF Edge +\$600	 Cliff-1 Sealed MDF Edge PVC Band  Cliff-2 Black 2mm PVC Band  Cliff-3 White 2mm PVC Band  Cliff-4 Veneer/Laminate Band  Plateau Sealed MDF Edge +\$600	 Cliff-1 Sealed MDF Edge PVC Band  Cliff-2 Black 2mm PVC Band  Cliff-3 White 2mm PVC Band  Cliff-4 Veneer/Laminate Band  Plateau Sealed MDF Edge +\$600	 Cliff-1 Sealed MDF Edge  Plateau Sealed MDF Edge +\$600				
4 Select hardware <a href="#">View hardware details</a>									

## Product features.

- 1" Thick top
- ENVI-CT Finish \*Environmental Coatings Technology
- Solid wood legs

### NOTES

- Table is designed to rest freely on top of case goods with non-slip bumper.

## Options.

### ACCESSORIES

- K28: Articulating Keyboard w/ Mouse - \$390
- K31: Center drawer - \$205
- K31-SK: Center drawer w/ skirt - \$310

### GROMMETS (STANDARD LOCATION)

- Specify Color and Left/Right - \$50 ea.
- Black: TM30-R (Right), TM30-L (Left)
- Silver: TM31-R (Right), TM31-L (Left)
- White: TM34-R (Right), TM34-L (Left)

### GROMMETS (NON-STANDARD LOCATION)

- Provide drawing w/ grommet location and specify color - \$95 ea.
- Black: TM30-NS
- Silver: TM31-NS
- White: TM34-NS

### MODESTY

- HMAP14: Acoustic Panel Modesty - \$450

### PRIVACY SCREEN

- FAPS14: Acoustic Privacy Screen (Approach Privacy) - \$450
- SAPS14: Acoustic Privacy Screen (Side Privacy) - \$400

# Chameleon.

Height Adjustable Table Desk  
Soft Rectangle Table Top with white height adjustable base

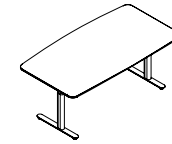

## 1 Select a model

w" x d" x h"

weight

	Standard Veneer Top Metal Base	Premium Veneer Top Metal Base	High Pressure Laminate Top Metal Base	Forbo Marmoleum Top Metal Base
72 x 36 x 29	CHM7236DT090W 3446	CHM7236DT090P 3791	CHM7236DT090G 3375	CHM7236DT090F 4110
72 x 30 x 29	CHM7230DT090W 3415	CHM7230DT090P 3757	CHM7230DT090G 3380	CHM7230DT090F 4077
66 x 33 x 29	CHM6633DT090W 3436	CHM6633DT090P 3780	CHM6633DT090G 3358	CHM6633DT090F 4099
66 x 30 x 29	CHM6630DT090W 3385	CHM6630DT090P 3724	CHM6630DT090G 3348	CHM6630DT090F 4045
60 x 30 x 29	CHM6030DT090W 3355	CHM6030DT090P 3691	CHM6030DT090G 3321	CHM6030DT090F 4011

[View statement of line](#)

## 2 Select a finish

[View finish details](#)

Metal finish  
MFW White

### Top Finishes

- WVP PO01
- PM01 PO02
- PM02 PO03
- PM03 PO04
- PM04 PO05
- PM05 PO06
- PM06 PO07
- PM07 PO08
- PM08 PO09
- PM10

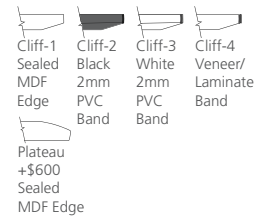

### Top Finishes

- WOW
- WNO
- WSO
- WLA

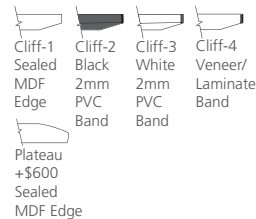

### Top Finishes

- GWL LW01
- LP01 LW02
- LP02 LW04
- LF01 LW05
- LF02 LW06
- LF03 LW07
- LN01
- LA01
- LA02



### Top Finishes

- FR01 FR10
- FR02 FR11
- FR03
- FR04
- FR05
- FR06
- FR07
- FR08
- FR09

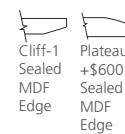

## 3 Select a edge

[View edge details](#)

## 4 Select hardware

[View hardware details](#)

## Product features.

- Adjustable height from 29" to 50" with a maximum weight capacity of 220 lbs.
- Lift available in MFW White (standard)
- Metal parts include 5 year warranty
- Programmable height adjustable mechanism, motor includes 2 year warranty
- Oval leg shape

## Options.

### ACCESSORIES

- K28: Articulating Keyboard w/ Mouse - \$390
- K31: Center drawer - \$205
- K31-SK: Center drawer w/ skirt - \$310

### GROMMETS (STANDARD LOCATION)

- Specify Color and Left/Right - \$50 ea.
- Black: TM30-R (Right), TM30-L (Left)
- Silver: TM31-R (Right), TM31-L (Left)
- White: TM34-R (Right), TM34-L (Left)

### GROMMETS (NON-STANDARD LOCATION)

- Provide drawing w/ grommet location and specify color - \$95 ea.
- Black: TM30-NS
- Silver: TM31-NS
- White: TM34-NS

### MODESTY

- HMAP14: Acoustic Panel Modesty - \$450

### PRIVACY SCREEN

- FAPS14: Acoustic Privacy Screen (Approach Privacy) - \$450
- SAPS14: Acoustic Privacy Screen (Side Privacy) - \$400

### WIRE MANAGEMENT

- W18: Coil wire manager - \$160

# Chameleon.

Conference Table  
Round Table with solid wood legs

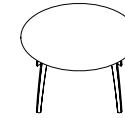

[View statement of line](#)

1 Select a model w" x d" x h"	weight	Standard Veneer Top Solid Wood Legs		Premium Veneer Top Solid Wood Legs		High Pressure Laminate Top Solid Wood Legs		Forbo Marmoleum Top Solid Wood Legs	
		60 DIA x 29	125	CHM6060RD121W	3305	CHM6060RD121P	3636	CHM6060RD121G	3036
54 DIA x 29	95	CHM5454RD121W	3044	CHM5454RD121P	3349	CHM5454RD121G	2851	CHM5454RD121F	3673
48 DIA x 29	85	CHM4848RD121W	2778	CHM4848RD121P	3056	CHM4848RD121G	2664	CHM4848RD121F	3383
42 DIA x 29	75	CHM4242RD121W	2512	CHM4242RD121P	2764	CHM4242RD121G	2479	CHM4242RD121F	3094

2 Select a finish <a href="#">View finish details</a>	Top Finishes		Leg Finishes		Top Finishes		Leg Finishes		Top Finishes		Leg Finishes		Top Finishes		Leg Finishes	
		WVP	PO01	WOW	PO06	WOW	WNO	PO07	WNO	WNO	PO07	WNO	PO07	WNO	PO07	WNO
	PM01	PO02	WNO	PO07	WNO	WNO	PO07	WNO	WNO	PO07	WNO	PO07	WNO	PO07	WNO	PO07
	PM02	PO03	WSO	PO08	WSO	WSO	PO08	WSO	WSO	PO08	WSO	PO08	WSO	PO08	WSO	PO08
	PM03	PO04	WLA	PO09	WLA	WLA	PO09	WLA	WLA	PO09	WLA	PO09	WLA	PO09	WLA	PO09
	PM04	PO05	PO01				PO01			PO01						
	PM05	PO06	PO02				PO02			PO02						
	PM06	PO07	PO03				PO03			PO03						
	PM07	PO08	PO04				PO04			PO04						
	PM08	PO09	PO05				PO05			PO05						
	PM10															

3 Select an edge <a href="#">View edge details</a>	Cliff-1				Cliff-2				Cliff-3				Cliff-4				Plateau	
		Cliff-1	Cliff-2	Cliff-3	Cliff-4	Cliff-1	Cliff-2	Cliff-3	Cliff-4	Cliff-1	Cliff-2	Cliff-3	Cliff-4	Cliff-1	Cliff-2	Cliff-3	Cliff-4	Plateau
	Sealed	Black	White	Veneer/	Sealed	Black	White	Veneer/	Sealed	Black	White	Veneer/	Sealed	Black	White	Veneer/	Sealed	Sealed
	MDF	2mm	2mm	Laminate	MDF	2mm	2mm	Laminate	MDF	2mm	2mm	Laminate	MDF	2mm	2mm	Laminate	+\$600	+\$600
	Edge	PVC	PVC	Band	Edge	PVC	PVC	Band	Edge	PVC	PVC	Band	Edge	PVC	PVC	Band	MDF	MDF
		Band	Band			Band	Band			Band	Band			Band	Band		Edge	Edge
	Plateau				Plateau				Plateau				Plateau					
	+\$600				+\$600				+\$600									
	Sealed				Sealed				Sealed									
	MDF Edge				MDF Edge				MDF Edge									

4 Select hardware <a href="#">View hardware details</a>

## Product features.

- 1" Thick top
- ENVI-CT Finish \*Environmental Coatings Technology
- Solid wood legs
- Ships KD

## Options.

### DELETE LEG

- DWL128: Delete one 28" leg - deduct \$300
- DWL228: Delete two 28" legs - deduct \$600

### MODIFY LEG

- M-1: Modify one 28" height leg to 7" height leg - no charge
- M-2: Modify two 28" height leg to 7" height leg - no charge
- M-3: Modify one 28" height leg to 14" height leg - no charge
- M-4: Modify two 28" height leg to 14" height leg - no charge

# Chameleon.

Swivel Conference Table  
Round Table with solid wood legs



[View statement of line](#)

1 Select a model w" x d" x h"	weight	Standard Veneer Top Solid Wood Legs		Premium Veneer Top Solid Wood Legs		High Pressure Laminate Top Solid Wood Legs		Forbo Marmoleum Top Solid Wood Legs	
60 DIA	125	CHM6060DR750W	3071	CHM6060DR750P	3379	CHM6060DR750G	2802	CHM6060DR750F	3723
54 DIA	95	CHM5454DR750W	2810	CHM5454DR750P	3091	CHM5454DR750G	2617	CHM5454DR750F	3439
48 DIA	85	CHM4848DR750W	2336	CHM4848DR750P	2570	CHM4848DR750G	2430	CHM4848DR750F	3149
42 DIA	75	CHM4242DR750W	2278	CHM4242DR750P	2506	CHM4242DR750G	2245	CHM4242DR750F	2860

2 Select a finish <a href="#">View finish details</a>	Top Finishes		Leg Finishes		Top Finishes	Leg Finishes		Top Finishes	Leg Finishes		Top Finishes	Leg Finishes			
	WVP	PO01	WOW	PO06	WOW	WOW	PO06	GWL	LW01	WOW	PO06	FR01	FR10	WOW	PO06
	PM01	PO02	WNO	PO07	WNO	WNO	PO07	LP01	LW02	WNO	PO07	FR02	FR11	WNO	PO07
	PM02	PO03	WSO	PO08	WSO	WSO	PO08	LP02	LW04	WSO	PO08	FR03		WSO	PO08
	PM03	PO04	WLA	PO09	WLA	WLA	PO09	LF01	LW05	WLA	PO09	FR04		WLA	PO09
	PM04	PO05		PO01			PO01	LF02	LW06		PO01	FR05			PO01
	PM05	PO06		PO02			PO02	LF03	LW07		PO02	FR06			PO02
	PM06	PO07		PO03			PO03	LN01			PO03	FR07			PO03
	PM07	PO08		PO04			PO04	LA01			PO04	FR08			PO04
	PM08	PO09		PO05			PO05	LA02			PO05	FR09			PO05
	PM10														

3 Select a edge <a href="#">View edge details</a>	Cliff-1				Cliff-2				Cliff-3				Cliff-4				Plateau	
	Cliff-1	Cliff-2	Cliff-3	Cliff-4	Cliff-1	Cliff-2	Cliff-3	Cliff-4	Cliff-1	Cliff-2	Cliff-3	Cliff-4	Cliff-1	Cliff-2	Cliff-3	Cliff-4	Cliff-1	Plateau
	Sealed	Black	White	Veneer/	Sealed	Black	White	Veneer/	Sealed	Black	White	Veneer/	Sealed	Black	White	Veneer/	Sealed	+\$600
	MDF	2mm	2mm	Laminate	MDF	2mm	2mm	Laminate	MDF	2mm	2mm	Laminate	MDF	2mm	2mm	Laminate	MDF	Sealed
	Edge	PVC	PVC	Band	Edge	PVC	PVC	Band	Edge	PVC	PVC	Band	Edge	PVC	PVC	Band	Edge	MDF
		Band	Band			Band	Band			Band	Band							Edge
	Plateau				Plateau				Plateau				Plateau				Plateau	
	+\$600				+\$600				+\$600				+\$600				+\$600	
	Sealed				Sealed				Sealed				Sealed				Sealed	
	MDF				MDF				MDF				MDF				MDF	
	Edge				Edge				Edge				Edge				Edge	

4 Select hardware <a href="#">View hardware details</a>	Hardware	

## Product features.

- 1" Thick top
- ENVI-CT Finish \*Environmental Coatings Technology
- Solid wood legs
- Table Top features rotating swivel mechanism and legs come with low profile nylon casters to protect carpet, tile and hardwood flooring

# Chameleon.

## 30" Ganging Credenza

### Modular Case

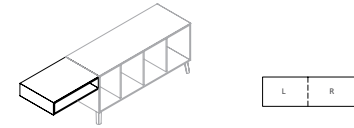

[View statement of line](#)

1 Select a model w" x d" x h"	weight	Standard Veneer Chassis	Premium Veneer Chassis	High Pressure Laminate Chassis	Forbo Marmoleum Chassis
		Ganging Unit	Ganging Unit	Ganging Unit	Solid Wood Legs
<b>7" Height Case</b> 30 x 22 x 7		CHM3007CU600W 853	CHM3007CU600P 939	CHM3007CU600G 771	"F" Option N/A
<b>14" Height Case</b> 30 x 22 x 14		CHM3014CU600W 1078	CHM3014CU600P 1186	CHM3014CU600G 967	"F" Option N/A
		<b>Case Finishes</b> WWP PO01 PM01 PO02 PM02 PO03 PM03 PO04 PM04 PO05 PM05 PO06 PM06 PO07 PM07 PO08 PM08 PO09 PM10 Edge N/A	<b>Case Finishes</b> WOW WLA WNO WSO Edge N/A	<b>Case Finishes</b> GWL LW01 LP01 LW02 LP02 LW04 LF01 LW05 LF02 LW06 LF03 LW07 LN01 LA01 LA02 Edge N/A	
		Push to Open Standard: Optional Hardward Below 	Push to Open Standard: Optional Hardward Below 	Push to Open Standard: Optional Hardward Below 	

## Product features.

- 4" belt line cavity for wire management
- Build your credenza based on your storage needs. Specify cases left to right based on above illustration.
- Mitered case construction utilizing 5/8" material
- Product ships assembled

### NOTES

- Unit designed for open plan use.

## Options.

### CONFIGURED STORAGE - 7" HEIGHT CASE (SPECIFICATION REQUIRED)

Specify location of each pedestal from left to right, see page 9 for Accent Finish pricing for Configured Storage.

- 15" Configured Storage
- OPS715: 15" Width Open Storage - \$85
  - SLD715: 15" Width Sliding Door - \$215
  - P1B715: 15" Width Box Drawer - \$210
- 30" Configured Storage

- OPS730: 30" Width Open Storage - \$85
- P1B730: 30" Width Box Drawer - \$245

### CONFIGURED STORAGE - 14" HEIGHT CASE (SPECIFICATION REQUIRED)

Specify location of each pedestal from left to right

- 15" Configured Storage
- OPS1415: 15" Width Open Storage - \$100
  - SLD1415: 15" Width Sliding Door - \$250
  - P1HD1415: 15" Width Hinged Door - \$200
  - P1F1415: 15" Width File Drawer - \$250
  - P1S1415: 15" Width Shelf - \$95

- 30" Configured Storage
- OPS1430: 30" Width Open Storage - \$100
  - P1DD1430: 30" Width Drop Door - \$500
  - P1L1430: 30" Width Lateral File Drawer - \$265
  - P1S1430: 30" Width Shelf - \$125

### GROMMETS (FOR GANGING)

Vertical sleeve grommet, template provided for field installation

- TM60: Vertical Grommet Sleeve - \$50

### DOOR LOCK

- D2: Door/ Lock (locks 1 door or 1 pedestal) - \$100 each

# Chameleon.

## 45" Ganging Credenza

### Modular Case

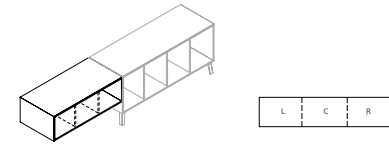

1 Select a model w" x d" x h"	weight	Standard Veneer Chassis	Premium Veneer Chassis	High Pressure Laminate Chassis	Forbo Marmoleum Chassis
		Ganging Unit	Ganging Unit	Ganging Unit	Solid Wood Legs
45 x 22 x 14		CHM4514CU600W 1510	CHM4514CU600P 1661	CHM4514CU600G 1349	"F" Option N/A
		<b>Case Finishes</b> WWP PO01 PM01 PO02 PM02 PO03 PM03 PO04 PM04 PO05 PM05 PO06 PM06 PO07 PM07 PO08 PM08 PO09 PM10 Edge N/A	<b>Case Finishes</b> WOW WLA WNO WSO Edge N/A	<b>Case Finishes</b> GWL LW01 LP01 LW02 LP02 LW04 LF01 LW05 LF02 LW06 LF03 LW07 LN01 LA01 LA02 Edge N/A	
		Push to Open Standard: Optional Hardware Below 	Push to Open Standard: Optional Hardware Below 	Push to Open Standard: Optional Hardware Below 	

[View statement of line](#)

## Product features.

- 4" belt line cavity for wire management
- Build your credenza based on your storage needs. Specify cases left to right based on above illustration.
- Mitered case construction utilizing 5/8" material
- Product ships assembled

### NOTES

- Unit designed for open plan use.

## Options.

### CONFIGURED STORAGE (SPECIFICATION REQUIRED) - 14" HEIGHT CASE

Specify location of each pedestal from left to right, see page 9 for Accent Finish pricing for Configured Storage.

- 15" Configured Storage
- OPS1415: 15" Width Open Storage - \$100
  - SLD1415: 15" Width Sliding Door - \$250
  - P1S1415: 15" Width Shelf \$95
  - P1HD1415: 15" Width Hinged Door - \$200
  - P1F1415: 15" Width File Drawer - \$250
- 30" Configured Storage
- OPS1430: 30" Width Open Storage - \$100
  - SLD1430: 30" Width Sliding Door - \$300
  - P1DD1430: 30" Width Drop Door - \$500
  - P1L1430: 30" Width Lateral File Drawer - \$265
  - P1S1430: 30" Width Shelf - \$125

### GROMMETS (FOR GANGING)

Vertical sleeve grommet, template provided for field installation

- TM60: Vertical Grommet Sleeve - \$50

### ADJUSTABLE SHELF

Specify location per adjustable shelf

- P1S2115: 15" Width Adjustable Shelf - \$95
- P1S2130: 30" Width Adjustable Shelf - \$125

### DOOR LOCK

- D2: Door/ Lock (locks 1 door or 1 pedestal) - \$100 each

# Chameleon.

60" Ganging Credenza  
Modular Case

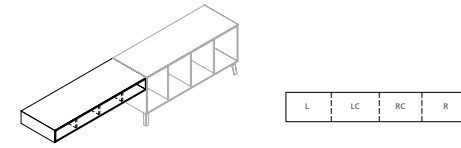

[View statement of line](#)

1 Select a model w" x d" x h"	weight	Standard Veneer Chassis	Premium Veneer Chassis	High Pressure Laminate Chassis	Forbo Marmoleum Chassis
		Ganging Unit	Ganging Unit	Ganging Unit	Solid Wood Legs
<b>7" Height Case</b> 60 x 22 x 7		CHM6007CU600W 1543	CHM6007CU600P 1698	CHM6007CU600G 1354	"F" Option N/A
<b>14" Height Case</b> 60 x 22 x 14		CHM6014CU600W 1652	CHM6014CU600P 1818	CHM6014CU600G 1480	"F" Option N/A
2 Select a finish <a href="#">View finish details</a>		Case Finishes WWP PO01 PM01 PO02 PM02 PO03 PM03 PO04 PM04 PO05 PM05 PO06 PM06 PO07 PM07 PO08 PM08 PO09 PM10	Case Finishes WOW WLA WNO WSO	Case Finishes GWL LW01 LP01 LW02 LP02 LW04 LF01 LW05 LF02 LW06 LF03 LW07 LN01 LA01 LA02	
3 Select an edge <a href="#">View edge details</a>		Edge N/A	Edge N/A	Edge N/A	
4 Select hardware <a href="#">View hardware details</a>		Push to Open Standard: Optional Hardware Below	Push to Open Standard: Optional Hardware Below	Push to Open Standard: Optional Hardware Below	

## Product features.

- 4" belt line cavity for wire management
- Build your credenza based on your storage needs. Specify cases left to right based on above illustration.
- Mitered case construction utilizing 5/8" material
- Product ships assembled

### NOTES

- Unit designed for open plan use.

## Options.

### CONFIGURED STORAGE - 7" HEIGHT CASE (SPECIFICATION REQUIRED)

Specify location of each pedestal from left to right, see page 9 for Accent Finish pricing for Configured Storage.

- 15" Configured Storage
- OPS715: 15" Width Open Storage - \$85
  - SLD715: 15" Width Sliding Door - \$215
  - P1B715: 15" Width Box Drawer - \$210
- 30" Configured Storage
- OPS730: 30" Width Open Storage - \$85
  - P1B730: 30" Width Box Drawer - \$245
  - P1B730: 30" Width Box Drawer - \$245

### CONFIGURED STORAGE - 14" HEIGHT CASE (SPECIFICATION REQUIRED)

Specify location of each pedestal from left to right

- 15" Configured Storage
- OPS1415: 15" Width Open Storage - \$100
  - SLD1415: 15" Width Sliding Door - \$250
  - P1HD1415: 15" Width Hinged Door - \$200
  - P1F1415: 15" Width File Drawer - \$250
  - P1S1415: 15" Width Shelf - \$95
- 30" Configured Storage
- OPS1430: 30" Width Open Storage - \$100
  - SLD1430: 30" Width Sliding Door - \$300
  - P1DD1430: 30" Width Drop Door - \$500
  - P1L1430: 30" Width Lateral File Drawer - \$265
  - P1S1430: 30" Width Shelf - \$125

### GROMMETS (FOR GANGING)

Vertical sleeve grommet, template provided for field installation

- TM60: Vertical Grommet Sleeve - \$50

### DOOR LOCK

- D2: Door/ Lock (locks 1 door or 1 pedestal) - \$100 each



# Chameleon.

## 75" Ganging Credenza

### Modular Case

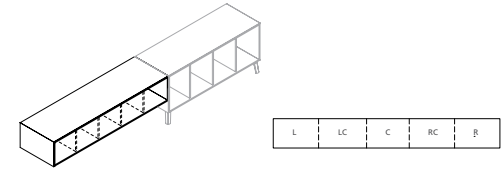

1 Select a model w" x d" x h"	weight	Standard Veneer Chassis Ganging Unit	Premium Veneer Chassis Ganging Unit	High Pressure Laminate Chassis Ganging Unit	Forbo Marmoleum Chassis Solid Wood Legs
75 x 22 x 14		CHM7514CU600W 2204	CHM7514CU600P 2425	CHM7514CU600G 1960	"F" Option N/A
2 Select a finish <i>View finish details</i>	Case Finishes	WWP PO01 PM01 PO02 PM02 PO03 PM03 PO04 PM04 PO05 PM05 PO06 PM06 PO07 PM07 PO08 PM08 PO09 PM10	Case Finishes	Case Finishes	
3 Select an edge <i>View edge details</i>	Edge	N/A	N/A	N/A	
4 Select hardware <i>View hardware details</i>	Push to Open Standard: Optional Hardware Below	PL - 406 Gloss White PL - 407 Matte Chrome	Push to Open Standard: Optional Hardware Below	Push to Open Standard: Optional Hardware Below	

[View statement of line](#)

## Product features.

- 4" belt line cavity for wire management
- Build your credenza based on your storage needs. Specify cases left to right based on above illustration.
- Mitered case construction utilizing 5/8" material
- Product ships assembled

### NOTES

- Unit designed for open plan use.

## Options.

### CONFIGURED STORAGE (SPECIFICATION REQUIRED) - 14" HEIGHT CASE

Specify location of each pedestal from left to right, see page 9 for Accent Finish pricing for Configured Storage.

#### 15" Configured Storage

- OPS1415: 15" Width Open Storage - \$100
- SLD1415: 15" Width Sliding Door - \$250
- P1HD1415: 15" Width Hinged Door - \$200
- P1F1415: 15" Width File Drawer - \$250
- P1S1415: 15" Width Shelf - \$95

#### 30" Configured Storage

- OPS1430: 30" Width Open Storage - \$100
- SLD1430: 30" Width Sliding Door - \$300
- P1DD1430: 30" Width Drop Door - \$500
- P1L1430: 30" Width Lateral File Drawer - \$265
- P1S1430: 30" Width Shelf - \$125

### GROMMETS (FOR GANGING)

Specify location of facing left, right or both grommet location with template

- TM60: Vertical Grommet Sleeve - \$50

### ADJUSTABLE SHELF

Specify location per adjustable shelf

- P1S2115: 15" Width Adjustable Shelf - \$95
- P1S2130: 30" Width Adjustable Shelf - \$125

### DOOR LOCK

- D2: Door/ Lock (locks 1 door or 1 pedestal) - \$100 each

# Chameleon.

30" Wide Freestanding Credenza  
Modular - 7" Height Case

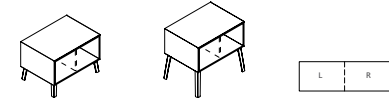

[View statement of line](#)

1 Select a model w" x d" x h"	weight	Standard Veneer Chassis Solid Wood Legs		Premium Veneer Chassis Solid Wood Legs		High Pressure Laminate Chassis Solid Wood Legs		Forbo Marmoleum Chassis Solid Wood Legs	
		<b>7" Height Case with 7" Leg</b> 30 x 22 x 14 <b>7" Height Case with 14" Leg</b> 30 x 22 x 21		CHM3014CA068W 1266 CHM3021CA068W 1376	CHM3014CA068P 1393 CHM3021CA068P 1514	CHM3014CA068G 1256 CHM3021CA068G 1393		"F" Option N/A "F" Option N/A	
2 Select a finish <a href="#">View finish details</a>		<b>Case Finishes</b> WWP PO01 PM01 PO02 PM02 PO03 PM03 PO04 PM04 PO05 PM05 PO06 PM06 PO07 PM07 PO08 PM08 PO09 PM10	<b>Leg Finishes</b> WOW PO06 WLA PO07 WNO PO08 WSO PO09 WLA PO01 WSO PO02 WNO PO03 WSO PO04 WNO PO05	<b>Case Finishes</b> WOW PO06 WNO PO07 WSO PO08 WLA PO09 WSO PO01 WNO PO02 WSO PO03 WNO PO04 WSO PO05	<b>Leg Finishes</b> WOW PO06 WLA PO07 WNO PO08 WSO PO09 WLA PO01 WSO PO02 WNO PO03 WSO PO04 WNO PO05	<b>Case Finishes</b> GWL LW01 LP01 LW02 LP02 LW04 LF01 LW05 LF02 LW06 LF03 LW07 LN01 LA01 LA02	<b>Leg Finishes</b> WOW PO06 WLA PO07 WNO PO08 WSO PO09 WSO PO01 WNO PO02 WSO PO03 WNO PO04 WSO PO05		
	3 Select an edge <a href="#">View edge details</a>		Edge N/A	Edge N/A	Edge N/A	Edge N/A	Edge N/A		
4 Select hardware <a href="#">View hardware details</a>		Push to Open Standard: Optional Hardward Below	Push to Open Standard: Optional Hardward Below	Push to Open Standard: Optional Hardward Below					

## Product features.

- 4" belt line cavity for wire management
- Build your credenza based on your storage needs. Specify cases left to right based on above illustration.
- Mitered case construction utilizing 5/8" material
- Product ships assembled
- Solid wood legs
- Dividers and shelves are finished to match case

### NOTES

- Unit designed for open plan use.
- Sliding door only available on side by side open storage

## Options.

### CONFIGURED STORAGE - 7" HEIGHT CASE (SPECIFICATION REQUIRED)

Specify location of each pedestal from left to right, see page 9 for

Accent Finish pricing for Configured Storage.

15" Configured Storage

- OPS715: 15" Width Open Storage - \$85
  - SLD715: 15" Width Sliding Door - \$215
  - P1B715: 15" Width Box Drawer - \$210
- 30" Configured Storage
- OPS730: 30" Width Open Storage-\$85
  - P1B730: 30" Width Box Drawer - \$245

### CUSHION

- BC30: Bench Cushion - \$354 com
- Specify fabric grade (5 yd. required) Recommended on 14" credenza to achieve 17" Seat Height

### GROMMETS (FOR GANGING)

Vertical sleeve grommet, template provided for field installation

- TM60: Vertical Grommet Sleeve - \$50

### DOOR LOCK

- D2: Door/ Lock (locks 1 door or 1 pedestal) - \$100 each

## BC30 Cushion fabric grades.

COM	COL	1	2	3
354	373	391	409	427
4	5	6	7	8
445	463	481	499	517
9	10	11/ L1	12	13/ L2
535	553	571	589	625

# Chameleon.

30" Wide Freestanding Credenza  
Modular - 14" Height Case

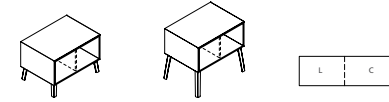

[View statement of line](#)

1 Select a model w" x d" x h"	weight	Standard Veneer Chassis Solid Wood Legs		Premium Veneer Chassis Solid Wood Legs		High Pressure Laminate Chassis Solid Wood Legs		Forbo Marmoleum Chassis Solid Wood Legs	
		<b>14" Height Case with 7" Leg</b> 30 x 22 x 21 <b>14" Height Case with 14" Leg</b> 30 x 22 x 28		CHM3021CA069W 1487 CHM3028CA069W 1597	CHM3021CA069P 1636 CHM3028CA069P 1757	CHM3021CA069G 1453 CHM3028CA069G 1589		"F" Option N/A "F" Option N/A	
2 Select a finish <a href="#">View finish details</a>		<b>Case Finishes</b> WWP PO01 PM01 PO02 PM02 PO03 PM03 PO04 PM04 PO05 PM05 PO06 PM06 PO07 PM07 PO08 PM08 PO09 PM10	<b>Leg Finishes</b> WOW PO06 WNO PO07 WSO PO08 WLA PO09	<b>Case Finishes</b> WOW PO06 WNO PO07 WSO PO08 WLA PO09	<b>Leg Finishes</b> WOW PO06 WNO PO07 WSO PO08 WLA PO09	<b>Case Finishes</b> GWL LW01 LP01 LW02 LP02 LW04 LF01 LW05 LF02 LW06 LF03 LW07 LN01 LA01 LA02	<b>Leg Finishes</b> WOW PO06 WLA PO07 WNO PO08 WSO PO09 PO01 PO02 PO03 PO04 PO05		
3 Select an edge <a href="#">View edge details</a>		Edge N/A		Edge N/A		Edge N/A			
4 Select hardware <a href="#">View hardware details</a>		Push to Open Standard: Optional Hardware Below	Push to Open Standard: Optional Hardware Below	Push to Open Standard: Optional Hardware Below		Push to Open Standard: Optional Hardware Below			

## Product features.

- 4" belt line cavity for wire management
- Build your credenza based on your storage needs. Specify cases left to right based on above illustration.
- Mitered case construction utilizing 5/8" material
- Product ships assembled
- Solid wood legs
- Dividers and shelves are finished to match case

### NOTES

- Unit designed for open plan use.
- Sliding door only available on side by side open storage

## Options.

### CONFIGURED STORAGE (SPECIFICATION REQUIRED)

Specify location of each pedestal from left to right, see page 9 for Accent Finish pricing for Configured Storage.

- 15" Configured Storage
  - OPS1415: 15" Width Open Storage - \$100
  - SLD1415: 15" Width Sliding Door - \$250
  - P1HD1415: 15" Width Hinged Door - \$200
  - P1F1415: 15" Width File Drawer - \$250
  - P1S1415: 15" Width Shelf - \$95
- 30" Configured Storage
  - OPS1430: 30" Width Open Storage - \$100
  - P1L1430: 30" Width Lateral File Drawer - \$265
  - P1S1430: 30" Width Shelf - \$125
  - P1DD1430: 30" Width Drop Door - \$500

### ADJUSTABLE SHELF

- Specify location per adjustable shelf
- P1S2115: 15" Width Adjustable Shelf - \$95
  - P1S2130: 30" Width Adjustable Shelf - \$125

### GROMMETS (FOR GANGING)

- Vertical sleeve grommet, template provided for field installation
- TM60: Vertical Grommet Sleeve - \$50

### DOOR LOCK

- D2: Door/ Lock (locks 1 door or 1 pedestal) - \$100 each

# Chameleon.

30" Wide Freestanding Credenza  
Modular - 21" Height Case

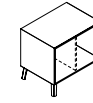

[View statement of line](#)

1 Select a model w" x d" x h"	weight	Standard Veneer Chassis Solid Wood Legs		Premium Veneer Chassis Solid Wood Legs		High Pressure Laminate Chassis Solid Wood Legs		Forbo Marmoleum Chassis Solid Wood Legs	
		21" Height Case with 7" Leg 30 x 22 x 28		CHM3028CA070W	1597	CHM3028CA070P	1757	CHM3028CA070G	1556
2 Select a finish <a href="#">View finish details</a>	Case Finishes	Leg Finishes		Case Finishes	Leg Finishes	Case Finishes	Leg Finishes		
	WVP PO01	WOW PO06		WOW	WOW PO06	GWL LW01	WOW PO06		
	PM01 PO02	WLA PO07		WNO	WLA PO07	LP01 LW02	WLA PO07		
	PM02 PO03	WNO PO08		WSO	WNO PO08	LP02 LW04	WNO PO08		
	PM03 PO04	WSO PO09		WLA	WSO PO09	LF01 LW05	WSO PO09		
	PM04 PO05	PO01			PO01	LF02 LW06	PO01		
	PM05 PO06	PO02			PO02	LF03 LW07	PO02		
	PM06 PO07	PO03			PO03	LN01	PO03		
	PM07 PO08	PO04			PO04	LA01	PO04		
	PM08 PO09	PO05			PO05	LA02	PO05		
PM10									
3 Select an edge <a href="#">View edge details</a>	Edge			Edge		Edge			
	N/A			N/A		N/A			
4 Select hardware <a href="#">View hardware details</a>	Push to Open Standard: Optional Hardware Below			Push to Open Standard: Optional Hardware Below		Push to Open Standard: Optional Hardware Below			

## Product features.

- 4" belt line cavity for wire management
- Build your credenza based on your storage needs. Specify cases left to right based on above illustration.
- Mitered case construction utilizing 5/8" material
- Product ships assembled
- Solid wood legs
- Dividers and shelves are finished to match case

### NOTES

- Unit designed for open plan use.
- Sliding door only available on side by side open storage

## Options.

### CONFIGURED STORAGE (SPECIFICATION REQUIRED)

Specify location of each pedestal from left to right, see page 9 for Accent Finish pricing for Configured Storage.

15" Configured Storage

- OPS2115: 15" Width Open Storage - \$125
- SLD2115: 15" Width Sliding Door - \$290
- P1HD2115: 15" Width Hinged Door - \$250
- P1BF2115: 15" Width Box/File Drawer - \$350

30" Configured Storage

- OPLF2130: 30" Width Open Upper/Lateral Lower File - \$400
- OPDD2130: 30" Width Open Upper / Drop Door Lower - \$650
- OPS2130: 30" Width Open Storage - \$125
- P1DD2130: 30" Width Drop Door - \$600
- P1BL2130: 30" Width Box/Lat. File Drawer - \$425

### ADJUSTABLE SHELF

Specify location per adjustable shelf

- P1S2115: 15" Width Adjustable Shelf - \$95
- P1S2130: 30" Width Adjustable Shelf - \$125

### GROMMETS (FOR GANGING)

Vertical sleeve grommet, template provided for field installation

- TM60: Vertical Grommet Sleeve - \$50

### DOOR LOCK

- D2: Door/ Lock (locks 1 door or 1 pedestal) - \$100 each

# Chameleon.

45" Wide Freestanding Credenza  
Modular - 14" Height Case

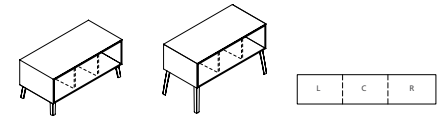

[View statement of line](#)

1 Select a model w" x d" x h"	weight	Standard Veneer Chassis Solid Wood Legs		Premium Veneer Chassis Solid Wood Legs		High Pressure Laminate Chassis Solid Wood Legs		Forbo Marmoleum Chassis Solid Wood Legs	
		<b>14" Height Case with 7" Leg</b> 45 x 22 x 21 <b>14" Height Case with 14" Leg</b> 45 x 22 x 28		CHM4521CA069W 1924 CHM4528CA069W 2045	CHM4521CA069P 2117 CHM4528CA069P 2250	CHM4521CA069G 1868 CHM4528CA069G 1999		"F" Option N/A "F" Option N/A	
2 Select a finish <a href="#">View finish details</a>	Case Finishes	Leg Finishes	Case Finishes	Leg Finishes	Case Finishes	Leg Finishes	Case Finishes	Leg Finishes	
	WWP PO01 PM01 PO02 PM02 PO03 PM03 PO04 PM04 PO05 PM05 PO06 PM06 PO07 PM07 PO08 PM08 PO09 PM10	WOW PO06 WLA PO07 WNO PO08 WSO PO09 WLA PO01 WSO PO02 WNO PO03 WSO PO04 WSO PO05	WOW PO06 WLA PO07 WNO PO08 WSO PO09 WLA PO01 WSO PO02 WNO PO03 WSO PO04 WSO PO05	GWL LW01 LP01 LW02 LP02 LW04 LF01 LW05 LF02 LW06 LF03 LW07 LN01 LA01 LA02	WOW PO06 WLA PO07 WNO PO08 WSO PO09 WLA PO01 WSO PO02 WNO PO03 WSO PO04 WSO PO05	Edge N/A	Edge N/A	Edge N/A	
3 Select an edge <a href="#">View edge details</a>	Edge		Edge		Edge		Edge		
	N/A		N/A		N/A		N/A		
4 Select hardware <a href="#">View hardware details</a>	Push to Open Standard: Optional Hardware Below		Push to Open Standard: Optional Hardware Below		Push to Open Standard: Optional Hardware Below		Push to Open Standard: Optional Hardware Below		

## Product features.

- 4" belt line cavity for wire management
- Build your credenza based on your storage needs. Specify cases left to right based on above illustration.
- Mitered case construction utilizing 5/8" material
- Product ships assembled
- Solid wood legs
- Dividers and shelves are finished to match case

### NOTES

- Unit designed for open plan use.
- Sliding door only available on side by side open storage

## Options.

### CONFIGURED STORAGE (SPECIFICATION REQUIRED)

Specify location of each pedestal from left to right, see page 9 for Accent Finish pricing for Configured Storage.

- 15" Configured Storage
  - OPS1415: 15" Width Open Storage - \$100
  - SLD1415: 15" Width Sliding Door - \$250
  - P1HD1415: 15" Width Hinged Door - \$200
  - P1F1415: 15" Width File Drawer - \$250
  - P1S1415: 15" Width Shelf - \$95
- 30" Configured Storage
  - OPS1430: 30" Width Open Storage - \$100
  - P1DD1430: 30" Width Drop Door - \$500
  - P1L1430: 30" Width Lateral File Drawer - \$265
  - P1S1430: 30" Width Shelf - \$125

### ADJUSTABLE SHELF

- Specify location per adjustable shelf
- P1S2115: 15" Width Adjustable Shelf - \$95
  - P1S2130: 30" Width Adjustable Shelf - \$125

### GROMMETS (FOR GANGING)

- Vertical sleeve grommet, template provided for field installation
- TM60: Vertical Grommet Sleeve - \$50

### DOOR LOCK

- D2: Door/ Lock (locks 1 door or 1 pedestal) - \$100 each

# Chameleon.

45" Wide Freestanding Credenza  
Modular - 21" Height Case

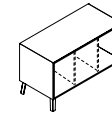

[View statement of line](#)

1 Select a model w" x d" x h"	weight	Standard Veneer Chassis Solid Wood Legs		Premium Veneer Chassis Solid Wood Legs		High Pressure Laminate Chassis Solid Wood Legs		Forbo Marmoleum Chassis Solid Wood Legs	
		21" Height Case with 7" Leg 45 x 22 x 28		CHM4528CA070W	2059	CHM4528CA070P	2265	CHM4528CA070G	1977
2 Select a finish <a href="#">View finish details</a>		<b>Case Finishes</b>	<b>Leg Finishes</b>	<b>Case Finishes</b>	<b>Leg Finishes</b>	<b>Case Finishes</b>	<b>Leg Finishes</b>	<b>Case Finishes</b>	<b>Leg Finishes</b>
		WWP PO01 PM01 PO02 PM02 PO03 PM03 PO04 PM04 PO05 PM05 PO06 PM06 PO07 PM07 PO08 PM08 PO09 PM10	PO01 WLA PO07 PO02 WNO PO08 PO03 WSO PO09 PO04 PO01 PO05 PO02 PO06 PO03 PO07 PO04 PO08 PO05	WOW WNO WSO WLA	WOW PO06 WLA PO07 WNO PO08 WSO PO09 PO01 PO02 PO03 PO04 PO05	GWL LW01 LP01 LW02 LP02 LW04 LF01 LW05 LF02 LW06 LF03 LW07 LN01 LA01 LA02	WOW PO06 WLA PO07 WNO PO08 WSO PO09 PO01 PO02 PO03 PO04 PO05		
3 Select an edge <a href="#">View edge details</a>		Edge N/A		Edge N/A		Edge N/A			
4 Select hardware <a href="#">View hardware details</a>		Push to Open Standard: Optional Hardware Below		Push to Open Standard: Optional Hardware Below		Push to Open Standard: Optional Hardware Below			

## Product features.

- 4" belt line cavity for wire management
- Build your credenza based on your storage needs. Specify cases left to right based on above illustration.
- Mitered case construction utilizing 5/8" material
- Product ships assembled
- Solid wood legs
- Dividers and shelves are finished to match case

### NOTES

- Unit designed for open plan use.
- Sliding door only available on side by side open storage

## Options.

### CONFIGURED STORAGE (SPECIFICATION REQUIRED)

Specify location of each pedestal from left to right, see page 9 for Accent Finish pricing for Configured Storage.

- 15" Configured Storage
  - OPS2115: 15" Width Open Storage - \$125
  - SLD2115: 15" Width Sliding Door - \$290
  - P1HD2115: 15" Width Hinged Door - \$250
  - P1BF2115: 15" Width Box/File Drawer - \$350
- 30" Configured Storage
  - OPS2130: 30" Width Open Storage - \$125
  - OPLF2130: 30" Width Open Upper/Lateral Lower File - \$400
  - OPDD2130: 30" Width Open Upper / Drop Door Lower - \$650
  - SLD2130: 30" Width Sliding Door - \$350
  - P1DD2130: 30" Width Drop Door - \$600
  - P1BL2130: 30" Width Box/Lat. File Drawer - \$425

### ADJUSTABLE SHELF

- Specify location per adjustable shelf
- P1S2115: 15" Width Adjustable Shelf - \$95
- P1S2130: 30" Width Adjustable Shelf - \$125

### GROMMETS (FOR GANGING)

- Vertical sleeve grommet, template provided for field installation
- TM60: Vertical Grommet Sleeve - \$50

### DOOR LOCK

- D2: Door/ Lock (locks 1 door or 1 pedestal) - \$100 each

# Chameleon.

60" Wide Freestanding Credenza  
Modular - 7" Height Case

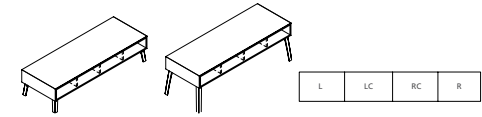

1 Select a model w" x d" x h"	weight	Standard Veneer Chassis Solid Wood Legs		Premium Veneer Chassis Solid Wood Legs		High Pressure Laminate Chassis Solid Wood Legs		Forbo Marmoleum Chassis Solid Wood Legs			
<b>7" Height Case with 7" Leg</b> 60 x 22 x 14		CHM6014CA068W	1939	CHM6014CA068P	2133	CHM6014CA068G	1878	"F" Option N/A			
<b>7" Height Case with 14" Leg</b> 60 x 22 x 21		CHM6021CA068W	2075	CHM6021CA068P	2283	CHM6021CA068G	2026	"F" Option N/A			
2 Select a finish <i>View finish details</i>	Case Finishes	Leg Finishes		Case Finishes	Leg Finishes	Case Finishes	Leg Finishes				
	WWP	PO01	WOW	PO06	WOW	WOW	PO06	GWL	LW01	WOW	PO06
	PM01	PO02	WLA	PO07	WNO	WLA	PO07	LP01	LW02	WLA	PO07
	PM02	PO03	WNO	PO08	WSO	WNO	PO08	LP02	LW04	WNO	PO08
	PM03	PO04	WSO	PO09	WLA	WSO	PO09	LF01	LW05	WSO	PO09
	PM04	PO05	PO01					LF02	LW06	PO01	
	PM05	PO06	PO02					LF03	LW07	PO02	
	PM06	PO07	PO03					LN01		PO03	
	PM07	PO08	PO04					LA01		PO04	
	PM08	PO09	PO05					LA02		PO05	
PM10											
3 Select an edge <i>View edge details</i>	Edge			Edge		Edge					
	N/A			N/A		N/A					
4 Select hardware <i>View hardware details</i>	Push to Open Standard: Optional Hardware Below			Push to Open Standard: Optional Hardware Below		Push to Open Standard: Optional Hardware Below					

*View statement of line*

## Product features.

- 4" belt line cavity for wire management
- Build your credenza based on your storage needs. Specify cases left to right based on above illustration.
- Mitered case construction utilizing 5/8" material
- Product ships assembled
- Solid wood legs
- Dividers and shelves are finished to match case

### NOTES

- Unit designed for open plan use.
- Sliding door only available on side by side open storage

## Options.

### CONFIGURED STORAGE (SPECIFICATION REQUIRED)

Specify location of each pedestal from left to right, see page 9 for Accent Finish pricing for Configured Storage.

- 15" Configured Storage
- OPS715: 15" Width Open Storage - \$85
- SLD715: 15" Width Sliding Door - \$215
- P1B715: 15" Width Box Drawer - \$210
- 30" Configured Storage
- OPS730: 30" Width Open Storage - \$85
- SLD730: 30" Width Sliding Door - \$250
- P1B730: 30" Width Box Drawer - \$245

### CUSHION

- BC30: Bench Cushion - \$354 com
- Specify fabric grade (5 yd. required) Recommended on 14" credenza to achieve 17" Seat Height

### GROMMETS (FOR GANGING)

- Vertical sleeve grommet, template provided for field installation
- TM60: Vertical Grommet Sleeve - \$50

### DOOR LOCK

- D2: Door/ Lock (locks 1 door or 1 pedestal) - \$100 each

## BC30 Cushion fabric grades.

COM	COL	1	2	3
354	373	391	409	427
4	5	6	7	8
445	463	481	499	517
9	10	11/ L1	12	13/ L2
535	553	571	589	625

# Chameleon.

60" Wide Freestanding Credenza  
Modular - 14" Height Case

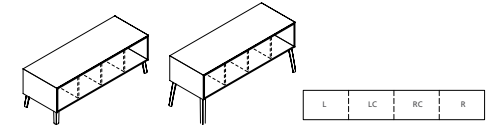

1 Select a model w" x d" x h"	weight	Standard Veneer Chassis Solid Wood Legs		Premium Veneer Chassis Solid Wood Legs		High Pressure Laminate Chassis Solid Wood Legs		Forbo Marmoleum Chassis Solid Wood Legs	
		<b>14" Height Case with 7" Leg</b> 60 x 22 x 21 <b>14" Height Case with 14" Leg</b> 60 x 22 x 28		CHM6021CA069W 2084 CHM6028CA069W 2215	CHM6021CA069P 2293 CHM6028CA069P 2437	CHM6021CA069G 2009 CHM6028CA069G 2146		"F" Option N/A "F" Option N/A	
2 Select a finish <i>View finish details</i>		<b>Case Finishes</b> WWP PO01 PM01 PO02 PM02 PO03 PM03 PO04 PM04 PO05 PM05 PO06 PM06 PO07 PM07 PO08 PM08 PO09 PM10	<b>Leg Finishes</b> WOW PO06 WLA PO07 WNO PO08 WSO PO09 PO01 PO02 PO03 PO04 PO05	<b>Case Finishes</b> WOW WNO WSO WLA	<b>Leg Finishes</b> WOW PO06 WLA PO07 WNO PO08 WSO PO09 PO01 PO02 PO03 PO04 PO05	<b>Case Finishes</b> GWL LP01 LP02 LF01 LF02 LF03 LN01 LA01 LA02	<b>Leg Finishes</b> LW01 LW02 LW04 LW05 LW06 LW07 PO01 PO02 PO03 PO04 PO05		
	3 Select a edge <i>View edge details</i>		Edge N/A	Edge N/A	Edge N/A	Edge N/A	Edge N/A		
4 Select hardware <i>View hardware details</i>		Push to Open Standard: Optional Hardware Below	Push to Open Standard: Optional Hardware Below	Push to Open Standard: Optional Hardware Below					

*View statement of line*

## Product features.

- 4" belt line cavity for wire management
- Build your credenza based on your storage needs. Specify cases left to right based on above illustration.
- Mitered case construction utilizing 5/8" material
- Product ships assembled
- Solid wood legs
- Dividers and shelves are finished to match case

### NOTES

- Unit designed for open plan use.
- Sliding door only available on side by side open storage

## Options.

### CONFIGURED STORAGE (SPECIFICATION REQUIRED)

Specify location of each pedestal from left to right, see page 9 for

Accent Finish pricing for Configured Storage.

15" Configured Storage

- OPS1415: 15" Width Open Storage - \$100
- SLD1415: 15" Width Sliding Door - \$250
- P1HD1415: 15" Width Hinged Door - \$200
- P1F1415: 15" Width File Drawer - \$250
- P1S1415: 15" Width Shelf - \$95

30" Configured Storage

- OPS1430: 30" Width Open Storage - \$100
- SLD1430: 30" Width Sliding Door - \$300
- P1DD1430: 30" Width Drop Door - \$500
- P1L1430: 30" Width Lateral File Drawer - \$265
- P1S1430: 30" Width Shelf - \$125

### ADJUSTABLE SHELF

Specify location per adjustable shelf

- P1S2115: 15" Width Adjustable Shelf - \$95
- P1S2130: 30" Width Adjustable Shelf - \$125

### GROMMETS (FOR GANGING)

Vertical sleeve grommet, template provided for field installation

- TM60: Vertical Grommet Sleeve - \$50

### DOOR LOCK

- D2: Door/ Lock (locks 1 door or 1 pedestal) - \$100 each



# Chameleon.

60" Wide Freestanding Credenza  
Modular - 21" Height Case

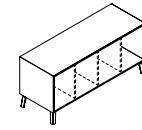

[View statement of line](#)

1 Select a model w" x d" x h"	weight	Standard Veneer Chassis Solid Wood Legs		Premium Veneer Chassis Solid Wood Legs		High Pressure Laminate Chassis Solid Wood Legs		Forbo Marmoleum Chassis Solid Wood Legs	
		21" Height Case with 7" Leg 60 x 22 x 28		CHM6028CA070W 2265	CHM6028CA070P 2492	CHM6028CA070G 2152	"F" Option N/A		
2 Select a finish <a href="#">View finish details</a>	Case Finishes	Leg Finishes	WWP PO01	WOW PO06	WNO PO07	WLA PO07	WLA PO07	WLA PO07	WLA PO07
			PM01 PO02	WNO PO08	WNO PO08	WNO PO08	WNO PO08	WNO PO08	WNO PO08
			PM02 PO03	WSO PO09	WSO PO09	WSO PO09	WSO PO09	WSO PO09	WSO PO09
			PM03 PO04	PO01	PO01	PO01	PO01	PO01	PO01
			PM04 PO05	PO02	PO02	PO02	PO02	PO02	PO02
			PM05 PO06	PO03	PO03	PO03	PO03	PO03	PO03
			PM06 PO07	PO04	PO04	PO04	PO04	PO04	PO04
			PM07 PO08	PO05	PO05	PO05	PO05	PO05	PO05
			PM08 PO09						
			PM10						
3 Select an edge <a href="#">View edge details</a>	Edge								
	N/A								
4 Select hardware <a href="#">View hardware details</a>	Push to Open Standard: Optional Hardware Below								

## Product features.

- 4" belt line cavity for wire management
- Build your credenza based on your storage needs. Specify cases left to right based on above illustration.
- Mitered case construction utilizing 5/8" material
- Product ships assembled
- Solid wood legs
- Dividers and shelves are finished to match case

### NOTES

- Unit designed for open plan use.
- Sliding door only available on side by side open storage

## Options.

### CONFIGURED STORAGE (SPECIFICATION REQUIRED)

Specify location of each pedestal from left to right, see page 9 for Accent Finish pricing for Configured Storage.

- 15" Configured Storage
- OPS2115: 15" Width Open Storage - \$125
- SLD2115: 15" Width Sliding Door - \$290
- P1HD2115: 15" Width Hinged Door - \$250
- P1BF2115: 15" Width Box/File Drawer - \$350
- 30" Configured Storage
- OPS2130: 30" Width Open Storage - \$125
- OPLF2130: 30" Width Open Upper/Lateral Lower File - \$400
- OPDD2130: 30" Width Open Upper / Drop Door Lower - \$650
- SLD2130: 30" Width Sliding Door - \$350
- P1DD2130: 30" Width Drop Door - \$600
- P1BL2130: 30" Width Box/Lat. File Drawer - \$425

### ADJUSTABLE SHELF

- Specify location per adjustable shelf
- P1S2115: 15" Width Adjustable Shelf - \$95
- P1S2130: 30" Width Adjustable Shelf - \$125

### GROMMETS (FOR GANGING)

- Vertical sleeve grommet, template provided for field installation
- TM60: Vertical Grommet Sleeve - \$50

### DOOR LOCK

- D2: Door/ Lock (locks 1 door or 1 pedestal) - \$100 each

# Chameleon.

75" Wide Freestanding Credenza  
Modular - 14" Height Case

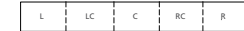
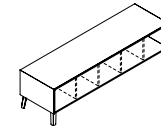

[View statement of line](#)

1 Select a model w" x d" x h"	weight	Standard Veneer Chassis Solid Wood Legs		Premium Veneer Chassis Solid Wood Legs		High Pressure Laminate Chassis Solid Wood Legs		Forbo Marmoleum Chassis Solid Wood Legs	
		14" Height Case with 7" Leg 75 x 22 x 21		CHM7521CA069W 2637	CHM7521CA069P 2901	CHM7521CA069G 2517	"F" Option N/A		
2 Select a finish <a href="#">View finish details</a>	Case Finishes	Leg Finishes	Case Finishes	Leg Finishes	Case Finishes	Leg Finishes	Case Finishes	Leg Finishes	
	WVP PO01	WOW PO06	WNO PO02	WLA PO07	WOW PO06	WOW PO06	WNO PO02	WLA PO07	
	PM01 PO02	WLA PO07	WNO PO03	WNO PO08	WNO PO07	WLA PO07	LP01 LW02	WLA PO07	
	PM02 PO03	WNO PO08	WSO PO04	WSO PO09	WSO PO08	WNO PO08	LP02 LW04	WNO PO08	
	PM03 PO04	WSO PO09	PM04 PO05	PO01	WLA PO09	WSO PO09	LF01 LW05	WSO PO09	
	PM04 PO05	PO01	PM05 PO06	PO02			LF02 LW06	PO01	
	PM05 PO06	PO02	PM06 PO07	PO03			LF03 LW07	PO02	
	PM06 PO07	PO03	PM07 PO08	PO04			LN01	PO03	
	PM07 PO08	PO04	PM08 PO09	PO05			LA01	PO04	
	PM08 PO09	PO05	PM10				LA02	PO05	
3 Select an edge <a href="#">View edge details</a>	Edge N/A		Edge N/A		Edge N/A				
4 Select hardware <a href="#">View hardware details</a>	Push to Open Standard: Optional Hardware Below		Push to Open Standard: Optional Hardware Below		Push to Open Standard: Optional Hardware Below				

## Product features.

- 4" belt line cavity for wire management
- Build your credenza based on your storage needs. Specify cases left to right based on above illustration.
- Mitered case construction utilizing 5/8" material
- Product ships assembled
- Solid wood legs
- Dividers and shelves are finished to match case

### NOTES

- Unit designed for open plan use.
- Sliding door only available on side by side open storage

## Options.

### CONFIGURED STORAGE (SPECIFICATION REQUIRED)

Specify location of each pedestal from left to right, see page 9 for Accent Finish pricing for Configured Storage.

- 15" Configured Storage
  - OPS1415: 15" Width Open Storage - \$100
  - SLD1415: 15" Width Sliding Door - \$250
  - P1HD1415: 15" Width Hinged Door - \$200
  - P1F1415: 15" Width File Drawer - \$250
  - P1S1415: 15" Width Shelf - \$95
- 30" Configured Storage
  - OPS1430: 30" Width Open Storage - \$100
  - SLD1430: 30" Width Sliding Door - \$300
  - P1DD1430: 30" Width Drop Door - \$500
  - P1L1430: 30" Width Lateral File Drawer - \$265
  - P1S1430: 30" Width Shelf - \$125

### ADJUSTABLE SHELF

- Specify location per adjustable shelf
- P1S2115: 15" Width Adjustable Shelf - \$95
- P1S2130: 30" Width Adjustable Shelf - \$125

### GROMMETS (FOR GANGING)

- Vertical sleeve grommet, template provided for field installation
- TM60: Vertical Grommet Sleeve - \$50

### DOOR LOCK

- D2: Door/ Lock (locks 1 door or 1 pedestal) - \$100 each

# Chameleon.

75" Wide Freestanding Credenza  
Modular - 21" Height Case

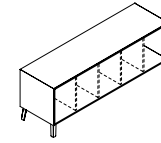

[View statement of line](#)

1 Select a model w" x d" x h"	weight	Standard Veneer Chassis Solid Wood Legs		Premium Veneer Chassis Solid Wood Legs		High Pressure Laminate Chassis Solid Wood Legs		Forbo Marmoleum Chassis Solid Wood Legs	
		21" Height Case with 7" Leg 75 x 22 x 28		CHM7528CA070W 2803	CHM7528CA070P 3084	CHM7528CA070G 2659	"F" Option N/A		
2 Select a finish <a href="#">View finish details</a>	Case Finishes	Leg Finishes	Case Finishes	Leg Finishes	Case Finishes	Leg Finishes	Case Finishes	Leg Finishes	
	WVP PO01 PM01 PO02 PM02 PO03 PM03 PO04 PM04 PO05 PM05 PO06 PM06 PO07 PM07 PO08 PM08 PO09 PM10	PO01 WOW PO06 PO02 WLA PO07 PO03 WNO PO08 PO04 WSO PO09 PO05 PO01 PO06 PO02 PO07 PO03 PO08 PO04 PO09 PO05	WNO WLA PO07 WSO WNO PO08 WLA WSO PO09	WOW WOW PO06 WNO WLA PO07 WSO WNO PO08 WLA WSO PO09	PO01 PO02 PO03 PO04 PO05	GWL LW01 LP01 LW02 LP02 LW04 LF01 LW05 LF02 LW06 LF03 LW07 LN01 LA01 LA02	WOW PO06 WLA PO07 WNO PO08 WSO PO09 PO01 PO02 PO03 PO04 PO05	Edge N/A	Edge N/A
3 Select an edge <a href="#">View edge details</a>	Edge	N/A	Edge	N/A	Edge	N/A	Edge	N/A	
4 Select hardware <a href="#">View hardware details</a>	Push to Open Standard: Optional Hardware Below		Push to Open Standard: Optional Hardware Below		Push to Open Standard: Optional Hardware Below		Push to Open Standard: Optional Hardware Below		

## Product features.

- 4" belt line cavity for wire management
- Build your credenza based on your storage needs. Specify cases left to right based on above illustration.
- Mitered case construction utilizing 5/8" material
- Product ships assembled
- Solid wood legs
- Dividers and shelves are finished to match case

### NOTES

- Unit designed for open plan use.
- Sliding door only available on side by side open storage

## Options.

### CONFIGURED STORAGE (SPECIFICATION REQUIRED)

Specify location of each pedestal from left to right, see page 9 for Accent Finish pricing for Configured Storage.

- 15" Configured Storage
  - OPS2115: 15" Width Open Storage - \$125
  - SLD2115: 15" Width Sliding Door - \$290
  - P1HD2115: 15" Width Hinged Door - \$250
  - P1BF2115: 15" Width Box/File Drawer - \$350
- 30" Configured Storage
  - OPS2130: 30" Width Open Storage - \$125
  - OPLF2130: 30" Width Open Upper/Lateral Lower File - \$400
  - OPDD2130: 30" Width Open Upper / Drop Door Lower - \$650
  - SLD2130: 30" Width Sliding Door - \$350
  - P1DD2130: 30" Width Drop Door - \$600
  - P1BL2130: 30" Width Box/Lat. File Drawer - \$425

### ADJUSTABLE SHELF

- Specify location per adjustable shelf
- P1S2115: 15" Width Adjustable Shelf - \$95
- P1S2130: 30" Width Adjustable Shelf - \$125

### GROMMETS (FOR GANGING)

- Vertical sleeve grommet, template provided for field installation
- TM60: Vertical Grommet Sleeve - \$50

### DOOR LOCK

- D2: Door/ Lock (locks 1 door or 1 pedestal) - \$100 each

# Chameleon.

30" Sit-On Storage  
Modular Case

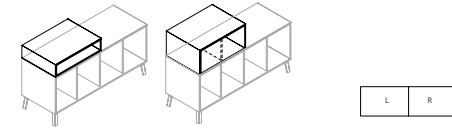

[View statement of line](#)

1 Select a model w" x d" x h"	weight	Standard Veneer Chassis Ganging Unit	Premium Veneer Chassis Ganging Unit	High Pressure Laminate Chassis Ganging Unit	Forbo Marmoleum Chassis Solid Wood Legs
<b>7" Height Case</b> 30 x 22 x 7		CHM3007SO600W 749	CHM3007SO600P 824	CHM3007SO600G 667	"F" Option N/A
<b>14" Height Case</b> 30 x 22 x 14		CHM3014SO600W 974	CHM3014SO600P 1072	CHM3014SO600G 863	"F" Option N/A
<b>2 Select a finish</b> <a href="#">View finish details</a>	Case Finishes	WWP PO01 PM01 PO02 PM02 PO03 PM03 PO04 PM04 PO05 PM05 PO06 PM06 PO07 PM07 PO08 PM08 PO09 PM10	Case Finishes WOW WNO WSO WLA	Case Finishes GWL LW01 LP01 LW02 LP02 LW04 LF01 LW05 LF02 LW06 LF03 LW07 LN01 LA01 LA02	
<b>3 Select an edge</b> <a href="#">View edge details</a>	Edge	N/A	N/A	N/A	
<b>4 Select hardware</b> <a href="#">View hardware details</a>	Push to Open Standard: Optional Hardware Below				

## Product features.

- 4" belt line cavity for wire management
- Build your credenza based on your storage needs. Specify cases left to right based on above illustration.
- Mitered case construction utilizing 5/8" material
- Product ships assembled
- Dividers and shelves are finished to match case
- Bumper Pads keep unit in place

### NOTES

- Unit designed for open plan use.
- Sliding door only available on side by side open storage
- Unit is not connected with fasteners unless specified

## Options.

### CONFIGURED STORAGE - 7" HEIGHT CASE (SPECIFICATION REQUIRED)

Specify location of each pedestal from left to right, see page 9 for Accent Finish pricing for Configured Storage.

15" Configured Storage

- OPS715: 15" Width Open Storage - \$85
- SLD715: 15" Width Sliding Door - \$215
- P1B715: 15" Width Box Drawer - \$210
- P1S1415: 15" Width Shelf - \$95

30" Configured Storage

- OPS730: 30" Width Open Storage-\$85
- P1B730: 30" Width Box Drawer - \$245
- MOD-OP: Open storage case front and back. Modify to open case both sides, delete back panel (includes middle partition) - Deduct \$50. Not available with doors; Only compatible with P1S1415 15" Width

### CONFIGURED STORAGE - 14" HEIGHT CASE (SPECIFICATION REQUIRED)

Specify location of each pedestal from left to right

- OPS1415: 15" Width Open Storage - \$100
- SLD1415: 15" Width Sliding Door - \$250
- P1HD1415: 15" Width Hinged Door - \$200
- P1S1415: 15" Width Shelf - \$95

30" Configured Storage

- OPS1430: 30" Width Open Storage - \$100
- P1S1430: 30" Width Shelf - \$125

# Chameleon.

30" Sit-On Storage  
Modular Case

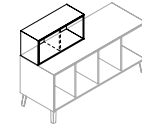

1 Select a model  
w" x d" x h"

weight

**14" Height Case**  
30 x 12 x 14

Standard Veneer Chassis Ganging Unit	Premium Veneer Chassis Ganging Unit	High Pressure Laminate Chassis Ganging Unit	Forbo Marmoleum Chassis Solid Wood Legs
--------------------------------------	-------------------------------------	---	---

CHM3014SO601W 884	CHM3014SO601P 973	CHM3014SO601G 785	"F" Option N/A
-------------------	-------------------	-------------------	----------------

[View statement of line](#)

2 Select a finish  
[View finish details](#)

Case Finishes

- WWP PO01
- PM01 PO02
- PM02 PO03
- PM03 PO04
- PM04 PO05
- PM05 PO06
- PM06 PO07
- PM07 PO08
- PM08 PO09
- PM10

Case Finishes

- WOW
- WNO
- WSO
- WLA

Case Finishes

- GWL LW01
- LP01 LW02
- LP02 LW04
- LF01 LW05
- LF02 LW06
- LF03 LW07
- LN01
- LA01
- LA02

3 Select a edge  
[View edge details](#)

Edge  
N/A

Edge  
N/A

Edge  
N/A

4 Select hardware  
[View hardware details](#)

Push to Open Standard:  
Optional Hardware Below



Push to Open Standard:  
Optional Hardware Below



Push to Open Standard:  
Optional Hardware Below



## Product features.

- Build your credenza based on your storage needs. Specify cases left to right based on above illustration.
- Mitered case construction utilizing 5/8" material
- Product ships assembled
- Dividers and shelves are finished to match case
- Bumper Pads keep unit in place

### NOTES

- Unit designed for open plan use.
- Unit is not connected with fasteners unless specified

## Options.

### CONFIGURED STORAGE - 14" HEIGHT CASE (SPECIFICATION REQUIRED)

- Specify location of each pedestal from left to right, see page 9 for Accent Finish pricing for Configured Storage.
- 15" Configured Storage
- OPS1415: 15" Width Open Storage - \$100
  - SLD1415: 15" Width Sliding Door - \$250
  - P1HD1415: 15" Width Hinged Door - \$200
  - P1S1415: 15" Width Shelf - \$95
- 30" Configured Storage
- OPS1430: 30" Width Open Storage - \$100
  - P1S1430: 30" Width Shelf - \$125
- MOD-OP: Open storage case front and back. Modify to open case both sides, delete back panel (includes middle partition) - Deduct \$50. Not available with doors; Only compatible with P1S1415 15" Width

# Chameleon.

45" Sit-On Storage  
Modular Case

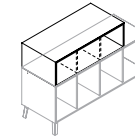

1 Select a model  
w" x d" x h"

weight

45 x 22 x 14 CHM4514SO600W 1406

Premium Veneer Chassis  
Ganging Unit

CHM4514SO600P 1547

High Pressure Laminate Chassis  
Ganging Unit

CHM4514SO600G 1245

[View statement of line](#)

Forbo Marmoleum Chassis  
Solid Wood Legs

"F" Option N/A

2 Select a finish  
[View finish details](#)

Case Finishes

- WWP PO01
- PM01 PO02
- PM02 PO03
- PM03 PO04
- PM04 PO05
- PM05 PO06
- PM06 PO07
- PM07 PO08
- PM08 PO09
- PM10

Case Finishes

- WOW
- WNO
- WSO
- WLA

Case Finishes

- GWL LW01
- LP01 LW02
- LP02 LW04
- LF01 LW05
- LF02 LW06
- LF03 LW07
- LN01
- LA01
- LA02

3 Select a edge  
[View edge details](#)

Edge  
N/A

Edge  
N/A

Edge  
N/A

4 Select hardware  
[View hardware details](#)

Push to Open Standard:  
Optional Hardware Below



Push to Open Standard:  
Optional Hardware Below



Push to Open Standard:  
Optional Hardware Below



## Product features.

- 4" belt line cavity for wire management
- Build your credenza based on your storage needs. Specify cases left to right based on above illustration.
- Mitered case construction utilizing 5/8" material
- Product ships assembled
- Dividers and shelves are finished to match case
- Bumper Pads keep unit in place

### NOTES

- Unit designed for open plan use.
- Sliding door only available on side by side open storage
- Unit is not connected with fasteners unless specified

## Options.

### CONFIGURED STORAGE (SPECIFICATION REQUIRED) - 14" HEIGHT CASE

Specify location of each pedestal from left to right, see page 9 for

Accent Finish pricing for Configured Storage.

15" Configured Storage

- OPS1415: 15" Width Open Storage - \$100
- SLD1415: 15" Width Sliding Door - \$250
- P1HD1415: 15" Width Hinged Door - \$200
- P1S1415: 15" Width Shelf - \$95

30" Configured Storage

- OPS1430: 30" Width Open Storage - \$100
- P1S1430: 30" Width Shelf - \$125

- MOD-OP: Open storage case front and back. Modify to open case both sides, delete back panel (includes middle partition) - Deduct \$50. Not available with doors; Only compatible with P1S1415 15" Width

# Chameleon.

Mobile Pedestals

Open Plan Mobile Desk Pedestal With Casters

optional top organizer

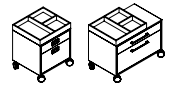
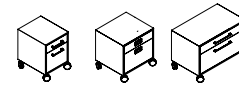

DARRAN

1 Select a model  
w" x d" x h"

weight	Standard Veneer Pedestal	Premium Veneer Pedestal	High Pressure Laminate Pedestal	Forbo Marmoleum Pedestal
<b>Box/File</b> 16 x 20 x 21	CHM1620PD423W 1572	CHM1620PD423P 1730	CHM1620PD423G 1453	"F" Option N/A
<b>Box/Drop Down Door</b> 20 x 20 x 21	CHM2020PD422W 1633	CHM2020PD422P 1797	CHM2020PD422G 1507	"F" Option N/A
30 x 20 x 21	CHM3020PD421W 1818	CHM3020PD421P 2000	CHM3020PD421G 1682	"F" Option N/A

[View statement of line](#)

## Product features.

- Anti-tilt safety feature
- Finished all sides and top - open plan

## Options.

### CUSHION

- BC16: Bench Cushion
- Specify fabric grade (1 yd. required) Recommended on 14" credenza to achieve 17" Seat Height

### TOP ACCESSORY TRAY

- SOWT1: Wood Tray Accessory - \$240
- SOLT1: High Pressure Laminate Tray Accessory - \$195

2 Select a finish  
[View finish details](#)

### Case Finishes

- WWP PO01
- PM01 PO02
- PM02 PO03
- PM03 PO04
- PM04 PO05
- PM05 PO06
- PM06 PO07
- PM07 PO08
- PM08 PO09
- PM10

### Case Finishes

- WOW
- WNO
- WSO
- WLA

### Case Finishes

- GWL LW01
- LP01 LW02
- LP02 LW04
- LF01 LW05
- LF02 LW06
- LF03 LW07
- LN01
- LA01
- LA02

3 Select an edge  
[View edge details](#)

Edge  
N/A

Edge  
N/A

Edge  
N/A

4 Select hardware  
[View hardware details](#)

Push to Open Standard:  
Optional Hardware Below

Push to Open Standard:  
Optional Hardware Below

Push to Open Standard:  
Optional Hardware Below



## BC16 Cushion fabric grades.

COM	COL	1	2	3
224	243	261	279	297
4	5	6	7	8
315	333	351	369	387
9	10	11/ L1	12	13/ L2
405	423	441	459	495

# Chameleon.

30" Single Height Wall Hung Overheads  
14" D Open Storage Cabinet



1 Select a model w" x d" x h"	weight	Standard Veneer Top	Premium Veneer Chassis	High Pressure Laminate Top	Forbo Marmoleum Top
		Standard Veneer Chassis	Premium Veneer Chassis	High Pressure Laminate Chassis	Forbo Marmoleum Chassis
2 Section 30 x 14 x 14		CHM3014WH332W 969	CHM3014WH332P 1066	CHM3014WH332G 786	"F" Option N/A
2 Select a finish View finish details		Case Finishes WWP PO01 PM01 PO02 PM02 PO03 PM03 PO04 PM04 PO05 PM05 PO06 PM06 PO07 PM07 PO08 PM08 PO09 PM10	Case Finishes WOW WNO WSO WLA	Case Finishes GWL LW01 LP01 LW02 LP02 LW04 LF01 LW05 LF02 LW06 LF03 LW07 LN01 LA01 LA02	
3 Select an edge View edge details		Edge N/A	Edge N/A	Edge N/A	
4 Select hardware View hardware details		 Touch Latch			

[View statement of line](#)

## Product features.

- Build your wall hung overhead based on your storage needs. Specify overheads based on above illustration.
- Interior cabinet depth 12"
- Mitered case construction utilizing 5/8" material
- Mounting wall rail included
- Product ships assembled

### NOTES

- 2 Section available with 15" sliding door
- Proper installation is critical to ensure safety from possible falling cabinets. The factory assumes no liability for damage or injury from the following: installation into non-load bearing or unlevel walls. Improper fasteners used in installation. Overloading of cabinets resulting in failures of wall and surrounding structures, fasteners, or cabinet construction. Misuse of cabinets for intended purposes.

## Options.

### STORAGE (SPECIFICATION REQUIRED)

- 15" Storage
- OPWH1415: 15" Width Open Storage - \$75
  - HDSWH1415: 15" Width Hinged Door - \$125
  - SLDWH1415: - 15" Width Sliding Door - \$200
- 30" Storage
- LUDWH1430: 30" Width Lift Up Door - \$250
  - P1DDWH1430: 30" Width Drop Door - \$450

### TASK LIGHTING (RECESSED)

- Overhead tasklight cord is located on the right facing side. If the opposite location is required please contact customer service.
- LT-LED24R: 24" LED Task light - \$180
  - LC24: Linking Task light - \$20

### DOOR LOCK

- D2: Door/ Lock (locks 1 door) - \$100 each



# Chameleon.

45" Single Height Wall Hung Overheads  
14" D Open Storage Cabinet

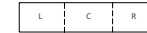
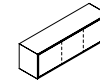

1 Select a model w" x d" x h"	weight	Standard Veneer Top	Premium Veneer Chassis	High Pressure Laminate Top	Forbo Marmoleum Top
		Standard Veneer Chassis	Premium Veneer Chassis	High Pressure Laminate Chassis	Forbo Marmoleum Chassis
<b>3 Section</b> 45 x 14 x 14		CHM4514WH332W 1386	CHM4514WH332P 1525	CHM4514WH332G 1152	"F" Option N/A
<b>2 Select a finish</b> <i>View finish details</i>	Case Finishes WWP PO01 PM01 PO02 PM02 PO03 PM03 PO04 PM04 PO05 PM05 PO06 PM06 PO07 PM07 PO08 PM08 PO09 PM10	Case Finishes WOW WNO WSO WLA	Case Finishes GWL LW01 LP01 LW02 LP02 LW04 LF01 LW05 LF02 LW06 LF03 LW07 LN01 LA01 LA02		
<b>3 Select an edge</b> <i>View edge details</i>	Edge N/A	Edge N/A	Edge N/A		
<b>4 Select hardware</b> <i>View hardware details</i>	 Touch Latch				

[View statement of line](#)

## Product features.

- Build your wall hung overhead based on your storage needs. Specify overheads based on above illustration.
- Interior cabinet depth 12"
- Mitered case construction utilizing 5/8" material
- Mounting wall rail included
- Product ships assembled

### NOTES

- 3 Section Overhead Available with 1 or 2 Sliding Doors
- Proper installation is critical to ensure safety from possible falling cabinets. The factory assumes no liability for damage or injury from the following: installation into non-load bearing or unlevel walls. Improper fasteners used in installation. Overloading of cabinets resulting in failures of wall and surrounding structures, fasteners, or cabinet construction. Misuse of cabinets for intended purposes.

## Options.

### STORAGE (SPECIFICATION REQUIRED)

- 15" Storage
- OPWH1415: 15" Width Open Storage - \$75
  - HDSWH1415: 15" Width Hinged Door - \$125
  - SLDWH1415: - 15" Width Sliding Door - \$200
- 30" Storage
- OPWH1430: 30" Width Open Storage - \$75
  - LUDWH1430: 30" Width Lift Up Door - \$250
  - P1DDWH1430: 30" Width Drop Door - \$450

### TASK LIGHTING (RECESSED)

- Overhead tasklight cord is located on the right facing side. If the opposite location is required please contact customer service.
- LT-LED24R: 24" LED Task light - \$180
  - LC24: Linking Task light - \$20

### DOOR LOCK

- D2: Door/ Lock (locks 1 door) - \$100 each

# Chameleon.

60" Single Height Wall Hung Overheads  
14" D Open Storage Cabinet

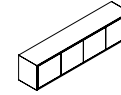

1 Select a model w" x d" x h"	weight	Standard Veneer Top	Premium Veneer Chassis	High Pressure Laminate Top	Forbo Marmoleum Top
		Standard Veneer Chassis	Premium Veneer Chassis	High Pressure Laminate Chassis	Forbo Marmoleum Chassis
4 Section 60 x 14 x 14		CHM6014WH332W 1527	CHM6014WH332P 1680	CHM6014WH332G 1256	"F" Option N/A
2 Select a finish <i>View finish details</i>	Case Finishes	WWP PO01 PM01 PO02 PM02 PO03 PM03 PO04 PM04 PO05 PM05 PO06 PM06 PO07 PM07 PO08 PM08 PO09 PM10	Case Finishes WOW WNO WSO WLA	Case Finishes GWL LW01 LP01 LW02 LP02 LW04 LF01 LW05 LF02 LW06 LF03 LW07 LN01 LA01 LA02	
3 Select an edge <i>View edge details</i>	Edge	N/A	N/A	N/A	
4 Select hardware <i>View hardware details</i>	 Touch Latch				

[View statement of line](#)

## Product features.

- Build your wall hung overhead based on your storage needs. Specify overheads based on above illustration.
- Interior cabinet depth 12"
- Mitered case construction utilizing 5/8" material
- Mounting wall rail included
- Product ships assembled

### NOTES

- 4 Section Overhead Available with 1 or 2 Sliding Doors
- Proper installation is critical to ensure safety from possible falling cabinets. The factory assumes no liability for damage or injury from the following: installation into non-load bearing or unlevel walls. Improper fasteners used in installation. Overloading of cabinets resulting in failures of wall and surrounding structures, fasteners, or cabinet construction. Misuse of cabinets for intended purposes.

## Options.

### STORAGE (SPECIFICATION REQUIRED)

- 15" Storage
- OPWH1415: 15" Width Open Storage - \$75
  - HDSWH1415: 15" Width Hinged Door - \$125
  - SLDWH1415: - 15" Width Sliding Door - \$200
- 30" Storage
- OPWH1430: 30" Width Open Storage - \$75
  - LUDWH1430: 30" Width Lift Up Door - \$250
  - P1DDWH1430: 30" Width Drop Door - \$450
  - SLDWH3015: - 30" Width Sliding Door - \$250

### TASK LIGHTING (RECESSED)

- Overhead tasklight cord is located on the right facing side. If the opposite location is required please contact customer service.
- LT-LED48R: 48" LED Task light - \$235
  - LC24: Linking Task light - \$20

### DOOR LOCK

- D2: Door/ Lock (locks 1 door) - \$100 each

# Chameleon.

Freestanding Screen - 40"W x 56"H  
Screen with Solid Wood Legs

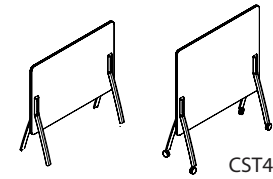

CST4 optional caster

1 Select a model		Fabric Tack Board Solid Wood Legs		Magnetic Marker Board Solid Wood Legs		White Acrylic Board Solid Wood Legs	
w" x d" x h"	weight						
40 x 18.5 x 56		CHM4056FT539	1842	CHM4056MB539	2090	CHM4056AB539	1930
2 Select a finish		Leg Finishes		Leg Finishes		Leg Finishes	
<a href="#">View finish details</a>		WOW PO07 WNO PO08 WSO PO09 WLA PO01 PO02 PO03 PO04 PO05 PO06		WOW PO06 WLA PO07 WNO PO08 WSO PO09 PO01 PO02 PO03 PO04 PO05		WOW PO06 WLA PO07 WNO WSO PO01 PO02 PO03 PO04 PO05	
3 Select a edge		Edge		Edge		Edge	
<a href="#">View edge details</a>		N/A		N/A		N/A	
4 Select hardware		N/A		N/A		N/A	
<a href="#">View hardware details</a>							

[View statement of line](#)

## Product features.

- Freestanding screen with the option of a fabric tack board, fabric magnetic board and magnetic marker board
- Solid steam bent leg with insert detail
- Inserts are standard veneer finished to match legs
- Legs are solid ash or walnut based on finish selection

### NOTES

- Fabric board: 2.5 yds
- Carton weight: 60 lbs

## Options.

### MOBILE SCREEN /ADD CASTER

- CST4: Add casters to screen Legs - \$200

### CONTRASTING LEG INSERTS

- Specify contrasting leg insert. Select any leg finish - \$120
- FLI01: Felt Leg Insert (specify color) - \$120

### MAGNETIC METAL TRAY

- MUT18: 18" White Magnetic Metal Tray - \$250
- Available on Fabric Magnetic and Magnetic Boards
- Specify Premium Metal Finish Color on Tray: \$60
- MFS: Silver, MFMB: Matte Black, MFGG: Graphite Gray, MFSS: Salmon Sienna, MFSA: Surfing Aquavert, MFPS: Pistachio, MFOS: Oyster, MFNA: Navy, MFOL: Olive, MFGB: Grey Beige

## Fabric Grades

COM	COL	1	2	3
1846	N/A	1939	1985	2031
4	5	6	7	8
2077	2123	2169	2215	2261
9	10	11	12	13
2307	2353	2399	2445	2537

# Chameleon.

Freestanding Screen - 54"W x 56"H  
Screen with Solid Wood Legs

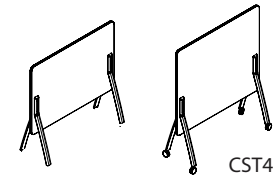

CST4 optional caster

1 Select a model		weight	Fabric Tack Board		Magnetic Marker Board		White Acrylic Board	
w" x d" x h"	Solid Wood Legs		Solid Wood Legs	Solid Wood Legs	Solid Wood Legs			
54 x 18.5 x 56	CHM5456FT539	1939		CHM5456MB539	2319		CHM5456AB539	2065
2 Select a finish		Leg Finishes		Leg Finishes		Leg Finishes		
<a href="#">View finish details</a>		WOW	PO07	WOW	PO06	WOW	PO06	
		WNO	PO08	WLA	PO07	WLA	PO07	
		WSO	PO09	WNO	PO08	WNO		
		WLA		WSO	PO09	WSO		
		PO01		PO01		PO01		
		PO02		PO02		PO02		
		PO03		PO03		PO03		
		PO04		PO04		PO04		
		PO05		PO05		PO05		
		PO06		PO06		PO06		
3 Select an edge		Edge		Edge		Edge		
<a href="#">View edge details</a>		N/A		N/A		N/A		
4 Select hardware		N/A		N/A		N/A		
<a href="#">View hardware details</a>								

[View statement of line](#)

## Product features.

- Freestanding screen with the option of a fabric tack board, fabric magnetic board and magnetic marker board
- Solid steam bent leg with insert detail
- Inserts are standard veneer finished to match legs
- Legs are solid ash or walnut based on finish selection

### NOTES

- Fabric board: 3.25 yds
- Carton weight: 80 lbs

## Options.

### MOBILE SCREEN /ADD CASTER

- CST4: Add casters to screen Legs - \$200

### CONTRASTING LEG INSERTS

- Specify contrasting leg insert. Select any leg finish - \$120
- FLI01: Felt Leg Insert (specify color) - \$120

### MAGNETIC METAL TRAY

- MUT18: 18" White Magnetic Metal Tray - \$250
- Available on Fabric Magnetic and Magnetic Boards
- Specify Premium Metal Finish Color on Tray: \$60
- MFS: Silver, MFMB: Matte Black, MFGG: Graphite Gray, MFSS: Salmon Sienna, MFSA: Surfing Aquavert, MFPS: Pistachio, MFOS: Oyster, MFNA: Navy, MFOL: Olive, MFGB: Grey Beige

## Fabric Grades

COM	COL	1	2	3
1943	N/A	2063	2122	2181
4	5	6	7	8
2240	2299	2358	2417	2476
9	10	11	12	13
2535	2594	2653	2712	2830

# Chameleon.

Freestanding Screen - 40"W x 66"H  
Screen with Solid Wood Legs

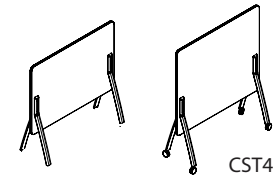

CST4 optional caster

1 Select a model		weight	Fabric Tack Board		Magnetic Marker Board		White Acrylic Board	
w" x d" x h"	Solid Wood Legs		Solid Wood Legs		Solid Wood Legs			
40 x 18.5 x 66	CHM4066FT539	1905		CHM4066MB539	2116	CHM4066AB539	2000	
2 Select a finish		Leg Finishes		Leg Finishes		Leg Finishes		
<a href="#">View finish details</a>		WOW	PO07	WOW	PO06	WOW	PO06	
		WNO	PO08	WLA	PO07	WLA	PO07	
		WSO	PO09	WNO	PO08	WNO		
		WLA		WSO	PO09	WSO		
		PO01		PO01		PO01		
		PO02		PO02		PO02		
		PO03		PO03		PO03		
		PO04		PO04		PO04		
		PO05		PO05		PO05		
		PO06		PO06		PO06		
3 Select an edge		Edge		Edge		Edge		
<a href="#">View edge details</a>		N/A		N/A		N/A		
4 Select hardware		N/A		N/A		N/A		
<a href="#">View hardware details</a>								

[View statement of line](#)

## Product features.

- Freestanding screen with the option of a fabric tack board, fabric magnetic board and magnetic marker board
- Solid steam bent leg with insert detail
- Inserts are standard veneer finished to match legs
- Legs are solid ash or walnut based on finish selection

### NOTES

- Fabric board: 2.5 yds
- Carton weight: 70 lbs

## Options.

### MOBILE SCREEN /ADD CASTER

- CST4: Add casters to screen Legs - \$200

### CONTRASTING LEG INSERTS

- Specify contrasting leg insert. Select any leg finish - \$120
- FLI01: Felt Leg Insert (specify color) - \$120

### MAGNETIC METAL TRAY

- MUT18: 18" White Magnetic Metal Tray - \$250
- Available on Fabric Magnetic and Magnetic Boards
- Specify Premium Metal Finish Color on Tray: \$60
- MFS: Silver, MFMB: Matte Black, MFGG: Graphite Gray, MFSS: Salmon Sienna, MFSA: Surfing Aquavert, MFPS: Pistachio, MFOS: Oyster, MFNA: Navy, MFOL: Olive, MFGB: Grey Beige

## Fabric Grades

COM	COL	1	2	3
1908	N/A	2001	2047	2093
4	5	6	7	8
2139	2185	2231	2277	2323
9	10	11	12	13
2369	2415	2461	2507	2599

# Chameleon.

Freestanding Screen - - 54"W x 66"H  
Screen with Solid Wood Legs

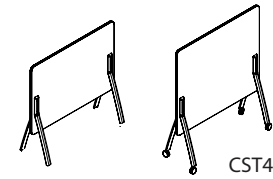

CST4 optional caster

1 Select a model		Fabric Tack Board Solid Wood Legs		Magnetic Marker Board Solid Wood Legs		White Acrylic Board Solid Wood Legs	
w" x d" x h"	weight						
54 x 18.5 x 66		CHM5466FT539	2009	CHM5466MB539	2350	CHM5466AB539	2144
2 Select a finish		Leg Finishes		Leg Finishes		Leg Finishes	
<a href="#">View finish details</a>		WOW PO07		WOW PO06		WOW PO06	
		WNO PO08		WLA PO07		WLA PO07	
		WSO PO09		WNO PO08		WNO	
				WSO PO09		WSO	
				PO01		PO01	
				PO02		PO02	
				PO03		PO03	
				PO04		PO04	
				PO05		PO05	
				PO06			
3 Select a edge		Edge		Edge		Edge	
<a href="#">View edge details</a>		N/A		N/A		N/A	
4 Select hardware		N/A		N/A		N/A	
<a href="#">View hardware details</a>							

[View statement of line](#)

## Product features.

- Freestanding screen with the option of a fabric tack board, fabric magnetic board and magnetic marker board
- Solid steam bent leg with insert detail
- Inserts are standard veneer finished to match legs
- Legs are solid ash or walnut based on finish selection

### NOTES

- Fabric board: 3.25 yds
- Carton weight: 90 lbs

## Options.

### MOBILE SCREEN /ADD CASTER

- CST4: Add casters to screen Legs - \$200

### CONTRASTING LEG INSERTS

- Specify contrasting leg insert. Select any leg finish - \$120
- FLI01: Felt Leg Insert (specify color) - \$120

### MAGNETIC METAL TRAY

- MUT18: 18" White Magnetic Metal Tray - \$250
- Available on Fabric Magnetic and Magnetic Boards
- Specify Premium Metal Finish Color on Tray: \$60
- MFS: Silver, MFMB: Matte Black, MFGG: Graphite Gray, MFSS: Salmon Sienna, MFSA: Surfing Aquavert, MFPS: Pistachio, MFOS: Oyster, MFNA: Navy, MFOL: Olive, MFGB: Grey Beige

## Fabric Grades

COM	COL	1	2	3
2014	N/A	2134	2193	2252
4	5	6	7	8
2311	2370	2429	2488	2547
9	10	11	12	13
2606	2665	2724	2783	2901

# Chameleon.

Vertical Half Tower  
Storage - Panel Door

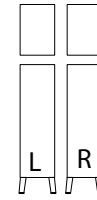

[View statement of line](#)

1 Select a model w" x d" x h"	weight	Standard Veneer Chassis Solid Wood Legs		Premium Veneer Chassis Solid Wood Legs		High Pressure Laminate Chassis Solid Wood Legs		Forbo Marmoleum Chassis Solid Wood Legs	
		<b>Door Hinged Left</b> 15 x 22 x 56 15 x 22 x 70 <b>Door Hinged Right</b> 15 x 22 x 56 15 x 22 x 70		CHM1556TW610W 2125 CHM1570TW610W 2325	CHM1556TW610P 2338 CHM1570TW610P 2558	CHM1556TW610G 1922 CHM1570TW610G 2124	CHM1556TW611G 1922 CHM1570TW611G 2124	"F" Option N/A "F" Option N/A	"F" Option N/A "F" Option N/A
2 Select a finish <a href="#">View finish details</a>		Case Finishes Leg Finishes WWP PO01 WOW PO06 PM01 PO02 WLA PO07 PM02 PO03 WNO PO08 PM03 PO04 WSO PO09 PM04 PO05 PO01 PM05 PO06 PO02 PM06 PO07 PO03 PM07 PO08 PO04 PM08 PO09 PO05 PM10	Case Finishes Leg Finishes WOW WOW PO06 WNO WLA PO07 WSO WNO PO08 WLA WSO PO09	Case Finishes Leg Finishes GWL LW01 WOW PO06 LP01 LW02 WLA PO07 LP02 LW04 WNO PO08 LF01 LW05 WSO PO09 LF02 LW06 PO01 LF03 LW07 PO02 LN01 PO03 LA01 PO04 LA02 PO05	Edge N/A	Edge N/A	Edge N/A		
3 Select an edge <a href="#">View edge details</a>		Edge N/A	Edge N/A	Edge N/A					
4 Select hardware <a href="#">View hardware details</a>		Push to Open Standard: Optional Hardware Below	Push to Open Standard: Optional Hardware Below	Push to Open Standard: Optional Hardware Below					

## Product features.

- 56" has 3 finished adjustable shelves
- 70" has 1 fixed and 3 adjustable finished shelves
- Mitered case construction utilizing 5/8" material
- Product ships assembled
- Solid wood legs

### NOTES

- Unit designed for open plan use.
- 56" H Interior Measurements for: 16-5/8" W x 20-5/8" D x 47-5/8" H
- 70" H Interior Measurements for: 16-5/8" W x 20-5/8" D x 61-5/8" H

## Options.

### DOOR

- D2: Door/ Lock (locks 1 door or 1 pedestal) - \$100 each
- D6: Delete doors - n/c
- D9SC: Soft Close Door Hinges - \$35 per door

### GROMMETS (FOR GANGING)

- Vertical sleeve grommet, template provided for field installation
- TM60: Vertical Grommet Sleeve - \$50

# Chameleon.

Vertical Half Tower  
Storage Wardrobe - Panel Door

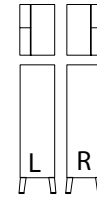

[View statement of line](#)

1 Select a model w" x d" x h"	weight	Standard Veneer Chassis Solid Wood Legs		Premium Veneer Chassis Solid Wood Legs		High Pressure Laminate Chassis Solid Wood Legs		Forbo Marmoleum Chassis Solid Wood Legs	
		<b>Door Hinged Left</b> 15 x 22 x 56 15 x 22 x 70 <b>Door Hinged Right</b> 15 x 22 x 56 15 x 22 x 70		CHM1556TW612W 2333 CHM1570TW612W 2533	CHM1556TW612P 2567 CHM1570TW612P 2786	CHM1556TW612G 2130 CHM1570TW612G 2332	CHM1556TW613P 2567 CHM1570TW613P 2787	CHM1556TW613G 2130 CHM1570TW613G 2332	"F" Option N/A "F" Option N/A "F" Option N/A "F" Option N/A
2 Select a finish <a href="#">View finish details</a>		Case Finishes    Leg Finishes WWP    PO01    WOW    PO06 PM01    PO02    WLA    PO07 PM02    PO03    WNO    PO08 PM03    PO04    WSO    PO09 PM04    PO05    PO01 PM05    PO06    PO02 PM06    PO07    PO03 PM07    PO08    PO04 PM08    PO09    PO05 PM10	Case Finishes    Leg Finishes WOW    WOW    PO06 WNO    WLA    PO07 WSO    WNO    PO08 WLA    WSO    PO09	Case Finishes    Leg Finishes GWL    LW01    WOW    PO06 LP01    LW02    WLA    PO07 LP02    LW04    WNO    PO08 LF01    LW05    WSO    PO09 LF02    LW06    PO01 LF03    LW07    PO02 LN01    PO03 LA01    PO04 LA02    PO05					
3 Select an edge <a href="#">View edge details</a>		Edge N/A	Edge N/A	Edge N/A					
4 Select hardware <a href="#">View hardware details</a>		Push to Open Standard: Optional Hardware Below 	Push to Open Standard: Optional Hardware Below 	Push to Open Standard: Optional Hardware Below 					

## Product features.

- 56" has 3 finished fixed shelves
- 70" has 1 fixed and 3 adjustable finished shelves
- Mitered case construction utilizing 5/8" material
- Product ships assembled
- Wardrobe w/ hook
- Solid wood legs

### NOTES

- Unit designed for open plan use.
- 56" H Interior Measurements
- Wardrobe: 4-1/2" x 20-5/8" x 47-5/8". Storage: 9-1/8" x 20-5/8" x 47-5/8"
- 70" H Interior Measurements
- Wardrobe: 4-1/2" x 20-5/8" x 61-5/8". Storage: 9-1/8" x 20-5/8" x 61-5/8"

## Options.

### DOOR

- D2: Door/ Lock (locks 1 door or 1 pedestal) - \$100 each
- D6: Delete doors - n/c
- D9SC: Soft Close Door Hinges - \$35 per door

### GROMMETS (FOR GANGING)

- Vertical sleeve grommet, template provided for field installation
- TM60: Vertical Grommet Sleeve - \$50



# Chameleon.

Vertical Full Tower  
Storage Wardrobe - Panel Door

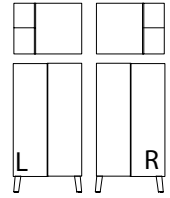
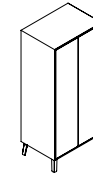

**1** Select a model  
w" x d" x h"

weight	Standard Veneer Chassis Solid Wood Legs		Premium Veneer Chassis Solid Wood Legs		High Pressure Laminate Chassis Solid Wood Legs		Forbo Marmoleum Chassis Solid Wood Legs		
	<b>Left Wardrobe</b> 30 x 22 x 56 30 x 22 x 70	CHM3056TW615W 3034 CHM3070TW615W 3340	CHM3056TW615P 3338 CHM3070TW615P 3674	CHM3056TW615G 2725 CHM3070TW615G 3047	"F" Option N/A "F" Option N/A	<b>Right Wardrobe</b> 30 x 22 x 56 30 x 22 x 70	CHM3056TW616W 3034 CHM3070TW616W 3340	CHM3056TW616P 3338 CHM3070TW616P 3674	CHM3056TW616G 2725 CHM3070TW616G 3047

[View statement of line](#)

## Product features.

- 56" has 3 finished adjustable shelves
- 70" has 1 fixed and 3 adjustable finished shelves
- Mitered case construction utilizing 5/8" material
- Product ships assembled
- Wardrobe w/ coat rod & hook
- Solid wood legs

### NOTES

- Unit designed for open plan use.
- 56" H Interior Measurements
- Wardrobe: 9-3/8" x 20-5/8" x 47-5/8". Storage: 18-5/8" x 20-5/8" x 47-5/8"
- 70" H Interior Measurements
- Wardrobe: 9-3/8" x 20-3/8" x 61-5/8". Storage: 18-5/8" x 20-5/8" x 61-5/8"

## Options.

### DOOR

- D2: Door/ Lock (locks 1 door or 1 pedestal) - \$100 each
- D6: Delete doors - n/c
- D9SC: Soft Close Door Hinges - \$35 per door

### GROMMETS (FOR GANGING)

- Vertical sleeve grommet, template provided for field installation
- TM60: Vertical Grommet Sleeve - \$50

**2** Select a finish  
[View finish details](#)

Case Finishes	Leg Finishes	Case Finishes	Leg Finishes	Case Finishes	Leg Finishes
WWP	PO01	WOW	PO06	GWL	LW01
PM01	PO02	WLA	PO07	LP01	LW02
PM02	PO03	WNO	PO08	LP02	LW04
PM03	PO04	WSO	PO09	LF01	LW05
PM04	PO05	WLA	PO01	LF02	LW06
PM05	PO06		PO02	LF03	LW07
PM06	PO07		PO03	LN01	
PM07	PO08		PO04	LA01	
PM08	PO09		PO05	LA02	
PM10					

**3** Select a edge  
[View edge details](#)

**4** Select hardware  
[View hardware details](#)

Push to Open Standard:  
Optional Hardware Below



Push to Open Standard:  
Optional Hardware Below



Push to Open Standard:  
Optional Hardware Below



# Chameleon.

Vertical Full Tower

Storage Side Access Wardrobe - Panel Door

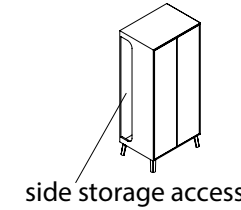

side storage access

## 1 Select a model

w" x d" x h"

weight	Standard Veneer Chassis		Premium Veneer Chassis		High Pressure Laminate Chassis		Forbo Marmoleum Chassis	
	Solid Wood Legs		Solid Wood Legs		Solid Wood Legs		Solid Wood Legs	
<b>Left Wardrobe</b>								
30 x 22 x 56	CHM3056TW617W	3116	CHM3056TW617P	3428	CHM3056TW617G	2768	"F" Option N/A	
30 x 22 x 70	CHM3070TW617W	3411	CHM3070TW617P	3752	CHM3070TW617G	3106	"F" Option N/A	
<b>Right Wardrobe</b>								
30 x 22 x 56	CHM3056TW618W	3085	CHM3056TW618P	3394	CHM3056TW618G	2768	"F" Option N/A	
30 x 22 x 70	CHM3070TW618W	3411	CHM3070TW618P	3753	CHM3070TW618G	3106	"F" Option N/A	

[View statement of line](#)

## Product features.

- 56" has 3 finished adjustable shelves
- 70" has 4 finished fixed shelves
- Mitered case construction utilizing 5/8" material
- Product ships assembled
- Side Access Wardrobe w/ coat rod & hook
- Solid wood legs

### NOTES

- Unit designed for open plan use.
- 56" H Interior Measurements
- Wardrobe: 28-5/8" x 7-1/4" x 47-5/8". Storage: 28-5/8" x 12-3/4" x 47-5/8"
- 70" H Interior Measurements
- Wardrobe: 28-5/8" x 7-1/4" x 61-5/8". Storage: 28-5/8" x 12-3/4" x 61-5/8"

## Options.

### DOOR

- D2: Door/ Lock (locks 1 door or 1 pedestal) - \$100 each
- D6: Delete doors - n/c
- D9SC: Soft Close Door Hinges - \$35 per door

### GROMMETS (FOR GANGING)

- Vertical sleeve grommet, template provided for field installation
- TM60: Vertical Grommet Sleeve - \$50

## 2 Select a finish

[View finish details](#)

Case Finishes	Leg Finishes	Case Finishes	Leg Finishes	Case Finishes	Leg Finishes
WWP	PO01	WOW	PO06	GWL	LW01
PM01	PO02	WLA	PO07	LP01	LW02
PM02	PO03	WNO	PO08	LP02	LW04
PM03	PO04	WSO	PO09	LF01	LW05
PM04	PO05			LF02	LW06
PM05	PO06			LF03	LW07
PM06	PO07			LN01	
PM07	PO08			LA01	
PM08	PO09			LA02	
PM10					

## 3 Select a edge

[View edge details](#)

## 4 Select hardware

[View hardware details](#)

Push to Open Standard:  
Optional Hardware Below



Push to Open Standard:  
Optional Hardware Below



Push to Open Standard:  
Optional Hardware Below



# Chameleon.

Vertical Full Tower  
Storage - Panel Door

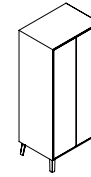

[View statement of line](#)

1 Select a model w" x d" x h"	weight	Standard Veneer Chassis Solid Wood Legs		Premium Veneer Chassis Solid Wood Legs		High Pressure Laminate Chassis Solid Wood Legs		Forbo Marmoleum Chassis Solid Wood Legs	
		30 x 22 x 56 30 x 22 x 70		CHM3056TW614W 2948 CHM3070TW614W 3154	CHM3056TW614P 3243 CHM3070TW614P 3470	CHM3056TW614G 2654 CHM3070TW614G 2960		"F" Option N/A "F" Option N/A	
2 Select a finish <a href="#">View finish details</a>		Case Finishes WWP PO01 PM01 PO02 PM02 PO03 PM03 PO04 PM04 PO05 PM05 PO06 PM06 PO07 PM07 PO08 PM08 PO09 PM10	Leg Finishes WOW PO06 WLA PO07 WNO PO08 WSO PO09 PO01 PO02 PO03 PO04 PO05	Case Finishes WOW WNO WSO WLA	Leg Finishes WOW PO06 WLA PO07 WNO PO08 WSO PO09 PO01 PO02 PO03 PO04 PO05	Case Finishes GWL LP01 LP02 LF01 LF02 LF03 LN01 LA01 LA02	Leg Finishes LW01 LW02 LW04 LW05 LW06 LW07 PO01 PO02 PO03 PO04 PO05		
	3 Select a edge <a href="#">View edge details</a>		Edge N/A	Edge N/A	Edge N/A				
4 Select hardware <a href="#">View hardware details</a>		Push to Open Standard: Optional Hardware Below	Push to Open Standard: Optional Hardware Below	Push to Open Standard: Optional Hardware Below					

## Product features.

- 56" has 3 finished fixed shelves
- 70" has 4 finished fixed shelves
- Mitered case construction utilizing 5/8" material
- Product ships assembled
- Solid wood legs

### NOTES

- Unit designed for open plan use.
- 56" H Interior Measurements
- Wardrobe: 28-5/8" x 20-5/8" x 47-5/8". Storage: 28-5/8" x 20-5/8" x 47-5/8"
- 70" H Interior Measurements
- Wardrobe: 28-5/8" x 20-5/8" x 47-5/8" Storage: 28-5/8" W x 20-5/8" D x 61-5/8" H

## Options.

### DOOR

- D2: Door/ Lock (locks 1 door or 1 pedestal) - \$100 each
- D6: Delete doors - n/c
- D9SC: Soft Close Door Hinges - \$35 per door

### GROMMETS (FOR GANGING)

- Vertical sleeve grommet, template provided for field installation
- TM60: Vertical Grommet Sleeve - \$50

# Chameleon.

Open Plan Bookcase  
Fixed Type A Insert Placement

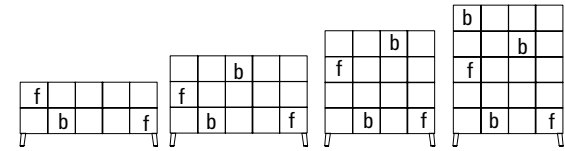

## 1 Select a model

w" x d" x h"

weight

Standard Veneer Chassis Solid Wood Legs	Premium Veneer Chassis Solid Wood Legs	High Pressure Laminate Chassis Solid Wood Legs	Forbo Marmoleum Chassis Solid Wood Legs
--	---	---	--

75.5 x 15 x 35	CHM7635BK244W 2859	CHM7635BK244P 3145	CHM7635BK244G 2635	"F" Option N/A
75.5 x 15 x 50	CHM7650BK244W 3205	CHM7650BK244P 3526	CHM7650BK244G 3004	"F" Option N/A
61 x 15 x 63	CHM6163BK244W 3299	CHM6163BK244P 3629	CHM6163BK244G 3080	"F" Option N/A
61 x 15 x 77	CHM6177BK244W 3657	CHM6177BK244P 4023	CHM6177BK244G 3427	"F" Option N/A

[View statement of line](#)

## Product features.

- Mitered case construction utilizing 5/8" material
- Fixed veneer insert panels are placed to the front "f" or back "b" of the case
- Product ships assembled
- Solid wood legs
- Fixed Inserts match bookcase finish. For contrasting panels order removable inserts
- Solid wood legs

### NOTES

- Unit designed for open plan use.
- 75" x 35" bookcase has 3 fixed back inserts and 10 total cubbies
- 75" x 50" bookcase has 4 fixed back inserts and 15 total cubbies
- 61" x 63" bookcase has 4 fixed back inserts and 16 total cubbies
- 61" x 77" bookcase has 5 fixed back inserts and 20 total cubbies

## Options.

### BOOKCASE PANEL INSERTS (REMOVABLE)

- RV11: Removable Veneer Insert - \$180 ea.
- Specify Veneer: PM01, PM02, PM03, PM04, PM05, PM06, PM07, PM08, PM10 WNO, WOW, WSO, WLA
- RL11: Removable Laminate Insert - \$125 ea.
- Specify laminate: GWL, LP01, LP02, LF01, LF02, LF03, LN01, LA01, LA02, LW01, LW02, LW04, LW05, LW06, LW07
- RF11: Removable Felt Insert - \$215 ea.
- Specify Felt: FL01, FL02, FL03, FL04, FL05, FL06, FL07, FL08, FL09, FL10, FL11, FL12

## 2 Select a finish

[View finish details](#)

Case Finishes	Leg Finishes	Case Finishes	Leg Finishes	Case Finishes	Leg Finishes
WWP PO01	WOW PO06	WOW	WOW PO06	GWL LW01	WOW PO06
PM01 PO02	WLA PO07	WNO	WLA PO07	LP01 LW02	WLA PO07
PM02 PO03	WNO PO08	WSO	WNO PO08	LP02 LW04	WNO PO08
PM03 PO04	WSO PO09	WLA	WSO PO09	LF01 LW05	WSO PO09
PM04 PO05	PO01		PO01	LF02 LW06	PO01
PM05 PO06	PO02		PO02	LF03 LW07	PO02
PM06 PO07	PO03		PO03	LN01	PO03
PM07 PO08	PO04		PO04	LA01	PO04
PM08 PO09	PO05		PO05	LA02	PO05
PM10					

## 3 Select a edge

[View edge details](#)

Edge	Edge	Edge
N/A	N/A	N/A

## 4

[View hardware details](#)

# Chameleon.

Open Plan Bookcase  
Fixed Type B Insert Placement

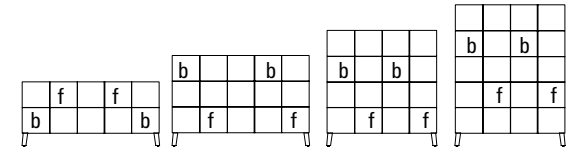

## 1 Select a model

w" x d" x h"

weight	Standard Veneer Chassis				Premium Veneer Chassis				High Pressure Laminate Chassis				Forbo Marmoleum Chassis			
	Solid Wood Legs				Solid Wood Legs				Solid Wood Legs				Solid Wood Legs			
75.5 x 15 x 35	CHM7635BK245W	2859	CHM7635BK245P	3145	CHM7635BK245G	2635	"F" Option N/A									
75.5 x 15 x 50	CHM7650BK245W	3205	CHM7650BK245P	3526	CHM7650BK245G	3004	"F" Option N/A									
61 x 15 x 63	CHM6163BK245W	3299	CHM6163BK245P	3629	CHM6163BK245G	3080	"F" Option N/A									
61 x 15 x 77	CHM6177BK245W	3605	CHM6177BK245P	3966	CHM6177BK245G	3375	"F" Option N/A									

[View statement of line](#)

## Product features.

- Mitered case construction utilizing 5/8" material
- Fixed insert panels are placed to the front "f" or back "b" of the case
- Product ships assembled
- Solid wood legs
- Fixed Inserts match bookcase finish. For contrasting panels order removable inserts

### NOTES

- Unit designed for open plan use.
- 75" x 35" bookcase has 4 fixed back inserts and 10 total cubbies
- 75" x 50" bookcase has 4 fixed back inserts and 15 total cubbies
- 61" x 63" bookcase has 4 fixed back inserts and 16 total cubbies
- 61" x 77" bookcase has 4 fixed back inserts and 20 total cubbies

## Options.

### BOOKCASE PANEL INSERTS (REMOVABLE)

- RV11: Removable Veneer Insert - \$180 ea.
- Specify Veneer: PM01, PM02, PM03, PM04, PM05, PM06, PM07, PM08, PM10 WNO, WOW, WSO, WLA
- RL11: Removable Laminate Insert - \$125 ea.
- Specify laminate: GWL, LP01, LP02, LF01, LF02, LF03, LN01, LA01, LA02, LW01, LW02, LW04, LW05, LW06, LW07
- RF11: Removable Felt Insert - \$215 ea.
- Specify Felt: FL01, FL02, FL03, FL04, FL05, FL06, FL07, FL08, FL09, FL10, FL11, FL12

## 2 Select a finish

[View finish details](#)

Case Finishes	Leg Finishes	Case Finishes	Leg Finishes	Case Finishes	Leg Finishes	Case Finishes	Leg Finishes		
WWP	PO01	WOW	PO06	WOW	PO06	GWL	LW01	WOW	PO06
PM01	PO02	WLA	PO07	WNO	PO07	LP01	LW02	WLA	PO07
PM02	PO03	WNO	PO08	WSO	PO08	LP02	LW04	WNO	PO08
PM03	PO04	WSO	PO09	WLA	PO09	LF01	LW05	WSO	PO09
PM04	PO05	PO01			PO01	LF02	LW06	PO01	
PM05	PO06	PO02			PO02	LF03	LW07	PO02	
PM06	PO07	PO03			PO03	LN01		PO03	
PM07	PO08	PO04			PO04	LA01		PO04	
PM08	PO09	PO05			PO05	LA02		PO05	
PM10									
Edge		Edge		Edge		Edge		Edge	
N/A		N/A		N/A		N/A		N/A	

## 3 Select a edge

[View edge details](#)

## 4

[View hardware details](#)

# Chameleon.

Interpersonal Screen  
Acoustic Interpersonal Screen

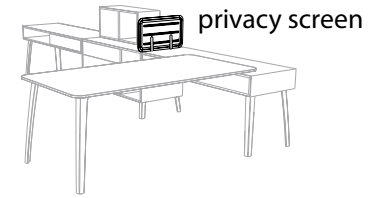

1 Select a model		Acoustic Interpersonal Screen					
w" x d" x h"	weight	White Mounting Bracket					
23" x 13.5		SAPS14	416				

2 Select a finish					
<i>View finish details</i>					
Metal finish MFW White (standard). Additional metal finishes are available, see options.					

3 Select a edge		Edge			
<i>View edge details</i>		N/A			

4 Select acoustic color		Hardware			
<i>View hardware details</i>		N/A			

[View statement of line](#)

## Product features.

- Acoustic panels are double sided with rounded corners
- Specify only one between two inline units
- Acoustic material panels are Heather Gray or Charcoal Gray standard ; specify color
- Mounting brackets are standard white metal finish. See Premium Metal Finishes for options

## Options.

### PREMIUM METAL FINISHES

- Specify Screen Brackets Metal Finish Color: \$50
- MFS: Silver, MFMB: Matte Black, MFGG: Graphite Gray, MFSS: Salmon Sienna, MFSA: Surfin Aquavert, MFPS: Pistachio, MFOS: Oyster, MFNA: Navy, MFOL: Olive, MFGB: Grey Beige

### PREMIUM ACOUSTIC MATERIAL

- Specify Premium Acoustic Material Color
- 21, 35, 29, 39, 31, 18, 2, 37, 16, or 34
- Contact customer service for premium acoustic screens. when specifying a quantity of ten or less screens acoustic screens an upcharge will apply - \$250

# Chameleon.

Privacy Screen  
Acoustic Modesty

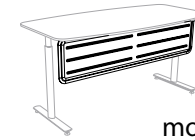

modesty

[View statement of line](#)

1 Select a model w" x d" x h"	weight	Acoustic Modesty White Mounting Bracket
38.5" x 13.5	HMAP3814	450
46.5 x 13.5	HMAP4614	468
54.25 x 13.5	HMAP5414	468

2 Select a finish  
[View finish details](#)

Metal finish  
MFW White (standard).  
Additional metal finishes are available, see options.

3 Select a edge  
[View edge details](#)

Edge  
N/A

4 Select acoustic color  
[View hardware details](#)

Hardware  
N/A

## Product features.

- Acoustic panels are double sided with rounded corners
- Half modesty is mounted under worksurface and gives 13.5" of privacy below worksurface
- Acoustic material panels are Heather Gray or Charcoal Gray standard ; specify color
- Mounting brackets are standard white metal finish. See Premium Metal Finishes for options
- Specify panel that fits work surface top size

## Options.

### PREMIUM METAL FINISHES

- Specify Screen Brackets Metal Finish Color: \$50
- MFS: Silver, MFMB: Matte Black, MFGG: Graphite Gray, MFSS: Salmon Sienna, MFSA: Surfin Aquavert, MFPS: Pistachio, MFOS: Oyster, MFNA: Navy, MFOL: Olive, MFGB: Grey Beige

### PREMIUM ACOUSTIC MATERIAL

- Specify Premium Acoustic Material Color
- 21, 35, 29, 39, 31, 18, 2, 37, 16, or 34
- Contact customer service for premium acoustic screens. when specifying a quantity of ten or less screens acoustic screens an upcharge will apply - \$250

# Chameleon.

Privacy Screen

Acoustic Worksurface Interpersonal Screen

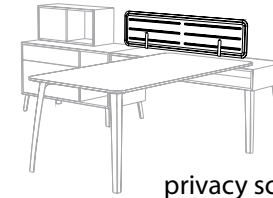

privacy screen

[View statement of line](#)

1 Select a model w" x d" x h"	weight	Acoustic Worksurface Interpersonal Screen			
38.5" x 13.5		FAPS3814	468		
46.51 x 13.5		FAPS4614	468		
54.25 x 13.5		FAPS5414	468		

2 Select a finish <a href="#">View finish details</a>	
Metal finish MFW White (standard). Additional metal finishes are available, see options.	

3 Select a edge <a href="#">View edge details</a>	Edge
	N/A

4 Select acoustic color <a href="#">View hardware details</a>	Hardware
	N/A

## Product features.

- Acoustic panels are double sided with rounded corners
- Front Acoustic Screens are mounted on top of worksurface and gives 13.5" of privacy above worksurface
- Acoustic material panels are Heather Gray or Charcoal Gray standard ; specify color
- Mounting brackets are standard white metal finish. See Premium Metal Finishes for options
- Specify panel that fits work surface top size

## Options.

### PREMIUM METAL FINISHES

- Specify Screen Brackets Metal Finish Color: \$50
- MFS: Silver, MFMB: Matte Black, MFGG: Graphite Gray, MFSS: Salmon Sienna, MFSA: Surfin Aquavert, MFPS: Pistachio, MFOS: Oyster, MFNA: Navy, MFOL: Olive, MFGB: Grey Beige

### PREMIUM ACOUSTIC MATERIAL

- Specify Premium Acoustic Material Color
- 21, 35, 29, 39, 31, 18, 2, 37, 16, or 34
- Contact customer service for premium acoustic screens. when specifying a quantity of ten or less screens acoustic screens an upcharge will apply - \$250



Chameleon options.



COMPUTER SUPPORT  
*single monitor arm*

Style Number	List Price
MA1	280

Specifications

- Available in black or silver
- Desk clamp and grommet mounting included
- Easy assembly and flexibility
- Elastic painting process for a durable and beautiful finish
- Gas spring tension adjustment for counter-balance height adjustment for monitors 1-8 KG
- Gas spring tested to 50,000 repetitions
- Hidden cable management



COMPUTER SUPPORT  
*double monitor arm*

Style Number	List Price
MA2	450

Specifications

- Available in black or silver
- Desk clamp and grommet mounting included
- Easy assembly and flexibility
- Elastic painting process for a durable and beautiful finish
- Gas spring tension adjustment for counter-balance height adjustment for monitors 1-8 KG
- Gas spring tested to 50,000 repetitions
- Hidden cable management



COMPUTER SUPPORT  
*triple monitor arm*

Style Number	List Price
MA3	530

Specifications

- Available in black or silver
- Desk clamp and grommet mounting included
- Easy assembly and flexibility
- Elastic painting process for a durable and beautiful finish
- Gas spring tension adjustment for counter-balance height adjustment for monitors 1-8 KG
- Gas spring tested to 50,000 repetitions
- Hidden cable management



COMPUTER SUPPORT  
*quadruple monitor arm*

Style Number	List Price
MA4	705

Specifications

- Available in black
- Desk clamp and grommet mounting included
- Easy assembly and flexibility
- Elastic painting process for a durable and beautiful finish
- Gas spring tension adjustment for counter-balance height adjustment for monitors 1-8 KG
- Gas spring tested to 50,000 repetitions
- Hidden cable management

## Chameleon options.

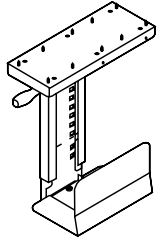

COMPUTER SUPPORT  
*cpu retractable cradle*

Style Number	List Price
K18	205

### Specifications

- Black Metal CPU Carriage
- Full 360° swivel capability allows easy access to rear of CPU for cables / wires
- Track allows 8- 1/2" extension
- Width Adjustment 5-1/2" to 9-1/4"
- Height adjustment 14- 5/8" to 20- 1/2"
- Black epoxy finish

Notes  
- Factory Installed

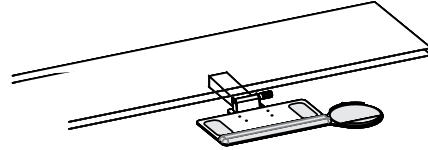

COMPUTER SUPPORT  
*articulating keyboard tray*

Style Number	List Price
Factory Installed K28	390
Field Installed K28F	415

### Specifications

- Adjusts effortlessly - A simple one-handed motion allows the keyboard to be repositioned instantly, without the use of locks or levers
- Encourages low-risk postures - Maximizes adjustability within a safe operating range.
- Will last a lifetime - Exceeds all applicable BIFMA Standards and comes with a lifetime guarantee.

Notes  
- Available on: Freestanding Desk  
- Factory Installed (standard)  
- FIELD INSTALL - \$395



DOOR MODIFICATIONS  
*soft close door hinge*

Style Number	List Price
D9SC	35 Per door

### Specifications

- Snap onto standard door hinge
- Requires (2) per door
- Max door height 43"
- Factory installed where specified
- Individually shipped for field installation

Notes  
- Specify Each Item To Have Slow Close Feature

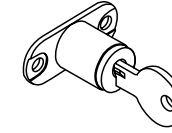

DOOR MODIFICATIONS  
*panel door lock*

Style Number	List Price
D2-CHM	100 Per

### Specifications

- Door Locks - 1 Door w/ Lock or Pedestal
- Contact Customer Service regarding limited lock locations and keying.

Notes  
- Available on: Panel Doors and Drawers

## Chameleon options.

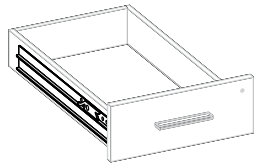

**DRAWER OPTIONS**  
*soft close suspension*

Style Number	List Price
SCS1	25 Per drawer

### Specifications

- Factory installed where specified

**Notes**

- Not recommended for field installation

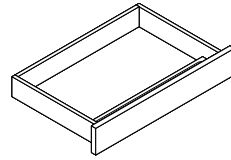

**DRAWER OPTIONS**  
*finished center drawer*

Style Number	List Price
K31	205
Add Skirt Option K31-SK	310

### Specifications

- Veneer drawer front finished to match unit W or G style veneer.
- Ball bearing smooth operation
- Drawer has lifetime guarantee
- Standard with matching wood grain pencil tray
- Laminate drawer front to match laminate unit (M style)

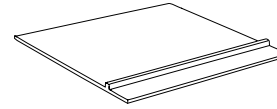

**DRAWER OPTIONS - BOTTOM COVER**  
*felt bottom center drawer insert liner*

Style Number	List Price
K3	100

### Specifications

- Inserts into center drawer and features divider for open pen and pencil storage. Removable for easy cleaning.
- Adds a luxurious touch to center drawers.
- Color: Dark Brown Coal



**GLASSBOARD ACCESSORIES**  
*glassboard accessory kit*

Style Number	List Price
GBKIT	275

### Specifications

- 8 Earth magnets, 1 magnetic marker cup holder and 1 magnetic dry eraser

## Chameleon options.

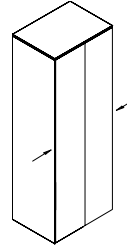
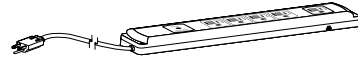

### RECESSED LIGHTING

*lt-led task light*

Style Number	List Price
24" Task light LT-LED24R	180
48" Task light LT-LED48R	235
60" Task light LT-LED60R	295
72" Task light LT-LED72R	320

### Specifications

- 6.5' Power cord. Switch with touch dimmer
- 36 LEDs per foot
- 4.6 Watts per foot
- 91 Lumens per watt
- Please note when ganging.
- Overhead tasklight cord is located on the right facing side. If the opposite location is required please contact customer service.

### POWER / DATA

*power supply cordset*

Style Number	List Price
PD717	100

### Specifications

- SIZE: 10.75" L x 2.0" W x 1.06" H
- (5) Outlets w/ 10' cord
- Surge suppression (720 Joules)
- 15 Amp breaker
- Available on: Vertical Panels, Cabinet Interiors, and under tops

### PRODUCT MODIFICATIONS

*modify width - open/closed storage*

Style Number	List Price
MOD-2	250

### Specifications

- Modify width down on any unit with open or closed storage section: overheads, wall hung units, storage credenzas, towers

### PRODUCT MODIFICATIONS

*modify width - outside of mod-1, mod-2*

Style Number	List Price
MOD-3	Contact for pricing

### Specifications

- Width modification outside of MOD-1 & MOD-2

## Chameleon options.

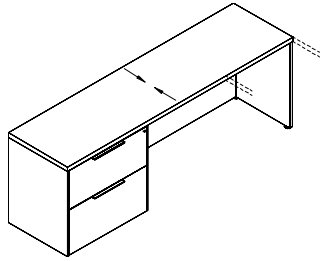

PRODUCT MODIFICATIONS  
*modify depth - decrease depth*

Style Number	List Price
MOD-5	125

### Specifications

- Modify depth down (minimum depth for a unit with drawers is 21" D)

Notes  
 - Ex. 24" to 21", 30" to 24", and 36" to 30"

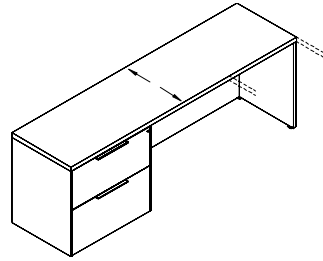

PRODUCT MODIFICATIONS  
*modify depth - increase depth*

Style Number	List Price
MOD-6	Add 10%

### Specifications

- Increase depth by no more than 6"

Notes  
 - Ex. 24" to 30", 30" to 36", and 36" to 42"  
 - Add 10% to the unit you want to increase the depth of by no more than 6"

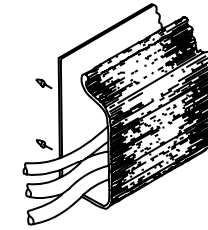

PRODUCT MODIFICATIONS  
*modify height*

Style Number	List Price
MOD-7	Contact for pricing

### Specifications

- Modify height of a unit

WIRE MANAGEMENT  
*horizontal j-channel wire management raceway*

Style Number	List Price
W1	80 Per 4' section

### Specifications

- 4' section for field installation.  
 - The "J" shape black thermoplastic wire raceway may be added to specified worksurface tops to provide concealed channeling of wires to and from worksurface grommets. For use in open kneespace areas, raceway is attachable to top of back panel with pan head screws. Interior dimensions are 1" x 1- 1/2" providing ample storage for multiple wires and excess cable. Front of raceway flexes out for easy cord insertion.

Notes  
 - Units w/ Wire Channel Standard.  
 - Field Installation

Chameleon options.

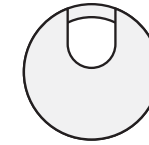
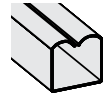
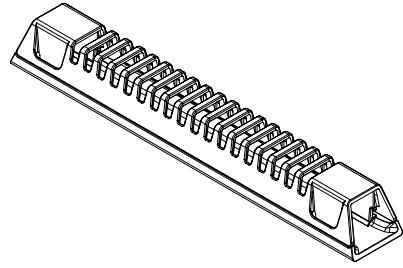

WIRE MANAGEMENT  
*horizontal wire management raceway*

Style Number	List Price
W21	35

Specifications

- 10"W x 1.5"D x 1.25"H
- Grey Wire Manager (10.5")
- Power and data cables can be discretely housed and managed with the W21 Gray Wire Manager. This can be mounted in any location to metal frame or underside of conference tables and runs cables through a 1" channel from power module to hollow steel legs. This keeps cables organized under the table top. Release clips make it simple to snap on and off the Wire Manager for easy organization and access after attached to the table

Notes  
- Field installed

WIRE MANAGEMENT  
*horizontal u-channel wire management raceway*

Style Number	List Price
W2A	80 Per 4' section

Specifications

- 4' section for field installation.
- Notes
- Units w/ Wire Channel Standard.
  - Field Installation

WIRE MANAGEMENT  
*coil wire manager*

Style Number	List Price
W18	160

Specifications

- Weighted Base, Table attachment plate
- 39- 1/2" Length
- Black

Notes  
- Location

WIRE MANAGEMENT  
*standard location grommets - factory installed*

Style Number	List Price
Standard Location Grommet	
Black	
TM30	50
Silver	
TM31	50
Antique Brass	
TM33	50
White	
TM34	50

Specifications

- 1 -5/8" Metal Grommet

Notes  
- \*Units w/ Grommets Standard Are Noted Under Standard Features. Grommets Match Pull Finish - Standard (Unless Specified Otherwise)

Chameleon options.

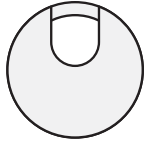

WIRE MANAGEMENT

*non-standard location grommets - factory installed*

Style Number	List Price
Non-Standard Location Grommet	
Black	
TM30 -NS	95
Silver	
TM31 -NS	95
Antique Brass	
TM33 -NS	95
White	
TM34 -NS	95

Specifications

- 1 -5/8" Metal Grommet

Notes

- \*Units w/ Grommets Standard Are Noted Under Standard Features. Grommets Match Pull Finish - Standard (Unless Specified Otherwise)

WIRE MANAGEMENT

*black plastic vertical surface grommets - factory installed*

Style Number	List Price
Standard Location Grommet	
TM50-C	50
Non-Standard Location Grommet	
TM50-NS	95

Specifications

- 2 " Black Plastic Grommet

Notes

- Standard Location is Bottom Center

## power & data options.

Aircharge wireless charging grommet

Style Number	List Price
 ACWG WIRELESS GROMMET	\$195

## Specifications

- › When used with GROVE Tables an additional \$350 LIST will apply for the special cutout required.
- › AirCharge offers a convenient way to charge any Qi compatible smartphone or device without the need to carry charging cables or find an available power outlet.
- › The Aircharge is powered by the latest Qi compliant IC offering reliable and efficient wireless charging in a convenient 3" grommet hub. Simply place your phone on the Aircharge and an LED will confirm pairing and begin wireless charging.
- › Recess: Efficient space conservation and quick access
- › Input: DC 5V (with included AC power adapter), DC 9V, 1.67A (with optional QC 2.0 power adapter)
- › Output: 5 watts Max. with DC 5V, 2A power adapter, 10 watts Max. with QC 2.0 power adapter
- › Qi V1.2 compliant IC
- › Charging distance: 6mm Max.



Available: All DARRAN collections





## power & data options.

Cove power unit with daisylink

Style Number	List Price
<b>STARTER UNITS</b>	
 COV-DCH HARDWIRED	\$710
Includes (1) Cove unit with Hardwire Infeed - 120"	
 COV-DCP PLUG	\$800
Includes (1) Cove unit with Plug infeed - Includes 72" Cord and 32" Infeed Jumper for 104" total cord infeed	
<b>ADDITIONAL LINKING UNITS</b>	
COV-DCL	\$575 EACH
Includes Linking Cove unit and Jumper up to 96", cable length determined by the top size	

## Specifications

- › Size: 5.75"L x 2.5"W
- › (2) 15 Amp Receptacles and (2) 2.1 Amp USB charging ports
- › Surface Mount
- › Max Daisy Chain - Hardwire - (9) units; Plug/Corded - (4) units
- › Standard Silver Finish, Available in White or Black Finish upon request
- › ETL Listed

Available: All DARRAN collections



## power & data options.

Cove power unit with daisylink

Style Number	List Price
--------------	------------

### STARTER UNITS



COV-DCH HARDWIRED	\$710
-------------------	-------

Includes (1) Cove unit with Hardwire Infeed - 120"



COV-DCP PLUG	\$800
--------------	-------

Includes (1) Cove unit with Plug infeed - Includes 72" Cord and 32" Infeed Jumper for 104" total cord infeed

### ADDITIONAL LINKING UNITS

COV-DCL	\$575 EACH
---------	------------

Includes Linking Cove unit and Jumper up to 96", cable length determined by the top size



## Specifications

- › Size: 5.75"L x 2.5"W
- › (2) 15 Amp Receptacles and (2) 2.1 Amp USB charging ports
- › Surface Mount
- › Max Daisy Chain - Hardwire - (9) units; Plug/Corded - (4) units
- › Standard Silver Finish, Available in White or Black Finish upon request
- › ETL Listed

Available: All DARRAN collections

## power & data options.

VILLA Power unit with daisylink

Style Number	List Price
STARTER UNITS	
VIL-DCH HARDWIRED	\$975
Includes (1) Villa unit with 120" Hardwire Infeed	
VIL-D-CP PLUG	\$975
Includes (1) Villa with Plug Infeed - Includes 72" Cord and 32" Infeed Jumper for 104" total cord infeed	
ADDITIONAL LINKING UNITS	
VIL-DCL ADDITIONAL	\$950
(Includes linking Villa and Jumper cable up to 96")	

## Specifications

- > Size: Top Grommet 5.68"L X 3.39"W; Under Top 12"L x 3.13"W x 3.08"D
- > (4) Power receptacles; (2) surface and (2) undersurface, (2) 2.1A USB charging ports and (1) Knockout for RJ45 Data Port
- > Surface Mount
- > Daisy Chain - Hardwire Max (10) Units, Plug/Corded Max (5) Units
- > Standard Silver Finish, Black Finish available upon request
- > UL or ETL Certified

Available: All DARRAN collections, excludes grove

RJ45 Knockout	
RJ45 (1)	\$35



# EdgeWorks price list



effective july 1, 2021

designed by thinkingworks design studio



## EdgeWorks table of contents

Statement of Line	
Features & Advantages .....	1
Finishes   Specifications .....	3
Metal Finishes   Specifications .....	4
Wire Management.....	6
Interconnecting Rails.....	7
Measurements.....	8
Edges   Pulls.....	9
Grommets .....	10
Grain Direction .....	11
Drawer Dimensions.....	12
Inline Workstations .....	15
Facing Workstations.....	18
Workstation Tops .....	23
Freestanding Desk.....	25
Workstation Returns .....	26
Training Tables.....	29
Workstation Credenzas.....	34
Mobile Pedestals .....	35
Screens .....	37
Wall Hung Units.....	43
Tackboards, Veneer Panels, Marker Boards, Glassboards.....	46
Accessories .....	48
Round Conference Tables.....	52
Square Conference Tables .....	54
Conference Tables.....	56
Conferencing Credenzas.....	76
Options.....	77
Power & Data .....	84

# EdgeWorks statement of line

29" unit with basket shown



PAGE 15  
Workstations



PAGE 16  
Workstations



PAGE 17  
Workstations

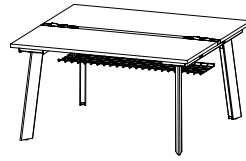

PAGE 18  
Workstations



PAGE 19  
Workstations



PAGE 20  
Workstations



PAGE 21  
Workstations



PAGE 22  
Workstations

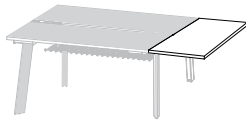

PAGE 23  
Workstation Tops

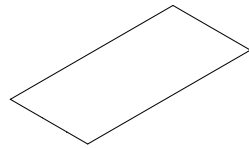

PAGE 24  
Workstation Tops

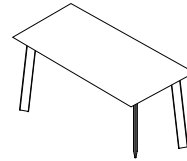

PAGE 25  
Freestanding Desk

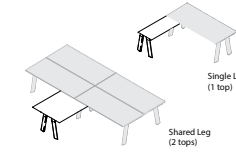

PAGE 26  
Return

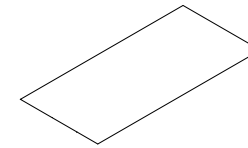

PAGE 27  
Return

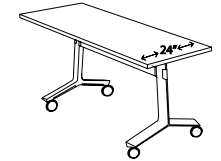

PAGE 28  
Training table



PAGE 29  
Training table

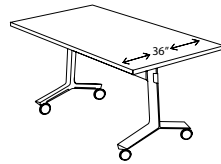

PAGE 30  
Training table

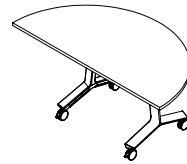

PAGE 31  
Training table

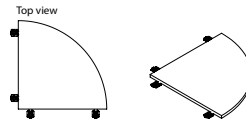

PAGE 32  
Training Table Top



PAGE 33  
Privacy Screen

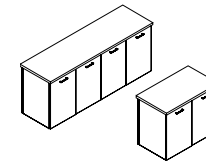

PAGE 34  
Full Pedestal Credenzas



PAGE 35  
Pedestals

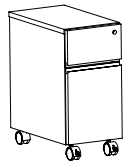

PAGE 36  
Pedestals

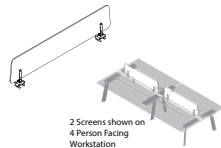

PAGE 37  
Privacy Screen

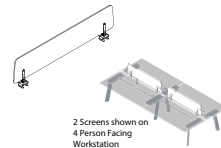

PAGE 38  
Privacy Screen

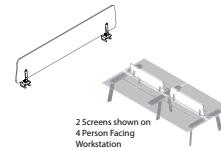

PAGE 39  
Privacy Screen

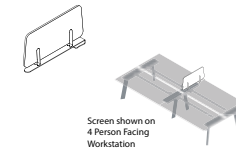

PAGE 40  
Interpersonal Screen

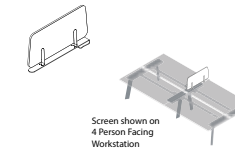

PAGE 41  
Interpersonal Screen

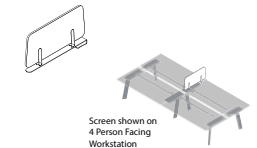

PAGE 42  
Interpersonal Screen

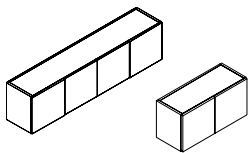

PAGE 43  
Single Height Wall Hung Overheads

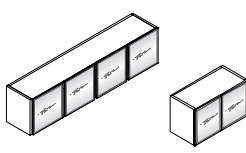

PAGE 44  
Single Height Wall Hung Overheads

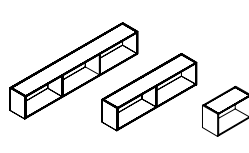

PAGE 45  
Single Height Wall Hung Overheads

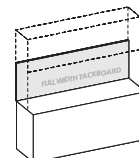

PAGE 46  
Wall Hung Tackboards

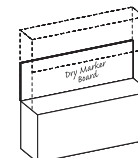

PAGE 47  
Wall Hung Marker Boards

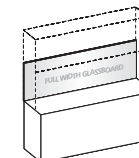

PAGE 48  
Wall Hung Veneer Panel

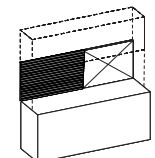

PAGE 49  
Wall Hung Glassboards

# EdgeWorks statement of line

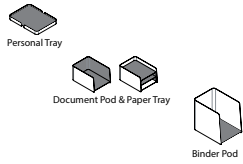

PAGE 50  
Metal Accessories

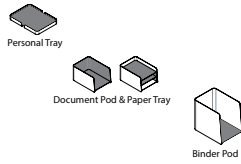

PAGE 51  
Metal Accessories

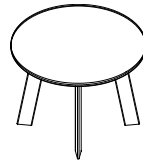

PAGE 52  
Conference Tables



PAGE 53  
Glass Conference Tables

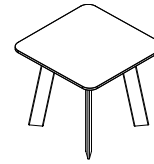

PAGE 54  
Conference Tables

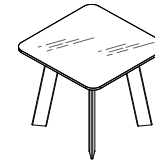

PAGE 55  
Glass Conference Tables

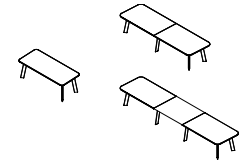

PAGE 56  
Conference Tables

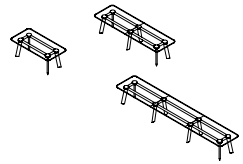

PAGE 57  
Glass Conference Tables

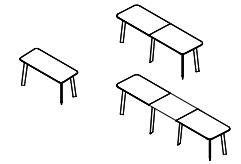

PAGE 58  
Conference Tables

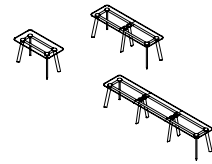

PAGE 59  
Glass Conference Tables

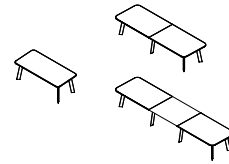

PAGE 60  
Conference Tables

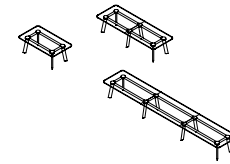

PAGE 61  
Glass Conference Tables

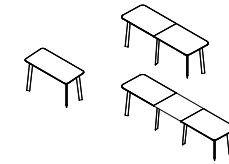

PAGE 62  
Conference Tables

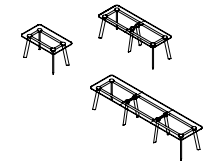

PAGE 63  
Glass Conference Tables

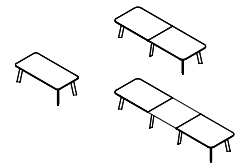

PAGE 64  
Conference Tables

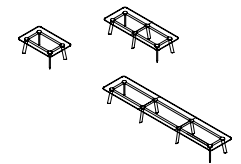

PAGE 65  
Glass Conference Tables

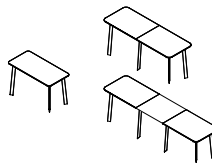

PAGE 66  
Conference Tables

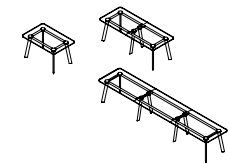

PAGE 67  
Glass Conference Tables

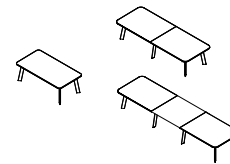

PAGE 68  
Conference Tables

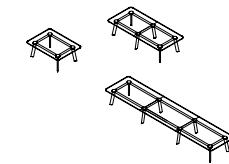

PAGE 69  
Glass Conference Tables

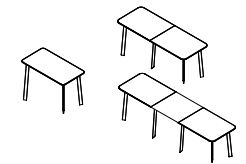

PAGE 70  
Conference Tables

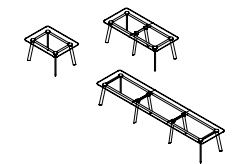

PAGE 71  
Glass Conference Tables

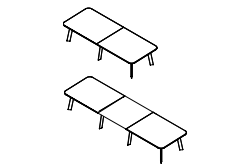

PAGE 72  
Conference Tables

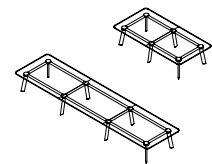

PAGE 73  
Glass Conference Tables

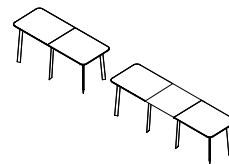

PAGE 74  
Conference Tables

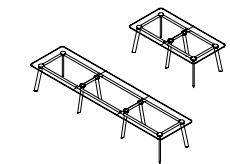

PAGE 75  
Glass Conference Tables

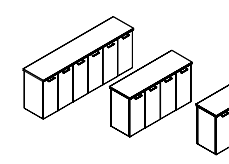

PAGE 76  
Full Pedestal Credenzas

## EdgeWorks features & advantages

### Veneer

DARRAN only uses HPVA AA Grade Flat Cut Cherry, Maple, and Walnut Veneers and AA Grade Quartered Oak and Ash Veneers. EdgeWorks is also available in double cut reconstituted walnut and oak patterns made from rapidly renewable wood veneer providing a repeatable consistent straight grain pattern. All veneers are selected and matched for balance and consistency.

### Veneer Tops

EdgeWorks veneer tops feature a 45-pound density substrate with balanced 3-ply construction. Tops are 1" thick on MDF core comprised of 100% recycled and recovered wood fibers. All veneer tops are slipmatched and feature a 3mm external solid hardwood band or profile edge.

### Laminate Tops

EdgeWorks high-pressure laminate tops feature a 45-pound density substrate with balanced 3-ply construction. Tops are 1" thick on MDF core comprised of 100% recycled and recovered wood fibers. All high pressure laminate tops are available with a profile edge, laminate self-edge or 2mm PVC edge band. Laminates in wood grain patterns feature a fine grain texture that features the polish and luxe of a real wood veneer with a subtle narrow grain structure.

### TFL top

Thermally Fused Laminate tops feature a 45-pound density substrate with balanced 3-ply construction. Tops are 1" thick on MDF core that is comprised of 100% recycled and recovered wood fibers. All Thermally Fused Laminate tops are available with a 2mm flat PVC band. Laminates in wood grain patterns feature Timberline Texture providing the grain pattern of wood.

### Cleaning wood & laminate

In addition to regular dusting, give your furniture an occasional cleaning in accordance with our cleaning instructions. DARRAN wood and laminate products can be cleaned with a soft cloth and a mild soap and water mixture. Use approximately 32 oz of water mixed with one tablespoon of dish soap, always wiping with the grain. Dry with a soft cloth, going with the grain, to avoid spotting or streaking.

Wood products should be waxed periodically using a non-wax liquid; please do not use any waxy polish or cleaner. Interior of drawers may also be cleaned with mild soap and water mixture, or any household cleaner that is not petroleum or thinner-based.

### Chassis & pedestal

Chassis components are  $\frac{3}{4}$ " thick core of particle board or MDF rated EPP/SCS/CARB-II material with 3-ply balanced construction. Pedestal and Cabinets feature dowel

construction reinforced with steel bracket plates, wood cleats, screws and glue. All units are standard with 1" adjustable glides that allow for leveling of units that are secured in solid wood glide blocks to prevent tearout.

### Cabinet construction

Wall mount cabinets are mounted to the wall with steel "z" bracket attachment method using 5mm euro screws to attach to the back of the cabinet. All units ship with a steel "z" bracket. This bracket is mounted to the wall by field installers. Installers are responsible for selecting and supplying appropriate fasteners for wall conditions.

### Tackboards

Wall mount tackboards are constructed of .75" thick fiberboard. The fabric is precisely aligned and fitted to the tackboard with a sock on cover.

#### Adjustable Glides

Glides provide 3" of vertical leveling adjustment. Glide bottom is durable plastic.

### Adjustable glides

Glides provide 1" of vertical leveling adjustment. Glide bottom is durable metal. Glides are secured in solid wood blocks that are screwed and glued for durability.

### Drawers

All drawers are constructed with mitre joint/dowel construction in a natural maple finish with four sides and a bottom, which are attached to a drawer front with screws for easy removal. Drawer fronts are vertically matched in balanced sets. Pencil trays are standard in all box drawers. Drawers are constructed of 1/2" thick wood grained wrapped 5 sided miter-folded construction with 1/4" thick hardboard bottoms reinforced for heavy weight capacity. Drawers have been tested and pass BIFMA 50,000 cycle test. All drawers are guaranteed lifetime with free replacement warranty.

### Drawer fronts

Drawer fronts are vertically matched in balanced sets.

### Optional wood drawers

Optional hardwood veneer plywood drawers feature banded top and bottom edges for smoothness. Drawers are dowel joint construction with a UV cured finish over maple veneers, plus a lifetime free replacement guarantee.

Optional Wood Drawer (Any Size) – Option Code P33...\$45 List Price Per Drawer.



## EdgeWorks features & advantages

### Suspensions

All casegoods utilize cold rolled steel zinc plated high-grade drawer suspensions. All suspensions are warranted for the lifetime of the product. Box and File drawers are full extension, featuring steel ball bearings for a smoother quieter range of motion and are rated 100lbs. Lateral file drawers are a progressive action full extension suspension and is rated at 150lbs. Veneer and High Pressure laminate casegoods feature soft close suspension. Thermally Fused Laminate casegoods feature standard suspensions. Lateral files include anti tip mechanism that allow only one drawer to be opened at a time.

### Filing

EdgeWorks features a highly durable black plastic extrusion that is securely fastened into a route on top of the drawer to support hanging files. An adjustable crossbar is provided for all file drawers that enables legal/letter filing front to back or side-to-side based on the drawer size.

### Locks (all collections except Chameleon)

Locks are Standard on all drawers below the worksurface. Random lock cores are installed at the factory. Some units may be shipped with the same key number. Locks are Silver, Black or Bronze and match pull finish unless otherwise specified.

DARRAN will also send lock cores separately to the dealer at your request. These units will be send with an empty lock core and the Dealer will receive a shipment of the requested lock core/keys.

### Keying

Keying is available either factory or field installed. Factory installed keying is random.

### Power

A large selection of power pods are available and handle power, data, docking stations and communication. See options section for selection.

### Wire management

Wire management capabilities include standard and optional worksurface grommets. Specify W21 under surface wire channels for organization and management of all communication wires and cords. Sold separately to conceal wire under worksurfaces.

### Grommets

Metal grommets are provided to match the drawer pull selection. Grommet is available in black, silver or white. Must specify standard or non-standard location. Black plastic grommets are available as an option for vertical applications.

### LED tasklights

LED task lighting provides high efficiency, low energy lighting with a long life. Recessed light is encased in silver aluminum channel with milk lense and rounded end caps. Lights are factory installed. Product specifications listed below:

- Diffuser creates a softer light and eliminates hot spots
- Touch dimmer switch
- Can be "daisy chained" up to 90W
- 4.6 watts per foot
- 120 LEDs per meter
- Certification: UL Listed
- 50,000 hour life span.

Color Temp is 4000K

## EdgeWorks finishes | specifications

STANDARD VENEER	PREMIUM VENEER	HIGH PRESSURE LAMINATE	THERMALLY FUSED LAMINATE
*WLA Lofty Ash.....	N/A.....	N/A.....	N/A
WAC Amber Cherry.....	N/A.....	GAC Amber Cherry.....	MAC Amber Cherry
WEC Ebony.....	N/A.....	GEC Ebony.....	MEC Ebony
WOC KoKo Cherry.....	N/A.....	GOC KoKo Cherry.....	MOC KoKo Cherry
WAM Alabaster Maple.....	N/A.....	GAM Alabaster Maple.....	N/A
WCM Clear Maple.....	N/A.....	GCM Clear Maple.....	N/A
WWM Wheat Maple.....	N/A.....	GWM Wheat Maple.....	N/A
N/A.....	WBO Blush Oak.....	N/A.....	N/A
N/A.....	WMO Mocha Oak.....	N/A.....	N/A
N/A.....	*WSO Salted Oak.....	N/A.....	N/A
WGW Gunstock Walnut.....	N/A.....	N/A.....	MGW Gunstock Walnut
WBW Henna Walnut.....	N/A.....	N/A.....	N/A
WSW Smokey Walnut.....	N/A.....	N/A.....	N/A
WNW Natural Walnut.....	N/A.....	GNW Natural Walnut.....	N/A
N/A.....	TBCO Baby's Cheek.....	N/A.....	N/A
N/A.....	TBSW Brown Sugar.....	N/A.....	N/A
N/A.....	TSTV Studio Teak Walnut.....	GSTV Studio Teak Walnut.....	MTW Studio Teak Walnut
N/A.....	TSMV Seattle Mist.....	N/A.....	N/A
N/A.....	TSLV Skyline Walnut.....	GSLV Skyline Walnut.....	MSW Skyline Walnut
N/A.....	TOBW Organic Brown.....	N/A.....	N/A
WWP Designer White Paint.....	N/A.....	GWL Designer White.....	MWL Designer White

HPL TOPS ON TFL PRODUCTS Add 10% - Available with flat edge only

\*WSO Salted Oak and WLA Lofty Ash Features matte 5% sheen. All other finishes are 40% sheen

For custom Fenix laminate pricing call our Customer Service at 1-800-334-7891

Send 3x3 or larger finish chip for color match. Custom finish upcharge is 3% or \$250 Net (whichever is greater).

### Finish

ENVI-CT Green Certified European Technology Coatings

Finish.

# EdgeWorks metal finishes | specifications

Metal is standard in MFMB Black. Premium Metal Finish: Priced per unit on product page.



MFMB  
Matte Black  
(Standard)



MFS  
Silver  
(Premium)



MFGG  
Graphite  
Gray  
(Premium)



MFW  
White  
(Premium)



MFSS  
Salmon  
Sienna  
(Premium)



MFSA  
Surfin  
Aquavert  
(Premium)

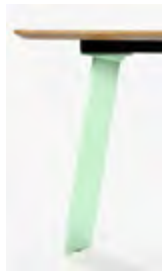

MFPS  
Pistachio  
(Premium)



MFOS  
Oyster  
(Premium)



MFNA  
Navy  
(Premium)



MFOL  
Olive  
(Premium)

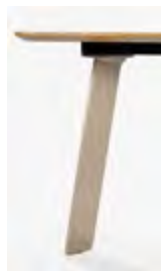

MFGB  
Grey  
Beige  
(Premium)

## EdgeWorks acoustic material | specifications

Central and Interpersonal Privacy Screens available in SCG Charcoal Gray and SHG Heather Gray acoustic material.



SCG  
Charcoal Gray



SHG  
Heather Gray



Acoustic material is mounted between die cast spacer blocks creating personal space.

# EdgeWorks metal finishes | specifications

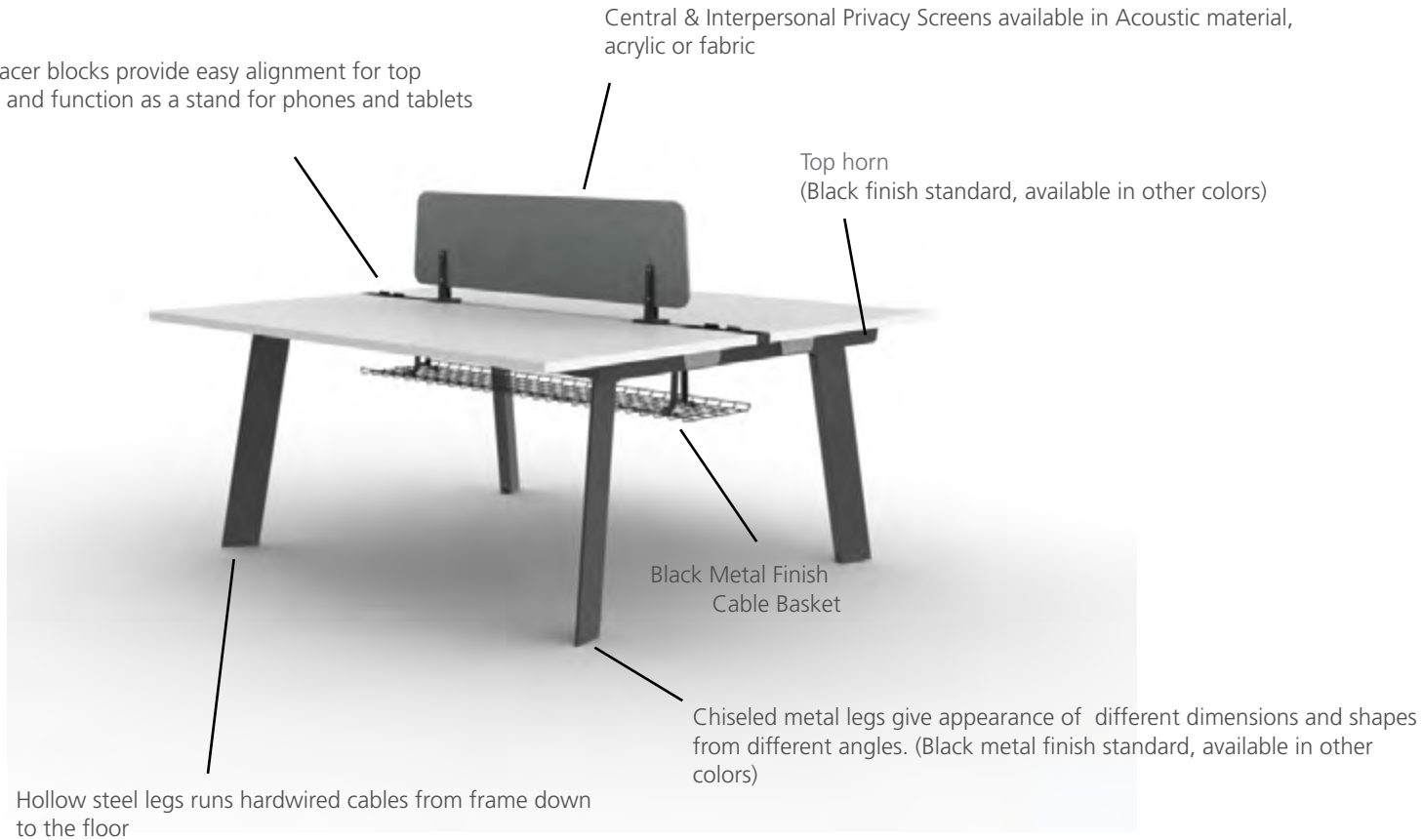

## EdgeWorks training table | power guide

Tables can be ganged together for larger workspaces and connected with infeed jumper cables. Power pods are available in black, white and silver.



### 1 Power Pod:

- PD-Cove-PKO-TT: Cover Power Unit with 2 power, 2 USB and 1 telecom plate - \$435

### Choose Your Infeed:

- PFC72: 72" 3 prong plug power infeed - \$225
- PFHRD120: 120" hardwire whip power infeed - \$210

### Choose Jumper Length:

- JCTT84: Jumper for 84" workspaces - \$145
- JCTT72: Jumper for 72" workspaces - \$135
- JCTT66: Jumper for 66" workspaces - \$130
- JCTT60: Jumper for 60" workspaces - \$125
- JCTT54: Jumper for 54" workspaces - \$120
- JCTT48: Jumper for 48" workspaces - \$115
- JCTT42: Jumper for 42" workspaces - \$110

### Choose 1 Telecom Plate:

- RJ45 (1) - \$35
- RJ45 (2) - \$70
- RJ45 (3) - \$105
- USB (1) - \$70
- USB (2) - \$140
- RJ45/USB - \$105
- RJ45/HDMI - \$190
- HDMI/USB - \$205

## Bottom View

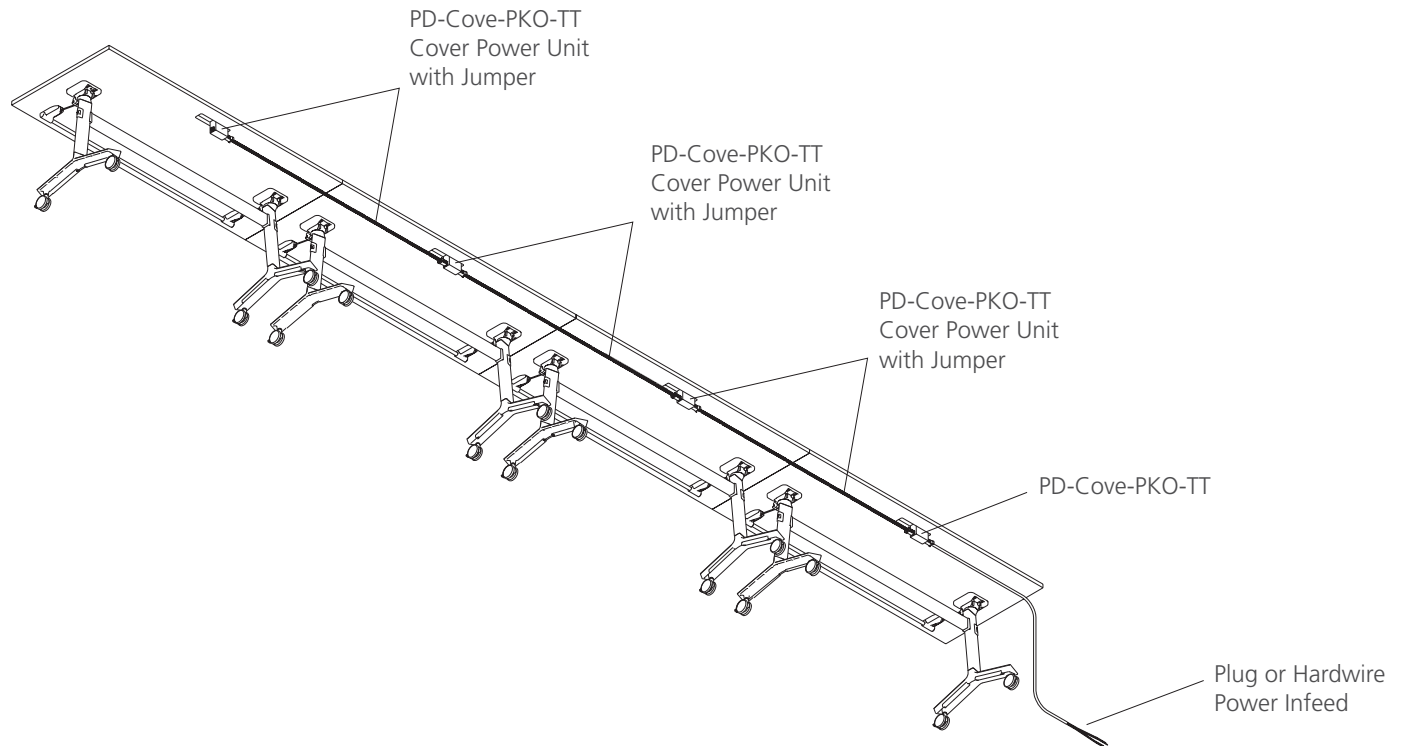

## EdgeWorks wire management

### Conference wire management

Power and data cables can be discretely housed and managed with the W21 Grey Wire Manager. This can be mounted in any location to metal frame or underside of conference tables and runs cables through a 1" channel from power module to hollow steel legs. This keeps cables organized under the table top. Release clips make it simple to snap on and off the Wire Manager for easy organization and access after attached to the table

W21: Grey Wire Manager (10.5") - \$35



W21 Grey Wire Manager  
10"W x 1.5"D x 1.25"H

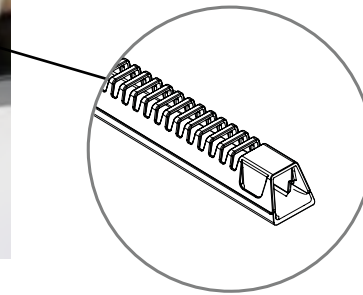

### Workstation wire management

Wire baskets secure the underside of tops with cWips enabling the easy removal and adjustment of wires. Baskets come standard on all Workstations.

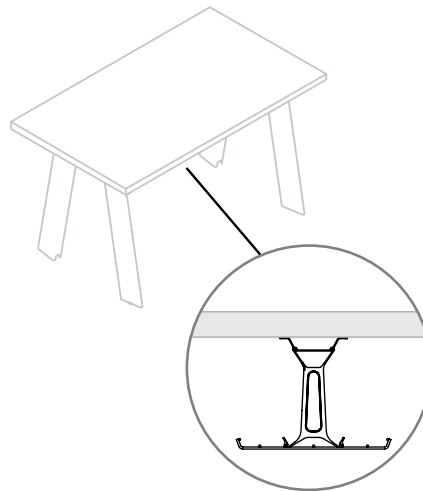
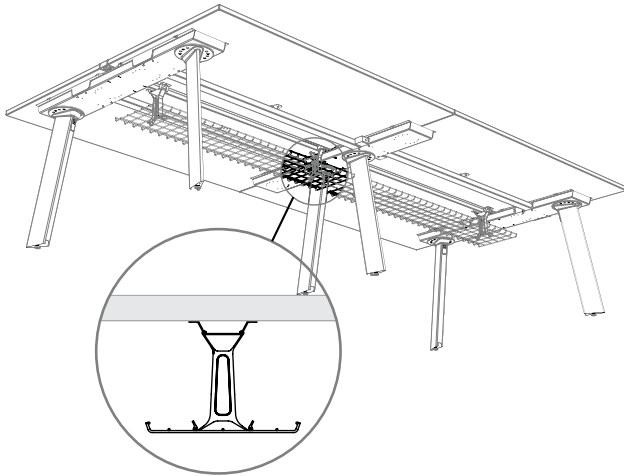

Cable baskets attach to underside of worksurface.

Double Sided Baskets for facing and inline workstations.

### Neat thinking

With ample capacity within the hollow steel leg for hardwired cables or data that can be discretely housed and managed.



## EdgeWorks interconnecting rails

The EdgeWorks workstation top horn is designed to accommodate rails that interconnect to allow for the easy addition or removal of a section of the workstation. This is a good selling point for clients who are looking to expand in the future, and considers the environment by conserving materials.

## Touchdown extension top

Touchdown extension top enhances communication and collaboration, making workstations a functional meeting space.

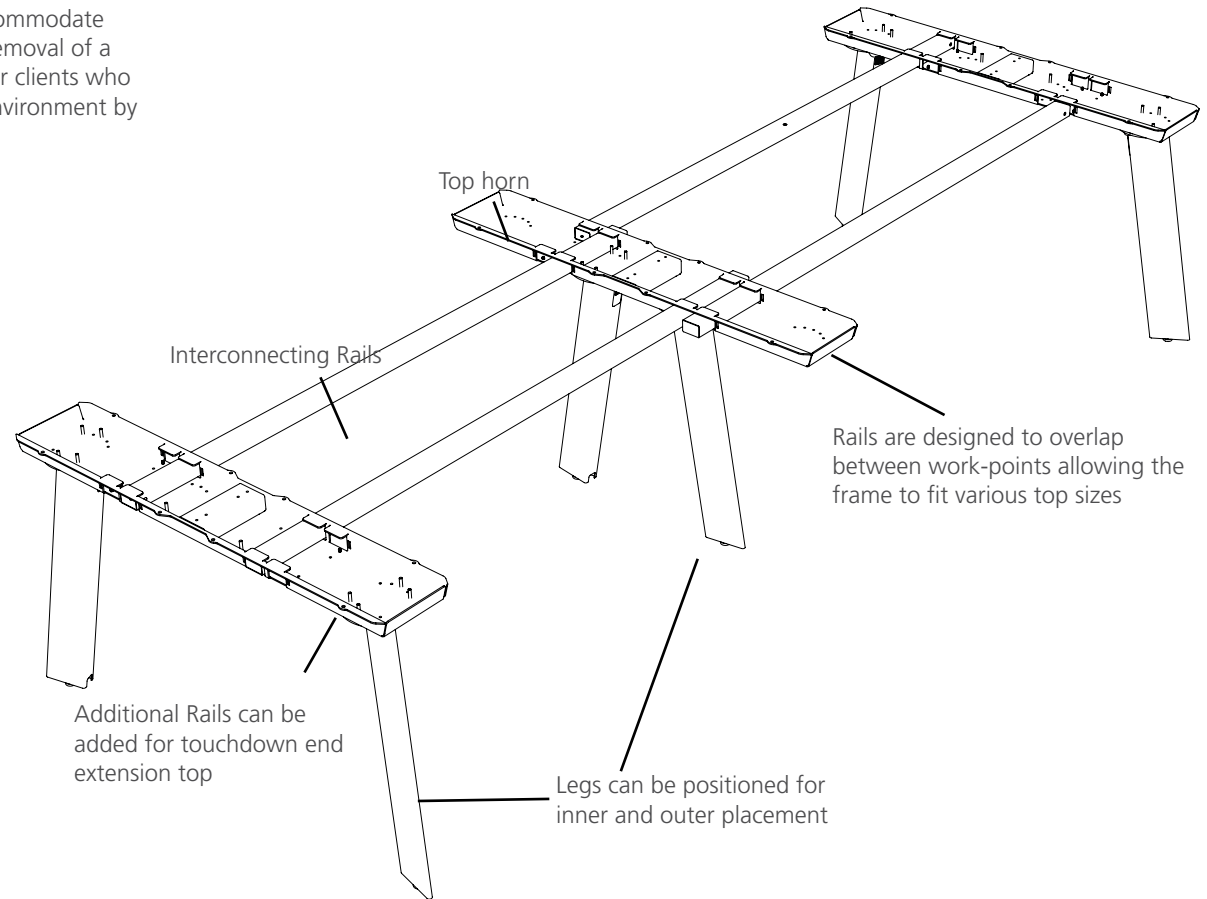

## Top horn and leg position



Attach worktop to the top horn

A single leg can be rotated on the top horn for right, left and center position increasing the design flexibility

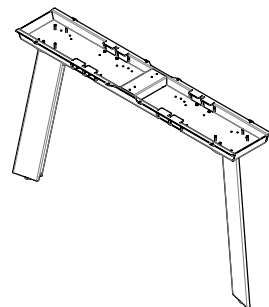

End Leg Set  
(Top horn + 2 Legs Outset)

OR

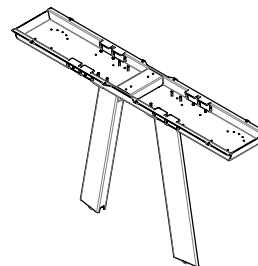

Middle Leg Set  
(Top horn + 2 Legs In set)



# EdgeWorks 4 person workstation measurements

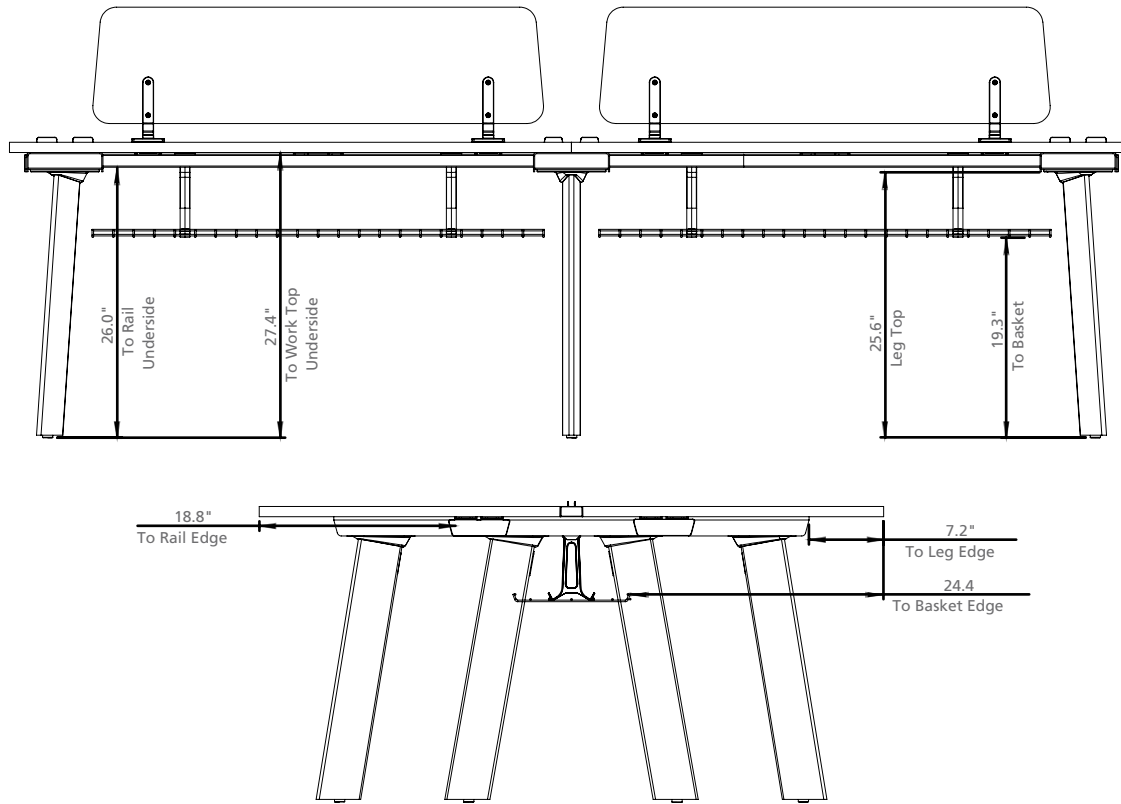

# EdgeWorks edges | pulls

## Standard profile

### "W" "P" "G" Standard profile

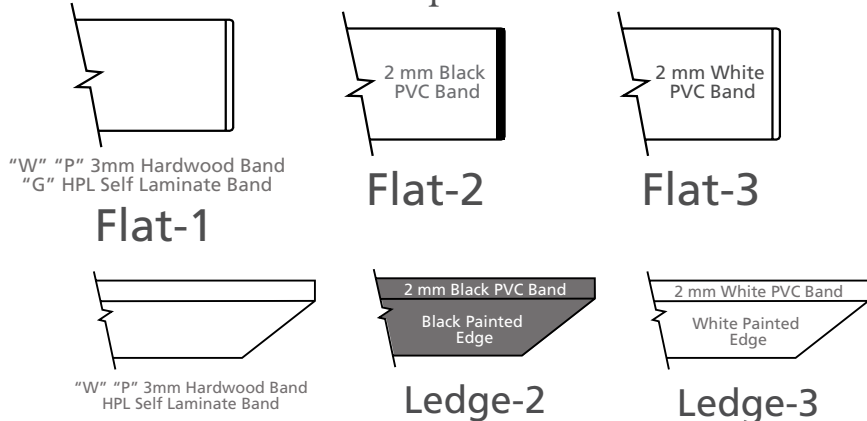

Flat-1

"W" "P" 3mm Hardwood Band  
HPL Self Laminate Band

Ledge-1

\*Flat-1 not available  
in GWL finish

### "M" Standard profile

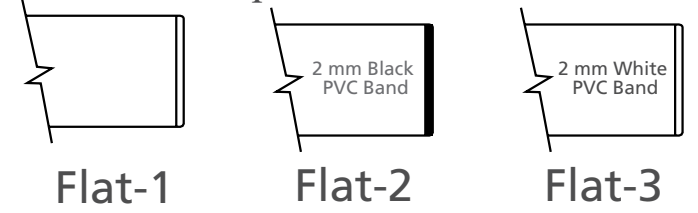

## Pulls

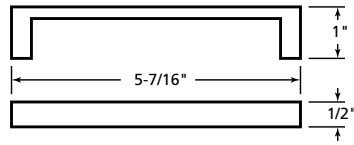

PL-115 Matte Black  
PL-116 Matte Nickel

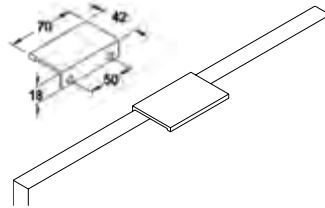

PL-260 Anodized Aluminum  
PL-261 White  
(Drawers Only)  
Optional \$15 list per pull

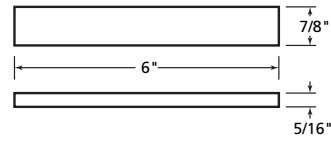

PL-210 Anodized Aluminum

## Finger pulls

Arrow indicates finger pull location

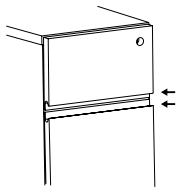

Finger Pull available on  
"W" "P" "G" Mobile Pedestals

## EdgeWorks grommets | grommet reference

TM30  
Black  
1-5/8" Dia.

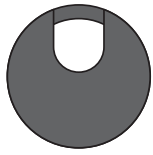

TM31  
Silver  
1-5/8" Dia.

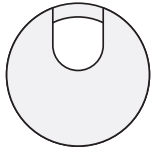

TM34  
White  
1-5/8" Dia.

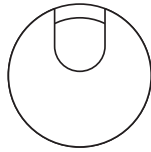

### Optional grommets

Factory Installed

Grommets (Standard Location)

Specify Color and Left/Right/Center - \$50 ea.

- Black: TM30-R (Right), TM30-L (Left), TM30-C (Center)

- Silver: TM31-R (Right), TM31-L (Left), TM31-C (Center)

- Antique Brass: TM33-R (Right), TM33-L (Left), TM33-C (Center)

Grommets (Non-Standard Location)

Provide drawing w/ Grommet Location and Specify

Color - \$95 ea.

- White: TM34-NS

TM50  
Black  
1-5/8" Dia.



### Grommets (vertical surface)

Standard Location - \$50 ea.

- Black Plastic Vertical Surface: TM50-C (Bottom Center)

Non-Standard Location - \$95 ea.

- Black Plastic Vertical Surface: TM50-NS

## Conference wire management

Power and data cables can be discretely housed and managed.

10"W x 1.5"D x 1.25"H

W21: Grey Wire Manager (10.5") - \$35

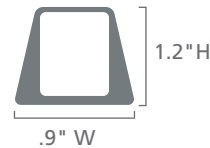
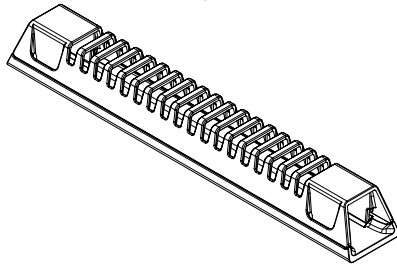

## Vertebrae wire management

W22 - Vertebrae (Clear) - \$135

W23 - Vertebrae (Gray) - \$140

\*Field Installed



## Standard grommet location reference

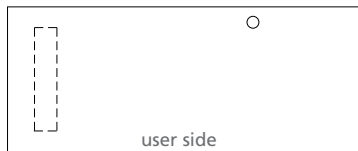

Return (Left leg shown)  
Left Leg - Right Grommet



Return (Right leg shown)  
Right Leg - Left Grommet



Full Pedestal Credenza  
Center Grommet

## EdgeWorks grain direction

### Grain direction

Veneer chassis parts are vertical grain. The backs of Thermally Fused Laminate overheads, wall hungs, wall hung shelves and flush chassis desks are horizontal grain. Bridges, returns, and credenza kneespace Thermally Fused Laminate backs over 60" are horizontal grain. Doors feature vertical veneer bookmatched horizontally in sets of 2,4, and 6 doors. Tower fronts are matched in vertical sets.

### "W" & "P" conference

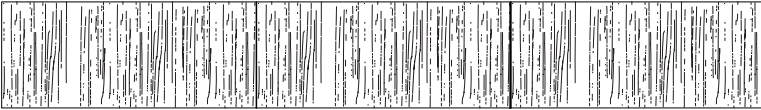
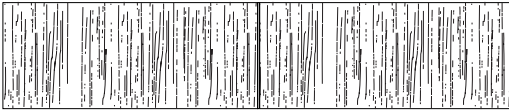

### "G" & "M" conference

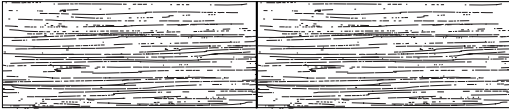

### Worksurfaces



Desk

## EdgeWorks Drawer dimensions | filing reference

### Interior drawer dimensions

UNIT DEPTH	DRAWER TYPE	OVERALL DIMENSIONS			INTERIOR DRAWER DIMENSIONS			NOTES
		W	D	H	W	D	H	
15-5/8" Letter	18" Box	13-1/8	16-1/16	4	12-1/8	15-1/16	3-7/16	Units less than 72"
	18" File	13-1/8	16-1/16	9-13/16	12-1/8	15-1/16	9-5/16	Units less than 72"
	10" Box	7-1/2	16-1/16	4	6-1/2	15-1/16	3-7/16	
	10" File	7-1/2	16-1/16	9-13/16	6-1/2	15-1/16	9-5/16	

### Filing reference

#### Filing for 18" depth units

13 1/8" Wide File Drawer - 16 1/16" Deep

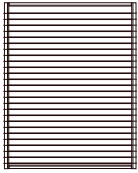

Letter Front to Back

#### Filing for 10" depth units

7-1/2" Wide File Drawer - 16 1/16" Deep

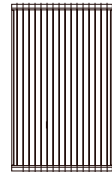

Letter Side to Side

# Edgeworks.

Workstations

1 Person Inline Workstation

1 Select a model w" x d" x h"	weight	Standard Veneer Top Matte Black Metal Base		Premium Veneer Top Matte Black Metal Frame		High Pressure Laminate Top Matte Black Metal Base		Thermally Fused Laminate Top Matte Black Metal Base			
		<b>29" Depth with wire basket</b>		72 x 29 x 29	115	EDG7229WP903W	2599	EDG7229WP903P	2859	EDG7229WP903G	2458
		66 x 29 x 29	145	EDG6629WP903W	2582	EDG6629WP903P	2840	EDG6629WP903G	2446	EDG6629WP903M	2222
		60 x 29 x 29	100	EDG6029WP903W	2567	EDG6029WP903P	2824	EDG6029WP903G	2436	EDG6029WP903M	2152
		54 x 29 x 29	95	EDG5429WP903W	2550	EDG5429WP903P	2805	EDG5429WP903G	2424	EDG5429WP903M	2140
<b>24" Depth without wire basket</b>		72 x 24 x 29	105	EDG7224WP903W	2348	EDG7224WP903P	2583	EDG7224WP903G	2231	EDG7224WP903M	2004
		66 x 24 x 29	95	EDG6624WP903W	2332	EDG6624WP903P	2566	EDG6624WP903G	2215	EDG6624WP903M	1993
		60 x 24 x 29	90	EDG6024WP903W	2315	EDG6024WP903P	2547	EDG6024WP903G	2200	EDG6024WP903M	1922
		54 x 24 x 29	85	EDG5424WP903W	2298	EDG5424WP903P	2528	EDG5424WP903G	2090	EDG5424WP903M	1912
2 Select a finish <i>View finish details</i>		WLA	WNW	TBCO		GAC	GSLV +10%	MAC			
		WAC	WWP	TBSW		GEC	GWL	MEC			
		WEC		TSTV		GOC		MOC			
		WOC		TSMV		GAM		MGW			
		WAM		TSLV		GCM		MSW			
		WCM		TOBV		GWM		MTW			
		WWM		WBO		GNW		MWL			
		WGW		WMO		GSTV					
		WBW		WSO		+10%					
		WSW									
3 Select an edge <i>View edge details</i>		Flat-1	Flat-2 (Black)	Flat-3 (White)		Flat-1	Flat-2 (Black)	Flat-3 (White)	Flat-1	Flat-2 (Black)	Flat-3 (White)
4 Select hardware <i>View hardware details</i>		Hardware N/A			Hardware N/A	Hardware N/A			Hardware N/A		

[View statement of line](#)

29" unit with basket shown



## Product features.

- 1" Thick top
- ENVI-CT finish on wood tops
- Matte black metal finish base standard
- (1) top
- (1) black metal finish wire basket (29" depth)
- Optional Metal accessories are mounted to the worksurface, matte black metal finish is standard
- 3" Adjustable glide

## Options.

### ACCESSORIES

- EA53: Personal Tray - \$270 ea.
- EA54: Document Pod & Paper Try - \$375 ea.
- EA55: Binder Pod - \$290 ea.

### POWER BLOCK

- 1IPBS: One In-Line Power Block System with Hardwire - \$390
- Specify hardwired or plug infeed. Plug infeed will require wire management W22 - \$130 Vertebrae (Clear) or W23 - \$135 Vertebrae (Gray)
- Includes (1) Power Block and Infeed
- Each power block has 8 duplex outlets

### WORKSURFACE CLAMP MOUNT POWER

- PD-KENO: Keno power pod with clamp - \$195 ea.
- PD-TULLY: Tully power pod with clamp - \$320 ea.
- P2SECL: Seclusion Power Clamp - \$245 ea.

### PREMIUM METAL FINISHES

- Specify Top Horn and Leg Metal Finish Color: \$630
- MFW: White, MFS: Silver, MFGG: Graphite Gray, MFSS: Salmon Sienna, MFSA: Surfing Aquavert, MFPS: Pistachio, MFOS: Oyster, MFNA: Navy, MFOL: Olive, MFGB: Grey Beige

### PLANK MATCH VENEER

- RPMV: Random Walnut Plank Match Veneer (Horizontal Grain with 25%+ Sap) - Add 10%. Clear coat only.

# Edgeworks.

Workstations  
2 Person Inline Workstation

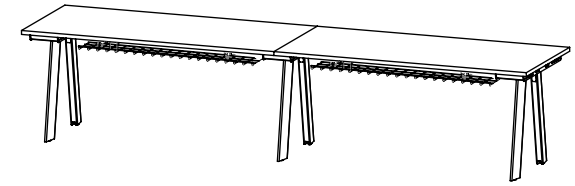

1 Select a model w" x d" x h"	weight	Standard Veneer Top Matte Black Metal Base		Premium Veneer Top Matte Black Metal Frame		High Pressure Laminate Top Matte Black Metal Base		Thermally Fused Laminate Top Matte Black Metal Base	
<b>72" Worksurfaces</b> 144 x 29 x 29	220	EDG14429WP903W	4516	EDG14429WP903P	4968	EDG14429WP903G	4232	EDG14429WP903M	3784
<b>66" Worksurfaces</b> 132 x 29 x 29	210	EDG13229WP903W	4482	EDG13229WP903P	4931	EDG13229WP903G	4210	EDG13229WP903M	3773
<b>60" Worksurfaces</b> 120 x 29 x 29	190	EDG12029WP903W	4450	EDG12029WP903P	4895	EDG12029WP903G	4188	EDG12029WP903M	3620
<b>54" Worksurfaces</b> 108 x 29 x 29	180	EDG10829WP903W	4417	EDG10829WP903P	4859	EDG10829WP903G	4166	EDG10829WP903M	3598
<b>2 Select a finish</b> <i>View finish details</i>		WLA WNW WAC WWP WEC Metal finish MFMB Matte Black. Additional metal finishes are available, see options.		TBCO TBSW TSTV TSMV TSLV TOBW WBO WMO WSO		GAC GSWL +10% GEC GWL GOC GAM GCM GWM GNW GSTV +10%		MAC MEC MOC MGW MSW MTW MWL	
<b>3 Select a edge</b> <i>View edge details</i>		Flat-1 Flat-2 (Black) Flat-3 (White)		Flat-1 Flat-2 (Black) Flat-3 (White)		Flat-1 Flat-2 (Black) Flat-3 (White)		Flat-1 Flat-2 (Black) Flat-3 (White)	
<b>4 Select hardware</b> <i>View hardware details</i>		Hardware N/A		Hardware N/A		Hardware N/A		Hardware N/A	

[View statement of line](#)

## Product features.

- 1" Thick top
- ENVI-CT finish on wood tops
- Matte black metal finish base standard
- (2) tops, (2) black metal finish wire baskets
- Optional Metal accessories are mounted to the worksurface, matte black metal finish is standard
- 3" Adjustable glide

## Options.

### ACCESSORIES

- EA53: Personal Tray - \$270 ea.
- EA54: Document Pod & Paper Try - \$375 ea.
- EA55: Binder Pod - \$290 ea.

### POWER BLOCK

- 2IPBS: Two In-Line Power Block System with Hardwire - \$750
- Specify hardwired or plug infeed. Plug infeed will require wire management W22 - \$130 Vertebrae (Clear) or W23 - \$135 Vertebrae (Gray)
- Includes (2) Power Blocks, (1) Jumper and Infeed
- Each power block has 8 duplex outlets

### WORKSURFACE CLAMP MOUNT POWER

- PD-KENO: Keno power pod with clamp - \$195 ea.
- PD-TULLY: Tully power pod with clamp - \$320 ea.
- P2SECL: Seclusion Power Clamp - \$245 ea.

### PREMIUM METAL FINISHES

- Specify Top Horn and Leg Metal Finish Color: \$1,010
- MFW: White, MFS: Silver, MFGG: Graphite Gray, MFSS: Salmon Sienna, MFSA: Surfin Aquavert, MFPS: Pistachio, MFOS: Oyster, MFNA: Navy, MFOL: Olive, MFGB: Grey Beige

### PLANK MATCH VENEER

- RPMV: Random Walnut Plank Match Veneer (Horizontal Grain with 25%+ Sap) - Add 10%. Clear coat only.

# Edgeworks.

Workstations  
3 Person Inline Workstation

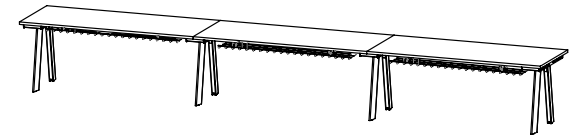

1 Select a model w" x d" x h"	weight	Standard Veneer Top Matte Black Metal Base		Premium Veneer Top Matte Black Metal Frame		High Pressure Laminate Top Matte Black Metal Base		Thermally Fused Laminate Top Matte Black Metal Base	
<b>72" Worksurfaces</b> 216 x 29 x 29	325	EDG21629WP903W	6426	EDG21629WP903P	7069	EDG21629WP903G	6001	EDG21629WP903M	5329
<b>66" Worksurfaces</b> 198 x 29 x 29	310	EDG19829WP903W	6377	EDG19829WP903P	7015	EDG19829WP903G	5968	EDG19829WP903M	5297
<b>60" Worksurfaces</b> 180 x 29 x 29	280	EDG18029WP903W	6328	EDG18029WP903P	6961	EDG18029WP903G	5935	EDG18029WP903M	5084
<b>54" Worksurfaces</b> 162 x 29 x 29	265	EDG16229WP903W	6280	EDG16229WP903P	6908	EDG16229WP903G	5902	EDG16229WP903M	5050
2 Select a finish <i>View finish details</i>  Metal finish MFMB Matte Black. Additional metal finishes are available, see options.		WLA	WNW	TBCO		GAC	GSLV +10%	MAC	
		WAC	WWP	TBSW		GEC	GWL	MEC	
		WEC		TSTV		GOC		MOC	
		WOC		TSMV		GAM		MGW	
		WAM		TSLV		GCM		MSW	
		WCM		TOBW		GWM		MTW	
		WWM		WBO		GNW		MWL	
		WGW		WMO		GSTV			
		WBW		WSO		+10%			
		WSW							
3 Select a edge <i>View edge details</i>									
		Flat-1	Flat-2 (Black)	Flat-3 (White)	Flat-1	Flat-2 (Black)	Flat-3 (White)	Flat-1	Flat-2 (Black)
4 Select hardware <i>View hardware details</i>		Hardware		Hardware		Hardware		Hardware	
		N/A		N/A		N/A		N/A	

*View statement of line*

## Product features.

- 1" Thick top
- ENVI-CT finish on wood tops
- Matte black metal finish base standard
- (3) tops, (3) black metal finish wire baskets
- Optional Metal accessories are mounted to the worksurface, matte black metal finish is standard
- 3" Adjustable glide

## Options.

### ACCESSORIES

- EA53: Personal Tray - \$270 ea.
- EA54: Document Pod & Paper Try - \$375 ea.
- EA55: Binder Pod - \$290 ea.

### POWER BLOCK

- 3IPBS: Three In-Line Power Block System with Hardwire - \$1,100
- Specify hardwired or plug infeed. Plug infeed will require wire management W22 - \$130 Vertebrae (Clear) or W23 - \$135 Vertebrae (Gray)
- Includes (3) Power Blocks, (2) Jumpers and Infeed
- Each power block has 8 duplex outlets
- Plug Infeed can be daisy chained up to 16 duplex outlets on one 20 amp circuit

### WORKSURFACE CLAMP MOUNT POWER

- PD-KENO: Keno power pod with clamp - \$195 ea.
- PD-TULLY: Tully power pod with clamp - \$320 ea.
- P2SECL: Seclusion Power Clamp - \$245 ea.

### PREMIUM METAL FINISHES

- Specify Top Horn and Leg Metal Finish Color: \$1,355
- MFW: White, MFS: Silver, MFGG: Graphite Gray, MFSS: Salmon Sienna, MFSA: Surfin Aquavert, MFPS: Pistachio, MFOS: Oyster, MFNA: Navy, MFOL: Olive, MFGB: Grey Beige

### PLANK MATCH VENEER

- RPMV: Random Walnut Plank Match Veneer (Horizontal Grain with 25%+ Sap) - Add 10%. Clear coat only.



# Edgeworks.

Workstations

2 Person Facing Workstation

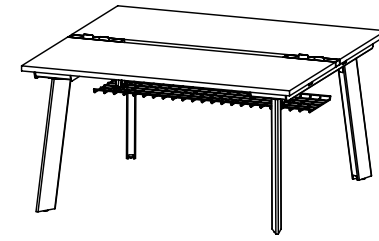

**1** Select a model  
w" x d" x h" weight

	Standard Veneer Top Matte Black Metal Base	Premium Veneer Top Matte Black Metal Frame	High Pressure Laminate Top Matte Black Metal Base	Thermally Fused Laminate Top Matte Black Metal Base
<b>Worksurface Dimensions</b>				
<b>29" Depth</b>				
72 x 60 x 29	210 EDG7260WP900W 3844	EDG7260WP900P 4228	EDG7260WP900G 3560	EDG7260WP900M 3113
66 x 60 x 29	200 EDG6660WP900W 3812	EDG6660WP900P 4194	EDG6660WP900G 3538	EDG6660WP900M 3091
60 x 60 x 29	180 EDG6060WP900W 3778	EDG6060WP900P 4156	EDG6060WP900G 3516	EDG6060WP900M 2948
54 x 60 x 29	170 EDG5460WP900W 3746	EDG5460WP900P 4121	EDG5460WP900G 3494	EDG5460WP900M 2927
<b>23" Depth</b>				
72 x 48 x 29	200 EDG7248WP900W 3506	EDG7248WP900P 3857	EDG7248WP900G 3266	EDG7248WP900M 2992
66 x 48 x 29	190 EDG6648WP900W 3473	EDG6648WP900P 3821	EDG6648WP900G 3244	EDG6648WP900M 2883
60 x 48 x 29	170 EDG6048WP900W 3440	EDG6048WP900P 3784	EDG6048WP900G 3222	EDG6048WP900M 2774
54 x 48 x 29	160 EDG5448WP900W 3407	EDG5448WP900P 3748	EDG5448WP900G 3200	EDG5448WP900M 2752
<b>2</b> Select a finish <i>View finish details</i>	WLA WNW WAC WWP WEC Metal finish MFMB Matte Black. Additional metal finishes are available, see options.	TBCO TBSW TSTV TSMV TSLV TOBWS WBO WMO WSO	GAC GSWL +10% GEC GWL GOC GAM GCM GWM GNW GSTV +10%	MAC MEC MOC MGW MSW MTW MWL
<b>3</b> Select an edge <i>View edge details</i>	Flat-1 Flat-2 (Black) Flat-3 (White)	Flat-1 Flat-2 (Black) Flat-3 (White)	Flat-1 Flat-2 (Black) Flat-3 (White)	Flat-1 Flat-2 (Black) Flat-3 (White)
<b>4</b> Select hardware <i>View hardware details</i>	Hardware N/A	Hardware N/A	Hardware N/A	Hardware N/A

[View statement of line](#)

## Product features.

- 1" Thick top
- ENVI-CT finish on wood tops
- Expandable frame matte black metal finish standard
- (2) tops, (1) black metal finish wire basket
- Optional Metal accessories are center mounted, matte black metal finish is standard
- 3" Adjustable glide

## Options.

### ACCESSORIES

- EA50: Personal Tray - \$270 ea.
- EA51: Document Pod & Paper Tray - \$375 ea.
- EA52: Binder Pod - \$290 ea.

### POWER BLOCK

- 2PPBS: Two Pack Power Block System with Hardwire - \$390
- Specify hardwired or plug infeed. Plug infeed will require wire management W22 - \$130 Vertebrae (Clear) or W23 - \$135 Vertebrae (Gray)
- Includes (1) Power Block and Infeed
- Each power block has 8 duplex outlets

### WORKSURFACE CLAMP MOUNT POWER

- PD-KENO: Keno power pod with clamp - \$195 ea.
- PD-TULLY: Tully power pod with clamp - \$320 ea.
- P2SECL: Seclusion Power Clamp - \$245 ea.

### PREMIUM METAL FINISHES

- Specify Top Horn and Leg Metal Finish Color: \$630
- MFW: White, MFS: Silver, MFGG: Graphite Gray, MFSS: Salmon Sienna, MFSA: Surfin Aquavert, MFPS: Pistachio, MFOS: Oyster, MFNA: Navy, MFOL: Olive, MFGB: Grey Beige

### PLANK MATCH VENEER

- RPMV: Random Walnut Plank Match Veneer (Horizontal Grain with 25%+ Sap) - Add 10%. Clear coat only.

# Edgeworks.

Workstations

4 Person Facing Workstation

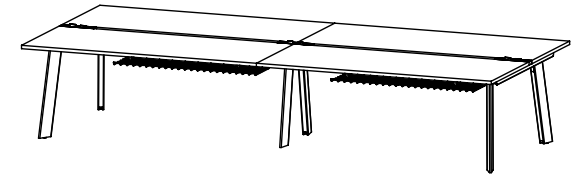

1 Select a model w" x d" x h"	weight	Standard Veneer Top Matte Black Metal Base		Premium Veneer Top Matte Black Metal Frame		High Pressure Laminate Top Matte Black Metal Base		Thermally Fused Laminate Top Matte Black Metal Base	
		<b>72" Worksurfaces</b> 144 x 60 x 29 144 x 48 x 29 <b>66" Worksurfaces</b> 132 x 60 x 29 132 x 48 x 29 <b>60" Worksurfaces</b> 120 x 60 x 29 120 x 48 x 29 <b>54" Worksurfaces</b> 108 x 60 x 29 108 x 48 x 29		EDG14460WP900W 6880 EDG14448WP900W 6203 EDG13260WP900W 6814 EDG13248WP900W 6137 EDG12060WP900W 6749 EDG12048WP900W 6072 EDG10860WP900W 6683 EDG10848WP900W 6006	EDG14460WP900P 7568 EDG14448WP900P 6823 EDG13260WP900P 7496 EDG13248WP900P 6751 EDG12060WP900P 7424 EDG12048WP900P 6680 EDG10860WP900P 7352 EDG10848WP900P 6607	EDG14460WP900G 6312 EDG14448WP900G 5722 EDG13260WP900G 6268 EDG13248WP900G 5678 EDG12060WP900G 6224 EDG12048WP900G 5635 EDG10860WP900G 6181 EDG10848WP900G 5591	EDG14460WP900M 5416 EDG14448WP900M 5001 EDG13260WP900M 5373 EDG13248WP900M 4958 EDG12060WP900M 5089 EDG12048WP900M 4739 EDG10860WP900M 5045 EDG10848WP900M 4696		
<b>2 Select a finish</b> <a href="#">View finish details</a>  Metal finish MFMB Matte Black. Additional metal finishes are available, see options.	WLA WNW WAC WWP WEC WOC WAM WCM WWM WGW WBW WSW	TBCO TBSW TSTV TSMV TSLV TOBW WBO WMO WSO	GAC GSLV +10% GEC GWL GOC GAM GCM GWM GNW GSTV +10%	MAC MEC MOC MGW MSW MTW MWL					
<b>3 Select an edge</b> <a href="#">View edge details</a>	Flat-1 Flat-2 (Black) Flat-3 (White)	Flat-1 Flat-2 (Black) Flat-3 (White)	Flat-1 Flat-2 (Black) Flat-3 (White)	Flat-1 Flat-2 (Black) Flat-3 (White)					
<b>4 Select hardware</b> <a href="#">View hardware details</a>	Hardware N/A	Hardware N/A	Hardware N/A	Hardware N/A					

[View statement of line](#)

## Product features.

- 1" Thick top
- ENVI-CT finish on wood tops
- Expandable frame matte black metal finish standard
- (4) tops, (2) black metal finish wire baskets
- Legs can be positioned for inner or outer placement
- Optional Metal accessories are center mounted, matte black metal finish is standard
- 3" Adjustable glide

### NOTES

- 60" Depth Workstations feature 29" Worksurfaces
- 48" Depth Workstations feature 23" Worksurfaces

## Options.

### ACCESSORIES

- EA50: Personal Tray - \$270 ea.
- EA51: Document Pod & Paper Tray - \$375 ea.
- EA52: Binder Pod - \$290 ea.

### POWER BLOCK

- 4PPBS: Four Pack Power Block System with Hardwire - \$750
- Specify hardwired or plug infeed. Plug infeed will require wire management W22 - \$130 Vertebrae (Clear) or W23 - \$135 Vertebrae (Gray)
- Includes (2) Power Blocks, (1) Jumper and Infeed
- Each power block has 8 duplex outlets

### WORKSURFACE CLAMP MOUNT POWER

- PD-KENO: Keno power pod with clamp - \$195 ea.
- PD-TULLY: Tully power pod with clamp - \$320 ea.
- P2SECL: Seclusion Power Clamp - \$245 ea.

### PREMIUM METAL FINISHES

- Specify Top Horn and Leg Metal Finish Color: \$1,010
- MFW: White, MFS: Silver, MFGG: Graphite Gray, MFSS: Salmon Sienna, MFSA: Surfing Aquavert, MFPS: Pistachio, MFOS: Oyster, MFNA: Navy, MFOL: Olive, MFGB: Grey Beige

### PLANK MATCH VENEER

- RPMV: Random Walnut Plank Match Veneer (Horizontal Grain with 25%+ Sap) - Add 10%. Clear coat only.

# Edgeworks.

Workstations  
6 Person Facing Workstation

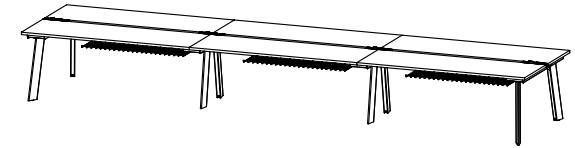

1 Select a model w" x d" x h"	weight	Standard Veneer Top Matte Black Metal Base		Premium Veneer Top Matte Black Metal Frame		High Pressure Laminate Top Matte Black Metal Base		Thermally Fused Laminate Top Matte Black Metal Base	
		<b>72" Worksurfaces</b> 216 x 60 x 29 216 x 48 x 29 <b>66" Worksurfaces</b> 198 x 60 x 29 198 x 48 x 29 <b>60" Worksurfaces</b> 180 x 60 x 29 180 x 48 x 29 <b>54" Worksurfaces</b> 162 x 60 x 29 162 x 48 x 29		570 EDG21660WP900W 9910 540 EDG21648WP900W 8894 540 EDG19860WP900W 9811 510 EDG19848WP900W 8796 480 EDG18060WP900W 9714 450 EDG18048WP900W 8698 450 EDG16260WP900W 9615 420 EDG16248WP900W 8600	EDG21660WP900P 10901 EDG21648WP900P 9783 EDG19860WP900P 10793 EDG19848WP900P 9676 EDG18060WP900P 10686 EDG18048WP900P 9568 EDG16260WP900P 10577 EDG16248WP900P 9460	10901 9783 10793 9676 10686 9568 10577 9460	GAC GSWL +10% GEC GWL GOC GAM GCM GWM GNW GSTV +10%	6958 8173 8993 8108 8927 8042 8862 7977	6958 8173 8993 8108 8927 8042 8862 7977

2 Select a finish <i>View finish details</i>	Metal finish MFMB Matte Black. Additional metal finishes are available, see options.		TBCO TBSW TSTV TSMV TSLV TOBW WBO WMO WSO	GAC GSWL +10% GEC GWL GOC GAM GCM GWM GNW GSTV +10%	MAC MEC MOC MGW MSW MTW MWL
	WLA WNW WAC WWP WEC WOC WAM WCM WWM WGW WBW WSW				

3 Select an edge <i>View edge details</i>	Flat-1 Flat-2 (Black) Flat-3 (White)			Flat-1 Flat-2 (Black) Flat-3 (White)			Flat-1 Flat-2 (Black) Flat-3 (White)		

4 Select hardware <i>View hardware details</i>	Hardware N/A	Hardware N/A	Hardware N/A	Hardware N/A

[View statement of line](#)

## Product features.

- 1" Thick top
- ENVI-CT finish on wood tops
- Expandable frame matte black metal finish standard
- (6) tops, (3) black metal finish wire baskets
- Legs can be positioned for inner or outer placement
- Optional Metal accessories are center mounted, matte black metal finish is standard
- 3" Adjustable glide

### NOTES

- 60" Depth Workstations feature 29" Worksurfaces
- 48" Depth Workstations feature 23" Worksurfaces

## Options.

### ACCESSORIES

- EA50: Personal Tray - \$270 ea.
- EA51: Document Pod & Paper Tray - \$375 ea.
- EA52: Binder Pod - \$290 ea.

### POWER BLOCK

- 6PPBS: Six Pack Power Block System with Hardwire - \$1,100
- Specify hardwired or plug infeed. Plug infeed will require wire management W22 - \$130 Vertebrae (Clear) or W23 - \$135 Vertebrae (Gray)
- Includes (3) Power Blocks, (2) Jumpers and Infeed
- Each power block has 8 duplex outlets
- Plug Infeed can be daisy chained up to 16 duplex outlets on one 20 amp circuit

### WORKSURFACE CLAMP MOUNT POWER

- PD-KENO: Keno power pod with clamp - \$195 ea.
- PD-TULLY: Tully power pod with clamp - \$320 ea.
- P2SECL: Seclusion Power Clamp - \$245 ea.

### PREMIUM METAL FINISHES

- Specify Top Horn and Leg Metal Finish Color: \$1,355
- MFW: White, MFS: Silver, MFGG: Graphite Gray, MFSS: Salmon Sienna, MFSA: Surfin Aquavert, MFPS: Pistachio, MFOS: Oyster, MFNA: Navy, MFOL: Olive, MFGB: Grey Beige









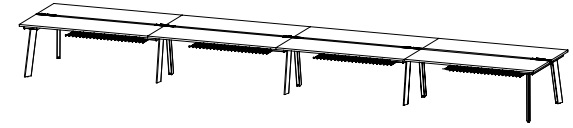



### PLANK MATCH VENEER

- RPMV: Random Walnut Plank Match Veneer (Horizontal Grain with 25%+ Sap) - Add 10%. Clear coat only.

# Edgeworks.

Workstations  
8 Person Facing Workstation



1 Select a model w" x d" x h"	weight	Standard Veneer Top Matte Black Metal Base		Premium Veneer Top Matte Black Metal Frame		High Pressure Laminate Top Matte Black Metal Base		Thermally Fused Laminate Top Matte Black Metal Base				
		<b>72" Worksurfaces</b> 288 x 60 x 29 288 x 48 x 29 <b>66" Worksurfaces</b> 264 x 60 x 29 264 x 48 x 29 <b>60" Worksurfaces</b> 240 x 60 x 29 240 x 48 x 29 <b>54" Worksurfaces</b> 216 x 60 x 29 216 x 48 x 29	760 720 720 680 640 600 600 560	EDG28860WP908W EDG28848WP908W EDG26460WP908W EDG26448WP908W EDG24060WP908W EDG24048WP908W EDG21660WP908W EDG21648WP908W	12946 11592 12815 11461 12684 11330 12553 11199	EDG28860WP908P EDG28848WP908P EDG26460WP908P EDG26448WP908P EDG24060WP908P EDG24048WP908P EDG21660WP908P EDG21648WP908P	14241 12751 14097 12608 13953 12463 13809 12319	EDG28860WP908G EDG28848WP908G EDG26460WP908G EDG26448WP908G EDG24060WP908G EDG24048WP908G EDG21660WP908G EDG21648WP908G	11810 10631 11723 10544 11636 10456 11548 10369	EDG28860WP908M EDG28848WP908M EDG26460WP908M EDG26448WP908M EDG24060WP908M EDG24048WP908M EDG21660WP908M EDG21648WP908M	10019 9102 9954 9037 9888 8971 9823 8906	
<b>2 Select a finish</b> <a href="#">View finish details</a>  Metal finish MFMB Matte Black. Additional metal finishes are available, see options.	WLA WNW WAC WWP WEC WOC WAM WCM WWM WGW WBW WSW	TBCO TBSW TSTV TSMV TSLV TOBW WBO WMO WSO	GAC GSWL +10% GEC GWL GOC GAM GCM GWM GNW GSTV +10%	MAC MEC MOC MGW MSW MTW MWL	 Flat-1  Flat-2 (Black)  Flat-3 (White)	 Flat-1  Flat-2 (Black)  Flat-3 (White)	 Flat-1  Flat-2 (Black)  Flat-3 (White)	 Flat-1  Flat-2 (Black)  Flat-3 (White)	Hardware N/A	Hardware N/A	Hardware N/A	Hardware N/A
<b>3 Select an edge</b> <a href="#">View edge details</a>												
<b>4 Select hardware</b> <a href="#">View hardware details</a>												

[View statement of line](#)

## Product features.

- 1" Thick top
- ENVI-CT finish on wood tops
- Expandable frame matte black metal finish standard
- (8) tops, (4) black metal finish wire baskets
- Legs can be positioned for inner or outer placement
- Optional Metal accessories are center mounted, matte black metal finish is standard
- 3" Adjustable glide

### NOTES

- 60" Depth Workstations feature 29" Worksurfaces
- 48" Depth Workstations feature 23" Worksurfaces

## Options.

### ACCESSORIES

- EA50: Personal Tray - \$270 ea.
- EA51: Document Pod & Paper Tray - \$375 ea.
- EA52: Binder Pod - \$290 ea.

### POWER BLOCK

- 8PPBS: Eight Pack Power Block System with Hardwire - \$1,500
- Specify hardwired or plug infeed. Plug infeed will require wire management W22 - \$130 Vertebrae (Clear) or W23 - \$135 Vertebrae (Gray)
- Includes (4) Power Blocks, (3) Jumpers and Infeed
- Each power block has 8 duplex outlets
- Plug Infeed can be daisy chained up to 16 duplex outlets on one 20 amp circuit

### WORKSURFACE CLAMP MOUNT POWER

- PD-KENO: Keno power pod with clamp - \$195 ea.
- PD-TULLY: Tully power pod with clamp - \$320 ea.
- P2SECL: Seclusion Power Clamp - \$245 ea.

### PREMIUM METAL FINISHES

- Specify Top Horn and Leg Metal Finish Color: \$990
- MFW: White, MFS: Silver, MFGG: Graphite Gray, MFSS: Salmon Sienna, MFSA: Surfin Aquavert, MFPS: Pistachio, MFOS: Oyster, MFNA: Navy, MFOL: Olive, MFGB: Grey Beige

### PLANK MATCH VENEER

- RPMV: Random Walnut Plank Match Veneer (Horizontal Grain with 25%+ Sap) - Add 10%. Clear coat only.

# Edgeworks.

Workstations  
10 Person Facing Workstation



1 Select a model w" x d" x h"	weight	Standard Veneer Top Matte Black Metal Base		Premium Veneer Top Matte Black Metal Frame		High Pressure Laminate Top Matte Black Metal Base		Thermally Fused Laminate Top Matte Black Metal Base		
		<b>72" Worksurfaces</b> 360 x 60 x 29 360 x 48 x 29 <b>66" Worksurfaces</b> 330 x 60 x 29 330 x 48 x 29 <b>60" Worksurfaces</b> 300 x 60 x 29 300 x 48 x 29 <b>54" Worksurfaces</b> 270 x 60 x 29 270 x 48 x 29		950 EDG36060WP900W 15982 900 EDG36048WP900W 14289 900 EDG33060WP900W 15817 850 EDG33048WP900W 14125 800 EDG30060WP900W 15654 750 EDG30048WP900W 13961 750 EDG27060WP900W 15485 700 EDG27048WP900W 13792	EDG36060WP900P 17581 EDG36048WP900P 15718 EDG33060WP900P 17399 EDG33048WP900P 15538 EDG30060WP900P 17220 EDG30048WP900P 15358 EDG27060WP900P 17034 EDG27048WP900P 15172	EDG36060WP900G 12378 EDG36048WP900G 13087 EDG33060WP900G 14453 EDG33048WP900G 12978 EDG30060WP900G 14344 EDG30048WP900G 12869 EDG27060WP900G 14229 EDG27048WP900G 12755	EDG36060WP900M 12323 EDG36048WP900M 11111 EDG33060WP900M 12236 EDG33048WP900M 11024 EDG30060WP900M 12138 EDG30048WP900M 10925 EDG27060WP900M 12072 EDG27048WP900M 10860			
<b>2 Select a finish</b> <a href="#">View finish details</a>  Metal finish MFMB Matte Black. Additional metal finishes are available, see options.	WLA WNW WAC WWP WEC WOC WAM WCM WWM WGW WBW WSW	TBCO TBSW TSTV TSMV TSLV TOBW WBO WMO WSO	GAC GSLV +10% GEC GWL GOC GAM GCM GWM GNW GSTV +10%	MAC MEC MOC MGW MSW MTW MWL						
<b>3 Select a edge</b> <a href="#">View edge details</a>	Flat-1 Flat-2 (Black) Flat-3 (White)	Flat-1 Flat-2 (Black) Flat-3 (White)	Flat-1 Flat-2 (Black) Flat-3 (White)	Flat-1 Flat-2 (Black) Flat-3 (White)						
<b>4 Select hardware</b> <a href="#">View hardware details</a>	Hardware N/A	Hardware N/A	Hardware N/A	Hardware N/A						

[View statement of line](#)

## Product features.

- 1" Thick top
- ENVI-CT finish on wood tops
- Expandable frame matte black metal finish standard
- (10) tops, (5) black metal finish wire baskets
- Legs can be positioned for inner or outer placement
- Optional Metal accessories are center mounted , matte black metal finish is standard
- 3" Adjustable glide

### NOTES

- 60" Depth Workstations feature 29" Worksurfaces
- 48" Depth Workstations feature 23" Worksurfaces

## Options.

### ACCESSORIES

- EA50: Personal Tray - \$270 ea.
- EA51: Document Pod & Paper Tray - \$375 ea.
- EA52: Binder Pod - \$290 ea.

### POWER BLOCK

- 10PPBS: Ten Pack Power Block System with Hardwire - \$1,850
- Specify hardwired or plug infeed. Plug infeed will require wire management W22 - \$130 Vertebrae (Clear) or W23 - \$135 Vertebrae (Gray)
- Includes (5) Power Blocks, (4) Jumpers and Infeed
- Each power block has 8 duplex outlets
- Plug Infeed can be daisy chained up to 16 duplex outlets on one 20 amp circuit

### WORKSURFACE CLAMP MOUNT POWER

- PD-KENO: Keno power pod with clamp - \$195 ea.
- PD-TULLY: Tully power pod with clamp - \$320 ea.
- P2SECL: Seclusion Power Clamp - \$245 ea.

### PREMIUM METAL FINISHES

- Specify Top Horn and Leg Metal Finish Color: \$1,190
- MFW: White, MFS: Silver, MFGG: Graphite Gray, MFSS: Salmon Sienna, MFSA: Surfin Aquavert, MFPS: Pistachio, MFOS: Oyster, MFNA: Navy, MFOL: Olive, MFGB: Grey Beige

### PLANK MATCH VENEER

- RPMV: Random Walnut Plank Match Veneer (Horizontal Grain with 25%+ Sap) - Add 10%. Clear coat only.

# Edgeworks.

Workstation Tops  
Touchdown End Extension Top

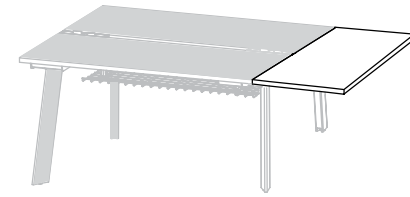

[View statement of line](#)

1 Select a model w" x d" x h"	weight	Standard Veneer Top		Premium Veneer Top		High Pressure Laminate Top		Thermally Fused Laminate Top	
<b>60"D Touchdown Top</b> 18 x 60 x 29	50	EDG6018ET904W	704	EDG6018ET904P	775	EDG6018ET904G	595	EDG6018ET904M	371
<b>48"D Touchdown Top</b> 18 x 48 x 29	45	EDG4818ET904W	688	EDG4818ET904P	757	EDG4818ET904G	584	EDG4818ET904M	361
2 Select a finish <a href="#">View finish details</a>		WLA WAC WEC WOC WAM WCM WWW WGW WBW WSW	WNW WWP	TBCO TBSW TSTV TSMV TSLV TOBW WBO WMO WSO		GAC GEC GOC GAM GCM GWM GNW GSTV +10%	GSLV +10% GWL	MAC MEC MOC MGW MSW MTW MWL	
3 Select an edge <a href="#">View edge details</a>		Flat-1 Flat-2 (Black) Flat-3 (White)		Flat-1 Flat-2 (Black) Flat-3 (White)		Flat-1 Flat-2 (Black) Flat-3 (White)		Flat-1 Flat-2 (Black) Flat-3 (White)	
4 Select hardware <a href="#">View hardware details</a>		Hardware N/A		Hardware N/A		Hardware N/A		Hardware N/A	

## Product features.

- 1" Thick top
- ENVI-CT finish on wood tops
- Touchdown extension top will fit facing workstations; 60" Depth Touchdowns match to 29" Worksurfaces, 48" D Touchdowns match to 23" Worksurfaces
- Workstation frames expand to fit touchdown end extension top

### NOTES

- For field installation with existing bases

## Options.

### PLANK MATCH VENEER

- RPMV: Random Walnut Plank Match Veneer (Horizontal Grain with 25%+ Sap) - Add 10%. Clear coat only.

# Edgeworks.

Workstation Tops

Rectangle Workstation - Top Only

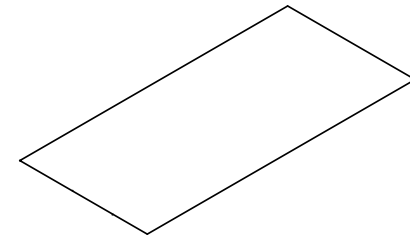

[View statement of line](#)

1 Select a model w" x d" x h"	weight	Standard Veneer Top		Premium Veneer Top		High Pressure Laminate Top		Thermally Fused Laminate Top		
		72 x 29 x 1	75	EDG7229WT902W	907	EDG7229WT902P	998	EDG7229WT902G	764	EDG7229WT902M
66 x 29 x 1	70	EDG6629WT902W	890	EDG6629WT902P	979	EDG6629WT902G	754	EDG6629WT902M	469	
60 x 29 x 1	60	EDG6029WT902W	874	EDG6029WT902P	961	EDG6029WT902G	743	EDG6029WT902M	459	
54 x 29 x 1	55	EDG5429WT902W	857	EDG5429WT902P	943	EDG5429WT902G	732	EDG5429WT902M	448	
2 Select a finish <a href="#">View finish details</a>		WLA	WNW	TBCO		GAC	GSLV +10%	MAC		
		WAC	WWP	TBSW		GEC	GWL	MEC		
		WEC		TSTV		GOC		MOC		
		WOC		TSMV		GAM		MGW		
		WAM		TSLV		GCM		MSW		
		WCM		TOBW		GWM		MTW		
		WWW		WBO		GNW		MWL		
		WGW		WMO		GSTV				
		WBW		WSO		+10%				
		WSW								
3 Select an edge <a href="#">View edge details</a>										
		Flat-1	Flat-2 (Black)	Flat-3 (White)	Flat-1	Flat-2 (Black)	Flat-3 (White)	Flat-1	Flat-2 (Black)	Flat-3 (White)
4 Select hardware <a href="#">View hardware details</a>		Hardware N/A		Hardware N/A		Hardware N/A		Hardware N/A		

## Product features.

- 1" Thick top
- ENVI-CT finish on wood tops

### NOTES

- For field installation with existing bases

## Options.

### PLANK MATCH VENEER

- RPMV: Random Walnut Plank Match Veneer (Horizontal Grain with 25%+ Sap) - Add 10%. Clear coat only.

# Edgeworks.

Freestanding Desk  
Table Desk With Metal Bases

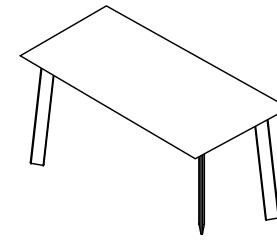

1 Select a model w" x d" x h"	weight	Standard Veneer Top Matte Black Metal Base		Premium Veneer Top Matte Black Metal Frame		High Pressure Laminate Top Matte Black Metal Base		Thermally Fused Laminate Top Matte Black Metal Base	
		72 x 30 x 29	115	EDG7230DS048W	2599	EDG7230DS048P	2859	EDG7230DS048G	2458
66 x 30 x 29	145	EDG6630DS048W	2582	EDG6630DS048P	2841	EDG6630DS048G	2446	EDG6630DS048M	2222
60 x 30 x 29	100	EDG6030DS048W	2567	EDG6030DS048P	2824	EDG6030DS048G	2436	EDG6030DS048M	2152
54 x 30 x 29	95	EDG5430DS048W	2550	EDG5430DS048P	2805	EDG5430DS048G	2424	EDG5430DS048M	2140

2 Select a finish <i>View finish details</i>	Metal finish MFMB Matte Black. Additional metal finishes are available, see options.		TBCO TBSW TSTV TSMV TSLV TOBW WBO WMO WSO		GAC    GSLV +10% GEC    GWL GOC GAM GCM GWM GNW GSTV +10%		MAC MEC MOC MGW MSW MTW MWL	
	3 Select a edge <i>View edge details</i>	WLA	WNW	Flat-1 Flat-2 (Black) Flat-3 (White) Ledge-1 (Finished) Ledge-2 (Black) Ledge-3 (White)	Flat-1 Flat-2 (Black) Flat-3 (White) Ledge-1 (Finished) Ledge-2 (Black) Ledge-3 (White)	Flat-1 Flat-2 (Black) Flat-3 (White) Ledge-1 (Finished) Ledge-2 (Black) Ledge-3 (White)	Flat-1 Flat-2 (Black) Flat-3 (White)	Flat-1 Flat-2 (Black) Flat-3 (White)
WAC		WWP						
4 Select hardware <i>View hardware details</i>	WEC		Hardware N/A	Hardware N/A	Hardware N/A	Hardware N/A		
	WOC							
	WAM							
	WCM							
	WWM							
	WGW							
	WBW							
	WSW							

[View statement of line](#)

## Product features.

- 1" Thick top
- ENVI-CT finish on wood tops
- Matte black metal finish base standard
- 3" Adjustable glide

### NOTES

- Freestanding use or with return

## Options.

### ACCESSORIES

- K28: Articulating Keyboard w/ Mouse - \$390

### GROMMETS (STANDARD LOCATION)

Specify Color and Location Right/Left - \$50 ea.

- Black: TM30-R (Left leg, right grommet), TM30-L (Right leg, left grommet)
- Silver: TM31-R (Left leg, right grommet), TM31-L (Right leg, left grommet)
- White: TM34-R (Left leg, right grommet), TM34-L (Right leg, left grommet)

### GROMMETS (NON-STANDARD LOCATION)

Provide drawing w/ Grommet Location and Specify Color - \$95 ea.

- Black: TM30-NS
- Silver: TM31-NS
- White: TM34-NS

### MODESTY

- MC51: Half veneer/laminate modesty - \$130

### PREMIUM METAL FINISHES

- Specify Top Horn and Leg Metal Finish Color: \$630
- MFW: White, MFS: Silver, MFGG: Graphite Gray, MFSS: Salmon Sienna, MFSA: Surfing Aquavert, MFPS: Pistachio, MFOS: Oyster, MFNA: Navy, MFOL: Olive, MFGB: Grey Beige
- PLANK MATCH VENEER
- RPMV: Random Walnut Plank Match Veneer (Horizontal Grain with 25%+ Sap) - Add 10%. Clear coat only.



# Edgeworks.

Return  
Workstation Return

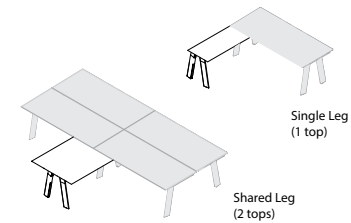

1 Select a model w" x d" x h"		weight	Standard Veneer Top	Premium Veneer Top	High Pressure Laminate Top	Thermally Fused Laminate Top			
<b>Single Leg (1 top)</b>									
48 x 23 x 29	85	EDG4823RE193W	1704	EDG4823RE193P	1875	EDG4823RE193G	1611	EDG4823RE193M	1409
42 x 23 x 29	80	EDG4223RE193W	1628	EDG4223RE193P	1791	EDG4223RE193G	1545	EDG4223RE193M	1371
36 x 23 x 29	75	EDG3623RE193W	1551	EDG3623RE193P	1707	EDG3623RE193G	1485	EDG3623RE193M	1332
<b>Shared Leg (2 tops)</b>									
48 x 30 x 29	150	EDG4830RE194W	2785	EDG4830RE194P	3064	EDG4830RE194G	2616	EDG4830RE194M	2228
42 x 30 x 29	140	EDG4230RE194W	2632	EDG4230RE194P	2896	EDG4230RE194G	2473	EDG4230RE194M	2152
36 x 30 x 29	130	EDG3630RE194W	2479	EDG3630RE194P	2727	EDG3630RE194G	2354	EDG3630RE194M	2075
2 Select a finish <i>View finish details</i>									
		WLA	WNW	TBCO	GAC	GSLV +10%	MAC		
		WAC	WWP	TBSW	GEC	GWL	MEC		
		WEC		TSTV	GOC		MOC		
		WOC		TSMV	GAM		MGW		
		WAM		TSLV	GCM		MSW		
		WCM		TOBW	GWM		MTW		
		WWM		WBO	GNW		MWL		
		WGW		WMO	GSTV				
		WBW		WSO	+10%				
		WSW							
3 Select an edge <i>View edge details</i>									
		Flat-1	Flat-2 (Black)	Flat-3 (White)	Flat-1	Flat-2 (Black)	Flat-3 (White)	Flat-1	Flat-2 (Black)
4 Select hardware <i>View hardware details</i>									
		Hardware N/A		Hardware N/A		Hardware N/A		Hardware N/A	

*View statement of line*

## Product features.

- 1" Thick top
- ENVI-CT finish on wood tops
- Matte black metal finish base standard
- Expandable frame
- 3" Adjustable glide

### NOTES

- Shared leg is for use with 2 person inline unit
- Shared leg has two tops
- Legs can be positioned for inner or outer placement

## Options.

### GROMMETS (STANDARD LOCATION)

Specify Color and Location Right/Left - \$50 ea.

- Black: TM30-R (Left leg, right grommet), TM30-L (Right leg, left grommet)
- Silver: TM31-R (Left leg, right grommet), TM31-L (Right leg, left grommet)
- White: TM34-R (Left leg, right grommet), TM34-L (Right leg, left grommet)

### GROMMETS (NON-STANDARD LOCATION)

Provide drawing w/ Grommet Location and Specify Color - \$95 ea.

- Black: TM30-NS
- Silver: TM31-NS
- White: TM34-NS

### PREMIUM METAL FINISHES

- Specify Top Horn and Leg Metal Finish Color: \$200
- MFW: White, MFS: Silver, MFGG: Graphite Gray, MFSS: Salmon Sienna, MFSA: Surfing Aquavert, MFPS: Pistachio, MFOS: Oyster, MFNA: Navy, MFOL: Olive, MFGB: Grey Beige

### PLANK MATCH VENEER

- RPMV: Random Walnut Plank Match Veneer (Horizontal Grain with 25%+ Sap) - Add 10%. Clear coat only.

# Edgeworks.

Return

Workstation Return - Top Only

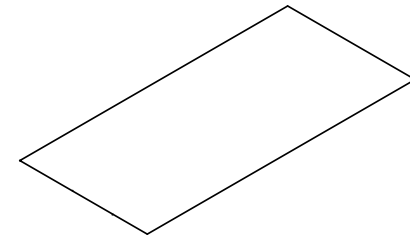

1 Select a model		Standard Veneer Top		Premium Veneer Top		High Pressure Laminate Top		Thermally Fused Laminate Top	
w" x d" x h"	weight								
48 x 23 x 1	45	EDG4823WT902W	672	EDG4823WT902P	740	EDG4823WT902G	568	EDG4823WT902M	349
42 x 23 x 1	40	EDG4223WT902W	655	EDG4223WT902P	721	EDG4223WT902G	557	EDG4223WT902M	339
36 x 23 x 1	35	EDG3623WT902W	639	EDG3623WT902P	703	EDG3623WT902G	546	EDG3623WT902M	317

2 Select a finish		Standard Veneer Top		Premium Veneer Top		High Pressure Laminate Top		Thermally Fused Laminate Top	
	<a href="#">View finish details</a>								
WLA		WNL		TBCO		GAC	GSLV +10%	MAC	
WAC		WNP		TBSW		GEC	GWL	MEC	
WEC				TSTV		GOC		MOC	
WOC				TSMV		GAM		MGW	
WAM				TSLV		GCM		MSW	
WCM				TOBW		GWM		MTW	
WWM				WBO		GNW		MWL	
WGW				WMO		GSTV			
WBW				WSO		+10%			
WSW									

3 Select a edge		Standard Veneer Top		Premium Veneer Top		High Pressure Laminate Top		Thermally Fused Laminate Top	
	<a href="#">View edge details</a>								
Flat-1		Flat-1		Flat-1		Flat-1		Flat-1	
Flat-2 (Black)		Flat-2 (Black)		Flat-2 (Black)		Flat-2 (Black)		Flat-2 (Black)	
Flat-3 (White)		Flat-3 (White)		Flat-3 (White)		Flat-3 (White)		Flat-3 (White)	

4 Select hardware		Standard Veneer Top		Premium Veneer Top		High Pressure Laminate Top		Thermally Fused Laminate Top	
	<a href="#">View hardware details</a>								
		Hardware N/A		Hardware N/A		Hardware N/A		Hardware N/A	

[View statement of line](#)

## Product features.

- 1" Thick top
- ENVI-CT finish on wood tops

### NOTES

- For field installation with existing bases

## Options.

### GROMMETS (STANDARD LOCATION)

Specify Color and Left/Right/Center - \$50 ea.

- Black: TM30-R (Right), TM30-L (Left)
- Silver: TM31-R (Right), TM31-L (Left)
- White: TM34-R (Right), TM34-L (Left)

### GROMMETS (NON-STANDARD LOCATION)

Provide drawing w/ Grommet Location and Specify Color - \$95 ea.

- Black: TM30-NS
- Silver: TM31-NS
- White: TM34-NS

### PLANK MATCH VENEER

- RPMV: Random Walnut Plank Match Veneer (Horizontal Grain with 25%+ Sap) - Add 10%. Clear coat only.

# Edgeworks.

Training table  
Rectangular Top

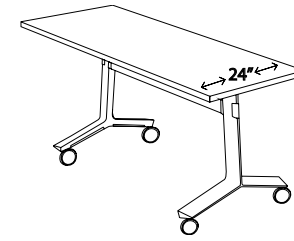

1 Select a model w" x d" x h"	weight	Standard Veneer Top Matte Black Metal Base		Premium Veneer Top Matte Black Metal Frame		High Pressure Laminate Top Matte Black Metal Base		Thermally Fused Laminate Top Matte Black Metal Base			
		84 x 24 x 28.5	230	EDG8424FN121W	2207	EDG8424FN121P	2428	EDG8424FN121G	2064	EDG8424FN121M	1844
72 x 24 x 28.5	215	EDG7224FN121W	2174	EDG7224FN121P	2391	EDG7224FN121G	2043	EDG7224FN121M	1823		
66 x 24 x 28.5	200	EDG6624FN121W	2136	EDG6624FN121P	2350	EDG6624FN121G	2012	EDG6624FN121M	1791		
60 x 24 x 28.5	185	EDG6024FN121W	2119	EDG6024FN121P	2331	EDG6024FN121G	2001	EDG6024FN121M	1781		
54 x 24 x 28.5	170	EDG5424FN121W	2081	EDG5424FN121P	2289	EDG5424FN121G	1970	EDG5424FN121M	1749		
48 x 24 x 28.5	155	EDG4824FN121W	2064	EDG4824FN121P	2270	EDG4824FN121G	1959	EDG4824FN121M	1739		
42 x 24 x 28.5	140	EDG4224FN121W	2027	EDG4224FN121P	2230	EDG4224FN121G	1928	EDG4224FN121M	1707		
2 Select a finish <i>View finish details</i>		WLA WNW		TBCO		GAC LP01 LW01		MAC			
		WAC WWP		TBSW		GEC LP02 LW02		MEC			
		WEC		TSTV		GOC LF01 LW04		MOC			
Metal finish		WOC		TSMV		GAM LF02 LW05		MGW			
MFMB Matte Black.		WAM		TSLV		GCM LF03 LW06		MSW			
Additional metal finishes are available, see options.		WCM		TOBW		GWM LN01 LW07		MTW			
		WWM		WBO		GNW LA01 + 20%		MWL			
		WGW		WMO		GWL LA02 + 20%					
		WBW		WSO		GSTV +10%					
		WSW				GSLV +10%					
3 Select a edge <i>View edge details</i>		Flat-1	Flat-2 (Black)	Flat-3 (White)		Flat-1	Flat-2 (Black)	Flat-3 (White)	Flat-1	Flat-2 (Black)	Flat-3 (White)
4 Select hardware <i>View hardware details</i>		Hardware N/A		Hardware N/A		Hardware N/A		Hardware N/A			

*View statement of line*

## Product features.

- 1" Thick top
- ENVI-CT Finish on wood tops
- Easy to use folding mechanism
- Matte black metal finish base standard
- 2 locking casters, 2 non-locking casters

## Options.

### PREMIUM METAL FINISHES

- Specify Top Horn and Leg Metal Finish Color: \$300
- MFW: White, MFS: Silver, MFGG: Graphite Gray, MFSS: Salmon Sienna, MFSA: Surfin Aquavert, MFPS: Pistachio, MFOS: Oyster, MFNA: Navy, MFOL: Olive, MFGB: Grey Beige

### COVE DAISYLINK POWER

#### Power Pod

- PD-Cove-PKO-TT: Cove Power Unit with 2 power, 2 USB and 1 telecom plate - \$435

#### Infeed

- PFC72: 72" 3 prong plug power infeed - \$225
- PFHRD120: 120" hardwire whip power infeed - \$210

#### Jumper

- JCTT84: Jumper for 84" worksurfaces - \$145
- JCTT72: Jumper for 72" worksurfaces - \$135
- JCTT66: Jumper for 66" worksurfaces - \$130
- JCTT60: Jumper for 60" worksurfaces - \$125
- JCTT54: Jumper for 54" worksurfaces - \$120
- JCTT48: Jumper for 48" worksurfaces - \$115
- JCTT42: Jumper for 48" worksurfaces - \$110

#### Telecom Plate

- RJ45 (1) - \$35, RJ45 (2) - \$70, RJ45 (3) - \$105, USB (1) - \$70, USB (2) - \$140, RJ45/USB - \$105, RJ45/HDMI - \$190, HDMI/USB - \$205

# Edgeworks.

Training table  
Rectangular Top

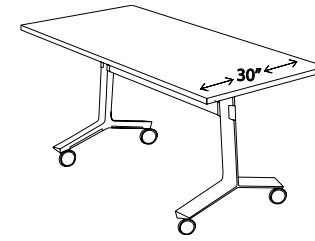

1 Select a model w" x d" x h"	weight	Standard Veneer Top Matte Black Metal Base		Premium Veneer Top Matte Black Metal Frame		High Pressure Laminate Top Matte Black Metal Base		Thermally Fused Laminate Top Matte Black Metal Base	
		84 x 30 x 28.5	245	EDG8430FN121W	2377	EDG8430FN121P	2615	EDG8430FN121G	2220
72 x 30 x 28.5	230	EDG7230FN121W	2344	EDG7230FN121P	2578	EDG7230FN121G	2199	EDG7230FN121M	1912
66 x 30 x 28.5	215	EDG6630FN121W	2306	EDG6630FN121P	2537	EDG6630FN121G	2167	EDG6630FN121M	1881
60 x 30 x 28.5	200	EDG6030FN121W	2289	EDG6030FN121P	2518	EDG6030FN121G	2157	EDG6030FN121M	1870
54 x 30 x 28.5	185	EDG5430FN121W	2251	EDG5430FN121P	2476	EDG5430FN121G	2125	EDG5430FN121M	1839
48 x 30 x 28.5	170	EDG4830FN121W	2234	EDG4830FN121P	2457	EDG4830FN121G	2115	EDG4830FN121M	1828
42 x 30 x 28.5	155	EDG4230FN121W	2197	EDG4230FN121P	2417	EDG4230FN121G	2083	EDG4230FN121M	1797
		WLA WNW WAC WWP WEC Metal finish MFMB Matte Black. Additional metal finishes are available, see options.		TBCO TBSW TSTV TSMV TSLV TOBW WBO WMO WSO		GAC LP01 LW01 GEC LP02 LW02 GOC LF01 LW04 GAM LF02 LW05 GCM LF03 LW06 GWM LN01 LW07 GNW LA01 + 20% GWL LA02 + 20% GSTV +10% GSLV +10%		MAC MEC MOC MGW MSW MTW MWL	
2 Select a finish <a href="#">View finish details</a>		Flat-1 Flat-2 Flat-3 (Black) (White)		Flat-1 Flat-2 Flat-3 (Black) (White)		Flat-1 Flat-2 Flat-3 (Black) (White)		Flat-1 Flat-2 Flat-3 (Black) (White)	
3 Select an edge <a href="#">View edge details</a>		Hardware N/A		Hardware N/A		Hardware N/A		Hardware N/A	
4 Select hardware <a href="#">View hardware details</a>									

[View statement of line](#)

## Product features.

- 1" Thick top
- ENVI-CT Finish on wood tops
- Easy to use folding mechanism
- Matte black metal finish base standard
- 2 locking casters, 2 non-locking casters

## Options.

### PREMIUM METAL FINISHES

- Specify Top Horn and Leg Metal Finish Color: \$300
- MFW: White, MFS: Silver, MFGG: Graphite Gray, MFSS: Salmon Sienna, MFSA: Surfin Aquavert, MFPS: Pistachio, MFOS: Oyster, MFNA: Navy, MFOL: Olive, MFGB: Grey Beige

### COVE DAISYLINK POWER

#### Power Pod

- PD-Cove-PKO-TT: Cove Power Unit with 2 power, 2 USB and 1 telecom plate - \$435

#### Infeed

- PFC72: 72" 3 prong plug power infeed - \$225
- PFHRD120: 120" hardwire whip power infeed - \$210

#### Jumper

- JCTT84: Jumper for 84" worksurfaces - \$145
- JCTT72: Jumper for 72" worksurfaces - \$135
- JCTT66: Jumper for 66" worksurfaces - \$130
- JCTT60: Jumper for 60" worksurfaces - \$125
- JCTT54: Jumper for 54" worksurfaces - \$120
- JCTT48: Jumper for 48" worksurfaces - \$115
- JCTT42: Jumper for 48" worksurfaces - \$110

#### Telecom Plate

- RJ45 (1) - \$35, RJ45 (2) - \$70, RJ45 (3) - \$105, USB (1) - \$70, USB (2) - \$140, RJ45/USB - \$105, RJ45/HDMI - \$190, HDMI/USB - \$205

# Edgeworks.

Training table  
Rectangular Top

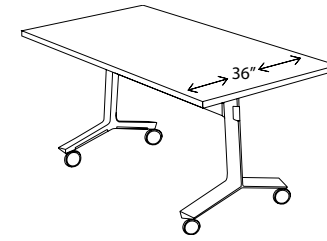

1 Select a model w" x d" x h"	weight	Standard Veneer Top Matte Black Metal Base		Premium Veneer Top Matte Black Metal Frame		High Pressure Laminate Top Matte Black Metal Base		Thermally Fused Laminate Top Matte Black Metal Base	
		84 x 36 x 28.5	260	EDG8436FN121W	2558	EDG8436FN121P	2814	EDG8436FN121G	2378
72 x 36 x 28.5	245	EDG7236FN121W	2520	EDG7236FN121P	2772	EDG7236FN121G	2353	EDG7236FN121M	2009
66 x 36 x 28.5	230	EDG6636FN121W	2480	EDG6636FN121P	2728	EDG6636FN121G	2319	EDG6636FN121M	1975
60 x 36 x 28.5	215	EDG6036FN121W	2461	EDG6036FN121P	2707	EDG6036FN121G	2307	EDG6036FN121M	1962
54 x 36 x 28.5	200	EDG5436FN121W	2421	EDG5436FN121P	2663	EDG5436FN121G	2273	EDG5436FN121M	1929
48 x 36 x 28.5	185	EDG4836FN121W	2402	EDG4836FN121P	2642	EDG4836FN121G	2261	EDG4836FN121M	1916
42 x 36 x 28.5	170	EDG4236FN121W	2363	EDG4236FN121P	2599	EDG4236FN121G	2227	EDG4236FN121M	1883

2 Select a finish <i>View finish details</i>		3 Select an edge <i>View edge details</i>	
Metal finish MFMB Matte Black. Additional metal finishes are available, see options.	WLA WNW WAC WWP WEC WOC WAM WCM WWM WGW WBW WSW	Flat-1 Flat-2 (Black) Flat-3 (White)	Flat-1 Flat-2 (Black) Flat-3 (White)
	TBCO TBSW TSTV TSMV TSLV TOBW WBO WMO WSO	Flat-1 Flat-2 (Black) Flat-3 (White)	Flat-1 Flat-2 (Black) Flat-3 (White)
	GAC LP01 LW01 GEC LP02 LW02 GOC LF01 LW04 GAM LF02 LW05 GCM LF03 LW06 GWM LN01 LW07 GNW LA01 + 20% GWL LA02 + 20% GSTV +10% GSLV +10%	Flat-1 Flat-2 (Black) Flat-3 (White)	Flat-1 Flat-2 (Black) Flat-3 (White)
	MAC MEC MOC MGW MSW MTW MWL	Flat-1 Flat-2 (Black) Flat-3 (White)	Flat-1 Flat-2 (Black) Flat-3 (White)
	Hardware N/A	Hardware N/A	Hardware N/A

*View statement of line*

## Product features.

- 1" Thick top
- ENVI-CT Finish on wood tops
- Easy to use folding mechanism
- Matte black metal finish base standard
- 2 locking casters, 2 non-locking casters

## Options.

### PREMIUM METAL FINISHES

- Specify Top Horn and Leg Metal Finish Color: \$300
- MFW: White, MFS: Silver, MFGG: Graphite Gray, MFSS: Salmon Sienna, MFSA: Surfin Aquavert, MFPS: Pistachio, MFOS: Oyster, MFNA: Navy, MFOL: Olive, MFGB: Grey Beige

### COVE DAISYLINK POWER

#### Power Pod

- PD-Cove-PKO-TT: Cove Power Unit with 2 power, 2 USB and 1 telecom plate - \$435

#### Infeed

- PFC72: 72" 3 prong plug power infeed - \$225
- PFHRD120: 120" hardwire whip power infeed - \$210

#### Jumper

- JCTT84: Jumper for 84" worksurfaces - \$145
- JCTT72: Jumper for 72" worksurfaces - \$135
- JCTT66: Jumper for 66" worksurfaces - \$130
- JCTT60: Jumper for 60" worksurfaces - \$125
- JCTT54: Jumper for 54" worksurfaces - \$120
- JCTT48: Jumper for 48" worksurfaces - \$115
- JCTT42: Jumper for 48" worksurfaces - \$110

#### Telecom Plate

- RJ45 (1) - \$35, RJ45 (2) - \$70, RJ45 (3) - \$105, USB (1) - \$70, USB (2) - \$140, RJ45/USB - \$105, RJ45/HDMI - \$190, HDMI/USB - \$205

# Edgeworks.

Training table  
Half Round Top

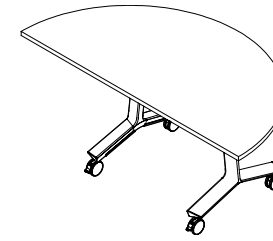

1 Select a model w" x d" x h"	weight	Standard Veneer Top Matte Black Metal Base		Premium Veneer Top Matte Black Metal Frame		High Pressure Laminate Top Matte Black Metal Base		Thermally Fused Laminate Top Matte Black Metal Base	
		<p><b>Use with 36" depth tops back to back</b></p> <p>72 x 36 x 28.5    230    EDG7236HR121W    2520</p> <p><b>Use with 30" depth tops back to back</b></p> <p>60 x 30 x 28.5    185    EDG6030HR121W    2289</p> <p>48 x 30 x 28.5    170    EDG4830HR121W    2064</p>		<p>EDG7236HR121P    2772</p> <p>EDG6030HR121P    2518</p> <p>EDG4830HR121P    2270</p>	<p>EDG7236HR121G    2353</p> <p>EDG6030HR121G    2157</p> <p>EDG4830HR121G    1959</p>	<p>EDG7236HR121M    2009</p> <p>EDG6030HR121M    1870</p> <p>EDG4830HR121M    1739</p>			
<p>2 Select a finish <i>View finish details</i></p> <p>Metal finish MFMB Matte Black. Additional metal finishes are available, see options.</p>	<p>WLA    WNW WAC    WWP WEC WOC WAM WCM WWM WGW WBW WSW</p>	<p>TBCO TBSW TSTV TSMV TSLV TOBW WBO WMO WSO</p>	<p>GAC    LP01    LW01 GEC    LP02    LW02 GOC    LF01    LW04 GAM    LF02    LW05 GCM    LF03    LW06 GWM    LN01    LW07 GNW    LA01 + 20% GWL    LA02 + 20% GSTV +10% GSLV +10%</p>	<p>MAC MEC MOC MGW MSW MTW MWL</p>	<p>3 Select a edge <i>View edge details</i></p> <p>Flat-1    Flat-2 (Black)    Flat-3 (White)</p>	<p>Flat-1    Flat-2 (Black)    Flat-3 (White)</p>	<p>Flat-1    Flat-2 (Black)    Flat-3 (White)</p>	<p>Flat-1    Flat-2 (Black)    Flat-3 (White)</p>	
<p>4 Select hardware <i>View hardware details</i></p>	<p>Hardware N/A</p>	<p>Hardware N/A</p>	<p>Hardware N/A</p>	<p>Hardware N/A</p>					

[View statement of line](#)

## Product features.

- 1" Thick top
- ENVI-CT Finish on wood tops
- Easy to use folding mechanism
- Matte black metal finish base standard
- 2 locking casters, 2 non-locking casters

## Options.

### PREMIUM METAL FINISHES

- Specify Top Horn and Leg Metal Finish Color: \$300
- MFW: White, MFS: Silver, MFGG: Graphite Gray, MFSS: Salmon Sienna, MFSA: Surfin Aquavert, MFPS: Pistachio, MFOS: Oyster, MFNA: Navy, MFOL: Olive, MFGB: Grey Beige

### COVE DAISYLINK POWER

- Power Pod
- PD-Cove-PKO-TT: Cove Power Unit with 2 power, 2 USB and 1 telecom plate - \$435

### INFEEED

- PFC72: 72" 3 prong plug power infeed - \$225
- PFHRD120: 120" hardwire whip power infeed - \$210

### JUMPER

- JCTT84: Jumper for 84" worksurfaces - \$145
- JCTT72: Jumper for 72" worksurfaces - \$135
- JCTT66: Jumper for 66" worksurfaces - \$130
- JCTT60: Jumper for 60" worksurfaces - \$125
- JCTT54: Jumper for 54" worksurfaces - \$120
- JCTT48: Jumper for 48" worksurfaces - \$115
- JCTT42: Jumper for 48" worksurfaces - \$110

### TELECOM PLATE

- RJ45 (1) - \$35, RJ45 (2) - \$70, RJ45 (3) - \$105, USB (1) - \$70, USB (2) - \$140, RJ45/USB - \$105, RJ45/HDMI - \$190, HDMI/USB - \$205

# Edgeworks.

Training Table Top  
Corner Top

Top view

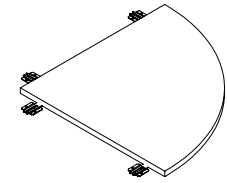
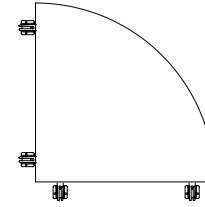

## 1 Select a model

w" x d" x h"

weight	Standard Veneer Top	Premium Veneer Top	High Pressure Laminate Top	Thermally Fused Laminate Top
36 x 36	35 EDG3636CT121W 675	EDG3636CT121P 743	EDG3636CT121G 574	EDG3636CT121M 428
30 x 30	25 EDG3030CT121W 640	EDG3030CT121P 704	EDG3030CT121G 544	EDG3030CT121M 410
24 x 24	20 EDG2424CT121W 605	EDG2424CT121P 666	EDG2424CT121G 515	EDG2424CT121M 392

*View statement of line*

## Product features.

- 1" Thick top
- ENVI-CT Finish on wood tops

### NOTES

- Corner tops connect with ganging device

## 2 Select a finish

*View finish details*

WLA WNW  
WAC WWP  
WEC  
WOC  
WAM  
WCM  
WWM  
WGW  
WBW  
WSW

TBCO  
TBSW  
TSTV  
TSMV  
TSLV  
TOBW  
WBO  
WMO  
WSO

GAC LP01 LW01  
GEC LP02 LW02  
GOC LF01 LW04  
GAM LF02 LW05  
GCM LF03 LW06  
GWM LN01 LW07  
GNW LA01 + 20%  
GWL LA02 + 20%  
GSTV +10%  
GSLV +10%

MAC  
MEC  
MOC  
MGW  
MSW  
MTW  
MWL

## 3 Select a edge

*View edge details*

Flat-1  
 Flat-2 (Black)  
 Flat-3 (White)

Flat-1  
 Flat-2 (Black)  
 Flat-3 (White)

Flat-1  
 Flat-2 (Black)  
 Flat-3 (White)

Flat-1  
 Flat-2 (Black)  
 Flat-3 (White)

## 4 Select hardware

*View hardware details*

Hardware  
N/A

Hardware  
N/A

Hardware  
N/A

Hardware  
N/A

# Edgeworks.

Privacy Screen  
Folding modesty

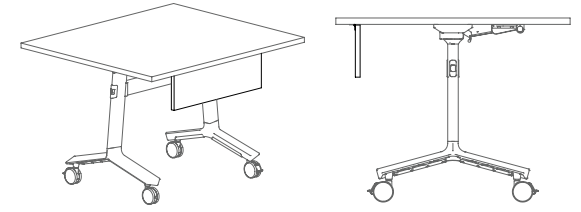

[View statement of line](#)

1 Select a model		Frosted Acrylic Privacy Screen	High Pressure Laminate Screen	Thermally Fused Laminate Screen
w" x d" x h"	weight			
<b>For 84" &amp; 72" Worksurfaces</b>				
57 x .75 x 8	8	EDG5708MS588A 260	EDG5708MS588G 270	EDG5708MS588M 220
<b>For 66" &amp; 60" Worksurfaces</b>				
46 x .75 x 8	7	EDG4608MS588A 235	EDG4608MS588G 260	EDG4608MS588M 210
<b>For 54" &amp; 48" Worksurfaces</b>				
35 x .75 x 8	6	EDG3508MS588A 210	EDG3508MS588G 250	EDG3508MS588M 200
<b>For 42" Worksurfaces</b>				
24 x .75 x 8	5	EDG2408MS588A 185	EDG2408MS588G 240	EDG2408MS588M 190
2 Select a finish		AF	GAC LP01 LW01 GEC LP02 LW02 GOC LF01 LW04 GAM LF02 LW05 GCM LF03 LW06 GWM LN01 LW07 GNW LA01 + 20% GWL LA02 + 20% GSTV +10% GSLV +10%	MAC MEC MOC MGW MSW MTW MWL
View finish details				
3 Select an edge		Edge N/A	Edge N/A	Edge N/A
View edge details				
4 Hardware		N/A	Hardware N/A	Hardware N/A
View hardware details				

## Product features.

- 3/4" Thick modesty

### NOTES

- When using the folding mechanism the modesty swings down to align with the top. Allowing the tables to nest while stowed away



# Edgeworks.

Full Pedestal Credenzas  
Storage Credenza

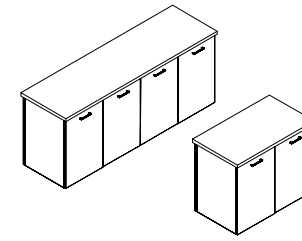

[View statement of line](#)

1 Select a model w" x d" x h"	weight	Standard Veneer Top	Premium Veneer Top	High Pressure Laminate Top	Thermally Fused Laminate Top
		Standard Veneer Chassis	Premium Veneer Chassis	Standard Veneer Chassis	Thermally Fused Laminate Chassis
<b>Double Storage</b>					
72 x 24 x 29		EDG7224CA125W 3259	EDG7224CA125P 3585	EDG7224CA125G 3259	EDG7224CA125M 2021
66 x 24 x 29		EDG6624CA125W 3031	EDG6624CA125P 3334	EDG6624CA125G 3031	EDG6624CA125M 1969
60 x 24 x 29		EDG6024CA125W 2932	EDG6024CA125P 3226	EDG6024CA125G 2932	EDG6024CA125M 1905
<b>Single Storage</b>					
36 x 24 x 29		EDG3624CA125W 1838	EDG3624CA125P 2022	EDG3624CA125G 1838	EDG3624CA125M 1245
2 Select a finish <a href="#">View finish details</a>		WLA WNW	TBCO	GAC GSLV +10%	MAC
		WAC WWP	TBSW	GEC GWL	MEC
		WEC	TSTV	GOC	MOC
		WOC	TSMV	GAM	MGW
		WAM	TSLV	GCM	MSW
		WCM	TOBW	GWM	MTW
		WWM	WBO	GNW	MWL
		WGW	WMO	GSTV	
		WBW	WSO	+10%	
		WSW			
3 Select a edge <a href="#">View edge details</a>		Flat-1 Flat-2 (Black) Flat-3 (White)	Flat-1 Flat-2 (Black) Flat-3 (White)	Flat-1 Flat-2 (Black) Flat-3 (White)	Flat-1 Flat-2 (Black) Flat-3 (White)
			Ledge-1 (Finished) Ledge-2 (Black) Ledge-3 (White)		
4 Select hardware <a href="#">View hardware details</a>		PL-115 Matte Black PL-116 Matte Nickel	PL-115 Matte Black PL-116 Matte Nickel	PL-115 Matte Black PL-116 Matte Nickel	PL-115 Matte Black PL-116 Matte Nickel
		PL-210 Anodized Aluminum	PL-210 Anodized Aluminum	PL-210 Anodized Aluminum	PL-210 Anodized Aluminum
		PL-260 Anodized Aluminum PL-261 White	PL-260 Anodized Aluminum PL-261 White	PL-260 Anodized Aluminum PL-261 White	PL-260 Anodized Aluminum PL-261 White

## Product features.

- Black adjustable shelf behind door set

### NOTES

- "M" Styles have matching "M" Finish Shelf
- All units are standard w/ flush ends
- Unit not designed for open plan use, standard with unfinished back. Select OPB Option for Open Plan application.

## Options.

### DOOR

- D2: Door Lock - \$100 per door set
- D6: Delete doors - n/c
- D6A: "W"/"G" Styles - Delete Doors and replace black laminate shelf with finished shelf - n/c
- D9SC: Soft Close Door Hinges - \$20 per door
- WPD3061: Designer White - \$80 per door

### GROMMETS (STANDARD LOCATION)

- Specify Color and Location Right/Left - \$50 ea.
- Black: TM30-R (Right), TM30-L (Left), TM30-C (Center)
  - Silver: TM31-R (Right), TM31-L (Left), TM31-C (Center)
  - White: TM34-R (Right), TM34-L (Left), TM34-C (Center)

### GROMMETS (NON-STANDARD LOCATION)

- Provide drawing w/ Grommet Location and Specify Color - \$95 ea.
- Black: TM30-NS
  - Silver: TM31-NS
  - White: TM34-NS

### GROMMETS (VERTICAL SURFACE)

- Standard Location - \$50 ea.
- Black Plastic Vertical Surface: TM50-C (Bottom Center)

### NON-STANDARD LOCATION - \$95 EA.

#NAME?

OPEN PLAN – FINISHED BACK

- OPB: "W" "G" Style - Modify Unit for Open Plan Application - \$195
- OPB: "M" Style - Modify Unit for Open Plan Application - \$95 Shelf
- S25: Replace Black Laminate Shelf with Finished Shelf - \$80 per shelf ("W" styles only)

# Edgeworks.

Pedestals

Open Plan Mobile Desk Pedestal With Casters

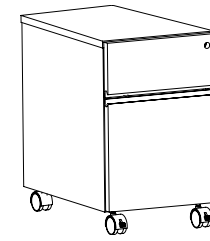

[View statement of line](#)

1 Select a model w" x d" x h"	weight	Standard Veneer Top Standard Veneer Chassis		Premium Veneer Top Premium Veneer Chassis		High Pressure Laminate Top Standard Veneer Chassis		Thermally Fused Laminate Top Thermally Fused Laminate Chassis	
		<b>Box/File Pedestal</b> 16 x 18 x 22	55	EDG1618PD423W	1201	EDG1618PD423P	1322	"G" Option N/A	
<b>2 Select a finish</b> <a href="#">View finish details</a>		WLA WAC WEC WOC WAM WCM WWM WGW WBW WSW	WNW WWP	TBCO TBSW TSTV TSMV TSLV TOBW WBO WMO WSO		GAC GEC GOC GAM GCM GWM GNW GSTV +10%	GSLV +10% GWL	MAC MEC MOC MGW MSW MTW MWL	
<b>3 Select a edge</b> <a href="#">View edge details</a>		Flat-1 Flat-2 (Black) Flat-3 (White) Ledge-1 (Finished) Ledge-2 (Black) Ledge-3 (White)		Flat-1 Flat-2 (Black) Flat-3 (White) Ledge-1 (Finished) Ledge-2 (Black) Ledge-3 (White)		Flat-1 Flat-2 (Black) Flat-3 (White) Ledge-1 (Finished) Ledge-2 (Black) Ledge-3 (White)		Flat-1 Flat-2 (Black) Flat-3 (White) Ledge-1 (Finished) Ledge-2 (Black) Ledge-3 (White)	
<b>4 Select hardware</b> <a href="#">View hardware details</a>		PL-115 Matte Black PL-116 Matte Nickel PL-260 Anodized Aluminum PL-261 White	PL-210 Anodized Aluminum Finger Pull "W"/"G"	PL-115 Matte Black PL-116 Matte Nickel PL-260 Anodized Aluminum PL-261 White	PL-210 Anodized Aluminum Finger Pull "W"/"G"	PL-115 Matte Black PL-116 Matte Nickel PL-260 Anodized Aluminum PL-261 White	PL-210 Anodized Aluminum Finger Pull "W"/"G"	PL-115 Matte Black PL-116 Matte Nickel PL-260 Anodized Aluminum PL-261 White	PL-210 Anodized Aluminum Finger Pull "W"/"G"

## Product features.

- Anti-tilt safety feature
- Finished all sides and top - open plan
- Full extension drawers - locking
- 3" Hollow wheel caster

## Options.

### CUSHION

- BC16: Bench Cushion
- Specify fabric grade (1 yd. required)

### DRAWER

- P33: Wood Drawer Upgrade - \$45 per drawer

## BC16 Cushion fabric grades.

COM	COL	1	2	3
224	N/A	261	279	297
4	5	6	7	8
315	333	351	369	387
9	10	11/L1	12	13/L2
405	423	441	459	495

# Edgeworks.

Pedestals

Open Plan Mini Mobile Desk Pedestal With Casters

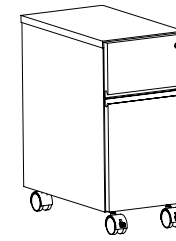

1 Select a model w" x d" x h"	weight	Standard Veneer Top Standard Veneer Chassis		Premium Veneer Top Premium Veneer Chassis		High Pressure Laminate Top Standard Veneer Chassis		Thermally Fused Laminate Top Thermally Fused Laminate Chassis	
		<b>Box/File Mini Pedestal</b> 10 x 18 x 22	40	EDG1018PD423W	1141	EDG1018PD423P	1256	"G" Option N/A	

2 Select a finish <i>View finish details</i>	Standard Veneer Top		Premium Veneer Top		High Pressure Laminate Top		Thermally Fused Laminate Top	
	<i>View finish details</i>	WLA WAC WEC WOC WAM WCM WWM WGW WBW WSW	WNW WWP	TBCO TBSW TSTV TSMV TSLV TOBW WBO WMO WSO		GAC GEC GOC GAM GCM GWM GNW GSTV +10%	GSLV +10% GWL	

3 Select a edge <i>View edge details</i>	Standard Veneer Top		Premium Veneer Top		High Pressure Laminate Top		Thermally Fused Laminate Top	
	<i>View edge details</i>	Flat-1 Flat-2 (Black) Flat-3 (White) Ledge-1 (Finished) Ledge-2 (Black) Ledge-3 (White)		Flat-1 Flat-2 (Black) Flat-3 (White) Ledge-1 (Finished) Ledge-2 (Black) Ledge-3 (White)		Flat-1 Flat-2 (Black) Flat-3 (White) Ledge-1 (Finished) Ledge-2 (Black) Ledge-3 (White)		Flat-1 Flat-2 (Black) Flat-3 (White)

4 Select hardware <i>View hardware details</i>	Standard Veneer Top		Premium Veneer Top		High Pressure Laminate Top		Thermally Fused Laminate Top	
	<i>View hardware details</i>	PL-115 Matte Black PL-116 Matte Nickel PL-260 Anodized Aluminum PL-261 White	PL-210 Anodized Aluminum Finger Pull "W"/"G"	PL-115 Matte Black PL-116 Matte Nickel PL-260 Anodized Aluminum PL-261 White	PL-210 Anodized Aluminum Finger Pull "W"/"G"	PL-115 Matte Black PL-116 Matte Nickel PL-260 Anodized Aluminum PL-261 White	PL-210 Anodized Aluminum Finger Pull "W"/"G"	PL-115 Matte Black PL-116 Matte Nickel PL-260 Anodized Aluminum PL-261 White

[View statement of line](#)

## Product features.

- Anti-tilt safety feature
- Finished all sides and top - open plan
- Full extension drawers - locking
- 3" Hollow wheel caster

## Options.

### CUSHION

- BC10: Bench Cushion
- Specify fabric grade (.5 yd. required)

### DRAWER

- P33: Wood Drawer Upgrade - \$45 per drawer

## BC10 Cushion fabric grades.

COM	COL	1	2	3
203	N/A	240	258	276
4	5	6	7	8
294	312	330	348	366
9	10	11/L1	12	13/L2
384	402	420	438	474

# Edgeworks.

Privacy Screen

Fabric Inline & Facing Screen

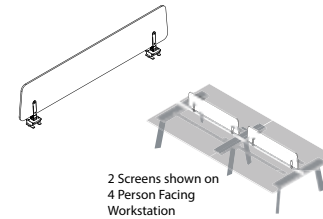

[View statement of line](#)

1	Select a model	weight	Privacy Screen
	w" x d" x h"		
	<b>Inline Workstation Screens</b>		
	42 x 1 x 12.75	10	EDG4213PIS603 475
	<b>Facing Workstation Central Screens</b>		
	42 x 1 x 12.75	10	EDG4213PFS603 475
2	Select a finish		MFMB
	<a href="#">View finish details</a>		
	<b>Metal finish</b>		
	MFMB Matte Black.		
	Additional metal finishes are available, see options.		
3	Select a edge		Edge
	<a href="#">View edge details</a>		N/A
4	Select hardware		Hardware
	<a href="#">View hardware details</a>		N/A

## Product features.

- Fabric panels are double sided with angled sides
- Panels are mounted on die cast space blocks between workstations
- Specify only one between two facing units
- Mounting brackets are matte black metal finish

## Options.

### PREMIUM METAL FINISHES

- Specify Screen Brackets Metal Finish Color: \$55
- MFW: White, MFS: Silver, MFGG: Graphite Gray, MFSS: Salmon Sienna, MFSA: Surfin Aquavert, MFPS: Pistachio, MFOS: Oyster, MFNA: Navy, MFOL: Olive, MFGB: Grey Beige

## Screen fabric grades.

COM	COL	1	2	3
463	N/A	523	553	583
4	5	6	7	8
613	643	673	703	733
9	10	11	12	13
763	793	823	853	913

# Edgeworks.

Privacy Screen  
Acrylic Inline & Facing Screen

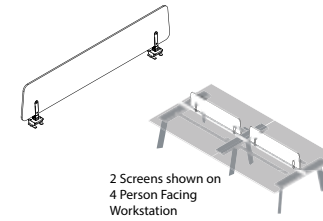

[View statement of line](#)

1 Select a model w" x d" x h"	weight	Privacy Screen			
<b>Inline Workstation Screens</b> 42 x .5 x 12.75	10	EDG4213PIS601 464			
<b>Facing Workstation Central Screens</b> 42 x .5 x 12.75	10	EDG4213PFS601 464			
<b>2 Select a finish</b> <a href="#">View finish details</a>  Metal finish MFMB Matte Black. Additional metal finishes are available, see options.		MFMB			
<b>3 Select a edge</b> <a href="#">View edge details</a>		Edge N/A			
<b>4 Select hardware</b> <a href="#">View hardware details</a>		Hardware N/A			

## Product features.

- Acrylic panels are double sided with angled sides
- Panels are mounted on die cast space blocks between workstations
- Specify only one between two facing units
- Acrylic panels are opaque white
- Mounting brackets are matte black metal finish

## Options.

### PREMIUM METAL FINISHES

- Specify Screen Brackets Metal Finish Color: \$55
- MFW: White, MFS: Silver, MFGG: Graphite Gray, MFSS: Salmon Sienna, MFSA: Surfin Aquavert, MFPS: Pistachio, MFOS: Oyster, MFNA: Navy, MFOL: Olive, MFGB: Grey Beige

# Edgeworks.

Privacy Screen

Acoustic Inline & Facing Central Screen

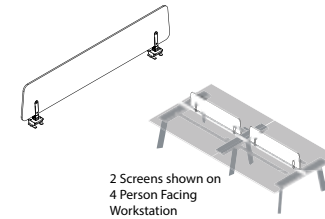

[View statement of line](#)

1	Select a model w" x d" x h"	weight	Privacy Screen			
	<b>Inline Workstation Screens</b>					
	42 x .5 x 12.75	10	EDG4213PIS602 536			
	<b>Facing Workstation Central Screens</b>					
	42 x .5 x 12.75	10	EDG4213PFS602 536			
2	Select a finish <a href="#">View finish details</a>		MFMB			
	<b>Metal finish</b> MFMB Matte Black. Additional metal finishes are available, see options.					
3	Select a edge <a href="#">View edge details</a>		Edge N/A			
4	Select acoustic color <a href="#">View hardware details</a>		SCG SHG			

## Product features.

- Acoustic panels are double sided with angled sides
- Panels are mounted on die cast space blocks between workstations
- Specify only one between two facing units
- Acoustic material panels are light gray
- Mounting brackets are matte black metal finish

## Options.

### PREMIUM METAL FINISHES

- Specify Screen Brackets Metal Finish Color: \$55
- MFW: White, MFS: Silver, MFGG: Graphite Gray, MFSS: Salmon Sienna, MFSA: Surfin Aquavert, MFPS: Pistachio, MFOS: Oyster, MFNA: Navy, MFOL: Olive, MFGB: Grey Beige

# Edgeworks.

Interpersonal Screen  
Fabric Interpersonal Screen

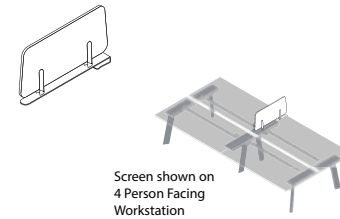

1 Select a model		Interpersonal Screen		<a href="#">View statement of line</a>	
w" x d" x h"	weight				
24 x .5 x 12.75	5	EDG2413PS603	317		

2 Select a finish					
	MFMB				
<a href="#">View finish details</a>					
<p><b>Metal finish</b> MFMB Matte Black. Additional metal finishes are available, see options.</p>					

3 Select a edge					
	Edge				
<a href="#">View edge details</a>	N/A				

4 Select hardware					
	Hardware				
<a href="#">View hardware details</a>	N/A				

## Product features.

- Fabric panels are double sided with angled sides
- Panels are mounted on die cast space blocks between workstations
- Specify only one between two facing units
- Mounting brackets are matte black metal finish

## Options.

### PREMIUM METAL FINISHES

- Specify Screen Brackets Metal Finish Color: \$55
- MFW: White, MFS: Silver, MFGG: Graphite Gray, MFSS: Salmon Sienna, MFSA: Surfin Aquavert, MFPS: Pistachio, MFOS: Oyster, MFNA: Navy, MFOL: Olive, MFGB: Grey Beige

## Screen fabric grades

COM	COL	1	2	3
313	N/A	353	373	393
4	5	6	7	8
413	433	453	473	493
9	10	11	12	13
513	533	553	573	613

# Edgeworks.

Interpersonal Screen  
*Acrylic Interpersonal Screen*

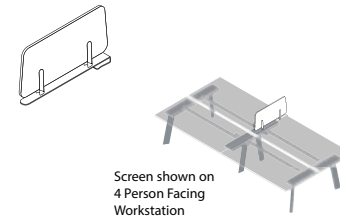

1 Select a model		Interpersonal Screen		<a href="#">View statement of line</a>	
w" x d" x h"	weight				
24 x .5 x 12.75	5	EDG2413PS604 311			
2 Select a finish		MFMB			
<a href="#">View finish details</a>					
Metal finish MFMB Matte Black. Additional metal finishes are available, see options.					
3 Select a edge		Edge N/A			
<a href="#">View edge details</a>					
4 Select hardware		Hardware N/A			
<a href="#">View hardware details</a>					

## Product features.

- Acrylic panels are double sided with angled sides
- Specify only one between two facing units
- Acrylic panels are opaque white
- Mounting brackets are matte black metal finish

## Options.

### PREMIUM METAL FINISHES

- Specify Screen Brackets Metal Finish Color: \$55
- MFW: White, MFS: Silver, MFGG: Graphite Gray, MFSS: Salmon Sienna, MFSA: Surfin Aquavert, MFPS: Pistachio, MFOS: Oyster, MFNA: Navy, MFOL: Olive, MFGB: Grey Beige



# Edgeworks.

Interpersonal Screen  
Acoustic Material Interpersonal Screen

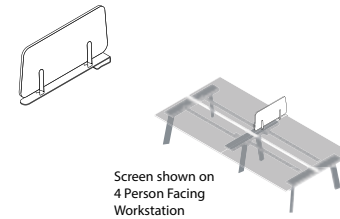

Screen shown on  
4 Person Facing  
Workstation

[View statement of line](#)

1	Select a model	Interpersonal Screen			
	w" x d" x h"				
	24 x .5 x 12.75	5	EDG2413PS602	361	
2	Select a finish	MFMB			
	<a href="#">View finish details</a>				
	Metal finish MFMB Matte Black. Additional metal finishes are available, see options.				
3	Select a edge	Edge N/A			
	<a href="#">View edge details</a>				
4	Select acoustic color	SCG SHG			
	<a href="#">View hardware details</a>				

## Product features.

- Acoustic panels are double sided with angled sides
- Panels are mounted on die cast space blocks between workstations
- Specify only one between two inline units
- Acoustic material panels are light gray
- Mounting brackets are matte black metal finish

## Options.

### PREMIUM METAL FINISHES

- Specify Screen Brackets Metal Finish Color: \$55
- MFW: White, MFS: Silver, MFGG: Graphite Gray, MFSS: Salmon Sienna, MFSA: Surfin Aquavert, MFPS: Pistachio, MFOS: Oyster, MFNA: Navy, MFOL: Olive, MFGB: Grey Beige

# Edgeworks.

Single Height Wall Hung Overheads  
14" D Panel Doors - 1/2 Section

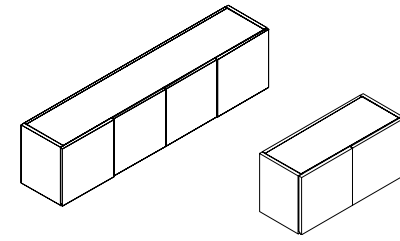

## 1 Select a model w" x d" x h"

weight	Standard Veneer		Premium Veneer		High Pressure Laminate		Thermally Fused Laminate	
<b>4 Door / 2 Section</b>								
78 x 14 x 18	195	EDG7818WH330W 2997	EDG7818WH330P	3297	"G" Option N/A	EDG7818WH330M	1578	
72 x 14 x 18	180	EDG7218WH330W 2506	EDG7218WH330P	2757	"G" Option N/A	EDG7218WH330M	1458	
66 x 14 x 18	160	EDG6618WH330W 2468	EDG6618WH330P	2715	"G" Option N/A	EDG6618WH330M	1414	
60 x 14 x 18	135	EDG6018WH330W 2429	EDG6018WH330P	2672	"G" Option N/A	EDG6018WH330M	1371	
48 x 14 x 18	125	EDG4818WH330W 1856	EDG4818WH330P	2042	"G" Option N/A	EDG4818WH330M	1305	
<b>2 Door / 1 Section</b>								
42 x 14 x 18	95	EDG4218WH330W 1624	EDG4218WH330P	1787	"G" Option N/A	EDG4218WH330M	1117	
36 x 14 x 18	75	EDG3618WH330W 1393	EDG3618WH330P	1533	"G" Option N/A	EDG3618WH330M	929	

*View statement of line*

## 2 Select a finish *View finish details*

- |     |     |
|-----|-----|
| WLA | WNW |
| WAC | WWP |
| WEC |     |
| WOC |     |
| WAM |     |
| WCM |     |
| WWM |     |
| WGW |     |
| WBW |     |
| WSW |     |

- TBCO  
TBSW  
TSTV  
TSMV  
TSLV  
TOBW  
WBO  
WMO  
WSO

- |      |           |
|------|-----------|
| GAC  | GSLV +10% |
| GEC  | GWL       |
| GOC  |           |
| GAM  |           |
| GCM  |           |
| GWM  |           |
| GNW  |           |
| GSTV |           |
| +10% |           |

- MAC  
MEC  
MOC  
MGW  
MSW  
MTW  
MWL

## 3 Select an edge *View edge details*

- Edge  
N/A

- Edge  
N/A

- Edge  
N/A

- Edge  
N/A

## 4 Select hardware *View hardware details*

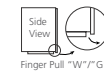
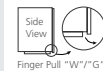
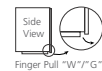

## Product features.

- Doors fully matched set
- Finished top
- Interior cabinet depth 12"
- Mounting wall rail included
- Panel doors with concealed finger pull

### NOTES

- All units are standard w/ flush ends
- Proper installation is critical to ensure safety from possible falling cabinets. The factory assumes no liability for damage or injury from The following: installation into non-load bearing or unlevel walls. Improper fasteners used in installation. Overloading of cabinets resulting in failures of wall and surrounding structures, fasteners, or cabinet construction. Misuse of cabinets for intended purposes.

## Options.

### DOOR

- D2: Door Lock - \$100 per door set
- D6: Delete doors - n/c
- D9SC: Soft Close Door Hinges - \$20 per door
- WPD3061: Designer White - \$80 per door

### RECESSED TASK LIGHT

- LT-LED24R: 24" LED Task light - \$190
- LT-LED48R: 48" LED Task light - \$245
- LT-LED60R: 60" LED Task light - \$310
- LT-LED72R: 72" LED Task light - \$335

# Edgeworks.

Single Height Wall Hung Overheads

14" D Silverluma Frame / Frosted Doors - 1/2 Section

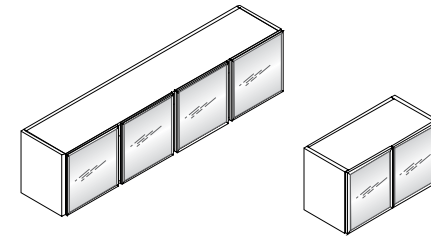

## 1 Select a model w" x d" x h"

weight	Standard Veneer		Premium Veneer		High Pressure Laminate		Thermally Fused Laminate	
<b>4 Door / 2 Section</b>								
78 x 14 x 18	195	EDG7818WH331W 3478	EDG7818WH331P 3826	"G" Option N/A	EDG7818WH331M 1846			
72 x 14 x 18	180	EDG7218WH331W 2905	EDG7218WH331P 3196	"G" Option N/A	EDG7218WH331M 1720			
66 x 14 x 18	160	EDG6618WH331W 2812	EDG6618WH331P 3094	"G" Option N/A	EDG6618WH331M 1676			
60 x 14 x 18	135	EDG6018WH331W 2725	EDG6018WH331P 2998	"G" Option N/A	EDG6018WH331M 1633			
48 x 14 x 18	125	EDG4818WH331W 2083	EDG4818WH331P 2292	"G" Option N/A	EDG4818WH331M 1572			
<b>2 Door / 1 Section</b>								
42 x 14 x 18	95	EDG4218WH331W 2001	EDG4218WH331P 2202	"G" Option N/A	EDG4218WH331M 1418			
36 x 14 x 18	75	EDG3618WH331W 1589	EDG3618WH331P 1748	"G" Option N/A	EDG3618WH331M 1038			
<b>2 Select a finish</b> <i>View finish details</i>								
	WLA	WNW	TBCO	GAC	GSLV +10%	MAC		
	WAC	WWP	TBSW	GEC	GWL	MEC		
	WEC		TSTV	GOC		MOC		
	WOC		TSMV	GAM		MGW		
	WAM		TSLV	GCM		MSW		
	WCM		TOBW	GWM		MTW		
	WWM		WBO	GNW		MWL		
	WGW		WMO	GSTV				
	WBW		WSO	+10%				
	WSW							
<b>3 Select an edge</b> <i>View edge details</i>								
	Edge		Edge	Edge		Edge		
	N/A		N/A	N/A		N/A		
<b>4 Select hardware</b> <i>View hardware details</i>								
								
		Finger Pull "W"/"G"		Finger Pull "W"/"G"		Finger Pull "W"/"G"		Finger Pull "W"/"G"

*View statement of line*

## Product features.

- Finished top
- Interior cabinet depth 12"
- Mounting wall rail included

### NOTES

- All units are standard w/ flush ends
- Proper installation is critical to ensure safety from possible falling cabinets. The factory assumes no liability for damage or injury from the following: installation into non-load bearing or unlevel walls. Improper fasteners used in installation. Overloading of cabinets resulting in failures of wall and surrounding structures, fasteners, or cabinet construction. Misuse of cabinets for intended purposes.

## Options.

### DOOR

- D2: Door Lock - \$100 per door set
- D9SC: Soft Close Door Hinges - \$20 per door
- DWF1: 2" Wood frame replaces SilverLuma Frame - n/c ("W" only)
- DWF2: 2" Wood frame w/ pull replaces SilverLuma Frame - \$20 per door ("W" only)

### INTERIOR CABINET LIGHT

- LEDPK starter kit includes Infeed, 1 Puck Interior Light and the ability to daisy chain up to 6 total Puck Lights
- LEDPK: LED Puck Starter Kit - \$310
- PK: 1 LED Interior Light - \$130 ea.

### RECESSED TASK LIGHT

- LT-LED24R: 24" LED Task light - \$190
- LT-LED48R: 48" LED Task light - \$245
- LT-LED60R: 60" LED Task light - \$310
- LT-LED72R: 72" LED Task light - \$335

# Edgeworks.

Single Height Wall Hung Overheads  
14" D Open Storage Cabinet - 1/2 Section

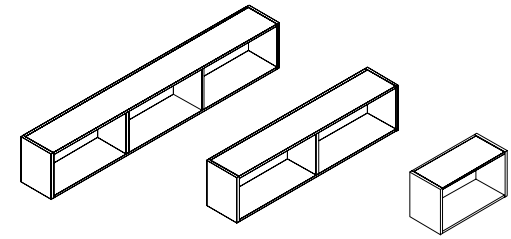

[View statement of line](#)

1 Select a model w" x d" x h"	weight	Standard Veneer		Premium Veneer		High Pressure Laminate		Thermally Fused Laminate	
<b>3 Section</b> 78 x 14 x 18	185	EDG7818WH332W	2905	EDG7818WH332P	3196	"G" Option N/A		EDG7818WH332M	1294
<b>2 Section</b> 72 x 14 x 18	170	EDG7218WH332W	2375	EDG7218WH332P	2613	"G" Option N/A		EDG7218WH332M	1223
66 x 14 x 18	150	EDG6618WH332W	2337	EDG6618WH332P	2571	"G" Option N/A		EDG6618WH332M	1185
60 x 14 x 18	125	EDG6018WH332W	2305	EDG6018WH332P	2536	"G" Option N/A		EDG6018WH332M	1141
48 x 14 x 18	115	EDG4818WH332W	1720	EDG4818WH332P	1892	"G" Option N/A		EDG4818WH332M	1075
<b>1 Section</b> 42 x 14 x 18	80	EDG4218WH332W	1507	EDG4218WH332P	1658	"G" Option N/A		EDG4218WH332M	939
36 x 14 x 18	60	EDG3618WH332W	1294	EDG3618WH332P	1424	"G" Option N/A		EDG3618WH332M	803
<b>2 Select a finish</b> <a href="#">View finish details</a>		WLA WNW WAC WWP WEC WOC WAM WCM WWM WGW WBW WSW		TBCO TBSW TSTV TSMV TSLV TOBW WBO WMO WSO		GAC GSLV +10% GEC GWL GOC GAM GCM GWM GNW GSTV +10%		MAC MEC MOC MGW MSW MTW MWL	
<b>3 Select an edge</b> <a href="#">View edge details</a>		Edge N/A		Edge N/A		Edge N/A		Edge N/A	
<b>4 Select hardware</b> <a href="#">View hardware details</a>		Hardware N/A		Hardware N/A		Hardware N/A		Hardware N/A	

## Product features.

- Finished top
- Interior cabinet depth 12"
- Mounting wall rail included

### NOTES

- 3 Section Overhead Available w/ 1 or 2 Sliding Doors
- 2 Section available w/ 1 sliding door
- All units are standard w/ flush ends
- Proper installation is critical to ensure safety from possible falling cabinets. The factory assumes no liability for damage or injury from The following: installation into non-load bearing or unlevel walls. Improper fasteners used in installation. Overloading of cabinets resulting in failures of wall and surrounding structures, fasteners, or cabinet construction. Misuse of cabinets for intended purposes.

## Options.

### DOOR

- Not available in 29" and 35"
- SLD17WD: Panel Door - \$260 per door
- SLD17LD: White Laminate Door - \$205 per door
- SLD17FD: SilverLuma / Frost Door - \$365 per door

### INTERIOR CABINET LIGHT

- LEDPK starter kit includes Infeed, 1 Puck Interior Light and the ability to daisy chain up to 6 total Puck Lights
- LEDPK: LED Puck Starter Kit - \$310
- PK: 1 LED Interior Light - \$130 ea.

### RECESSED TASK LIGHT

- LT-LED24R: 24" LED Task light - \$190
- LT-LED48R: 48" LED Task light - \$245
- LT-LED60R: 60" LED Task light - \$310
- LT-LED72R: 72" LED Task light - \$335

## EdgeWorks tackboards.

Wall hung tackboard  
Full width tackboards

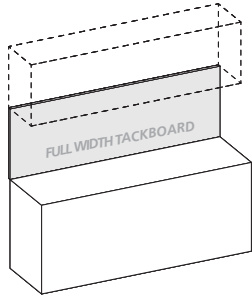

78	78 x .75 x 24	FTWH7824	388	474	519	564	608	653	698	743	787	832	877	921	966	1056
72	72 x .75 x 24	FTWH7224	355	437	478	520	562	603	645	686	728	770	811	853	894	978
66	66 x .75 x 24	FTWH6624	322	399	437	474	512	549	587	624	661	699	736	774	811	886
60	60 x .75 x 24	FTWH6024	294	362	395	428	462	495	528	562	595	628	661	695	728	795
48	48 x .75 x 24	FTWH4824	236	293	321	349	378	406	434	462	490	518	546	574	602	658
42	42 x .75 x 24	FTWH4224	206	256	281	305	330	354	379	402	427	451	476	500	525	574
36	36 x .75 x 24	FTWH3624	176	218	239	260	281	302	322	343	364	385	406	426	447	489

### Standard Features

- Constructed of .5" thick fiberboard
- Hung with Z-Strip mounting system

- Fabric is precisely aligned and fitted to the tackboard
- Adhered to the rigid hardboard with staples

Wall hung tackboard  
Half width tackboards

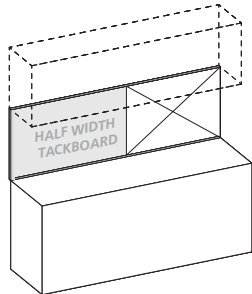

78 Half Width	39 x .75 x 24	FTWH3924	194	237	260	282	305	327	349	371	394	416	439	461	484	528
72 Half Width	36 x .75 x 24	FTWH3624	178	218	239	260	281	302	322	343	364	385	406	426	447	489
66 Half Width	33 x .75 x 24	FTWH3324	161	200	218	237	256	275	293	312	331	349	368	387	406	443

### Standard Features

- Constructed of .5" thick fiberboard
- Fabric is precisely aligned and fitted to the tackboard
- Adhered to the rigid hardboard with staples
- Hung with Z-Strip mounting system

### Notes

- Half width tackboards can be specified and combined with a Veneer Panel, Marker Board or Glass Board. See "Half Width" items under product width.
- Specify right or left facing tackboard

## EdgeWorks tackboards.

Wall hung dry marker board  
Full width dry marker board

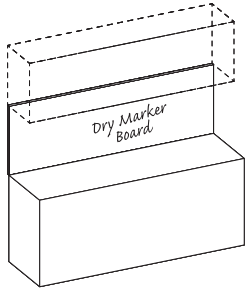

78	78 x .75 x 24	DMWH7824	948
72	72 x .75 x 24	DMWH7224	874
66	66 x .75 x 24	DMWH6624	799
60	60 x .75 x 24	DMWH6024	724
48	48 x .75 x 24	DMWH4824	587
42	42 x .75 x 24	DMWH4224	512
36	36 x .75 x 24	DMWH3624	437

### Standard Features

- Dry marker panel has edge trim molding
- Standard magnetic surface

- Hung with Z-Strip mounting system

Wall hung dry marker board  
Half width dry marker board

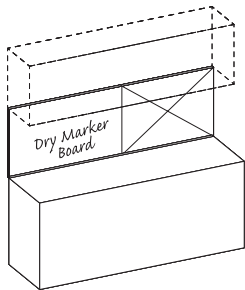

78 Half Width	39 x .75 x 24	DMWH3924	474
72 Half Width	36 x .75 x 24	DMWH3624	437
66 Half Width	33 x .75 x 24	DMWH3324	399

### Standard Features

- Dry marker panel has edge trim molding
- Standard magnetic surface
- Hung with Z-Strip mounting system

### Notes

- Half width dry marker boards can be specified and combined with a Tackboard, Veneer Panel or Glass Board. See "Half Width" items under product width.
- Specify right or left facing dry marker board

## EdgeWorks tackboards.

Wall hung veneer panel  
Full width veneer panel

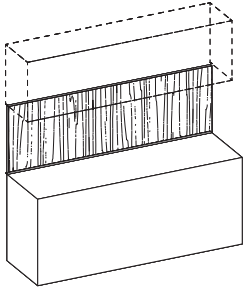

78	78 x .75 x 24	VPWH7824	790
72	72 x .75 x 24	VPWH7224	728
66	66 x .75 x 24	VPWH6624	666
60	60 x .75 x 24	VPWH6024	603
48	48 x .75 x 24	VPWH4824	489
42	42 x .75 x 24	VPWH4224	426
36	36 x .75 x 24	VPWH3624	364

### Standard Features

- Hung with Z-Strip mounting system

### Notes

- Veneer edges.
- Vertical wire channels on back for task light cords
- Steel mounting wall channel is recessed for flush mounting
- Can be used with or without overhead cabinet
- Required for other accessory panels

Wall hung veneer panel  
Half width veneer panel

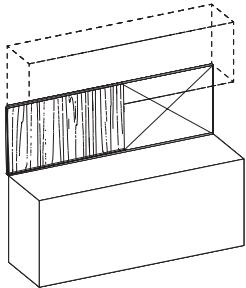

78 Half Width	39 x .75 x 24	VPWH3924	395
72 Half Width	36 x .75 x 24	VPWH3624	364
66 Half Width	33 x .75 x 24	VPWH3324	333

### Standard Features

- Veneer edges
- Vertical wire channels on back for task light cords
- Steel mounting wall channel is recessed for flush mounting
- Hung with Z-Strip mounting system

### Notes

- Half width veneer panels can be specified and combined with a Tackboard, Marker Board or Glass Board. See "Half Width" items under product width.
- Specify right or left facing veneer panel
- Can be used with or without overhead cabinet
- Required for other accessory panels

## EdgeWorks tackboards.

Wall hung glassboard  
Full width glassboard

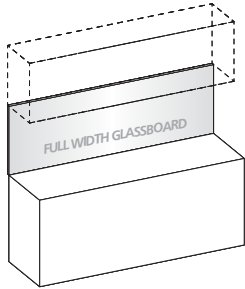

78	78 x .75 x 24	GBWH7824	2281
72	72 x .75 x 24	GBWH7224	2114
66	66 x .75 x 24	GBWH6624	1948
60	60 x .75 x 24	GBWH6024	1780
48	48 x .75 x 24	GBWH4824	1476
42	42 x .75 x 24	GBWH4224	1309
36	36 x .75 x 24	GBWH3624	1142

Standard Features  
- 4 mm tempered glass

Notes  
- Use glass cleaner or alcohol to clean  
- Standard dry erase markers may be used  
- Earth magnets are required to hold items securely in place  
- Hung with Z-Strip mounting system

Wall hung glassboard  
Half width glassboard

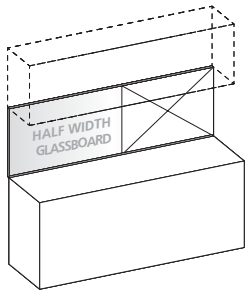

78 Half Width	39 x .75 x 24	GBWH3924	1232
72 Half Width	36 x .75 x 24	GBWH3624	1142
66 Half Width	33 x .75 x 24	GBWH3324	1059

Standard Features  
- 4 mm tempered glass  
- Hung with Z-Strip mounting system

Notes  
- Half width glassboards can be specified and combined with a Tackboard, Veneer panel or Marker Board. See "Half Width" items under product width.  
- Specify right or left facing glassboard  
- Use glass cleaner or alcohol to clean  
- Standard dry erase markers may be used  
- Earth magnets are required to hold items securely in place



# Edgeworks.

Metal Accessories

*Inline Worksurface Accessories*



Personal Tray

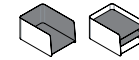

Document Pod & Paper Tray



Binder Pod

[View statement of line](#)

1 Select a model		weight	Accessory		
w" x d" x h"					
<b>Personal Tray</b>					
13 x 9 x 3	4	EA53	267		
<b>Document Pod &amp; Paper Tray</b>					
9 x 14 x 7	12	EA54	371		
<b>Binder Pod</b>					
9 x 14 x 12	12	EA55	289		

2 Select a finish		MFMB
<a href="#">View finish details</a>		
<b>Metal finish</b>		
MFMB Matte Black.		
Additional metal finishes are available, see options.		

3 Select a edge		Edge
<a href="#">View edge details</a>		N/A

4 Select hardware		Hardware
<a href="#">View hardware details</a>		N/A

## Product features.

- Metal accessories are mounted on die cast aluminum spacer blocks for inline workstations
- Accessories come standard in matte black powdercoat

## Options.

### PREMIUM METAL FINISHES

- Specify Accessory Brackets Metal Finish Color: \$55 ea. and/or Accessory Metal Finish Color: \$100 ea.
- MFW: White, MFS: Silver, MFGG: Graphite Gray, MFSS: Salmon Sienna, MFSA: Surfin Aquavert, MFPS: Pistachio, MFOS: Oyster, MFNA: Navy, MFOL: Olive, MFGB: Grey Beige

# Edgeworks.

Metal Accessories

Facing Workstation Accessories



Personal Tray

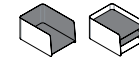

Document Pod & Paper Tray



Binder Pod

[View statement of line](#)

1 Select a model		weight	Accessory		
w" x d" x h"					
<b>Personal Tray</b>					
13 x 9 x 3	4	EA50	267		
<b>Document Pod &amp; Paper Tray</b>					
9 x 14 x 7	12	EA51	371		
<b>Binder Pod</b>					
9 x 14 x 12	12	EA52	289		

2 Select a finish		MFMB
<a href="#">View finish details</a>		
<p><b>Metal finish</b>                      MFMB Matte Black.                      Additional metal finishes are available, see options.</p>		

3 Select a edge		Edge
<a href="#">View edge details</a>		N/A

4 Select hardware		Hardware
<a href="#">View hardware details</a>		N/A

## Product features.

- Metal accessories are center mounted on die cast aluminum spacer blocks for facing workstations
- Accessories come standard in matte black powdercoat

## Options.

### PREMIUM METAL FINISHES

- Specify Accessory Brackets Metal Finish Color: \$55 ea. and/or Accessory Metal Finish Color: \$100 ea.
- MFW: White, MFS: Silver, MFGG: Graphite Gray, MFSS: Salmon Sienna, MFSA: Surfin Aquavert, MFPS: Pistachio, MFOS: Oyster, MFNA: Navy, MFOL: Olive, MFGB: Grey Beige

# Edgeworks.

Conference Tables  
Round Frameless

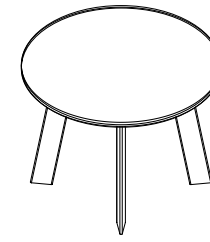

1 Select a model w" x d" x h"	weight	Standard Veneer Top Matte Black Metal Base		Premium Veneer Top Matte Black Metal Base		High Pressure Laminate Top Matte Black Metal Base		Thermally Fused Laminate Top Matte Black Metal Base	
		<b>Sitting Height</b>							
54 DIA x 29	85	EDG5454RD121W	3227	EDG5454RD121P	3550	EDG5454RD121G	3036	EDG5454RD121M	2582
48 DIA x 29	105	EDG4848RD121W	2954	EDG4848RD121P	3249	EDG4848RD121G	2779	EDG4848RD121M	2419
42 DIA x 29	95	EDG4242RD121W	2927	EDG4242RD121P	3220	EDG4242RD121G	2757	EDG4242RD121M	2386
<b>Standing Height</b>									
54 DIA x 42	95	EDG5454RD141W	3511	EDG5454RD141P	3863	EDG5454RD141G	3320	EDG5454RD141M	2866
48 DIA x 42	115	EDG4848RD141W	3238	EDG4848RD141P	3562	EDG4848RD141G	3063	EDG4848RD141M	2703
42 DIA x 42	105	EDG4242RD141W	3210	EDG4242RD141P	3531	EDG4242RD141G	3041	EDG4242RD141M	2670
<b>2 Select a finish</b> <i>View finish details</i>		WLA WNW WAC WWP WEC WOC WAM WCM WWM WGW WBW WSW		TBCO TBSW TSTV TSMV TSLV TOBW WBO WMO WSO		GAC GSWL +10% GEC GWL GOC GAM GCM GWM GNW GSTV +10%		MAC MEC MOC MGW MSW MTW MWL	
<b>3 Select an edge</b> <i>View edge details</i>		Flat-1 Flat-2 (Black) Flat-3 (White) Ledge-1 (Finished) Ledge-2 (Black) Ledge-3 (White)		Flat-1 Flat-2 (Black) Flat-3 (White) Ledge-1 (Finished) Ledge-2 (Black) Ledge-3 (White)		Flat-1 Flat-2 (Black) Flat-3 (White) Ledge-1 (Finished) Ledge-2 (Black) Ledge-3 (White)		Flat-1 Flat-2 (Black) Flat-3 (White)	
<b>4 Select hardware</b> <i>View hardware details</i>		Hardware N/A		Hardware N/A		Hardware N/A		Hardware N/A	

[View statement of line](#)

## Product features.

- 1" Thick top
- ENVI-CT finish on wood tops
- Matte black metal finish base standard
- 3" Adjustable glide

## Options.

### POWER

- Two pods mounted under the hinged seamless grommet. Each pod has 4 power and 2 data ports. Telecom connectors sold separately.
- PSG82-C: Plug with 124" cord (8 power, 2 telecom plates) - \$1875 each
- W21: Grey Wire Manager (10.5") - \$35 ea.

### PREMIUM METAL FINISHES

- Specify Top Horn and Leg Metal Finish Color: \$630
- MFW: White, MFS: Silver, MFGG: Graphite Gray, MFSS: Salmon Sienna, MFSA: Surfin Aquavert, MFPS: Pistachio, MFOS: Oyster, MFNA: Navy, MFOL: Olive, MFGB: Grey Beige



### PLANK MATCH VENEER

- RPMV: Random Walnut Plank Match Veneer (Horizontal Grain with 25%+ Sap) - Add 10%. Clear coat only.

# Edgeworks.

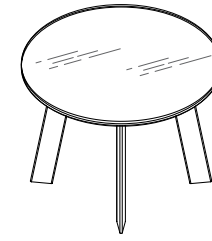
Glass Conference Tables  
Round Frameless



1 Select a model w" x d" x h"	weight	Clear Gloss Glass Top Matte Black Metal Base		White Gloss Glass Top Matte Black Metal Base		Black Gloss Glass Top Matte Black Metal Base	
		<b>Sitting Height</b>					
54 DIA x 29	85	EDG5454RD121SC	4554	EDG5454RD121SW	6212	EDG5454RD121SB	6212
48 DIA x 29	105	EDG4848RD121SC	4002	EDG4848RD121SW	5312	EDG4848RD121SB	5312
42 DIA x 29	95	EDG4242RD121SC	3729	EDG4242RD121SW	4733	EDG4242RD121SB	4733
<b>Standing Height</b>							
54 DIA x 42	95	EDG5454RD141SC	4838	EDG5454RD141SW	6496	EDG5454RD141SB	6496
48 DIA x 42	115	EDG4848RD141SC	4286	EDG4848RD141SW	5596	EDG4848RD141SB	5596
42 DIA x 42	105	EDG4242RD141SC	4013	EDG4242RD141SW	5017	EDG4242RD141SB	5017
2 Select a finish <i>View finish details</i>		MFMB		MFMB		MFMB	
Metal finish MFMB Matte Black. Additional metal finishes are available, see options.							
3 Select an edge <i>View edge details</i>							
4 Select hardware <i>View hardware details</i>		Hardware N/A		Hardware N/A		Hardware N/A	

[View statement of line](#)

## Product features.

- 1/2" Clear glass top
- Matte black metal finish base standard
- 3" Adjustable glide
- Wood subtop underneath glass
- Glass tops are gloss finish, see options for Soft Etch Glass tops

## Options.

### PREMIUM METAL FINISHES

- Specify Top Horn and Leg Metal Finish Color: \$630
- MFW: White, MFS: Silver, MFGG: Graphite Gray, MFSS: Salmon Sienna, MFSA: Surfin Aquavert, MFPS: Pistachio, MFOS: Oyster, MFNA: Navy, MFOL: Olive, MFGB: Grey Beige

### GLASS FINISH

- Optional Soft Etch Finished glass
- EB: Black Soft Etch Glass, EW: White Soft Etch Glass - n/c

# Edgeworks.

Conference Tables  
Square Frameless

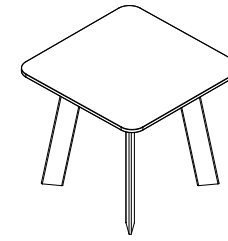

## 1 Select a model

w" x d" x h"

weight	Standard Veneer Top Matte Black Metal Base		Premium Veneer Top Matte Black Metal Base		High Pressure Laminate Top Matte Black Metal Base		Thermally Fused Laminate Top Matte Black Metal Base	
<b>Sitting Height</b>								
54 x 54 x 29	130	EDG5454SQ121W 3227	EDG5454SQ121P 3550		EDG5454SQ121G 3036		EDG5454SQ121M 2582	
48 x 48 x 29	110	EDG4848SQ121W 2954	EDG4848SQ121P 3249		EDG4848SQ121G 2779		EDG4848SQ121M 2419	
42 x 42 x 29	100	EDG4242SQ121W 2927	EDG4242SQ121P 3220		EDG4242SQ121G 2757		EDG4242SQ121M 2386	
<b>Standing Height</b>								
54 x 54 x 42	140	EDG5454SQ141W 3511	EDG5454SQ141P 3863		EDG5454SQ141G 3320		EDG5454SQ141M 2866	
48 x 48 x 42	120	EDG4848SQ141W 3238	EDG4848SQ141P 3562		EDG4848SQ141G 3063		EDG4848SQ141M 2703	
42 x 42 x 42	110	EDG4242SQ141W 3210	EDG4242SQ141P 3531		EDG4242SQ141G 3041		EDG4242SQ141M 2670	

[View statement of line](#)

## 2 Select a finish

[View finish details](#)

**Metal finish**  
MFMB Matte Black.  
Additional metal finishes are available, see options.

- WLA WNW
- WAC WWP
- WEC
- WOC
- WAM
- WCM
- WWM
- WGW
- WBW
- WSW

## 3 Select a edge

[View edge details](#)

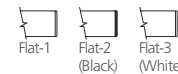
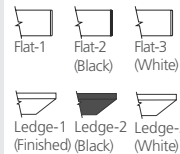
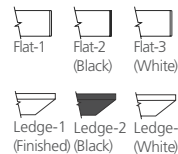
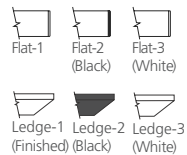

## 4 Select hardware

[View hardware details](#)

Hardware  
N/A

Hardware  
N/A

Hardware  
N/A

Hardware  
N/A

## Product features.

- 1" Thick top
- ENVI-CT finish on wood tops
- Matte black metal finish base standard
- 6" Radius corners
- 3" Adjustable glide

## Options.

### EDGE

- SC1: Modify radius corner to square corner - n/c

### POWER

- Two pods mounted under the hinged seamless grommet. Each pod has 4 power and 2 data ports. Telecom connectors sold separately.
- PSG82-C: Plug with 124" cord (8 power, 2 telecom plates) - \$1875 each
- W21: Grey Wire Manager (10.5") - \$35 ea.

### PREMIUM METAL FINISHES

- Specify Top Horn and Leg Metal Finish Color: \$630
- MFW: White, MFS: Silver, MFGG: Graphite Gray, MFSS: Salmon Sienna, MFSA: Surfin Aquavert, MFPS: Pistachio, MFOS: Oyster, MFNA: Navy, MFOL: Olive, MFGB: Grey Beige



### PLANK MATCH VENEER

- RPMV: Random Walnut Plank Match Veneer (Horizontal Grain with 25%+ Sap) - Add 10%. Clear coat only.

# Edgeworks.

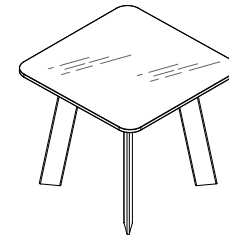
Glass Conference Tables  
Square Frameless



1 Select a model w" x d" x h"	weight	Clear Gloss Glass Top Matte Black Metal Base		White Gloss Glass Top Matte Black Metal Base		Black Gloss Glass Top Matte Black Metal Base	
		<b>Sitting Height</b>					
54 x 54 x 29	130	EDG5454SQ121SC	4554	EDG5454SQ121SW	6212	EDG5454SQ121SB	6212
48 x 48 x 29	110	EDG4848SQ121SC	4002	EDG4848SQ121SW	5312	EDG4848SQ121SB	5312
42 x 42 x 29	100	EDG4242SQ121SC	3729	EDG4242SQ121SW	4733	EDG4242SQ121SB	4733
<b>Standing Height</b>							
54 x 54 x 42	140	EDG5454SQ141SC	4838	EDG5454SQ141SW	6496	EDG5454SQ141SB	6496
48 x 48 x 42	120	EDG4848SQ141SC	4286	EDG4848SQ141SW	5596	EDG4848SQ141SB	5596
42 x 42 x 42	110	EDG4242SQ141SC	4013	EDG4242SQ141SW	5017	EDG4242SQ141SB	5017
2 Select a finish <i>View finish details</i>		MFMB		MFMB		MFMB	
Metal finish MFMB Matte Black. Additional metal finishes are available, see options.							
3 Select an edge <i>View edge details</i>							
4 Select hardware <i>View hardware details</i>		Hardware N/A		Hardware N/A		Hardware N/A	

*View statement of line*

## Product features.

- 1/2" Clear glass top
- Matte black metal finish base standard
- 6" Radius corners
- 3" Adjustable glide
- Wood subtop underneath glass
- Glass tops are gloss finish, see options for Soft Etch Glass tops

## Options.

### EDGE

- SC1: Modify radius corner to square corner - n/c

### PREMIUM METAL FINISHES

- Specify Top Horn and Leg Metal Finish Color: \$630
- MFW: White, MFS: Silver, MFGG: Graphite Gray, MFSS: Salmon Sienna, MFSA: Surfin Aquavert, MFPS: Pistachio, MFOS: Oyster, MFNA: Navy, MFOL: Olive, MFGB: Grey Beige

### GLASS FINISH

- Optional Soft Etch Finished glass
- EB: Black Soft Etch Glass, EW: White Soft Etch Glass - n/c

# Edgeworks.

Conference Tables  
Rectangle 36" Depth Sitting Height

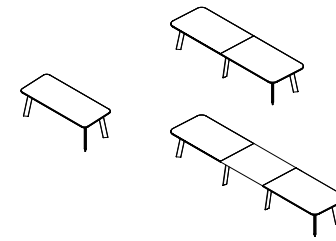

[View statement of line](#)

1 Select a model w" x d" x h"	weight	Standard Veneer Top Matte Black Metal Base		Premium Veneer Top Matte Black Metal Base		High Pressure Laminate Top Matte Black Metal Base		Thermally Fused Laminate Top Matte Black Metal Base	
		<b>3 Piece Top</b> 240 x 36 x 29 216 x 36 x 29 198 x 36 x 29 <b>2 Piece Top</b> 168 x 36 x 29 144 x 36 x 29 120 x 36 x 29 <b>1 Piece Top</b> 96 x 36 x 29 84 x 36 x 29 72 x 36 x 29		430 EDG24036RE123W 11580 360 EDG21636RE123W 9577 265 EDG19836RE123W 8692 265 EDG16836RE122W 6738 240 EDG14436RE122W 6508 215 EDG12036RE122W 6280 735 EDG9636RE121W 3833 145 EDG8436RE121W 3735 135 EDG7236RE121W 3637	EDG24036RE123P 12738 EDG21636RE123P 10535 EDG19836RE123P 9562 EDG16836RE122P 7412 EDG14436RE122P 7159 EDG12036RE122P 6908 EDG9636RE121P 4217 EDG8436RE121P 4109 EDG7236RE121P 4001	EDG24036RE123G 10986 EDG21636RE123G 9025 EDG19836RE123G 8272 EDG16836RE122G 6355 EDG14436RE122G 6159 EDG12036RE122G 5962 EDG9636RE121G 3625 EDG8436RE121G 3538 EDG7236RE121G 3456	EDG24036RE123M 10014 EDG21636RE123M 8201 EDG19836RE123M 7524 EDG16836RE122M 5734 EDG14436RE122M 5668 EDG12036RE122M 5602 EDG9636RE121M 3238 EDG8436RE121M 3205 EDG7236RE121M 3172		
<b>2 Select a finish</b> <a href="#">View finish details</a>  Metal finish MFMB Matte Black. Additional metal finishes are available, see options.	WLA WNW WAC WWP WEC WOC WAM WCM WWM WGW WBW WSW	TBCO TBSW TSTV TSMV TSLV TOBW WBO WMO WSO	GAC GSWL +10% GEC GWL GOC GAM GCM GWM GNW GSTV +10%	MAC MEC MOC MGW MSW MTW MWL					
<b>3 Select a edge</b> <a href="#">View edge details</a>									
<b>4 Select hardware</b> <a href="#">View hardware details</a>	Hardware N/A	Hardware N/A	Hardware N/A	Hardware N/A					

## Product features.

- 1" Thick top with rounded edges
- ENVI-CT finish on wood tops
- Matte black metal finish base standard
- 6" Radius corners
- 3" Adjustable glide

### NOTES

- 4 leg: 72" - 96" width
- 6 leg: 120" - 168" width
- 8 leg: 198" - 240" width

## Options.

### EDGE

- SC1: Modify radius corner to square corner - n/c

### INSET LEGS

- IL2: Inset legs for two piece top - 10% upcharge
- IL3: Inset legs for a three piece top - 10% upcharge

### POWER

- Two pods mounted under the hinged seamless grommet. Each pod has 4 power and 2 data ports. Telecom connectors sold separately.
- PSG82-C: Plug with 124" cord (8 power, 2 telecom plates) - \$1875 each
- W21: Grey Wire Manager (10.5") - \$35 ea.

### PREMIUM METAL FINISHES

- Specify Top Horn and Leg Metal Finish Color: \$660 (1) Piece Top, \$1,010 (2) Piece Top, \$1,355 (3) Piece Top
- MFW: White, MFS: Silver, MFGG: Graphite Gray, MFSS: Salmon Sienna, MFSA: Surfin Aquavert, MFPS: Pistachio, MFOS: Oyster, MFNA: Navy, MFOL: Olive, MFGB: Grey Beige
- PLANK MATCH VENEER
- RPMV: Random Walnut Plank Match Veneer (Horizontal Grain with 25%+ Sap) - Add 10%. Clear coat only.

# Edgeworks.

Glass Conference Tables  
Rectangle 36" Depth Sitting Height

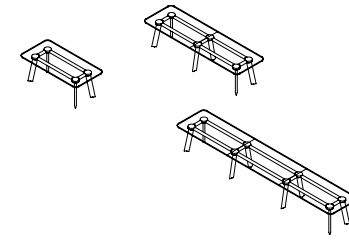

1 Select a model w" x d" x h"	weight	Clear Gloss Glass Top Matte Black Metal Base		White Gloss Glass Top Matte Black Metal Base		Black Gloss Glass Top Matte Black Metal Base	
<b>3 Piece Top</b>							
240 x 36 x 29	430	EDG24036RE123SC	12596	EDG24036RE123SW	17510	EDG24036RE123SB	17510
216 x 36 x 29	360	EDG21636RE123SC	10478	EDG21636RE123SW	14900	EDG21636RE123SB	14900
198 x 36 x 29	265	EDG19836RE123SC	10183	EDG19836RE123SW	14238	EDG19836RE123SB	14238
<b>2 Piece Top</b>							
168 x 36 x 29	265	EDG16836RE122SC	7704	EDG16836RE122SW	11144	EDG16836RE122SB	11144
144 x 36 x 29	240	EDG14436RE122SC	7311	EDG14436RE122SW	10260	EDG14436RE122SB	10260
120 x 36 x 29	215	EDG12036RE122SC	6918	EDG12036RE122SW	9375	EDG12036RE122SB	9375
<b>1 Piece Top</b>							
96 x 36 x 29	735	EDG9636RE121SC	4526	EDG9636RE121SW	6492	EDG9636RE121SB	6492
84 x 36 x 29	145	EDG8436RE121SC	4330	EDG8436RE121SW	6050	EDG8436RE121SB	6050
72 x 36 x 29	135	EDG7236RE121SC	4133	EDG7236RE121SW	5608	EDG7236RE121SB	5608
2 Select a finish View finish details		MFMB		MFMB		MFMB	
Metal finish MFMB Matte Black. Additional metal finishes are available, see options.							
3 Select an edge View edge details		Flat		Flat		Flat	
4 Select hardware View hardware details		Hardware N/A		Hardware N/A		Hardware N/A	

View statement of line

## Product features.

- 1/2" Clear glass top
- Matte black metal finish base standard
- 6" Radius corners
- 3" Adjustable glide
- Glass tops are glass finish, see options for Soft Etch Glass tops

### NOTES

- Contact our customer service department for custom inset leg quote with glass tops
- 4 leg: 72" - 96" width
- 6 leg: 120" - 168" width
- 8 leg: 198" - 240" width

## Options.

### EDGE

- SC1: Modify radius corner to square corner - n/c

### PREMIUM METAL FINISHES

- Specify Top Horn and Leg Metal Finish Color: \$660 (1) Piece Top, \$1,010 (2) Piece Top, \$1,355 (3) Piece Top
- MFV: White, MFS: Silver, MFGG: Graphite Gray, MFSS: Salmon Sienna, MFSA: Surfin Aquavert, MFPS: Pistachio, MFOS: Oyster, MFNA: Navy, MFOL: Olive, MFGB: Grey Beige

### GLASS FINISH

- Optional Soft Etch Finished glass
- EB: Black Soft Etch Glass, EW: White Soft Etch Glass - n/c

### POWER

- Glasspod cutouts will include an additional fee of \$125 per pod
- REF-310: Reef power unit with daisylink - \$1100 ea
- PD-Cove-PKO: Cove corded series - \$800 ea
- FPDB: Flush power/data bay
- Hardwired: FPDB-H72: 72" Cord - \$1250. FPDB-H108: 108" Cord - \$1300. FPDB-H144: 144" Cord - \$1350. FPDB-H180: 180" Cord - \$1400.
- Power/Plug: FPDB-C72: 72" Cord - \$1250. FPDB-C108: 108" Cord - \$1300. FPDB-C144: 144" - Cord \$1350. FPDB-C180: 180" Cord - \$1400



# Edgeworks.

Conference Tables  
Rectangle 36" Depth Standing Height

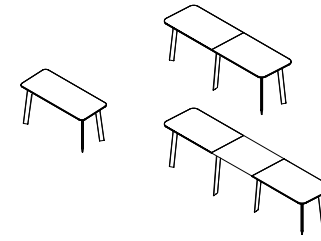

[View statement of line](#)

1 Select a model w" x d" x h"	weight	Standard Veneer Top Matte Black Metal Base		Premium Veneer Top Matte Black Metal Base		High Pressure Laminate Top Matte Black Metal Base		Thermally Fused Laminate Top Matte Black Metal Base	
		<b>3 Piece Top</b> 240 x 36 x 42 216 x 36 x 42 198 x 36 x 42 <b>2 Piece Top</b> 168 x 36 x 42 144 x 36 x 42 120 x 36 x 42 <b>1 Piece Top</b> 96 x 36 x 42 84 x 36 x 42 72 x 36 x 42		430 EDG24036RE143W 12291 360 EDG21636RE143W 10145 265 EDG19836RE143W 9260 265 EDG16836RE142W 7164 240 EDG14436RE142W 6935 215 EDG12036RE142W 6705 735 EDG9636RE141W 4259 145 EDG8436RE141W 4019 135 EDG7236RE141W 3921	EDG24036RE143P 13521 EDG21636RE143P 11160 EDG19836RE143P 10186 EDG16836RE142P 7881 EDG14436RE142P 7629 EDG12036RE142P 7376 EDG9636RE141P 4685 EDG8436RE141P 4421 EDG7236RE141P 4314	EDG24036RE143G 11696 EDG21636RE143G 9593 EDG19836RE143G 8840 EDG16836RE142G 6782 EDG14436RE142G 6585 EDG12036RE142G 6393 EDG9636RE141G 4052 EDG8436RE141G 3822 EDG7236RE141G 3740	EDG24036RE143M 10723 EDG21636RE143M 8769 EDG19836RE143M 8092 EDG16836RE142M 6159 EDG14436RE142M 6093 EDG12036RE142M 6028 EDG9636RE141M 3664 EDG8436RE141M 3489 EDG7236RE141M 3456		
<b>2 Select a finish</b> <a href="#">View finish details</a>  <b>Metal finish</b> MFMB Matte Black. Additional metal finishes are available, see options.	WLA WNW WAC WWP WEC WOC WAM WCM WWM WGW WBW WSW	TBCO TBSW TSTV TSMV TSLV TOBW WBO WMO WSO	GAC GSWL +10% GEC GWL GOC GAM GCM GWM GNW GSTV +10%	MAC MEC MOC MGW MSW MTW MWL					
<b>3 Select a edge</b> <a href="#">View edge details</a>									
<b>4 Select hardware</b> <a href="#">View hardware details</a>	Hardware N/A	Hardware N/A	Hardware N/A	Hardware N/A					

## Product features.

- 1" Thick top with rounded edges
- ENVI-CT finish on wood tops
- Matte black metal finish base standard
- 6" Radius corners
- 3" Adjustable glide

### NOTES

- 4 leg: 72" - 96" width
- 6 leg: 120" - 168" width
- 8 leg: 198" - 240" width

## Options.

### EDGE

- SC1: Modify radius corner to square corner - n/c

### INSET LEGS

- IL2: Inset legs for two piece top - 10% upcharge
- IL3: Inset legs for a three piece top - 10% upcharge

### POWER

- Two pods mounted under the hinged seamless grommet. Each pod has 4 power and 2 data ports. Telecom connectors sold separately.
- PSG82-C: Plug with 124" cord (8 power, 2 telecom plates) - \$1875 each
- W21: Grey Wire Manager (10.5") - \$35 ea.



### PREMIUM METAL FINISHES

- Specify Top Horn and Leg Metal Finish Color: \$660 (1) Piece Top, \$1,010 (2) Piece Top, \$1,355 (3) Piece Top
- MFW: White, MFS: Silver, MFGG: Graphite Gray, MFSS: Salmon Sienna, MFSA: Surfin Aquavert, MFPS: Pistachio, MFOS: Oyster, MFNA: Navy, MFOL: Olive, MFGB: Grey Beige
- PLANK MATCH VENEER
- RPMV: Random Walnut Plank Match Veneer (Horizontal Grain with 25%+ Sap) - Add 10%. Clear coat only.

# Edgeworks.

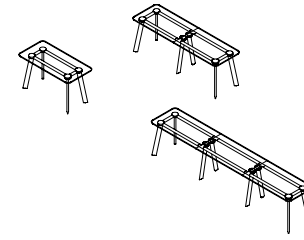
Glass Conference Tables  
Rectangle 36" Depth Standing Height



1 Select a model w" x d" x h"	weight	Clear Gloss Glass Top Matte Black Metal Base		White Gloss Glass Top Matte Black Metal Base		Black Gloss Glass Top Matte Black Metal Base	
<b>3 Piece Top</b>							
240 x 36 x 42	430	EDG24036RE143SC	13306	EDG24036RE143SW	18220	EDG24036RE143SB	18220
216 x 36 x 42	360	EDG21636RE143SC	11046	EDG21636RE143SW	15468	EDG21636RE143SB	15468
198 x 36 x 42	265	EDG19836RE143SC	10750	EDG19836RE143SW	14805	EDG19836RE143SB	14805
<b>2 Piece Top</b>							
168 x 36 x 42	265	EDG16836RE142SC	8130	EDG16836RE142SW	11570	EDG16836RE142SB	11570
144 x 36 x 42	240	EDG14436RE142SC	7737	EDG14436RE142SW	10685	EDG14436RE142SB	10685
120 x 36 x 42	215	EDG12036RE142SC	7343	EDG12036RE142SW	9801	EDG12036RE142SB	9801
<b>1 Piece Top</b>							
96 x 36 x 42	735	EDG9636RE141SC	4810	EDG9636RE141SW	6776	EDG9636RE141SB	6776
84 x 36 x 42	145	EDG8436RE141SC	4613	EDG8436RE141SW	6334	EDG8436RE141SB	6334
72 x 36 x 42	135	EDG7236RE141SC	4417	EDG7236RE141SW	5892	EDG7236RE141SB	5892
2 Select a finish View finish details		MFMB		MFMB		MFMB	
Metal finish MFMB Matte Black. Additional metal finishes are available, see options.							
3 Select an edge View edge details							
		Flat		Flat		Flat	
4 Select hardware View hardware details		Hardware N/A		Hardware N/A		Hardware N/A	

View statement of line

## Product features.

- 1/2" Clear glass top
- Matte black metal finish base standard
- 6" Radius corners
- 3" Adjustable glide
- Glass tops are glass finish, see options for Soft Etch Glass tops

### NOTES

- Contact our customer service department for custom inset leg quote with glass tops
- 4 leg: 72" - 96" width
- 6 leg: 120" - 168" width
- 8 leg: 198" - 240" width

## Options.

### EDGE

- SC1: Modify radius corner to square corner - n/c

### PREMIUM METAL FINISHES

- Specify Top Horn and Leg Metal Finish Color: \$660 (1) Piece Top, \$1,010 (2) Piece Top, \$1,355 (3) Piece Top
- MFV: White, MFS: Silver, MFGG: Graphite Gray, MFSS: Salmon Sienna, MFSA: Surfin Aquavert, MFPS: Pistachio, MFOS: Oyster, MFNA: Navy, MFOL: Olive, MFGB: Grey Beige

### GLASS FINISH

- Optional Soft Etch Finished glass
- EB: Black Soft Etch Glass, EW: White Soft Etch Glass - n/c

### POWER

- Glasspod cutouts will include an additional fee of \$125 per pod
- REF-310: Reef power unit with daisylink - \$1100 ea
- PD-Cove-PKO: Cove corded series - \$800 ea
- FPDB: Flush power/data bay
- Hardwired: FPDB-H72: 72" Cord - \$1250. FPDB-H108: 108" Cord - \$1300. FPDB-H144: 144" Cord - \$1350. FPDB-H180: 180" Cord - \$1400.
- Power/Plug: FPDB-C72: 72" Cord - \$1250. FPDB-C108: 108" Cord - \$1300. FPDB-C144: 144" - Cord \$1350. FPDB-C180: 180" Cord - \$1400

# Edgeworks.

Conference Tables  
Rectangle 42" Depth Sitting Height

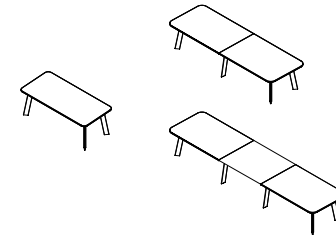

1 Select a model w" x d" x h"	weight	Standard Veneer Top Matte Black Metal Base		Premium Veneer Top Matte Black Metal Base		High Pressure Laminate Top Matte Black Metal Base		Thermally Fused Laminate Top Matte Black Metal Base	
		<b>3 Piece Top</b> 240 x 42 x 29 216 x 42 x 29 198 x 42 x 29 <b>2 Piece Top</b> 168 x 42 x 29 144 x 42 x 29 120 x 42 x 29 <b>1 Piece Top</b> 96 x 42 x 29 84 x 42 x 29 72 x 42 x 29		470 EDG24042RE123W 12089 390 EDG21642RE123W 10046 365 EDG19842RE123W 9031 295 EDG16842RE122W 7071 260 EDG14442RE122W 6841 235 EDG12042RE122W 6607 175 EDG9642RE121W 4019 160 EDG8442RE121W 3909 150 EDG7242RE121W 3800	EDG24042RE123P 13298 EDG21642RE123P 11051 EDG19842RE123P 9935 EDG16842RE122P 7779 EDG14442RE122P 7526 EDG12042RE122P 7268 EDG9642RE121P 4421 EDG8442RE121P 4300 EDG7242RE121P 4180	EDG24042RE123G 11417 EDG21642RE123G 9424 EDG19842RE123G 8561 EDG16842RE122G 6634 EDG14442RE122G 6443 EDG12042RE122G 6241 EDG9642RE121G 3778 EDG8442RE121G 3686 EDG7242RE121G 3593	EDG24042RE123M 10123 EDG21642RE123M 8299 EDG19842RE123M 7612 EDG16842RE122M 5809 EDG14442RE122M 5734 EDG12042RE122M 5657 EDG9642RE121M 3320 EDG8442RE121M 3266 EDG7242RE121M 3205		
<b>2 Select a finish</b> <a href="#">View finish details</a>  Metal finish MFMB Matte Black. Additional metal finishes are available, see options.	WLA WNW WAC WWP WEC WOC WAM WCM WWM WGW WBW WSW	TBCO TBSW TSTV TSMV TSLV TOBW WBO WMO WSO	GAC GSWL +10% GEC GWL GOC GAM GCM GWM GNW GSTV +10%	MAC MEC MOC MGW MSW MTW MWL					
<b>3 Select a edge</b> <a href="#">View edge details</a>									
<b>4 Select hardware</b> <a href="#">View hardware details</a>	Hardware N/A	Hardware N/A	Hardware N/A	Hardware N/A					

[View statement of line](#)

## Product features.

- 1" Thick top with rounded edges
- ENVI-CT finish on wood tops
- Matte black metal finish base standard
- 6" Radius corners
- 3" Adjustable glide

### NOTES

- 4 leg: 72" - 96" width
- 6 leg: 120" - 168" width
- 8 leg: 198" - 240" width

## Options.

### EDGE

- SC1: Modify radius corner to square corner - n/c

### INSET LEGS

- IL2: Inset legs for two piece top - 10% upcharge
- IL3: Inset legs for a three piece top - 10% upcharge

### POWER

- Two pods mounted under the hinged seamless grommet. Each pod has 4 power and 2 data ports. Telecom connectors sold separately.
- PSG82-C: Plug with 124" cord (8 power, 2 telecom plates) - \$1875 each
- W21: Grey Wire Manager (10.5") - \$35 ea.

### PREMIUM METAL FINISHES

- Specify Top Horn and Leg Metal Finish Color: \$660 (1) Piece Top, \$1,010 (2) Piece Top, \$1,355 (3) Piece Top
- MFW: White, MFS: Silver, MFGG: Graphite Gray, MFSS: Salmon Sienna, MFSA: Surfin Aquavert, MFPS: Pistachio, MFOS: Oyster, MFNA: Navy, MFOL: Olive, MFGB: Grey Beige
- PLANK MATCH VENEER
- RPMV: Random Walnut Plank Match Veneer (Horizontal Grain with 25%+ Sap) - Add 10%. Clear coat only.

# Edgeworks.

Glass Conference Tables  
Rectangle 42" Depth Sitting Height

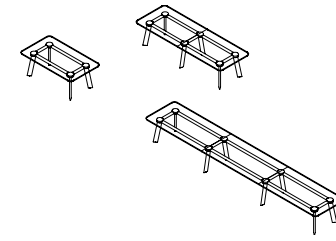

1 Select a model w" x d" x h"	weight	Clear Gloss Glass Top Matte Black Metal Base		White Gloss Glass Top Matte Black Metal Base		Black Gloss Glass Top Matte Black Metal Base	
<b>3 Piece Top</b>							
240 x 42 x 29	470	EDG24042RE123SC	13252	EDG24042RE123SW	18984	EDG24042RE123SB	18984
216 x 42 x 29	390	EDG21642RE123SC	11068	EDG21642RE123SW	16227	EDG21642RE123SB	16227
198 x 42 x 29	365	EDG19842RE123SC	10723	EDG19842RE123SW	15453	EDG19842RE123SB	15453
<b>2 Piece Top</b>							
168 x 42 x 29	295	EDG16842RE122SC	8163	EDG16842RE122SW	12176	EDG16842RE122SB	12176
144 x 42 x 29	260	EDG14442RE122SC	7704	EDG14442RE122SW	11144	EDG14442RE122SB	11144
120 x 42 x 29	235	EDG12042RE122SC	7246	EDG12042RE122SW	10112	EDG12042RE122SB	10112
<b>1 Piece Top</b>							
96 x 42 x 29	175	EDG9642RE121SC	4788	EDG9642RE121SW	7081	EDG9642RE121SB	7081
84 x 42 x 29	160	EDG8442RE121SC	4559	EDG8442RE121SW	6567	EDG8442RE121SB	6567
72 x 42 x 29	150	EDG7242RE121SC	4330	EDG7242RE121SW	6050	EDG7242RE121SB	6050
2 Select a finish View finish details		MFMB		MFMB		MFMB	
Metal finish MFMB Matte Black. Additional metal finishes are available, see options.							
3 Select an edge View edge details		Flat		Flat		Flat	
4 Select hardware View hardware details		Hardware N/A		Hardware N/A		Hardware N/A	

[View statement of line](#)

## Product features.

- 1/2" Clear glass top
- Matte black metal finish base standard
- 6" Radius corners
- 3" Adjustable glide
- Glass tops are gloss finish, see options for Soft Etch Glass tops

### NOTES

- Contact our customer service department for custom inset leg quote with glass tops
- 4 leg: 72" - 96" width
- 6 leg: 120" - 168" width
- 8 leg: 198" - 240" width

## Options.

### EDGE

- SC1: Modify radius corner to square corner - n/c

### PREMIUM METAL FINISHES

- Specify Top Horn and Leg Metal Finish Color: \$660 (1) Piece Top, \$1,010 (2) Piece Top, \$1,355 (3) Piece Top
- MFV: White, MFS: Silver, MFGG: Graphite Gray, MFSS: Salmon Sienna, MFSA: Surfin Aquavert, MFPS: Pistachio, MFOS: Oyster, MFNA: Navy, MFOL: Olive, MFGB: Grey Beige

### GLASS FINISH

- Optional Soft Etch Finished glass
- EB: Black Soft Etch Glass, EW: White Soft Etch Glass - n/c

### POWER

- Glasspod cutouts will include an additional fee of \$125 per pod
- REF-310: Reef power unit with daisylink - \$1100 ea
- PD-Cove-PKO: Cove corded series - \$800 ea
- FPDB: Flush power/data bay
- Hardwired: FPDB-H72: 72" Cord - \$1250. FPDB-H108: 108" Cord - \$1300. FPDB-H144: 144" Cord - \$1350. FPDB-H180: 180" Cord - \$1400.
- Power/Plug: FPDB-C72: 72" Cord - \$1250. FPDB-C108: 108" Cord - \$1300. FPDB-C144: 144" - Cord \$1350. FPDB-C180: 180" Cord - \$1400

# Edgeworks.

Conference Tables  
Rectangle 42" Depth Standing Height

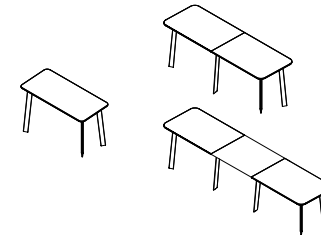

[View statement of line](#)

1 Select a model w" x d" x h"	weight	Standard Veneer Top Matte Black Metal Base		Premium Veneer Top Matte Black Metal Base		High Pressure Laminate Top Matte Black Metal Base		Thermally Fused Laminate Top Matte Black Metal Base					
		<b>3 Piece Top</b> 240 x 42 x 42 216 x 42 x 42 198 x 42 x 42 <b>2 Piece Top</b> 168 x 42 x 42 144 x 42 x 42 120 x 42 x 42 <b>1 Piece Top</b> 96 x 42 x 42 84 x 42 x 42 72 x 42 x 42		470 EDG24042RE143W 12798 390 EDG21642RE143W 10614 365 EDG19842RE143W 9599 295 EDG16842RE142W 7496 260 EDG14442RE142W 7268 235 EDG12042RE142W 7032 175 EDG9642RE141W 4445 160 EDG8442RE141W 4193 150 EDG7242RE141W 4084	EDG24042RE143P 14078 EDG21642RE143P 11675 EDG19842RE143P 10559 EDG16842RE142P 8246 EDG14442RE142P 7995 EDG12042RE142P 7736 EDG9642RE141P 4890 EDG8442RE141P 4613 EDG7242RE141P 4493	42126 9992 9129 7060 6869 6666 4205 3970 3877	10833 8867 8180 6236 6159 6083 3746 3550 3489	<b>2</b> Select a finish <a href="#">View finish details</a>  Metal finish MFMB Matte Black. Additional metal finishes are available, see options.	WLA WNW WAC WWP WEC WOC WAM WCM WWM WGW WBW WSW  TBCO TBSW TSTV TSMV TSLV TOBW WBO WMO WSO	GAC GSWL +10% GEC GWL GOC GAM GCM GWM GNW GSTV +10%  MAC MEC MOC MGW MSW MTW MWL	<b>3</b> Select a edge <a href="#">View edge details</a>  Flat-1 Flat-2 Flat-3 (Black) (White)  Ledge-1 Ledge-2 Ledge-3 (Finished) (Black) (White)  Flat-1 Flat-2 Flat-3 (Black) (White)  Ledge-1 Ledge-2 Ledge-3 (Finished) (Black) (White)  Flat-1 Flat-2 Flat-3 (Black) (White)  Ledge-1 Ledge-2 Ledge-3 (Finished) (Black) (White)	<b>4</b> Select hardware <a href="#">View hardware details</a> Hardware N/A	Hardware N/A

## Product features.

- 1" Thick top with rounded edges
- ENVI-CT finish on wood tops
- Matte black metal finish base standard
- 6" Radius corners
- 3" Adjustable glide

### NOTES

- 4 leg: 72" - 96" width
- 6 leg: 120" - 168" width
- 8 leg: 198" - 240" width

## Options.

### EDGE

- SC1: Modify radius corner to square corner - n/c

### INSET LEGS

- IL2: Inset legs for two piece top - 10% upcharge
- IL3: Inset legs for a three piece top - 10% upcharge

### POWER

- Two pods mounted under the hinged seamless grommet. Each pod has 4 power and 2 data ports. Telecom connectors sold separately.
- PSG82-C: Plug with 124" cord (8 power, 2 telecom plates) - \$1875 each
- W21: Grey Wire Manager (10.5") - \$35 ea.



### PREMIUM METAL FINISHES

- Specify Top Horn and Leg Metal Finish Color: \$660 (1) Piece Top, \$1,010 (2) Piece Top, \$1,355 (3) Piece Top
- MFW: White, MFS: Silver, MFGG: Graphite Gray, MFSS: Salmon Sienna, MFSA: Surfin Aquavert, MFPS: Pistachio, MFOS: Oyster, MFNA: Navy, MFOL: Olive, MFGB: Grey Beige
- PLANK MATCH VENEER
- RPMV: Random Walnut Plank Match Veneer (Horizontal Grain with 25%+ Sap) - Add 10%. Clear coat only.

# Edgeworks.

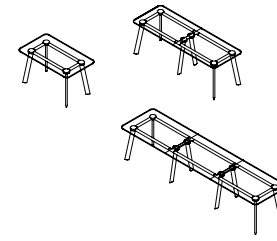
Glass Conference Tables  
Rectangle 42" Depth Standing Height



1 Select a model w" x d" x h"	weight	Clear Gloss Glass Top Matte Black Metal Base		White Gloss Glass Top Matte Black Metal Base		Black Gloss Glass Top Matte Black Metal Base	
		<b>3 Piece Top</b>					
240 x 42 x 42	470	EDG24042RE143SC	13961	EDG24042RE143SW	19694	EDG24042RE143SB	19694
216 x 42 x 42	390	EDG21642RE143SC	11636	EDG21642RE143SW	16795	EDG21642RE143SB	16795
198 x 42 x 42	365	EDG19842RE143SC	11291	EDG19842RE143SW	16021	EDG19842RE143SB	16021
<b>2 Piece Top</b>							
168 x 42 x 42	295	EDG16842RE142SC	8588	EDG16842RE142SW	12602	EDG16842RE142SB	12602
144 x 42 x 42	260	EDG14442RE142SC	8130	EDG14442RE142SW	11570	EDG14442RE142SB	11570
120 x 42 x 42	235	EDG12042RE142SC	7671	EDG12042RE142SW	10538	EDG12042RE142SB	10538
<b>1 Piece Top</b>							
96 x 42 x 42	175	EDG9642RE141SC	5072	EDG9642RE141SW	7365	EDG9642RE141SB	7365
84 x 42 x 42	160	EDG8442RE141SC	4843	EDG8442RE141SW	6850	EDG8442RE141SB	6850
72 x 42 x 42	150	EDG7242RE141SC	4613	EDG7242RE141SW	6334	EDG7242RE141SB	6334
2 Select a finish <i>View finish details</i>		MFMB		MFMB		MFMB	
Metal finish MFMB Matte Black. Additional metal finishes are available, see options.							
3 Select an edge <i>View edge details</i>							
		Flat		Flat		Flat	
4 Select hardware <i>View hardware details</i>		Hardware N/A		Hardware N/A		Hardware N/A	

[View statement of line](#)

## Product features.

- 1/2" Clear glass top
- Matte black metal finish base standard
- 6" Radius corners
- 3" Adjustable glide
- Glass tops are glass finish, see options for Soft Etch Glass tops

### NOTES

- Contact our customer service department for custom inset leg quote with glass tops
- 4 leg: 72" - 96" width
- 6 leg: 120" - 168" width
- 8 leg: 198" - 240" width

## Options.

### EDGE

- SC1: Modify radius corner to square corner - n/c

### PREMIUM METAL FINISHES

- Specify Top Horn and Leg Metal Finish Color: \$660 (1) Piece Top, \$1,010 (2) Piece Top, \$1,355 (3) Piece Top
- MFV: White, MFS: Silver, MFGG: Graphite Gray, MFSS: Salmon Sienna, MFSA: Surfin Aquavert, MFPS: Pistachio, MFOS: Oyster, MFNA: Navy, MFOL: Olive, MFGB: Grey Beige

### GLASS FINISH

- Optional Soft Etch Finished glass
- EB: Black Soft Etch Glass, EW: White Soft Etch Glass - n/c

### POWER

- Glasspod cutouts will include an additional fee of \$125 per pod
- REF-310: Reef power unit with daisylink - \$1100 ea
- PD-Cove-PKO: Cove corded series - \$800 ea
- FPDB: Flush power/data bay
- Hardwired: FPDB-H72: 72" Cord - \$1250. FPDB-H108: 108" Cord - \$1300. FPDB-H144: 144" Cord - \$1350. FPDB-H180: 180" Cord - \$1400.
- Power/Plug: FPDB-C72: 72" Cord - \$1250. FPDB-C108: 108" Cord - \$1300. FPDB-C144: 144" - Cord \$1350. FPDB-C180: 180" Cord - \$1400







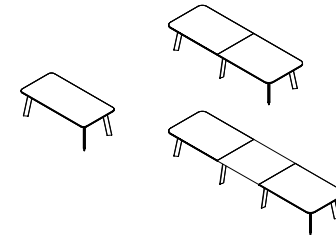













# Edgeworks.

Conference Tables

Rectangle 48" Depth Sitting Height



[View statement of line](#)

1 Select a model w" x d" x h"	weight	Standard Veneer Top Matte Black Metal Base		Premium Veneer Top Matte Black Metal Base		High Pressure Laminate Top Matte Black Metal Base		Thermally Fused Laminate Top Matte Black Metal Base	
		<b>3 Piece Top</b>		240 x 48 x 29	310 EDG24048RE123W 12318	EDG24048RE123P	13550	EDG24048RE123G	11936
		216 x 48 x 29	420 EDG21648RE123W 10614	EDG21648RE123P	11675	EDG21648RE123G	9905	EDG21648RE123M	8398
		198 x 48 x 29	400 EDG19848RE123W 9457	EDG19848RE123P	10403	EDG19848RE123G	8922	EDG19848RE123M	7639
<b>2 Piece Top</b>		168 x 48 x 29	325 EDG16848RE122W 7469	EDG16848RE122P	8216	EDG16848RE122G	6972	EDG16848RE122M	5826
		144 x 48 x 29	280 EDG14448RE122W 7207	EDG14448RE122P	7928	EDG14448RE122G	6754	EDG14448RE122M	5739
		120 x 48 x 29	255 EDG12048RE122W 6940	EDG12048RE122P	7634	EDG12048RE122G	6525	EDG12048RE122M	5712
<b>1 Piece Top</b>		96 x 48 x 29	195 EDG9648RE121W 4237	EDG9648RE121P	4661	EDG9648RE121G	3953	EDG9648RE121M	3363
		84 x 48 x 29	175 EDG8448RE121W 4111	EDG8448RE121P	4523	EDG8448RE121G	3860	EDG8448RE121M	3303
		72 x 48 x 29	165 EDG7248RE121W 3986	EDG7248RE121P	4385	EDG7248RE121G	3756	EDG7248RE121M	3238
<b>2 Select a finish</b> <a href="#">View finish details</a>		WLA WNW	TBCO	GAC GSWL +10%	MAC				
		WAC WWP	TBSW	GEC GWL	MEC				
		WEC	TSTV	GOC	MOC				
<b>Metal finish</b>		WOC	TSMV	GAM	MGW				
MFMB Matte Black.		WAM	TSLV	GCM	MSW				
Additional metal finishes are available, see options.		WCM	TOBW	GWM	MTW				
		WWM	WBO	GNW	MWL				
		WGW	WMO	GSTV					
		WBW	WSO	+10%					
		WSW							
<b>3 Select a edge</b> <a href="#">View edge details</a>		 Flat-1  Flat-2 (Black)  Flat-3 (White)	 Flat-1  Flat-2 (Black)  Flat-3 (White)	 Flat-1  Flat-2 (Black)  Flat-3 (White)	 Flat-1  Flat-2 (Black)  Flat-3 (White)				
		 Ledge-1 (Finished)  Ledge-2 (Black)  Ledge-3 (White)	 Ledge-1 (Finished)  Ledge-2 (Black)  Ledge-3 (White)	 Ledge-1 (Finished)  Ledge-2 (Black)  Ledge-3 (White)					
<b>4 Select hardware</b> <a href="#">View hardware details</a>		Hardware N/A	Hardware N/A	Hardware N/A	Hardware N/A				

## Product features.

- 1" Thick top with rounded edges
- ENVI-CT finish on wood tops
- Matte black metal finish base standard
- 6" Radius corners
- 3" Adjustable glide

### NOTES

- 4 leg: 72" - 96" width
- 6 leg: 120" - 168" width
- 8 leg: 198" - 240" width

## Options.

### EDGE

- SC1: Modify radius corner to square corner - n/c

### INSET LEGS

- IL2: Inset legs for two piece top - 10% upcharge
- IL3: Inset legs for a three piece top - 10% upcharge

### POWER

- Two pods mounted under the hinged seamless grommet. Each pod has 4 power and 2 data ports. Telecom connectors sold separately.
- PSG82-C: Plug with 124" cord (8 power, 2 telecom plates) - \$1875 each
- W21: Grey Wire Manager (10.5") - \$35 ea.



### PREMIUM METAL FINISHES

- Specify Top Horn and Leg Metal Finish Color: \$660 (1) Piece Top, \$1,010 (2) Piece Top, \$1,355 (3) Piece Top
- MFW: White, MFS: Silver, MFGG: Graphite Gray, MFSS: Salmon Sienna, MFSA: Surfin Aquavert, MFPS: Pistachio, MFOS: Oyster, MFNA: Navy, MFOL: Olive, MFGB: Grey Beige
- PLANK MATCH VENEER
- RPMV: Random Walnut Plank Match Veneer (Horizontal Grain with 25%+ Sap) - Add 10%. Clear coat only.

# Edgeworks.

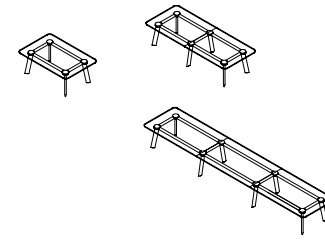
Glass Conference Tables  
Rectangle 48" Depth Sitting Height



1 Select a model w" x d" x h"	weight	Clear Gloss Glass Top Matte Black Metal Base		White Gloss Glass Top Matte Black Metal Base		Black Gloss Glass Top Matte Black Metal Base	
		<b>3 Piece Top</b>					
240 x 48 x 29	310	EDG24048RE123SC	13907	EDG24048RE123SW	20459	EDG24048RE123SB	20459
216 x 48 x 29	420	EDG21648RE123SC	11657	EDG21648RE123SW	17554	EDG21648RE123SB	17554
198 x 48 x 29	400	EDG19848RE123SC	11264	EDG19848RE123SW	16669	EDG19848RE123SB	16669
<b>2 Piece Top</b>							
168 x 48 x 29	325	EDG16848RE122SC	8622	EDG16848RE122SW	13208	EDG16848RE122SB	13208
144 x 48 x 29	280	EDG14448RE122SC	8097	EDG14448RE122SW	12029	EDG14448RE122SB	12029
120 x 48 x 29	255	EDG12048RE122SC	7573	EDG12048RE122SW	10849	EDG12048RE122SB	10849
<b>1 Piece Top</b>							
96 x 48 x 29	195	EDG9648RE121SC	5050	EDG9648RE121SW	7671	EDG9648RE121SB	7671
84 x 48 x 29	175	EDG8448RE121SC	4788	EDG8448RE121SW	7081	EDG8448RE121SB	7081
72 x 48 x 29	165	EDG7248RE121SC	4526	EDG7248RE121SW	6492	EDG7248RE121SB	6492
2 Select a finish <i>View finish details</i>		MFMB		MFMB		MFMB	
Metal finish MFMB Matte Black. Additional metal finishes are available, see options.							
3 Select an edge <i>View edge details</i>							
		Flat		Flat		Flat	
4 Select hardware <i>View hardware details</i>		Hardware N/A		Hardware N/A		Hardware N/A	

[View statement of line](#)

## Product features.

- 1/2" Clear glass top
- Matte black metal finish base standard
- 6" Radius corners
- 3" Adjustable glide
- Glass tops are glass finish, see options for Soft Etch Glass tops

### NOTES

- Contact our customer service department for custom inset leg quote with glass tops
- 4 leg: 72" - 96" width
- 6 leg: 120" - 168" width
- 8 leg: 198" - 240" width

## Options.

### EDGE

- SC1: Modify radius corner to square corner - n/c

### PREMIUM METAL FINISHES

- Specify Top Horn and Leg Metal Finish Color: \$660 (1) Piece Top, \$1,010 (2) Piece Top, \$1,355 (3) Piece Top
- MFV: White, MFS: Silver, MFGG: Graphite Gray, MFSS: Salmon Sienna, MFSA: Surfin Aquavert, MFPS: Pistachio, MFOS: Oyster, MFNA: Navy, MFOL: Olive, MFGB: Grey Beige

### GLASS FINISH

- Optional Soft Etch Finished glass
- EB: Black Soft Etch Glass, EW: White Soft Etch Glass - n/c

### POWER

- Glasspod cutouts will include an additional fee of \$125 per pod
- REF-310: Reef power unit with daisylink - \$1100 ea
- PD-Cove-PKO: Cove corded series - \$800 ea
- FPDB: Flush power/data bay
- Hardwired: FPDB-H72: 72" Cord - \$1250. FPDB-H108: 108" Cord - \$1300. FPDB-H144: 144" Cord - \$1350. FPDB-H180: 180" Cord - \$1400.
- Power/Plug: FPDB-C72: 72" Cord - \$1250. FPDB-C108: 108" Cord - \$1300. FPDB-C144: 144" - Cord \$1350. FPDB-C180: 180" Cord - \$1400



# Edgeworks.

Conference Tables  
Rectangle 48" Depth Standing Height

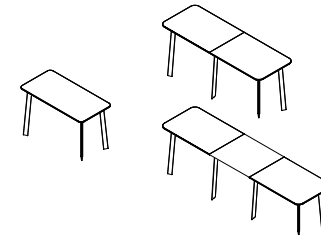

[View statement of line](#)

1 Select a model w" x d" x h"	weight	Standard Veneer Top Matte Black Metal Base		Premium Veneer Top Matte Black Metal Base		High Pressure Laminate Top Matte Black Metal Base		Thermally Fused Laminate Top Matte Black Metal Base		
		<b>3 Piece Top</b> 240 x 48 x 42 216 x 48 x 42 198 x 48 x 42 <b>2 Piece Top</b> 168 x 48 x 42 144 x 48 x 42 120 x 48 x 42 <b>1 Piece Top</b> 96 x 48 x 42 84 x 48 x 42 72 x 48 x 42		310 EDG24048RE143W 13229 420 EDG21648RE143W 11182 400 EDG19848RE143W 10025 325 EDG16848RE142W 7786 280 EDG14448RE142W 7634 255 EDG12048RE142W 7365 195 EDG9648RE141W 4663 175 EDG8448RE141W 4395 165 EDG7248RE141W 4270	EDG24048RE143P 14552 EDG21648RE143P 12300 EDG19848RE143P 11028 EDG16848RE142P 8565 EDG14448RE142P 8398 EDG12048RE142P 8102 EDG9648RE141P 5130 EDG8448RE141P 4835 EDG7248RE141P 4697	EDG24048RE143G 13229 EDG21648RE143G 10473 EDG19848RE143G 9490 EDG16848RE142G 7399 EDG14448RE142G 7180 EDG12048RE142G 6950 EDG9648RE141G 4379 EDG8448RE141G 4144 EDG7248RE141G 4040	EDG24048RE143M 10942 EDG21648RE143M 8966 EDG19848RE143M 8207 EDG16848RE142M 6251 EDG14448RE142M 6164 EDG12048RE142M 6137 EDG9648RE141M 3790 EDG8448RE141M 3587 EDG7248RE141M 3521	WLA WNW WAC WWP WEC WOC WAM WCM WWM WGW WBW WSW TBCO TBSW TSTV TSMV TSLV TOBW WBO WMO WSO GAC GSWL +10% GEC GWL GOC GAM GCM GWM GNW GSTV +10% MAC MEC MOC MGW MSW MTW MWL	Flat-1 Flat-2 Flat-3 (Black) (White) Ledge-1 Ledge-2 Ledge-3 (Finished) (Black) (White) Hardware N/A	Flat-1 Flat-2 Flat-3 (Black) (White) Ledge-1 Ledge-2 Ledge-3 (Finished) (Black) (White) Hardware N/A

## Product features.

- 1" Thick top with rounded edges
- ENVI-CT finish on wood tops
- Matte black metal finish base standard
- 6" Radius corners
- 3" Adjustable glide

### NOTES

- 4 leg: 72" - 96" width
- 6 leg: 120" - 168" width
- 8 leg: 198" - 240" width

## Options.

### EDGE

- SC1: Modify radius corner to square corner - n/c

### INSET LEGS

- IL2: Inset legs for two piece top - 10% upcharge
- IL3: Inset legs for a three piece top - 10% upcharge

### POWER

- Two pods mounted under the hinged seamless grommet. Each pod has 4 power and 2 data ports. Telecom connectors sold separately.
- PSG82-C: Plug with 124" cord (8 power, 2 telecom plates) - \$1875 each
- W21: Grey Wire Manager (10.5") - \$35 ea.



### PREMIUM METAL FINISHES

- Specify Top Horn and Leg Metal Finish Color: \$660 (1) Piece Top, \$1,010 (2) Piece Top, \$1,355 (3) Piece Top
- MFW: White, MFS: Silver, MFGG: Graphite Gray, MFSS: Salmon Sienna, MFSA: Surfin Aquavert, MFPS: Pistachio, MFOS: Oyster, MFNA: Navy, MFOL: Olive, MFGB: Grey Beige
- PLANK MATCH VENEER
- RPMV: Random Walnut Plank Match Veneer (Horizontal Grain with 25%+ Sap) - Add 10%. Clear coat only.

# Edgeworks.

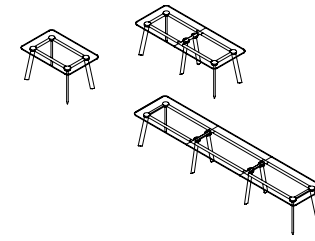
Glass Conference Tables  
Rectangle 48" Depth Standing Height



1 Select a model w" x d" x h"	weight	Clear Gloss Glass Top Matte Black Metal Base		White Gloss Glass Top Matte Black Metal Base		Black Gloss Glass Top Matte Black Metal Base	
<b>3 Piece Top</b>							
240 x 48 x 42	310	EDG24048RE143SC	14616	EDG24048RE143SW	21168	EDG24048RE143SB	21168
216 x 48 x 42	420	EDG21648RE143SC	12225	EDG21648RE143SW	18122	EDG21648RE143SB	18122
198 x 48 x 42	400	EDG19848RE143SC	11832	EDG19848RE143SW	17237	EDG19848RE143SB	17237
<b>2 Piece Top</b>							
168 x 48 x 42	325	EDG16848RE142SC	9047	EDG16848RE142SW	13633	EDG16848RE142SB	13633
144 x 48 x 42	280	EDG14448RE142SC	8523	EDG14448RE142SW	12454	EDG14448RE142SB	12454
120 x 48 x 42	255	EDG12048RE142SC	7999	EDG12048RE142SW	11275	EDG12048RE142SB	11275
<b>1 Piece Top</b>							
96 x 48 x 42	195	EDG9648RE141SC	5334	EDG9648RE141SW	7955	EDG9648RE141SB	7955
84 x 48 x 42	175	EDG8448RE141SC	5072	EDG8448RE141SW	7365	EDG8448RE141SB	7365
72 x 48 x 42	165	EDG7248RE141SC	4810	EDG7248RE141SW	6776	EDG7248RE141SB	6776
2 Select a finish <i>View finish details</i>		MFMB		MFMB		MFMB	
Metal finish MFMB Matte Black. Additional metal finishes are available, see options.							
3 Select an edge <i>View edge details</i>							
		Flat		Flat		Flat	
4 Select hardware <i>View hardware details</i>		Hardware N/A		Hardware N/A		Hardware N/A	

*View statement of line*

## Product features.

- 1/2" Clear glass top
- Matte black metal finish base standard
- 6" Radius corners
- 3" Adjustable glide
- Glass tops are glass finish, see options for Soft Etch Glass tops

### NOTES

- Contact our customer service department for custom inset leg quote with glass tops
- 4 leg: 72" - 96" width
- 6 leg: 120" - 168" width
- 8 leg: 198" - 240" width

## Options.

### EDGE

- SC1: Modify radius corner to square corner - n/c

### PREMIUM METAL FINISHES

- Specify Top Horn and Leg Metal Finish Color: \$660 (1) Piece Top, \$1,010 (2) Piece Top, \$1,355 (3) Piece Top
- MFW: White, MFS: Silver, MFGG: Graphite Gray, MFSS: Salmon Sienna, MFSA: Surfin Aquavert, MFPS: Pistachio, MFOS: Oyster, MFNA: Navy, MFOL: Olive, MFGB: Grey Beige

### GLASS FINISH

- Optional Soft Etch Finished glass
- EB: Black Soft Etch Glass, EW: White Soft Etch Glass - n/c

### POWER

- Glasspod cutouts will include an additional fee of \$125 per pod
- REF-310: Reef power unit with daisylink - \$1100 ea
- PD-Cove-PKO: Cove corded series - \$800 ea
- FPDB: Flush power/data bay
- Hardwired: FPDB-H72: 72" Cord - \$1250. FPDB-H108: 108" Cord - \$1300. FPDB-H144: 144" Cord - \$1350. FPDB-H180: 180" Cord - \$1400.
- Power/Plug: FPDB-C72: 72" Cord - \$1250. FPDB-C108: 108" Cord - \$1300. FPDB-C144: 144" - Cord \$1350. FPDB-C180: 180" Cord - \$1400

# Edgeworks.

Conference Tables

Rectangle 54" Depth Sitting Height

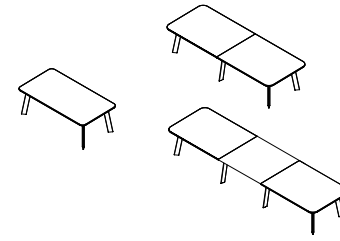

[View statement of line](#)

1 Select a model w" x d" x h"	weight	Standard Veneer Top Matte Black Metal Base		Premium Veneer Top Matte Black Metal Base		High Pressure Laminate Top Matte Black Metal Base		Thermally Fused Laminate Top Matte Black Metal Base	
		<b>3 Piece Top</b> 240 x 54 x 29 216 x 54 x 29 198 x 54 x 29 <b>2 Piece Top</b> 168 x 54 x 29 144 x 54 x 29 120 x 54 x 29 <b>1 Piece Top</b> 96 x 54 x 29 84 x 54 x 29 72 x 54 x 29		535 EDG24054RE123W 13393 450 EDG21654RE123W 11259 420 EDG19854RE123W 9942 350 EDG16854RE122W 7918 315 EDG14454RE122W 7622 280 EDG12054RE122W 7316 155 EDG9654RE121W 4461 135 EDG8454RE121W 4302 180 EDG7254RE121W 4139	EDG24054RE123P 14733 EDG21654RE123P 12385 EDG19854RE123P 10937 EDG16854RE122P 8710 EDG14454RE122P 8385 EDG12054RE122P 8048 EDG9654RE121P 4908 EDG8454RE121P 4733 EDG7254RE121P 4553	EDG24054RE123G 12526 EDG21654RE123G 10456 EDG19854RE123G 9337 EDG16854RE122G 7355 EDG14454RE122G 7103 EDG12054RE122G 6847 EDG9654RE121G 4155 EDG8454RE121G 4040 EDG7254RE121G 3921	EDG24054RE123M 10342 EDG21654RE123M 8212 EDG19854RE123M 7693 EDG16854RE122M 5892 EDG14454RE122M 5804 EDG12054RE122M 5766 EDG9654RE121M 3478 EDG8454RE121M 3446 EDG7254RE121M 3412	WLA WNW WAC WWP WEC WOC WAM WCM WWM WGW WBW WSW TBCO TBSW TSTV TSMV TSLV TOBW WBO WMO WSO GAC GSLV +10% GEC GWL GOC GAM GCM GWM GNW GSTV +10% MAC MEC MOC MGW MSW MTW MWL	Flat-1 Flat-2 Flat-3 (Black) (White) Ledge-1 Ledge-2 Ledge-3 (Finished) (Black) (White) Flat-1 Flat-2 Flat-3 (Black) (White) Ledge-1 Ledge-2 Ledge-3 (Finished) (Black) (White) Flat-1 Flat-2 Flat-3 (Black) (White) Ledge-1 Ledge-2 Ledge-3 (Finished) (Black) (White)

## Product features.

- 1" Thick top with rounded edges
- ENVI-CT finish on wood tops
- Matte black metal finish base standard
- 6" Radius corners
- 3" Adjustable glide

### NOTES

- 4 leg: 72" - 96" width
- 6 leg: 120" - 168" width
- 8 leg: 198" - 240" width

## Options.

### EDGE

- SC1: Modify radius corner to square corner - n/c

### INSET LEGS

- IL2: Inset legs for two piece top - 10% upcharge
- IL3: Inset legs for a three piece top - 10% upcharge

### POWER

- Two pods mounted under the hinged seamless grommet. Each pod has 4 power and 2 data ports. Telecom connectors sold separately.
- PSG82-C: Plug with 124" cord (8 power, 2 telecom plates) - \$1875 each
- W21: Grey Wire Manager (10.5") - \$35 ea.

### PREMIUM METAL FINISHES

- Specify Top Horn and Leg Metal Finish Color: \$660 (1) Piece Top, \$1,010 (2) Piece Top, \$1,355 (3) Piece Top
- MFW: White, MFS: Silver, MFGG: Graphite Gray, MFSS: Salmon Sienna, MFSA: Surfin Aquavert, MFPS: Pistachio, MFOS: Oyster, MFNA: Navy, MFOL: Olive, MFGB: Grey Beige
- PLANK MATCH VENEER
- RPMV: Random Walnut Plank Match Veneer (Horizontal Grain with 25%+ Sap) - Add 10%. Clear coat only.

# Edgeworks.

Glass Conference Tables  
Rectangle 54" Depth Sitting Height

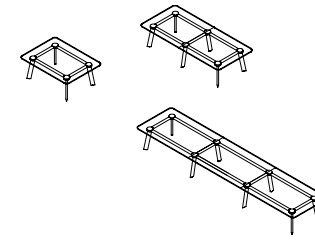

1 Select a model w" x d" x h"	weight	Clear Gloss Glass Top Matte Black Metal Base		White Gloss Glass Top Matte Black Metal Base		Black Gloss Glass Top Matte Black Metal Base	
<b>3 Piece Top</b>							
240 x 54 x 29	535	EDG24054RE123SC	14562	EDG24054RE123SW	21933	EDG24054RE123SB	21933
216 x 54 x 29	450	EDG21654RE123SC	12247	EDG21654RE123SW	18881	EDG21654RE123SB	18881
198 x 54 x 29	420	EDG19854RE123SC	11805	EDG19854RE123SW	17886	EDG19854RE123SB	17886
<b>2 Piece Top</b>							
168 x 54 x 29	350	EDG16854RE122SC	9080	EDG16854RE122SW	14240	EDG16854RE122SB	14240
144 x 54 x 29	315	EDG14454RE122SC	8491	EDG14454RE122SW	12913	EDG14454RE122SB	12913
120 x 54 x 29	280	EDG12054RE122SC	7999	EDG12054RE122SW	11587	EDG12054RE122SB	11587
<b>1 Piece Top</b>							
96 x 54 x 29	155	EDG9654RE121SC	5312	EDG9654RE121SW	8261	EDG9654RE121SB	8261
84 x 54 x 29	135	EDG8454RE121SC	5018	EDG8454RE121SW	7598	EDG8454RE121SB	7598
72 x 54 x 29	180	EDG7254RE121SC	4723	EDG7254RE121SW	6935	EDG7254RE121SB	6935
2 Select a finish View finish details		MFMB		MFMB		MFMB	
Metal finish MFMB Matte Black. Additional metal finishes are available, see options.							
3 Select a edge View edge details		Flat		Flat		Flat	
4 Select hardware View hardware details		Hardware N/A		Hardware N/A		Hardware N/A	

[View statement of line](#)

## Product features.

- 1/2" Clear glass top
- Matte black metal finish base standard
- 6" Radius corners
- 3" Adjustable glide
- Glass tops are glass finish, see options for Soft Etch Glass tops

### NOTES

- Contact our customer service department for custom inset leg quote with glass tops
- 4 leg: 72" - 96" width
- 6 leg: 120" - 168" width
- 8 leg: 198" - 240" width

## Options.

### EDGE

- SC1: Modify radius corner to square corner - n/c

### PREMIUM METAL FINISHES

- Specify Top Horn and Leg Metal Finish Color: \$660 (1) Piece Top, \$1,010 (2) Piece Top, \$1,355 (3) Piece Top
- MFV: White, MFS: Silver, MFGG: Graphite Gray, MFSS: Salmon Sienna, MFSA: Surfin Aquavert, MFPS: Pistachio, MFOS: Oyster, MFNA: Navy, MFOL: Olive, MFGB: Grey Beige

### GLASS FINISH

- Optional Soft Etch Finished glass
- EB: Black Soft Etch Glass, EW: White Soft Etch Glass - n/c

### POWER

- Glasspod cutouts will include an additional fee of \$125 per pod
- REF-310: Reef power unit with daisylink - \$1100 ea
- PD-Cove-PKO: Cove corded series - \$800 ea
- FPDB: Flush power/data bay
- Hardwired: FPDB-H72: 72" Cord - \$1250. FPDB-H108: 108" Cord - \$1300. FPDB-H144: 144" Cord - \$1350. FPDB-H180: 180" Cord - \$1400.
- Power/Plug: FPDB-C72: 72" Cord - \$1250. FPDB-C108: 108" Cord - \$1300. FPDB-C144: 144" - Cord \$1350. FPDB-C180: 180" Cord - \$1400

# Edgeworks.

Conference Tables  
Rectangle 54" Depth Standing Height

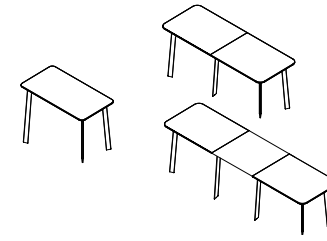

1 Select a model w" x d" x h"	weight	Standard Veneer Top Matte Black Metal Base		Premium Veneer Top Matte Black Metal Base		High Pressure Laminate Top Matte Black Metal Base		Thermally Fused Laminate Top Matte Black Metal Base		
		<b>3 Piece Top</b> 240 x 54 x 42 216 x 54 x 42 198 x 54 x 42 <b>2 Piece Top</b> 168 x 54 x 42 144 x 54 x 42 120 x 54 x 42 <b>1 Piece Top</b> 96 x 54 x 42 84 x 54 x 42 72 x 54 x 42		535 450 420	EDG24054RE143W EDG21654RE143W EDG19854RE143W	14103 11827 10510	EDG24054RE143P EDG21654RE143P EDG19854RE143P	15514 13010 11561	EDG24054RE143G EDG21654RE143G EDG19854RE143G	13235 11024 9905
		350 315 280	EDG16854RE142W EDG14454RE142W EDG12054RE142W	8343 8049 7743	EDG16854RE142P EDG14454RE142P EDG12054RE142P	9178 8854 8518	EDG16854RE142G EDG14454RE142G EDG12054RE142G	7780 7530 7273	EDG16854RE142M EDG14454RE142M EDG12054RE142M	6317 6230 6192
		155 135 180	EDG9654RE141W EDG8454RE141W EDG7254RE141W	4887 4657 4423	EDG9654RE141P EDG8454RE141P EDG7254RE141P	5376 5123 4866	EDG9654RE141G EDG8454RE141G EDG7254RE141G	4581 4324 4205	EDG9654RE141M EDG8454RE141M EDG7254RE141M	3904 3696 3729
2 Select a finish <i>View finish details</i>		WLA WAC WEC Metal finish MFMB Matte Black. Additional metal finishes are available, see options.	WNW WWP		TBCO TBSW TSTV TSMV TSLV TOBW WBO WMO WSO		GAC GEC GOC GAM GCM GWM GNW GSTV +10%	GSLV +10% GWL	MAC MEC MOC MGW MSW MTW MWL	
3 Select a edge <i>View edge details</i>		Flat-1 Flat-2 (Black) Flat-3 (White) Ledge-1 (Finished) Ledge-2 (Black) Ledge-3 (White)			Flat-1 Flat-2 (Black) Flat-3 (White) Ledge-1 (Finished) Ledge-2 (Black) Ledge-3 (White)		Flat-1 Flat-2 (Black) Flat-3 (White) Ledge-1 (Finished) Ledge-2 (Black) Ledge-3 (White)		Flat-1 Flat-2 (Black) Flat-3 (White)	
4 Select hardware <i>View hardware details</i>		Hardware N/A			Hardware N/A		Hardware N/A		Hardware N/A	

[View statement of line](#)

## Product features.

- 1" Thick top with rounded edges
- ENVI-CT finish on wood tops
- Matte black metal finish base standard
- 6" Radius corners
- 3" Adjustable glide

### NOTES

- 4 leg: 72" - 96" width
- 6 leg: 120" - 168" width
- 8 leg: 198" - 240" width

## Options.

### EDGE

- SC1: Modify radius corner to square corner - n/c

### INSET LEGS

- IL2: Inset legs for two piece top - 10% upcharge
- IL3: Inset legs for a three piece top - 10% upcharge

### POWER

- Two pods mounted under the hinged seamless grommet. Each pod has 4 power and 2 data ports. Telecom connectors sold separately.
- PSG82-C: Plug with 124" cord (8 power, 2 telecom plates) - \$1875 each
- W21: Grey Wire Manager (10.5") - \$35 ea.

### PREMIUM METAL FINISHES



- Specify Top Horn and Leg Metal Finish Color: \$660 (1) Piece Top, \$1,010 (2) Piece Top, \$1,355 (3) Piece Top
- MFW: White, MFS: Silver, MFGG: Graphite Gray, MFSS: Salmon Sienna, MFSA: Surfin Aquavert, MFPS: Pistachio, MFOS: Oyster, MFNA: Navy, MFOL: Olive, MFGB: Grey Beige
- PLANK MATCH VENEER
- RPMV: Random Walnut Plank Match Veneer (Horizontal Grain with 25%+ Sap) - Add 10%. Clear coat only.

# Edgeworks.

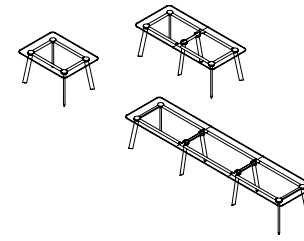
Glass Conference Tables  
Rectangle 54" Depth Standing Height



[View statement of line](#)

1 Select a model w" x d" x h"	weight	Clear Gloss Glass Top Matte Black Metal Base	White Gloss Glass Top Matte Black Metal Base	Black Gloss Glass Top Matte Black Metal Base
<b>3 Piece Top</b>				
240 x 54 x 42	535	EDG24054RE143SC 15271	EDG24054RE143SW 22643	EDG24054RE143SB 22643
216 x 54 x 42	450	EDG21654RE143SC 12815	EDG21654RE143SW 19449	EDG21654RE143SCB 19449
198 x 54 x 42	420	EDG19854RE143SC 12373	EDG19854RE143SW 18454	EDG19854RE143SB 18454
<b>2 Piece Top</b>				
168 x 54 x 42	350	EDG16854RE142SC 9506	EDG16854RE142SW 14666	EDG16854RE142SB 14666
144 x 54 x 42	315	EDG14454RE142SC 8916	EDG14454RE142SW 13339	EDG14454RE142SB 13339
120 x 54 x 42	280	EDG12054RE142SC 8326	EDG12054RE142SW 12012	EDG12054RE142SB 12012
<b>1 Piece Top</b>				
96 x 54 x 42	155	EDG9654RE141SC 5596	EDG9654RE141SW 8545	EDG9654RE141SB 8545
84 x 54 x 42	135	EDG8454RE141SC 5302	EDG8454RE141SW 7882	EDG8454RE141SB 7882
72 x 54 x 42	180	EDG7254RE141SC 5007	EDG7254RE141SW 7219	EDG7254RE141SB 7219
<b>2 Select a finish</b> <a href="#">View finish details</a>		MFMB	MFMB	MFMB
Metal finish MFMB Matte Black. Additional metal finishes are available, see options.				
<b>3 Select a edge</b> <a href="#">View edge details</a>				
		Flat	Flat	Flat
<b>4 Select hardware</b> <a href="#">View hardware details</a>		Hardware N/A	Hardware N/A	Hardware N/A

## Product features.

- 1/2" Clear glass top
- Matte black metal finish base standard
- 6" Radius corners
- 3" Adjustable glide
- Glass tops are glass finish, see options for Soft Etch Glass tops

### NOTES

- Contact our customer service department for custom inset leg quote with glass tops
- 4 leg: 72" - 96" width
- 6 leg: 120" - 168" width
- 8 leg: 198" - 240" width

## Options.

### EDGE

- SC1: Modify radius corner to square corner - n/c

### PREMIUM METAL FINISHES

- Specify Top Horn and Leg Metal Finish Color: \$660 (1) Piece Top, \$1,010 (2) Piece Top, \$1,355 (3) Piece Top
- MFW: White, MFS: Silver, MFGG: Graphite Gray, MFSS: Salmon Sienna, MFSA: Surfin Aquavert, MFPS: Pistachio, MFOS: Oyster, MFNA: Navy, MFOL: Olive, MFGB: Grey Beige

### GLASS FINISH

- Optional Soft Etch Finished glass
- EB: Black Soft Etch Glass, EW: White Soft Etch Glass - n/c

### POWER

- Glasspod cutouts will include an additional fee of \$125 per pod
- REF-310: Reef power unit with daisylink - \$1100 ea
- PD-Cove-PKO: Cove corded series - \$800 ea
- FPDB: Flush power/data bay
- Hardwired: FPDB-H72: 72" Cord - \$1250. FPDB-H108: 108" Cord - \$1300. FPDB-H144: 144" Cord - \$1350. FPDB-H180: 180" Cord - \$1400.
- Power/Plug: FPDB-C72: 72" Cord - \$1250. FPDB-C108: 108" Cord - \$1300. FPDB-C144: 144" - Cord \$1350. FPDB-C180: 180" Cord - \$1400

# Edgeworks.

Conference Tables  
Rectangle 60" Depth Sitting Height

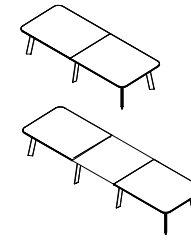

1 Select a model w" x d" x h"	weight	Standard Veneer Top Matte Black Metal Base		Premium Veneer Top Matte Black Metal Base		High Pressure Laminate Top Matte Black Metal Base		Thermally Fused Laminate Top Matte Black Metal Base	
		<b>3 Piece Top</b> 240 x 60 x 29 216 x 60 x 29 198 x 60 x 29 <b>2 Piece Top</b> 168 x 60 x 29 144 x 60 x 29 120 x 60 x 29	580 490 445 375 335 290	EDG24060RE123W EDG21660RE123W EDG19860RE123W EDG16860RE122W EDG14460RE122W EDG12060RE122W	14179 11990 10495 8430 8092 7743	EDG24060RE123P EDG21660RE123P EDG19860RE123P EDG16860RE122P EDG14460RE122P EDG12060RE122P	15597 13189 11545 9273 8902 8518	EDG24060RE123G EDG21660RE123G EDG19860RE123G EDG16860RE122G EDG14460RE122G EDG12060RE122G	13197 11078 9806 7792 7503 7207
<b>2 Select a finish</b> <i>View finish details</i>  <b>Metal finish</b> MFMB Matte Black. Additional metal finishes are available, see options.	WLA WNW WAC WWP WEC WOC WAM WCM WWM WGW WBW WSW	TBCO TBSW TSTV TSMV TSLV TOBW WBO WMO WSO	GAC GSWL +10% GEC GWL GOC GAM GCM GWM GNW GSTV +10%	MAC MEC MOC MGW MSW MTW MWL					
<b>3 Select a edge</b> <i>View edge details</i>									
<b>4 Select hardware</b> <i>View hardware details</i>	Hardware N/A	Hardware N/A	Hardware N/A	Hardware N/A					

*View statement of line*

## Product features.

- 1" Thick top with rounded edges
- ENVI-CT finish on wood tops
- Matte black metal finish base standard
- 6" Radius corners
- 3" Adjustable glide

### NOTES

- 6 leg: 120" - 168" width
- 8 leg: 198" - 240" width

## Options.

### EDGE

- SC1: Modify radius corner to square corner - n/c

### INSET LEGS

- IL2: Inset legs for two piece top - 10% upcharge
- IL3: Inset legs for a three piece top - 10% upcharge

### POWER

- Two pods mounted under the hinged seamless grommet. Each pod has 4 power and 2 data ports. Telecom connectors sold separately.
- PSG82-C: Plug with 124" cord (8 power, 2 telecom plates) - \$1875 each
- W21: Grey Wire Manager (10.5") - \$35 ea.

### PREMIUM METAL FINISHES

- Specify Top Horn and Leg Metal Finish Color: \$1,010 (2) Piece Top, \$1,355 (3) Piece Top
- MFW: White, MFS: Silver, MFGG: Graphite Gray, MFSS: Salmon Sienna, MFSA: Surfin Aquavert, MFPS: Pistachio, MFOS: Oyster, MFNA: Navy, MFOL: Olive, MFGB: Grey Beige

### PLANK MATCH VENEER



- RPMV: Random Walnut Plank Match Veneer (Horizontal Grain with 25%+ Sap) - Add 10%. Clear coat only.

# Edgeworks.

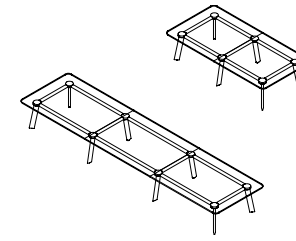
Glass Conference Tables  
Rectangle 60" Depth Sitting Height



[View statement of line](#)

1 Select a model w" x d" x h"	weight	Clear Gloss Glass Top Matte Black Metal Base	White Gloss Glass Top Matte Black Metal Base	Black Gloss Glass Top Matte Black Metal Base
		<b>3 Piece Top</b> 240 x 60 x 29 580 EDG24060RE123SC 15217 216 x 60 x 29 490 EDG21660RE123SC 12837 198 x 60 x 29 445 EDG19860RE123SC 12345 <b>2 Piece Top</b> 168 x 60 x 29 375 EDG16860RE122SC 9539 144 x 60 x 29 335 EDG14460RE122SC 8884 120 x 60 x 29 290 EDG12060RE122SC 8228		EDG24060RE123SW 23407 EDG21660RE123SW 20207 EDG19860RE123SW 19103  EDG16860RE122SW 15271 EDG14460RE122SW 13798 EDG12060RE122SW 12323
2 Select a finish <a href="#">View finish details</a>  Metal finish MFMB Matte Black. Additional metal finishes are available, see options.		MFMB	MFMB	MFMB
3 Select an edge <a href="#">View edge details</a>		 Flat	 Flat	 Flat
4 Select hardware <a href="#">View hardware details</a>		Hardware N/A	Hardware N/A	Hardware N/A

## Product features.

- 1/2" Clear glass top
- Matte black metal finish base standard
- 6" Radius corners
- 3" Adjustable glide
- Glass tops are gloss finish, see options for Soft Etch Glass tops

### NOTES

- Contact our customer service department for custom inset leg quote with glass tops
- 6 leg: 120" - 168" width
- 8 leg: 198" - 240" width

## Options.

### EDGE

- SC1: Modify radius corner to square corner - n/c

### PREMIUM METAL FINISHES

- Specify Top Horn and Leg Metal Finish Color: \$1,010 (2) Piece Top, \$1,355 (3) Piece Top
- MFW: White, MFS: Silver, MFGG: Graphite Gray, MFSS: Salmon Sienna, MFSA: Surfin Aquavert, MFPS: Pistachio, MFOS: Oyster, MFNA: Navy, MFOL: Olive, MFGB: Grey Beige

### GLASS FINISH

- Optional Soft Etch Finished glass
- EB: Black Soft Etch Glass, EW: White Soft Etch Glass - n/c

### POWER

- Glasspod cutouts will include an additional fee of \$125 per pod
- REF-310: Reef power unit with daisylink - \$1100 ea
- PD-Cove-PKO: Cove corded series - \$800 ea
- FPDB: Flush power/data bay
- Hardwired: FPDB-H72: 72" Cord - \$1250. FPDB-H108: 108" Cord - \$1300. FPDB-H144: 144" Cord - \$1350. FPDB-H180: 180" Cord - \$1400.
- Power/Plug: FPDB-C72: 72" Cord - \$1250. FPDB-C108: 108" Cord - \$1300. FPDB-C144: 144" - Cord \$1350. FPDB-C180: 180" Cord - \$1400



# Edgeworks.

Conference Tables  
Rectangle 60" Depth Standing Height

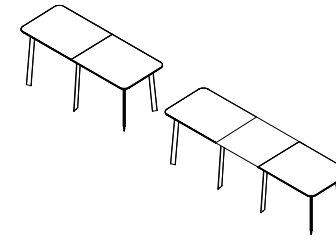

1 Select a model w" x d" x h"	weight	Standard Veneer Top Matte Black Metal Base		Premium Veneer Top		High Pressure Laminate Top Matte Black Metal Base		Thermally Fused Laminate Top Matte Black Metal Base	
		<b>3 Piece Top</b> 240 x 60 x 42 216 x 60 x 42 198 x 60 x 42 <b>2 Piece Top</b> 168 x 60 x 42 144 x 60 x 42 120 x 60 x 42	580 490 445 375 335 290	EDG24060RE143W EDG21660RE143W EDG19860RE143W EDG16860RE142W EDG14460RE142W EDG12060RE142W	14890 12558 11062 8857 8518 8168	EDG24060RE143P EDG21660RE143P EDG19860RE143P EDG16860RE142P EDG14460RE142P EDG12060RE142P	16379 13814 12169 9743 9370 8985	EDG24060RE143G EDG21660RE143G EDG19860RE143G EDG16860RE142G EDG14460RE142G EDG12060RE142G	13907 11646 10374 8217 7928 7634
<b>2 Select a finish</b> <a href="#">View finish details</a>  Metal finish MFMB Matte Black. Additional metal finishes are available, see options.	WLA WNW WAC WWP WEC WOC WAM WCM WWM WGW WBW WSW	TBCO TBSW TSTV TSMV TSLV TOBW WBO WMO WSO	GAC GSWL +10% GEC GWL GOC GAM GCM GWM GNW GSTV +10%	MAC MEC MOC MGW MSW MTW MWL					
<b>3 Select an edge</b> <a href="#">View edge details</a>									
<b>4 Select hardware</b> <a href="#">View hardware details</a>	Hardware N/A	Hardware N/A	Hardware N/A	Hardware N/A					

[View statement of line](#)

## Product features.

- 1" Thick top with rounded edges
- ENVI-CT finish on wood tops
- Matte black metal finish base standard
- 6" Radius corners
- 3" Adjustable glide

### NOTES

- 6 leg: 120" - 168" width
- 8 leg: 198" - 240" width

## Options.

### EDGE

- SC1: Modify radius corner to square corner - n/c

### INSET LEGS

- IL2: Inset legs for two piece top - 10% upcharge
- IL3: Inset legs for a three piece top - 10% upcharge

### POWER

- Two pods mounted under the hinged seamless grommet. Each pod has 4 power and 2 data ports. Telecom connectors sold separately.
- PSG82-C: Plug with 124" cord (8 power, 2 telecom plates) - \$1875 each
- W21: Grey Wire Manager (10.5") - \$35 ea.

### PREMIUM METAL FINISHES

- Specify Top Horn and Leg Metal Finish Color: \$1,010 (2) Piece Top, \$1,355 (3) Piece Top
- MFW: White, MFS: Silver, MFGG: Graphite Gray, MFSS: Salmon Sienna, MFSA: Surfing Aquavert, MFPS: Pistachio, MFOS: Oyster, MFNA: Navy, MFOL: Olive, MFGB: Grey Beige

### PLANK MATCH VENEER

- RPMV: Random Walnut Plank Match Veneer (Horizontal Grain with 25%+ Sap) - Add 10%. Clear coat only.

# Edgeworks.

Glass Conference Tables  
Rectangle 60" Depth Standing Height

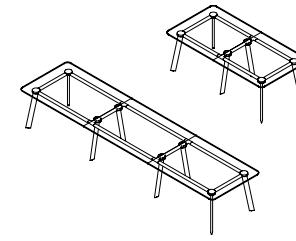

[View statement of line](#)

1 Select a model w" x d" x h"	weight	Clear Gloss Glass Top Metal Base		White Gloss Glass Top Metal Base		Black Gloss Glass Top Metal Base	
		<b>3 Piece Top</b>					
240 x 60 x 42	580	EDG24060RE143SC	15927	EDG24060RE143SW	24117	EDG24060RE143SB	24117
216 x 60 x 42	490	EDG21660RE143SC	13405	EDG21660RE143SW	20775	EDG21660RE143SB	20775
198 x 60 x 42	445	EDG19860RE143SC	12913	EDG19860RE143SW	19671	EDG19860RE143SB	19671
<b>2 Piece Top</b>							
168 x 60 x 42	375	EDG16860RE142SC	9964	EDG16860RE142SW	15698	EDG16860RE142SB	15698
144 x 60 x 42	335	EDG14460RE142SC	9309	EDG14460RE142SW	14223	EDG14460RE142SB	14223
120 x 60 x 42	290	EDG12060RE142SC	8654	EDG12060RE142SW	12749	EDG12060RE142SB	12749
2 Select a finish <a href="#">View finish details</a>		MFMB		MFMB		MFMB	
Metal finish MFMB Matte Black. Additional metal finishes are available, see options.							
3 Select an edge <a href="#">View edge details</a>		Flat					
4 Select hardware <a href="#">View hardware details</a>		Hardware N/A					

## Product features.

- 1/2" Clear glass top
- Matte black metal finish base standard
- 6" Radius corners
- 3" Adjustable glide
- Glass tops are glass finish, see options for Soft Etch Glass tops

### NOTES

- Contact our customer service department for custom inset leg quote with glass tops
- 6 leg: 120" - 168" width
- 8 leg: 198" - 240" width

## Options.

### EDGE

- SC1: Modify radius corner to square corner - n/c

### PREMIUM METAL FINISHES

- Specify Top Horn and Leg Metal Finish Color: \$1,010 (2) Piece Top, \$1,355 (3) Piece Top
- MFW: White, MFS: Silver, MFGG: Graphite Gray, MFSS: Salmon Sienna, MFSA: Surfin Aquavert, MFPS: Pistachio, MFOS: Oyster, MFNA: Navy, MFOL: Olive, MFGB: Grey Beige

### GLASS FINISH

- Optional Soft Etch Finished glass
- EB: Black Soft Etch Glass, EW: White Soft Etch Glass - n/c

### POWER

- Glasspod cutouts will include an additional fee of \$125 per pod
- REF-310: Reef power unit with daisylink - \$1100 ea
- PD-Cove-PKO: Cove corded series - \$800 ea
- FPDB: Flush power/data bay
- Hardwired: FPDB-H72: 72" Cord - \$1250. FPDB-H108: 108" Cord - \$1300. FPDB-H144: 144" Cord - \$1350. FPDB-H180: 180" Cord - \$1400.
- Power/Plug: FPDB-C72: 72" Cord - \$1250. FPDB-C108: 108" Cord - \$1300. FPDB-C144: 144" - Cord \$1350. FPDB-C180: 180" Cord - \$1400

# Edgeworks.

Full Pedestal Credenzas  
 Conferencing Storage Credenza

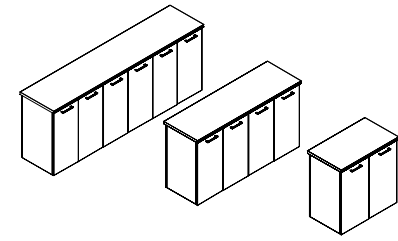

## 1 Select a model w" x d" x h"

weight	Standard Veneer Top Standard Veneer Chassis		Premium Veneer Top Premium Veneer Chassis		High Pressure Laminate Top Standard Veneer Chassis		Thermally Fused Laminate Top Thermally Fused Laminate Chassis	
	<b>Double Storage</b>							
72 x 24 x 36	EDG7224CA124W	4107	EDG7224CA124P	4518	EDG7224CA124G	4107	EDG7224CA124M	2725
66 x 24 x 36	EDG6624CA124W	3972	EDG6624CA124P	4369	EDG6624CA124G	3972	EDG6624CA124M	2676
60 x 24 x 36	EDG6024CA124W	3837	EDG6024CA124P	4221	EDG6024CA124G	3837	EDG6024CA124M	2626
48 x 24 x 36	EDG4824CA124W	3508	EDG4824CA124P	3859	EDG4824CA124G	3508	EDG4824CA124M	2473
<b>Single Storage</b>								
36 x 24 x 36	EDG3624CA124W	2335	EDG3624CA124P	2569	EDG3624CA124G	2335	EDG3624CA124M	1507

[View statement of line](#)

## 2 Select a finish [View finish details](#)

- WLA WNW
- WAC WWP
- WEC
- WOC
- WAM
- WCM
- WWM
- WGW
- WBW
- WSW

- TBCO
- TBSW
- TSTV
- TSMV
- TSLV
- TOBW
- WBO
- WMO
- WSO

- GAC GSWL +10%
- GEC GWL
- GOC
- GAM
- GCM
- GWM
- GNW
- GSTV
- +10%

- MAC
- MEC
- MOC
- MGW
- MSW
- MTW
- MWL

## 3 Select an edge [View edge details](#)

- Flat-1
- Flat-2 (Black)
- Flat-3 (White)
- Ledge-1 (Finished)
- Ledge-2 (Black)
- Ledge-3 (White)

- Flat-1
- Flat-2 (Black)
- Flat-3 (White)
- Ledge-1 (Finished)
- Ledge-2 (Black)
- Ledge-3 (White)

- Flat-1
- Flat-2 (Black)
- Flat-3 (White)
- Ledge-1 (Finished)
- Ledge-2 (Black)
- Ledge-3 (White)

- Flat-1
- Flat-2 (Black)
- Flat-3 (White)

## 4 Select hardware [View hardware details](#)

- PL-115 Matte Black
- PL-116 Matte Nickel
- PL-210 Anodized Aluminum
- PL-260 Anodized Aluminum
- PL-261 White

- PL-115 Matte Black
- PL-116 Matte Nickel
- PL-210 Anodized Aluminum
- PL-260 Anodized Aluminum
- PL-261 White

- PL-115 Matte Black
- PL-116 Matte Nickel
- PL-210 Anodized Aluminum
- PL-260 Anodized Aluminum
- PL-261 White

- PL-115 Matte Black
- PL-116 Matte Nickel
- PL-210 Anodized Aluminum
- PL-260 Anodized Aluminum
- PL-261 White

## Product features.

- Adjustable glides
- "M" styles shelves match finish
- "W"/"G" styles have black adjustable shelf behind door set

### NOTES

- All units are std with flush ends

## Options.

### ACCESSORIES

- REF-01: Modify Storage section for refrigerator - \$205

### AUDIO VISUAL

- AVR1: AV Exhaust Fan - \$470
- AVR2: AV Pullout Rack - \$1655

### DOOR

- D2: Wood Door Lock - \$100 per door set
- D6: Delete doors - n/c
- D6A: "W"/"G" Styles - Delete Doors and replace black laminate shelf with finished shelf - n/c
- D9SC: Soft Close Door Hinges - \$20 per door
- WPD3061: Designer White - \$80 per door

### GROMMETS (STANDARD LOCATION)

- Specify Color and Left/Right/Center - \$50 ea.
- Black: TM30-R (Right), TM30-L (Left), TM30-C (Center)
- Silver: TM31-R (Right), TM31-L (Left), TM31-C (Center)
- White: TM34-R (Right), TM34-L (Left), TM34-C (Center)

### GROMMETS (NON-STANDARD LOCATION)

- Provide drawing w/ Grommet Location and Specify Color - \$95 ea.
- Black: TM30-NS
- Silver: TM31-NS
- White: TM34-NS
- Grommets (Vertical Surface)
- Standard Location - \$50 ea.
- Black Plastic Vertical Surface: TM50-C (Bottom Center)
- Non-Standard Location - \$95 ea.
- Black Plastic Vertical Surface: TM50-NS
- Open Plan - Finished Back
- OPB: "W" "G" Style - Modify Unit for Open Plan Application - \$195
- OPB: "M" Style - Modify Unit for Open Plan Application - \$95
- Shelf
- S25: Replace Black Laminate Shelf with Finished Shelf - \$80 per shelf ("W" styles only)

Options.



COMPUTER SUPPORT  
*single monitor arm*

Style Number	List Price
MA1	280

Specifications

- Available in black or silver
- Desk clamp and mounting included
- Easy assembly and flexibility
- Elastic painting process for a durable and beautiful finish
- Gas spring tension adjustment for counter-balance height adjustment for monitors 1-8 KG
- Gas spring tested to 50,000 repetitions
- Hidden cable management



COMPUTER SUPPORT  
*double monitor arm*

Style Number	List Price
MA2	450

Specifications

- Available in black or silver
- Desk clamp and mounting included
- Easy assembly and flexibility
- Elastic painting process for a durable and beautiful finish
- Gas spring tension adjustment for counter-balance height adjustment for monitors 1-8 KG
- Gas spring tested to 50,000 repetitions
- Hidden cable management



COMPUTER SUPPORT  
*triple monitor arm*

Style Number	List Price
MA3	530

Specifications

- Available in black or silver
- Desk clamp and mounting included
- Easy assembly and flexibility
- Elastic painting process for a durable and beautiful finish
- Gas spring tension adjustment for counter-balance height adjustment for monitors 1-8 KG
- Gas spring tested to 50,000 repetitions
- Hidden cable management



COMPUTER SUPPORT  
*quadruple monitor arm*

Style Number	List Price
MA4	705

Specifications

- Available in black
- Desk clamp and mounting included
- Easy assembly and flexibility
- Elastic painting process for a durable and beautiful finish
- Gas spring tension adjustment for counter-balance height adjustment for monitors 1-8 KG
- Gas spring tested to 50,000 repetitions
- Hidden cable management

## Options.

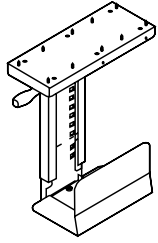

### COMPUTER SUPPORT *cpu retractable cradle*

Style Number	List Price
K18	205

### Specifications

- Black Metal CPU Carriage
- Full 360° swivel capability allows easy access to rear of CPU for cables / wires
- Track allows 8- 1/2" extension
- Width Adjustment 5-1/2" to 9-1/4"
- Height adjustment 14- 5/8" to 20- 1/2"
- Black epoxy finish

**Notes**

- Factory Installed



### DOOR MODIFICATIONS *soft close door hinge*

Style Number	List Price
D9SC	20 Per door

### Specifications

- Snap onto standard door hinge
- Requires (2) per door
- Max door height 43"
- Factory installed where specified
- Individually shipped for field installation

**Notes**

- Specify Each Item To Have Slow Close Feature

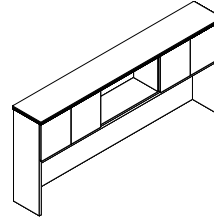

### DOOR MODIFICATIONS *delete doors*

Style Number	List Price
D6	N/C

### Specifications

- Standard Door overheads and cabinets can have door deleted for open access. Modification of hinge rails and structural components are made face ready.

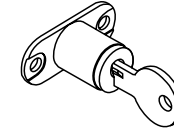

### DOOR MODIFICATIONS *panel door lock*

Style Number	List Price
D2	100 Per door set

### Specifications

- Door Locks - 1 Door w/ Lock, Other Door w/ Catch Latch
- Contact Customer Service regarding limited lock locations and keying.

**Notes**

- Available on: Panel Doors, Wood Frame Doors, and Silverluma doors

## Options.

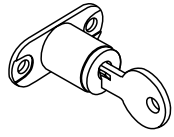

### DOOR MODIFICATIONS *glass door lock*

Style Number	List Price
D2-G	205 Per door set

### Specifications

- Door Locks - 1 Door w/ Lock, Other Door w/ Catch Latch
- Contact Customer Service regarding limited lock locations and keying.

Notes  
- Available on: Glass Doors

### GLASSBOARD ACCESSORIES *glassboard accessory kit*

Style Number	List Price
GBKIT	290

### Specifications

- 8 Earth magnets, 1 magnetic marker cup holder and 1 magnetic dry eraser



### RECESSED LIGHTING *lt-led task light*

Style Number	List Price
24" Task light LT-LED24R	190
48" Task light LT-LED48R	245
60" Task light LT-LED60R	310
72" Task light LT-LED72R	335

### Specifications

- 6.5' Power cord. Switch with touch dimmer
- 36 LEDs per foot
- 4.6 Watts per foot
- 91 Lumens per watt
- Please note when ganging.

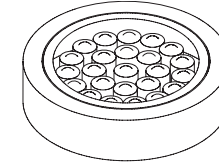

### LIGHTING *led interior cabinet puck light*

Style Number	List Price
Starter Kit LEDPK	310
1 LED Interior Puck Light PK	135

### Specifications

- Starter kit includes Infeed, 1 Puck Interior Light and the ability to daisy chain up to 6 total Puck Lights
- (1) LED Puck Light with 30W power drive and switch
- Recessed fixture
- 12V linking cord 98"L
- Silver finish
- 50,000 hour life
- 2 watt per light

Notes  
- Available on: Overhead/Tower Units with glass doors or no doors  
- Power drive included, Light only

## Options.

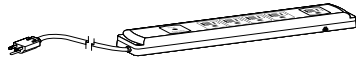

### POWER / DATA *power supply cordset*

Style Number	List Price
PD717	100

### Specifications

- SIZE: 10.75"L x 2.0"W x 1.06"H
- (5) Outlets w/ 10' cord
- Surge suppression (720 Joules)
- 15 Amp breaker
- Available on: Vertical Panels, Cabinet Interiors, and under tops

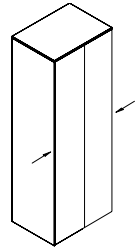

### PRODUCT MODIFICATIONS *modify width - open/closed storage*

Style Number	List Price
MOD-2	250

### Specifications

- Modify width down on any unit with open or closed storage section: overheads, wall hung units, storage credenzas

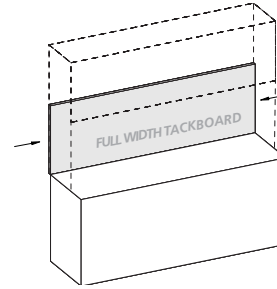

### PRODUCT MODIFICATIONS *modify width - tackboard, slat wall, veneer panel, or a glassboard*

Style Number	List Price
MOD-4	50

### Specifications

- Modify width down on tackboard, slat wall, veneer panel, or a overhead glassboard

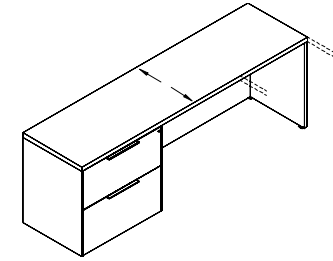

### PRODUCT MODIFICATIONS *modify depth - increase depth*

Style Number	List Price
MOD-6	Add 10%

### Specifications

- Increase depth by no more than 6"

#### Notes

- Ex. 24" to 30", 30" to 36", and 36" to 42"
- Add 10% to the unit you want to increase the depth of by no more than 6"

# Options.

## PRODUCT MODIFICATIONS *modify height*

Style Number	List Price
MOD-7	Contact for pricing

## Specifications

- Modify height of a unit

## PRODUCT MODIFICATIONS *modify conference table length and width - 1 piece top*

Style Number	List Price
MOD-8	125

## Specifications

- Modify length/width on a 1 piece table top

## PRODUCT MODIFICATIONS *modify conference table length and width - 2/3 piece top*

Style Number	List Price
MOD-9	250

## Specifications

- Modify length/width on a 2 or 3 piece table top

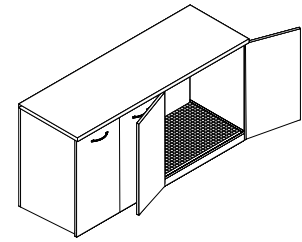

## REFRIGERATOR MODIFICATION *refrigerator cabinet modification*

Style Number	List Price
REF01	205

## Specifications

- Open back cutout for venting
- Moisture sponge mat
- Contaminate ledge
- Contact customer service for maximum refrigerator size (Changes based on unit).

### Notes

- Available on: 36" and 42" Storage Credenzas



## Options.

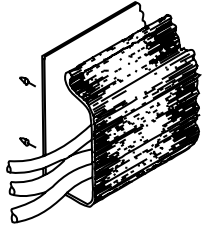

### WIRE MANAGEMENT *horizontal j-channel wire management raceway*

Style Number	List Price
W1	80 Per 4' section

### Specifications

- 4' section for field installation.
- The "J" shape black thermoplastic wire raceway may be added to specified worksurface tops to provide concealed channeling of wires to and from worksurface grommets. For use in open kneespace areas, raceway is attachable to top of back panel with pan head screws. Interior dimensions are 1" x 1- 1/2" providing ample storage for multiple wires and excess cable. Front of raceway flexes out for easy cord insertion.

#### Notes

- Units w/ Wire Channel Standard.
- Field Installation

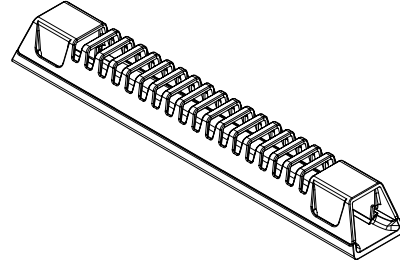

### WIRE MANAGEMENT *horizontal wire management raceway*

Style Number	List Price
W21	35

### Specifications

- 10"W x 1.5"D x 1.25"H
- Grey Wire Manager (10.5")
- Power and data cables can be discretely housed and managed with the W21 Gray Wire Manager. This can be mounted in any location to metal frame or underside of conference tables and runs cables through a 1" channel from power module to hollow steel legs. This keeps cables organized under the table top. Release clips make it simple to snap on and off the Wire Manager for easy organization and access after attached to the table

#### Notes

- Field installed

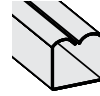

### WIRE MANAGEMENT *horizontal u-channel wire management raceway*

Style Number	List Price
W2A	80 Per 4' section

### Specifications

- 4' section for field installation.

#### Notes

- Units w/ Wire Channel Standard.
- Field Installation



### WIRE MANAGEMENT *coil wire manager*

Style Number	List Price
W18	160

### Specifications

- Weighted Base, Table attachment plate
- 39- 1/2" Length
- Black

#### Notes

- Location

Options.

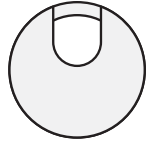

WIRE MANAGEMENT

*standard location grommets - factory installed*

Style Number	List Price
Standard Location Grommet	
Black	
TM30	50
Silver	
TM31	50
Antique Brass	
TM33	50
White	
TM34	50

Specifications

- 1 -5/8" Metal Grommet

Notes

- \*Units w/ Grommets Standard Are Noted Under Standard Features. Grommets Match Pull Finish - Standard (Unless Specified Otherwise)

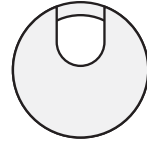

WIRE MANAGEMENT

*non-standard location grommets - factory installed*

Style Number	List Price
Non-Standard Location Grommet	
Black	
TM30 -NS	95
Silver	
TM31 -NS	95
Antique Brass	
TM33 -NS	95
White	
TM34 -NS	95

Specifications

- 1 -5/8" Metal Grommet

Notes

- \*Units w/ Grommets Standard Are Noted Under Standard Features. Grommets Match Pull Finish - Standard (Unless Specified Otherwise)



WIRE MANAGEMENT

*black plastic vertical surface grommets - factory installed*

Style Number	List Price
Standard Location Grommet	
TM50-C	50
Non-Standard Location Grommet	
TM50-NS	95

Specifications

- 2 " Black Plastic Grommet

Notes

- Standard Location is Bottom Center

## power & data options.

Aircharge wireless charging grommet

Style Number	List Price
 ACWG WIRELESS GROMMET	\$195

## Specifications

- › When used with GROVE Tables an additional \$350 LIST will apply for the special cutout required.
- › AirCharge offers a convenient way to charge any Qi compatible smartphone or device without the need to carry charging cables or find an available power outlet.
- › The Aircharge is powered by the latest Qi compliant IC offering reliable and efficient wireless charging in a convenient 3" grommet hub. Simply place your phone on the Aircharge and an LED will confirm pairing and begin wireless charging.
- › Recess: Efficient space conservation and quick access
- › Input: DC 5V (with included AC power adapter), DC 9V, 1.67A (with optional QC 2.0 power adapter)
- › Output: 5 watts Max. with DC 5V, 2A power adapter, 10 watts Max. with QC 2.0 power adapter
- › Qi V1.2 compliant IC
- › Charging distance: 6mm Max.

Available: All DARRAN collections



## power & data options.

Cove power unit - non-linking

Style Number

List Price



PD-COVE PLUG

\$550

Non-linking version

### Specifications

- › Size 5.75" L x 2.5" W
- › (2) 15 Amp Receptacles and (2) USB charging ports
- › Surface Mount
- › 108" Cord
- › Standard Silver Finish, Available in White or Black Finish upon request
- › ETL Listed

Available: All DARRAN collections



## power & data options.

Cove power unit with daisylink

Style Number	List Price
--------------	------------

### STARTER UNITS



COV-DCH HARDWIRED	\$710
-------------------	-------

Includes (1) Cove unit with Hardwire Infeed - 120"



COV-DCP PLUG	\$800
--------------	-------

Includes (1) Cove unit with Plug infeed -  
Includes 72" Cord and 32" Infeed Jumper for  
104" total cord infeed

### ADDITIONAL LINKING UNITS

COV-DCL	\$575 EACH
---------	------------

Includes Linking Cove unit and Jumper up to  
96", cable length determined by the top size

## Specifications

- › Size: 5.75"L x 2.5"W
- › (2) 15 Amp Receptacles and (2) 2.1 Amp USB charging ports
- › Surface Mount
- › Max Daisy Chain - Hardwire - (9) units; Plug/Corded - (4) units
- › Standard Silver Finish, Available in White or Black Finish upon request
- › ETL Listed

Available: All DARRAN collections



## power & data options.

Cove corded series

Style Number

List Price



PD-COVE-PKO

\$800

## Specifications

- › Size 9.5" L x 2.5" W x 3.18" D
- › When used with GROVE Tables an additional \$350 LIST will apply for the special cutout required.
- › (2) Power Receptacles, (2) 2.1 Amp USB charging ports and (1) Telecom Plate Knockout
- › Surface Mount
- › 108" Cord
- › Standard Silver Finish, Available in White or Black Finish upon request
- › ETL Listed

Available: All DARRAN collections

### Telecom Plates

RJ45 (1)	\$35
RJ45 (2)	\$70
RJ45 (3)	\$105
USB (1)	\$70
USB (2)	\$140
RJ11/RJ45	\$70
RJ45/USB	\$105
RJ45/HDMI	\$190
HDMI/DVI	\$325
HDMI/USB	\$205
HDMI/VGA	\$240
VGA/MINI-STEREO	\$155
VGA/USB	\$175

This pod can have up to 1 total plates.  
\*All telecom connectors sold separately.



## power & data options.

Dual

Style Number	List Price
STARTER UNITS	
PD-DUAL3P3J	\$1170
3 modules; 3' jumpers	
PD-DUAL3P6J	\$1185
3 modules; 6' jumpers	
PD-DUAL3P12J	\$1200
3 modules; 12' jumpers	
PD-DUAL4P3J	\$1450
4 modules; 3' jumpers	
PD-DUAL4P6J	\$1470
4 modules; 6' jumpers	
PD-DUAL4P12J	\$1490
4 modules; 12' jumpers	
PD-DUAL8P3J	\$2825
8 modules; 3' jumpers	
PD-DUAL8P6J	\$2865
8 modules; 6' jumpers	
PD-DUAL8P12J	\$2905
8 modules; 12' jumpers	

## Specifications

- > Size: 3" x 1.75" x 1.25"
- > (2) 2.4 Amp USB charging ports per module
- > Undersurface mount
- > 72" cord
- > Standard black finish, available in white upon request
- > UL certified

Available: Conference, Milner, ThinkingQuietly

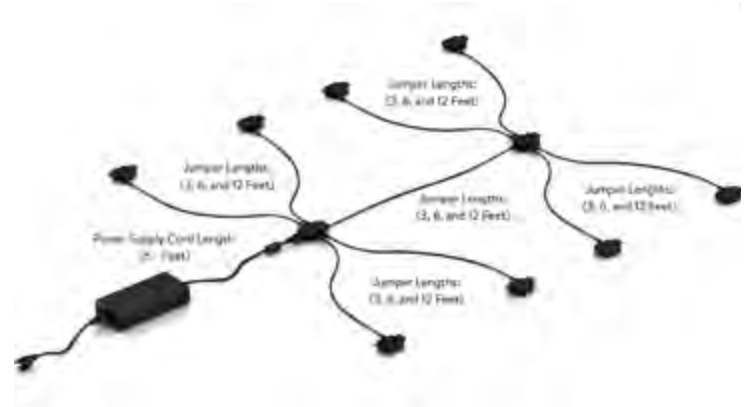

## power & data options.

### Keno power unit

Style Number

List Price



PD-KENO

\$195

Select power block to link workstations

## Specifications

- > Size 5.5" L x 2.125" W x 2.5" H
- > 2 TR AC Outlets
- > 1 4.2A USB module w/ 2 charging ports
- > 10' Power cord

Available: EdgeWorks, NSS Open, Rail, Rail Open Office, ThinkingQuietly

### Telecom Plates

With 120" hardwire power cord.

Two Pack Power Block System: 2PPBS	\$390
Four Pack Power Block System: 4PPBS	\$750
Six Pack Power Block System: 6PPBS	\$1100



White



Black



## power & data options.

Reef power unit with daisylink

Style Number	List Price
 REF310 PLUG	\$1100

## Specifications

- › Size 16.1”L x 6.25”W x 4.89”D
- › When used with GROVE Tables an additional \$350 LIST will apply for the special cutout required.
- › (3) 120V Receptacles, (2) USB charging ports, 1 Data Plate Knockout, (2) Knockouts for RJ45 Data Ports
- › Surface Mount
- › 108” Cord
- › Features Convenience Plug on bottom of unit that allows for max (3) Daisy Chain
- › Standard Black Finish, Available in White or Silver Finish upon request
- › Additional Telecom Plate Knockout
- › RJ45 for Knockouts not required. If not ordered a small hole will be present in the pod in this this location
- › ETL Listed

Available: Conferencing

Telecom Plates	
RJ45 (1)	\$35
RJ45 (2)	\$70
RJ45 (3)	\$105
USB (1)	\$70
USB (2)	\$140
RJ11/RJ45	\$70
RJ45/USB	\$105
RJ45/HDMI	\$190
HDMI/DVI	\$325
HDMI/USB	\$205
HDMI/VGA	\$240
VGA/MINI-STEREO	\$155
VGA/USB	\$175

This pod can have up to 1 total plates.  
\*All telecom connectors sold separately.



## power & data options.

Powered seamless grommet

Style Number	List Price
	
Power/Plug	
PSG82-C: PLUG	\$1875

## Specifications

- › Grommet comes with 2 Power Pods that are mounted under the Seamless Grommet. Pods daisylink together with (2) innerconnecting cables.
- › Soft close door
- › Size: 11.5”L x 8.25W”
- › (4) Power Receptacles per power pod, 8 total
- › 124” Power cord
- › Standard Black Finish
- › UL Listed
- › (2) 2.1 Dual USB ports per pod, 4 total
- › (2) Data ports per pod, 4 total
- › Contact customer service when daisy chaining 2 Seamless grommets together.

Available: ThinkingQuietly, Diva, EdgeWorks, Rift, Conference

Telecom Plates	
RJ45 (1)	\$35
RJ45 (2)	\$70
RJ45/HDMI	\$190
HDMI/VGA	\$240
RJ45/VGA	\$190

This pod can have up to 1 total plates.  
 \*All telecom connectors sold separately.



## power & data options.

Seclusion corded power unit non-linking

Style Number	List Price
 P2SECL	\$245
Choose from plate mount or clamp mount (seen in photo)	

### Specifications

- > Size: 3.5"L x 2.2"D x 2.5"H
- > (2) Power Receptacles
- > Worksurface Clamp Mount or Plate Under Surface Mount
- > Clamp Accessory accommodates table thickness up to 2"
- > 72" Cord
- > Standard Silver Finish, Black Finish available upon request
- > UL/UCL Listed

Available: All DARRAN collections



Clamp Mount

## power & data options.

Soba wire manager

Style Number	List Price
STARTER UNITS	
SCDW	\$200
White wire manager	
SCDB	\$200
Black wire manager	

## Specifications

- › Dimensions: 9ft x 9in x 3.15in
- › Zips up, bundles and routes loose, messy cables into a single tube
- › Routes and guides cables behind desks, TVs, and anywhere cables tend to get messy
- › Accommodates large or small cables, up to three cables at once
- › Support channels, used to route cables, include powerful adhesive backing which allows easy attachment to surfaces.

Available: All DARRAN collections



## power & data options.

Tully power unit

Style Number List Price



PD-TULLY \$320

Select power block to link workstations

### Specifications

- › 5.5" W x 3.2" H x 1.81" D
- › Finish: Smooth molded plastic integrated within a single piece cover
- › Mounts to the edge of your work surface, with no table cut outs or installation required.
- › (2) Power receptacles, (2) USB 2.1 Amp ports
- › 72" Cord (10' cord available, contact customer service).
- › Standard in White. Available in gray, black, neon red, harvest pumpkin, light green, daisy blue.
- › UL310, Class 2, FCC Part 15A approved
- › Clamp accessory accomodates table thickness from .75"-1.5"

Available: EdgeWorks, NSS Open, Rail, Rail Open Office, ThinkingQuietly.

#### Power Block

With 120" hardwire power cord.

Two Pack Power Block System: 2PPBS \$390

Four Pack Power Block System: 4PPBS \$750

Six Pack Power Block System: 6PPBS \$1100

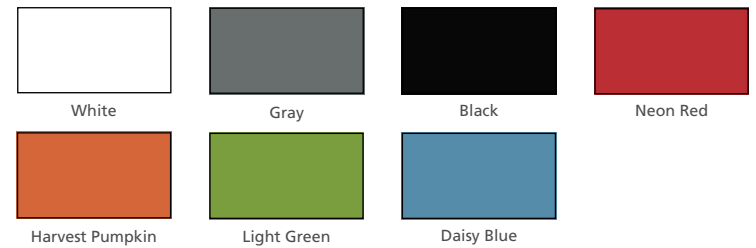

## power & data options.

Tully data power unit

Style Number List Price



PD-TULLY-DATA \$400

Select power block to link workstations

### Specifications

- > 5.5" W x 3.2" H x 1.81" D
- > Finish: Smooth molded plastic integrated within a single piece cover
- > Mounts to the edge of your work surface, with no table cut outs or installation required.
- > (2) Power receptacles, (2) knockouts for HDMI, VGA, or RJ45 (Please specify).
- > 72" Cord (10' cord available, contact customer service).
- > Standard in White. Available in gray, black, neon red, harvest pumpkin, light green, daisy blue.
- > UL310, Class 2, FCC Part 15A approved
- > Clamp accessory accommodates table thickness from .75"-1.5"
- > Includes 2 wire management grommets

Available: Bota booth table

#### Power Block

With 120" hardwire power cord.

Two Pack Power Block System 2PPBS	\$390
Four Pack Power Block System 4PPBS	\$750
Six Pack Power Block System 6PPBS	\$1100

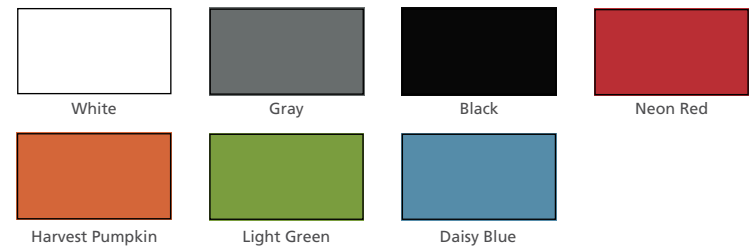

# Home office price list



effective july 1, 2021

## Home office table of contents

Statement of Line	
Finishes.....	1
Metals .....	2
Edges   Pulls.....	3
Grommet   Grommet Reference .....	5
"L" Shaped Workstation.....	6
Printer Desk .....	7
Drop Leaf Table .....	8
Student Desk .....	9
Table Desk .....	10
Privacy Screen .....	18
Freestanding Credenza .....	20
Moblie Pedestal .....	21
Single Pedestal Desk .....	23
Bookcase .....	24
Freestanding Table .....	26
Options.....	27
Power & Data .....	32



# Home office statement of line.

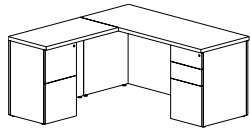

PAGE 6  
Home Office - Central park  
Flush Chassis "L" Workstation

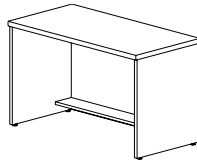

PAGE 7  
Home Office - Central park  
Computer Resource Table

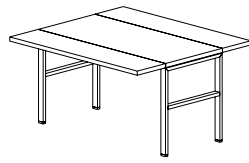

PAGE 8  
Home Office - Central park  
Drop Leaf Table Desk

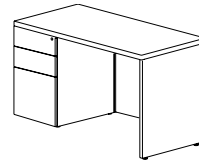

PAGE 9  
Home Office - Central park  
Student Desk

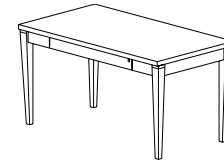

PAGE 10  
Home Office - Central park  
Table Desk with Center Drawer

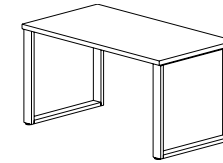

PAGE 11  
Home Office - Central park  
Table Desk with Sleigh Base



PAGE 12  
Home Office - Edgeworks  
Table Desk

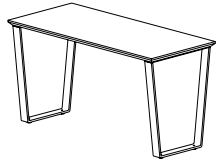

PAGE 13  
Home Office - Not SO Square  
Table Desk

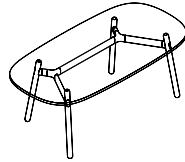

PAGE 14  
Home Office - Roki  
Table Desk



PAGE 15  
Home Office - Roki  
Table Desk

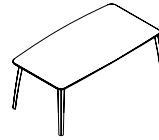

PAGE 16  
Home Office - Chameleon  
Table desks with Solid Wood Legs

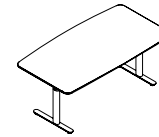

PAGE 17  
Home Office - Chameleon  
Height Adjustable Table Desk



PAGE 18  
Home Office - Chameleon  
Privacy Screen



PAGE 19  
Home Office - Chameleon  
Privacy Screen



PAGE 20  
Home Office - Chameleon  
45" Wide Freestanding Credenza

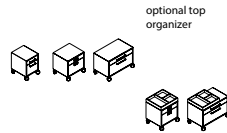

PAGE 21  
Home Office - Chameleon  
Mobile Pedestals

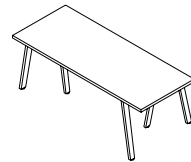

PAGE 22  
Home Office - Rail  
Freestanding Desk

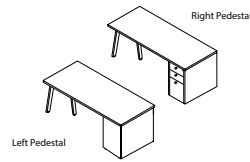

PAGE 23  
Home Office - Rail  
Single Pedestal Desks

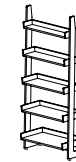

PAGE 24  
Home Office - Rail  
Bookcase

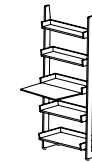

PAGE 25  
Home Office - Rail  
Bookcase



PAGE 26  
Home Office - Bota  
Freestanding Table

## Home office finishes | specifications

STANDARD VENEER	PREMIUM VENEER	HIGH PRESSURE LAMINATE	THERMALLY FUSED LAMINATE
WAC Amber Cherry	N/A	GAC Amber Cherry	MAC Amber Cherry
WRC Caramel Cherry	N/A	N/A	N/A
WIC Crimson Cherry	N/A	GIC Crimson Cherry	N/A
WEC Ebony on Cherry	N/A	GEC Ebony	MEC Ebony
WHC Honey Cherry	N/A	GHC Honey Cherry	MHC Honey Cherry
WOC KoKo Cherry	N/A	GOC KoKo Cherry	MOC KoKo Cherry
WAM Alabaster Maple	N/A	GAM Alabaster Maple	N/A
WCM Clear Maple	N/A	GCM Clear Maple	N/A
WWM Wheat Maple	N/A	GWM Wheat Maple	N/A
WEW Executive Walnut	N/A	GEW Executive Walnut	N/A
WGW Gunstock Walnut	N/A	N/A	MGW Gunstock Walnut
WBW Henna Walnut	N/A	N/A	N/A
WSW Smokey Walnut	N/A	N/A	N/A
WNW Natural Walnut	N/A	GNW Natural Walnut	N/A
N/A	WBO Blush Oak	N/A	N/A
N/A	WMO Mocha Oak	N/A	N/A
N/A	WSO Salted Oak	N/A	N/A
N/A	TBCO Baby's Cheek	N/A	N/A
N/A	TBSW Brown Sugar	N/A	N/A
N/A	TOBW Organic Brown	N/A	N/A
N/A	TSTV Studio Teak Walnut	GSTV Studio Teak Walnut +10%	MTW Studio Teak Walnut
N/A	TSMV Seattle Mist	N/A	N/A
N/A	TSLV Skyline Walnut	GSLV Skyline Walnut +10%	MSW Skyline Walnut
WWP Designer White Paint	N/A	GWL Designer White	MWL Designer White

Send 3x3 or larger finish chip for color match. Custom finish upcharge is 3% or \$250 Net (). When specifying a standard Cherry, Oak, or Walnut finish on Quartered Ash Veneer a 3% or \$250 Net finish upcharge is applied.

**\*See product page for available finish selection**

## Home office metal finishes | specifications

Standard metals vary per product. See product page for standard and premium metal selection.

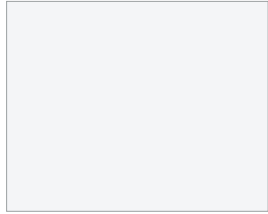

MFW  
White



MFGG  
Graphite Gray



MFS  
Silver



MFMB  
Matte Black



MFNA  
Navy

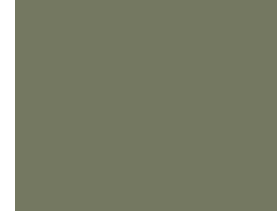

MFOL  
Olive



MFGB  
Grey Beige



MFSA  
Surfin Aquavert



MFOS  
Oyster



MFPS  
Pistachio



MFSS  
Salmon Sienna

**\*See product page for available metal finish selection**

## Home office edges

### Standard profile

Central Park Edge for "W" and "G" Styles

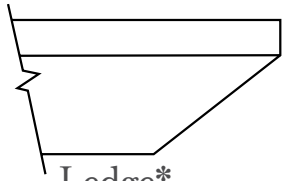

**Ledge\***

"W" 3mm Solid Hardwood Band  
 "P" 3mm Solid Hardwood Band  
 "G" HPL Self Edge

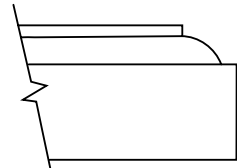

**Classic\***

"W" 3mm Solid Hardwood Band  
 "G" HPL Self Edge

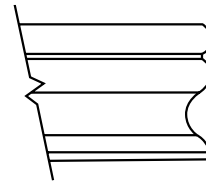

**Cobee**

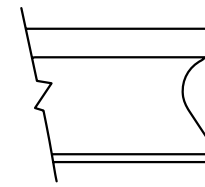

**Cove**

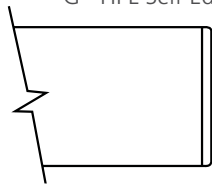

**Flat**

"W" 3mm Solid Hardwood Band  
 "P" 3mm Solid Hardwood Band  
 "G" HPL Self Edge

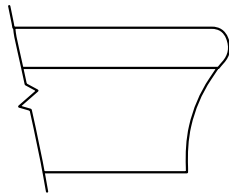

**Knife\***

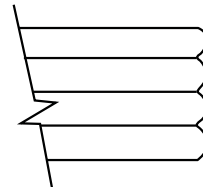

**Reed**

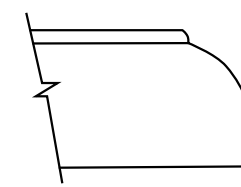

**Waterfall\***

### "W" Premium profile

3/4" Hardwood Rim Band Species Same As Surface Veneer

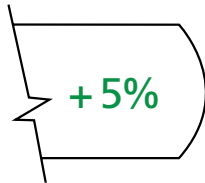

**Bullnose\***



**Ogee\***

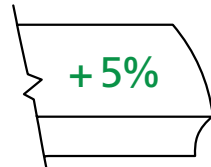

**Radius\***

### "M" Standard profile

Central Park Edges for "M" Styles

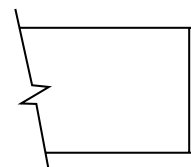

**Flat**

2 mm PVC Edge

\* Coping edges

\*See product page for available edge selection

# Home office pulls | knobs

## Pulls/knobs

Factory Installed

\$15 per pull on Overhead and Wall Hung units

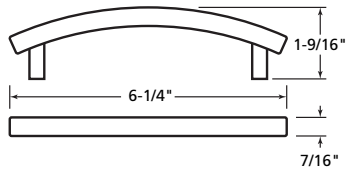

PL-112 Matte Black  
PL-113 Matte Nickel

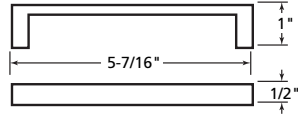

PL-115 Matte Black  
PL-116 Matte Nickel

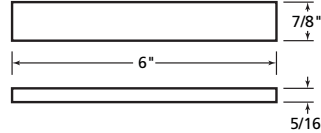

PL-210 Anodized Aluminum

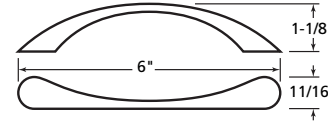

PL-105 Matte Black  
PL-106 Matte Nickel

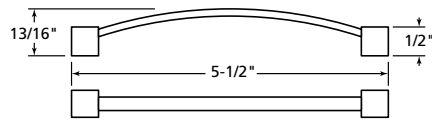

PL-125 Antique Pewter  
PL-126 Antique English  
PL-127 Matte Black

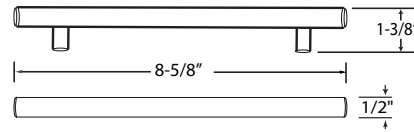

PL-310 Stainless Steel  
PL-311 Royal Brass

## Finger pulls

Arrow indicates finger pull location

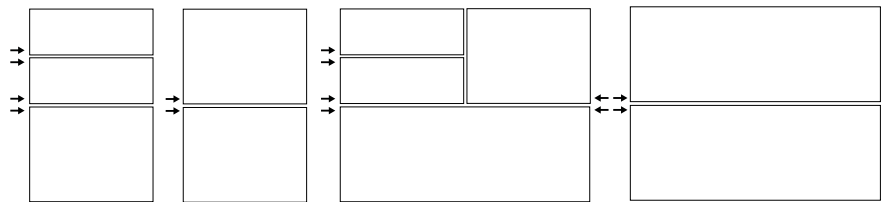

b/b/f

f/f

multi

lateral/lateral

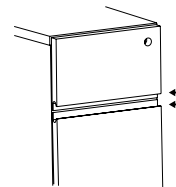

finger pull side view

**\*See product page for available pull selection**

## Home office grommets | grommet reference

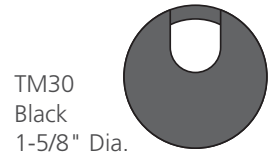

TM30  
Black  
1-5/8" Dia.

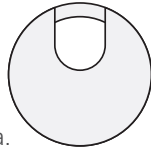

TM31  
Silver  
1-5/8" Dia.

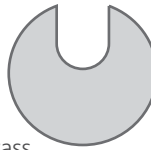

TM33  
Antique Brass  
2-1/2" Dia.

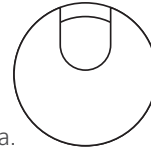

TM34  
White  
1-5/8" Dia.

### Optional Grommets

Factory Installed

Grommets (Standard Location)

Specify Color and Left/Right/Center - \$50 ea.

- Black: TM30-R (Right), TM30-L (Left),
- Silver: TM31-R (Right), TM31-L (Left)
- Antique Brass: TM33-R (Right), TM33-L (Left)
- White: TM34-R (Right), TM34-L (Left),

Grommets (Non-Standard Location)

Provide drawing w/ Grommet Location and Specify Color - \$95 ea.

- Black: TM30-NS
- Silver: TM31-NS
- Antique Brass: TM33-NS
- White: TM34-NS

TM50  
Black  
1-5/8" Dia.

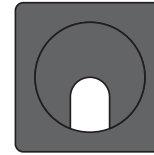

### Grommets (vertical surface)

Standard Location - \$50 ea.

- Black Plastic Vertical Surface: TM50-C (Bottom Center)

Non-Standard Location - \$95 ea.

- Black Plastic Vertical Surface: TM50-NS

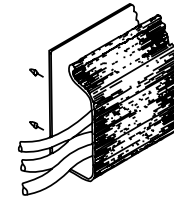

W1

### Horizontal J-Channel

Horizontal J-Channel wire management (Sku: W-1) is sold separately to conceal wire under worksurfaces.

**\*See product page for available grommet selection**

## Standard grommet location reference

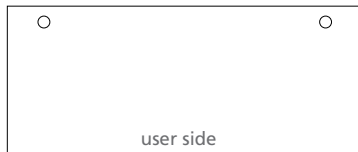

Desk  
Specify Right or Left Grommet

# Home Office - Central park.

Flush Chassis "L" Workstation  
"L" Workstation with Return

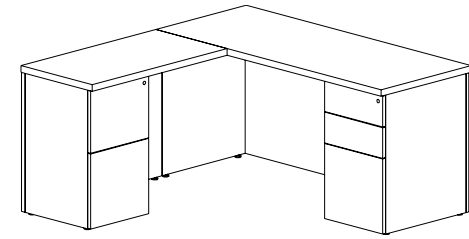

## 1 Select a model

w" x d" x h"

weight	Standard Veneer Top Standard Veneer Chassis		Premium Veneer Top Premium Veneer Chassis		High Pressure Laminate Top Veneer Chassis		Thermally Fused Laminate Top Veneer Chassis				
	Left Pedestal 60 x 60 x 29	280	HCP6060DS629W 4555	HCP6060DS629P 5011	HCP6060DS629G 4555	HCP6060DS629M 2745	Right Pedestal 60 x 60 x 29	280	HCP6060DS630W 4555	HCP6060DS630P 5011	HCP6060DS630G 4555

View statement of line

## 2 Select a finish

View finish details

WAC	WGW	TBCO	GAC	GNW	MAC
WRC	WBW	TBSW	GIC	GSTV +10%	MEC
WIC	WSW	TSTV	GEC	GSLV +10%	MHC
WEC	WNW	TSMV	GHC	GWL	MOC
WHC	WWP	TSLV	GOC	GAM	MGW
WOC		TOBW	GCM	GWM	MTW
WAM		WBO	GEW	MSW	MWL
WCM		WMO			
WWW		WSO			
WEW					

## 3 Select a edge

View edge details

+5% Bullnose	Classic	Cobee	Cove	Flat	Ledge	+5% Bullnose	Classic	Cobee	Cove	Flat
Flat	Knife	Ledge	+5% Ogee	Flat	Knife	Ledge	+5% Ogee	Reed	+5% Radius	Waterfall
Reed	+5% Radius	Waterfall		Reed	+5% Radius	Waterfall				

## 4 Select hardware

View hardware details

PL-105 PL-106	PL-112 PL-113	PL-125 PL-127 PL-126	PL-105 PL-106	PL-112 PL-113	PL-125 PL-127 PL-126	PL-105 PL-106	PL-112 PL-113	PL-125 PL-127 PL-126	PL-105 PL-106	PL-112 PL-113	PL-125 PL-127 PL-126
PL-115 PL-116	PL-210	PL-310 PL-311	PL-115 PL-116	PL-210	PL-310 PL-311	PL-115 PL-116	PL-210	PL-310 PL-311	PL-115 PL-116	PL-210	PL-310 PL-311
Finger Pull "W"/"P"/"G"	Finger Pull "W"/"P"/"G"	Finger Pull "W"/"P"/"G"	Finger Pull "W"/"P"/"G"	Finger Pull "W"/"P"/"G"	Finger Pull "W"/"P"/"G"	Finger Pull "W"/"P"/"G"	Finger Pull "W"/"P"/"G"	Finger Pull "W"/"P"/"G"	Finger Pull "W"/"P"/"G"	Finger Pull "W"/"P"/"G"	Finger Pull "W"/"P"/"G"

## Product features.

- Lockable Box/Box/File (left)
- Lockable File/File (right)
- Legal/Letter filing
- "W" & "G" SKUs feature soft close suspensions, "M" SKUs feature ball bearing suspensions. Both suspensions are full extension.
- Ships KD

### NOTES

- Return 19" deep for 25" depth kneespace
- Product ships with pedestal, top and chassis. Metal fasteners are used for quick assembly

## Options.

### ACCESSORIES

- K28: Articulating Keyboard w/ Mouse - \$390
- K31: Center drawer - \$205

### MODESTY

- M34T-O: "W" "G" Style Drop Door Tech Modesty - \$310
- M34TM-O: "M" Style Drop Door Tech Modesty - \$235

### DRAWER

- P6: Modify File/File to Box/Box/File - \$55 per pedestal
- P33: Wood Drawer Upgrade - \$45 per drawer
- WPD3061: Designer White - \$80 per pedestal

### GROMMETS (STANDARD LOCATION)

- Specify Color and Left/Right - \$50 ea.
- Black: TM30-R (Right), TM30-L (Left)
  - Silver: TM31-R (Right), TM31-L (Left)
  - Antique Brass: TM33-R (Right), TM33-L (Left)
  - White: TM34-R (Right), TM34-L (Left)

### GROMMETS (NON-STANDARD LOCATION)

- Provide drawing w/ Grommet Location and Specify Color - \$95 ea.
- Black: TM30-NS
  - Silver: TM31-NS
  - Antique Brass: TM33-NS
  - White: TM34-NS

### WIRE MANAGEMENT

- LWMB: Lift wire management box with flip down door - \$365
- Power strip with five outlets and 12' cord, mesh wire cover, 6" deep black box

# Home Office - Central park.

Computer Resource Table  
Printer Desk

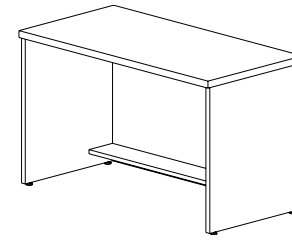

1 Select a model w" x d" x h"	weight	Standard Veneer Top Standard Veneer Chassis		Premium Veneer Top Premium Veneer Chassis		High Pressure Laminate Top Veneer Chassis		Thermally Fused Laminate Top Veneer Chassis	
		48 x 24 x 29	150	HCP4824AU231W	1410	HCP4824AU231P	1551	HCP4824AU231G	1410
36 x 24 x 29	100	HCP3624AU231W	1315	HCP3624AU231P	1447	HCP3624AU231G	1315	HCP3624AU231M	835
30 x 24 x 29	90	HCP3024AU231W	1220	HCP3024AU231P	1342	HCP3024AU231G	1220	HCP3024AU231M	775

*View statement of line*

## Product features.

- Available with 6" deep footrest shelf
- Ships KD

### NOTES

- Product ships KD. Metal fastners are used for quick assembly

## Options.

### ACCESSORIES

- K28: Articulating Keyboard w/ Mouse - \$390
- K31: Center drawer - \$205

### GROMMETS (STANDARD LOCATION)

Specify Color and Left/Right - \$50 ea.

- Black: TM30-R (Right), TM30-L (Left)
- Silver: TM31-R (Right), TM31-L (Left)
- Antique Brass: TM33-R (Right), TM33-L (Left)
- White: TM34-R (Right), TM34-L (Left)

### GROMMETS (NON-STANDARD LOCATION)

Provide drawing w/ Grommet Location and Specify Color - \$95 ea.

- Black: TM30-NS
- Silver: TM31-NS
- Antique Brass: TM33-NS
- White: TM34-NS

## 2 Select a finish *View finish details*

WAC    WGW  
WRC    WBW  
WIC    WSW  
WEC    WNW  
WHC    WWP  
WOC  
WAM  
WCM  
WWM  
WEW

TBCO  
TBSW  
TSTV  
TSMV  
TSLV  
TOBW  
WBO  
WMO  
WSO

GAC    GNW  
GIC    GSTV +10%  
GEC    GSLV +10%  
GHC    GWL  
GOC  
GAM  
GCM  
GWM  
GEW

MAC  
MEC  
MHC  
MOC  
MGW  
MTW  
MSW  
MWL

## 3 Select a edge *View edge details*

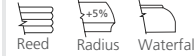
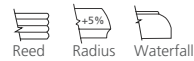

## 4 Select hardware *View hardware details*

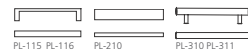
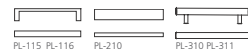



# Home Office - Central park.

Drop Leaf Table Desk

Drop Leaf Table Desk with H-frame Metal Base

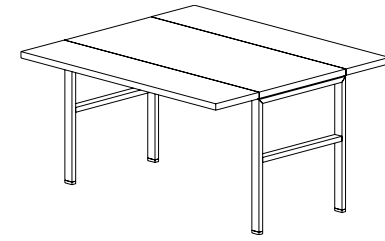



1 Select a model w" x d" x h"	weight	Standard Veneer Top Metal Base		Premium Veneer Top Metal Base		High Pressure Laminate Top Metal Base		Thermally Fused Laminate Top Metal Base	
		60 x 24 x 28.5	100	HCP6024DT105W	2425	"P" Option N/A	HCP6024DT105G	2425	HCP6024DT105M
54 x 24 x 28.5	90	HCP5424DT105W	2370	"P" Option N/A	HCP5424DT105G	2370	HCP5424DT105M	1895	

2 Select a finish <i>View finish details</i>	Standard Veneer Top Metal Base		High Pressure Laminate Top Metal Base		Thermally Fused Laminate Top Metal Base	
		WAC	WGW	GAC	GNW	MAC
	WRC	WBW	GIC	GSTV +10%	MEC	
	WIC	WSW	GEC	GSLV +10%	MHC	
	WEC	WNW	GHC	GWL	MOC	
	WHC	WWP	GOC		MGW	
	WOC		GAM		MTW	
	WAM		GCM		MSW	
	WCM		GWM		MWL	
	WWW		GEW			
	WEW					

3 Select an edge <i>View edge details</i>	Standard Veneer Top Metal Base		High Pressure Laminate Top Metal Base		Thermally Fused Laminate Top Metal Base	
			Flat		Flat	

4 Select hardware <i>View hardware details</i>	Standard Veneer Top Metal Base		High Pressure Laminate Top Metal Base		Thermally Fused Laminate Top Metal Base	
		Hardware	N/A	Hardware	N/A	Hardware

[View statement of line](#)

## Product features.

- Drop leaf swings up and secures underneath
- Top available in "W" "G" and "M"
- Adjustable glides
- Metal base standard in MFB Black. Optional in MFW White and MFS Silver when specified.

### NOTES

- Product ships KD. Metal fastners are used for quick assembly

## Options.

### GROMMETS (STANDARD LOCATION)

Specify Color and Left/Right - \$50 ea.

- Black: TM30-R (Right), TM30-L (Left)
- Silver: TM31-R (Right), TM31-L (Left)
- Antique Brass: TM33-R (Right), TM33-L (Left)
- White: TM34-R (Right), TM34-L (Left)

### GROMMETS (NON-STANDARD LOCATION)

Provide drawing w/ Grommet Location and Specify Color - \$95 ea.

- Black: TM30-NS
- Silver: TM31-NS
- Antique Brass: TM33-NS
- White: TM34-NS

### PLANK MATCH VENEER

- RPMV: Random Walnut Plank Match Veneer (Horizontal Grain with 25%+ Sap) - Add 10%. Clear coat only.

# Home Office - Central park.

## Student Desk

### Student Desk with Single Pedestal

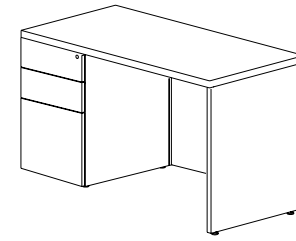

#### 1 Select a model

w" x d" x h"

weight	Standard Veneer Top Standard Veneer Chassis		Premium Veneer Top Premium Veneer Chassis		High Pressure Laminate Top Veneer Chassis		Thermally Fused Laminate Top Veneer Chassis				
	<b>Left Pedestal</b>										
48 x 24 x 29	155	HCP4824DS232W 2385	HCP4824DS232P 2624	HCP4824DS232G 2385	HCP4824DS232M 1355	42 x 24 x 29	145	HCP4224DS232W 2325	HCP4224DS232P 2558	HCP4224DS232G 2325	HCP4224DS232M 1335
<b>Right Pedestal</b>											
48 x 24 x 29	155	HCP4824DS233W 2385	HCP4824DS233P 2624	HCP4824DS233G 2385	HCP4824DS233M 1355	42 x 24 x 29	145	HCP4224DS233W 2325	HCP4224DS233P 2558	HCP4224DS233G 2325	HCP4224DS233M 1335

[View statement of line](#)

#### 2 Select a finish

[View finish details](#)

WAC	WGW	TBCO	GAC	GNW	MAC
WRC	WBW	TBSW	GIC	GSTV +10%	MEC
WIC	WSW	TSTV	GEC	GSLV +10%	MHC
WEC	WNW	TSMV	GHC	GWL	MOC
WHC	WWP	TSLV	GOC		MGW
WOC		TOBW	GAM		MTW
WAM		WBO	GCM		MSW
WCM		WMO	GWM		MWL
WWW		WSO	GEW		
WEW					

#### 3 Select a edge

[View edge details](#)



#### 4 Select hardware

[View hardware details](#)

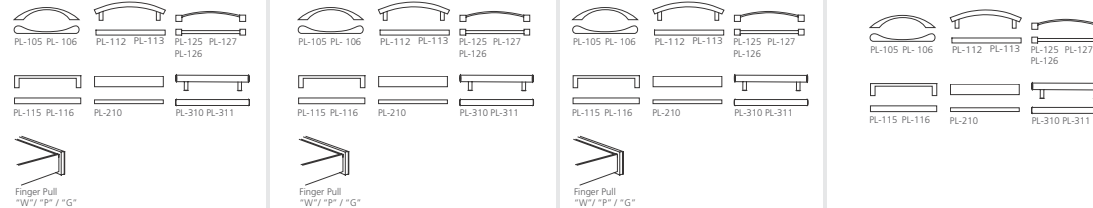

## Product features.

- Lockable Box/Box/File (left pedestal)
- Full height modesty
- Legal/Letter filing
- "W" & "G" SKUs feature soft close suspensions, "M" SKUs feature ball bearing suspensions. Both suspensions are full extension.
- Ships KD

#### NOTES

- Product ships with pedestal, top and chassis. Metal fastners are used for quick assembly

## Options.

#### ACCESSORIES

- K28: Articulating Keyboard w/ Mouse - \$390
- K31: Center drawer - \$205

#### DRAWER

- P6: Modify Box/Box/File to File/File - \$55 per pedestal
- P33: Wood Drawer Upgrade - \$45 per drawer
- WPD3061: Designer White - \$80 per pedestal

#### GROMMETS (STANDARD LOCATION)

- Specify Color and Left/Right - \$50 ea.
- Black: TM30-R (Right), TM30-L (Left)
- Silver: TM31-R (Right), TM31-L (Left)
- Antique Brass: TM33-R (Right), TM33-L (Left)
- White: TM34-R (Right), TM34-L (Left)

#### GROMMETS (NON-STANDARD LOCATION)

- Provide drawing w/ Grommet Location and Specify Color - \$95 ea.
- Black: TM30-NS
- Silver: TM31-NS
- Antique Brass: TM33-NS
- White: TM34-NS

#### MODESTY

- M34T-O: "W" "G" Style Drop Door Tech Modesty - \$310
- M34TM-O: "M" Style Drop Door Tech Modesty - \$235

# Home Office - Central park.

Table Desk with Center Drawer  
Table Desk with Tapered Wood Legs

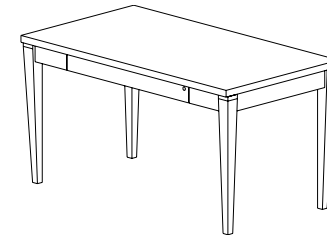

1 Select a model w" x d" x h"	weight	Standard Veneer Top	Premium Veneer Top	High Pressure Laminate Top	Thermally Fused Laminate Top		
		Solid Wood Legs		Solid Wood Legs		Solid Wood Legs	
60 x 30 x 29	100	HCP6030DT106W	1660	"P" Option N/A	HCP6030DT106G	1660	"M" Option N/A
54 x 30 x 29	85	HCP5430DT106W	1610	"P" Option N/A	HCP5430DT106G	1610	"M" Option N/A

2 Select a finish <i>View finish details</i>	Standard Veneer Top	Premium Veneer Top	High Pressure Laminate Top	Thermally Fused Laminate Top
		WAC	WGW	GAC
	WRC	WBW	GIC	GSTV +10%
	WIC	WSW	GEC	GSLV +10%
	WEC	WNW	GHC	GWL
	WHC	WWP	GOC	
	WOC		GAM	
	WAM		GCM	
	WCM		GWM	
	WWW		GEW	
	WEW			

3 Select a edge <i>View edge details</i>	Standard Veneer Top	Premium Veneer Top	High Pressure Laminate Top	Thermally Fused Laminate Top
		Bullnose	Classic	Cobee
	Flat	Knife	Ledge	Ogee
	Reed	Radius	Waterfall	

4 Select hardware <i>View hardware details</i>	Standard Veneer Top	Premium Veneer Top	High Pressure Laminate Top	Thermally Fused Laminate Top
		PL-105 PL-106	PL-112 PL-113	PL-125 PL-127
	PL-115 PL-116	PL-210	PL-310 PL-311	PL-115 PL-116
	Finger Pull "W"/"P"/"G"			Finger Pull "W"/"P"/"G"

[View statement of line](#)

## Product features.

- Locking center drawer
- 3" high apron rails
- Full extension drawers - locking
- Ships KD

### NOTES

- Product ships KD. Metal fastners are used for quick assembly

## Options.

### GROMMETS (STANDARD LOCATION)

Specify Color and Left/Right - \$50 ea.

- Black: TM30-R (Right), TM30-L (Left)
- Silver: TM31-R (Right), TM31-L (Left)
- Antique Brass: TM33-R (Right), TM33-L (Left)
- White: TM34-R (Right), TM34-L (Left)

### GROMMETS (NON-STANDARD LOCATION)

Provide drawing w/ Grommet Location and Specify Color - \$95 ea.

- Black: TM30-NS
- Silver: TM31-NS
- Antique Brass: TM33-NS
- White: TM34-NS

# Home Office - Central park.

Table Desk with Sleigh Base  
Rectangle with Sleigh Base

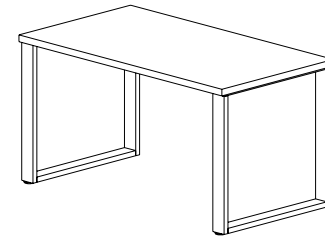

1 Select a model w" x d" x h"	weight	Standard Veneer Top Metal Base		Premium Veneer Top Metal Base		High Pressure Laminate Top Metal Base		Thermally Fused Laminate Top Metal Base	
		60 x 24 x 29	100	HCP6024DT084W	2990	HCP6024DT084P	3289	HCP6024DT084G	2990
54 x 24 x 29	90	HCP5424DT084W	2940	HCP5424DT084P	3234	HCP5424DT084G	2940	HCP5424DT084M	1610
48 x 24 x 29	80	HCP4824DT084W	2890	HCP4824DT084P	3179	HCP4824DT084G	2890	HCP4824DT084M	1570

2 Select a finish <i>View finish details</i>	Metal finish MFS Silver. Additional metal finishes are available, see options.		TBCO		GAC		MAC	
	WAC	WGW	TBCO	GAC	GNW	MAC	WRC	WBW
WIC	WSW	TBSW	GIC	GSTV +10%	MOC	WEC	WNW	MOC
WFC	WFW	TSTV	GEC	GSLV +10%	MGW	WHC	WWP	MTW
WOC		TSMV	GHC	GWL	MSW	WOC		MWL
WAM		TSLV	GOC		MSW	WAM		MWL
WCM		TOBW	GAM		MSW	WCM		MSW
WWW		WBO	GCM		MSW	WWW		MSW
WEW		WMO	GWM		MSW	WEW		MSW
		WSO	GEW					

3 Select a edge <i>View edge details</i>	Standard Veneer Top				Premium Veneer Top		High Pressure Laminate Top				Thermally Fused Laminate Top

4 Select hardware <i>View hardware details</i>	Standard Veneer Top		Premium Veneer Top		High Pressure Laminate Top		Thermally Fused Laminate Top	
	Hardware	N/A	Hardware	N/A	Hardware	N/A	Hardware	N/A

[View statement of line](#)

## Product features.

- Metal sleigh base in silver metal finish. Optional metal finishes available. See options.
- Ships KD

### NOTES

- Product ships KD. Metal fasteners are used for quick assembly

## Options.

### ACCESSORIES

- K28: Articulating Keyboard w/ Mouse - \$390
- K31: Center drawer - \$205
- K31-SK: Center drawer w/ skirt - \$310
- W17: Wire Mgmt. Cover matches leg finish - \$80

### GROMMETS (STANDARD LOCATION)

- Specify Color and Left/Right - \$50 ea.
- Black: TM30-R (Right), TM30-L (Left)
  - Silver: TM31-R (Right), TM31-L (Left)
  - Antique Brass: TM33-R (Right), TM33-L (Left)
  - White: TM34-R (Right), TM34-L (Left)

### GROMMETS (NON-STANDARD LOCATION)

- Provide drawing w/ Grommet Location and Specify Color - \$95 ea.
- Black: TM30-NS
  - Silver: TM31-NS
  - White: TM34-NS

### MODESTY

- M34T-O: "W" "G" Style Drop Door Tech Modesty - \$310
- M34TM-O: "M" Style Drop Door Tech Modesty - \$235

### PREMIUM METAL FINISHES

- Specify premium metal finish color per base - \$160
- MFB: Black, MFW: White

# Home Office - Edgeworks.

Table Desk  
Table Desk with Metal Legs

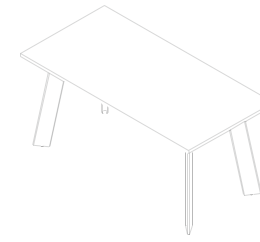



















1 Select a model w" x d" x h"	weight	Standard Veneer Top Metal Base		Premium Veneer Top Metal Base		High Pressure Laminate Top Metal Base		Thermally Fused Laminate Top Metal Base	
		60 x 30 x 29	100	HED6030DT049W	2480	HED6030DT049P	2728	HED6030DT049G	2480
54 x 30 x 29	100	HED5430DT049W	2420	HED5430DT049P	2662	HED5430DT049G	2420	HED5430DT049M	1985

2 Select a finish <i>View finish details</i>	Standard Veneer Top		Premium Veneer Top		High Pressure Laminate Top		Thermally Fused Laminate Top	
	<b>Metal finish</b> MFMB Matte Black. Additional metal finishes are available, see options.	WLA WAC WEC WOC WAM WCM WWM WGW WBW	WSW WNW WWP	TBCO TBSW TSTV TSMV TSLV TOBW WBO WMO WSO	TBCO TBSW TSTV TSMV TSLV TOBW WBO WMO WSO	GAC GEC GOC GAM GCM GWM GNW GSTV +10%	GSLV +10% GWL	MAC MEC MOC MGW MSW MTW MWL

3 Select an edge <i>View edge details</i>	Standard Veneer Top		Premium Veneer Top		High Pressure Laminate Top		Thermally Fused Laminate Top	
	<i>View edge details</i>	 Flat-1  Flat-2 (Black)  Flat-3 (White)	 Flat-2 (Black)  Flat-3 (White)	 Flat-1  Flat-2 (Black)  Flat-3 (White)	 Flat-1  Flat-2 (Black)  Flat-3 (White)	 Flat-1  Flat-2 (Black)  Flat-3 (White)	 Flat-2 (Black)  Flat-3 (White)	 Flat-1  Flat-2 (Black)  Flat-3 (White)

4 Select hardware <i>View hardware details</i>	Standard Veneer Top		Premium Veneer Top		High Pressure Laminate Top		Thermally Fused Laminate Top	
	<i>View hardware details</i>	Hardware N/A		Hardware N/A		Hardware N/A		Hardware N/A

[View statement of line](#)

## Product features.

- 1" Thick top
- ENVI-CT finish on wood tops
- Standard matte black metal finish base
- 3" adjustable glides
- Ships KD

### NOTES

- Product ships KD. Metal fasteners are used for quick assembly

## Options.

### ACCESSORIES

- K28: Articulating Keyboard w/ Mouse - \$390

### GROMMETS (STANDARD LOCATION)

- Specify Color and Left/Right - \$50 ea.
- Black: TM30-R (Right), TM30-L (Left)
  - Silver: TM31-R (Right), TM31-L (Left)
  - Antique Brass: TM33-R (Right), TM33-L (Left)
  - White: TM34-R (Right), TM34-L (Left)

### GROMMETS (NON-STANDARD LOCATION)

- Provide drawing w/ Grommet Location and Specify Color - \$95 ea.
- Black: TM30-NS
  - Silver: TM31-NS
  - White: TM34-NS

### PREMIUM METAL FINISHES

- Specify premium metal finish color - \$630
- MFW: White, MFS: Silver, MFGG: Graphite Gray, MFSS: Salmon Sienna, MFSA: Surfing Aquavert, MFPS: Pistachio, MFOS: Oyster, MFNA: Navy, MFOL: Olive, MFGB: Grey Beige

### PLANK MATCH VENEER

- RPMV: Random Walnut Plank Match Veneer (Horizontal Grain with 25%+ Sap) - Add 10%. Clear coat only.

# Home Office - Not SO Square.

Table Desk

Table Desk with Metal Sleigh Bases

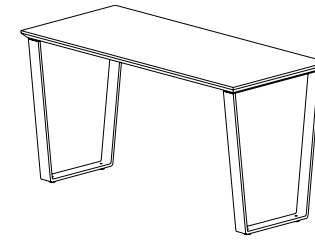

[View statement of line](#)

1 Select a model w" x d" x h"	weight	Standard Veneer Top Metal Base		Premium Veneer Top Metal Base		High Pressure Laminate Top Metal Base		Thermally Fused Laminate Top Metal Base	
		60 x 30 x 29	115	HNS6030DT085W	2705	HNS6030DT085P	2976	HNS6030DT085G	2705
54 x 30 x 29	105	HNS5430DT085W	2665	HNS5430DT085P	2932	HNS5430DT085G	2665	HNS5430DT085M	1455
54 x 24 x 29	95	HNS5424DT085W	2615	HNS5424DT085P	2877	HNS5424DT085G	2615	HNS5424DT085M	1425
48 x 30 x 29	95	HNS4830DT085W	2625	HNS4830DT085P	2888	HNS4830DT085G	2625	HNS4830DT085M	1430
48 x 24 x 29	85	HNS4824DT085W	2575	HNS4824DT085P	2833	HNS4824DT085G	2575	HNS4824DT085M	1400

2 Select a finish <a href="#">View finish details</a>	Metal finish		TBCO	GAC	GNW	MAC
	Metal finish MFS Silver. Additional metal finishes are available, see options.	WAC				
	WRC	WBW	TSTV	GEC	GSLV +10%	MOC
	WIC	WSW	TSMV	GHC	GWL	MGW
	WEC	WNW	TSLV	GOC		MTW
	WHC	WWP	TOBWW	GAM		MSW
	WOC		WBO	GCM		MWL
	WAM		WMO	GWM		MSW
	WCM		WSO	GEW		
	WWW					
	WEW					

3 Select an edge <a href="#">View edge details</a>	NSS Bevel	NSS Bevel	NSS Bevel	NSS Bevel

4 Select hardware <a href="#">View hardware details</a>	Hardware N/A	Hardware N/A	Hardware N/A	Hardware N/A

## Product features.

- Base standard in silver metal finish. Optional metal finishes available. See options.
- Ships KD

### NOTES

- Product ships KD. Metal fasteners are used for quick assembly

## Options.

### ACCESSORIES

- K28: Articulating Keyboard w/ Mouse - \$390
- K31: Center drawer - \$205
- W17: Wire Mgmt. Cover matches leg finish - \$80

### GROMMETS (STANDARD LOCATION)

- Specify Color and Left/Right - \$50 ea.
- Black: TM30-R (Right), TM30-L (Left)
- Silver: TM31-R (Right), TM31-L (Left)
- Antique Brass: TM33-R (Right), TM33-L (Left)
- White: TM34-R (Right), TM34-L (Left)

### GROMMETS (NON-STANDARD LOCATION)

- Provide drawing w/ grommet location and specify color - \$95 ea.
- Black: TM30-NS
- Silver: TM31-NS
- White: TM34-NS

### PREMIUM METAL FINISHES

- Specify premium metal finish color per base - \$160
- MFB: Black, MFW: White

# Home Office - Roki.

Table Desk

Table Desk with Clear Glass Top

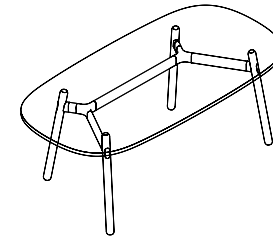

1 Select a model		View statement of line	
w" x d" x h"	weight		
60 x 30 x 29	100	HRO6030DS048S3335	
		Glass Top	
		Solid Wood Legs	
		Wood legs	
		WLA	
		WEC	
		WAM	
		WOW + 15%	
		WEW + 15%	
		WGW + 15%	
		WBW + 15%	
		WSW + 15%	
		WNW + 15%	
		WWP	
		Flat	
		Hardware	
		N/A	
2 Select a finish			
View finish details			
Metal finish			
MFW White (Standard).			
Optional metal finishes			
are available, see			
options.			
3 Select a edge			
View edge details			
4 Select hardware			
View hardware details			

## Product features.

- 1/2" Thick clear glass top with flat polished edges
- 1" Adjustable glides
- Oval wood top with 6" radius corners
- Metal frame standard in MFW white
- Solid Ash (standard), optional Solid Walnut legs with 15% upcharge
- Ships KD

### NOTES

- All Roki finishes are 5% matte sheen
- Product ships KD. Metal fasteners are used for quick assembly

## Options.

### PREMIUM METAL FINISHES



- Specify Rail and End Cap Metal Finish Color
- MFW: White, MFS: Silver, MFGG: Graphite Gray, MFSS: Salmon Sienna, MFSA: Surfin Aquavert, MFPS: Pistachio, MFOS: Oyster, MFNA: Navy, MFOL: Olive, MFGB: Grey Beige - \$400
- MFC: Copper metal finish upcharge - \$625

# Home Office - Roki.

Table Desk

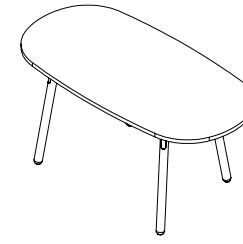
Table Desk with Round Wood Legs



1 Select a model w" x d" x h"	weight	Standard Veneer Top Solid Wood Legs		Premium Veneer Top Solid Wood Legs		High Pressure Laminate Top Solid Wood Legs		Thermally Fused Laminate Top Solid Wood Legs	
		60 x 30 x 29	100	HRO6030DS048W	3225	"P" Option N/A	HRO6030DS048G	3225	HRO6030DS048M
2 Select a finish w" x d" x h" <a href="#">View finish details</a>		Top finishes		Wood legs		Top finishes		Wood legs	
Metal finish MFW White (Standard). Optional metal finishes are available, see options.		WLA WEC WAM WOW + 15% WEW + 15% WGW + 15% WBW + 15% WSW + 15% WNW + 15% WWP		WLA WEC WAM WOW + 15% WEW + 15% WGW + 15% WNW + 15% WWP		GEC GAM GEW GNW GWL		WLA WEC WAM WOW + 15% WEW + 15% WNW + 15% WWP	
3 Select an edge <a href="#">View edge details</a>		 Flat				 Flat		 Flat	
4 Select hardware <a href="#">View hardware details</a>		Hardware N/A				Hardware N/A		Hardware N/A	

[View statement of line](#)

## Product features.

- 1" Thick top
- 1" Adjustable glides
- Oval wood top with 6" radius corners
- ENVI-CT Finish on wood tops
- Solid Ash (standard), optional Solid Walnut legs with 15% upcharge
- Metal frame standard in MFW white
- Ships KD

### NOTES

- All Roki finishes are 5% matte sheen
- Product ships KD. Metal fasteners are used for quick assembly

## Options.

### PREMIUM METAL FINISHES

- Specify Rail and End Cap Metal Finish Color
- MFW: White, MFS: Silver, MFGG: Graphite Gray, MFSS: Salmon Sienna, MFSA: Surfin Aquavert, MFPS: Pistachio, MFOS: Oyster, MFNA: Navy, MFOL: Olive, MFGB: Grey Beige -\$400
- MFC: Copper metal finish upcharge - \$625



# Home Office - Chameleon.

Table desks with Solid Wood Legs

Soft Rectangle Table Top with Solid Wood Legs

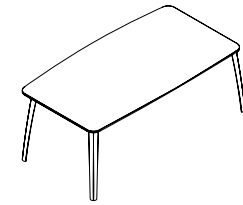

[View statement of line](#)

1 Select a model w" x d" x h"	weight	Standard Veneer Top Solid Wood Legs				Premium Veneer Top Solid Wood Legs				High Pressure Laminate Top Solid Wood Legs				Forbo Marmoleum Top Solid Wood Legs			
		Top Finishes		Leg Finishes		Top Finishes		Leg Finishes		Top Finishes		Leg Finishes		Top Finishes		Leg Finishes	
72 x 36 x 29	90	HCH7236DT097W	3527	HCH7236DT097P	3880	HCH7236DT097G	3527	HCH7236DT097F	4197								
72 x 30 x 29	75	HCH7230DT097W	3511	HCH7230DT097P	3863	HCH7230DT097G	3511	HCH7230DT097F	4181								
66 x 33 x 29	75	HCH6633DT097W	3516	HCH6633DT097P	3868	HCH6633DT097G	3516	HCH6633DT097F	4186								
66 x 30 x 29	70	HCH6630DT097W	3466	HCH6630DT097P	3813	HCH6630DT097G	3466	HCH6630DT097F	4132								
60 x 30 x 29	65	HCH6030DT097W	3441	HCH6030DT097P	3786	HCH6030DT097G	3441	HCH6030DT097F	4104								
2 Select a finish <a href="#">View finish details</a>		WVP	PO01	WOW	PO06	WNO	PO07	WNO	PO07	WNO	PO07	WNO	PO07	FR01	FR10	WOW	PO06
3 Select an edge <a href="#">View edge details</a>		PM01	PO02	WNO	PO07	WSO	PO08	WSO	PO08	WSO	PO08	WSO	PO08	FR02	FR11	WNO	PO07
4 Select hardware <a href="#">View hardware details</a>		PM02	PO03	WSO	PO08	WLA	PO09	WLA	PO09	WLA	PO09	WLA	PO09	FR03		WSO	PO08
		PM03	PO04	WLA	PO09									FR04		WLA	PO09
		PM04	PO05	PO01										FR05		PO01	
		PM05	PO06	PO02										FR06		PO02	
		PM06	PO07	PO03										FR07		PO03	
		PM07	PO08	PO04										FR08		PO04	
		PM08	PO09	PO05										FR09		PO05	
		PM10															

## Product features.

- 1" Thick top
- ENVI-CT Finish \*Environmental Coatings Technology
- Solid wood legs
- Ships KD

### NOTES

- Product ships KD. Metal fasteners are used for quick assembly

## Options.

### ACCESSORIES

- K28: Articulating Keyboard w/ Mouse - \$390
- K31: Center drawer - \$205
- K31-SK: Center drawer w/ skirt - \$310

### GROMMETS (STANDARD LOCATION)

Specify Color and Left/Right - \$50 ea.

- Black: TM30-R (Right), TM30-L (Left)
- Silver: TM31-R (Right), TM31-L (Left)
- White: TM34-R (Right), TM34-L (Left)

### GROMMETS (NON-STANDARD LOCATION)

Provide drawing w/ grommet location and specify color - \$95 ea.

- Black: TM30-NS
- Silver: TM31-NS
- White: TM34-NS

### MODESTY

- HMAP14: Acoustic Panel Modesty - \$450

### MODIFY LEG

- M-1: Modify one 28" height leg to 7" height leg - no charge
- M-2: Modify two 28" height leg to 7" height leg - no charge
- M-3: Modify one 28" height leg to 14" height leg - no charge
- M-4: Modify two 28" height leg to 14" height leg - no charge

### PRIVACY SCREEN

- FAPS14: Acoustic Privacy Screen (Approach Privacy) - \$450
- SAPS14: Acoustic Privacy Screen (Side Privacy) - \$400

# Home Office - Chameleon.

Height Adjustable Table Desk

Soft Rectangle Table Top with white height adjustable base

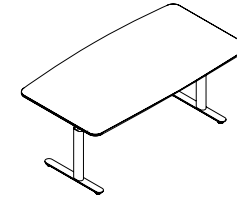

[View statement of line](#)

1 Select a model w" x d" x h"	weight	Standard Veneer Top Metal Base	Premium Veneer Top Metal Base	High Pressure Laminate Top Metal Base	Forbo Marmoleum Top Metal Base
72 x 36 x 29	245	HCH7236DT090W 3446	HCH7236DT090P 3791	HCH7236DT090G 3446	HCH7236DT090F 4110
72 x 30 x 29	230	HCH7230DT090W 3415	HCH7230DT090P 3757	HCH7230DT090G 3415	HCH7230DT090F 4077
66 x 33 x 29	230	HCH6633DT090W 3436	HCH6633DT090P 3780	HCH6633DT090G 3436	HCH6633DT090F 4099
66 x 30 x 29	215	HCH6630DT090W 3385	HCH6630DT090P 3724	HCH6630DT090G 3385	HCH6630DT090F 4045
60 x 30 x 29	200	HCH6030DT090W 3355	HCH6030DT090P 3691	HCH6030DT090G 3355	HCH6030DT090F 4011

2 Select a finish <a href="#">View finish details</a>	Top Finishes	Top Finishes	Top Finishes	Top Finishes
Metal finish MFW White	WWP PO01 PM01 PO02 PM02 PO03 PM03 PO04 PM04 PO05 PM05 PO06 PM06 PO07 PM07 PO08 PM08 PO09 PM10	WOW WNO WSO WLA	GWL LW01 LP01 LW02 LP02 LW04 LF01 LW05 LF02 LW06 LF03 LW07 LN01 LA01 LA02	FR01 FR10 FR02 FR11 FR03 FR04 FR05 FR06 FR07 FR08 FR09

3 Select a edge <a href="#">View edge details</a>	Cliff-1 Sealed MDF Edge	Cliff-2 Black 2mm PVC Band	Cliff-3 White 2mm PVC Band	Cliff-4 Veneer/Laminate Band	Cliff-1 Sealed MDF Edge	Cliff-2 Black 2mm PVC Band	Cliff-3 White 2mm PVC Band	Cliff-4 Veneer/Laminate Band	Cliff-1 Sealed MDF Edge	Plateau +\$600 Sealed MDF Edge

4 Select hardware <a href="#">View hardware details</a>	Hardware N/A	Hardware N/A	Hardware N/A	Hardware N/A

## Product features.

- Adjustable height from 29" to 50" with a maximum weight capacity of 220 lbs.
- Lift available in MFW White (standard)
- Metal parts include 5 year warranty
- Programmable height adjustable mechanism, motor includes 2 year warranty
- Oval leg shape
- Ships KD

### NOTES

- Product ships KD. Metal fasteners are used for quick assembly

## Options.

### ACCESSORIES

- K28: Articulating Keyboard w/ Mouse - \$390
- K31: Center drawer - \$205
- K31-SK: Center drawer w/ skirt - \$310

### GROMMETS (STANDARD LOCATION)

- Specify Color and Left/Right - \$50 ea.
- Black: TM30-R (Right), TM30-L (Left)
  - Silver: TM31-R (Right), TM31-L (Left)
  - White: TM34-R (Right), TM34-L (Left)

### GROMMETS (NON-STANDARD LOCATION)

- Provide drawing w/ grommet location and specify color - \$95 ea.
- Black: TM30-NS
  - Silver: TM31-NS
  - White: TM34-NS

### MODESTY

- HMAP14: Acoustic Panel Modesty - \$450

### PRIVACY SCREEN

- FAPS14: Acoustic Privacy Screen (Approach Privacy) - \$450
- SAPS14: Acoustic Privacy Screen (Side Privacy) - \$400

### WIRE MANAGEMENT

- W18: Coil wire manager - \$160

# Home Office - Chameleon.

Privacy Screen  
Acoustic Modesty

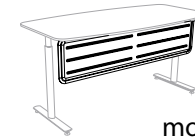

modesty

[View statement of line](#)

1 Select a model		weight	Acoustic Modesty	
w" x d" x h"			White Mounting Bracket	
38.5" x 13.5	10	HMAP3814	450	
46.5 x 13.5	8	HMAP4614	468	
54.25 x 13.5	6	HMAP5414	468	

2 Select a finish		MFW
	<a href="#">View finish details</a>	
<b>Metal finish</b> MFW White (standard). Additional metal finishes are available, see options.		

3 Select a edge		Edge
	<a href="#">View edge details</a>	
N/A		

4 Select acoustic color		3 Hardware
	<a href="#">View hardware details</a>	
N/A		

## Product features.

- Acoustic panels are double sided with rounded corners
- Half modesty is mounted under worksurface and gives 13.5" of privacy below worksurface
- Acoustic material panels are Heather Gray or Charcoal Gray standard ; specify color
- Mounting brackets are standard white metal finish. See Premium Metal Finishes for options
- Specify panel that fits work surface top size

## Options.

### PREMIUM METAL FINISHES

- Specify Screen Brackets Metal Finish Color: \$50
- MFS: Silver, MFMB: Matte Black, MFGG: Graphite Gray, MFSS: Salmon Sienna, MFSA: Surfin Aquavert, MFPS: Pistachio, MFOS: Oyster, MFNA: Navy, MFOL: Olive, MFGB: Grey Beige

### PREMIUM ACOUSTIC MATERIAL

- Specify Premium Acoustic Material Color
- 21, 35, 29, 39, 31, 18, 2, 37, 16, or 34
- Contact customer service for premium acoustic screens. when specifying a quantity of ten or less screens acoustic screens an upcharge will apply - \$250

# Home Office - Chameleon.

Privacy Screen

Acoustic Worksurface Interpersonal Screen

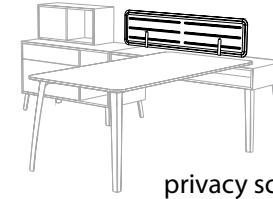

privacy screen

[View statement of line](#)

1 Select a model		weight	Acoustic Worksurface			
w" x d" x h"			Interpersonal Screen			
38.5" x 13.5		10	FAPS3814	468		
46.51 x 13.5		8	FAPS4614	468		
54.25 x 13.5		6	FAPS5414	468		

2 Select a finish		MFW
<a href="#">View finish details</a>		
<p><b>Metal finish</b>                      MFW White (standard).                      Additional metal finishes are available, see options.</p>		

3 Select a edge		Edge
<a href="#">View edge details</a>		N/A

4 Select acoustic color		Hardware
<a href="#">View hardware details</a>		N/A

## Product features.

- Acoustic panels are double sided with rounded corners
- Front Acoustic Screens are mounted on top of worksurface and gives 13.5" of privacy above worksurface
- Acoustic material panels are Heather Gray or Charcoal Gray standard ; specify color
- Mounting brackets are standard white metal finish. See Premium Metal Finishes for options
- Specify panel that fits work surface top size

## Options.

### PREMIUM METAL FINISHES

- Specify Screen Brackets Metal Finish Color: \$50
- MFS: Silver, MFMB: Matte Black, MFGG: Graphite Gray, MFSS: Salmon Sienna, MFSA: Surfin Aquavert, MFPS: Pistachio, MFOS: Oyster, MFNA: Navy, MFOL: Olive, MFGB: Grey Beige

### PREMIUM ACOUSTIC MATERIAL

- Specify Premium Acoustic Material Color
- 21, 35, 29, 39, 31, 18, 2, 37, 16, or 34
- Contact customer service for premium acoustic screens. when specifying a quantity of ten or less screens acoustic screens an upcharge will apply - \$250

# Home Office - Chameleon.

45" Wide Freestanding Credenza  
Modular - 21" Height Case

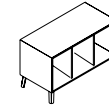

[View statement of line](#)

1 Select a model w" x d" x h"	weight	Standard Veneer Chassis Solid Wood Legs		Premium Veneer Chassis Solid Wood Legs		High Pressure Laminate Chassis Solid Wood Legs		Forbo Marmoleum Chassis Solid Wood Legs		
21" Height Case with 7" Leg 45 x 22 x 28	85	HCH4528CA070W	2059	HCH4528CA070P	2265	HCH4528CA070G	2059	"F" Option N/A		
2 Select a finish <a href="#">View finish details</a>	Case Finishes	Leg Finishes	WVP PO01	WOW PO06	WNO PO07	WLA PO07	WNO PO07	WLA PO07	WNO PO07	WLA PO07
			PM01 PO02	WLA PO07	WNO PO08	WNO PO08	WNO PO08	WNO PO08	WNO PO08	WNO PO08
			PM02 PO03	WNO PO08	WNO PO08	WNO PO08	WNO PO08	WNO PO08	WNO PO08	WNO PO08
			PM03 PO04	WSO PO09	WNO PO08	WNO PO08	WNO PO08	WNO PO08	WNO PO08	WNO PO08
			PM04 PO05	PO01	WNO PO08	WNO PO08	WNO PO08	WNO PO08	WNO PO08	WNO PO08
			PM05 PO06	PO02	WNO PO08	WNO PO08	WNO PO08	WNO PO08	WNO PO08	WNO PO08
			PM06 PO07	PO03	WNO PO08	WNO PO08	WNO PO08	WNO PO08	WNO PO08	WNO PO08
			PM07 PO08	PO04	WNO PO08	WNO PO08	WNO PO08	WNO PO08	WNO PO08	WNO PO08
			PM08 PO09	PO05	WNO PO08	WNO PO08	WNO PO08	WNO PO08	WNO PO08	WNO PO08
			PM10		WNO PO08	WNO PO08	WNO PO08	WNO PO08	WNO PO08	WNO PO08
3 Select a edge <a href="#">View edge details</a>	Edge			Edge		Edge		Edge		
	N/A			N/A		N/A		N/A		
4 Select hardware <a href="#">View hardware details</a>	Push to Open Standard: Optional Hardware Below			Push to Open Standard: Optional Hardware Below		Push to Open Standard: Optional Hardware Below		Push to Open Standard: Optional Hardware Below		

## Product features.

- 4" belt line cavity for wire management
- Build your credenza based on your storage needs. Specify cases left to right based on above illustration.
- Mitered case construction utilizing 5/8" material
- Product ships assembled
- Solid wood legs
- Dividers and shelves are finished to match case
- Products ships assembled

### NOTES

- Unit designed for open plan use.
- Sliding door only available on side by side open storage

## Options.

### CONFIGURED STORAGE (SPECIFICATION REQUIRED)

Specify location of each pedestal from left to right, see page 9 for Accent Finish pricing for Configured Storage.

#### 15" Configured Storage

- OPS2115: 15" Width Open Storage - \$125
- SLD2115: 15" Width Sliding Door - \$290
- P1HD2115: 15" Width Hinged Door - \$250
- P1BF2115: 15" Width Box/File Drawer - \$350

#### 30" Configured Storage

- OPS2130: 30" Width Open Storage - \$125
- OPLF2130: 30" Width Open Upper/Lateral Lower File - \$400
- OPDD2130: 30" Width Open Upper / Drop Door Lower - \$650
- SLD2130: 30" Width Sliding Door - \$350
- P1DD2130: 30" Width Drop Door - \$600
- P1BL2130: 30" Width Box/Lat. File Drawer - \$425

### ADJUSTABLE SHELF

Specify location per adjustable shelf

- P1S2115: 15" Width Adjustable Shelf - \$95
- P1S2130: 30" Width Adjustable Shelf - \$125

### GROMMETS (FOR GANGING)

Vertical sleeve grommet, template provided for field installation  
- TM60: Vertical Grommet Sleeve - \$50

### DOOR LOCK

- D2: Door/ Lock (locks 1 door or 1 pedestal) - \$100 each

# Home Office - Chameleon.

Mobile Pedestals

Open Plan Mobile Desk Pedestal With Casters

optional top organizer

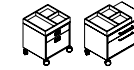

1 Select a model  
w" x d" x h"

weight

Standard Veneer Chassis  
Solid Wood Legs

Premium Veneer Chassis  
Solid Wood Legs

High Pressure Laminate Chassis  
Solid Wood Legs

Forbo Marmoleum Chassis  
Solid Wood Legs

**Box/File**  
16 x 20 x 21      65      HCH1620PD423W      1572

HCH1620PD423P      1730

HCH1620PD423G      1572

"F" Option N/A

[View statement of line](#)

2 Select a finish  
[View finish details](#)

Case Finishes

WWP PO01  
PM01 PO02  
PM02 PO03  
PM03 PO04  
PM04 PO05  
PM05 PO06  
PM06 PO07  
PM07 PO08  
PM08 PO09  
PM10

Case Finishes

WOW  
WNO  
WSO  
WLA

Case Finishes

GWL LW01  
LP01 LW02  
LP02 LW04  
LF01 LW05  
LF02 LW06  
LF03 LW07  
LN01  
LA01  
LA02

3 Select a edge  
[View edge details](#)

Edge  
N/A

Edge  
N/A

Edge  
N/A

4 Select hardware  
[View hardware details](#)

Push to Open Standard:  
Optional Hardware Below

Push to Open Standard:  
Optional Hardware Below

Push to Open Standard:  
Optional Hardware Below



## Product features.

- Anti-tilt safety feature
- Finished all sides and top - open plan
- Products ships assembled

## Options.

### CUSHION

- BC16: Bench Cushion
- Specify fabric grade (.5 yd. required) Recommended on 14" credenza to achieve 17" Seat Height

### TOP ACCESSORY TRAY

- SOWT1: Wood Tray Accessory - \$240
- SOLT1: High Pressure Laminate Tray Accessory - \$195

## BC16 Cushion fabric grades.

COM	COL	1	2	3
224	243	261	279	297
4	5	6	7	8
315	333	351	369	387
9	10	11/ L1	12	13/ L2
405	423	441	459	495

# Home Office - Rail.

Freestanding Desk

Table Desk With Metal Bases

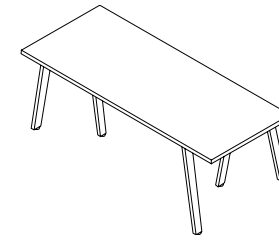

1 Select a model w" x d" x h"	weight	Standard Veneer Top Metal Legs		Premium Veneer Top Metal Legs		High Pressure Laminate Top Metal Legs		Thermally Fused Laminate Top Metal Legs	
		72 x 30 x 29	135	HRA7230DT098W	3172	HRA7230DT098P	3490	HRA7230DT098G	3172
66 x 30 x 29	125	HRA6630DT098W	3088	HRA6630DT098P	3397	HRA6630DT098G	3088	HRA6630DT098M	1558
60 x 30 x 29	115	HRA6030DT098W	3005	HRA6030DT098P	3306	HRA6030DT098G	3005	HRA6030DT098M	1519

2 Select a finish <i>View finish details</i>	WAC WNW		TSTV	GAC GSLV +10%		MAC
	Metal finish MFB Black (standard), MFR Industrial (optional)	WEC WWP		WOC	TSMV	
	WAM	WCM	TSLV	GOC	MOC	
	WWM	WGW		GAM	MGW	
	WGW	WBN		GCM	MTW	
	WBS	WSW		GWM	MSW	
				GNW	MWL	
				GSTV		
				+10%		

3 Select a edge <i>View edge details</i>	Flat Exposed Plywood		Flat	Flat	Flat

4 Select hardware <i>View hardware details</i>	Hardware N/A		Hardware N/A	Hardware N/A	Hardware N/A

[View statement of line](#)

## Product features.

- Standard base is black metal finish (optional industrial metal finish)
- Ships KD

### NOTES

- Freestanding use
- Product ships KD. Metal fasteners are used for quick assembly

## Options.

### ACCESSORIES

- K28: Articulating Keyboard w/ Mouse - \$390
- K31-SK: Center drawer w/ skirt - \$310
- K31: Center drawer w/o skirt - \$205
- W19: Wire management cover for leg - \$80

### EXPOSED PLYWOOD EDGE

- WEPB: Exposed Plywood Edge w/ Baltic Birch Veneer - n/c
- Only available with WCF - Clear Coat Finish

### GROMMETS (STANDARD LOCATION)

- Specify Color and Left/Right - \$50 ea.
- Black: TM30-R (Right), TM30-L (Left)
  - Silver: TM31-R (Right), TM31-L (Left)
  - White: TM34-R (Right), TM34-L (Left)

### GROMMETS (NON-STANDARD LOCATION)

- Provide drawing w/ Grommet Location and Specify Color - \$95 ea.
- Black: TM30-NS
  - Silver: TM31-NS
  - White: TM34-NS

### MODESTY

- HM3: Veneer Half Modesty - \$260 (for "W" and "G")
- HM3M: Melamine Half Modesty - \$205 (For "M")

### PLANK MATCH VENEER

- RPMV: Random Walnut Plank Match Veneer (Horizontal Grain with 25%+ Sap) - Add 10%. Clear coat only.

# Home Office - Rail.

Single Pedestal Desks  
Single Pedestal Desk

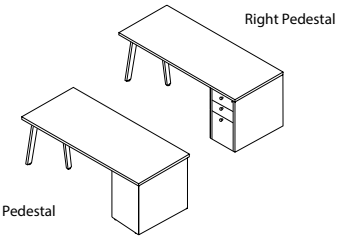

Left Pedestal

Right Pedestal

1 Select a model  
w" x d" x h"

weight	Standard Veneer Top		Premium Veneer Top		High Pressure Laminate Top		Thermally Fused Laminate Top		
	Standard Veneer Chassis		Premium Veneer Chassis		Veneer Chassis		Thermally Fused Laminate Chassis		
<b>Left Pedestal</b>									
72 x 30 x 29	255	HRA7230DS619W	3065	HRA7230DS619P	3372	HRA7230DS619G	3065	HRA7230DS619M	1940
66 x 30 x 29	220	HRA6630DS619W	2990	HRA6630DS619P	3289	HRA6630DS619G	2990	HRA6630DS619M	1890
60 x 30 x 29	200	HRA6030DS619W	2915	HRA6030DS619P	3207	HRA6030DS619G	2915	HRA6030DS619M	1840
54 x 30 x 29	180	HRA5430DS619W	2840	HRA5430DS619P	3124	HRA5430DS619G	2840	HRA5430DS619M	1790
54 x 24 x 29	160	HRA5424DS619W	2595	HRA5424DS619P	2855	HRA5424DS619G	2595	HRA5424DS619M	1740
<b>Right Pedestal</b>									
72 x 30 x 29	255	HRA7230DS609W	3065	HRA7230DS609P	3372	HRA7230DS609G	3065	HRA7230DS609M	1940
66 x 30 x 29	220	HRA6630DS609W	2990	HRA6630DS609P	3289	HRA6630DS609G	2990	HRA6630DS609M	1890
60 x 30 x 29	200	HRA6030DS609W	2915	HRA6030DS609P	3207	HRA6030DS609G	2915	HRA6030DS609M	1840
54 x 30 x 29	180	HRA5430DS609W	2840	HRA5430DS609P	3124	HRA5430DS609G	2840	HRA5430DS609M	1790
54 x 24 x 29	160	HRA5424DS609W	2595	HRA5424DS609P	2855	HRA5424DS609G	2595	HRA5424DS609M	1740

[View statement of line](#)

2 Select a finish  
[View finish details](#)

- WAC WNW
- WEC WWP
- WOC
- Metal finish
- MFB Black (standard),
- MFR Industrial (optional)
- WAM
- WCM
- WWM
- WGW
- WBW
- WSW

- TSTV
- TSMV
- TSLV

- GAC GSLV +10%
- GEC GWL
- GOC
- GAM
- GCM
- GWM
- GNW
- GSTV +10%

- MAC
- MEC
- MOC
- MGW
- MTW
- MSW
- MWL

3 Select an edge  
[View edge details](#)

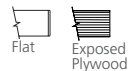

4 Select hardware  
[View hardware details](#)



## Product features.

- Box/Box/File
- Full extension drawers - locking
- Soft close suspension drawer(s)
- Standard base is black metal finish (optional industrial metal finish)
- Ships KD

### NOTES

- All units are standard w/ flush ends
- Freestanding use
- Product ships with pedestal, top and base. Metal fasteners are used for quick assembly

## Options.

### ACCESSORIES

- K28: Articulating Keyboard w/ Mouse - \$390
- K31-SK: Center drawer w/ skirt - \$310
- K31: Center drawer w/o skirt - \$205
- W19: Wire management cover for leg - \$80

### DRAWER

- P33: Wood Drawer Upgrade - \$45 per drawer
- P6: Modify Box/Box/File to File/File - \$55 per pedestal
- WPD3061: Designer White - \$80 per pedestal

### EXPOSED PLYWOOD EDGE

- WEPB: Exposed Plywood Edge w/ Baltic Birch Veneer - n/c
- Only available with WCF - Clear Coat Finish

### GROMMETS (STANDARD LOCATION)

- Specify Color and Left/Right - \$50 ea.
- Black: TM30-R (Right), TM30-L (Left)
- Silver: TM31-R (Right), TM31-L (Left)
- White: TM34-R (Right), TM34-L (Left)

### GROMMETS (NON-STANDARD LOCATION)

- Provide drawing w/ Grommet Location and Specify Color - \$95 ea.
- Black: TM30-NS
- Silver: TM31-NS
- White: TM34-NS

### MODESTY

- HM3: Veneer Half Modesty - \$260 (for "W" and "G")
- HM3M: Melamine Half Modesty - \$205 (For "M")

### PLANK MATCH VENEER

- RPMV: Random Walnut Plank Match Veneer (Horizontal Grain with 25%+ Sap) - Add 10%. Clear coat only.



# Home Office - Rail.

Bookcase

Wall Mount Bookcase

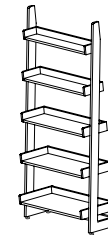

1 Select a model	weight	Exposed Plywood Clear Coat Finish
w" x d" x h" 30 x 13.75 x 71	75	HRA3071BK254W 1564

[View statement of line](#)

2 Select a finish  
[View finish details](#)

WEPB

3 Select a edge  
[View edge details](#)



Exposed Plywood

4 Select hardware  
[View hardware details](#)

Hardware  
N/A

## Product features.

- 3/4" Thick finished shelves standard
- Exposed plywood standard
- Interior shelf depth from bottom to top 13", 11", 9", 7", 5"
- Mounting hardware included
- Products ships assembled

### NOTES

- Not meant to gang

# Home Office - Rail.

Bookcase

Wall Mount Bookcase with Desk

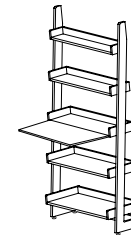

1 Select a model		Exposed Plywood Clear Coat Finish		View statement of line	
w" x d" x h"	weight				
30 x 20 x 71	90	HRA3071BK254WX1	1898		

2 Select a finish		WEPB	

3 Select a edge		Exposed Plywood	

4 Select hardware		Hardware N/A	

## Product features.

- 3/4" Thick finished shelves standard
- Exposed plywood standard
- Interior shelf depth from bottom to top 13", 11", 9", 7", 5"
- Folding personal desk
- Mounting hardware included
- Products ships assembled

### NOTES

- Not meant to gang

Home Office - Bota.  
Freestanding Table  
*Freestanding Table*



1 Select a model		Solid Wood Top Black Metal Base		1/2" Compact Laminate Top Black Metal Base		View statement of line	
w" x d" x h"	weight						
12.5 x 13.75 x 24.5	15	HBO0160FST01W	698	HBO0160FST01M	675		
2 Select a finish		WLA		LAW			
<i>View finish details</i>		WEC		LNB			
Metal finish		WAM					
MFB Black. Additional metal finishes are available, see options.		WCM					
		WWM					
		WGW					
		WBW					
		WSW					
		WNV					
		WWP					
3 Select a edge		Edge		Edge			
<i>View edge details</i>		N/A		N/A			
4 Select hardware		Hardware		Hardware			
<i>View hardware details</i>		N/A		N/A			

Product features.

- Standard Black Base (optional White, Silver)
- Products ships assembled

Options.

**PREMIUM FINISH OPTION**

- Specify base metal finish color - \$160 per base
- MFW: White, MFS: Silver

## Home office options.



COMPUTER SUPPORT  
*single monitor arm*

Style Number	List Price
MA1	285

### Specifications

- Available in black or silver
- Desk clamp and mounting included
- Easy assembly and flexibility
- Elastic painting process for a durable and beautiful finish
- Gas spring tension adjustment for counter-balance height adjustment for monitors 1-8 KG
- Gas spring tested to 50,000 repetitions
- Hidden cable management



COMPUTER SUPPORT  
*double monitor arm*

Style Number	List Price
MA2	455

### Specifications

- Available in black or silver
- Desk clamp and mounting included
- Easy assembly and flexibility
- Elastic painting process for a durable and beautiful finish
- Gas spring tension adjustment for counter-balance height adjustment for monitors 1-8 KG
- Gas spring tested to 50,000 repetitions
- Hidden cable management



COMPUTER SUPPORT  
*triple monitor arm*

Style Number	List Price
MA3	530

### Specifications

- Available in black or silver
- Desk clamp and mounting included
- Easy assembly and flexibility
- Elastic painting process for a durable and beautiful finish
- Gas spring tension adjustment for counter-balance height adjustment for monitors 1-8 KG
- Gas spring tested to 50,000 repetitions
- Hidden cable management



COMPUTER SUPPORT  
*quadruple monitor arm*

Style Number	List Price
MA4	705

### Specifications

- Available in black
- Desk clamp and mounting included
- Easy assembly and flexibility
- Elastic painting process for a durable and beautiful finish
- Gas spring tension adjustment for counter-balance height adjustment for monitors 1-8 KG
- Gas spring tested to 50,000 repetitions
- Hidden cable management

## Home office options.

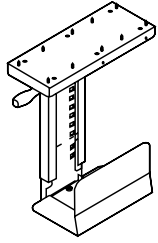

COMPUTER SUPPORT  
*cpu retractable cradle*

Style Number	List Price
K18	205

### Specifications

- Black Metal CPU Carriage
- Full 360° swivel capability allows easy access to rear of CPU for cables / wires
- Track allows 8- 1/2" extension
- Width Adjustment 5-1/2" to 9-1/4"
- Height adjustment 14- 5/8" to 20- 1/2"
- Black epoxy finish

- Notes
- Factory Installed

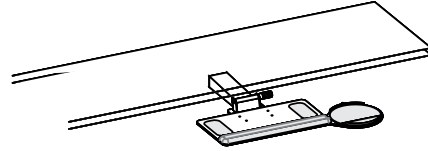

COMPUTER SUPPORT  
*articulating keyboard tray*

Style Number	List Price
Factory Installed K28	395
Field Installed K28F	415

### Specifications

- Adjusts effortlessly - A simple one-handed motion allows the keyboard to be repositioned instantly, without the use of locks or levers
- Available on freestanding desks
- Encourages low-risk postures - Maximizes adjustability within a safe operating range.
- Will last a lifetime - Exceeds all applicable BIFMA Standards and comes with a lifetime guarantee.

- Notes
- Factory Installed (standard)
  - FIELD INSTALL - \$415



DOOR MODIFICATIONS  
*soft close door hinge*

Style Number	List Price
D95C	20 Per door

### Specifications

- Snap onto standard door hinge
- Requires (2) per door
- Max door height 43"
- Factory installed where specified
- Individually shipped for field installation

- Notes
- Specify Each Item To Have Slow Close Feature

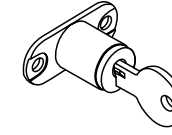

DOOR MODIFICATIONS  
*panel door lock*

Style Number	List Price
D2	100 Per door set

### Specifications

- Door Locks - 1 Door w/ Lock, Other Door w/ Catch Latch
- Contact Customer Service regarding limited lock locations and keying.

- Notes
- Available on: Panel Doors, Wood Frame Doors, and Silverluma doors

# Home office options.

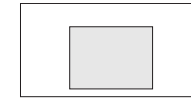
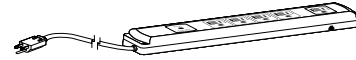
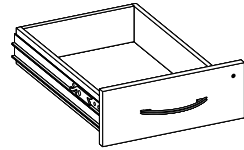
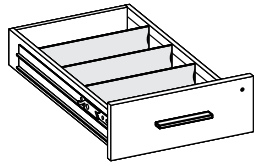

RECTANGLE INLAY

## DRAWER OPTIONS *box drawer accessories*

Style Number	List Price
Wood Drawer Dividers w/ Clips K-DIV	SET OF 3 - 30
Single Tray - Utility Tray K-Sut	35 ea.

### Specifications

- K-DIV Extra Wood Drawer Dividers with Clips, Top Box drawers standard with 1 divider
- K-SUT Single Tray - Utility Tray, Specify Legal or Letter drawer width

## DRAWER OPTIONS - UPGRADE *wood drawer upgrade*

Style Number	List Price
P33	45 Per drawer

### Specifications

- Dowel joint construction
- Hardwood veneer multi-ply drawer
- UV finish
- 1/4" Wood veneer bottoms
- File drawer bottoms are five block reinforced for heavy weight capacity
- Lifetime guaranteed

## POWER / DATA *power supply cordset*

Style Number	List Price
PD717	100

### Specifications

- SIZE: 10.75"L x 2.0"W x 1.06"H
- (5) Outlets w/ 10' cord
- Surge suppression (720 Joules)
- 15 Amp breaker
- Available on: Vertical Panels, Cabinet Interiors, and under tops

## SPECIALTY VENEER ACCENTS *rectangle inlay - recesses dura-leather writing surface*

Style Number	List Price
RL-29A	935

### Specifications

- Recessed inlay desk pads are covered with Alomost Leather from Paul Brayton Designs.
- DARRAN will gladly custom quote other inlay materials ie: solid surfaces, biocomposites, metallic laminates, or genuine leather to match seating

## Home office options.

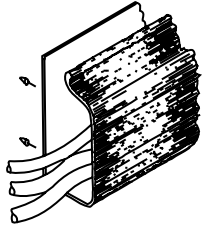

WIRE MANAGEMENT  
*horizontal j-channel wire management raceway*

Style Number	List Price
W1	80 Per 4' section

### Specifications

- 4' section for field installation.
- The "J" shape black thermoplastic wire raceway may be added to specified worksurface tops to provide concealed channeling of wires to and from worksurface grommets. For use in open kneespace areas, raceway is attachable to top of back panel with pan head screws. Interior dimensions are 1" x 1- 1/2" providing ample storage for multiple wires and excess cable. Front of raceway flexes out for easy cord insertion.

Notes

- Units w/ Wire Channel Standard.
- Field Installation

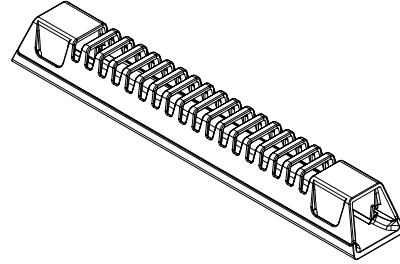

WIRE MANAGEMENT  
*horizontal wire management raceway*

Style Number	List Price
W21	35

### Specifications

- 10"W x 1.5"D x 1.25"H
- Grey Wire Manager (10.5")
- Power and data cables can be discretely housed and managed with the W21 Gray Wire Manager. This can be mounted in any location to metal frame or underside of conference tables and runs cables through a 1" channel from power module to hollow steel legs. This keeps cables organized under the table top. Release clips make it simple to snap on and off the Wire Manager for easy organization and access after attached to the table

Notes

- Field installed

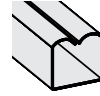

WIRE MANAGEMENT  
*horizontal u-channel wire management raceway*

Style Number	List Price
W2A	80 Per 4' section

### Specifications

- 4' section for field installation.

Notes

- Units w/ Wire Channel Standard.
- Field Installation



WIRE MANAGEMENT  
*coil wire manager*

Style Number	List Price
W18	160

### Specifications

- Weighted Base, Table attachment plate
- 39- 1/2" Length
- Black

Notes

- Location

## Home office options.

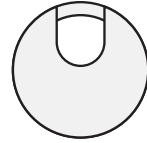
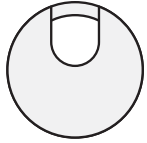

### WIRE MANAGEMENT

*standard location grommets - factory installed*

Style Number	List Price
Standard Location Grommet	
Black	
TM30	50
Silver	
TM31	50
White	
TM34	50

### Specifications

- 1 -5/8" Metal Grommet

#### Notes

- \*Units w/ Grommets Standard Are Noted Under Standard Features. Grommets Match Pull Finish - Standard (Unless Specified Otherwise)

### WIRE MANAGEMENT

*non-standard location grommets - factory installed*

Style Number	List Price
Non-Standard Location Grommet	
Black	
TM30 -NS	95
Silver	
TM31 -NS	95
White	
TM34 -NS	95

### Specifications

- 1 -5/8" Metal Grommet

#### Notes

- \*Units w/ Grommets Standard Are Noted Under Standard Features. Grommets Match Pull Finish - Standard (Unless Specified Otherwise)

### WIRE MANAGEMENT

*black plastic vertical surface grommets - factory installed*

Style Number	List Price
Standard Location Grommet	
TM50-C	50
Non-Standard Location Grommet	
TM50-NS	95

### Specifications

- 2 " Black Plastic Grommet

#### Notes

- Standard Location is Bottom Center



## Power & data options.

Aircharge wireless charging grommet

Style Number	List Price
 ACWG WIRELESS GROMMET	\$195

## Specifications

- › When used with GROVE Tables an additional \$350 LIST will apply for the special cutout required.
- › AirCharge offers a convenient way to charge any Qi compatible smartphone or device without the need to carry charging cables or find an available power outlet.
- › The Aircharge is powered by the latest Qi compliant IC offering reliable and efficient wireless charging in a convenient 3" grommet hub. Simply place your phone on the Aircharge and an LED will confirm pairing and begin wireless charging.
- › Recess: Efficient space conservation and quick access
- › Input: DC 5V (with included AC power adapter), DC 9V, 1.67A (with optional QC 2.0 power adapter)
- › Output: 5 watts Max. with DC 5V, 2A power adapter, 10 watts Max. with QC 2.0 power adapter
- › Qi V1.2 compliant IC
- › Charging distance: 6mm Max.

Available: All DARRAN collections



## Power & data options.

Cove power unit - non-linking

Style Number	List Price
 PD-COVE PLUG Non-linking version	\$550

## Specifications

- › Size 5.75"L x 2.5"W
- › (2) 15 Amp Receptacles and (2) USB charging ports
- › Surface Mount
- › 108" Cord
- › Standard Silver Finish, Available in White or Black Finish upon request
- › ETL Listed

Available: All DARRAN collections



## Power & data options.

Cove corded series

Style Number	List Price
 PD-COVE-PKO	\$800

## Specifications

- › Size 9.5" L x 2.5" W x 3.18" D
- › When used with GROVE Tables an additional \$350 LIST will apply for the special cutout required.
- › (2) Power Receptacles, (2) 2.1 Amp USB charging ports and (1) Telecom Plate Knockout
- › Surface Mount
- › 108" Cord
- › Standard Silver Finish, Available in White or Black Finish upon request
- › ETL Listed

Available: All DARRAN collections

### Telecom Plates

RJ45 (1)	\$35
RJ45 (2)	\$70
RJ45 (3)	\$105
USB (1)	\$70
USB (2)	\$140
RJ11/RJ45	\$70
RJ45/USB	\$105
RJ45/HDMI	\$190
HDMI/DVI	\$325
HDMI/USB	\$205
HDMI/VGA	\$240
VGA/MINI-STEREO	\$155
VGA/USB	\$175

This pod can have up to 1 total plates.  
\*All telecom connectors sold separately.



## Power & data options.

Soba wire manager

Style Number	List Price
STARTER UNITS	
SCDW	\$200
White wire manager	
SCDB	\$200
Black wire manager	

## Specifications

- › Dimensions: 9ft x 9in x 3.15in
- › Zips up, bundles and routes loose, messy cables into a single tube
- › Routes and guides cables behind desks, TVs, and anywhere cables tend to get messy
- › Accommodates large or small cables, up to three cables at once
- › Support channels, used to route cables, include powerful adhesive backing which allows easy attachment to surfaces.

Available: All DARRAN collections



## Power & data options.

VILLA Power unit - non-linking

Style Number	List Price
 VIL-C PLUG	\$515
Non-Linking	

## Specifications

- › Size: Top Grommet 5.68" L X 3.39"W; Under Top 12"L x 3.13"W x 3.08"D
- › (2) Power receptacles; (2) USB charging ports and (1) Knockouts for RJ45 Data Ports
- › Surface Mount
- › 72" Cord (Longer cord available, contact Customer Service)
- › Standard Silver Finish, Black Finish available upon request
- › UL or ETL Certified

Available: All DARRAN collections, excludes Grove

RJ45 Knockout	
RJ45 (1)	\$35

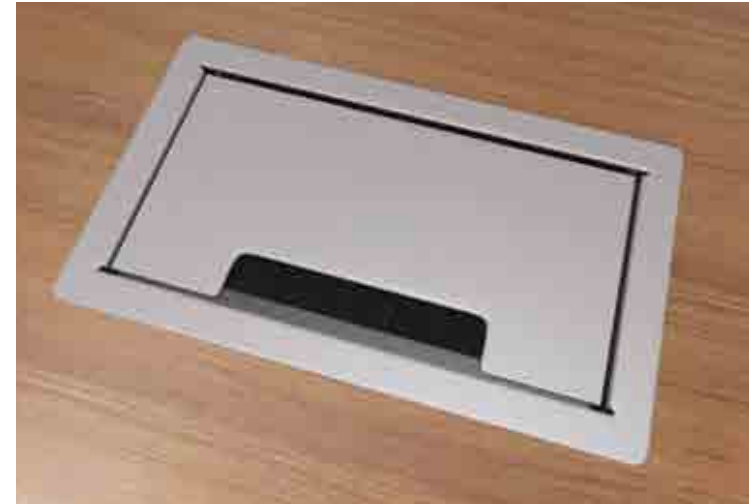

# Honey price list

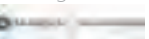

## Honey table of contents

Statement of Line	
Features & Advantages .....	1
Fabric & Leather Program .....	3
Finishes   Specifications .....	6
Metal Finishes   Specifications .....	7
Edges   Specifications .....	8
Pulls   Specifications .....	9
Grommets .....	10
Grain Direction .....	11
Honey Power .....	12
Honey Wire Management .....	13
Honey Workstation Dimensions .....	14
Honey New York Power .....	15
Honey West Coast Power .....	16
Drawer Dimensions .....	17
Honey Typical .....	18
Honey Lounge .....	66
Honey Panels .....	67
Power Entry Box .....	76
Tops .....	77
Fixed Tables .....	79
Privacy Screens .....	81
Storage Credenzas .....	83
Wardrobe Storage .....	85
Mobile Pedestal .....	88
Options .....	89
Power   Specifications .....	93

statement of line.

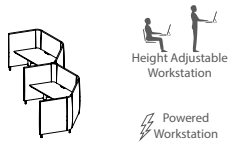

PAGE 18  
Inline Diagonal Workstation Typical



PAGE 19  
Inline Diagonal Workstation Typical

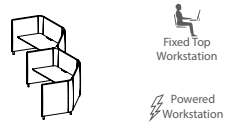

PAGE 20  
Inline Diagonal Workstation Typical

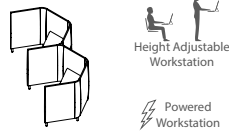

PAGE 21  
Inline Diagonal Workstation Typical



PAGE 22  
Inline Diagonal Workstation Typical

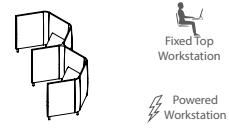

PAGE 23  
Inline Diagonal Workstation Typical

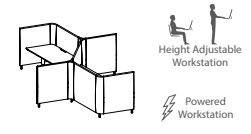

PAGE 24  
Facing Diagonal Workstation Typical



PAGE 25  
Facing Diagonal Workstation Typical

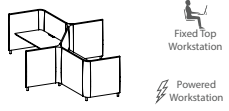

PAGE 26  
Facing Diagonal Workstation Typical

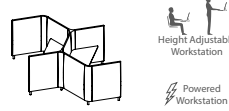

PAGE 27  
Facing Diagonal Workstation Typical

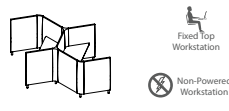

PAGE 28  
Facing Diagonal Workstation Typical

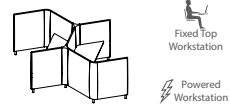

PAGE 29  
Facing Diagonal Workstation Typical

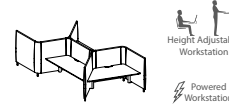

PAGE 30  
Diamond Workstation Typical

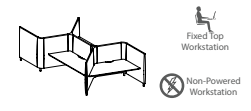

PAGE 31  
Diamond Workstation Typical



PAGE 32  
Diamond Workstation Typical



PAGE 33  
Inline Hexagon Workstation Typical



PAGE 34  
Inline Hexagon Workstation Typical



PAGE 35  
Inline Hexagon Workstation Typical



PAGE 36  
Inline Hexagon Workstation Typical



PAGE 37  
Inline Hexagon Workstation Typical



PAGE 38  
Inline Hexagon Workstation Typical



PAGE 39  
Inline Hexagon Workstation Typical



PAGE 40  
Inline Hexagon Workstation Typical

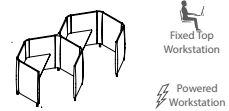

PAGE 41  
Inline Hexagon Workstation Typical

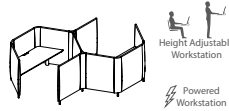

PAGE 42  
Double Hexagon Workstation Typical

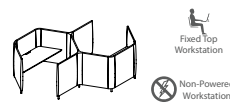

PAGE 43  
Double Hexagon Workstation Typical

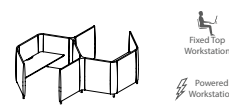

PAGE 44  
Double Hexagon Workstation Typical

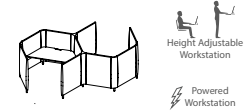

PAGE 45  
Double Hexagon Workstation Typical



PAGE 46  
Double Hexagon Workstation Typical

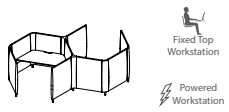

PAGE 47  
Double Hexagon Workstation Typical

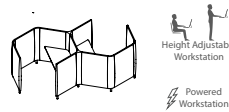

PAGE 48  
Double Hexagon Workstation Typical

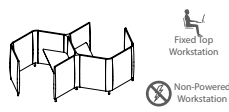

PAGE 49  
Double Hexagon Workstation Typical

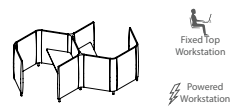

PAGE 50  
Double Hexagon Workstation Typical

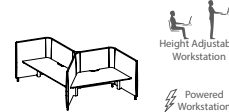

PAGE 51  
Hexagon Workstation Typical



PAGE 52  
Hexagon Workstation Typical



# statement of line.

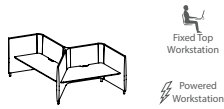

PAGE 53  
Hexagon Workstation Typical



PAGE 54  
Hexagon Workstation Typical



PAGE 55  
Hexagon Workstation Typical



PAGE 56  
Hexagon Workstation Typical



PAGE 57  
Hexagon Workstation Typical

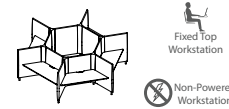

PAGE 58  
Hexagon Workstation Typical



PAGE 59  
Hexagon Workstation Typical

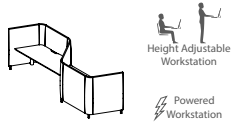

PAGE 60  
Linear Workstation Typical

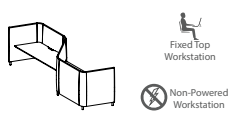

PAGE 61  
Linear Workstation Typical

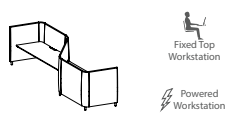

PAGE 62  
Linear Workstation Typical

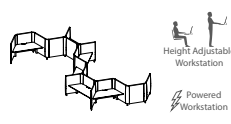

PAGE 63  
S-Shaped Workstation Typical

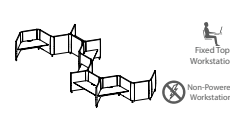

PAGE 64  
S-Shaped Workstation Typical

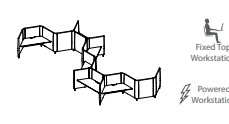

PAGE 65  
S-Shaped Workstation Typical

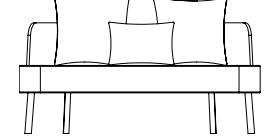

PAGE 66  
120° Lounge

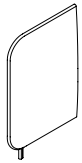

PAGE 67  
120° Starter Panel

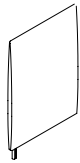

PAGE 68  
120° Starter Panel



PAGE 69  
120° Corner Panel Connector



PAGE 70  
120° Corner Panel Connector



PAGE 71  
In-Line Panel Connector



PAGE 72  
120° Adder Panel

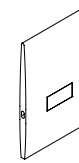

PAGE 73  
120° Adder Access Panel

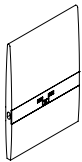

PAGE 74  
120° Single Sided Power Panel

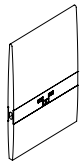

PAGE 75  
120° Double Sided Power Panel

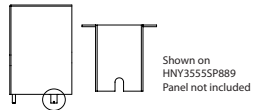

PAGE 76  
Concealed Floor Power Infeed Cover

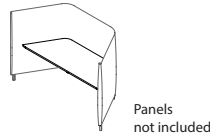

PAGE 77  
120° Worksurface Top

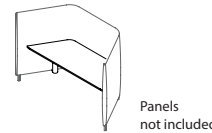

PAGE 78  
120° Worksurface Top



PAGE 79  
Fixed Triangular Table

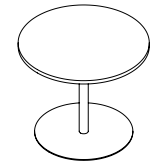

PAGE 80  
Fixed Circular Table

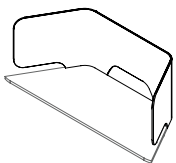

PAGE 81  
120° Worksurface Privacy Screen

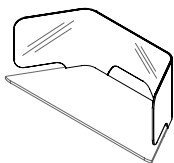

PAGE 82  
120° Worksurface Privacy Screen

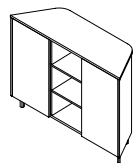

PAGE 83  
120° 64" Wide Push-In Storage Credenza



PAGE 84  
120° Open Storage Credenza

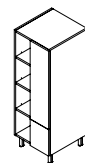

PAGE 85  
Single Sided Open Storage Tower

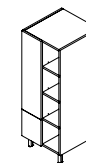

PAGE 86  
Single Sided Open Storage Tower

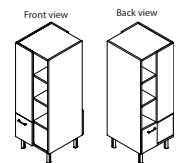

PAGE 87  
Two Person Double Sided - Freestanding Shared Storage

statement of line.

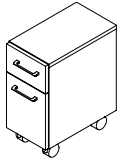

PAGE 88  
Open Plan Mobile Pedestal

## Honey features & advantages

### Veneer tops

Veneer tops are 1" thick and comprised of 45-pound density MDF core with a balanced 3-ply construction. Veneer tops, screens, and lounge backs are standard in Quartered Walnut and Rift Cut White Oak Veneers that are slip-matched. Veneer tops are available in Flat or Cliff edge profile, with multiple banding options. Tops are finished in either 5-sheen matte finish or 40-sheen depending on finish selection.

### HPL laminate tops

Honey high-pressure laminate tops are 1" thick and comprised of 45-pound density MDF core with a balanced 3-ply construction. Tops are available in Flat or Cliff edge profile, with multiple banding option.

### TFL tops

Thermally Fused Laminate tops are 1-1/8" thick and fused to a 45-pound density substrate of the top for a durable surface. Tops are available in a Flat edge profile with multiple banding options.

### Panel construction

Panels are composed of 3/4" and 1" birch plywood with tenon and groove construction that is secured with screws and glued. MDF trim pieces create soft rounded edges and beautiful contours. The frame is covered with 4.5mm PET acoustic panels for sound absorption. PET panels are composed of recycled content, are flame retardant, mold resistant and have zero emissions. Panels are standard elevated on 5" solid wood legs that feature 2" Glide for adjustment on uneven surfaces.

### Case construction

Case pieces including pedestals, towers and credenzas are constructed of 3/4" thick particle board with 3-ply balanced construction. Pedestal and Cabinets feature dowel construction reinforced with steel bracket plates, wood cleats, screws and glue. Credenzas and Towers are elevated on 6" solid wood legs featuring 1" glide for adjustment on uneven surfaces.

### Lounge construction

Lounge units are constructed from plywood with 2" thick bottom platform, 3/4" seat pan and 4" of high resiliency foam for comfort and durability. The honey Lounge back is a curved plywood core with veneer or laminate. Honey lounge consists of high resilient foam with a minimum of 2.5 density in seats and blown fiber cushions, further advances support and durability.

Lounge unit is elevated on 10.5" solid wood leg with oval shape to match panel stations.

### Screens

Honey screens are available in Acrylic or Veneer over plywood. Acrylic is 1/4" thick and available in frosted, white, and black. Plywood screens are 1/2" thick and are available in Quartered Walnut and Rift Cut White Oak Veneer that runs horizontally on the screen. Screens secure to the underside of the worksurfaces with an L bracket. Screens feature a center cutout to allow clip-on power pods and easy wire management to the MGT: Wire Tray below the worksurface. The screen is 24" tall for added privacy; the screen's unique curved wings mimic the worksurface top creating a barrier between users and work area to focus.

### Cleaning wood & laminate

In addition to regular dusting, give your furniture an occasional cleaning in accordance with our cleaning instructions. DARRAN wood and laminate products can be cleaned with a soft cloth and a mild soap and water mixture. Use approximately 32 oz of water mixed with one tablespoon of dish soap, always wiping with the grain. Dry with a soft cloth, going with the grain, to avoid spotting or streaking. Wood products should be waxed periodically using a non-wax liquid; please do not use any waxy polish or cleaner. Interior of drawers may also be cleaned with mild soap and water mixture, or any household cleaner that is not petroleum or thinner-based.

### Suspensions

All cabinets and mobile pedestals utilize cold rolled steel zinc plated high-grade drawer suspensions. All suspensions are warranted for the lifetime of the product. Box and File drawers are full extension, featuring steel ball bearings for a smoother quieter range of motion with soft close operation and are rated 100lbs.

### Filing

Honey features a highly durable black plastic extrusion that is securely fastened into a route on top of the drawer to support hanging files. An adjustable crossbar is provided for all file drawers that enables legal/letter filing front to back or side-to-side based on the drawer size.

## Honey features & advantages

### Locks

Locks are optional on pedestals and doors. Each drawer pedestal is independently locked. Lock plugs are factory or field installed.

### Keying

Keying is available either factory or field installed. Factory installed keying offers two options: random or designated. When the random keying option is selected an arbitrary key number will be assigned to the unit. When the designated keying option is selected a key number must be specified between 101 and 110. Higher numbers may be specified if noted on the purchase order and may be factory or field installed. Black and silver face lock have silver keys.

### Wire management

Wire management capabilities include standard and optional worksurface grommets. Specify W21 under surface wire channels for organization and management of all communication wires and cords. Sold separately to conceal wire under worksurfaces. Top feature a cutout in the back and unique curved wings allowing for clip on modules or easy wire management to the power tray below the worksurface.

### Grommets

Metal grommets are provided to match the drawer pull selection. Metal grommets are available in black, silver or white. Must specify standard or non-standard location. TM50 Black plastic grommets are available as an option for vertical applications.

## Honey fabric & leather program

### Seating & fabric leather program

DARRAN has partnered with some of the most prestigious fabric suppliers of the office furniture industry to bring you quality fabrics that are engaging designs, environmentally friendly and durable for years to come. The majority of fabrics we have graded-in are in heavy supply making it most likely available on our Quickship however, we cannot guarantee stock. If you do not see the fabric you wish to include in a project, please contact our Factory to see if this pattern can be graded in at 800.334.7891.

### Panel fabric program

ALL COM fabric must be preapproved by DARRAN. Leather fabric program is not approved on panels. Due to stretching and sagging textile content for panels should not exceed a combined 50% cotton, linen, nylon and/or rayon is not recommended. Panel fabrics are required to have flame certificates that meet ASTM E84 Adhered (for power panels) and Unadhered (for panels). DARRAN does not accept responsibility of collecting flame certificates for COM.

### Fabrics & leathers

Please visit our Seating Fabrics page at [darran.com/textilesleather](http://darran.com/textilesleather)

Camira  
www.camirafabrics.com  
800.334.789

Wollsdorf  
www.wollsdorf.com  
336.884.5005

CFStinson  
www.cfstinson.com  
800.841.6279

Green Hides  
www.greenhides.com  
336.315.9720

DesignTex  
www.designtex.com  
800.797.4949

Maharam  
www.maharam.com  
800.645.3943

Momentum Textiles  
www.momentumtextiles.com  
800.366.6839

Ultrafabrics  
www.ultrafabricsinc.com  
800.334.7891

Application instructions must be specified on the purchase order or COM / COL submission form. In the absence of application instructions, DARRAN will apply materials accordingly.

### CAL117

All DARRAN seating products conform to California Technical Bulletin 117 as a minimum standard.

### CAL133

To meet the California Technical Bulletin 133 flammability regulation, a combination of proper materials must be used to pass, as it tests the fire resistance of a finished product. Flame resistant fabric, a fire blocker material and special foam must be used to pass CAL133 fire codes.

Testing is available for all seating products with the following fees and considerations:

- If laboratory certification is not required, any style can be manufactured to comply with California Technical Bulletin 133 for \$75 list per yard required. (Customer's Own Materials must factor in additional yardage requirements based on repeat.)
- The purchase order must clearly indicate the requirement of California Technical Bulletin 133
- If laboratory California Technical Bulletin 133 certification is required, the cost of testing a chair is \$820 NET, plus the cost of the chair and covering material.
- An additional lead time of 4 to 6 weeks is required for testing for CAL133.
- Once testing is completed, we will provide a certification letter specific to the sample tested for CAL133.
- DARRAN's manufacturing procedures for California TB 133 compliance are based on the testing of representative style with specific fabrics. Please contact Customer Service for an updated list of tested models.
- A copy of test certification is available upon request.

## Honey fabric & leather program

### Combination fabrics

DARRAN is pleased to offer customers the design freedom of combination fabrics. When using fabric, vinyl or leather combinations, pricing will be as follows:

- When combining two materials of the same grade, pricing will be specified grade + 5%.
- If combining two materials of different grades or leather/ fabric combination, use the highest grade/price + 5%.
- If using COM or COL, pricing will be COM or COL + 5%. If both COM + COL are used in combination, use COL + 5%

### COM/COL ordering instructions

Please complete the COM Submission Form prior to ordering the fabric from the supplier. All COM fabrics must be approved prior to order submission. Please refer to our website or contact DARRAN Seating Customer Service for an updated list of preapproved COM fabrics. Application instructions must be specified on the purchase order or COM/COL submission form. In the absence of application instructions, DARRAN will apply materials in the best manner and cannot be held responsible for tailoring or application objections after upholstering. COM orders will be scheduled for production after receipt of the material. Packages must be clearly marked and the fabric must be first quality, continuous yardage.

### COM/COL yardage requirements

The yardage requirements stated in this price list for each style are calculated using 54" wide, non-directional fabrics. For fabrics with a different width or for patterns with repeats, please refer to the below chart to calculate the additional percent of fabric required:

Fabric Width	Plain Fabric	2" - 14" Repeat	15" - 19" Repeat	20" - 27" Repeat	28" - 36" Repeat
54"	0	15%	20%	25%	30%
53"	6%	19%	24%	28%	36%
52"	13%	23%	28%	33%	38%
51"	19%	26%	31%	36%	41%
50"	25%	30%	35%	40%	45%
49"	30%	35%	40%	45%	50%
48"	35%	40%	45%	50%	55%
47"	45%	50%	55%	58%	65%

## Honey fabric & leather program

NOTE: Prior To Completion Of This Form, Please Refer To Our Graded In Materials Program For Preapproved Fabrics/Leathers.

### COM/COL Approval

DARRAN Furniture Industries  
 2402 Shore Street, High Point, NC 27263  
 ATTN: Seating Division / COM/COL Approval  
 TAG: DARRAN Purchase Order Number

### Shipping approved COM/COL materials

DARRAN Furniture Industries  
 2402 Shore Street, High Point, NC 27263  
 ATTN: Seating Division / COM/COL Approval  
 TAG: DARRAN Purchase Order Number

Please complete this form, attach a 6"x 6" sample and mail to the COM/COL APPROVAL address shown above.  
 This form can also be downloaded from our website at [www.darran.com/leathers](http://www.darran.com/leathers) OR [www.darran.com/fabrics](http://www.darran.com/fabrics)

Purchase Order # \_\_\_\_\_  
 Dealer's Name \_\_\_\_\_  
 Contact \_\_\_\_\_  
 Address \_\_\_\_\_  
 Telephone \_\_\_\_\_  
 Email \_\_\_\_\_  
 Chair Style \_\_\_\_\_  
 Manufacturer \_\_\_\_\_  
 Pattern Name \_\_\_\_\_  
 Pattern Color \_\_\_\_\_  
 Content \_\_\_\_\_  
 Repeat \_\_\_\_\_

Please specify any special requirements and check the application above.

\_\_\_\_\_  
 \_\_\_\_\_  
 \_\_\_\_\_

ATTACH 6" X 6" FABRIC/LEATHER SAMPLE HERE

**NOTE**

Actual Fabric/Leather samples needed instead of digital images. If digital images are sent in lieu of samples, DARRAN will only verify the pattern and will not take responsibility for color variances that cannot be verified due to printing restrictions

In the absence of application instructions, DARRAN will apply the material in the best manner and cannot be held responsible for tailoring or application objections after upholstery.

Unless otherwise instructed on the purchase order, excess COM materials will be recycled at the discretion of DARRAN after six months of the original product ship date.

The COM approval solely pertains to the application of the fabric onto the specified DARRAN seating product. DARRAN's approval or acceptance does not constitute any responsibility or warranty to the overall appearance, durability, flammability, defects, dye lot variations or colorfastness of the COM. It is the customer's responsibility to ensure the COM meets CAL 117 compliance and are first quality continuous goods.

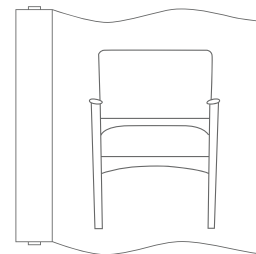

**RAILROAD**

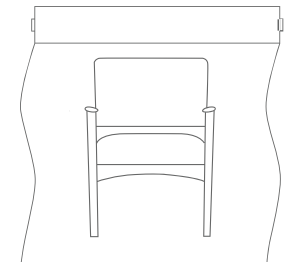

**SETUP**

# Honey finishes | specifications

## MATTE 5% SHEEN VENEER

Specify LST-40 to change matte 5% sheen to gloss 40% sheen - N/C.

### Finishes on White Oak

- PO01 Olive
- PO02 Aquavert
- PO03 Mushroom
- PO04 Burgundy
- PO05 Ash
- PO06 Powder
- PO07 Pebble
- PO08 Vapour
- PO09 Verde

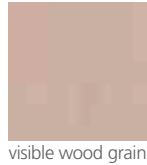

visible wood grain

### Paint Finishes on White Oak

- PM01 Olive
- PM02 Aquavert
- PM03 Mushroom
- PM04 Burgundy
- PM05 Ash
- PM06 Powder
- PM07 Pebble
- PM08 Vapour
- PM10 Verde



printed full coverage

- WOW Clear Walnut
- WNO Natural Oak
- WSO Salted Oak

## GLOSS 40% SHEEN VENEER

Specify LST-5 to change gloss 40% sheen to matte 5% sheen - N/C.

- WBW Henna Walnut
- WSW Smokey Walnut
- WEC Ebony
- WWP Designer White

## HIGH PRESSURE LAMINATE

- GEC Ebony
- GWL Designer White
- LP01 Surfin USA
- LP02 Royal Blue Suede
- LF01 New Burgundy
- LF02 Just Rose
- LF03 Folkstone
- LN01 Cafe Sienna
- LA01 Bleu Spazio (20% upcharge)
- LA02 Verde Chairò (20% upcharge)
- LW01 Neo Walnut
- LW02 Fawn Cypress
- LW04 Phantom Pearl
- LW05 Phantom Ecru
- LW06 Phantom Cocoa
- LW07 Stickley Oak

## THERMALLY FUSED LAMINATE

- MEC Ebony
- MOC Koko Cherry
- MSW Skyline Walnut
- MTW Studio Teak
- MWL Designer White

## Custom finishes

Send 3x3 or larger finish chip for color match. Custom finish upcharge is 3% or \$250 Net (whichever is greater).

## Finish

ENVI-CT Green Certified European Technology Coatings Finish.



# Honey metal finishes | specifications

Height adjustable columns are standard in MFW White. MFB Black is optional when specified.

## Height Adjustable Mechanism Metal Finishes

STANDARD

OPTIONAL

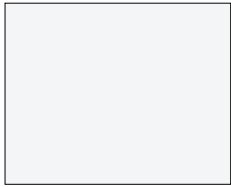

MFW  
White  
(Standard)



MFB  
Black  
(Optional - N/C)

## Feet, Table Base, Wire Tray and Bracket Metal Finishes

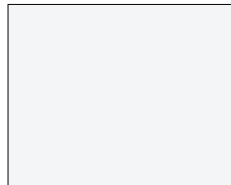

MFW  
White  
(Standard)



MFG  
Gray  
(Premium)



MFGG  
Graphite Gray  
(Premium)



MFS  
Silver  
(Premium)



MFMB  
Matte Black  
(Premium)



MFNA  
Navy  
(Premium)

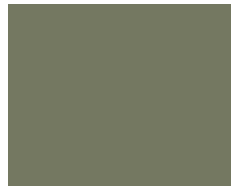

MFOL  
Olive  
(Premium)



MFGB  
Grey Beige  
(Premium)



MFSA  
Surfin Aquavert  
(Premium)



MFOS  
Oyster  
(Premium)

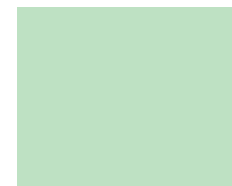

MFPS  
Pistachio  
(Premium)

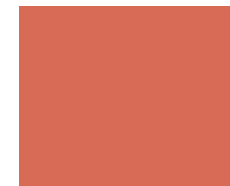

MFSS  
Salmon Sienna  
(Premium)

# Honey edges

## Standard profile

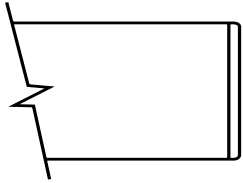

**Flat-1**

"W" "G"  
3mm Hardwood Band  
"G" HPL Self Laminate Band

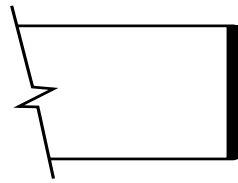

**Flat-2**

"W" "G" "M"  
2mm Black  
PVC Band

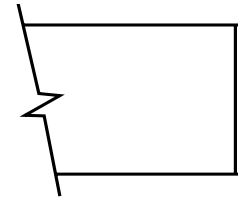

**Flat-3**

"W" "G" "M"  
2mm White  
PVC Band

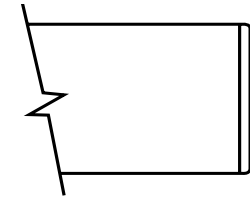

**Flat-4**

"M"  
2mm Matching PVC Band

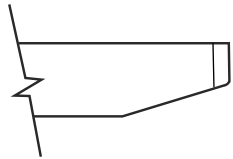

**Cliff-1**

"W" "G"  
3mm Hardwood Band  
"G" HPL Self Laminate Band



**Cliff-2**

"W" "G"  
2mm Black PVC Band  
"G" Black cutback is finished to match HPL

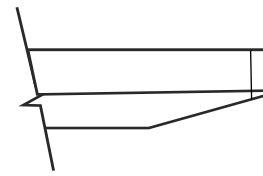

**Cliff-3**

"W" "G"  
2mm White PVC Band  
"G" White cutback is finished to match HPL

# Honey pulls

Honey pulls come standard in PL-506 gloss white. Optional pulls available when specified.



PL - 506 Gloss White (Standard)  
PL - 507 Matte Chrome



PL - 406 Gloss White  
PL - 407 Matte Chrome



PL-260 Anodized Aluminum



PL-115 Matte Black  
PL-116 Matte Nickel

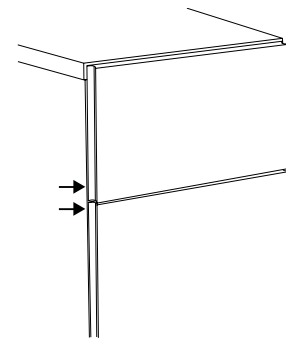

finger pull side view

# Honey grommets | grommet reference

TM60  
Black  
1-5/8" Dia.



## Grommets (vertical surface)

Standard Location - \$50 ea.  
- Black Plastic Vertical Surface: TM60-C (Bottom Center)

Non-Standard Location - \$95 ea.  
- Black Plastic Vertical Surface: TM60-NS

## Honey grain direction

### Grain direction

All top parts, storage credenzas, pedestals and towers come with horizontal grain.

## Worksurfaces

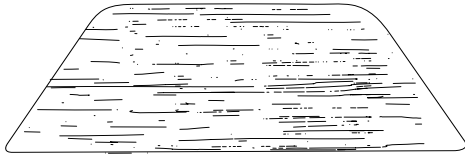

Desk/Credenza

# Honey wire management | power

Honey panels feature an integrated power system that daisy chains through panels to power workstations.

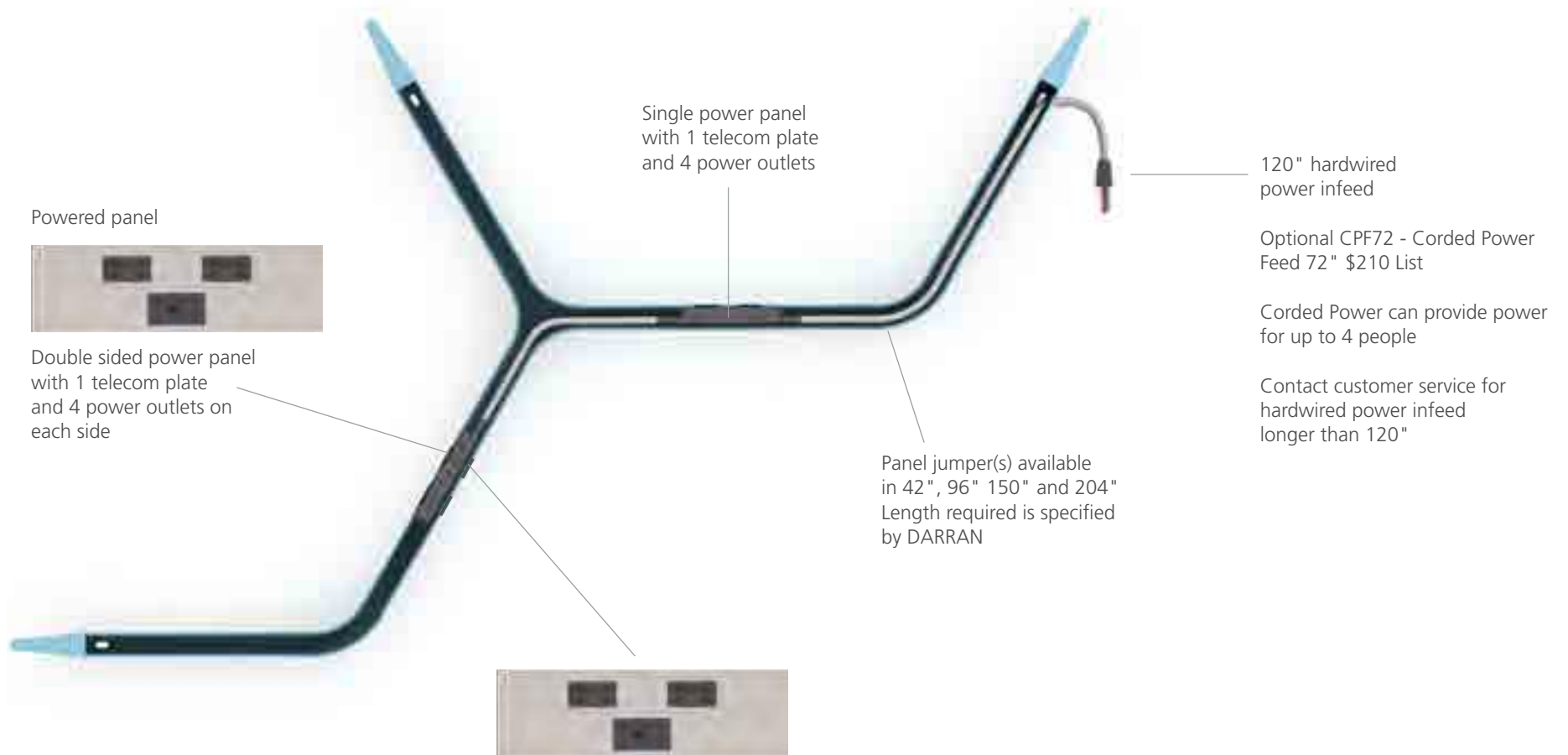

## Honey wire management

### Honey cutout

Honey worksurfaces feature a standard T75 wire management cutout to drop wires below the worksurface.

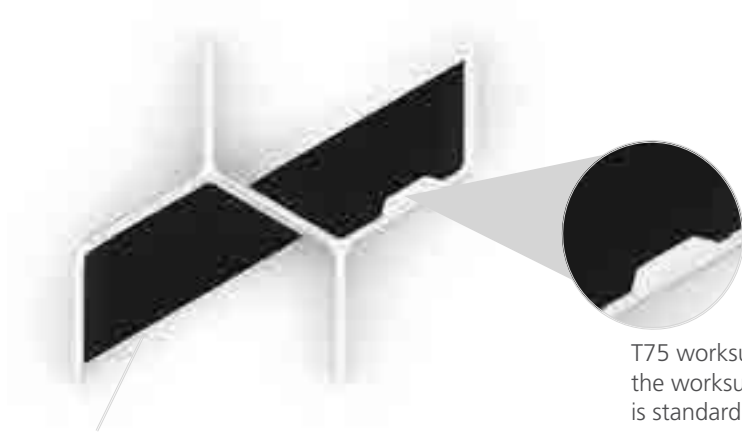

T75D option is available to delete cutout on worksurfaces at no charge. Please specify when ordering.

T75 worksurface cutout to drop wires below the worksurface to power access. Wire cutout is standard on all typicals.

### Honey T75 dimensions

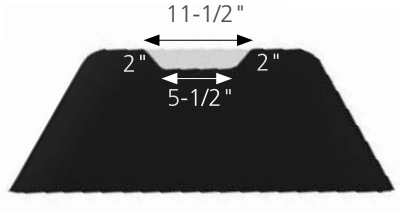

# Honey workstation dimensions

## Panel workstation dimensions

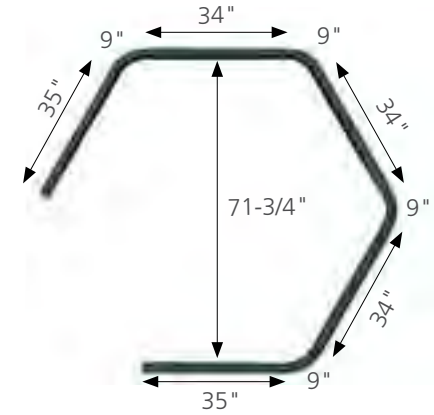
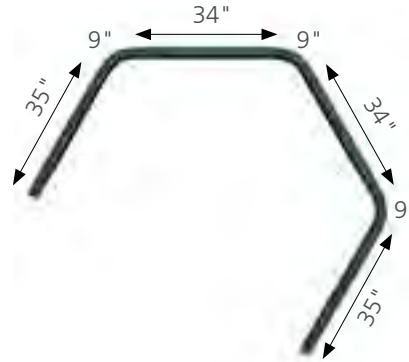
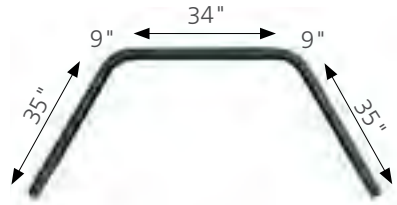

## Height adjustable worksurface dimensions

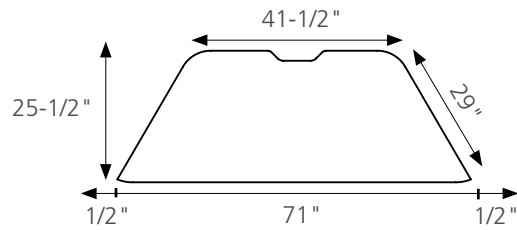

72" Height Adjustable Worksurface

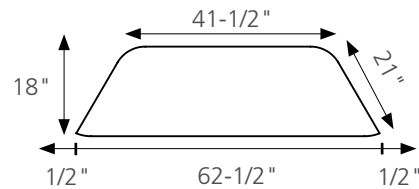

63-1/2" Height Adjustable Worksurface

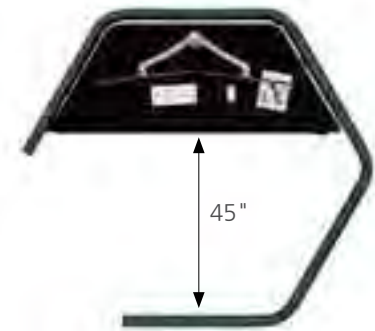

## Fixed worksurface dimensions

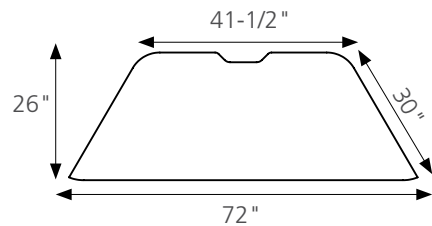

72" Fixed Worksurface

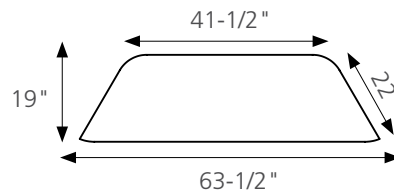

63-1/2" Fixed Height Worksurface



## Honey New York power.

Honey workstations can be specified to meet New York electrical requirements. A flexible infeed, junction box and removable cover is included when specifying New York Power. The infeed and junction box are required to be on the Starter Panel at the first workstation next to a Single or Double Sided Power Panel. The customer will need to specify if the removable cover will need to be on the inside or outside of the workstation Starter Panel. NYPE: New York Power - \$425 list.

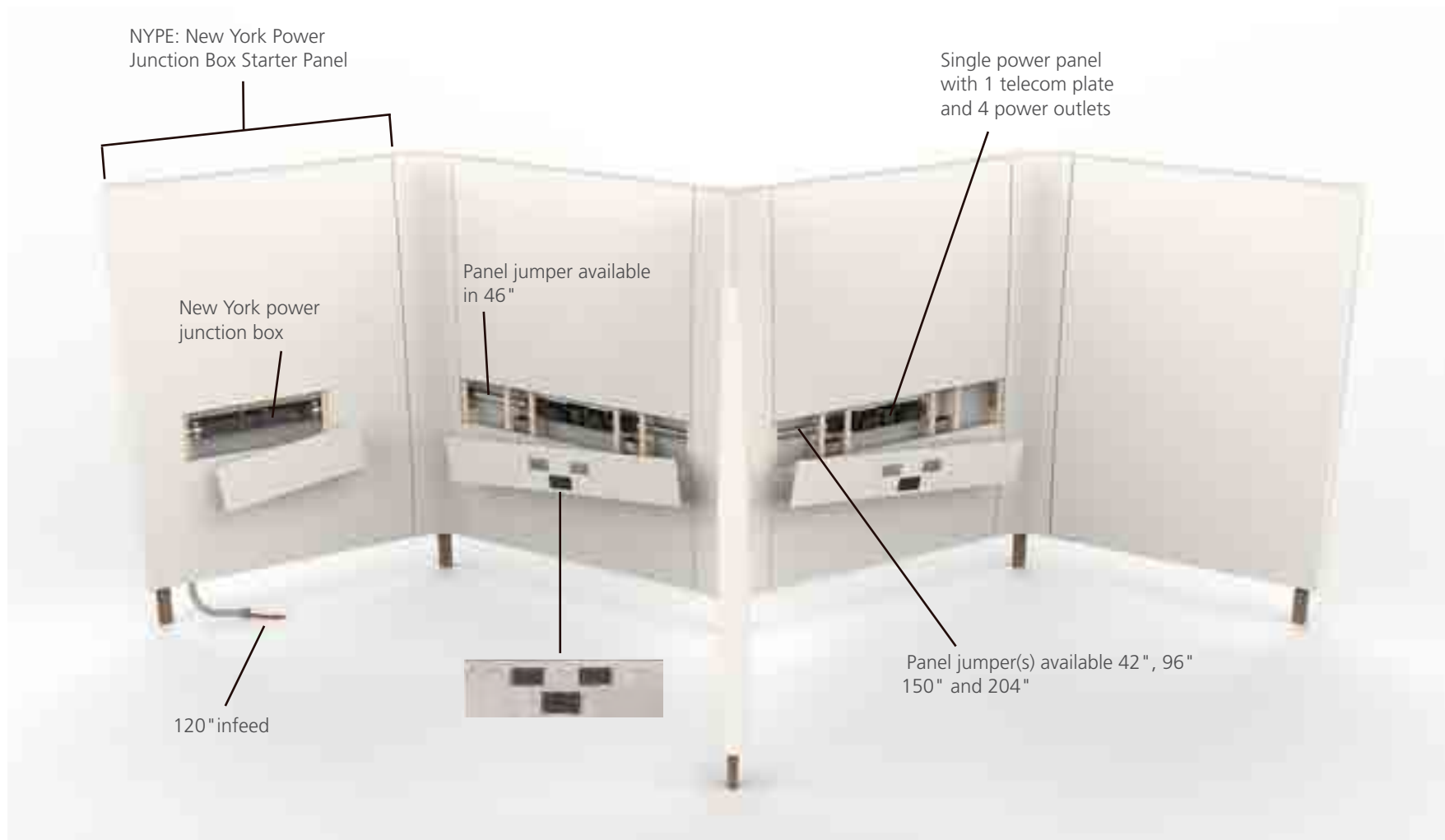

Rounded Starter Panels are not available with NYPE: New York Power Entry option.

\*Please check with general contractor to see if NYPE: New York Power option is required.

## Honey West Coast power.

Honey workstations can be specified to meet West Coast electrical requirements. A Circuitrac energy management system and flexible infeed is included and must be specifying on a Starter Panel at the first workstation next to a Single or Double Sided Power Panel. The customer will need to specify if the removable cover will need to be on the inside or outside of the workstation Starter Panel. WCPE: West Coast Power - \$2,695.

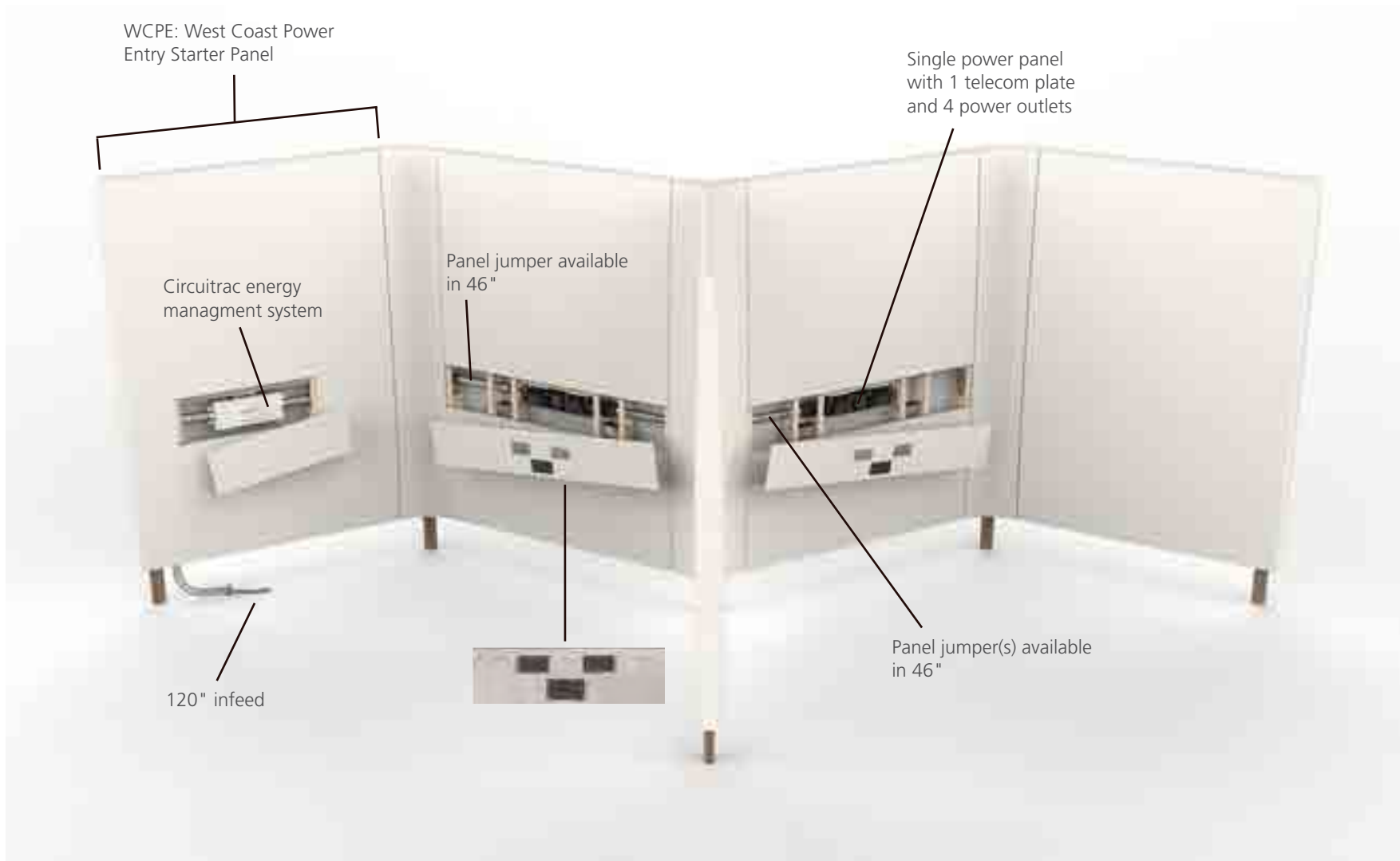

Rounded Starter Panels are not available with WCPE: West Coast Power option.

\*Please check with general contractor to see if WCPE: West Coast Power option is required.

## Honey Chicago power.

Honey workstations can be specified with a Single or Double Sided Power Panel to meet Chicago electrical requirements. Chicago Power Panels include an electrical box inside Power Panels for a local electrician to wire receptacles and connectors. CSSPP: Single Sided Power Panel - \$25. CDSPP: Double Sided Power Panel - \$50.

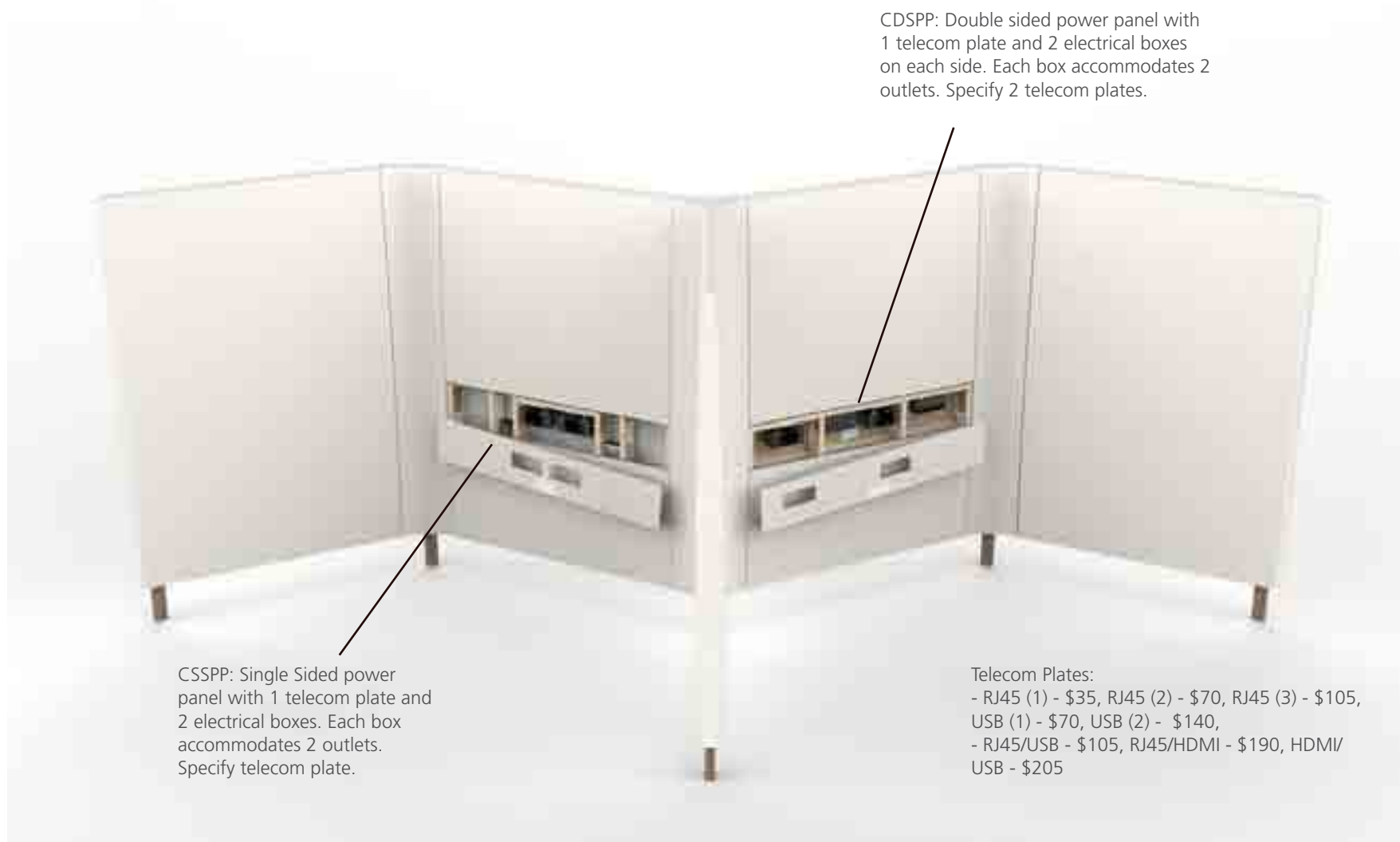

CDSPP: Double sided power panel with 1 telecom plate and 2 electrical boxes on each side. Each box accommodates 2 outlets. Specify 2 telecom plates.

CSSPP: Single Sided power panel with 1 telecom plate and 2 electrical boxes. Each box accommodates 2 outlets. Specify telecom plate.

Telecom Plates:  
 - RJ45 (1) - \$35, RJ45 (2) - \$70, RJ45 (3) - \$105,  
 USB (1) - \$70, USB (2) - \$140,  
 - RJ45/USB - \$105, RJ45/HDMI - \$190, HDMI/  
 USB - \$205

\*Please check with general contractor to see if Chicago Power is required.

## Honey drawer dimensions | filing reference

### Interior drawer dimensions

UNIT DEPTH	DRAWER TYPE	OVERALL DIMENSIONS			INTERIOR DRAWER DIMENSIONS			NOTES
		W	D	H	W	D	H	
15-5/8" Letter	18" Box	13-1/8	16-1/16	4	12-1/8	15-1/16	3-7/16	Units less than 72"
	18" File	13-1/8	16-1/16	9-13/16	12-1/8	15-1/16	9-5/16	Units less than 72"
	10" Box	7-1/2	16-1/16	4	6-1/2	15-1/16	3-7/16	
	10" File	7-1/2	16-1/16	9-13/16	6-1/2	15-1/16	9-5/16	

### Filing reference

#### Filing for 10" depth units

7-1/2" Wide File Drawer - 16 1/16" Deep



Letter Side to Side

Mobile Pedestal and Tower

# Honey.

Inline Diagonal Workstation Typical  
Position 1 with Height Adjustable Worksurface

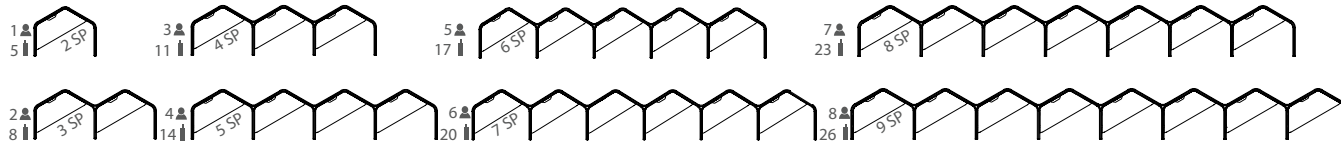

Number of Feet per Typical (MTL10 Option) "SP" Number of Starter Panels per Typical (RSP Option)

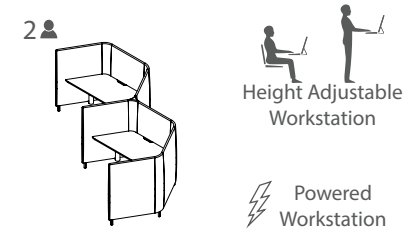

DARRAN

## Product features.

- 5" Solid wood feet - oval shape, ships KD
- 4 Power outlets with 1 telecom plate, see options below for telecom plate
- Adjustable height from 27" to 47.5" with a maximum weight capacity of 275 lbs. Lift standard in MFW White, optional MFB Black
- HNY7227WT163 Height Adjustable worksurfaces are included
- Wire management tray attaches to worksurface top, standard in MFW White, see premium metal finish for options

### NOTES

- 1" Gap between worksurface and panels to drop wires below worksurface
- Metal parts include 5 year warranty
- Programmable height adjustable mechanism, motor includes 2 year warranty

## Options.

### ACCESSORIES

- K28: Articulating Keyboard w/ Mouse - \$390
- K31-SK: Center drawer w/ skirt - \$310
- K31: Center drawer w/o skirt - \$205

### CONCEALED FLOOR POWER INFEED COVER

- PCEB: White metal finish concealed floor power infeed cover - \$150

### DELETE TOP AND WIRE TRAY

- DHAT: Delete height adjustable top. Deduct \$3265 Veneer(W), \$3095 High Pressure Laminate(G), \$2770 Thermally Fused Laminate(M) per top

### METAL FEET

- MTL10: Replace solid wood feet with metal feet, standard MFW White - \$55 ea

### PREMIUM METAL FINISH

- Specify premium metal finish. MFMB: Matte Black, MFS: Silver, MFSS: Salmon Sienna, MFSA: Surfing Aquavert, MFPS: Pistachio, MFOS: Oyster, MFNA: Navy, MFOL: Olive, MFGB: Grey Beige MFGG: Graphite Gray, MFG: Gray
- Premium metal finish for WMT Wire Management Tray - \$75 ea
- Premium metal finish for MTL10 Metal Feet - \$20 ea
- Premium metal finish for PCEB Concealed Floor Power Infeed Cover - \$35

### STARTER PANEL

- RSP: Substitute round starter panel in place of flat starter panel. Must substitute all starters, priced per starter panel - \$83 each. See HNY3555SP888

### TELECOM PLATES

- Each power unit has 1 plate. All telecom connectors sold separately.
- RJ45 (1) - \$35, RJ45 (2) - \$70, RJ45 (3) - \$105, USB (1) - \$70, USB (2) - \$140, RJ45/USB - \$105, RJ45/HDMI - \$190, HDMI/USB - \$205

1 Select a model w" x d" x h"	PERSON	yardage	Standard Veneer Top Upholstered Panels - COM\$		Premium Veneer Top Upholstered Panels - COM\$		High Pressure Laminate Top Upholstered Panels - COM\$		Thermally Fused Laminate Top Upholstered Panels - COM\$	
602 x 62 x 55	8	96	HNY60262HA571W	58699	"P" Option N/A	HNY60262HA571G	57339	HNY60262HA571M	54739	
528 x 62 x 55	7	84	HNY52862HA571W	51505	"P" Option N/A	HNY52862HA571G	50315	HNY52862HA571M	48040	
453 x 62 x 55	6	73	HNY45362HA571W	44311	"P" Option N/A	HNY45362HA571G	43291	HNY45362HA571M	41341	
378 x 62 x 55	5	61	HNY37862HA571W	37117	"P" Option N/A	HNY37862HA571G	36267	HNY37862HA571M	34642	
303 x 62 x 55	4	50	HNY30362HA571W	29923	"P" Option N/A	HNY30362HA571G	29243	HNY30362HA571M	27943	
228 x 62 x 55	3	38	HNY22862HA571W	22729	"P" Option N/A	HNY22862HA571G	22219	HNY22862HA571M	21244	
153 x 62 x 55	2	27	HNY15362HA571W	15535	"P" Option N/A	HNY15362HA571G	15195	HNY15362HA571M	14545	
78 x 62 x 55	1	15	HNY7862HA571W	8341	"P" Option N/A	HNY7862HA571G	8171	HNY7862HA571M	7846	

2 Select a worksurface finish								
WWP	WBW			GEC	LW01	MEC		
PO01	WSW			GWL	LW02	MOC		
PO02	WEC			LP01	LW04	MSW		
PO03	WOW			LP02	LW05	MTW		
PO04	WNO			LF01	LW06	MWL		
PO05	WSO			LF02	LW07			
PO06				LF03				
PO07				LN01				
PO08				LA01				
PO09				LA02				

3 Select feet finish								
WWP	WBW			WWP	WBW	WWP	WBW	
PO01	WSW			PO01	WSW	PO01	WSW	
PO02	WEC			PO02	WEC	PO02	WEC	
PO03	WOW			PO03	WOW	PO03	WOW	
PO04	WNO			PO04	WNO	PO04	WNO	
PO05	WSO			PO05	WSO	PO05	WSO	
PO06				PO06		PO06		
PO07				PO07		PO07		
PO08				PO08		PO08		
PO09				PO09		PO09		

4 Select an edge								
Cliff-1 Veneer	Cliff-2 Black	Cliff-3 White		Cliff-1 HPL	Cliff-2 Black	Cliff-3 White		
Flat-1 Veneer	Flat-2 Black	Flat-3 White		Flat-2 Black	Flat-3 White	Flat-4 Matching		

# Honey.

## Inline Diagonal Workstation Typical Position 1 with Fixed Worksurface

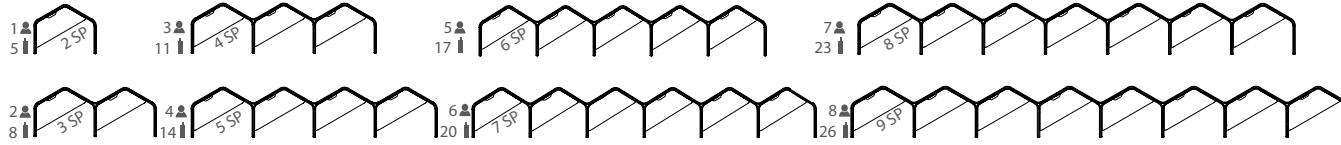

Number of Feet per Typical (MTL10 Option) "SP" Number of Starter Panels per Typical (RSP Option)

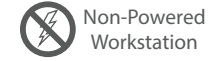
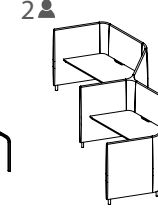

[View statement of line](#)

### Product features.

- 5" Solid wood feet - oval shape
- HNY7227WT162 Fixed Desk Height worksurfaces, 29" worksurface height
- Ships KD

### Options.

#### ACCESSORIES

- K28: Articulating Keyboard w/ Mouse - \$390
- K31-SK: Center drawer w/ skirt - \$310
- K31: Center drawer w/o skirt - \$205

#### CONCEALED FLOOR POWER INFEED COVER

- PCEB: White metal finish concealed floor power infeed cover - \$150

#### DELETE TOP

- DFT: Delete fixed top. Deduct \$1125 Veneer(W), \$955 High Pressure Laminate (G), \$630 Thermally Fused Laminate (M) per top

#### METAL FEET

- MTL10: Replace solid wood feet with metal feet, standard MFW White - \$55 ea

#### PREMIUM METAL FINISH

- Specify premium metal finish. MFMB: Matte Black, MFS: Silver, MFSS: Salmon Sienna, MFSA: Surfin Aquavert, MFPS: Pistachio, MFOS: Oyster, MFNA: Navy, MFOL: Olive, MFGB: Grey Beige MFGG: Graphite Gray, MFG: Gray
- Premium metal finish for WMT Wire Management Tray - \$75 ea
- Premium metal finish for MTL10 Metal Feet - \$20 ea
- Premium metal finish for PCEB Concealed Floor Power Infeed Cover - \$35

#### STARTER PANEL

- RSP: Substitute round starter panel in place of flat starter panel. Must substitute all starters, priced per starter panel - \$83 each. See HNY3555SP888

#### WORKSURFACE HEIGHT

- Modify worksurface height to bar height.
- THL42: Position worksurface at bar height - N/C

#### WIRE TRAY

- WMT: Wire metal tray. Mounts under top and comes standard in MFW White - \$210

1 Select a model w" x d" x h"	PERSON	yardage	Standard Veneer Top Upholstered Panels - COM\$		Premium Veneer Top Upholstered Panels - COM\$		High Pressure Laminate Top Upholstered Panels - COM\$		Thermally Fused Laminate Top Upholstered Panels - COM\$	
602 x 62 x 55	8	96	HNY60262FT571W	38505	"P" Option N/A	HNY60262FT571G	37145	HNY60262FT571M	34545	
528 x 62 x 55	7	84	HNY52862FT571W	33839	"P" Option N/A	HNY52862FT571G	32649	HNY52862FT571M	30374	
453 x 62 x 55	6	73	HNY45362FT571W	29173	"P" Option N/A	HNY45362FT571G	28153	HNY45362FT571M	26203	
378 x 62 x 55	5	61	HNY37862FT571W	24507	"P" Option N/A	HNY37862FT571G	23657	HNY37862FT571M	22032	
303 x 62 x 55	4	50	HNY30362FT571W	19841	"P" Option N/A	HNY30362FT571G	19161	HNY30362FT571M	17861	
228 x 62 x 55	3	38	HNY22862FT571W	15175	"P" Option N/A	HNY22862FT571G	14665	HNY22862FT571M	13690	
153 x 62 x 55	2	27	HNY15362FT571W	10509	"P" Option N/A	HNY15362FT571G	10169	HNY15362FT571M	9519	
78 x 62 x 55	1	15	HNY7862FT571W	5843	"P" Option N/A	HNY7862FT571G	5673	HNY7862FT571M	5348	

2 Select a worksurface finish <a href="#">View finish details</a>	WVP	WBW	GEC	LW01	MEC
PO01	WSW		GWL	LW02	MOC
PO02	WEC		LP01	LW04	MSW
PO03	WOW		LP02	LW05	MTW
PO04	WNO		LF01	LW06	MWL
PO05	WSO		LF02	LW07	
PO06			LF03		
PO07			LN01		
PO08			LA01		
PO09			LA02		

3 Select feet finish <a href="#">View finish details</a>	WVP	WBW	WVP	WBW	WVP	WBW
PO01	WSW		PO01	WSW	PO01	WSW
PO02	WEC		PO02	WEC	PO02	WEC
PO03	WOW		PO03	WOW	PO03	WOW
PO04	WNO		PO04	WNO	PO04	WNO
PO05	WSO		PO05	WSO	PO05	WSO
PO06			PO06		PO06	
PO07			PO07		PO07	
PO08			PO08		PO08	
PO09			PO09		PO09	

4 Select a edge <a href="#">View edge details</a>	Cliff-1 Veneer	Cliff-2 Black	Cliff-3 White	Cliff-1 HPL	Cliff-2 Black	Cliff-3 White	Flat-2 Black	Flat-3 White	Flat-4 Matching	Flat-1 Veneer	Flat-2 Black	Flat-3 White

# Honey.

Inline Diagonal Workstation Typical  
Position 1 with Power Fixed Worksurface

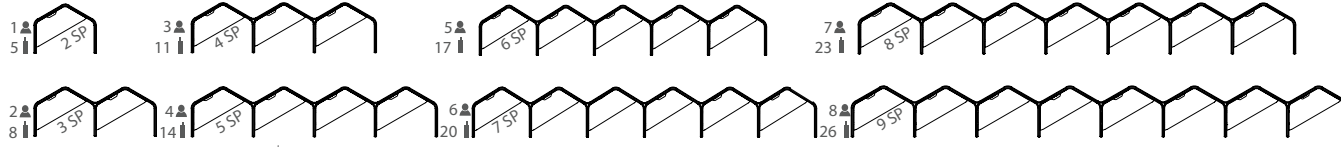

Number of Feet per Typical (MTL10 Option) "SP" Number of Starter Panels per Typical (RSP Option)

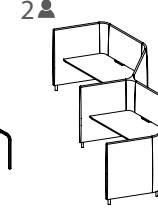

[View statement of line](#)

## Product features.

- HNY7227WT162 Fixed Desk Height worksurfaces, 29" worksurface height
- 5" Solid wood feet - oval shape
- 4 Power outlets with 1 telecom plate, see options below for telecom plate
- Ships KD
- Wire management tray attaches to worksurface top, standard in MFW White, see premium metal finish for options
- Hardwire infeed and jumpers are included in workstations

## Options.

### ACCESSORIES

- K28: Articulating Keyboard w/ Mouse - \$390
- K31-SK: Center drawer w/ skirt - \$310
- K31: Center drawer w/o skirt - \$205

### CONCEALED FLOOR POWER INFEED COVER

- PCEB: White metal finish concealed floor power infeed cover - \$150

### DELETE TOP AND WIRE TRAY

- DFP: Delete fixed top. Deduct \$1335 Veneer (W), \$1165 High Pressure Laminate (G), \$840 Thermally Fused Laminate (M) per top

### METAL FEET

- MTL10: Replace solid wood feet with metal feet, standard MFW White - \$55 ea

### PREMIUM METAL FINISH

- Specify premium metal finish. MFMB: Matte Black, MFS: Silver, MFSS: Salmon Sienna, MFSA: Surfin Aquavert, MFPS: Pistachio, MFOS: Oyster, MFNA: Navy, MFOL: Olive, MFGB: Grey Beige MFGG: Graphite Gray, MFG: Gray
- Premium metal finish for WMT Wire Management Tray - \$75 ea
- Premium metal finish for MTL10 Metal Feet - \$20 ea
- Premium metal finish for PCEB Concealed Floor Power Infeed Cover - \$35

### STARTER PANEL

- RSP: Substitute round starter panel in place of flat starter panel. Must substitute all starters, priced per starter panel - \$83 each. See HNY3555SP888

### TELECOM PLATES

- Each power unit has 1 plate. All telecom connectors sold separately.
- RJ45 (1) - \$35, RJ45 (2) - \$70, RJ45 (3) - \$105, USB (1) - \$70, USB (2) - \$140, RJ45/USB - \$105, RJ45/HDMI - \$190, HDMI/USB - \$205

### WORKSURFACE HEIGHT

- THL42: Modify worksurface height to bar height - N/C

1 Select a model w" x d" x h"	PERSON	yardage	Standard Veneer Top Upholstered Panels - COM\$		Premium Veneer Top Upholstered Panels - COM\$		High Pressure Laminate Top Upholstered Panels - COM\$		Thermally Fused Laminate Top Upholstered Panels - COM\$	
602 x 62 x 55	8	96	HNY60262FP571W	43259	"P" Option N/A	HNY60262FP571G	41899	HNY60262FP571M	39299	
528 x 62 x 55	7	84	HNY52862FP571W	37995	"P" Option N/A	HNY52862FP571G	36805	HNY52862FP571M	34530	
453 x 62 x 55	6	73	HNY45362FP571W	32731	"P" Option N/A	HNY45362FP571G	31711	HNY45362FP571M	29761	
378 x 62 x 55	5	61	HNY37862FP571W	27467	"P" Option N/A	HNY37862FP571G	26617	HNY37862FP571M	24992	
303 x 62 x 55	4	50	HNY30362FP571W	22203	"P" Option N/A	HNY30362FP571G	21523	HNY30362FP571M	20223	
228 x 62 x 55	3	38	HNY22862FP571W	16939	"P" Option N/A	HNY22862FP571G	16429	HNY22862FP571M	15454	
153 x 62 x 55	2	27	HNY15362FP571W	11675	"P" Option N/A	HNY15362FP571G	11335	HNY15362FP571M	10685	
78 x 62 x 55	1	15	HNY7862FP571W	6411	"P" Option N/A	HNY7862FP571G	6241	HNY7862FP571M	5916	

2 Select a worksurface finish <a href="#">View finish details</a>	WWP	WBW	GEC	LW01	MEC
Wire Tray Metal finish Standard in MFW White. See premium finishes for options.	PO01	WSW	GWL	LW02	MOC
	PO02	WEC	LP01	LW04	MSW
	PO03	WOW	LP02	LW05	MTW
	PO04	WNO	LF01	LW06	MWL
	PO05	WSO	LF02	LW07	
	PO06		LF03		
	PO07		LN01		
	PO08		LA01		
	PO09		LA02		

3 Select feet finish <a href="#">View finish details</a>	WWP	WBW	WWP	WBW	WWP	WBW
	PO01	WSW	PO01	WSW	PO01	WSW
	PO02	WEC	PO02	WEC	PO02	WEC
	PO03	WOW	PO03	WOW	PO03	WOW
	PO04	WNO	PO04	WNO	PO04	WNO
	PO05	WSO	PO05	WSO	PO05	WSO
	PO06		PO06		PO06	
	PO07		PO07		PO07	
	PO08		PO08		PO08	
	PO09		PO09		PO09	

4 Select a edge <a href="#">View edge details</a>	Cliff-1 Veneer	Cliff-2 Black	Cliff-3 White	Flat-1 Veneer	Flat-2 Black	Flat-3 White

# Honey.

Inline Diagonal Workstation Typical  
Position 2 with Height Adjustable Worksurface

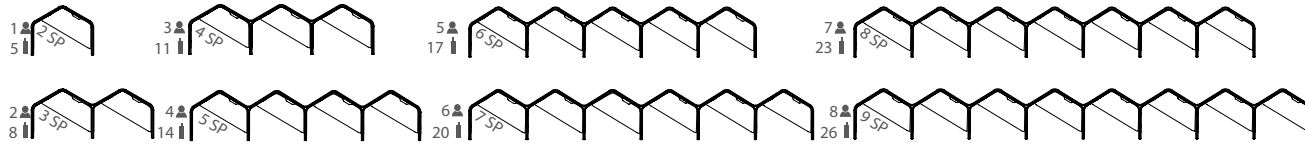

Number of Feet per Typical (MTL10 Option) "SP" Number of Starter Panels per Typical (RSP Option)

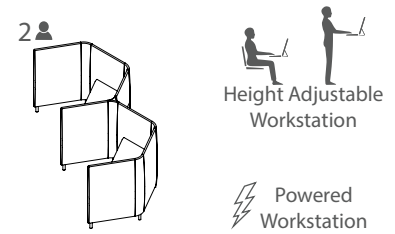

[View statement of line](#)

## Product features.

- 5" Solid wood feet - oval shape, ships KD
- 4 Power outlets with 1 telecom plate, see options below for telecom plate
- Adjustable height from 27" to 47.5" with a maximum weight capacity of 275 lbs. Lift standard in MFW White, optional MFB Black
- HNY7227WT163 Height Adjustable worksurfaces are included
- Wire management tray attaches to worksurface top, standard in MFW White, see premium metal finish for options

### NOTES

- 1" Gap between worksurface and panels to drop wires below worksurface
- Metal parts include 5 year warranty
- Programmable height adjustable mechanism, motor includes 2 year warranty

## Options.

### ACCESSORIES

- K28: Articulating Keyboard w/ Mouse - \$390
- K31-SK: Center drawer w/ skirt - \$310
- K31: Center drawer w/o skirt - \$205

### CONCEALED FLOOR POWER INFEED COVER

- PCEB: White metal finish concealed floor power infeed cover - \$150

### DELETE TOP AND WIRE TRAY

- DHAT: Delete height adjustable top. Deduct \$3265 Veneer(W), \$3095 High Pressure Laminate(G), \$2770 Thermally Fused Laminate(M) per top

### METAL FEET

- MTL10: Replace solid wood feet with metal feet, standard MFW White - \$55 ea

### PREMIUM METAL FINISH

- Specify premium metal finish. MFMB: Matte Black, MFS: Silver, MFSS: Salmon Sienna, MFSA: Surfing Aquavert, MFPS: Pistachio, MFOS: Oyster, MFNA: Navy, MFOL: Olive, MFGB: Grey Beige MFGG: Graphite Gray, MFG: Gray
- Premium metal finish for WMT Wire Management Tray - \$75 ea
- Premium metal finish for MTL10 Metal Feet - \$20 ea
- Premium metal finish for PCEB Concealed Floor Power Infeed Cover - \$35

### STARTER PANEL

- RSP: Substitute round starter panel in place of flat starter panel. Must substitute all starters, priced per starter panel - \$83 each. See HNY3555SP888

### TELECOM PLATES

- Each power unit has 1 plate. All telecom connectors sold separately.
- RJ45 (1) - \$35, RJ45 (2) - \$70, RJ45 (3) - \$105, USB (1) - \$70, USB (2) - \$140, RJ45/USB - \$105, RJ45/HDMI - \$190, HDMI/USB - \$205

1 Select a model w" x d" x h"	PERSON	yardage	Standard Veneer Top Upholstered Panels - COM\$		Premium Veneer Top Upholstered Panels - COM\$		High Pressure Laminate Top Upholstered Panels - COM\$		Thermally Fused Laminate Top Upholstered Panels - COM\$	
602 x 62 x 55	8	96	HNY60262HA572W	58699	"P" Option N/A	HNY60262HA572G	57339	HNY60262HA572M	54739	
528 x 62 x 55	7	84	HNY52862HA572W	51505	"P" Option N/A	HNY52862HA572G	50315	HNY52862HA572M	48040	
453 x 62 x 55	6	73	HNY45362HA572W	44311	"P" Option N/A	HNY45362HA572G	43291	HNY45362HA572M	41341	
378 x 62 x 55	5	61	HNY37862HA572W	37117	"P" Option N/A	HNY37862HA572G	36267	HNY37862HA572M	34642	
303 x 62 x 55	4	50	HNY30362HA572W	29923	"P" Option N/A	HNY30362HA572G	29243	HNY30362HA572M	27943	
228 x 62 x 55	3	38	HNY22862HA572W	22729	"P" Option N/A	HNY22862HA572G	22219	HNY22862HA572M	21244	
153 x 62 x 55	2	27	HNY15362HA572W	15535	"P" Option N/A	HNY15362HA572G	15195	HNY15362HA572M	14545	
78 x 62 x 55	1	15	HNY7862HA572W	8341	"P" Option N/A	HNY7862HA572G	8171	HNY7862HA572M	7846	

  

2 Select a worksurface finish <a href="#">View finish details</a>	Metal finish Height adjustable column standard in MFW White. Optional MFB Black.		GEC	LW01	MEC				
	WWP	WBW							
3 Select feet finish <a href="#">View finish details</a>	PO01	WSW	WWP	WBW	WWP				
	PO02	WEC							
	PO03	WOW							
	PO04	WNO							
	PO05	WSO							
	PO06								
	PO07								
	PO08								
	PO09								
4 Select a edge <a href="#">View edge details</a>	Cliff-1 Veneer	Cliff-2 Black	Cliff-3 White	HPL	Cliff-2 Black	Cliff-3 White	Flat-2 Black	Flat-3 White	Flat-4 Matching
	Flat-1 Veneer	Flat-2 Black	Flat-3 White						



# Honey.

## Inline Diagonal Workstation Typical Position 2 with Fixed Worksurface

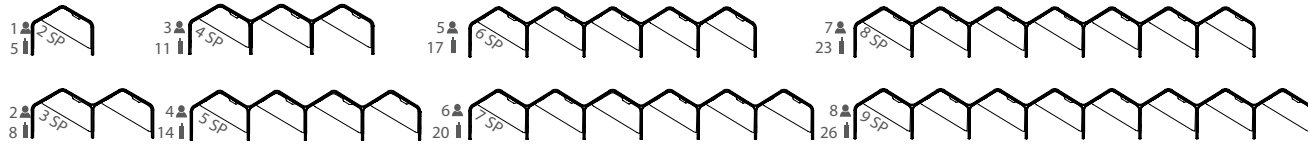

Number of Feet per Typical (MTL10 Option) "SP" Number of Starter Panels per Typical (RSP Option)

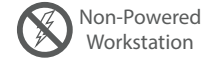
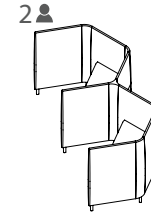

[View statement of line](#)

### Product features.

- 5" Solid wood feet - oval shape
- HNY7227WT162 Fixed Desk Height worksurfaces, 29" worksurface height
- Ships KD

### Options.

#### ACCESSORIES

- K28: Articulating Keyboard w/ Mouse - \$390
- K31-SK: Center drawer w/ skirt - \$310
- K31: Center drawer w/o skirt - \$205

#### CONCEALED FLOOR POWER INFEED COVER

- PCEB: White metal finish concealed floor power infeed cover - \$150

#### DELETE TOP

- DFT: Delete fixed top. Deduct \$1125 Veneer(W), \$955 High Pressure Laminate (G), \$630 Thermally Fused Laminate (M) per top

#### METAL FEET

- MTL10: Replace solid wood feet with metal feet, standard MFW White - \$55 ea

#### PREMIUM METAL FINISH

- Specify premium metal finish. MFMB: Matte Black, MFS: Silver, MFSS: Salmon Sienna, MFSA: Surfin Aquavert, MFPS: Pistachio, MFOS: Oyster, MFNA: Navy, MFOL: Olive, MFGB: Grey Beige MFGG: Graphite Gray, MFG: Gray
- Premium metal finish for WMT Wire Management Tray - \$75 ea
- Premium metal finish for MTL10 Metal Feet - \$20 ea
- Premium metal finish for PCEB Concealed Floor Power Infeed Cover - \$35

#### STARTER PANEL

- RSP: Substitute round starter panel in place of flat starter panel. Must substitute all starters, priced per starter panel - \$83 each. See HNY3555SP888

#### WORKSURFACE HEIGHT

- Modify worksurface height to bar height.
- THL-42: Position worksurface at bar height - N/C

#### WIRE TRAY

- WMT: Wire metal tray. Mounts under top and comes standard in MFW White - \$210

1 Select a model w" x d" x h"	PERSON	yardage	Standard Veneer Top Upholstered Panels - COM\$		Premium Veneer Top Upholstered Panels - COM\$		High Pressure Laminate Top Upholstered Panels - COM\$		Thermally Fused Laminate Top Upholstered Panels - COM\$	
602 x 62 x 55	8	96	HNY60262FT572W	38505	"P" Option N/A	HNY60262FT572G	37145	HNY60262FT572M	34545	
528 x 62 x 55	7	84	HNY52862FT572W	33839	"P" Option N/A	HNY52862FT572G	32649	HNY52862FT572M	30374	
453 x 62 x 55	6	73	HNY45362FT572W	29173	"P" Option N/A	HNY45362FT572G	28153	HNY45362FT572M	26203	
378 x 62 x 55	5	61	HNY37862FT572W	24507	"P" Option N/A	HNY37862FT572G	23657	HNY37862FT572M	22032	
303 x 62 x 55	4	50	HNY30362FT572W	19841	"P" Option N/A	HNY30362FT572G	19161	HNY30362FT572M	17861	
228 x 62 x 55	3	38	HNY22862FT572W	15175	"P" Option N/A	HNY22862FT572G	14665	HNY22862FT572M	13690	
153 x 62 x 55	2	27	HNY15362FT572W	10509	"P" Option N/A	HNY15362FT572G	10169	HNY15362FT572M	9519	
78 x 62 x 55	1	15	HNY7862FT572W	5843	"P" Option N/A	HNY7862FT572G	5673	HNY7862FT572M	5348	

2 Select a worksurface finish <a href="#">View finish details</a>								
WWP	WBW	GEC	LW01	MEC				
PO01	WSW	GWL	LW02	MOC				
PO02	WEC	LP01	LW04	MSW				
PO03	WOW	LP02	LW05	MTW				
PO04	WNO	LF01	LW06	MWL				
PO05	WSO	LF02	LW07					
PO06		LF03						
PO07		LN01						
PO08		LA01						
PO09		LA02						

3 Select feet finish <a href="#">View finish details</a>								
WWP	WBW	WWP	WBW	WWP	WBW			
PO01	WSW	PO01	WSW	PO01	WSW			
PO02	WEC	PO02	WEC	PO02	WEC			
PO03	WOW	PO03	WOW	PO03	WOW			
PO04	WNO	PO04	WNO	PO04	WNO			
PO05	WSO	PO05	WSO	PO05	WSO			
PO06		PO06		PO06				
PO07		PO07		PO07				
PO08		PO08		PO08				
PO09		PO09		PO09				

4 Select an edge <a href="#">View edge details</a>						
Cliff-1 Veneer	Cliff-2 Black	Cliff-3 White	Cliff-1 HPL	Cliff-2 Black	Cliff-3 White	Flat-2 Black
Flat-1 Veneer	Flat-2 Black	Flat-3 White	Flat-1 HPL	Flat-2 Black	Flat-3 White	Flat-3 Matching

# Honey.

## Inline Diagonal Workstation Typical Position 2 with Power Fixed Worksurface

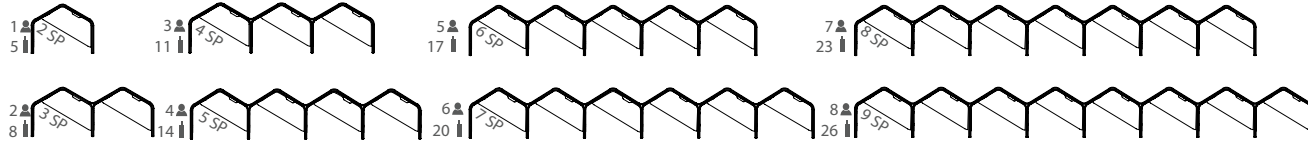

Number of Feet per Typical (MTL10 Option) "SP" Number of Starter Panels per Typical (RSP Option)

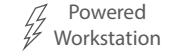
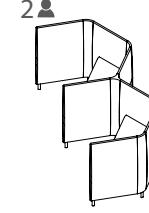

[View statement of line](#)

## Product features.

- HNY7227WT162 Fixed Desk Height worksurfaces, 29" worksurface height
- 5" Solid wood feet - oval shape
- 4 Power outlets with 1 telecom plate, see options below for telecom plate
- Ships KD
- Wire management tray attaches to worksurface top, standard in MFW White, see premium metal finish for options
- Hardwire infeed and jumpers are included in workstations

## Options.

### ACCESSORIES

- K28: Articulating Keyboard w/ Mouse - \$390
- K31-SK: Center drawer w/ skirt - \$310
- K31: Center drawer w/o skirt - \$205

### CONCEALED FLOOR POWER INFEED COVER

- PCEB: White metal finish concealed floor power infeed cover - \$150

### DELETE TOP AND WIRE TRAY

- DFP: Delete fixed top. Deduct \$1335 Veneer (W), \$1165 High Pressure Laminate (G), \$840 Thermally Fused Laminate (M) per top

### METAL FEET

- MTL10: Replace solid wood feet with metal feet, standard MFW White - \$55 ea

### PREMIUM METAL FINISH

- Specify premium metal finish. MFMB: Matte Black, MFS: Silver, MFSS: Salmon Sienna, MFSA: Surfin Aquavert, MFPS: Pistachio, MFOS: Oyster, MFNA: Navy, MFOL: Olive, MFGB: Grey Beige MFGG: Graphite Gray, MFG: Gray
- Premium metal finish for WMT Wire Management Tray - \$75 ea
- Premium metal finish for MTL10 Metal Feet - \$20 ea
- Premium metal finish for PCEB Concealed Floor Power Infeed Cover - \$35

### STARTER PANEL

- RSP: Substitute round starter panel in place of flat starter panel. Must substitute all starters, priced per starter panel - \$83 each. See HNY3555SP888

### TELECOM PLATES

- Each power unit has 1 plate. All telecom connectors sold separately.
- RJ45 (1) - \$35, RJ45 (2) - \$70, RJ45 (3) - \$105, USB (1) - \$70, USB (2) - \$140, RJ45/USB - \$105, RJ45/HDMI - \$190, HDMI/USB - \$205

### WORKSURFACE HEIGHT

- THL42: Modify worksurface height to bar height - N/C

1 Select a model w" x d" x h"	PERSON	yardage	Standard Veneer Top Upholstered Panels - COM\$		Premium Veneer Top Upholstered Panels - COM\$		High Pressure Laminate Top Upholstered Panels - COM\$		Thermally Fused Laminate Top Upholstered Panels - COM\$	
602 x 62 x 55	8	96	HNY60262FP572W	43259	"P" Option N/A	HNY60262FP572G	41899	HNY60262FP572M	39299	
528 x 62 x 55	7	84	HNY52862FP572W	37995	"P" Option N/A	HNY52862FP572G	36805	HNY52862FP572M	34530	
453 x 62 x 55	6	73	HNY45362FP572W	32731	"P" Option N/A	HNY45362FP572G	31711	HNY45362FP572M	29761	
378 x 62 x 55	5	61	HNY37862FP572W	27467	"P" Option N/A	HNY37862FP572G	26617	HNY37862FP572M	24992	
303 x 62 x 55	4	50	HNY30362FP572W	22203	"P" Option N/A	HNY30362FP572G	21523	HNY30362FP572M	20223	
228 x 62 x 55	3	38	HNY22862FP572W	16939	"P" Option N/A	HNY22862FP572G	16429	HNY22862FP572M	15454	
153 x 62 x 55	2	27	HNY15362FP572W	11675	"P" Option N/A	HNY15362FP572G	11335	HNY15362FP572M	10685	
78 x 62 x 55	1	15	HNY7862FP572W	6411	"P" Option N/A	HNY7862FP572G	6241	HNY7862FP572M	5916	

2 Select a worksurface finish	WWP	WBW	GEC	LW01	MEC
<a href="#">View finish details</a>	PO01	WSW	GWL	LW02	MOC
Wire Tray Metal finish Standard in MFW White. See premium finishes for options.	PO02	WEC	LP01	LW04	MSW
	PO03	WOW	LP02	LW05	MTW
	PO04	WNO	LF01	LW06	MWL
	PO05	WSO	LF02	LW07	
	PO06		LF03		
	PO07		LN01		
	PO08		LA01		
	PO09		LA02		

3 Select feet finish	WWP	WBW	WWP	WBW	WWP	WBW
<a href="#">View finish details</a>	PO01	WSW	PO01	WSW	PO01	WSW
	PO02	WEC	PO02	WEC	PO02	WEC
	PO03	WOW	PO03	WOW	PO03	WOW
	PO04	WNO	PO04	WNO	PO04	WNO
	PO05	WSO	PO05	WSO	PO05	WSO
	PO06		PO06		PO06	
	PO07		PO07		PO07	
	PO08		PO08		PO08	
	PO09		PO09		PO09	

4 Select a edge	Cliff-1 Veneer	Cliff-2 Black	Cliff-3 White	Flat-2 Black	Flat-3 White	Flat-4 Matching
<a href="#">View edge details</a>						
	Flat-1 Veneer	Flat-2 Black	Flat-3 White	Flat-1 HPL	Flat-2 Black	Flat-3 White

# Honey.

## Facing Diagonal Workstation Typical Position 1 with Height Adjustable Worksurface

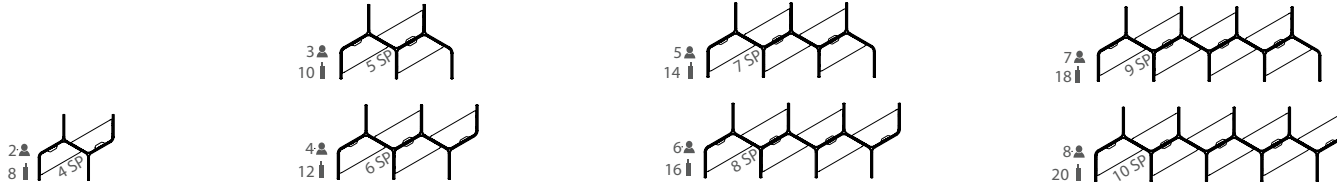

Number of Feet per Typical (MTL10 Option) "SP" Number of Starter Panels per Typical (RSP Option)

2 people

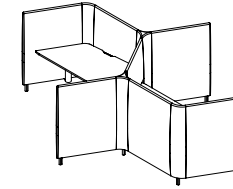

Height Adjustable Workstation

Powered Workstation

DARRAN

[View statement of line](#)

## Product features.

- 5" Solid wood feet - oval shape, ships KD
- 4 Power outlets with 1 telecom plate, see options below for telecom plate
- Adjustable height from 27" to 47.5" with a maximum weight capacity of 275 lbs. Lift standard in MFW White, optional MFB Black
- HNY7227WT163 Height Adjustable worksurfaces are included
- Wire management tray attaches to worksurface top, standard in MFW White, see premium metal finish for options

### NOTES

- 1" Gap between worksurface and panels to drop wires below worksurface
- Metal parts include 5 year warranty
- Programmable height adjustable mechanism, motor includes 2 year warranty

## Options.

### ACCESSORIES

- K28: Articulating Keyboard w/ Mouse - \$390
- K31-SK: Center drawer w/ skirt - \$310
- K31: Center drawer w/o skirt - \$205

### CONCEALED FLOOR POWER INFEED COVER

- PCEB: White metal finish concealed floor power infeed cover - \$150

### DELETE TOP AND WIRE TRAY

- DHAT: Delete height adjustable top. Deduct \$3265 Veneer(W), \$3095 High Pressure Laminate(G), \$2770 Thermally Fused Laminate(M) per top

### METAL FEET

- MTL10: Replace solid wood feet with metal feet, standard MFW White - \$55 ea

### PREMIUM METAL FINISH

- Specify premium metal finish. MFMB: Matte Black, MFS: Silver, MFSS: Salmon Sienna, MFSA: Surfing Aquavert, MFPS: Pistachio, MFOS: Oyster, MFNA: Navy, MFOL: Olive, MFGB: Grey Beige MFGG: Graphite Gray, MFG: Gray
- Premium metal finish for WMT Wire Management Tray - \$75 ea
- Premium metal finish for MTL10 Metal Feet - \$20 ea
- Premium metal finish for PCEB Concealed Floor Power Infeed Cover - \$35

### STARTER PANEL

- RSP: Substitute round starter panel in place of flat starter panel. Must substitute all starters, priced per starter panel - \$83 each. See HNY3555SP888

### TELECOM PLATES

- Each power unit has 1 plate. All telecom connectors sold separately.
- RJ45 (1) - \$35, RJ45 (2) - \$70, RJ45 (3) - \$105, USB (1) - \$70, USB (2) - \$140, RJ45/USB - \$105, RJ45/HDMI - \$190, HDMI/USB - \$205

1 Select a model w" x d" x h"	PERSON	yardage	Standard Veneer Top Upholstered Panels - COM\$		Premium Veneer Top Upholstered Panels - COM\$		High Pressure Laminate Top Upholstered Panels - COM\$		Thermally Fused Laminate Top Upholstered Panels - COM\$	
340 x 101 x 55	8	71	HNY340101HA573W	49403	"P" Option N/A	HNY340101HA573G	48043	HNY340101HA573M	45443	
303 x 101 x 55	7	64	HNY303101HA573W	43529	"P" Option N/A	HNY303101HA573G	42339	HNY303101HA573M	40064	
265 x 101 x 55	6	56	HNY265101HA573W	37974	"P" Option N/A	HNY265101HA573G	36954	HNY265101HA573M	35004	
228 x 101 x 55	5	49	HNY228101HA573W	32100	"P" Option N/A	HNY228101HA573G	31250	HNY228101HA573M	29625	
191 x 101 x 55	4	41	HNY191101HA573W	26545	"P" Option N/A	HNY191101HA573G	25865	HNY191101HA573M	24565	
153 x 101 x 55	3	34	HNY153101HA573W	20671	"P" Option N/A	HNY153101HA573G	20161	HNY153101HA573M	19186	
116 x 101 x 55	2	26	HNY116101HA573W	15116	"P" Option N/A	HNY116101HA573G	14776	HNY116101HA573M	14126	

2 Select a worksurface finish <a href="#">View finish details</a>	Metal finish Height adjustable column standard in MFW White. Optional MFB Black.		GEC	LW01	MEC
	WWP	WBW			
3 Select feet finish <a href="#">View finish details</a>	PO01	WSW	LP01	LW04	MSW
	PO02	WEC			
	PO03	WOW			
	PO04	WNO			
	PO05	WSO			
	PO06				
	PO07				
	PO08				
	PO09				

4 Select an edge <a href="#">View edge details</a>	Cliff-1 Veneer			Cliff-2 Black			Cliff-3 White		
	Flat-1 Veneer	Flat-2 Black	Flat-3 White	HPL	Black	White	Black	White	Matching
Metal column finish (MFW or MFB)									

# Honey.

## Facing Diagonal Workstation Typical Position 1 Desk with Fixed Worksurface

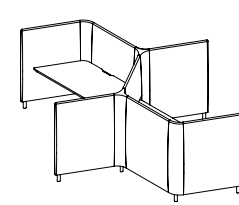
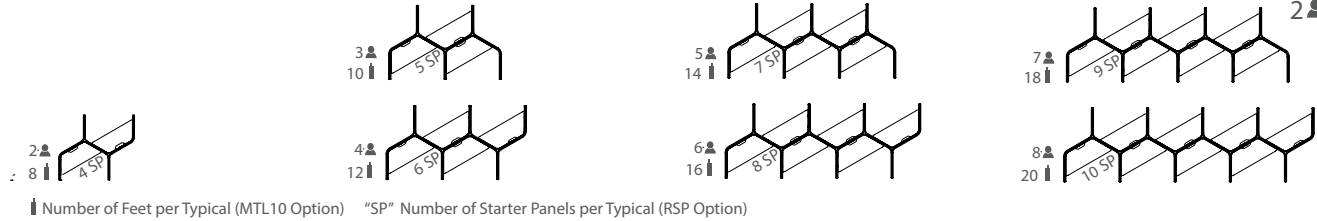

[View statement of line](#)

### Product features.

- 5" Solid wood feet - oval shape
- HNY7227WT162 Fixed Desk Height worksurfaces, 29" worksurface height
- Ships KD

### Options.

#### ACCESSORIES

- K28: Articulating Keyboard w/ Mouse - \$390
- K31-SK: Center drawer w/ skirt - \$310
- K31: Center drawer w/o skirt - \$205

#### CONCEALED FLOOR POWER INFEED COVER

- PCEB: White metal finish concealed floor power infeed cover - \$150

#### DELETE TOP

- DFT: Delete fixed top. Deduct \$1125 Veneer(W), \$955 High Pressure Laminate (G), \$630 Thermally Fused Laminate (M) per top

#### METAL FEET

- MTL10: Replace soild wood feet with metal feet, standard MFW White - \$55 ea

#### PREMIUM METAL FINISH

- Specify premium metal finish. MFMB: Matte Black, MFS: Silver, MFSS: Salmon Sienna, MFSA: Surfin Aquavert, MFPS: Pistachio, MFOS: Oyster, MFNA: Navy, MFOL: Olive, MFGB: Grey Beige MFGG: Graphite Gray, MFG: Gray
- Premium metal finish for WMT Wire Management Tray - \$75 ea
- Premium metal finish for MTL10 Metal Feet - \$20 ea
- Premium metal finish for PCEB Concealed Floor Power Infeed Cover - \$35

#### STARTER PANEL

- RSP: Substitute round starter panel in place of flat starter panel. Must substitute all starters, priced per starter panel - \$83 each. See HNY3555SP888

#### WORKSURFACE HEIGHT

- Modify worksurface height to bar height.
- THL-42: Position worksurface at bar height - N/C

#### WIRE TRAY

- WMT: Wire metal tray. Mounts under top and comes standard in MFW White - \$210

1 Select a model w" x d" x h"	PERSON	yardage	Standard Veneer Top Upholstered Panels - COM\$		Premium Veneer Top Upholstered Panels - COM\$		High Pressure Laminate Top Upholstered Panels - COM\$		Thermally Fused Laminate Top Upholstered Panels - COM\$	
340 x 101 x 55	8	71	HNY340101FT573W	30166	"P" Option N/A	HNY340101FT573G	28806	HNY340101FT573M	26206	
303 x 101 x 55	7	64	HNY303101FT573W	26820	"P" Option N/A	HNY303101FT573G	25630	HNY303101FT573M	23355	
265 x 101 x 55	6	56	HNY265101FT573W	23474	"P" Option N/A	HNY265101FT573G	22454	HNY265101FT573M	20504	
228 x 101 x 55	5	49	HNY228101FT573W	20128	"P" Option N/A	HNY228101FT573G	19278	HNY228101FT573M	17653	
191 x 101 x 55	4	41	HNY191101FT573W	16782	"P" Option N/A	HNY191101FT573G	16102	HNY191101FT573M	14802	
153 x 101 x 55	3	34	HNY153101FT573W	13436	"P" Option N/A	HNY153101FT573G	12926	HNY153101FT573M	11951	
116 x 101 x 55	2	26	HNY116101FT573W	10090	"P" Option N/A	HNY116101FT573G	9750	HNY116101FT573M	9100	

2 Select a worksurface finish <a href="#">View finish details</a>								
WWP	WBW			GEC	LW01	MEC		
PO01	WSW			GWL	LW02	MOC		
PO02	WEC			LP01	LW04	MSW		
PO03	WOW			LP02	LW05	MTW		
PO04	WNO			LF01	LW06	MWL		
PO05	WSO			LF02	LW07			
PO06				LF03				
PO07				LN01				
PO08				LA01				
PO09				LA02				

3 Select feet finish <a href="#">View finish details</a>								
WWP	WBW			WWP	WBW			
PO01	WSW			PO01	WSW			
PO02	WEC			PO02	WEC			
PO03	WOW			PO03	WOW			
PO04	WNO			PO04	WNO			
PO05	WSO			PO05	WSO			
PO06				PO06				
PO07				PO07				
PO08				PO08				
PO09				PO09				

4 Select a edge <a href="#">View edge details</a>										
Cliff-1 Veneer	Cliff-2 Black	Cliff-3 White		Cliff-1 HPL	Cliff-2 Black	Cliff-3 White		Flat-2 Black	Flat-3 White	Flat-4 Matching
Flat-1 Veneer	Flat-2 Black	Flat-3 White		Flat-1 HPL	Flat-2 Black	Flat-3 White				

# Honey.

## Facing Diagonal Workstation Typical Position 1 Desk with Power Fixed Worksurface

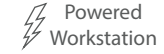
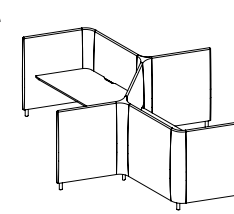
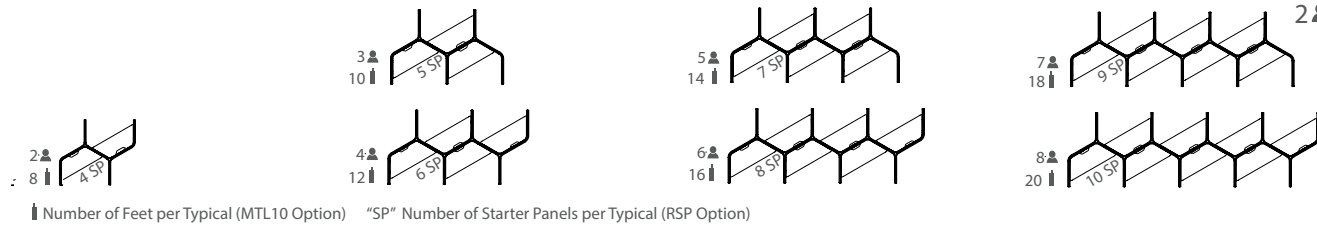

[View statement of line](#)

### Product features.

- HNY7227WT162 Fixed Desk Height worksurfaces, 29" worksurface height
- 5" Solid wood feet - oval shape
- 4 Power outlets with 1 telecom plate, see options below for telecom plate
- Ships KD
- Wire management tray attaches to worksurface top, standard in MFW White, see premium metal finish for options
- Hardwire infeed and jumpers are included in workstations

### Options.

#### ACCESSORIES

- K28: Articulating Keyboard w/ Mouse - \$390
- K31-SK: Center drawer w/ skirt - \$310
- K31: Center drawer w/o skirt - \$205

#### CONCEALED FLOOR POWER INFEEED COVER

- PCEB: White metal finish concealed floor power infeed cover - \$150

#### DELETE TOP AND WIRE TRAY

- DFP: Delete fixed top. Deduct \$1335 Veneer (W), \$1165 High Pressure Laminate (G), \$840 Thermally Fused Laminate (M) per top

#### METAL FEET

- MTL10: Replace solid wood feet with metal feet, standard MFW White - \$55 ea

#### PREMIUM METAL FINISH

- Specify premium metal finish. MFMB: Matte Black, MFS: Silver, MFSS: Salmon Sienna, MFSA: Surfin Aquavert, MFPS: Pistachio, MFOS: Oyster, MFNA: Navy, MFOL: Olive, MFGB: Grey Beige MFGG: Graphite Gray, MFG: Gray
- Premium metal finish for WMT Wire Management Tray - \$75 ea
- Premium metal finish for MTL10 Metal Feet - \$20 ea
- Premium metal finish for PCEB Concealed Floor Power Infeed Cover - \$35

#### STARTER PANEL

- RSP: Substitute round starter panel in place of flat starter panel. Must substitute all starters, priced per starter panel - \$83 each. See HNY3555SP888

#### TELECOM PLATES

- Each power unit has 1 plate. All telecom connectors sold separately.
- RJ45 (1) - \$35, RJ45 (2) - \$70, RJ45 (3) - \$105, USB (1) - \$70, USB (2) - \$140, RJ45/USB - \$105, RJ45/HDMI - \$190, HDMI/USB - \$205

#### WORKSURFACE HEIGHT

- THL42: Modify worksurface height to bar height - N/C

1 Select a model w" x d" x h"	PERSON	yardage	Standard Veneer Top Upholstered Panels - COM\$		Premium Veneer Top Upholstered Panels - COM\$		High Pressure Laminate Top Upholstered Panels - COM\$		Thermally Fused Laminate Top Upholstered Panels - COM\$	
340 x 101 x 55	8	71	HNY340101FP573W	33963	"P" Option N/A	HNY340101FP573G	32603	HNY340101FP573M	30003	
303 x 101 x 55	7	64	HNY303101FP573W	30019	"P" Option N/A	HNY303101FP573G	28829	HNY303101FP573M	26554	
265 x 101 x 55	6	56	HNY265101FP573W	26394	"P" Option N/A	HNY265101FP573G	25374	HNY265101FP573M	23424	
228 x 101 x 55	5	49	HNY228101FP573W	22450	"P" Option N/A	HNY228101FP573G	21600	HNY228101FP573M	19975	
191 x 101 x 55	4	41	HNY191101FP573W	18825	"P" Option N/A	HNY191101FP573G	18145	HNY191101FP573M	16845	
153 x 101 x 55	3	34	HNY153101FP573W	14881	"P" Option N/A	HNY153101FP573G	14371	HNY153101FP573M	13396	
116 x 101 x 55	2	26	HNY116101FP573W	11256	"P" Option N/A	HNY116101FP573G	10916	HNY116101FP573M	10266	

2 Select a worksurface finish								
WWP	WBW							
PO01	WSW				GEC	LW01		MEC
PO02	WEC				GWL	LW02		MOC
PO03	WOW				LP01	LW04		MSW
PO04	WNO				LP02	LW05		MTW
PO05	WSO				LF01	LW06		MWL
PO06					LF02	LW07		
PO07					LF03			
PO08					LN01			
PO09					LA01			
					LA02			

3 Select feet finish								
WWP	WBW				WWP	WBW		
PO01	WSW				PO01	WSW		
PO02	WEC				PO02	WEC		
PO03	WOW				PO03	WOW		
PO04	WNO				PO04	WNO		
PO05	WSO				PO05	WSO		
PO06					PO06			
PO07					PO07			
PO08					PO08			
PO09					PO09			

4 Select an edge								
Cliff-1 Veneer	Cliff-2 Black	Cliff-3 White			Cliff-1 HPL	Cliff-2 Black	Cliff-3 White	
Flat-1 Veneer	Flat-2 Black	Flat-3 White			Flat-1 HPL	Flat-2 Black	Flat-3 White	

# Honey.

## Facing Diagonal Workstation Typical Position 2 Desk with Height Adjustable Worksurface

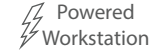
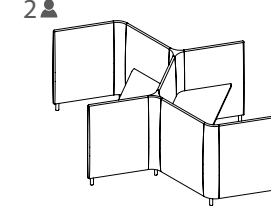
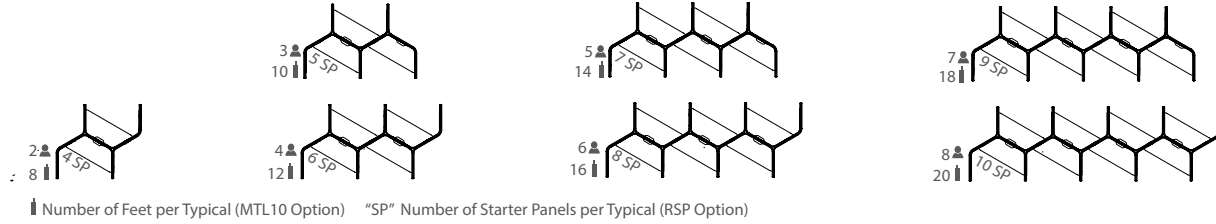

[View statement of line](#)

### Product features.

- 5" Solid wood feet - oval shape, ships KD
- 4 Power outlets with 1 telecom plate, see options below for telecom plate
- Adjustable height from 27" to 47.5" with a maximum weight capacity of 275 lbs. Lift standard in MFW White, optional MFB Black
- HNY7227WT163 Height Adjustable worksurfaces are included
- Wire management tray attaches to worksurface top, standard in MFW White, see premium metal finish for options

#### NOTES

- 1" Gap between worksurface and panels to drop wires below worksurface
- Metal parts include 5 year warranty
- Programmable height adjustable mechanism, motor includes 2 year warranty

### Options.

#### ACCESSORIES

- K28: Articulating Keyboard w/ Mouse - \$390
- K31-SK: Center drawer w/ skirt - \$310
- K31: Center drawer w/o skirt - \$205

#### CONCEALED FLOOR POWER INFEED COVER

- PCEB: White metal finish concealed floor power infeed cover - \$150

#### DELETE TOP AND WIRE TRAY

- DHAT: Delete height adjustable top. Deduct \$3265 Veneer(W), \$3095 High Pressure Laminate(G), \$2770 Thermally Fused Laminate(M) per top

#### METAL FEET

- MTL10: Replace solid wood feet with metal feet, standard MFW White - \$55 ea

#### PREMIUM METAL FINISH

- Specify premium metal finish. MFMB: Matte Black, MFS: Silver, MFSS: Salmon Sienna, MFSA: Surfing Aquavert, MFPS: Pistachio, MFOS: Oyster, MFNA: Navy, MFOL: Olive, MFGB: Grey Beige MFGG: Graphite Gray, MFG: Gray
- Premium metal finish for WMT Wire Management Tray - \$75 ea
- Premium metal finish for MTL10 Metal Feet - \$20 ea
- Premium metal finish for PCEB Concealed Floor Power Infeed Cover - \$35

#### STARTER PANEL

- RSP: Substitute round starter panel in place of flat starter panel. Must substitute all starters, priced per starter panel - \$83 each. See HNY3555SP888

#### TELECOM PLATES

- Each power unit has 1 plate. All telecom connectors sold separately.
- RJ45 (1) - \$35, RJ45 (2) - \$70, RJ45 (3) - \$105, USB (1) - \$70, USB (2) - \$140, RJ45/USB - \$105, RJ45/HDMI - \$190, HDMI/USB - \$205

1 Select a model w" x d" x h"	PERSON	yardage	Standard Veneer Top Upholstered Panels - COM\$		Premium Veneer Top Upholstered Panels - COM\$		High Pressure Laminate Top Upholstered Panels - COM\$		Thermally Fused Laminate Top Upholstered Panels - COM\$	
340 x 101 x 55	8	71	HNY340101HA574W	49134	"P" Option N/A	HNY340101HA574G	47774	HNY340101HA574M	45174	
303 x 101 x 55	7	64	HNY303101HA574W	43579	"P" Option N/A	HNY303101HA574G	42389	HNY303101HA574M	40114	
265 x 101 x 55	6	56	HNY265101HA574W	37705	"P" Option N/A	HNY265101HA574G	36685	HNY265101HA574M	34735	
228 x 101 x 55	5	49	HNY228101HA574W	32150	"P" Option N/A	HNY228101HA574G	31300	HNY228101HA574M	29675	
191 x 101 x 55	4	41	HNY191101HA574W	26276	"P" Option N/A	HNY191101HA574G	25596	HNY191101HA574M	24296	
153 x 101 x 55	3	34	HNY153101HA574W	20721	"P" Option N/A	HNY153101HA574G	20211	HNY153101HA574M	19236	
116 x 101 x 55	2	26	HNY116101HA574W	14847	"P" Option N/A	HNY116101HA574G	14507	HNY116101HA574M	13857	

2 Select a worksurface finish									
WWP	WBW	GEC	LW01	MEC					
PO01	WSW	GWL	LW02	MOC					
PO02	WEC	LP01	LW04	MSW					
PO03	WOW	LP02	LW05	MTW					
PO04	WNO	LF01	LW06	MWL					
PO05	WSO	LF02	LW07						
PO06		LF03							
PO07		LN01							
PO08		LA01							
PO09		LA02							

3 Select feet finish									
WWP	WBW	WWP	WBW	WWP	WBW				
PO01	WSW	PO01	WSW	PO01	WSW				
PO02	WEC	PO02	WEC	PO02	WEC				
PO03	WOW	PO03	WOW	PO03	WOW				
PO04	WNO	PO04	WNO	PO04	WNO				
PO05	WSO	PO05	WSO	PO05	WSO				
PO06		PO06		PO06					
PO07		PO07		PO07					
PO08		PO08		PO08					
PO09		PO09		PO09					

4 Select an edge									
Cliff-1 Veneer	Cliff-2 Black	Cliff-3 White	Cliff-1 HPL	Cliff-2 Black	Cliff-3 White	Flat-2 Black	Flat-3 White	Flat-4 Matching	
Flat-1 Veneer	Flat-2 Black	Flat-3 White	Flat-1 HPL	Flat-2 Black	Flat-3 White				

# Honey.

## Facing Diagonal Workstation Typical Position 2 Desk with Power Fixed Worksurface

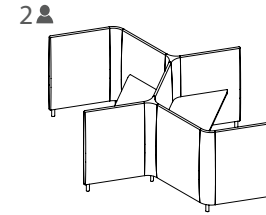
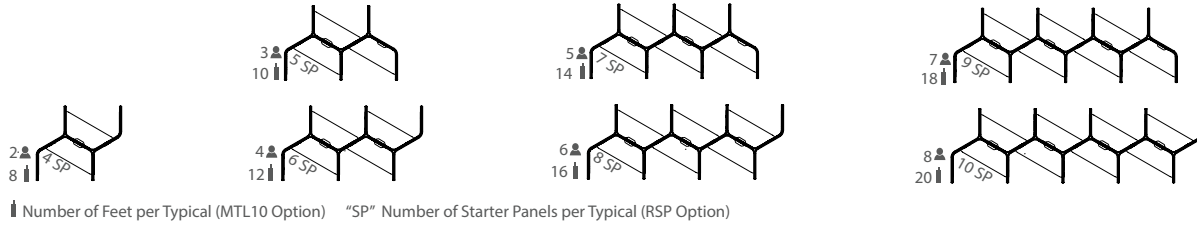

[View Statement of Work](#)

## Product features.

- HNY7227WT162 Fixed Desk Height worksurfaces, 29" worksurface height
- 5" Solid wood feet - oval shape
- 4 Power outlets with 1 telecom plate, see options below for telecom plate
- Ships KD
- Wire management tray attaches to worksurface top, standard in MFW White, see premium metal finish for options
- Hardwire infeed and jumpers are included in workstations

## Options.

### ACCESSORIES

- K28: Articulating Keyboard w/ Mouse - \$390
- K31-SK: Center drawer w/ skirt - \$310
- K31: Center drawer w/o skirt - \$205

### CONCEALED FLOOR POWER INFEED COVER

- PCEB: White metal finish concealed floor power infeed cover - \$150

### DELETE TOP AND WIRE TRAY

- DFP: Delete fixed top. Deduct \$1335 Veneer (W), \$1165 High Pressure Laminate (G), \$840 Thermally Fused Laminate (M) per top

### METAL FEET

- MTL10: Replace solid wood feet with metal feet, standard MFW White - \$55 ea

### PREMIUM METAL FINISH

- Specify premium metal finish. MFMB: Matte Black, MFS: Silver, MFSS: Salmon Sienna, MFSA: Surfin Aquavert, MFPS: Pistachio, MFOS: Oyster, MFNA: Navy, MFOL: Olive, MFGB: Grey Beige MFGG: Graphite Gray, MFG: Gray
- Premium metal finish for WMT Wire Management Tray - \$75 ea
- Premium metal finish for MTL10 Metal Feet - \$20 ea
- Premium metal finish for PCEB Concealed Floor Power Infeed Cover - \$35

### STARTER PANEL

- RSP: Substitute round starter panel in place of flat starter panel. Must substitute all starters, priced per starter panel - \$83 each. See HNY3555SP888

### TELECOM PLATES

- Each power unit has 1 plate. All telecom connectors sold separately.
- RJ45 (1) - \$35, RJ45 (2) - \$70, RJ45 (3) - \$105, USB (1) - \$70, USB (2) - \$140, RJ45/USB - \$105, RJ45/HDMI - \$190, HDMI/USB - \$205

### WORKSURFACE HEIGHT

- THL42: Modify worksurface height to bar height - N/C

1 Select a model w" x d" x h"	person	yardage	Standard Veneer Top Upholstered Panels - COM\$		Premium Veneer Top Upholstered Panels - COM\$		High Pressure Laminate Top Upholstered Panels - COM\$		Thermally Fused Laminate Top Upholstered Panels - COM\$	
340 x 101 x 55	8	71	HNY340101FP574W	33694	"P" Option N/A	HNY340101FP574G	32334	HNY340101FP574M	29734	
303 x 101 x 55	7	64	HNY303101FP574W	30069	"P" Option N/A	HNY303101FP574G	28879	HNY303101FP574M	26604	
265 x 101 x 55	6	56	HNY265101FP574W	26125	"P" Option N/A	HNY265101FP574G	25105	HNY265101FP574M	23155	
228 x 101 x 55	5	49	HNY228101FP574W	22500	"P" Option N/A	HNY228101FP574G	21650	HNY228101FP574M	20025	
191 x 101 x 55	4	41	HNY191101FP574W	18556	"P" Option N/A	HNY191101FP574G	17876	HNY191101FP574M	16576	
153 x 101 x 55	3	34	HNY153101FP574W	14931	"P" Option N/A	HNY153101FP574G	14421	HNY153101FP574M	13446	
116 x 101 x 55	2	26	HNY116101FP574W	10987	"P" Option N/A	HNY116101FP574G	10647	HNY116101FP574M	9997	
2 Select a worksurface finish <a href="#">View finish details</a>			WWP	WBW		GEC	LW01	MEC		
			PO01	WSW		GWL	LW02	MOC		
<a href="#">View edge details</a>			PO02	WEC		LP01	LW04	MSW		
Wire Tray Metal finish Standard in MFW White. See premium finishes for options.			PO03	WOW		LP02	LW05	MTW		
			PO04	WNO		LF01	LW06	MWL		
			PO05	WSO		LF02	LW07			
			PO06			LF03				
			PO07			LN01				
			PO08			LA01				
			PO09			LA02				
3 Select feet finish <a href="#">View edge details</a>			WWP	WBW		WWP	WBW	WWP	WBW	
			PO01	WSW		PO01	WSW	PO01	WSW	
			PO02	WEC		PO02	WEC	PO02	WEC	
			PO03	WOW		PO03	WOW	PO03	WOW	
			PO04	WNO		PO04	WNO	PO04	WNO	
			PO05	WSO		PO05	WSO	PO05	WSO	
			PO06			PO06		PO06		
			PO07			PO07		PO07		
			PO08			PO08		PO08		
			PO09			PO09		PO09		
4 Select a edge <a href="#">View hardware details</a>			Cliff-1 Veneer	Cliff-2 Black	Cliff-3 White	Cliff-1 HPL	Cliff-2 Black	Cliff-3 White	Flat-2 Black	
			Flat-1 Veneer	Flat-2 Black	Flat-3 White	Flat-1 HPL	Flat-2 Black	Flat-3 White	Flat-4 Matching	

# Honey.

Diamond Workstation Typical  
Diamond Workstation with Height Adjustable Worksurface

4  
8

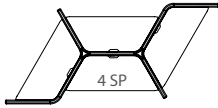

8  
14

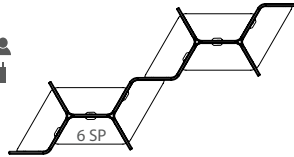

Number of Feet per Typical (MTL10 Option) "SP" Number of Starter Panels per Typical (RSP Option)

4  
8

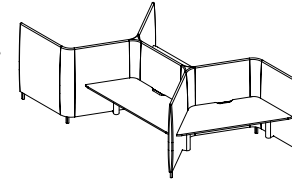

[View statement of line](#)

## Product features.

- 5" Solid wood feet - oval shape, ships KD
- 4 Power outlets with 1 telecom plate, see options below for telecom plate
- Adjustable height from 27" to 47.5" with a maximum weight capacity of 275 lbs. Lift standard in MFW White, optional MFB Black
- HNY7227WT163 Height Adjustable worksurfaces are included
- Wire management tray attaches to worksurface top, standard in MFW White, see premium metal finish for options

### NOTES

- 1" Gap between worksurface and panels to drop wires below worksurface
- Metal parts include 5 year warranty
- Programmable height adjustable mechanism, motor includes 2 year warranty

## Options.

### ACCESSORIES

- K28: Articulating Keyboard w/ Mouse - \$390
- K31-SK: Center drawer w/ skirt - \$310
- K31: Center drawer w/o skirt - \$205

### CONCEALED FLOOR POWER INFEED COVER

- PCEB: White metal finish concealed floor power infeed cover - \$150

### DELETE TOP AND WIRE TRAY

- DHAT: Delete height adjustable top. Deduct \$3265 Veneer(W), \$3095 High Pressure Laminate(G), \$2770 Thermally Fused Laminate(M) per top

### METAL FEET

- MTL10: Replace solid wood feet with metal feet, standard MFW White - \$55 ea

### PREMIUM METAL FINISH

- Specify premium metal finish. MFMB: Matte Black, MFS: Silver, MFSS: Salmon Sienna, MFSA: Surfing Aquavert, MFPS: Pistachio, MFOS: Oyster, MFNA: Navy, MFOL: Olive, MFGB: Grey Beige MFGG: Graphite Gray, MFG: Gray
- Premium metal finish for WMT Wire Management Tray - \$75 ea
- Premium metal finish for MTL10 Metal Feet - \$20 ea
- Premium metal finish for PCEB Concealed Floor Power Infeed Cover - \$35

### STARTER PANEL

- RSP: Substitute round starter panel in place of flat starter panel. Must substitute all starters, priced per starter panel - \$83 each. See HNY3555SP888

### TELECOM PLATES

- Each power unit has 1 plate. All telecom connectors sold separately.
- RJ45 (1) - \$35, RJ45 (2) - \$70, RJ45 (3) - \$105, USB (1) - \$70, USB (2) - \$140, RJ45/USB - \$105, RJ45/HDMI - \$190, HDMI/USB - \$205

1 Select a model w" x d" x h"	PERSON	yardage	Standard Veneer Top Upholstered Panels - COM\$		Premium Veneer Top Upholstered Panels - COM\$		High Pressure Laminate Top Upholstered Panels - COM\$		Thermally Fused Laminate Top Upholstered Panels - COM\$	
295 x 153 x 55	8	49	HNY295153HA575W	43038	"P" Option N/A	HNY295153HA575G	41678	HNY295153HA575M	39078	
166 x 78 x 55	4	26	HNY16678HA575W	21883	"P" Option N/A	HNY16678HA575G	21203	HNY16678HA575M	19903	

2 Select a worksurface finish										
WWP	WBW				GEC	LW01		MEC		
PO01	WSW				GWL	LW02		MOC		
PO02	WEC				LP01	LW04		MSW		
PO03	WOW				LP02	LW05		MTW		
PO04	WNO				LF01	LW06		MWL		
PO05	WSO				LF02	LW07				
PO06					LF03					
PO07					LN01					
PO08					LA01					
PO09					LA02					

3 Select feet finish										
WWP	WBW				WWP	WBW		WWP	WBW	
PO01	WSW				PO01	WSW		PO01	WSW	
PO02	WEC				PO02	WEC		PO02	WEC	
PO03	WOW				PO03	WOW		PO03	WOW	
PO04	WNO				PO04	WNO		PO04	WNO	
PO05	WSO				PO05	WSO		PO05	WSO	
PO06					PO06			PO06		
PO07					PO07			PO07		
PO08					PO08			PO08		
PO09					PO09			PO09		

4 Select a edge										
Cliff-1 Veneer	Cliff-2 Black	Cliff-3 White			Cliff-1 HPL	Cliff-2 Black	Cliff-3 White	Flat-2 Black	Flat-3 White	Flat-4 Matching
Flat-1 Veneer	Flat-2 Black	Flat-3 White			Flat-1 HPL	Flat-2 Black	Flat-3 White			



# Honey.

Diamond Workstation Typical  
Diamond Workstation with Fixed Worksurface

4  
8

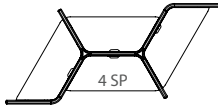

8  
14

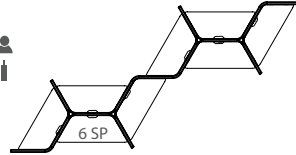

4  
8

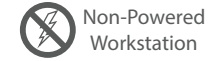
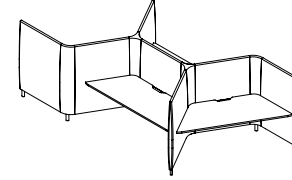

Number of Feet per Typical (MTL10 Option) "SP" Number of Starter Panels per Typical (RSP Option)

[View statement of line](#)

## Product features.

- 5" Solid wood feet - oval shape
- HNY7227WT162 Fixed Desk Height worksurfaces, 29" worksurface height
- Ships KD

## Options.

### ACCESSORIES

- K28: Articulating Keyboard w/ Mouse - \$390
- K31-SK: Center drawer w/ skirt - \$310
- K31: Center drawer w/o skirt - \$205

### CONCEALED FLOOR POWER INFEED COVER

- PCEB: White metal finish concealed floor power infeed cover - \$150

### DELETE TOP

- DFT: Delete fixed top. Deduct \$1125 Veneer(W), \$955 High Pressure Laminate (G), \$630 Thermally Fused Laminate (M) per top

### METAL FEET

- MTL10: Replace solid wood feet with metal feet, standard MFW White - \$55 ea

### PREMIUM METAL FINISH

- Specify premium metal finish. MFMB: Matte Black, MFS: Silver, MFSS: Salmon Sienna, MFSA: Surfin Aquavert, MFPS: Pistachio, MFOS: Oyster, MFNA: Navy, MFOL: Olive, MFGB: Grey Beige MFGG: Graphite Gray, MFG: Gray
- Premium metal finish for WMT Wire Management Tray - \$75 ea
- Premium metal finish for MTL10 Metal Feet - \$20 ea
- Premium metal finish for PCEB Concealed Floor Power Infeed Cover - \$35

### STARTER PANEL

- RSP: Substitute round starter panel in place of flat starter panel. Must substitute all starters, priced per starter panel - \$83 each. See HNY3555SP888

### WORKSURFACE HEIGHT

- Modify worksurface height to bar height.
- THL-42: Position worksurface at bar height - N/C

### WIRE TRAY

- WMT: Wire metal tray. Mounts under top and comes standard in MFW White - \$210

1 Select a model w" x d" x h"	PERSON	yardage	Standard Veneer Top Upholstered Panels - COM\$		Premium Veneer Top Upholstered Panels - COM\$		High Pressure Laminate Top Upholstered Panels - COM\$		Thermally Fused Laminate Top Upholstered Panels - COM\$	
295 x 153 x 55	8	49	HNY295153FT575W	23922	"P" Option N/A	HNY295153FT575G	22562	HNY295153FT575M	19962	
166 x 78 x 55	4	26	HNY16678FT575W	12340	"P" Option N/A	HNY16678FT575G	11660	HNY16678FT575M	10360	

2 Select a worksurface finish <a href="#">View finish details</a>								
WWP	WBW				GEC	LW01	MEC	
PO01	WSW				GWL	LW02	MOC	
PO02	WEC				LP01	LW04	MSW	
PO03	WOW				LP02	LW05	MTW	
PO04	WNO				LF01	LW06	MWL	
PO05	WSO				LF02	LW07		
PO06					LF03			
PO07					LN01			
PO08					LA01			
PO09					LA02			

3 Select feet finish <a href="#">View finish details</a>								
WWP	WBW				WWP	WBW		
PO01	WSW				PO01	WSW		
PO02	WEC				PO02	WEC		
PO03	WOW				PO03	WOW		
PO04	WNO				PO04	WNO		
PO05	WSO				PO05	WSO		
PO06					PO06			
PO07					PO07			
PO08					PO08			
PO09					PO09			

4 Select a edge <a href="#">View edge details</a>								
Cliff-1 Veneer	Cliff-2 Black	Cliff-3 White			Cliff-1 HPL	Cliff-2 Black	Cliff-3 White	
Flat-1 Veneer	Flat-2 Black	Flat-3 White			Flat-1 HPL	Flat-2 Black	Flat-3 White	

# Honey.

## Diamond Workstation Typical Diamond Workstation with Power Fixed Worksurface

4  
8



Number of Feet per Typical (MTL10 Option) "SP" Number of Starter Panels per Typical (RSP Option)

8  
14

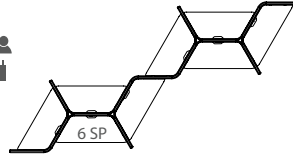

4  
8

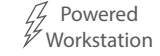
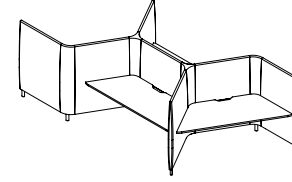

[View statement of line](#)

## Product features.

- HNY7227WT162 Fixed Desk Height worksurfaces, 29" worksurface height
- 5" Solid wood feet - oval shape
- 4 Power outlets with 1 telecom plate, see options below for telecom plate
- Ships KD
- Wire management tray attaches to worksurface top, standard in MFW White, see premium metal finish for options
- Hardwire infeed and jumpers are included in workstations

## Options.

### ACCESSORIES

- K28: Articulating Keyboard w/ Mouse - \$390
- K31-SK: Center drawer w/ skirt - \$310
- K31: Center drawer w/o skirt - \$205

### CONCEALED FLOOR POWER INFEEED COVER

- PCEB: White metal finish concealed floor power infeed cover - \$150

### DELETE TOP AND WIRE TRAY

- DFP: Delete fixed top. Deduct \$1335 Veneer (W), \$1165 High Pressure Laminate (G), \$840 Thermally Fused Laminate (M) per top

### METAL FEET

- MTL10: Replace solid wood feet with metal feet, standard MFW White - \$55 ea

### PREMIUM METAL FINISH

- Specify premium metal finish. MFMB: Matte Black, MFS: Silver, MFSS: Salmon Sienna, MFSA: Surfing Aquavert, MFPS: Pistachio, MFOS: Oyster, MFNA: Navy, MFOL: Olive, MFGB: Grey Beige MFGG: Graphite Gray, MFG: Gray
- Premium metal finish for WMT Wire Management Tray - \$75 ea
- Premium metal finish for MTL10 Metal Feet - \$20 ea
- Premium metal finish for PCEB Concealed Floor Power Infeed Cover - \$35

### STARTER PANEL

- RSP: Substitute round starter panel in place of flat starter panel. Must substitute all starters, priced per starter panel - \$83 each. See HNY3555SP888

### TELECOM PLATES

- Each power unit has 1 plate. All telecom connectors sold separately.
- RJ45 (1) - \$35, RJ45 (2) - \$70, RJ45 (3) - \$105, USB (1) - \$70, USB (2) - \$140, RJ45/USB - \$105, RJ45/HDMI - \$190, HDMI/USB - \$205

### WORKSURFACE HEIGHT

- THL42: Modify worksurface height to bar height - N/C

1 Select a model w" x d" x h"	person	yardage	Standard Veneer Top Upholstered Panels - COM\$		Premium Veneer Top Upholstered Panels - COM\$	High Pressure Laminate Top Upholstered Panels - COM\$		Thermally Fused Laminate Top Upholstered Panels - COM\$	
295 x 153 x 55	8	49	HNY295153FP575W	27598	"P" Option N/A	HNY295153FP575G	26238	HNY295153FP575M	23638
166 x 78 x 55	4	26	HNY16678FP575W	14163	"P" Option N/A	HNY16678FP575G	13483	HNY16678FP575M	12183

[Click Here for Graded in Pricing](#)

2 Select a worksurface finish <a href="#">View finish details</a>		
Wire Tray Metal finish Standard in MFW White. See premium finishes for options.	WWP	WBW
	PO01	WSW
	PO02	WEC
	PO03	WOW
	PO04	WNO
	PO05	WSO
	PO06	
	PO07	
	PO08	
	PO09	

3 Select feet finish <a href="#">View finish details</a>		
	WWP	WBW
	PO01	WSW
	PO02	WEC
	PO03	WOW
	PO04	WNO
	PO05	WSO
	PO06	
	PO07	
	PO08	
	PO09	

4 Select a edge <a href="#">View edge details</a>			
	Cliff-1 Veneer	Cliff-2 Black	Cliff-3 White
	Flat-1 Veneer	Flat-2 Black	Flat-3 White

GEC	LW01
GWL	LW02
LP01	LW04
LP02	LW05
LF01	LW06
LF02	LW07
LF03	
LN01	
LA01	
LA02	

WWP	WBW
PO01	WSW
PO02	WEC
PO03	WOW
PO04	WNO
PO05	WSO
PO06	
PO07	
PO08	
PO09	

Cliff-1 HPL	Cliff-2 Black	Cliff-3 White
Flat-1 HPL	Flat-2 Black	Flat-3 White

MEC	
MOC	
MSW	
MTW	
MWL	

WWP	WBW
PO01	WSW
PO02	WEC
PO03	WOW
PO04	WNO
PO05	WSO
PO06	
PO07	
PO08	
PO09	

Flat-2 Black	Flat-3 White	Flat-4 Matching
-----------------	-----------------	--------------------

# Honey.

Inline Hexagon Workstation Typical  
Position 1 Desk with Height Adjustable Worksurface

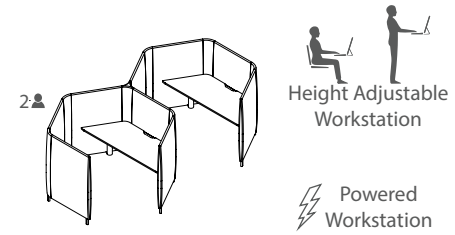
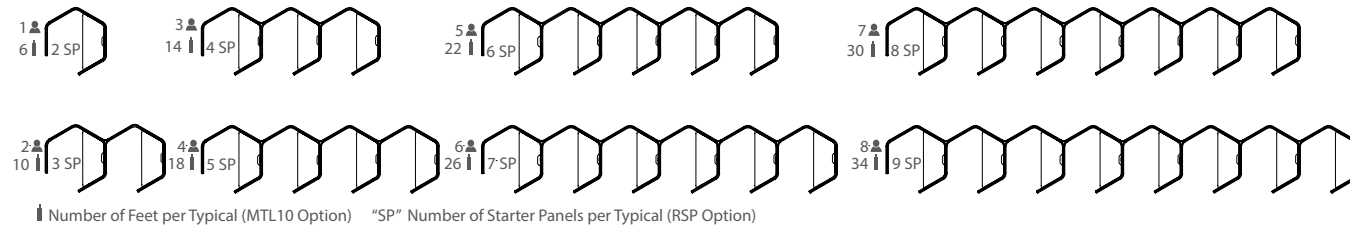

[View statement of line](#)

## Product features.

- 5" Solid wood feet - oval shape, ships KD
- 4 Power outlets with 1 telecom plate, see options below for telecom plate
- Adjustable height from 27" to 47.5" with a maximum weight capacity of 275 lbs. Lift standard in MFW White, optional MFB Black
- HNY7227WT163 Height Adjustable worksurfaces are included
- Wire management tray attaches to worksurface top, standard in MFW White, see premium metal finish for options

### NOTES

- 1" Gap between worksurface and panels to drop wires below worksurface
- Metal parts include 5 year warranty
- Programmable height adjustable mechanism, motor includes 2 year warranty

## Options.

### ACCESSORIES

- K28: Articulating Keyboard w/ Mouse - \$390
- K31-SK: Center drawer w/ skirt - \$310
- K31: Center drawer w/o skirt - \$205

### CONCEALED FLOOR POWER INFEED COVER

- PCEB: White metal finish concealed floor power infeed cover - \$150

### DELETE TOP AND WIRE TRAY

- DHAT: Delete height adjustable top. Deduct \$3265 Veneer(W), \$3095 High Pressure Laminate(G), \$2770 Thermally Fused Laminate(M) per top

### METAL FEET

- MTL10: Replace solid wood feet with metal feet, standard MFW White - \$55 ea

### PREMIUM METAL FINISH

- Specify premium metal finish. MFMB: Matte Black, MFS: Silver, MFSS: Salmon Sienna, MFSA: Surfing Aquavert, MFPS: Pistachio, MFOS: Oyster, MFNA: Navy, MFOL: Olive, MFGB: Grey Beige MFGG: Graphite Gray, MFG: Gray
- Premium metal finish for WMT Wire Management Tray - \$75 ea
- Premium metal finish for MTL10 Metal Feet - \$20 ea
- Premium metal finish for PCEB Concealed Floor Power Infeed Cover - \$35

### STARTER PANEL

- RSP: Substitute round starter panel in place of flat starter panel. Must substitute all starters, priced per starter panel - \$83 each. See HNY3555SP888

### TELECOM PLATES

- Each power unit has 1 plate. All telecom connectors sold separately.
- RJ45 (1) - \$35, RJ45 (2) - \$70, RJ45 (3) - \$105, USB (1) - \$70, USB (2) - \$140, RJ45/USB - \$105, RJ45/HDMI - \$190, HDMI/USB - \$205

1 Select a model w" x d" x h"	PERSON	yardage	Standard Veneer Top Upholstered Panels - COM\$		Premium Veneer Top Upholstered Panels - COM\$		High Pressure Laminate Top Upholstered Panels - COM\$		Thermally Fused Laminate Top Upholstered Panels - COM\$	
602 x 86 x 55	8	128	HNY60286HA576W	69959	"P" Option N/A	HNY60286HA576G	68599	HNY60286HA576M	65999	
528 x 86 x 55	7	112	HNY52886HA576W	61345	"P" Option N/A	HNY52886HA576G	60155	HNY52886HA576M	57880	
453 x 86 x 55	6	97	HNY45386HA576W	52731	"P" Option N/A	HNY45386HA576G	51711	HNY45386HA576M	49761	
378 x 86 x 55	5	81	HNY37886HA576W	44117	"P" Option N/A	HNY37886HA576G	43267	HNY37886HA576M	41642	
303 x 86 x 55	4	66	HNY30386HA576W	35503	"P" Option N/A	HNY30386HA576G	34823	HNY30386HA576M	33523	
228 x 86 x 55	3	50	HNY22886HA576W	26889	"P" Option N/A	HNY22886HA576G	26379	HNY22886HA576M	25404	
153 x 86 x 55	2	35	HNY15386HA576W	18275	"P" Option N/A	HNY15386HA576G	17935	HNY15386HA576M	17285	
78 x 86 x 55	1	19	HNY7886HA576W	9661	"P" Option N/A	HNY7886HA576G	9491	HNY7886HA576M	9166	

2 Select a worksurface finish	WWP	WBW	GEC	LW01	MEC
<a href="#">View finish details</a>	PO01	WSW	GWL	LW02	MOC
<b>Metal finish</b>	PO02	WEC	LP01	LW04	MSW
Height adjustable	PO03	WOW	LP02	LW05	MTW
column standard in	PO04	WNO	LF01	LW06	MWL
MFW White. Optional	PO05	WSO	LF02	LW07	
MFB Black.	PO06		LF03		
	PO07		LN01		
	PO08		LA01		
	PO09		LA02		

3 Select feet finish	WWP	WBW	WWP	WBW	WWP	WBW
<a href="#">View finish details</a>	PO01	WSW	PO01	WSW	PO01	WSW
	PO02	WEC	PO02	WEC	PO02	WEC
	PO03	WOW	PO03	WOW	PO03	WOW
	PO04	WNO	PO04	WNO	PO04	WNO
	PO05	WSO	PO05	WSO	PO05	WSO
	PO06		PO06		PO06	
	PO07		PO07		PO07	
	PO08		PO08		PO08	
	PO09		PO09		PO09	

4 Select a edge	Cliff-1	Cliff-2	Cliff-3	Flat-2	Flat-3	Flat-4
<a href="#">View edge details</a>	Veneer	Black	White	Black	White	Matching
	Flat-1	Flat-2	Flat-3	Flat-1	Flat-2	Flat-3
	Veneer	Black	White	HPL	Black	White

# Honey.

## Inline Hexagon Workstation Typical Position 1 Desk with Fixed Worksurface

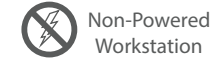
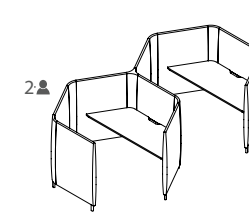
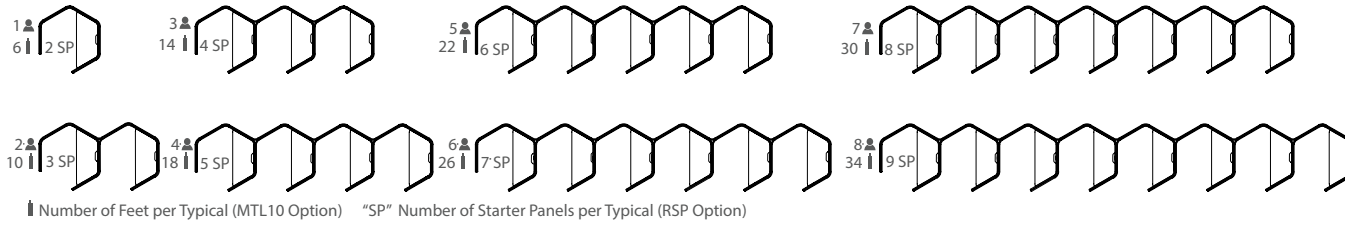

[View statement of line](#)

## Product features.

- 5" Solid wood feet - oval shape
- HNY7227WT162 Fixed Desk Height worksurfaces, 29" worksurface height
- Ships KD

## Options.

### ACCESSORIES

- K28: Articulating Keyboard w/ Mouse - \$390
- K31-SK: Center drawer w/ skirt - \$310
- K31: Center drawer w/o skirt - \$205

### CONCEALED FLOOR POWER INFEEED COVER

- PCEB: White metal finish concealed floor power infeed cover - \$150

### DELETE TOP

- DFT: Delete fixed top. Deduct \$1125 Veneer(W), \$955 High Pressure Laminate (G), \$630 Thermally Fused Laminate (M) per top

### METAL FEET

- MTL10: Replace soild wood feet with metal feet, standard MFW White - \$55 ea

### PREMIUM METAL FINISH

- Specify premium metal finish. MFMB: Matte Black, MFS: Silver, MFSS: Salmon Sienna, MFSA: Surfin Aquavert, MFPS: Pistachio, MFOS: Oyster, MFNA: Navy, MFOL: Olive, MFGB: Grey Beige MFGG: Graphite Gray, MFG: Gray
- Premium metal finish for WMT Wire Management Tray - \$75 ea
- Premium metal finish for MTL10 Metal Feet - \$20 ea
- Premium metal finish for PCEB Concealed Floor Power Infeed Cover - \$35

### STARTER PANEL

- RSP: Substitute round starter panel in place of flat starter panel. Must substitute all starters, priced per starter panel - \$83 each. See HNY3555SP888

### WORKSURFACE HEIGHT

- Modify worksurface height to bar height.
- THL42: Position worksurface at bar height - N/C

### WIRE TRAY

- WMT: Wire metal tray. Mounts under top and comes standard in MFW White - \$210

1 Select a model w" x d" x h"	PERSON	yardage	Standard Veneer Top Upholstered Panels - COM\$		Premium Veneer Top Upholstered Panels - COM\$		High Pressure Laminate Top Upholstered Panels - COM\$		Thermally Fused Laminate Top Upholstered Panels - COM\$	
602 x 86 x 55	8	128	HNY60286FT576W	49065	"P" Option N/A	HNY60286FT576G	47705	HNY60286FT576M	45105	
528 x 86 x 55	7	112	HNY52886FT576W	43079	"P" Option N/A	HNY52886FT576G	41889	HNY52886FT576M	39614	
453 x 86 x 55	6	97	HNY45386FT576W	37093	"P" Option N/A	HNY45386FT576G	36073	HNY45386FT576M	34123	
378 x 86 x 55	5	81	HNY37886FT576W	31107	"P" Option N/A	HNY37886FT576G	30257	HNY37886FT576M	28632	
303 x 86 x 55	4	66	HNY30386FT576W	25121	"P" Option N/A	HNY30386FT576G	24441	HNY30386FT576M	23141	
228 x 86 x 55	3	50	HNY22886FT576W	19135	"P" Option N/A	HNY22886FT576G	18625	HNY22886FT576M	17650	
153 x 86 x 55	2	35	HNY15386FT576W	13485	"P" Option N/A	HNY15386FT576G	13145	HNY15386FT576M	12495	
78 x 86 x 55	1	19	HNY7886FT576W	7163	"P" Option N/A	HNY7886FT576G	6993	HNY7886FT576M	6668	

2 Select a worksurface finish <a href="#">View finish details</a>								
WWP	WBW	GEC	LW01	MEC				
PO01	WSW	GWL	LW02	MOC				
PO02	WEC	LP01	LW04	MSW				
PO03	WOW	LP02	LW05	MTW				
PO04	WNO	LF01	LW06	MWL				
PO05	WSO	LF02	LW07					
PO06		LF03						
PO07		LN01						
PO08		LA01						
PO09		LA02						

3 Select feet finish <a href="#">View finish details</a>								
WWP	WBW	WWP	WBW	WWP	WBW			
PO01	WSW	PO01	WSW	PO01	WSW			
PO02	WEC	PO02	WEC	PO02	WEC			
PO03	WOW	PO03	WOW	PO03	WOW			
PO04	WNO	PO04	WNO	PO04	WNO			
PO05	WSO	PO05	WSO	PO05	WSO			
PO06		PO06		PO06				
PO07		PO07		PO07				
PO08		PO08		PO08				
PO09		PO09		PO09				

4 Select a edge <a href="#">View edge details</a>						
Cliff-1 Veneer	Cliff-2 Black	Cliff-3 White	Cliff-1 HPL	Cliff-2 Black	Cliff-3 White	Flat-2 Black
Flat-1 Veneer	Flat-2 Black	Flat-3 White	Flat-1 HPL	Flat-2 Black	Flat-3 White	Flat-4 Matching

# Honey.

## Inline Hexagon Workstation Typical Position 1 Desk with Power Fixed Worksurface

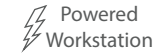
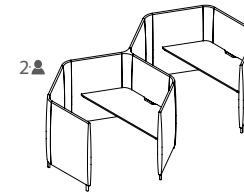
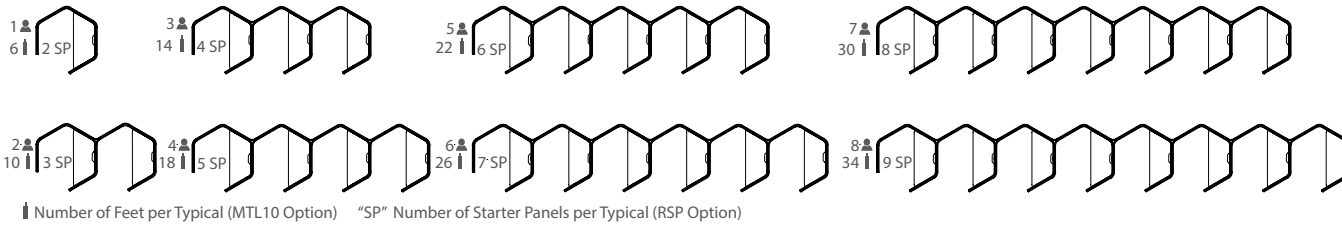

[View statement of line](#)

## Product features.

- HNY7227WT162 Fixed Desk Height worksurfaces, 29" worksurface height
- 5" Solid wood feet - oval shape
- 4 Power outlets with 1 telecom plate, see options below for telecom plate
- Ships KD
- Wire management tray attaches to worksurface top, standard in MFW White, see premium metal finish for options
- Hardwire infeed and jumpers are included in workstations

## Options.

### ACCESSORIES

- K28: Articulating Keyboard w/ Mouse - \$390
- K31-SK: Center drawer w/ skirt - \$310
- K31: Center drawer w/o skirt - \$205

### CONCEALED FLOOR POWER INFEEED COVER

- PCEB: White metal finish concealed floor power infeed cover - \$150

### DELETE TOP AND WIRE TRAY

- DFP: Delete fixed top. Deduct \$1335 Veneer (W), \$1165 High Pressure Laminate (G), \$840 Thermally Fused Laminate (M) per top

### METAL FEET

- MTL10: Replace solid wood feet with metal feet, standard MFW White - \$55 ea

### PREMIUM METAL FINISH

- Specify premium metal finish. MFMB: Matte Black, MFS: Silver, MFSS: Salmon Sienna, MFSA: Surfin Aquavert, MFPS: Pistachio, MFOS: Oyster, MFNA: Navy, MFOL: Olive, MFGB: Grey Beige MFGG: Graphite Gray, MFG: Gray
- Premium metal finish for WMT Wire Management Tray - \$75 ea
- Premium metal finish for MTL10 Metal Feet - \$20 ea
- Premium metal finish for PCEB Concealed Floor Power Infeed Cover - \$35

### STARTER PANEL

- RSP: Substitute round starter panel in place of flat starter panel. Must substitute all starters, priced per starter panel - \$83 each. See HNY3555SP888

### TELECOM PLATES

- Each power unit has 1 plate. All telecom connectors sold separately.
- RJ45 (1) - \$35, RJ45 (2) - \$70, RJ45 (3) - \$105, USB (1) - \$70, USB (2) - \$140, RJ45/USB - \$105, RJ45/HDMI - \$190, HDMI/USB - \$205

### WORKSURFACE HEIGHT

- THL42: Modify worksurface height to bar height - N/C

1 Select a model w" x d" x h"	PERSON	yardage	Standard Veneer Top Upholstered Panels - COM\$		Premium Veneer Top Upholstered Panels - COM\$		High Pressure Laminate Top Upholstered Panels - COM\$		Thermally Fused Laminate Top Upholstered Panels - COM\$	
602 x 86 x 55	8	128	HNY60286FP576W	54519	"P" Option N/A	HNY60286FP576G	53159	HNY60286FP576M	50559	
528 x 86 x 55	7	112	HNY52886FP576W	47835	"P" Option N/A	HNY52886FP576G	46645	HNY52886FP576M	44370	
453 x 86 x 55	6	97	HNY45386FP576W	41151	"P" Option N/A	HNY45386FP576G	40131	HNY45386FP576M	38181	
378 x 86 x 55	5	81	HNY37886FP576W	34467	"P" Option N/A	HNY37886FP576G	33617	HNY37886FP576M	31992	
303 x 86 x 55	4	66	HNY30386FP576W	27783	"P" Option N/A	HNY30386FP576G	27103	HNY30386FP576M	25803	
228 x 86 x 55	3	50	HNY22886FP576W	21099	"P" Option N/A	HNY22886FP576G	20589	HNY22886FP576M	19614	
153 x 86 x 55	2	35	HNY15386FP576W	14415	"P" Option N/A	HNY15386FP576G	14075	HNY15386FP576M	13425	
78 x 86 x 55	1	19	HNY7886FP576W	7731	"P" Option N/A	HNY7886FP576G	7561	HNY7886FP576M	7236	

2 Select a worksurface finish									
WWP	WBW								
PO01	WSW								
PO02	WEC								
PO03	WOW								
PO04	WNO								
PO05	WSO								
PO06									
PO07									
PO08									
PO09									

3 Select feet finish									
WWP	WBW								
PO01	WSW								
PO02	WEC								
PO03	WOW								
PO04	WNO								
PO05	WSO								
PO06									
PO07									
PO08									
PO09									

4 Select an edge									
Cliff-1 Veneer	Cliff-2 Black	Cliff-3 White							
Flat-1 Veneer	Flat-2 Black	Flat-3 White							

# Honey.

Inline Hexagon Workstation Typical  
Position 2 Desk with Height Adjustable Worksurface

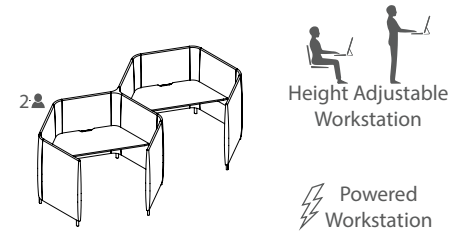
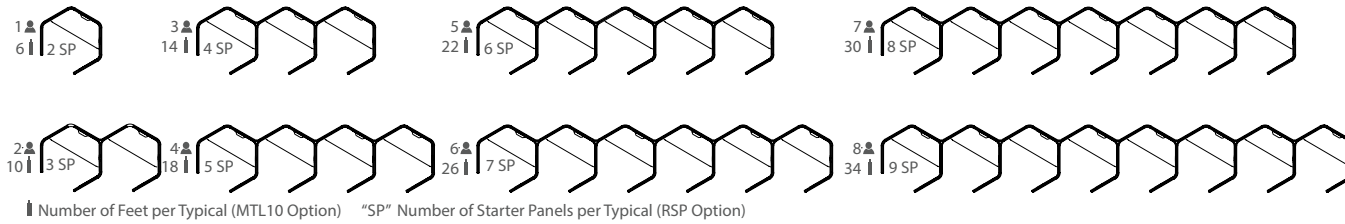

[View statement of line](#)

## Product features.

- 5" Solid wood feet - oval shape, ships KD
- 4 Power outlets with 1 telecom plate, see options below for telecom plate
- Adjustable height from 27" to 47.5" with a maximum weight capacity of 275 lbs. Lift standard in MFW White, optional MFB Black
- HNY7227WT163 Height Adjustable worksurfaces are included
- Wire management tray attaches to worksurface top, standard in MFW White, see premium metal finish for options

### NOTES

- 1" Gap between worksurface and panels to drop wires below worksurface
- Metal parts include 5 year warranty
- Programmable height adjustable mechanism, motor includes 2 year warranty

## Options.

### ACCESSORIES

- K28: Articulating Keyboard w/ Mouse - \$390
- K31-SK: Center drawer w/ skirt - \$310
- K31: Center drawer w/o skirt - \$205

### CONCEALED FLOOR POWER INFEED COVER

- PCEB: White metal finish concealed floor power infeed cover - \$150

### DELETE TOP AND WIRE TRAY

- DHAT: Delete height adjustable top. Deduct \$3265 Veneer(W), \$3095 High Pressure Laminate(G), \$2770 Thermally Fused Laminate(M) per top

### METAL FEET

- MTL10: Replace solid wood feet with metal feet, standard MFW White - \$55 ea

### PREMIUM METAL FINISH

- Specify premium metal finish. MFMB: Matte Black, MFS: Silver, MFSS: Salmon Sienna, MFSA: Surfing Aquavert, MFPS: Pistachio, MFOS: Oyster, MFNA: Navy, MFOL: Olive, MFGB: Grey Beige MFGG: Graphite Gray, MFG: Gray
- Premium metal finish for WMT Wire Management Tray - \$75 ea
- Premium metal finish for MTL10 Metal Feet - \$20 ea
- Premium metal finish for PCEB Concealed Floor Power Infeed Cover - \$35

### STARTER PANEL

- RSP: Substitute round starter panel in place of flat starter panel. Must substitute all starters, priced per starter panel - \$83 each. See HNY3555SP888

### TELECOM PLATES

- Each power unit has 1 plate. All telecom connectors sold separately.
- RJ45 (1) - \$35, RJ45 (2) - \$70, RJ45 (3) - \$105, USB (1) - \$70, USB (2) - \$140, RJ45/USB - \$105, RJ45/HDMI - \$190, HDMI/USB - \$205

1 Select a model w" x d" x h"	PERSON	yardage	Standard Veneer Top		Premium Veneer Top		High Pressure Laminate Top		Thermally Fused Laminate Top	
			Upholstered Panels - COM\$		Upholstered Panels - COM\$		Upholstered Panels - COM\$		Upholstered Panels - COM\$	
602 x 86 x 55	8	128	HNY60286HA577W	69309	"P" Option N/A	HNY60286HA577G	67949	HNY60286HA577M	65349	
528 x 86 x 55	7	112	HNY52886HA577W	60795	"P" Option N/A	HNY52886HA577G	59605	HNY52886HA577M	57330	
453 x 86 x 55	6	97	HNY45386HA577W	52281	"P" Option N/A	HNY45386HA577G	51261	HNY45386HA577M	49311	
378 x 86 x 55	5	81	HNY37886HA577W	43767	"P" Option N/A	HNY37886HA577G	42917	HNY37886HA577M	41292	
303 x 86 x 55	4	66	HNY30386HA577W	35253	"P" Option N/A	HNY30386HA577G	34573	HNY30386HA577M	33273	
228 x 86 x 55	3	50	HNY22886HA577W	26739	"P" Option N/A	HNY22886HA577G	26229	HNY22886HA577M	25254	
153 x 86 x 55	2	35	HNY15386HA577W	18225	"P" Option N/A	HNY15386HA577G	17885	HNY15386HA577M	17235	
78 x 86 x 55	1	19	HNY7886HA577W	9711	"P" Option N/A	HNY7886HA577G	9541	HNY7886HA577M	9216	

2 Select a worksurface finish <a href="#">View finish details</a>	Metal finish		GEC	LW01	MEC
	WWP	WBW			
Height adjustable column standard in MFW White. Optional MFB Black.	PO01	WSW	GWL	LW02	MOC
	PO02	WEC	LP01	LW04	MSW
	PO03	WOW	LP02	LW05	MTW
	PO04	WNO	LF01	LW06	MWL
	PO05	WSO	LF02	LW07	
	PO06		LF03		
	PO07		LN01		
	PO08		LA01		
	PO09		LA02		

3 Select feet finish <a href="#">View finish details</a>	Metal finish		WWP	WBW	WWP	WBW
	PO01	WSW				
	PO02	WEC	PO02	WEC	PO02	WEC
	PO03	WOW	PO03	WOW	PO03	WOW
	PO04	WNO	PO04	WNO	PO04	WNO
	PO05	WSO	PO05	WSO	PO05	WSO
	PO06		PO06		PO06	
	PO07		PO07		PO07	
	PO08		PO08		PO08	
	PO09		PO09		PO09	

4 Select an edge <a href="#">View edge details</a>	Cliff			Flat							
	Cliff-1 Veneer	Cliff-2 Black	Cliff-3 White	Flat-1 Veneer	Flat-2 Black	Flat-3 White					
Cliff-1 Veneer	Cliff-2 Black	Cliff-3 White	Flat-1 Veneer	Flat-2 Black	Flat-3 White	HPL	Cliff-1 Black	Cliff-2 White	Flat-2 Black	Flat-3 White	Matching

# Honey.

## Inline Hexagon Workstation Typical Position 2 Desk with Fixed Worksurface

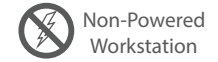
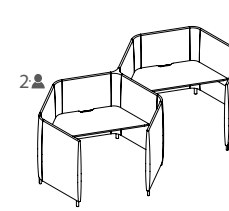
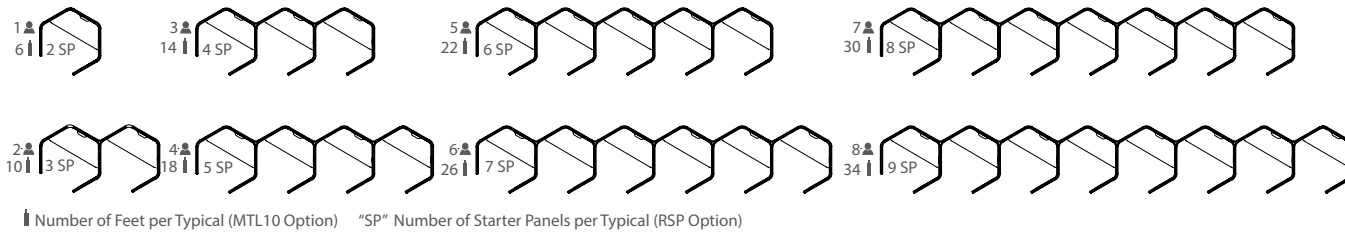

[View statement of line](#)

### Product features.

- 5" Solid wood feet - oval shape
- HNY7227WT162 Fixed Desk Height worksurfaces, 29" worksurface height
- Ships KD

### Options.

#### ACCESSORIES

- K28: Articulating Keyboard w/ Mouse - \$390
- K31-SK: Center drawer w/ skirt - \$310
- K31: Center drawer w/o skirt - \$205

#### CONCEALED FLOOR POWER INFEED COVER

- PCEB: White metal finish concealed floor power infeed cover - \$150

#### DELETE TOP

- DFT: Delete fixed top. Deduct \$1125 Veneer(W), \$955 High Pressure Laminate (G), \$630 Thermally Fused Laminate (M) per top

#### METAL FEET

- MTL10: Replace solid wood feet with metal feet, standard MFW White - \$55 ea

#### PREMIUM METAL FINISH

- Specify premium metal finish. MFMB: Matte Black, MFS: Silver, MFSS: Salmon Sienna, MFSA: Surfin Aquavert, MFPS: Pistachio, MFOS: Oyster, MFNA: Navy, MFOL: Olive, MFGB: Grey Beige MFGG: Graphite Gray, MFG: Gray
- Premium metal finish for WMT Wire Management Tray - \$75 ea
- Premium metal finish for MTL10 Metal Feet - \$20 ea
- Premium metal finish for PCEB Concealed Floor Power Infeed Cover - \$35

#### STARTER PANEL

- RSP: Substitute round starter panel in place of flat starter panel. Must substitute all starters, priced per starter panel - \$83 each. See HNY3555SP888

#### WORKSURFACE HEIGHT

- Modify worksurface height to bar height.
- THL-42: Position worksurface at bar height - N/C

#### WIRE TRAY

- WMT: Wire metal tray. Mounts under top and comes standard in MFW White - \$210

1 Select a model w" x d" x h"	PERSON	yardage	Standard Veneer Top		Premium Veneer Top		High Pressure Laminate Top		Thermally Fused Laminate Top	
			Upholstered Panels - COM\$		Upholstered Panels - COM\$		Upholstered Panels - COM\$		Upholstered Panels - COM\$	
602 x 86 x 55	8	128	HNY60286FT577W	49065	"P" Option N/A	HNY60286FT577G	47705	HNY60286FT577M	45105	
528 x 86 x 55	7	112	HNY52886FT577W	43079	"P" Option N/A	HNY52886FT577G	41889	HNY52886FT577M	39614	
453 x 86 x 55	6	97	HNY45386FT577W	37093	"P" Option N/A	HNY45386FT577G	36073	HNY45386FT577M	34123	
378 x 86 x 55	5	81	HNY37886FT577W	31107	"P" Option N/A	HNY37886FT577G	30257	HNY37886FT577M	28632	
303 x 86 x 55	4	66	HNY30386FT577W	25121	"P" Option N/A	HNY30386FT577G	24441	HNY30386FT577M	23141	
228 x 86 x 55	3	50	HNY22886FT577W	19135	"P" Option N/A	HNY22886FT577G	18625	HNY22886FT577M	17650	
153 x 86 x 55	2	35	HNY15386FT577W	13149	"P" Option N/A	HNY15386FT577G	12809	HNY15386FT577M	12159	
78 x 86 x 55	1	19	HNY7886FT577W	7163	"P" Option N/A	HNY7886FT577G	6993	HNY7886FT577M	6668	

2 Select a worksurface finish <a href="#">View finish details</a>	WWP	WBW	GEC	LW01	MEC
PO01	WSW	WSW	GWL	LW02	MOC
PO02	WEC	WEC	LP01	LW04	MSW
PO03	WOW	WOW	LP02	LW05	MTW
PO04	WNO	WNO	LF01	LW06	MWL
PO05	WSO	WSO	LF02	LW07	
PO06			LF03		
PO07			LN01		
PO08			LA01		
PO09			LA02		

3 Select feet finish <a href="#">View finish details</a>	WWP	WBW	WWP	WBW	WWP	WBW
PO01	WSW	WSW	PO01	WSW	PO01	WSW
PO02	WEC	WEC	PO02	WEC	PO02	WEC
PO03	WOW	WOW	PO03	WOW	PO03	WOW
PO04	WNO	WNO	PO04	WNO	PO04	WNO
PO05	WSO	WSO	PO05	WSO	PO05	WSO
PO06			PO06		PO06	
PO07			PO07		PO07	
PO08			PO08		PO08	
PO09			PO09		PO09	

4 Select a edge <a href="#">View edge details</a>	Cliff-1 Veneer	Cliff-2 Black	Cliff-3 White	Cliff-1 HPL	Cliff-2 Black	Cliff-3 White	Flat-2 Black	Flat-3 White	Flat-4 Matching	Flat-1 Veneer	Flat-2 Black	Flat-3 White

# Honey.

## Inline Hexagon Workstation Typical Position 2 Desk with Power Fixed Worksurface

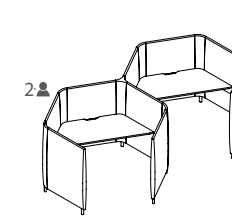
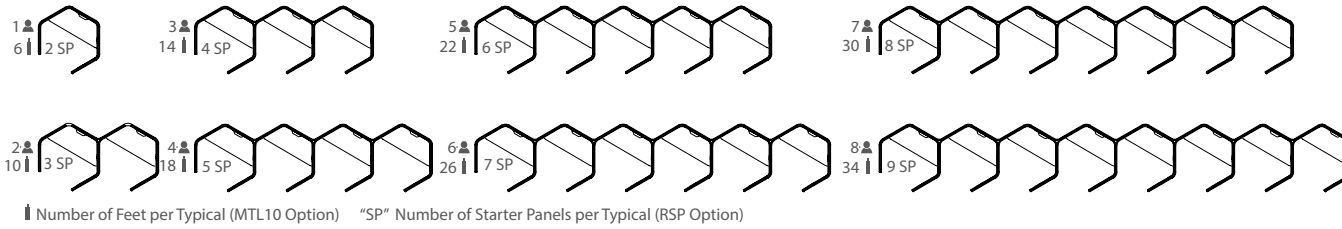

[View statement of line](#)

## Product features.

- HNY7227WT162 Fixed Desk Height worksurfaces, 29" worksurface height
- 5" Solid wood feet - oval shape
- 4 Power outlets with 1 telecom plate, see options below for telecom plate
- Ships KD
- Wire management tray attaches to worksurface top, standard in MFW White, see premium metal finish for options
- Hardwire infeed and jumpers are included in workstations

## Options.

### ACCESSORIES

- K28: Articulating Keyboard w/ Mouse - \$390
- K31-SK: Center drawer w/ skirt - \$310
- K31: Center drawer w/o skirt - \$205

### CONCEALED FLOOR POWER INFEED COVER

- PCEB: White metal finish concealed floor power infeed cover - \$150

### DELETE TOP AND WIRE TRAY

- DFP: Delete fixed top. Deduct \$1335 Veneer (W), \$1165 High Pressure Laminate (G), \$840 Thermally Fused Laminate (M) per top

### METAL FEET

- MTL10: Replace solid wood feet with metal feet, standard MFW White - \$55 ea

### PREMIUM METAL FINISH

- Specify premium metal finish. MFMB: Matte Black, MFS: Silver, MFSS: Salmon Sienna, MFSA: Surfin Aquavert, MFPS: Pistachio, MFOS: Oyster, MFNA: Navy, MFOL: Olive, MFGB: Grey Beige MFGG: Graphite Gray, MFG: Gray
- Premium metal finish for WMT Wire Management Tray - \$75 ea
- Premium metal finish for MTL10 Metal Feet - \$20 ea
- Premium metal finish for PCEB Concealed Floor Power Infeed Cover - \$35

### STARTER PANEL

- RSP: Substitute round starter panel in place of flat starter panel. Must substitute all starters, priced per starter panel - \$83 each. See HNY3555SP888

### TELECOM PLATES

- Each power unit has 1 plate. All telecom connectors sold separately.
- RJ45 (1) - \$35, RJ45 (2) - \$70, RJ45 (3) - \$105, USB (1) - \$70, USB (2) - \$140, RJ45/USB - \$105, RJ45/HDMI - \$190, HDMI/USB - \$205

### WORKSURFACE HEIGHT

- THL42: Modify worksurface height to bar height - N/C

1 Select a model w" x d" x h"	PERSON U	yardage SP	Standard Veneer Top Upholstered Panels - COM\$		Premium Veneer Top Upholstered Panels - COM\$		High Pressure Laminate Top Upholstered Panels - COM\$		Thermally Fused Laminate Top Upholstered Panels - COM\$	
602 x 86 x 55	8	128	HNY60286FP577W	53869	"P" Option N/A	HNY60286FP577G	52509	HNY60286FP577M	49909	
528 x 86 x 55	7	112	HNY52886FP577W	47285	"P" Option N/A	HNY52886FP577G	46095	HNY52886FP577M	43820	
453 x 86 x 55	6	97	HNY45386FP577W	40701	"P" Option N/A	HNY45386FP577G	39681	HNY45386FP577M	37731	
378 x 86 x 55	5	81	HNY37886FP577W	34117	"P" Option N/A	HNY37886FP577G	33267	HNY37886FP577M	31642	
303 x 86 x 55	4	66	HNY30386FP577W	27533	"P" Option N/A	HNY30386FP577G	26853	HNY30386FP577M	25553	
228 x 86 x 55	3	50	HNY22886FP577W	20949	"P" Option N/A	HNY22886FP577G	20439	HNY22886FP577M	19464	
153 x 86 x 55	2	35	HNY15386FP577W	14365	"P" Option N/A	HNY15386FP577G	14025	HNY15386FP577M	13375	
78 x 86 x 55	1	19	HNY7886FP577W	7781	"P" Option N/A	HNY7886FP577G	7611	HNY7886FP577M	7286	

2 Select a worksurface finish	WWP	WBW	GEC	LW01	MEC
<a href="#">View finish details</a>	PO01	WSW	GWL	LW02	MOC
Wire Tray Metal finish Standard in MFW White. See premium finishes for options.	PO02	WEC	LP01	LW04	MSW
	PO03	WOW	LP02	LW05	MTW
	PO04	WNO	LF01	LW06	MWL
	PO05	WSO	LF02	LW07	
	PO06		LF03		
	PO07		LN01		
	PO08		LA01		
	PO09		LA02		

3 Select feet finish	WWP	WBW	WWP	WBW	WWP	WBW
<a href="#">View finish details</a>	PO01	WSW	PO01	WSW	PO01	WSW
	PO02	WEC	PO02	WEC	PO02	WEC
	PO03	WOW	PO03	WOW	PO03	WOW
	PO04	WNO	PO04	WNO	PO04	WNO
	PO05	WSO	PO05	WSO	PO05	WSO
	PO06		PO06		PO06	
	PO07		PO07		PO07	
	PO08		PO08		PO08	
	PO09		PO09		PO09	

  

4 Select a edge	Cliff-1 Veneer	Cliff-2 Black	Cliff-3 White	Flat-1 Veneer	Flat-2 Black	Flat-3 White
<a href="#">View edge details</a>						



# Honey.

Inline Hexagon Workstation Typical  
Position 3 with Height Adjustable Worksurface

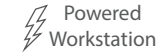
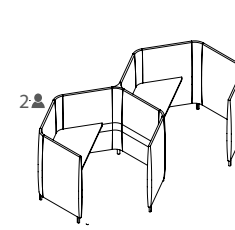
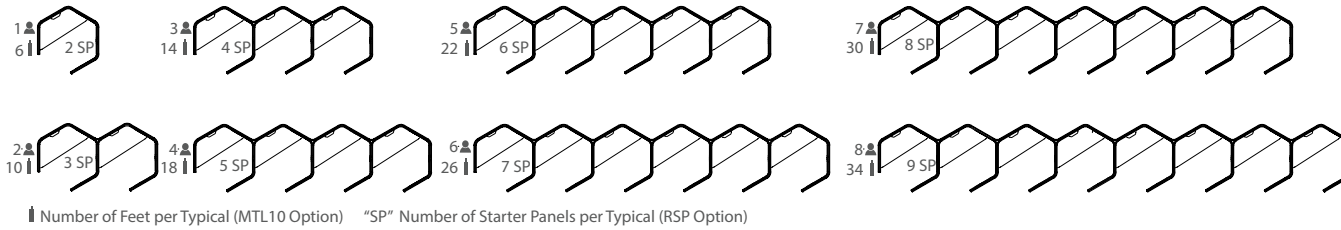

[View statement of line](#)

## Product features.

- 5" Solid wood feet - oval shape, ships KD
- 4 Power outlets with 1 telecom plate, see options below for telecom plate
- Adjustable height from 27" to 47.5" with a maximum weight capacity of 275 lbs. Lift standard in MFW White, optional MFB Black
- HNY7227WT163 Height Adjustable worksurfaces are included
- Wire management tray attaches to worksurface top, standard in MFW White, see premium metal finish for options

### NOTES

- 1" Gap between worksurface and panels to drop wires below worksurface
- Metal parts include 5 year warranty
- Programmable height adjustable mechanism, motor includes 2 year warranty

## Options.

### ACCESSORIES

- K28: Articulating Keyboard w/ Mouse - \$390
- K31-SK: Center drawer w/ skirt - \$310
- K31: Center drawer w/o skirt - \$205

### CONCEALED FLOOR POWER INFEED COVER

- PCEB: White metal finish concealed floor power infeed cover - \$150

### DELETE TOP AND WIRE TRAY

- DHAT: Delete height adjustable top. Deduct \$3265 Veneer(W), \$3095 High Pressure Laminate(G), \$2770 Thermally Fused Laminate(M) per top

### METAL FEET

- MTL10: Replace solid wood feet with metal feet, standard MFW White - \$55 ea

### PREMIUM METAL FINISH

- Specify premium metal finish. MFMB: Matte Black, MFS: Silver, MFSS: Salmon Sienna, MFSA: Surfing Aquavert, MFPS: Pistachio, MFOS: Oyster, MFNA: Navy, MFOL: Olive, MFGB: Grey Beige MFGG: Graphite Gray, MFG: Gray
- Premium metal finish for WMT Wire Management Tray - \$75 ea
- Premium metal finish for MTL10 Metal Feet - \$20 ea
- Premium metal finish for PCEB Concealed Floor Power Infeed Cover - \$35

### STARTER PANEL

- RSP: Substitute round starter panel in place of flat starter panel. Must substitute all starters, priced per starter panel - \$83 each. See HNY3555SP888

### TELECOM PLATES

- Each power unit has 1 plate. All telecom connectors sold separately.
- RJ45 (1) - \$35, RJ45 (2) - \$70, RJ45 (3) - \$105, USB (1) - \$70, USB (2) - \$140, RJ45/USB - \$105, RJ45/HDMI - \$190, HDMI/USB - \$205

1 Select a model w" x d" x h"	PERSON	yardage	Standard Veneer Top Upholstered Panels - COM\$		Premium Veneer Top Upholstered Panels - COM\$		High Pressure Laminate Top Upholstered Panels - COM\$		Thermally Fused Laminate Top Upholstered Panels - COM\$	
602 x 86 x 55	8	128	HNY60286HA578W	69359	"P" Option N/A	HNY60286HA578G	67999	HNY60286HA578M	65399	
528 x 86 x 55	7	112	HNY52886HA578W	60845	"P" Option N/A	HNY52886HA578G	59655	HNY52886HA578M	57380	
453 x 86 x 55	6	97	HNY45386HA578W	52331	"P" Option N/A	HNY45386HA578G	51311	HNY45386HA578M	49361	
378 x 86 x 55	5	81	HNY37886HA578W	43817	"P" Option N/A	HNY37886HA578G	42967	HNY37886HA578M	41342	
303 x 86 x 55	4	66	HNY30386HA578W	35303	"P" Option N/A	HNY30386HA578G	34623	HNY30386HA578M	33323	
228 x 86 x 55	3	50	HNY22886HA578W	26789	"P" Option N/A	HNY22886HA578G	26279	HNY22886HA578M	25304	
153 x 86 x 55	2	35	HNY15386HA578W	18275	"P" Option N/A	HNY15386HA578G	17935	HNY15386HA578M	17285	
78 x 86 x 55	1	19	HNY7886HA578W	9761	"P" Option N/A	HNY7886HA578G	9591	HNY7886HA578M	9266	

2 Select a worksurface finish	WWP	WBW	GEC	LW01	MEC
<a href="#">View finish details</a>	PO01	WSW	GWL	LW02	MOC
<b>Metal finish</b>	PO02	WEC	LP01	LW04	MSW
Height adjustable	PO03	WOW	LP02	LW05	MTW
column standard in	PO04	WNO	LF01	LW06	MWL
MFW White. Optional	PO05	WSO	LF02	LW07	
MFB Black.	PO06		LF03		
	PO07		LN01		
	PO08		LA01		
	PO09		LA02		

3 Select feet finish	WWP	WBW	WWP	WBW	WWP	WBW
<a href="#">View finish details</a>	PO01	WSW	PO01	WSW	PO01	WSW
	PO02	WEC	PO02	WEC	PO02	WEC
	PO03	WOW	PO03	WOW	PO03	WOW
	PO04	WNO	PO04	WNO	PO04	WNO
	PO05	WSO	PO05	WSO	PO05	WSO
	PO06		PO06		PO06	
	PO07		PO07		PO07	
	PO08		PO08		PO08	
	PO09		PO09		PO09	

4 Select a edge	Cliff-1	Cliff-2	Cliff-3	Flat-2	Flat-3	Flat-4
<a href="#">View edge details</a>	Veneer	Black	White	Black	White	Matching
	Flat-1	Flat-2	Flat-3	Flat-1	Flat-2	Flat-3
	Veneer	Black	White	HPL	Black	White

# Honey.

## Inline Hexagon Workstation Typical Position 3 Desk with Fixed Worksurface

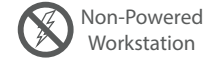
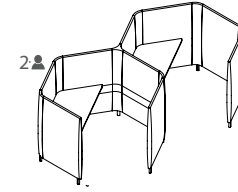
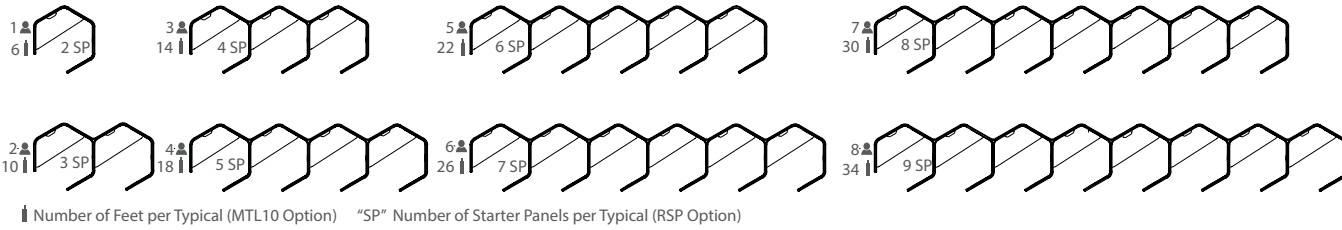

[View statement of line](#)

### Product features.

- 5" Solid wood feet - oval shape
- HNY7227WT162 Fixed Desk Height worksurfaces, 29" worksurface height
- Ships KD

### Options.

#### ACCESSORIES

- K28: Articulating Keyboard w/ Mouse - \$390
- K31-SK: Center drawer w/ skirt - \$310
- K31: Center drawer w/o skirt - \$205

#### CONCEALED FLOOR POWER INFEED COVER

- PCEB: White metal finish concealed floor power infeed cover - \$150

#### DELETE TOP

- DFT: Delete fixed top. Deduct \$1125 Veneer(W), \$955 High Pressure Laminate (G), \$630 Thermally Fused Laminate (M) per top

#### METAL FEET

- MTL10: Replace solid wood feet with metal feet, standard MFW White - \$55 ea

#### PREMIUM METAL FINISH

- Specify premium metal finish. MFMB: Matte Black, MFS: Silver, MFSS: Salmon Sienna, MFSA: Surfing Aquavert, MFPS: Pistachio, MFOS: Oyster, MFNA: Navy, MFOL: Olive, MFGB: Grey Beige MFGG: Graphite Gray, MFG: Gray
- Premium metal finish for WMT Wire Management Tray - \$75 ea
- Premium metal finish for MTL10 Metal Feet - \$20 ea
- Premium metal finish for PCEB Concealed Floor Power Infeed Cover - \$35

#### STARTER PANEL

- RSP: Substitute round starter panel in place of flat starter panel. Must substitute all starters, priced per starter panel - \$83 each. See HNY3555SP888

#### WORKSURFACE HEIGHT

- Modify worksurface height to bar height.
- THL-42: Position worksurface at bar height - N/C

#### WIRE TRAY

- WMT: Wire metal tray. Mounts under top and comes standard in MFW White - \$210

1 Select a model w" x d" x h"	PERSON	yardage	Standard Veneer Top		Premium Veneer Top		High Pressure Laminate Top		Thermally Fused Laminate Top	
			Upholstered Panels - COM\$		Upholstered Panels - COM\$		Upholstered Panels - COM\$		Upholstered Panels - COM\$	
602 x 86 x 55	8	128	HNY60286FT578W	49065	"P" Option N/A	HNY60286FT578G	47705	HNY60286FT578M	45105	
528 x 86 x 55	7	112	HNY52886FT578W	43079	"P" Option N/A	HNY52886FT578G	41889	HNY52886FT578M	39614	
453 x 86 x 55	6	97	HNY45386FT578W	37093	"P" Option N/A	HNY45386FT578G	36073	HNY45386FT578M	34123	
378 x 86 x 55	5	81	HNY37886FT578W	31107	"P" Option N/A	HNY37886FT578G	30257	HNY37886FT578M	28632	
303 x 86 x 55	4	66	HNY30386FT578W	25121	"P" Option N/A	HNY30386FT578G	24441	HNY30386FT578M	23141	
228 x 86 x 55	3	50	HNY22886FT578W	19135	"P" Option N/A	HNY22886FT578G	18625	HNY22886FT578M	17650	
153 x 86 x 55	2	35	HNY15386FT578W	13149	"P" Option N/A	HNY15386FT578G	12809	HNY15386FT578M	12159	
78 x 86 x 55	1	19	HNY7886FT578W	7163	"P" Option N/A	HNY7886FT578G	6993	HNY7886FT578M	6668	

2 Select a worksurface finish <a href="#">View finish details</a>	WWP	WBW	GEC	LW01	MEC
PO01	WSW	WSW	GWL	LW02	MOC
PO02	WEC	WEC	LP01	LW04	MSW
PO03	WOW	WOW	LP02	LW05	MTW
PO04	WNO	WNO	LF01	LW06	MWL
PO05	WSO	WSO	LF02	LW07	
PO06			LF03		
PO07			LN01		
PO08			LA01		
PO09			LA02		

3 Select feet finish <a href="#">View finish details</a>	WWP	WBW	WWP	WBW	WWP	WBW
PO01	WSW	WSW	PO01	WSW	PO01	WSW
PO02	WEC	WEC	PO02	WEC	PO02	WEC
PO03	WOW	WOW	PO03	WOW	PO03	WOW
PO04	WNO	WNO	PO04	WNO	PO04	WNO
PO05	WSO	WSO	PO05	WSO	PO05	WSO
PO06			PO06		PO06	
PO07			PO07		PO07	
PO08			PO08		PO08	
PO09			PO09		PO09	

4 Select a edge <a href="#">View edge details</a>	Cliff-1 Veneer	Cliff-2 Black	Cliff-3 White	Cliff-1 HPL	Cliff-2 Black	Cliff-3 White	Flat-2 Black	Flat-3 White	Flat-4 Matching	Flat-1 Veneer	Flat-2 Black	Flat-3 White

# Honey.

## Inline Hexagon Workstation Typical Position 3 Desk with Power Fixed Worksurface

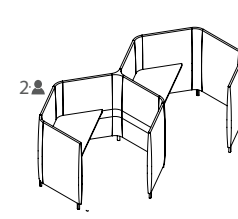
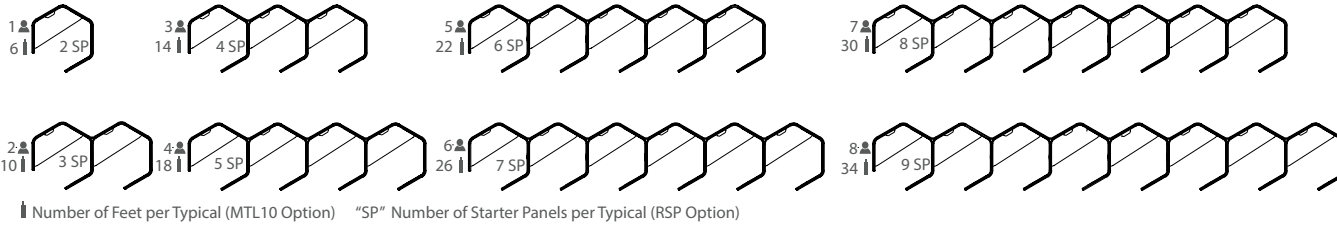

### View statement of line Product features.

- HNY7227WT162 Fixed Desk Height worksurfaces, 29" worksurface height
- 5" Solid wood feet - oval shape
- 4 Power outlets with 1 telecom plate, see options below for telecom plate
- Ships KD
- Wire management tray attaches to worksurface top, standard in MFW White, see premium metal finish for options
- Hardwire infeed and jumpers are included in workstations

### Options.

- ACCESSORIES**
- K28: Articulating Keyboard w/ Mouse - \$390
  - K31-SK: Center drawer w/ skirt - \$310
  - K31: Center drawer w/o skirt - \$205
- CONCEALED FLOOR POWER INFEEED COVER**
- PCEB: White metal finish concealed floor power infeed cover - \$150
- DELETE TOP AND WIRE TRAY**
- DFP: Delete fixed top. Deduct \$1335 Veneer (W), \$1165 High Pressure Laminate (G), \$840 Thermally Fused Laminate (M) per top
- METAL FEET**
- MTL10: Replace solid wood feet with metal feet, standard MFW White - \$55 ea
- PREMIUM METAL FINISH**
- Specify premium metal finish. MFMB: Matte Black, MFS: Silver, MFSS: Salmon Sienna, MFSA: Surfin Aquavert, MFPS: Pistachio, MFOS: Oyster, MFNA: Navy, MFOL: Olive, MFGB: Grey Beige MFGG: Graphite Gray, MFG: Gray
  - Premium metal finish for WMT Wire Management Tray - \$75 ea
  - Premium metal finish for MTL10 Metal Feet - \$20 ea
  - Premium metal finish for PCEB Concealed Floor Power Infeed Cover - \$35
- STARTER PANEL**
- RSP: Substitute round starter panel in place of flat starter panel. Must substitute all starters, priced per starter panel - \$83 each. See HNY3555SP888
- TELECOM PLATES**
- Each power unit has 1 plate. All telecom connectors sold separately.
  - RJ45 (1) - \$35, RJ45 (2) - \$70, RJ45 (3) - \$105, USB (1) - \$70, USB (2) - \$140, RJ45/USB - \$105, RJ45/HDMI - \$190, HDMI/USB - \$205
- WORKSURFACE HEIGHT**
- THL42: Modify worksurface height to bar height - N/C

1 Select a model w" x d" x h"	PERSON	yardage	Standard Veneer Top Upholstered Panels - COM\$		Premium Veneer Top Upholstered Panels - COM\$		High Pressure Laminate Top Upholstered Panels - COM\$		Thermally Fused Laminate Top Upholstered Panels - COM\$	
602 x 86 x 55	8	128	HNY60286FP578W	53919	"P" Option N/A	HNY60286FP578G	52559	HNY60286FP578M	49959	
528 x 86 x 55	7	112	HNY52886FP578W	47335	"P" Option N/A	HNY52886FP578G	46145	HNY52886FP578M	43870	
453 x 86 x 55	6	97	HNY45386FP578W	40751	"P" Option N/A	HNY45386FP578G	39731	HNY45386FP578M	37781	
378 x 86 x 55	5	81	HNY37886FP578W	34167	"P" Option N/A	HNY37886FP578G	33317	HNY37886FP578M	31692	
303 x 86 x 55	4	66	HNY30386FP578W	27583	"P" Option N/A	HNY30386FP578G	26903	HNY30386FP578M	25603	
228 x 86 x 55	3	50	HNY22886FP578W	20999	"P" Option N/A	HNY22886FP578G	20489	HNY22886FP578M	19514	
153 x 86 x 55	2	35	HNY15386FP578W	14415	"P" Option N/A	HNY15386FP578G	14075	HNY15386FP578M	13425	
78 x 86 x 55	1	19	HNY7886FP578W	7831	"P" Option N/A	HNY7886FP578G	7661	HNY7886FP578M	7336	

2 Select a worksurface finish <i>View finish details</i>	WWP	WBW	GEC	LW01	MEC
Wire Tray Metal finish Standard in MFW White. See premium finishes for options.	PO02	WEC	LP01	LW04	MSW
	PO03	WOW	LP02	LW05	MTW
	PO04	WNO	LF01	LW06	MWL
	PO05	WSO	LF02	LW07	
	PO06		LF03		
	PO07		LN01		
	PO08		LA01		
	PO09		LA02		

3 Select feet finish <i>View finish details</i>	WWP	WBW	WWP	WBW	WWP	WBW
	PO02	WEC	PO02	WEC	PO02	WEC
	PO03	WOW	PO03	WOW	PO03	WOW
	PO04	WNO	PO04	WNO	PO04	WNO
	PO05	WSO	PO05	WSO	PO05	WSO
	PO06		PO06		PO06	
	PO07		PO07		PO07	
	PO08		PO08		PO08	
	PO09		PO09		PO09	

4 Select a edge <i>View edge details</i>	Cliff-1 Veneer			Cliff-2 Black			Cliff-3 White		
		Flat-1 Veneer	Flat-2 Black	Flat-3 White	Cliff-1 HPL	Cliff-2 Black	Cliff-3 White	Flat-2 Black	Flat-3 White
				Flat-1 HPL	Flat-2 Black	Flat-3 White			

# Honey.

## Double Hexagon Workstation Typical Position 1 Desk with Height Adjustable Worksurface

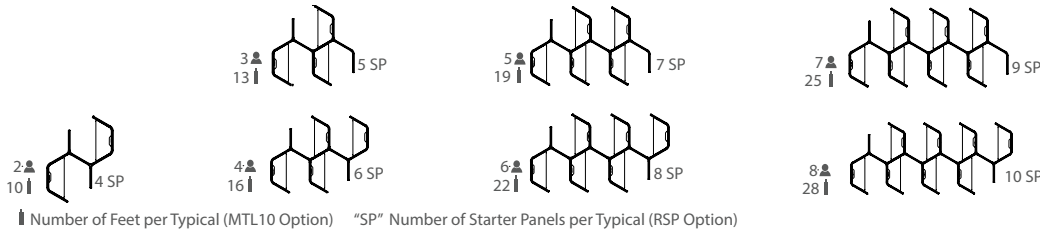

Number of Feet per Typical (MTL10 Option) "SP" Number of Starter Panels per Typical (RSP Option)

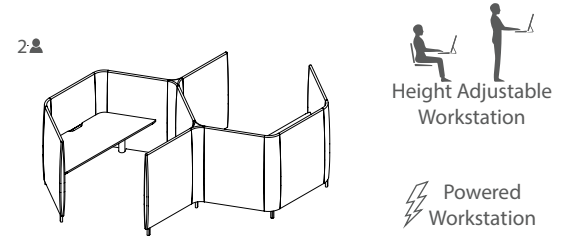

[View statement of line](#)

### Product features.

- 5" Solid wood feet - oval shape, ships KD
- 4 Power outlets with 1 telecom plate, see options below for telecom plate
- Adjustable height from 27" to 47.5" with a maximum weight capacity of 275 lbs. Lift standard in MFW White, optional MFB Black
- HNY7227WT163 Height Adjustable worksurfaces are included
- Wire management tray attaches to worksurface top, standard in MFW White, see premium metal finish for options

#### NOTES

- 1" Gap between worksurface and panels to drop wires below worksurface
- Metal parts include 5 year warranty
- Programmable height adjustable mechanism, motor includes 2 year warranty

### Options.

#### ACCESSORIES

- K28: Articulating Keyboard w/ Mouse - \$390
- K31-SK: Center drawer w/ skirt - \$310
- K31: Center drawer w/o skirt - \$205

#### CONCEALED FLOOR POWER INFEED COVER

- PCEB: White metal finish concealed floor power infeed cover - \$150

#### DELETE TOP AND WIRE TRAY

- DHAT: Delete height adjustable top. Deduct \$3265 Veneer(W), \$3095 High Pressure Laminate(G), \$2770 Thermally Fused Laminate(M) per top

#### METAL FEET

- MTL10: Replace solid wood feet with metal feet, standard MFW White - \$55 ea

#### PREMIUM METAL FINISH

- Specify premium metal finish. MFMB: Matte Black, MFS: Silver, MFSS: Salmon Sienna, MFSA: Surfing Aquavert, MFPS: Pistachio, MFOS: Oyster, MFNA: Navy, MFOL: Olive, MFGB: Grey Beige MFGG: Graphite Gray, MFG: Gray
- Premium metal finish for WMT Wire Management Tray - \$75 ea
- Premium metal finish for MTL10 Metal Feet - \$20 ea
- Premium metal finish for PCEB Concealed Floor Power Infeed Cover - \$35

#### STARTER PANEL

- RSP: Substitute round starter panel in place of flat starter panel. Must substitute all starters, priced per starter panel - \$83 each. See HNY3555SP888

#### TELECOM PLATES

- Each power unit has 1 plate. All telecom connectors sold separately.
- RJ45 (1) - \$35, RJ45 (2) - \$70, RJ45 (3) - \$105, USB (1) - \$70, USB (2) - \$140, RJ45/USB - \$105, RJ45/HDMI - \$190, HDMI/USB - \$205

1 Select a model w" x d" x h"	PERSON	yardage	Standard Veneer Top Upholstered Panels - COM\$		Premium Veneer Top Upholstered Panels - COM\$		High Pressure Laminate Top Upholstered Panels - COM\$		Thermally Fused Laminate Top Upholstered Panels - COM\$	
340 x 150 x 55	8	103	HNY340150HA579W	61120	"P" Option N/A	HNY340150HA579G	59760	HNY340150HA579M	57160	
303 x 150 x 55	7	92	HNY303150HA579W	53826	"P" Option N/A	HNY303150HA579G	52636	HNY303150HA579M	50361	
265 x 150 x 55	6	80	HNY265150HA579W	46732	"P" Option N/A	HNY265150HA579G	45712	HNY265150HA579M	43762	
228 x 150 x 55	5	69	HNY228150HA579W	39488	"P" Option N/A	HNY228150HA579G	38638	HNY228150HA579M	37013	
191 x 150 x 55	4	57	HNY191150HA579W	32344	"P" Option N/A	HNY191150HA579G	31664	HNY191150HA579M	30364	
153 x 150 x 55	3	46	HNY153150HA579W	25050	"P" Option N/A	HNY153150HA579G	24540	HNY153150HA579M	23565	
116 x 150 x 55	2	34	HNY116150HA579W	17961	"P" Option N/A	HNY116150HA579G	17621	HNY116150HA579M	16971	

2 Select a worksurface finish									
WWP	WBW	GEC	LW01	MEC					
PO01	WSW	GWL	LW02	MOC					
PO02	WEC	LP01	LW04	MSW					
PO03	WOW	LP02	LW05	MTW					
PO04	WNO	LF01	LW06	MWL					
PO05	WSO	LF02	LW07						
PO06		LF03							
PO07		LN01							
PO08		LA01							
PO09		LA02							

3 Select feet finish									
WWP	WBW	WWP	WBW	WWP	WBW				
PO01	WSW	PO01	WSW	PO01	WSW				
PO02	WEC	PO02	WEC	PO02	WEC				
PO03	WOW	PO03	WOW	PO03	WOW				
PO04	WNO	PO04	WNO	PO04	WNO				
PO05	WSO	PO05	WSO	PO05	WSO				
PO06		PO06		PO06					
PO07		PO07		PO07					
PO08		PO08		PO08					
PO09		PO09		PO09					

4 Select an edge									
Cliff-1 Veneer	Cliff-2 Black	Cliff-3 White	Cliff-1 HPL	Cliff-2 Black	Cliff-3 White	Flat-2 Black	Flat-3 White	Flat-4 Matching	
Flat-1 Veneer	Flat-2 Black	Flat-3 White	Flat-1 HPL	Flat-2 Black	Flat-3 White				

# Honey.

## Double Hexagon Workstation Typical Position 1 Desk with Fixed Worksurface

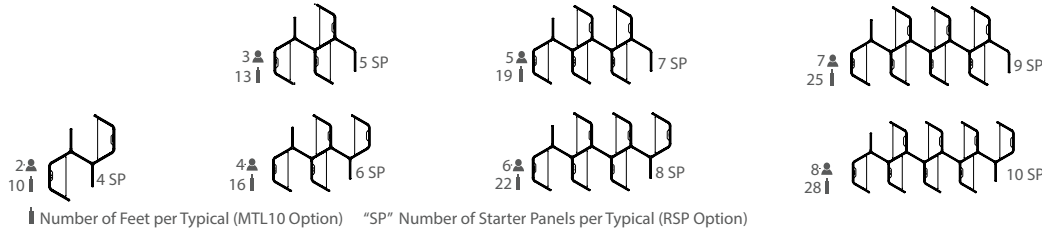

Number of Feet per Typical (MTL10 Option) "SP" Number of Starter Panels per Typical (RSP Option)

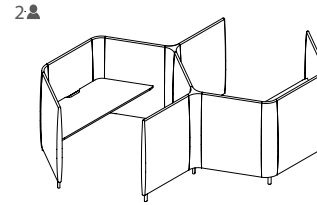

Fixed Top Workstation

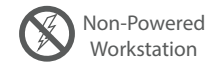

Non-Powered Workstation

[View statement of line](#)

### Product features.

- 5" Solid wood feet - oval shape
- HNY7227WT162 Fixed Desk Height worksurfaces, 29" worksurface height
- Ships KD

### Options.

#### ACCESSORIES

- K28: Articulating Keyboard w/ Mouse - \$390
- K31-SK: Center drawer w/ skirt - \$310
- K31: Center drawer w/o skirt - \$205

#### CONCEALED FLOOR POWER INFEED COVER

- PCEB: White metal finish concealed floor power infeed cover - \$150

#### DELETE TOP

- DFT: Delete fixed top. Deduct \$1125 Veneer(W), \$955 High Pressure Laminate (G), \$630 Thermally Fused Laminate (M) per top

#### METAL FEET

- MTL10: Replace soild wood feet with metal feet, standard MFW White - \$55 ea

#### PREMIUM METAL FINISH

- Specify premium metal finish. MFMB: Matte Black, MFS: Silver, MFSS: Salmon Sienna, MFSA: Surfin Aquavert, MFPS: Pistachio, MFOS: Oyster, MFNA: Navy, MFOL: Olive, MFGB: Grey Beige MFGG: Graphite Gray, MFG: Gray
- Premium metal finish for WMT Wire Management Tray - \$75 ea
- Premium metal finish for MTL10 Metal Feet - \$20 ea
- Premium metal finish for PCEB Concealed Floor Power Infeed Cover - \$35

#### STARTER PANEL

- RSP: Substitute round starter panel in place of flat starter panel. Must substitute all starters, priced per starter panel - \$83 each. See HNY3555SP888

#### WORKSURFACE HEIGHT

- Modify worksurface height to bar height.
- THL-42: Position worksurface at bar height - N/C

#### WIRE TRAY

- WMT: Wire metal tray. Mounts under top and comes standard in MFW White - \$210

1 Select a model w" x d" x h"	PERSON	yardage	Standard Veneer Top Upholstered Panels - COM\$		Premium Veneer Top Upholstered Panels - COM\$		High Pressure Laminate Top Upholstered Panels - COM\$		Thermally Fused Laminate Top Upholstered Panels - COM\$	
340 x 150 x 55	8	103	HNY340150FT579W	40726	"P" Option N/A	HNY340150FT579G	39366	HNY340150FT579M	36766	
303 x 150 x 55	7	92	HNY303150FT579W	36060	"P" Option N/A	HNY303150FT579G	34870	HNY303150FT579M	32595	
265 x 150 x 55	6	80	HNY265150FT579W	31394	"P" Option N/A	HNY265150FT579G	30374	HNY265150FT579M	28424	
228 x 150 x 55	5	69	HNY228150FT579W	26728	"P" Option N/A	HNY228150FT579G	25878	HNY228150FT579M	24253	
191 x 150 x 55	4	57	HNY191150FT579W	22062	"P" Option N/A	HNY191150FT579G	21382	HNY191150FT579M	20082	
153 x 150 x 55	3	46	HNY153150FT579W	17396	"P" Option N/A	HNY153150FT579G	16886	HNY153150FT579M	15911	
116 x 150 x 55	2	34	HNY116150FT579W	12730	"P" Option N/A	HNY116150FT579G	12390	HNY116150FT579M	11740	

[Click Here for Graded in Pricing](#)

2 Select a worksurface finish <a href="#">View finish details</a>	WVP	WBW
PO01	WSW	
PO02	WEC	
PO03	WOW	
PO04	WNO	
PO05	WSO	
PO06		
PO07		
PO08		
PO09		

3 Select feet finish <a href="#">View finish details</a>	WVP	WBW
PO01	WSW	
PO02	WEC	
PO03	WOW	
PO04	WNO	
PO05	WSO	
PO06		
PO07		
PO08		
PO09		

4 Select a edge <a href="#">View edge details</a>	Cliff-1 Veneer	Cliff-2 Black	Cliff-3 White	Flat-1 Veneer	Flat-2 Black	Flat-3 White

GEC	LW01
GWL	LW02
LP01	LW04
LP02	LW05
LF01	LW06
LF02	LW07
LF03	
LN01	
LA01	
LA02	

WVP	WBW
PO01	WSW
PO02	WEC
PO03	WOW
PO04	WNO
PO05	WSO
PO06	
PO07	
PO08	
PO09	

MEC	
MOC	
MSW	
MTW	
MWL	

Cliff-1 HPL	Cliff-2 Black	Cliff-3 White
Flat-1 HPL	Flat-2 Black	Flat-3 White

WVP	WBW
PO01	WSW
PO02	WEC
PO03	WOW
PO04	WNO
PO05	WSO
PO06	
PO07	
PO08	
PO09	

Flat-2 Black	Flat-3 White	Flat-4 Matching
-----------------	-----------------	--------------------

# Honey.

## Double Hexagon Workstation Typical Position 1 Desk with Power Fixed Worksurface

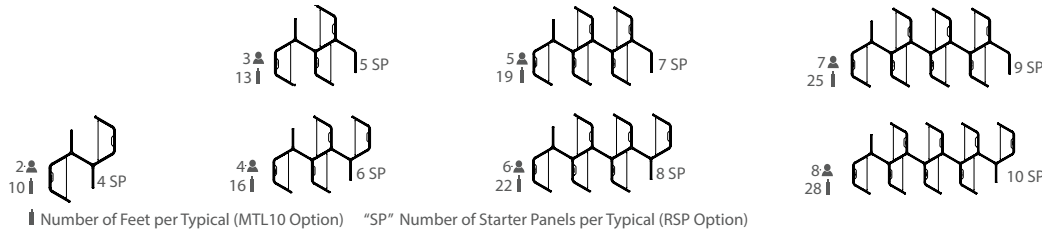

Number of Feet per Typical (MTL10 Option) "SP" Number of Starter Panels per Typical (RSP Option)

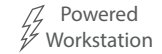
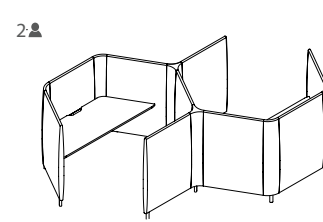

[View statement of line](#)

## Product features.

- HNY7227WT162 Fixed Desk Height worksurfaces, 29" worksurface height
- 5" Solid wood feet - oval shape
- 4 Power outlets with 1 telecom plate, see options below for telecom plate
- Ships KD
- Wire management tray attaches to worksurface top, standard in MFW White, see premium metal finish for options
- Hardwire infeed and jumpers are included in workstations

## Options.

### ACCESSORIES

- K28: Articulating Keyboard w/ Mouse - \$390
- K31-SK: Center drawer w/ skirt - \$310
- K31: Center drawer w/o skirt - \$205

### CONCEALED FLOOR POWER INFEED COVER

- PCEB: White metal finish concealed floor power infeed cover - \$150

### DELETE TOP AND WIRE TRAY

- DFP: Delete fixed top. Deduct \$1335 Veneer (W), \$1165 High Pressure Laminate (G), \$840 Thermally Fused Laminate (M) per top

### METAL FEET

- MTL10: Replace solid wood feet with metal feet, standard MFW White - \$55 ea

### PREMIUM METAL FINISH

- Specify premium metal finish. MFMB: Matte Black, MFS: Silver, MFSS: Salmon Sienna, MFSA: Surfin Aquavert, MFPS: Pistachio, MFOS: Oyster, MFNA: Navy, MFOL: Olive, MFGB: Grey Beige MFGG: Graphite Gray, MFG: Gray
- Premium metal finish for WMT Wire Management Tray - \$75 ea
- Premium metal finish for MTL10 Metal Feet - \$20 ea
- Premium metal finish for PCEB Concealed Floor Power Infeed Cover - \$35

### STARTER PANEL

- RSP: Substitute round starter panel in place of flat starter panel. Must substitute all starters, priced per starter panel - \$83 each. See HNY3555SP888

### TELECOM PLATES

- Each power unit has 1 plate. All telecom connectors sold separately.
- RJ45 (1) - \$35, RJ45 (2) - \$70, RJ45 (3) - \$105, USB (1) - \$70, USB (2) - \$140, RJ45/USB - \$105, RJ45/HDMI - \$190, HDMI/USB - \$205

### WORKSURFACE HEIGHT

- THL42: Modify worksurface height to bar height - N/C

1 Select a model w" x d" x h"	PERSON	yardage	Standard Veneer Top Upholstered Panels - COM\$		Premium Veneer Top Upholstered Panels - COM\$		High Pressure Laminate Top Upholstered Panels - COM\$		Thermally Fused Laminate Top Upholstered Panels - COM\$			
			WVP	WBW	WVP	WBW	GEC	LW01	MEC		WVP	WBW
340 x 150 x 55	8	103	HNY340150FP579W	45680	"P" Option N/A		HNY340150FP579G	44320	HNY340150FP579M	41720		
303 x 150 x 55	7	92	HNY303150FP579W	40316	"P" Option N/A		HNY303150FP579G	39126	HNY303150FP579M	36851		
265 x 150 x 55	6	80	HNY265150FP579W	35152	"P" Option N/A		HNY265150FP579G	34132	HNY265150FP579M	32182		
228 x 150 x 55	5	69	HNY228150FP579W	29838	"P" Option N/A		HNY228150FP579G	28988	HNY228150FP579M	27363		
191 x 150 x 55	4	57	HNY191150FP579W	24624	"P" Option N/A		HNY191150FP579G	23944	HNY191150FP579M	22644		
153 x 150 x 55	3	46	HNY153150FP579W	19260	"P" Option N/A		HNY153150FP579G	18750	HNY153150FP579M	17775		
116 x 150 x 55	2	34	HNY116150FP579W	14101	"P" Option N/A		HNY116150FP579G	13761	HNY116150FP579M	13111		
2 Select a worksurface finish <a href="#">View finish details</a>			WVP	WBW			GEC	LW01	MEC			
Wire Tray Metal finish Standard in MFW White. See premium finishes for options.			PO01	WSW			GWL	LW02	MOC			
			PO02	WEC			LP01	LW04	MSW			
			PO03	WOW			LP02	LW05	MTW			
			PO04	WNO			LF01	LW06	MWL			
			PO05	WSO			LF02	LW07				
			PO06				LF03					
			PO07				LN01					
			PO08				LA01					
			PO09				LA02					
3 Select feet finish <a href="#">View finish details</a>			WVP	WBW			WVP	WBW	WVP	WBW		
			PO01	WSW			PO01	WSW	PO01	WSW		
			PO02	WEC			PO02	WEC	PO02	WEC		
			PO03	WOW			PO03	WOW	PO03	WOW		
			PO04	WNO			PO04	WNO	PO04	WNO		
			PO05	WSO			PO05	WSO	PO05	WSO		
			PO06				PO06		PO06			
			PO07				PO07		PO07			
			PO08				PO08		PO08			
			PO09				PO09		PO09			
4 Select an edge <a href="#">View edge details</a>			Cliff-1 Veneer	Cliff-2 Black	Cliff-3 White		Cliff-1 HPL	Cliff-2 Black	Cliff-3 White	Flat-2 Black	Flat-3 White	Flat-4 Matching
			Flat-1 Veneer	Flat-2 Black	Flat-3 White		Flat-1 HPL	Flat-2 Black	Flat-3 White			

# Honey.

## Double Hexagon Workstation Typical Position 2 Desk with Height Adjustable Worksurface

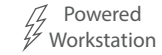
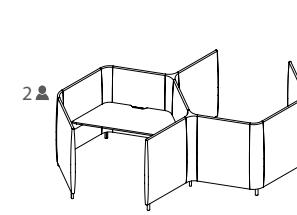
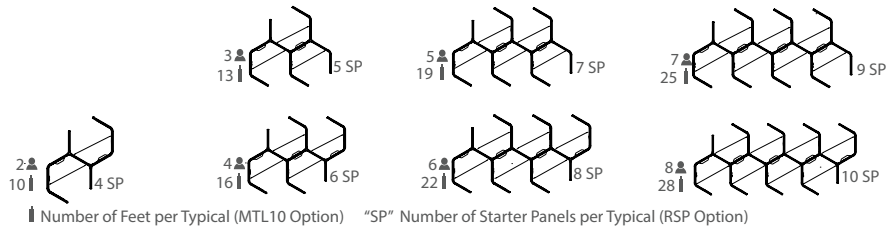

[View statement of line](#)

### Product features.

- 5" Solid wood feet - oval shape, ships KD
- 4 Power outlets with 1 telecom plate, see options below for telecom plate
- Adjustable height from 27" to 47.5" with a maximum weight capacity of 275 lbs. Lift standard in MFW White, optional MFB Black
- HNY7227WT163 Height Adjustable worksurfaces are included
- Wire management tray attaches to worksurface top, standard in MFW White, see premium metal finish for options

#### NOTES

- 1" Gap between worksurface and panels to drop wires below worksurface
- Metal parts include 5 year warranty
- Programmable height adjustable mechanism, motor includes 2 year warranty

### Options.

#### ACCESSORIES

- K28: Articulating Keyboard w/ Mouse - \$390
- K31-SK: Center drawer w/ skirt - \$310
- K31: Center drawer w/o skirt - \$205

#### CONCEALED FLOOR POWER INFEED COVER

- PCEB: White metal finish concealed floor power infeed cover - \$150

#### DELETE TOP AND WIRE TRAY

- DHAT: Delete height adjustable top. Deduct \$3265 Veneer(W), \$3095 High Pressure Laminate(G), \$2770 Thermally Fused Laminate(M) per top

#### METAL FEET

- MTL10: Replace solid wood feet with metal feet, standard MFW White - \$55 ea

#### PREMIUM METAL FINISH

- Specify premium metal finish. MFMB: Matte Black, MFS: Silver, MFSS: Salmon Sienna, MFSA: Surfing Aquavert, MFPS: Pistachio, MFOS: Oyster, MFNA: Navy, MFOL: Olive, MFGB: Grey Beige MFGG: Graphite Gray, MFG: Gray
- Premium metal finish for WMT Wire Management Tray - \$75 ea
- Premium metal finish for MTL10 Metal Feet - \$20 ea
- Premium metal finish for PCEB Concealed Floor Power Infeed Cover - \$35

#### STARTER PANEL

- RSP: Substitute round starter panel in place of flat starter panel. Must substitute all starters, priced per starter panel - \$83 each. See HNY3555SP888

#### TELECOM PLATES

- Each power unit has 1 plate. All telecom connectors sold separately.
- RJ45 (1) - \$35, RJ45 (2) - \$70, RJ45 (3) - \$105, USB (1) - \$70, USB (2) - \$140, RJ45/USB - \$105, RJ45/HDMI - \$190, HDMI/USB - \$205

1 Select a model w" x d" x h"	PERSON	yardage	Standard Veneer Top Upholstered Panels - COM\$		Premium Veneer Top Upholstered Panels - COM\$		High Pressure Laminate Top Upholstered Panels - COM\$		Thermally Fused Laminate Top Upholstered Panels - COM\$	
340 x 150 x 55	8	103	HNY340150HA580W	60013	"P" Option N/A	HNY340150HA580G	58653	HNY340150HA580M	56053	
303 x 150 x 55	7	92	HNY303150HA580W	52819	"P" Option N/A	HNY303150HA580G	51629	HNY303150HA580M	49354	
265 x 150 x 55	6	80	HNY265150HA580W	45944	"P" Option N/A	HNY265150HA580G	44924	HNY265150HA580M	42974	
228 x 150 x 55	5	69	HNY228150HA580W	38750	"P" Option N/A	HNY228150HA580G	37900	HNY228150HA580M	36275	
191 x 150 x 55	4	57	HNY191150HA580W	31875	"P" Option N/A	HNY191150HA580G	31195	HNY191150HA580M	29895	
153 x 150 x 55	3	46	HNY153150HA580W	24681	"P" Option N/A	HNY153150HA580G	24171	HNY153150HA580M	23196	
116 x 150 x 55	2	34	HNY116150HA580W	17806	"P" Option N/A	HNY116150HA580G	17466	HNY116150HA580M	16816	

2 Select a worksurface finish								
View finish details	WWP	WBW			GEC	LW01	MEC	
Metal finish	PO01	WSW			GWL	LW02	MOC	
Height adjustable column standard in MFW White. Optional MFB Black.	PO02	WEC			LP01	LW04	MSW	
	PO03	WOW			LP02	LW05	MTW	
	PO04	WNO			LF01	LW06	MWL	
	PO05	WSO			LF02	LW07		
	PO06				LF03			
	PO07				LN01			
	PO08				LA01			
	PO09				LA02			

3 Select feet finish								
View finish details	WWP	WBW			WWP	WBW	WWP	WBW
	PO01	WSW			PO01	WSW	PO01	WSW
	PO02	WEC			PO02	WEC	PO02	WEC
	PO03	WOW			PO03	WOW	PO03	WOW
	PO04	WNO			PO04	WNO	PO04	WNO
	PO05	WSO			PO05	WSO	PO05	WSO
	PO06				PO06		PO06	
	PO07				PO07		PO07	
	PO08				PO08		PO08	
	PO09				PO09		PO09	

4 Select a edge									
View edge details	Cliff-1 Veneer	Cliff-2 Black	Cliff-3 White	Cliff-1 HPL	Cliff-2 Black	Cliff-3 White	Flat-2 Black	Flat-3 White	Flat-4 Matching
	Flat-1 Veneer	Flat-2 Black	Flat-3 White	Flat-1 HPL	Flat-2 Black	Flat-3 White			

# Honey.

## Double Hexagon Workstation Typical Position 2 Desk with Fixed Worksurface

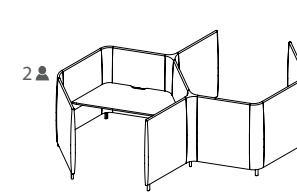
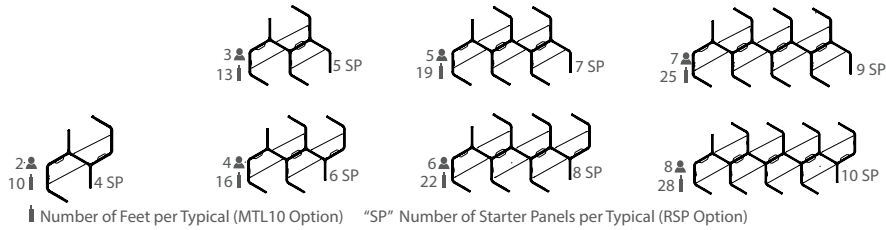

Fixed Top Workstation

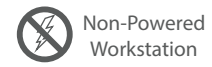

[View statement of line](#)

### Product features.

- 5" Solid wood feet - oval shape
- HNY7227WT162 Fixed Desk Height worksurfaces, 29" worksurface height
- Ships KD

### Options.

#### ACCESSORIES

- K28: Articulating Keyboard w/ Mouse - \$390
- K31-SK: Center drawer w/ skirt - \$310
- K31: Center drawer w/o skirt - \$205

#### CONCEALED FLOOR POWER INFEED COVER

- PCEB: White metal finish concealed floor power infeed cover - \$150

#### DELETE TOP

- DFT: Delete fixed top. Deduct \$1125 Veneer(W), \$955 High Pressure Laminate (G), \$630 Thermally Fused Laminate (M) per top

#### METAL FEET

- MTL10: Replace soild wood feet with metal feet, standard MFW White - \$55 ea

#### PREMIUM METAL FINISH

- Specify premium metal finish. MFMB: Matte Black, MFS: Silver, MFSS: Salmon Sienna, MFSA: Surfin Aquavert, MFPS: Pistachio, MFOS: Oyster, MFNA: Navy, MFOL: Olive, MFGB: Grey Beige MFGG: Graphite Gray, MFG: Gray
- Premium metal finish for WMT Wire Management Tray - \$75 ea
- Premium metal finish for MTL10 Metal Feet - \$20 ea
- Premium metal finish for PCEB Concealed Floor Power Infeed Cover - \$35

#### STARTER PANEL

- RSP: Substitute round starter panel in place of flat starter panel. Must substitute all starters, priced per starter panel - \$83 each. See HNY3555SP888

#### WORKSURFACE HEIGHT

- Modify worksurface height to bar height.
- THL-42: Position worksurface at bar height - N/C

#### WIRE TRAY

- WMT: Wire metal tray. Mounts under top and comes standard in MFW White - \$210

1 Select a model w" x d" x h"	PERSON	yardage	Standard Veneer Top Upholstered Panels - COM\$		Premium Veneer Top Upholstered Panels - COM\$		High Pressure Laminate Top Upholstered Panels - COM\$		Thermally Fused Laminate Top Upholstered Panels - COM\$	
340 x 150 x 55	8	103	HNY340150FT580W	40726	"P" Option N/A	HNY340150FT580G	39366	HNY340150FT580M	36766	
303 x 150 x 55	7	92	HNY303150FT580W	36060	"P" Option N/A	HNY303150FT580G	34870	HNY303150FT580M	32595	
265 x 150 x 55	6	80	HNY265150FT580W	31394	"P" Option N/A	HNY265150FT580G	30374	HNY265150FT580M	28424	
228 x 150 x 55	5	69	HNY228150FT580W	26728	"P" Option N/A	HNY228150FT580G	25878	HNY228150FT580M	24253	
191 x 150 x 55	4	57	HNY191150FT580W	22062	"P" Option N/A	HNY191150FT580G	21382	HNY191150FT580M	20082	
153 x 150 x 55	3	46	HNY153150FT580W	17396	"P" Option N/A	HNY153150FT580G	16886	HNY153150FT580M	15911	
116 x 150 x 55	2	34	HNY116150FT580W	12730	"P" Option N/A	HNY116150FT580G	12390	HNY116150FT580M	11740	

2 Select a worksurface finish <a href="#">View finish details</a>								
WWP	WBW	GEC	LW01	MEC				
PO01	WSW	GWL	LW02	MOC				
PO02	WEC	LP01	LW04	MSW				
PO03	WOW	LP02	LW05	MTW				
PO04	WNO	LF01	LW06	MWL				
PO05	WSO	LF02	LW07					
PO06		LF03						
PO07		LN01						
PO08		LA01						
PO09		LA02						

3 Select feet finish <a href="#">View finish details</a>								
WWP	WBW	WWP	WBW	WWP	WBW			
PO01	WSW	PO01	WSW	PO01	WSW			
PO02	WEC	PO02	WEC	PO02	WEC			
PO03	WOW	PO03	WOW	PO03	WOW			
PO04	WNO	PO04	WNO	PO04	WNO			
PO05	WSO	PO05	WSO	PO05	WSO			
PO06		PO06		PO06				
PO07		PO07		PO07				
PO08		PO08		PO08				
PO09		PO09		PO09				

  

4 Select an edge <a href="#">View edge details</a>									
Cliff-1 Veneer	Cliff-2 Black	Cliff-3 White	Cliff-1 HPL	Cliff-2 Black	Cliff-3 White	Flat-2 Black	Flat-3 White	Flat-4 Matching	
Flat-1 Veneer	Flat-2 Black	Flat-3 White	Flat-1 HPL	Flat-2 Black	Flat-3 White				



# Honey.

## Double Hexagon Workstation Typical Position 2 Desk with Power Fixed Worksurface

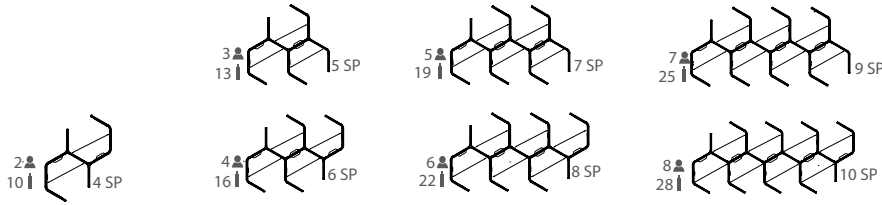

Number of Feet per Typical (MTL10 Option) "SP" Number of Starter Panels per Typical (RSP Option)

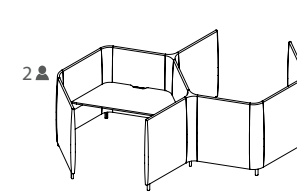

[View statement of line](#)

### Product features.

- HNY7227WT162 Fixed Desk Height worksurfaces, 29" worksurface height
- 5" Solid wood feet - oval shape
- 4 Power outlets with 1 telecom plate, see options below for telecom plate
- Ships KD
- Wire management tray attaches to worksurface top, standard in MFW White, see premium metal finish for options
- Hardwire infeed and jumpers are included in workstations

### Options.

#### ACCESSORIES

- K28: Articulating Keyboard w/ Mouse - \$390
- K31-SK: Center drawer w/ skirt - \$310
- K31: Center drawer w/o skirt - \$205

#### CONCEALED FLOOR POWER INFEEED COVER

- PCEB: White metal finish concealed floor power infeed cover - \$150

#### DELETE TOP AND WIRE TRAY

- DFP: Delete fixed top. Deduct \$1335 Veneer (W), \$1165 High Pressure Laminate (G), \$840 Thermally Fused Laminate (M) per top

#### METAL FEET

- MTL10: Replace solid wood feet with metal feet, standard MFW White - \$55 ea

#### PREMIUM METAL FINISH

- Specify premium metal finish. MFMB: Matte Black, MFS: Silver, MFSS: Salmon Sienna, MFSA: Surfin Aquavert, MFPS: Pistachio, MFOS: Oyster, MFNA: Navy, MFOL: Olive, MFGB: Grey Beige MFGG: Graphite Gray, MFG: Gray
- Premium metal finish for WMT Wire Management Tray - \$75 ea
- Premium metal finish for MTL10 Metal Feet - \$20 ea
- Premium metal finish for PCEB Concealed Floor Power Infeed Cover - \$35

#### STARTER PANEL

- RSP: Substitute round starter panel in place of flat starter panel. Must substitute all starters, priced per starter panel - \$83 each. See HNY3555SP888

#### TELECOM PLATES

- Each power unit has 1 plate. All telecom connectors sold separately.
- RJ45 (1) - \$35, RJ45 (2) - \$70, RJ45 (3) - \$105, USB (1) - \$70, USB (2) - \$140, RJ45/USB - \$105, RJ45/HDMI - \$190, HDMI/USB - \$205

#### WORKSURFACE HEIGHT

- THL42: Modify worksurface height to bar height - N/C

1 Select a model w" x d" x h"	PERSON	yardage	Standard Veneer Top Upholstered Panels - COM\$		Premium Veneer Top Upholstered Panels - COM\$		High Pressure Laminate Top Upholstered Panels - COM\$		Thermally Fused Laminate Top Upholstered Panels - COM\$	
340 x 150 x 55	8	103	HNY340150FP580W	44573	"P" Option N/A	HNY340150FP580G	43213	HNY340150FP580M	40613	
303 x 150 x 55	7	92	HNY303150FP580W	39309	"P" Option N/A	HNY303150FP580G	38119	HNY303150FP580M	35844	
265 x 150 x 55	6	80	HNY265150FP580W	34364	"P" Option N/A	HNY265150FP580G	33344	HNY265150FP580M	31394	
228 x 150 x 55	5	69	HNY228150FP580W	29100	"P" Option N/A	HNY228150FP580G	28250	HNY228150FP580M	26625	
191 x 150 x 55	4	57	HNY191150FP580W	24155	"P" Option N/A	HNY191150FP580G	23475	HNY191150FP580M	22175	
153 x 150 x 55	3	46	HNY153150FP580W	18891	"P" Option N/A	HNY153150FP580G	18381	HNY153150FP580M	17406	
116 x 150 x 55	2	34	HNY116150FP580W	13946	"P" Option N/A	HNY116150FP580G	13606	HNY116150FP580M	12956	

2 Select a worksurface finish								
WWP	WBW				GEC	LW01	MEC	
PO01	WSW				GWL	LW02	MOC	
PO02	WEC				LP01	LW04	MSW	
PO03	WOW				LP02	LW05	MTW	
PO04	WNO				LF01	LW06	MWL	
PO05	WSO				LF02	LW07		
PO06					LF03			
PO07					LN01			
PO08					LA01			
PO09					LA02			

3 Select feet finish								
WWP	WBW				WWP	WBW		
PO01	WSW				PO01	WSW		
PO02	WEC				PO02	WEC		
PO03	WOW				PO03	WOW		
PO04	WNO				PO04	WNO		
PO05	WSO				PO05	WSO		
PO06					PO06			
PO07					PO07			
PO08					PO08			
PO09					PO09			

4 Select an edge								
Cliff-1 Veneer	Cliff-2 Black	Cliff-3 White	Cliff-1 HPL	Cliff-2 Black	Cliff-3 White	Flat-2 Black	Flat-3 White	Flat-4 Matching
Flat-1 Veneer	Flat-2 Black	Flat-3 White	Flat-1 HPL	Flat-2 Black	Flat-3 White			

# Honey.

## Double Hexagon Workstation Typical Position 3 Desk with Height Adjustable Worksurface

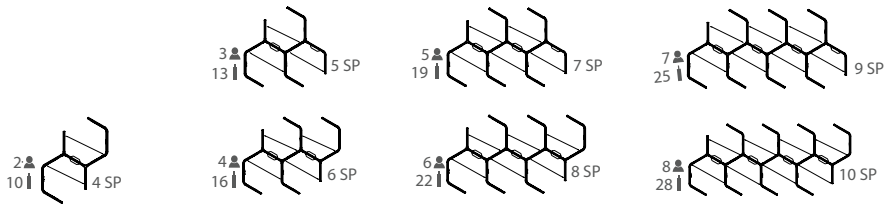

Number of Feet per Typical (MTL10 Option) "SP" Number of Starter Panels per Typical (RSP Option)

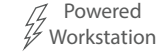
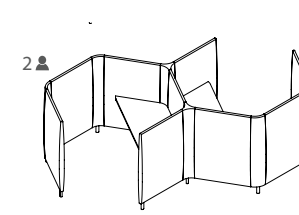

[View statement of line](#)

## Product features.

- 5" Solid wood feet - oval shape, ships KD
- 4 Power outlets with 1 telecom plate, see options below for telecom plate
- Adjustable height from 27" to 47.5" with a maximum weight capacity of 275 lbs. Lift standard in MFW White, optional MFB Black
- HNY7227WT163 Height Adjustable worksurfaces are included
- Wire management tray attaches to worksurface top, standard in MFW White, see premium metal finish for options

### NOTES

- 1" Gap between worksurface and panels to drop wires below worksurface
- Metal parts include 5 year warranty
- Programmable height adjustable mechanism, motor includes 2 year warranty

## Options.

### ACCESSORIES

- K28: Articulating Keyboard w/ Mouse - \$390
- K31-SK: Center drawer w/ skirt - \$310
- K31: Center drawer w/o skirt - \$205

### CONCEALED FLOOR POWER INFEED COVER

- PCEB: White metal finish concealed floor power infeed cover - \$150

### DELETE TOP AND WIRE TRAY

- DHAT: Delete height adjustable top. Deduct \$3265 Veneer(W), \$3095 High Pressure Laminate(G), \$2770 Thermally Fused Laminate(M) per top

### METAL FEET

- MTL10: Replace solid wood feet with metal feet, standard MFW White - \$55 ea

### PREMIUM METAL FINISH

- Specify premium metal finish. MFMB: Matte Black, MFS: Silver, MFSS: Salmon Sienna, MFSA: Surfing Aquavert, MFPS: Pistachio, MFOS: Oyster, MFNA: Navy, MFOL: Olive, MFGB: Grey Beige MFGG: Graphite Gray, MFG: Gray
- Premium metal finish for WMT Wire Management Tray - \$75 ea
- Premium metal finish for MTL10 Metal Feet - \$20 ea
- Premium metal finish for PCEB Concealed Floor Power Infeed Cover - \$35

### STARTER PANEL

- RSP: Substitute round starter panel in place of flat starter panel. Must substitute all starters, priced per starter panel - \$83 each. See HNY3555SP888

### TELECOM PLATES

- Each power unit has 1 plate. All telecom connectors sold separately.
- RJ45 (1) - \$35, RJ45 (2) - \$70, RJ45 (3) - \$105, USB (1) - \$70, USB (2) - \$140, RJ45/USB - \$105, RJ45/HDMI - \$190, HDMI/USB - \$205

1 Select a model w" x d" x h"	PERSON	yardage	Standard Veneer Top Upholstered Panels - COM\$		Premium Veneer Top Upholstered Panels - COM\$		High Pressure Laminate Top Upholstered Panels - COM\$		Thermally Fused Laminate Top Upholstered Panels - COM\$	
340 x 150 x 55	8	103	HNY340150HA581W	59744	"P" Option N/A	HNY340150HA581G	58384	HNY340150HA581M	55784	
303 x 150 x 55	7	92	HNY303150HA581W	52869	"P" Option N/A	HNY303150HA581G	51679	HNY303150HA581M	49404	
265 x 150 x 55	6	80	HNY265150HA581W	45675	"P" Option N/A	HNY265150HA581G	44655	HNY265150HA581M	42705	
228 x 150 x 55	5	69	HNY228150HA581W	38800	"P" Option N/A	HNY228150HA581G	37950	HNY228150HA581M	36325	
191 x 150 x 55	4	57	HNY191150HA581W	31606	"P" Option N/A	HNY191150HA581G	30926	HNY191150HA581M	29626	
153 x 150 x 55	3	46	HNY153150HA581W	24731	"P" Option N/A	HNY153150HA581G	24221	HNY153150HA581M	23246	
116 x 150 x 55	2	34	HNY116150HA581W	17537	"P" Option N/A	HNY116150HA581G	17197	HNY116150HA581M	16547	

2 Select a worksurface finish								
WWP	WBW			GEC	LW01	MEC		
PO01	WSW			GWL	LW02	MOC		
PO02	WEC			LP01	LW04	MSW		
PO03	WOW			LP02	LW05	MTW		
PO04	WNO			LF01	LW06	MWL		
PO05	WSO			LF02	LW07			
PO06				LF03				
PO07				LN01				
PO08				LA01				
PO09				LA02				

3 Select feet finish								
WWP	WBW			WWP	WBW	WWP	WBW	
PO01	WSW			PO01	WSW	PO01	WSW	
PO02	WEC			PO02	WEC	PO02	WEC	
PO03	WOW			PO03	WOW	PO03	WOW	
PO04	WNO			PO04	WNO	PO04	WNO	
PO05	WSO			PO05	WSO	PO05	WSO	
PO06				PO06		PO06		
PO07				PO07		PO07		
PO08				PO08		PO08		
PO09				PO09		PO09		

4 Select a edge								
Cliff-1 Veneer	Cliff-2 Black	Cliff-3 White		Cliff-1 HPL	Cliff-2 Black	Cliff-3 White		
Flat-1 Veneer	Flat-2 Black	Flat-3 White		Flat-2 Black	Flat-3 White	Flat-4 Matching		

# Honey.

## Double Hexagon Workstation Typical Position 3 Desk with Fixed Worksurface

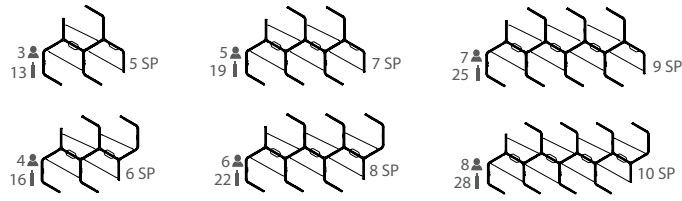

Number of Feet per Typical (MTL10 Option) "SP" Number of Starter Panels per Typical (RSP Option)

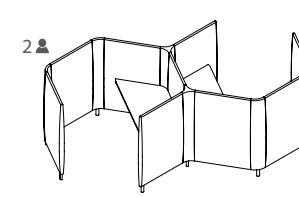

Fixed Top Workstation

Non-Powered Workstation

[View statement of line](#)

### Product features.

- 5" Solid wood feet - oval shape
- HNY7227WT162 Fixed Desk Height worksurfaces, 29" worksurface height
- Ships KD

### Options.

#### ACCESSORIES

- K28: Articulating Keyboard w/ Mouse - \$390
- K31-SK: Center drawer w/ skirt - \$310
- K31: Center drawer w/o skirt - \$205

#### CONCEALED FLOOR POWER INFEED COVER

- PCEB: White metal finish concealed floor power infeed cover - \$150

#### DELETE TOP

- DFT: Delete fixed top. Deduct \$1125 Veneer(W), \$955 High Pressure Laminate (G), \$630 Thermally Fused Laminate (M) per top

#### METAL FEET

- MTL10: Replace soild wood feet with metal feet, standard MFW White - \$55 ea

#### PREMIUM METAL FINISH

- Specify premium metal finish. MFMB: Matte Black, MFS: Silver, MFSS: Salmon Sienna, MFSA: Surfin Aquavert, MFPS: Pistachio, MFOS: Oyster, MFNA: Navy, MFOL: Olive, MFGB: Grey Beige MFGG: Graphite Gray, MFG: Gray
- Premium metal finish for WMT Wire Management Tray - \$75 ea
- Premium metal finish for MTL10 Metal Feet - \$20 ea
- Premium metal finish for PCEB Concealed Floor Power Infeed Cover - \$35

#### STARTER PANEL

- RSP: Substitute round starter panel in place of flat starter panel. Must substitute all starters, priced per starter panel - \$83 each. See HNY3555SP888

#### WORKSURFACE HEIGHT

- Modify worksurface height to bar height.
- THL-42: Position worksurface at bar height - N/C

#### WIRE TRAY

- WMT: Wire metal tray. Mounts under top and comes standard in MFW White - \$210

1 Select a model w" x d" x h"	PERSON	yardage	Standard Veneer Top Upholstered Panels - COM\$		Premium Veneer Top Upholstered Panels - COM\$		High Pressure Laminate Top Upholstered Panels - COM\$		Thermally Fused Laminate Top Upholstered Panels - COM\$	
340 x 150 x 55	8	103	HNY340150FT581W	40726	"P" Option N/A	HNY340150FT581G	39366	HNY340150FT581M	36766	
303 x 150 x 55	7	92	HNY303150FT581W	36060	"P" Option N/A	HNY303150FT581G	34870	HNY303150FT581M	32595	
265 x 150 x 55	6	80	HNY265150FT581W	31394	"P" Option N/A	HNY265150FT581G	30374	HNY265150FT581M	28424	
228 x 150 x 55	5	69	HNY228150FT581W	26728	"P" Option N/A	HNY228150FT581G	25878	HNY228150FT581M	24253	
191 x 150 x 55	4	57	HNY191150FT581W	22062	"P" Option N/A	HNY191150FT581G	21382	HNY191150FT581M	20082	
153 x 150 x 55	3	46	HNY153150FT581W	17396	"P" Option N/A	HNY153150FT581G	16886	HNY153150FT581M	15911	
116 x 150 x 55	2	34	HNY116150FT581W	12730	"P" Option N/A	HNY116150FT581G	12390	HNY116150FT581M	11740	

2 Select a worksurface finish <a href="#">View finish details</a>								
WWP	WBW	GEC	LW01	MEC				
PO01	WSW	GWL	LW02	MOC				
PO02	WEC	LP01	LW04	MSW				
PO03	WOW	LP02	LW05	MTW				
PO04	WNO	LF01	LW06	MWL				
PO05	WSO	LF02	LW07					
PO06		LF03						
PO07		LN01						
PO08		LA01						
PO09		LA02						

3 Select feet finish <a href="#">View finish details</a>								
WWP	WBW	WWP	WBW	WWP	WBW			
PO01	WSW	PO01	WSW	PO01	WSW			
PO02	WEC	PO02	WEC	PO02	WEC			
PO03	WOW	PO03	WOW	PO03	WOW			
PO04	WNO	PO04	WNO	PO04	WNO			
PO05	WSO	PO05	WSO	PO05	WSO			
PO06		PO06		PO06				
PO07		PO07		PO07				
PO08		PO08		PO08				
PO09		PO09		PO09				

4 Select a edge <a href="#">View edge details</a>									
Cliff-1 Veneer	Cliff-2 Black	Cliff-3 White	Cliff-1 HPL	Cliff-2 Black	Cliff-3 White	Flat-2 Black	Flat-3 White	Flat-4 Matching	
Flat-1 Veneer	Flat-2 Black	Flat-3 White	Flat-1 HPL	Flat-2 Black	Flat-3 White				

# Honey.

## Double Hexagon Workstation Typical Position 3 Desk with Power Fixed Worksurface

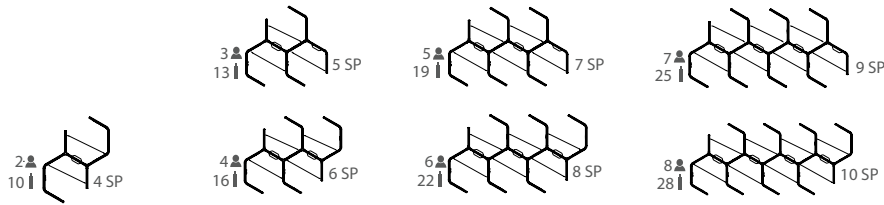

Number of Feet per Typical (MTL10 Option) "SP" Number of Starter Panels per Typical (RSP Option)

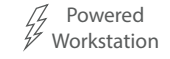
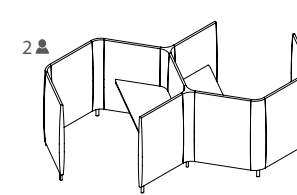

[View statement of line](#)

### Product features.

- HNY7227WT162 Fixed Desk Height worksurfaces, 29" worksurface height
- 5" Solid wood feet - oval shape
- 4 Power outlets with 1 telecom plate, see options below for telecom plate
- Ships KD
- Wire management tray attaches to worksurface top, standard in MFW White, see premium metal finish for options
- Hardwire infeed and jumpers are included in workstations

### Options.

#### ACCESSORIES

- K28: Articulating Keyboard w/ Mouse - \$390
- K31-SK: Center drawer w/ skirt - \$310
- K31: Center drawer w/o skirt - \$205

#### CONCEALED FLOOR POWER INFEED COVER

- PCEB: White metal finish concealed floor power infeed cover - \$150

#### DELETE TOP AND WIRE TRAY

- DFP: Delete fixed top. Deduct \$1335 Veneer (W), \$1165 High Pressure Laminate (G), \$840 Thermally Fused Laminate (M) per top

#### METAL FEET

- MTL10: Replace solid wood feet with metal feet, standard MFW White - \$55 ea

#### PREMIUM METAL FINISH

- Specify premium metal finish. MFMB: Matte Black, MFS: Silver, MFSS: Salmon Sienna, MFSA: Surfin Aquavert, MFPS: Pistachio, MFOS: Oyster, MFNA: Navy, MFOL: Olive, MFGB: Grey Beige MFGG: Graphite Gray, MFG: Gray
- Premium metal finish for WMT Wire Management Tray - \$75 ea
- Premium metal finish for MTL10 Metal Feet - \$20 ea
- Premium metal finish for PCEB Concealed Floor Power Infeed Cover - \$35

#### STARTER PANEL

- RSP: Substitute round starter panel in place of flat starter panel. Must substitute all starters, priced per starter panel - \$83 each. See HNY3555SP888

#### TELECOM PLATES

- Each power unit has 1 plate. All telecom connectors sold separately.
- RJ45 (1) - \$35, RJ45 (2) - \$70, RJ45 (3) - \$105, USB (1) - \$70, USB (2) - \$140, RJ45/USB - \$105, RJ45/HDMI - \$190, HDMI/USB - \$205

#### WORKSURFACE HEIGHT

- THL42: Modify worksurface height to bar height - N/C

1 Select a model w" x d" x h"	PERSON	yardage	Standard Veneer Top Upholstered Panels - COM\$		Premium Veneer Top Upholstered Panels - COM\$		High Pressure Laminate Top Upholstered Panels - COM\$		Thermally Fused Laminate Top Upholstered Panels - COM\$	
340 x 150 x 55	8	103	HNY340150FP581W	44304	"P" Option N/A	HNY340150FP581G	42944	HNY340150FP581M	40344	
303 x 150 x 55	7	92	HNY303150FP581W	39359	"P" Option N/A	HNY303150FP581G	38169	HNY303150FP581M	35894	
265 x 150 x 55	6	80	HNY265150FP581W	34095	"P" Option N/A	HNY265150FP581G	33075	HNY265150FP581M	31125	
228 x 150 x 55	5	69	HNY228150FP581W	29150	"P" Option N/A	HNY228150FP581G	28300	HNY228150FP581M	26675	
191 x 150 x 55	4	57	HNY191150FP581W	23886	"P" Option N/A	HNY191150FP581G	23206	HNY191150FP581M	21906	
153 x 150 x 55	3	46	HNY153150FP581W	18941	"P" Option N/A	HNY153150FP581G	18431	HNY153150FP581M	17456	
116 x 150 x 55	2	34	HNY116150FP581W	13677	"P" Option N/A	HNY116150FP581G	13337	HNY116150FP581M	12687	

2 Select a worksurface finish								
WWP	WBW				GEC	LW01	MEC	
PO01	WSW				GWL	LW02	MOC	
PO02	WEC				LP01	LW04	MSW	
PO03	WOW				LP02	LW05	MTW	
PO04	WNO				LF01	LW06	MWL	
PO05	WSO				LF02	LW07		
PO06					LF03			
PO07					LN01			
PO08					LA01			
PO09					LA02			

3 Select feet finish								
WWP	WBW				WWP	WBW	WWP	WBW
PO01	WSW				PO01	WSW	PO01	WSW
PO02	WEC				PO02	WEC	PO02	WEC
PO03	WOW				PO03	WOW	PO03	WOW
PO04	WNO				PO04	WNO	PO04	WNO
PO05	WSO				PO05	WSO	PO05	WSO
PO06					PO06		PO06	
PO07					PO07		PO07	
PO08					PO08		PO08	
PO09					PO09		PO09	

4 Select an edge								
Cliff-1 Veneer	Cliff-2 Black	Cliff-3 White	Cliff-1 HPL	Cliff-2 Black	Cliff-3 White	Flat-2 Black	Flat-3 White	Flat-4 Matching
Flat-1 Veneer	Flat-2 Black	Flat-3 White	Flat-1 HPL	Flat-2 Black	Flat-3 White			

# Honey.

Hexagon Workstation Typical  
Desk with Height Adjustable Worksurface

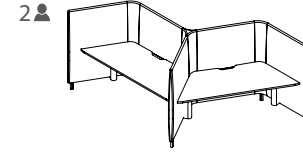
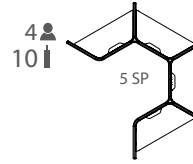
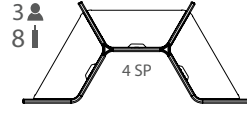
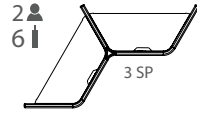

Number of Feet per Typical (MTL10 Option) "SP" Number of Starter Panels per Typical (RSP Option)

1 Select a model w" x d" x h"	person	yardage	Standard Veneer Top Upholstered Panels - COM\$		Premium Veneer Top Upholstered Panels - COM\$		High Pressure Laminate Top Upholstered Panels - COM\$		Thermally Fused Laminate Top Upholstered Panels - COM\$	
166 x 145 x 55	4	34	HNY166145HA582W	24313	"P" Option N/A	HNY166145HA582G	23633	HNY166145HA582M	22333	
166 x 74 x 55	3	26	HNY16674HA582W	18549	"P" Option N/A	HNY16674HA582G	18039	HNY16674HA582M	17064	
125 x 74 x 55	2	19	HNY12574HA582W	12785	"P" Option N/A	HNY12574HA582G	12445	HNY12574HA582M	11795	
85 x 37 x 55	1	11	HNY8537HA582W	7021	"P" Option N/A	HNY8537HA582G	6851	HNY8537HA582M	6526	

2 Select a worksurface finish <i>View finish details</i>	Metal finish Height adjustable column standard in MFW White. Optional MFB Black.		GEC		LW01		MEC	
	WWP	WBW						
PO01	WSW							MOC
PO02	WEC							MSW
PO03	WOW							MTW
PO04	WNO							MWL
PO05	WSO							
PO06								
PO07								
PO08								
PO09								

3 Select feet finish <i>View finish details</i>	WWP		WBW		WWP		WBW		WWP		WBW	
PO01	WSW											
PO02	WEC											
PO03	WOW											
PO04	WNO											
PO05	WSO											
PO06												
PO07												
PO08												
PO09												

4 Select a edge <i>View edge details</i>	Cliff-1 Veneer			Cliff-2 Black			Cliff-3 White			Flat-2 Black			Flat-3 White			Flat-4 Matching		
Flat-1 Veneer																		
Flat-2 Black																		
Flat-3 White																		

## View statement of line Product features.

- 5" Solid wood feet - oval shape, ships KD
- 4 Power outlets with 1 telecom plate, see options below for telecom plate
- Adjustable height from 27" to 47.5" with a maximum weight capacity of 275 lbs. Lift standard in MFW White, optional MFB Black
- HNY7227WT163 Height Adjustable worksurfaces are included
- Wire management tray attaches to worksurface top, standard in MFW White, see premium metal finish for options

### NOTES

- 1" Gap between worksurface and panels to drop wires below worksurface
- Metal parts include 5 year warranty
- Programmable height adjustable mechanism, motor includes 2 year warranty

## Options.

### ACCESSORIES

- K28: Articulating Keyboard w/ Mouse - \$390
- K31-SK: Center drawer w/ skirt - \$310
- K31: Center drawer w/o skirt - \$205

### CONCEALED FLOOR POWER INFEED COVER

- PCEB: White metal finish concealed floor power infeed cover - \$150

### DELETE TOP AND WIRE TRAY

- DHAT: Delete height adjustable top. Deduct \$3265 Veneer(W), \$3095 High Pressure Laminate(G), \$2770 Thermally Fused Laminate(M) per top

### METAL FEET

- MTL10: Replace solid wood feet with metal feet, standard MFW White - \$55 ea

### PREMIUM METAL FINISH

- Specify premium metal finish. MFMB: Matte Black, MFS: Silver, MFSS: Salmon Sienna, MFSA: Surfing Aquavert, MFPS: Pistachio, MFOS: Oyster, MFNA: Navy, MFOL: Olive, MFGB: Grey Beige MFGG: Graphite Gray, MFG: Gray
- Premium metal finish for WMT Wire Management Tray - \$75 ea
- Premium metal finish for MTL10 Metal Feet - \$20 ea
- Premium metal finish for PCEB Concealed Floor Power Infeed Cover - \$35

### STARTER PANEL

- RSP: Substitute round starter panel in place of flat starter panel. Must substitute all starters, priced per starter panel - \$83 each. See HNY3555SP888

### TELECOM PLATES

- Each power unit has 1 plate. All telecom connectors sold separately.
- RJ45 (1) - \$35, RJ45 (2) - \$70, RJ45 (3) - \$105, USB (1) - \$70, USB (2) - \$140, RJ45/USB - \$105, RJ45/HDMI - \$190, HDMI/USB - \$205

# Honey.

## Hexagon Workstation Typical Desk with Fixed Worksurface

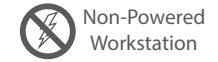
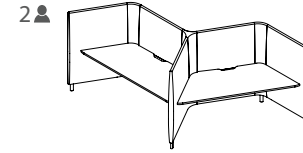
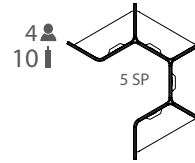
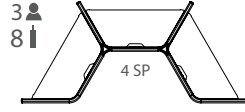
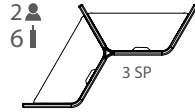

Number of Feet per Typical (MTL10 Option) "SP" Number of Starter Panels per Typical (RSP Option)

[View statement of line](#)

### Product features.

- 5" Solid wood feet - oval shape
- HNY7227WT162 Fixed Desk Height worksurfaces, 29" worksurface height
- Ships KD

### Options.

#### ACCESSORIES

- K28: Articulating Keyboard w/ Mouse - \$390
- K31-SK: Center drawer w/ skirt - \$310
- K31: Center drawer w/o skirt - \$205

#### CONCEALED FLOOR POWER INFEED COVER

- PCEB: White metal finish concealed floor power infeed cover - \$150

#### DELETE TOP

- DFT: Delete fixed top. Deduct \$1125 Veneer(W), \$955 High Pressure Laminate (G), \$630 Thermally Fused Laminate (M) per top

#### METAL FEET

- MTL10: Replace solid wood feet with metal feet, standard MFW White - \$55 ea

#### PREMIUM METAL FINISH

- Specify premium metal finish. MFMB: Matte Black, MFS: Silver, MFSS: Salmon Sienna, MFSA: Surfin Aquavert, MFPS: Pistachio, MFOS: Oyster, MFNA: Navy, MFOL: Olive, MFGB: Grey Beige MFGG: Graphite Gray, MFG: Gray
- Premium metal finish for WMT Wire Management Tray - \$75 ea
- Premium metal finish for MTL10 Metal Feet - \$20 ea
- Premium metal finish for PCEB Concealed Floor Power Infeed Cover - \$35

#### STARTER PANEL

- RSP: Substitute round starter panel in place of flat starter panel. Must substitute all starters, priced per starter panel - \$83 each. See HNY3555SP888

#### WORKSURFACE HEIGHT

- Modify worksurface height to bar height.
- THL-42: Position worksurface at bar height - N/C

#### WIRE TRAY

- WMT: Wire metal tray. Mounts under top and comes standard in MFW White - \$210

1 Select a model w" x d" x h"	PERSON	yardage	Standard Veneer Top Upholstered Panels - COM\$		Premium Veneer Top Upholstered Panels - COM\$		High Pressure Laminate Top Veneer CFTssis		Thermally Fused Laminate Top Upholstered Panels - COM\$	
166 x 145 x 55	4	34	HNY166145FT582W	14561	"P" Option N/A	HNY166145FT582G	13881	HNY166145FT582M	12581	
166 x 74 x 55	3	26	HNY16674FT582W	11215	"P" Option N/A	HNY16674FT582G	10705	HNY16674FT582M	9730	
125 x 74 x 55	2	19	HNY12574FT582W	7869	"P" Option N/A	HNY12574FT582G	7529	HNY12574FT582M	6879	
85 x 37 x 55	1	11	HNY8537FT582W	4523	"P" Option N/A	HNY8537FT582G	4353	HNY8537FT582M	4028	

2 Select a worksurface finish <a href="#">View finish details</a>	WWP	WBW	GEC	LW01	MEC
PO01	WSW		GWL	LW02	MOC
PO02	WEC		LP01	LW04	MSW
PO03	WOW		LP02	LW05	MTW
PO04	WNO		LF01	LW06	MWL
PO05	WSO		LF02	LW07	
PO06			LF03		
PO07			LN01		
PO08			LA01		
PO09			LA02		

3 Select feet finish <a href="#">View finish details</a>	WWP	WBW	WWP	WBW	WWP	WBW
PO01	WSW		PO01	WSW	PO01	WSW
PO02	WEC		PO02	WEC	PO02	WEC
PO03	WOW		PO03	WOW	PO03	WOW
PO04	WNO		PO04	WNO	PO04	WNO
PO05	WSO		PO05	WSO	PO05	WSO
PO06			PO06		PO06	
PO07			PO07		PO07	
PO08			PO08		PO08	
PO09			PO09		PO09	

4 Select a edge <a href="#">View edge details</a>	Cliff-1 Veneer	Cliff-2 Black	Cliff-3 White	Cliff-1 HPL	Cliff-2 Black	Cliff-3 White	Flat-2 Black	Flat-3 White	Flat-4 Matching	Flat-1 Veneer	Flat-2 Black	Flat-3 White

# Honey.

Hexagon Workstation Typical  
Desk with Power Fixed Worksurface

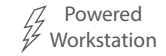
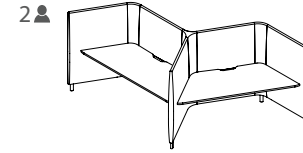
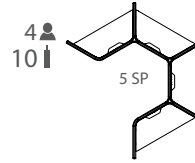
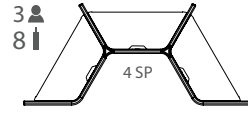
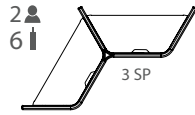

Number of Feet per Typical (MTL10 Option) "SP" Number of Starter Panels per Typical (RSP Option)

1 Select a model w" x d" x h"	PERSON	yardage	Standard Veneer Top Upholstered Panels - COM\$		Premium Veneer Top Upholstered Panels - COM\$		High Pressure Laminate Top Upholstered Panels - COM\$		Thermally Fused Laminate Top Upholstered Panels - COM\$	
166 x 145 x 55	4	34	HNY166145FP582W	16593	"P" Option N/A	HNY166145FP582G	15913	HNY166145FP582M	14613	
166 x 74 x 55	3	26	HNY16674FP582W	12759	"P" Option N/A	HNY16674FP582G	12249	HNY16674FP582M	11274	
125 x 74 x 55	2	19	HNY12574FP582W	8925	"P" Option N/A	HNY12574FP582G	8585	HNY12574FP582M	7935	
85 x 37 x 55	1	11	HNY8537FP582W	5091	"P" Option N/A	HNY8537FP582G	4921	HNY8537FP582M	4596	

2 Select a worksurface finish	Standard Veneer Top		Premium Veneer Top		High Pressure Laminate Top		Thermally Fused Laminate Top	
	WWP	WBW	WWP	WBW	GEC	LW01	MEC	
View finish details	PO01	WSW	PO01	WSW	GWL	LW02	MOC	
Wire Tray Metal finish Standard in MFW White. See premium finishes for options.	PO02	WEC	PO02	WEC	LP01	LW04	MSW	
	PO03	WOW	PO03	WOW	LP02	LW05	MTW	
	PO04	WNO	PO04	WNO	LF01	LW06	MWL	
	PO05	WSO	PO05	WSO	LF02	LW07		
	PO06		PO06		LF03			
	PO07		PO07		LN01			
	PO08		PO08		LA01			
	PO09		PO09		LA02			

3 Select feet finish	Standard Veneer Top		Premium Veneer Top		High Pressure Laminate Top		Thermally Fused Laminate Top	
	WWP	WBW	WWP	WBW	WWP	WBW	WWP	WBW
View finish details	PO01	WSW	PO01	WSW	PO01	WSW	PO01	WSW
	PO02	WEC	PO02	WEC	PO02	WEC	PO02	WEC
	PO03	WOW	PO03	WOW	PO03	WOW	PO03	WOW
	PO04	WNO	PO04	WNO	PO04	WNO	PO04	WNO
	PO05	WSO	PO05	WSO	PO05	WSO	PO05	WSO
	PO06		PO06		PO06		PO06	
	PO07		PO07		PO07		PO07	
	PO08		PO08		PO08		PO08	
	PO09		PO09		PO09		PO09	

4 Select an edge	Standard Veneer Top			Premium Veneer Top			High Pressure Laminate Top			Thermally Fused Laminate Top		
	Cliff-1	Cliff-2	Cliff-3	Cliff-1	Cliff-2	Cliff-3	Flat-2	Flat-3	Flat-4	Flat-2	Flat-3	Flat-4
View edge details	Veneer	Black	White	HPL	Black	White	Black	White	Matching	Black	White	Matching
	Flat-1	Flat-2	Flat-3	Flat-1	Flat-2	Flat-3						
	Veneer	Black	White	HPL	Black	White						

[View statement of line](#)

## Product features.

- HNY7227WT162 Fixed Desk Height worksurfaces, 29" worksurface height
- 5" Solid wood feet - oval shape
- 4 Power outlets with 1 telecom plate, see options below for telecom plate
- Ships KD
- Wire management tray attaches to worksurface top, standard in MFW White, see premium metal finish for options
- Hardwire infeed and jumpers are included in workstations

## Options.

### ACCESSORIES

- K28: Articulating Keyboard w/ Mouse - \$390
- K31-SK: Center drawer w/ skirt - \$310
- K31: Center drawer w/o skirt - \$205

### CONCEALED FLOOR POWER INFEEED COVER

- PCEB: White metal finish concealed floor power infeed cover - \$150

### DELETE TOP AND WIRE TRAY

- DFP: Delete fixed top. Deduct \$1335 Veneer (W), \$1165 High Pressure Laminate (G), \$840 Thermally Fused Laminate (M) per top

### METAL FEET

- MTL10: Replace solid wood feet with metal feet, standard MFW White - \$55 ea

### PREMIUM METAL FINISH

- Specify premium metal finish. MFMB: Matte Black, MFS: Silver, MFSS: Salmon Sienna, MFSA: Surfin Aquavert, MFPS: Pistachio, MFOS: Oyster, MFNA: Navy, MFOL: Olive, MFGB: Grey Beige MFGG: Graphite Gray, MFG: Gray
- Premium metal finish for WMT Wire Management Tray - \$75 ea
- Premium metal finish for MTL10 Metal Feet - \$20 ea
- Premium metal finish for PCEB Concealed Floor Power Infeed Cover - \$35

### STARTER PANEL

- RSP: Substitute round starter panel in place of flat starter panel. Must substitute all starters, priced per starter panel - \$83 each. See HNY3555SP888

### TELECOM PLATES

- Each power unit has 1 plate. All telecom connectors sold separately.
- RJ45 (1) - \$35, RJ45 (2) - \$70, RJ45 (3) - \$105, USB (1) - \$70, USB (2) - \$140, RJ45/USB - \$105, RJ45/HDMI - \$190, HDMI/USB - \$205

### WORKSURFACE HEIGHT

- THL42: Modify worksurface height to bar height - N/C

# Honey.

Hexagon Workstation Typical  
Five Person Workstation with Height Adjustable Worksurface

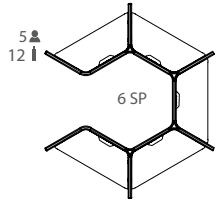

Number of Feet per Typical (MTL10 Option) "SP" Number of Starter Panels per Typical (RSP Option)

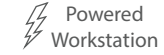
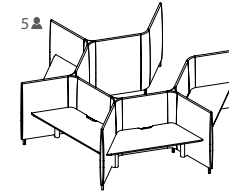

[View statement of line](#)

## Product features.

- 5" Solid wood feet - oval shape, ships KD
- 4 Power outlets with 1 telecom plate, see options below for telecom plate
- Adjustable height from 27" to 47.5" with a maximum weight capacity of 275 lbs. Lift standard in MFW White, optional MFB Black
- HNY7227WT163 Height Adjustable worksurfaces are included
- Wire management tray attaches to worksurface top, standard in MFW White, see premium metal finish for options

### NOTES

- 1" Gap between worksurface and panels to drop wires below worksurface
- Metal parts include 5 year warranty
- Programmable height adjustable mechanism, motor includes 2 year warranty

## Options.

### ACCESSORIES

- K28: Articulating Keyboard w/ Mouse - \$390
- K31-SK: Center drawer w/ skirt - \$310
- K31: Center drawer w/o skirt - \$205

### CONCEALED FLOOR POWER INFEED COVER

- PCEB: White metal finish concealed floor power infeed cover - \$150

### DELETE TOP AND WIRE TRAY

- DHAT: Delete height adjustable top. Deduct \$3265 Veneer(W), \$3095 High Pressure Laminate(G), \$2770 Thermally Fused Laminate(M) per top

### METAL FEET

- MTL10: Replace solid wood feet with metal feet, standard MFW White - \$55 ea

### PREMIUM METAL FINISH

- Specify premium metal finish. MFMB: Matte Black, MFS: Silver, MFSS: Salmon Sienna, MFSA: Surfing Aquavert, MFPS: Pistachio, MFOS: Oyster, MFNA: Navy, MFOL: Olive, MFGB: Grey Beige MFGG: Graphite Gray, MFG: Gray
- Premium metal finish for WMT Wire Management Tray - \$75 ea
- Premium metal finish for MTL10 Metal Feet - \$20 ea
- Premium metal finish for PCEB Concealed Floor Power Infeed Cover - \$35

### STARTER PANEL

- RSP: Substitute round starter panel in place of flat starter panel. Must substitute all starters, priced per starter panel - \$83 each. See HNY3555SP888

### TELECOM PLATES

- Each power unit has 1 plate. All telecom connectors sold separately.
- RJ45 (1) - \$35, RJ45 (2) - \$70, RJ45 (3) - \$105, USB (1) - \$70, USB (2) - \$140, RJ45/USB - \$105, RJ45/HDMI - \$190, HDMI/USB - \$205

1 Select a model w" x d" x h"	PERSON	yardage	Standard Veneer Top Upholstered Panels - COM\$	Premium Veneer Top Upholstered Panels - COM\$	High Pressure Laminate Top Upholstered Panels - COM\$	Thermally Fused Laminate Top Upholstered Panels - COM\$
166 x 145 x 55	5	41	HNY166145HA583W 30077	"P" Option N/A	HNY166145HA583G 29227	HNY166145HA583M 27602

2 Select a worksurface finish <a href="#">View finish details</a>	Metal finish Height adjustable column standard in MFW White. Optional MFB Black.	WWP	WBW	GEC	LW01	MEC
PO01	WSW			GWL	LW02	MOC
PO02	WEC			LP01	LW04	MSW
PO03	WOW			LP02	LW05	MTW
PO04	WNO			LF01	LW06	MWL
PO05	WSO			LF02	LW07	
PO06				LF03		
PO07				LN01		
PO08				LA01		
PO09				LA02		

3 Select feet finish <a href="#">View finish details</a>	WWP	WBW	WWP	WBW	WWP	WBW
PO01	WSW		PO01	WSW	PO01	WSW
PO02	WEC		PO02	WEC	PO02	WEC
PO03	WOW		PO03	WOW	PO03	WOW
PO04	WNO		PO04	WNO	PO04	WNO
PO05	WSO		PO05	WSO	PO05	WSO
PO06			PO06		PO06	
PO07			PO07		PO07	
PO08			PO08		PO08	
PO09			PO09		PO09	

  

4 Select an edge <a href="#">View edge details</a>	Cliff-1 Veneer	Cliff-2 Black	Cliff-3 White	Cliff-1 HPL	Cliff-2 Black	Cliff-3 White	Flat-2 Black	Flat-3 White	Flat-4 Matching	Flat-1 Veneer	Flat-2 Black	Flat-3 White



# Honey.

## Hexagon Workstation Typical Five Person Workstation with Fixed Worksurface

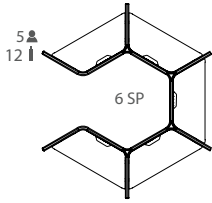

Number of Feet per Typical (MTL10 Option) "SP" Number of Starter Panels per Typical (RSP Option)

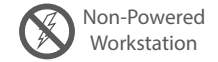
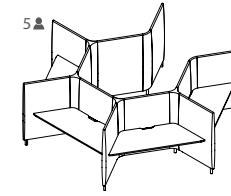

[View statement of line](#)

### Product features.

- 5" Solid wood feet - oval shape
- HNY7227WT162 Fixed Desk Height worksurfaces, 29" worksurface height
- Ships KD

### Options.

#### ACCESSORIES

- K28: Articulating Keyboard w/ Mouse - \$390
- K31-SK: Center drawer w/ skirt - \$310
- K31: Center drawer w/o skirt - \$205

#### CONCEALED FLOOR POWER INFEED COVER

- PCEB: White metal finish concealed floor power infeed cover - \$150

#### DELETE TOP

- DFT: Delete fixed top. Deduct \$1125 Veneer(W), \$955 High Pressure Laminate (G), \$630 Thermally Fused Laminate (M) per top

#### METAL FEET

- MTL10: Replace soild wood feet with metal feet, standard MFW White - \$55 ea

#### PREMIUM METAL FINISH

- Specify premium metal finish. MFMB: Matte Black, MFS: Silver, MFSS: Salmon Sienna, MFSA: Surfin Aquavert, MFPS: Pistachio, MFOS: Oyster, MFNA: Navy, MFOL: Olive, MFGB: Grey Beige MFGG: Graphite Gray, MFG: Gray
- Premium metal finish for WMT Wire Management Tray - \$75 ea
- Premium metal finish for MTL10 Metal Feet - \$20 ea
- Premium metal finish for PCEB Concealed Floor Power Infeed Cover - \$35

#### STARTER PANEL

- RSP: Substitute round starter panel in place of flat starter panel. Must substitute all starters, priced per starter panel - \$83 each. See HNY3555SP888

#### WORKSURFACE HEIGHT

- Modify worksurface height to bar height.
- THL-42: Position worksurface at bar height - N/C

#### WIRE TRAY

- WMT: Wire metal tray. Mounts under top and comes standard in MFW White - \$210

1 Select a model w" x d" x h"	PERSON	yardage	Standard Veneer Top Upholstered Panels - COM\$	Premium Veneer Top Upholstered Panels - COM\$	High Pressure Laminate Top Upholstered Panels - COM\$	Thermally Fused Laminate Top Upholstered Panels - COM\$
166 x 145 x 55	5	41	HNY166145FT583W 17907	"P" Option N/A	HNY166145FT583G 17057	HNY166145FT583M 15432

2 Select a worksurface finish <a href="#">View finish details</a>	WWP	WBW	GEC	LW01	MEC
PO01	WSW		GWL	LW02	MOC
PO02	WEC		LP01	LW04	MSW
PO03	WOW		LP02	LW05	MTW
PO04	WNO		LF01	LW06	MWL
PO05	WSO		LF02	LW07	
PO06			LF03		
PO07			LN01		
PO08			LA01		
PO09			LA02		

3 Select feet finish <a href="#">View finish details</a>	WWP	WBW	WWP	WBW	WWP	WBW
PO01	WSW		PO01	WSW	PO01	WSW
PO02	WEC		PO02	WEC	PO02	WEC
PO03	WOW		PO03	WOW	PO03	WOW
PO04	WNO		PO04	WNO	PO04	WNO
PO05	WSO		PO05	WSO	PO05	WSO
PO06			PO06		PO06	
PO07			PO07		PO07	
PO08			PO08		PO08	
PO09			PO09		PO09	

4 Select a edge <a href="#">View edge details</a>	Cliff-1 Veneer	Cliff-2 Black	Cliff-3 White	Cliff-1 HPL	Cliff-2 Black	Cliff-3 White	Flat-2 Black	Flat-3 White	Flat-4 Matching	Flat-1 Veneer	Flat-2 Black	Flat-3 White

# Honey.

Hexagon Workstation Typical  
Five Person Workstation with Power Fixed Worksurface

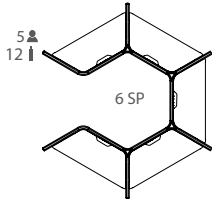

Number of Feet per Typical (MTL10 Option) "SP" Number of Starter Panels per Typical (RSP Option)

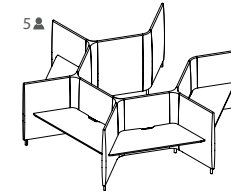

[View statement of line](#)

## Product features.

- HNY7227WT162 Fixed Desk Height worksurfaces, 29" worksurface height
- 5" Solid wood feet - oval shape
- 4 Power outlets with 1 telecom plate, see options below for telecom plate
- Ships KD
- Wire management tray attaches to worksurface top, standard in MFW White, see premium metal finish for options
- Hardwire infeed and jumpers are included in workstations

## Options.

### ACCESSORIES

- K28: Articulating Keyboard w/ Mouse - \$390
- K31-SK: Center drawer w/ skirt - \$310
- K31: Center drawer w/o skirt - \$205

### CONCEALED FLOOR POWER INFEEED COVER

- PCEB: White metal finish concealed floor power infeed cover - \$150

### DELETE TOP AND WIRE TRAY

- DFP: Delete fixed top. Deduct \$1335 Veneer (W), \$1165 High Pressure Laminate (G), \$840 Thermally Fused Laminate (M) per top

### METAL FEET

- MTL10: Replace soild wood feet with metal feet, standard MFW White - \$55 ea

### PREMIUM METAL FINISH

- Specify premium metal finish. MFMB: Matte Black, MFS: Silver, MFSS: Salmon Sienna, MFSA: Surfin Aquavert, MFPS: Pistachio, MFOS: Oyster, MFNA: Navy, MFOL: Olive, MFGB: Grey Beige MFGG: Graphite Gray, MFG: Gray
- Premium metal finish for WMT Wire Management Tray - \$75 ea
- Premium metal finish for MTL10 Metal Feet - \$20 ea
- Premium metal finish for PCEB Concealed Floor Power Infeed Cover - \$35

### STARTER PANEL

- RSP: Substitute round starter panel in place of flat starter panel. Must substitute all starters, priced per starter panel - \$83 each. See HNY3555SP888

### TELECOM PLATES

- Each power unit has 1 plate. All telecom connectors sold separately.
- RJ45 (1) - \$35, RJ45 (2) - \$70, RJ45 (3) - \$105, USB (1) - \$70, USB (2) - \$140, RJ45/USB - \$105, RJ45/HDMI - \$190, HDMI/USB - \$205

### WORKSURFACE HEIGHT

- THL-42: Modify worksurface height to bar height - N/C

1 Select a model w" x d" x h"	PERSON	yardage	Standard Veneer Top Upholstered Panels - COM\$	Premium Veneer Top Upholstered Panels - COM\$	High Pressure Laminate Top Upholstered Panels - COM\$	Thermally Fused Laminate Top Upholstered Panels - COM\$
166 x 145 x 55	5	41	HNY166145FP583W 20427	"P" Option N/A	HNY166145FP583G 19577	HNY166145FP583M 17952

2 Select a worksurface finish <a href="#">View finish details</a>	WWP	WBW	GEC	LW01	MEC
Wire Tray Metal finish Standard in MFW White. See premium finishes for options.	PO01 WSW	PO02 WEC	GWL LW02	LW03	MOC
	PO03 WOW	PO04 WNO	LP01 LW04	LP02 LW05	MSW
	PO04 WNO	PO05 WSO	LF01 LW06	LF02 LW07	MTW
	PO06		LF03		MWL
	PO07		LN01		
	PO08		LA01		
	PO09		LA02		

3 Select feet finish <a href="#">View finish details</a>	WWP	WBW	WWP	WBW	WWP	WBW
	PO01 WSW	PO02 WEC	PO01 WSW	PO02 WEC	PO01 WSW	PO02 WEC
	PO03 WOW	PO04 WNO	PO03 WOW	PO04 WNO	PO03 WOW	PO04 WNO
	PO04 WNO	PO05 WSO	PO04 WNO	PO05 WSO	PO04 WNO	PO05 WSO
	PO06		PO06		PO06	
	PO07		PO07		PO07	
	PO08		PO08		PO08	
	PO09		PO09		PO09	

4 Select a edge <a href="#">View edge details</a>	Cliff-1 Veneer	Cliff-2 Black	Cliff-3 White	Cliff-1 HPL	Cliff-2 Black	Cliff-3 White	Flat-2 Black	Flat-3 White	Flat-4 Matching	Flat-1 Veneer	Flat-2 Black	Flat-3 White

# Honey.

Hexagon Workstation Typical  
Six Person Workstation with Height Adjustable Worksurface

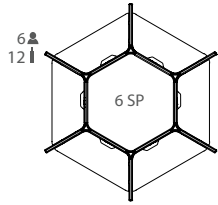

Number of Feet per Typical (MTL10 Option) "SP" Number of Starter Panels per Typical (RSP Option)

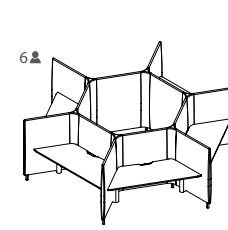

[View statement of line](#)

## Product features.

- 5" Solid wood feet - oval shape, ships KD
- 4 Power outlets with 1 telecom plate, see options below for telecom plate
- Adjustable height from 27" to 47.5" with a maximum weight capacity of 275 lbs. Lift standard in MFW White, optional MFB Black
- HNY7227WT163 Height Adjustable worksurfaces are included
- Wire management tray attaches to worksurface top, standard in MFW White, see premium metal finish for options

### NOTES

- 1" Gap between worksurface and panels to drop wires below worksurface
- Metal parts include 5 year warranty
- Programmable height adjustable mechanism, motor includes 2 year warranty

## Options.

### ACCESSORIES

- K28: Articulating Keyboard w/ Mouse - \$390
- K31-SK: Center drawer w/ skirt - \$310
- K31: Center drawer w/o skirt - \$205

### CONCEALED FLOOR POWER INFEED COVER

- PCEB: White metal finish concealed floor power infeed cover - \$150

### DELETE TOP AND WIRE TRAY

- DHAT: Delete height adjustable top. Deduct \$3265 Veneer(W), \$3095 High Pressure Laminate(G), \$2770 Thermally Fused Laminate(M) per top

### METAL FEET

- MTL10: Replace solid wood feet with metal feet, standard MFW White - \$55 ea

### PREMIUM METAL FINISH

- Specify premium metal finish. MFMB: Matte Black, MFS: Silver, MFSS: Salmon Sienna, MFSA: Surfing Aquavert, MFPS: Pistachio, MFOS: Oyster, MFNA: Navy, MFOL: Olive, MFGB: Grey Beige MFGG: Graphite Gray, MFG: Gray
- Premium metal finish for WMT Wire Management Tray - \$75 ea
- Premium metal finish for MTL10 Metal Feet - \$20 ea
- Premium metal finish for PCEB Concealed Floor Power Infeed Cover - \$35

### STARTER PANEL

- RSP: Substitute round starter panel in place of flat starter panel. Must substitute all starters, priced per starter panel - \$83 each. See HNY3555SP888

### TELECOM PLATES

- Each power unit has 1 plate. All telecom connectors sold separately.
- RJ45 (1) - \$35, RJ45 (2) - \$70, RJ45 (3) - \$105, USB (1) - \$70, USB (2) - \$140, RJ45/USB - \$105, RJ45/HDMI - \$190, HDMI/USB - \$205

1 Select a model w" x d" x h"	PERSON	yardage	Standard Veneer Top Upholstered Panels - COM\$	Premium Veneer Top Upholstered Panels - COM\$	High Pressure Laminate Top Upholstered Panels - COM\$	Thermally Fused Laminate Top Upholstered Panels - COM\$
166 x 145 x 55	6	45	HNY166145HA584W 34664	"P" Option N/A	HNY166145HA584G 33644	HNY166145HA584M 31694

2 Select a worksurface finish <a href="#">View finish details</a>	Metal finish	Height adjustable column standard in MFW White. Optional MFB Black.	WWP	WBW	GEC	LW01	MEC
PO01	WSW						MOC
PO02	WEC						MSW
PO03	WOW						MTW
PO04	WNO						MWL
PO05	WSO						
PO06							
PO07							
PO08							
PO09							

3 Select feet finish <a href="#">View finish details</a>	WWP	WBW	WWP	WBW	WWP	WBW
PO01	WSW		PO01	WSW	PO01	WSW
PO02	WEC		PO02	WEC	PO02	WEC
PO03	WOW		PO03	WOW	PO03	WOW
PO04	WNO		PO04	WNO	PO04	WNO
PO05	WSO		PO05	WSO	PO05	WSO
PO06			PO06		PO06	
PO07			PO07		PO07	
PO08			PO08		PO08	
PO09			PO09		PO09	

4 Select an edge <a href="#">View edge details</a>	Cliff-1 Veneer	Cliff-2 Black	Cliff-3 White	Flat-1 Veneer	Flat-2 Black	Flat-3 White	Cliff-1 HPL	Cliff-2 Black	Cliff-3 White	Flat-2 Black	Flat-3 White	Flat-4 Matching

# Honey.

Hexagon Workstation Typical  
Six Person Workstation with Fixed Worksurface

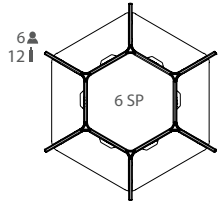

Number of Feet per Typical (MTL10 Option) "SP" Number of Starter Panels per Typical (RSP Option)

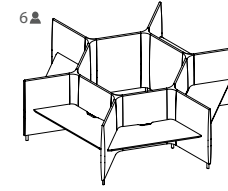

Fixed Top Workstation



Non-Powered Workstation

[View statement of line](#)

## Product features.

- 5" Solid wood feet - oval shape
- HNY7227WT162 Fixed Desk Height worksurfaces, 29" worksurface height
- Ships KD

## Options.

### ACCESSORIES

- K28: Articulating Keyboard w/ Mouse - \$390
- K31-SK: Center drawer w/ skirt - \$310
- K31: Center drawer w/o skirt - \$205

### CONCEALED FLOOR POWER INFEED COVER

- PCEB: White metal finish concealed floor power infeed cover - \$150

### DELETE TOP

- DFT: Delete fixed top. Deduct \$1125 Veneer(W), \$955 High Pressure Laminate (G), \$630 Thermally Fused Laminate (M) per top

### METAL FEET

- MTL10: Replace soild wood feet with metal feet, standard MFW White - \$55 ea

### PREMIUM METAL FINISH

- Specify premium metal finish. MFMB: Matte Black, MFS: Silver, MFSS: Salmon Sienna, MFSA: Surfin Aquavert, MFPS: Pistachio, MFOS: Oyster, MFNA: Navy, MFOL: Olive, MFGB: Grey Beige MFGG: Graphite Gray, MFG: Gray
- Premium metal finish for WMT Wire Management Tray - \$75 ea
- Premium metal finish for MTL10 Metal Feet - \$20 ea
- Premium metal finish for PCEB Concealed Floor Power Infeed Cover - \$35

### STARTER PANEL

- RSP: Substitute round starter panel in place of flat starter panel. Must substitute all starters, priced per starter panel - \$83 each. See HNY3555SP888

### WORKSURFACE HEIGHT

- Modify worksurface height to bar height.
- THL-42: Position worksurface at bar height - N/C

### WIRE TRAY

- WMT: Wire metal tray. Mounts under top and comes standard in MFW White - \$210

1 Select a model w" x d" x h"	PERSON	yardage	Standard Veneer Top Upholstered Panels - COM\$	Premium Veneer Top Upholstered Panels - COM\$	High Pressure Laminate Top Upholstered Panels - COM\$	Thermally Fused Laminate Top Upholstered Panels - COM\$
166 x 145 x 55	6	45	HNY166145FT584W 20076	"P" Option N/A	HNY166145FT584G 19056	HNY166145FT584M 17106

2 Select a worksurface finish <a href="#">View finish details</a>	WWP	WBW	GEC	LW01	MEC
PO01	WSW	WEC	GWL	LW02	MOC
PO02	WEC	WOW	LP01	LW04	MSW
PO03	WOW	WNO	LP02	LW05	MTW
PO04	WNO	WSO	LF01	LW06	MWL
PO05	WSO		LF02	LW07	
PO06			LF03		
PO07			LN01		
PO08			LA01		
PO09			LA02		

3 Select feet finish <a href="#">View finish details</a>	WWP	WBW	WWP	WBW	WWP	WBW
PO01	WSW	WEC	PO01	WSW	PO01	WSW
PO02	WEC	WOW	PO02	WEC	PO02	WEC
PO03	WOW	WNO	PO03	WOW	PO03	WOW
PO04	WNO	WSO	PO04	WNO	PO04	WNO
PO05	WSO		PO05	WSO	PO05	WSO
PO06			PO06		PO06	
PO07			PO07		PO07	
PO08			PO08		PO08	
PO09			PO09		PO09	

4 Select a edge <a href="#">View edge details</a>	Cliff-1 Veneer	Cliff-2 Black	Cliff-3 White	Cliff-1 HPL	Cliff-2 Black	Cliff-3 White	Flat-2 Black	Flat-3 White	Flat-4 Matching	Flat-1 Veneer	Flat-2 Black	Flat-3 White

# Honey.

## Hexagon Workstation Typical Six Person Workstation with Power Fixed Worksurface

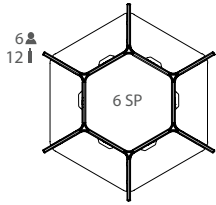

Number of Feet per Typical (MTL10 Option) "SP" Number of Starter Panels per Typical (RSP Option)

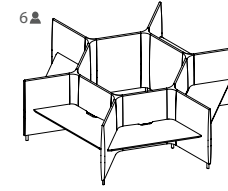

Fixed Top Workstation

Powered Workstation

[View statement of line](#)

## Product features.

- HNY7227WT162 Fixed Desk Height worksurfaces, 29" worksurface height
- 5" Solid wood feet - oval shape
- 4 Power outlets with 1 telecom plate, see options below for telecom plate
- Ships KD
- Wire management tray attaches to worksurface top, standard in MFW White, see premium metal finish for options
- Hardwire infeed and jumpers are included in workstations

## Options.

### ACCESSORIES

- K28: Articulating Keyboard w/ Mouse - \$390
- K31-SK: Center drawer w/ skirt - \$310
- K31: Center drawer w/o skirt - \$205

### CONCEALED FLOOR POWER INFEED COVER

- PCEB: White metal finish concealed floor power infeed cover - \$150

### DELETE TOP AND WIRE TRAY

- DFP: Delete fixed top. Deduct \$1335 Veneer (W), \$1165 High Pressure Laminate (G), \$840 Thermally Fused Laminate (M) per top

### METAL FEET

- MTL10: Replace solid wood feet with metal feet, standard MFW White - \$55 ea

### PREMIUM METAL FINISH

- Specify premium metal finish. MFMB: Matte Black, MFS: Silver, MFSS: Salmon Sienna, MFSA: Surfing Aquavert, MFPS: Pistachio, MFOS: Oyster, MFNA: Navy, MFOL: Olive, MFGB: Grey Beige MFGG: Graphite Gray, MFG: Gray
- Premium metal finish for WMT Wire Management Tray - \$75 ea
- Premium metal finish for MTL10 Metal Feet - \$20 ea
- Premium metal finish for PCEB Concealed Floor Power Infeed Cover - \$35

### STARTER PANEL

- RSP: Substitute round starter panel in place of flat starter panel. Must substitute all starters, priced per starter panel - \$83 each. See HNY3555SP888

### TELECOM PLATES

- Each power unit has 1 plate. All telecom connectors sold separately.
- RJ45 (1) - \$35, RJ45 (2) - \$70, RJ45 (3) - \$105, USB (1) - \$70, USB (2) - \$140, RJ45/USB - \$105, RJ45/HDMI - \$190, HDMI/USB - \$205

### WORKSURFACE HEIGHT

- THL-42: Modify worksurface height to bar height - N/C

1 Select a model w" x d" x h"	PERSON	yardage	Standard Veneer Top Upholstered Panels - COM\$	Premium Veneer Top Upholstered Panels - COM\$	High Pressure Laminate Top Upholstered Panels - COM\$	Thermally Fused Laminate Top Upholstered Panels - COM\$
166 x 145 x 55	6	45	HNY166145FP584W 23084	"P" Option N/A	HNY166145FP584G 22064	HNY166145FP584M 20114

2 Select a worksurface finish <a href="#">View finish details</a>	WWP	WBW	GEC	LW01	MEC
Wire Tray Metal finish Standard in MFW White. See premium finishes for options.	PO01 WSW	PO02 WEC	GWL LW02	LW03	MOC
	PO03 WOW	PO04 WNO	LP01 LW04	LP02 LW05	MSW
	PO04 WNO	PO05 WSO	LF01 LW06	LF02 LW07	MTW
	PO05 WSO	PO06	LF03	LN01	MWL
	PO06	PO07	LA01	LA02	
	PO07	PO08			
	PO08	PO09			
	PO09				

3 Select feet finish <a href="#">View finish details</a>	WWP	WBW	WWP	WBW	WWP	WBW
	PO01 WSW	PO02 WEC	PO01 WSW	PO02 WEC	PO01 WSW	PO02 WEC
	PO02 WEC	PO03 WOW	PO02 WEC	PO03 WOW	PO02 WEC	PO03 WOW
	PO03 WOW	PO04 WNO	PO03 WOW	PO04 WNO	PO03 WOW	PO04 WNO
	PO04 WNO	PO05 WSO	PO04 WNO	PO05 WSO	PO04 WNO	PO05 WSO
	PO05 WSO	PO06	PO05 WSO	PO06	PO05 WSO	PO06
	PO06	PO07	PO06	PO07	PO06	PO07
	PO07	PO08	PO07	PO08	PO07	PO08
	PO08	PO09	PO08	PO09	PO08	PO09
	PO09		PO09		PO09	

4 Select an edge <a href="#">View edge details</a>	Cliff-1 Veneer	Cliff-2 Black	Cliff-3 White	Flat-2 Black	Flat-3 White	Flat-4 Matching
	Cliff-1 Veneer	Cliff-2 Black	Cliff-3 White	Flat-2 Black	Flat-3 White	Flat-4 Matching
	Flat-1 Veneer	Flat-2 Black	Flat-3 White	Flat-1 HPL	Flat-2 Black	Flat-3 White

# Honey.

## Linear Workstation Typical Desk with Height Adjustable Worksurface

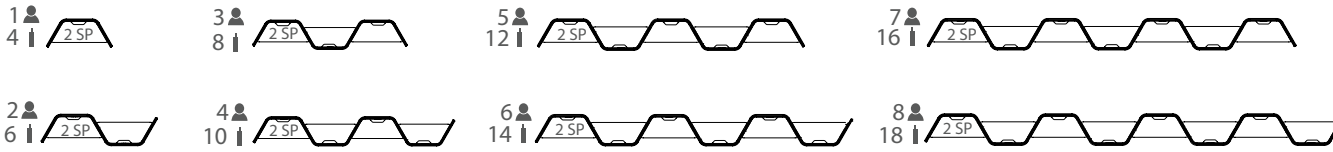

Number of Feet per Typical (MTL10 Option) "SP" Number of Starter Panels per Typical (RSP Option)

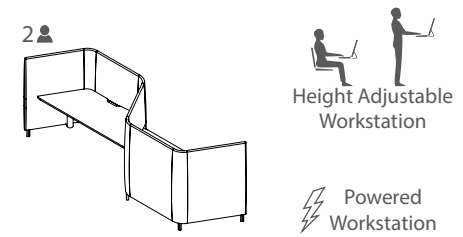

[View statement of line](#)

## Product features.

- 5" Solid wood feet - oval shape, ships KD
- 4 Power outlets with 1 telecom plate, see options below for telecom plate
- Adjustable height from 27" to 47.5" with a maximum weight capacity of 275 lbs. Lift standard in MFW White, optional MFB Black
- HNY7227WT163 Height Adjustable worksurfaces are included
- Wire management tray attaches to worksurface top, standard in MFW White, see premium metal finish for options

### NOTES

- 1" Gap between worksurface and panels to drop wires below worksurface
- Metal parts include 5 year warranty
- Programmable height adjustable mechanism, motor includes 2 year warranty

## Options.

### ACCESSORIES

- K28: Articulating Keyboard w/ Mouse - \$390
- K31-SK: Center drawer w/ skirt - \$310
- K31: Center drawer w/o skirt - \$205

### CONCEALED FLOOR POWER INFEED COVER

- PCEB: White metal finish concealed floor power infeed cover - \$150

### DELETE TOP AND WIRE TRAY

- DHAT: Delete height adjustable top. Deduct \$3265 Veneer(W), \$3095 High Pressure Laminate(G), \$2770 Thermally Fused Laminate(M) per top

### METAL FEET

- MTL10: Replace solid wood feet with metal feet, standard MFW White - \$55 ea

### PREMIUM METAL FINISH

- Specify premium metal finish. MFMB: Matte Black, MFS: Silver, MFSS: Salmon Sienna, MFSA: Surfing Aquavert, MFPS: Pistachio, MFOS: Oyster, MFNA: Navy, MFOL: Olive, MFGB: Grey Beige MFGG: Graphite Gray, MFG: Gray
- Premium metal finish for WMT Wire Management Tray - \$75 ea
- Premium metal finish for MTL10 Metal Feet - \$20 ea
- Premium metal finish for PCEB Concealed Floor Power Infeed Cover - \$35

### STARTER PANEL

- RSP: Substitute round starter panel in place of flat starter panel. Must substitute all starters, priced per starter panel - \$83 each. See HNY3555SP888

### TELECOM PLATES

- Each power unit has 1 plate. All telecom connectors sold separately.
- RJ45 (1) - \$35, RJ45 (2) - \$70, RJ45 (3) - \$105, USB (1) - \$70, USB (2) - \$140, RJ45/USB - \$105, RJ45/HDMI - \$190, HDMI/USB - \$205

1 Select a model w" x d" x h"	PERSON	yardage	Standard Veneer Top Upholstered Panels - COM\$		Premium Veneer Top Upholstered Panels - COM\$		High Pressure Laminate Top Upholstered Panels - COM\$		Thermally Fused Laminate Top Upholstered Panels - COM\$	
539 x 41 x 55	8	67	HNY53941HA585W	51072	"P" Option N/A	HNY53941HA585G	49712	HNY53941HA585M	47112	
474 x 41 x 55	7	59	HNY47441HA585W	44779	"P" Option N/A	HNY47441HA585G	43589	HNY47441HA585M	43589	
409 x 41 x 55	6	51	HNY40941HA585W	38486	"P" Option N/A	HNY40941HA585G	37466	HNY40941HA585M	35516	
345 x 41 x 55	5	43	HNY34541HA585W	32193	"P" Option N/A	HNY34541HA585G	31343	HNY34541HA585M	29718	
280 x 41 x 55	4	35	HNY28041HA585W	25900	"P" Option N/A	HNY28041HA585G	25220	HNY28041HA585M	23920	
215 x 41 x 55	3	27	HNY21541HA585W	19607	"P" Option N/A	HNY21541HA585G	19097	HNY21541HA585M	18122	
150 x 41 x 55	2	19	HNY15041HA585W	13314	"P" Option N/A	HNY15041HA585G	12974	HNY15041HA585M	12324	
85 x 37 x 55	1	11	HNY8537HA585W	7021	"P" Option N/A	HNY8537HA585G	6851	HNY8537HA585M	6526	

2 Select a worksurface finish <a href="#">View finish details</a>	Metal finish		GEC	LW01	MEC
	WWP	WBW			
Height adjustable column standard in MFW White. Optional MFB Black.	PO01	WSW	GWL	LW02	MOC
	PO02	WEC	LP01	LW04	MSW
	PO03	WOW	LP02	LW05	MTW
	PO04	WNO	LF01	LW06	MWL
	PO05	WSO	LF02	LW07	
	PO06		LF03		
	PO07		LN01		
	PO08		LA01		
	PO09		LA02		

3 Select feet finish <a href="#">View finish details</a>	Metal finish		WWP	WBW	WWP	WBW
	WWP	WBW				
	PO01	WSW	PO01	WSW	PO01	WSW
	PO02	WEC	PO02	WEC	PO02	WEC
	PO03	WOW	PO03	WOW	PO03	WOW
	PO04	WNO	PO04	WNO	PO04	WNO
	PO05	WSO	PO05	WSO	PO05	WSO
	PO06		PO06		PO06	
	PO07		PO07		PO07	
	PO08		PO08		PO08	
	PO09		PO09		PO09	

4 Select a edge <a href="#">View edge details</a>	Cliff			Flat		
	Cliff-1 Veneer	Cliff-2 Black	Cliff-3 White	Flat-1 Veneer	Flat-2 Black	Flat-3 White

# Honey.

## Linear Workstation Typical Desk with Fixed Worksurface

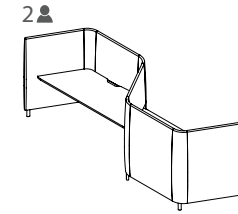
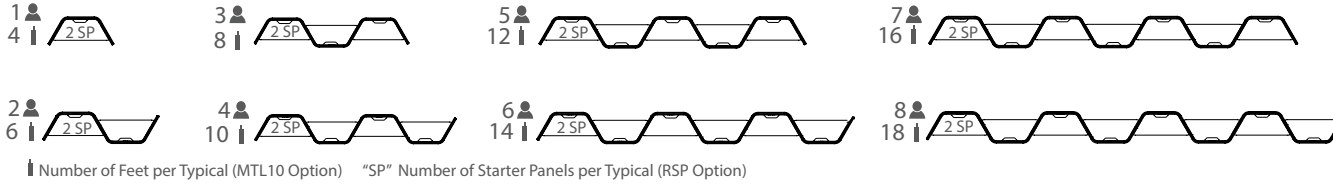

2  
Fixed Top  
Workstation



Non-Powered  
Workstation

[View statement of line](#)

## Product features.

- 5" Solid wood feet - oval shape
- HNY7227WT162 Fixed Desk Height worksurfaces, 29" worksurface height
- Ships KD

## Options.

### ACCESSORIES

- K28: Articulating Keyboard w/ Mouse - \$390
- K31-SK: Center drawer w/ skirt - \$310
- K31: Center drawer w/o skirt - \$205

### CONCEALED FLOOR POWER INFEED COVER

- PCEB: White metal finish concealed floor power infeed cover - \$150

### DELETE TOP

- DFT: Delete fixed top. Deduct \$1125 Veneer(W), \$955 High Pressure Laminate (G), \$630 Thermally Fused Laminate (M) per top

### METAL FEET

- MTL10: Replace solid wood feet with metal feet, standard MFW White - \$55 ea

### PREMIUM METAL FINISH

- Specify premium metal finish. MFMB: Matte Black, MFS: Silver, MFSS: Salmon Sienna, MFSA: Surfin Aquavert, MFPS: Pistachio, MFOS: Oyster, MFNA: Navy, MFOL: Olive, MFGB: Grey Beige MFGG: Graphite Gray, MFG: Gray
- Premium metal finish for WMT Wire Management Tray - \$75 ea
- Premium metal finish for MTL10 Metal Feet - \$20 ea
- Premium metal finish for PCEB Concealed Floor Power Infeed Cover - \$35

### STARTER PANEL

- RSP: Substitute round starter panel in place of flat starter panel. Must substitute all starters, priced per starter panel - \$83 each. See HNY3555SP888

### WORKSURFACE HEIGHT

- Modify worksurface height to bar height.
- THL-42: Position worksurface at bar height - N/C

### WIRE TRAY

- WMT: Wire metal tray. Mounts under top and comes standard in MFW White - \$210

1 Select a model w" x d" x h"	PERSON	yardage	Standard Veneer Top Upholstered Panels - COM\$		Premium Veneer Top Upholstered Panels - COM\$		High Pressure Laminate Top Upholstered Panels - COM\$		Thermally Fused Laminate Top Upholstered Panels - COM\$	
539 x 41 x 55	8	67	HNY53941FT585W	30878	"P" Option N/A	HNY53941FT585G	29518	HNY53941FT585M	26918	
474 x 41 x 55	7	59	HNY47441FT585W	27113	"P" Option N/A	HNY47441FT585G	25923	HNY47441FT585M	23648	
409 x 41 x 55	6	51	HNY40941FT585W	23348	"P" Option N/A	HNY40941FT585G	22328	HNY40941FT585M	20378	
345 x 41 x 55	5	43	HNY34541FT585W	19583	"P" Option N/A	HNY34541FT585G	18733	HNY34541FT585M	17108	
280 x 41 x 55	4	35	HNY28041FT585W	15818	"P" Option N/A	HNY28041FT585G	15138	HNY28041FT585M	13838	
215 x 41 x 55	3	27	HNY21541FT585W	12053	"P" Option N/A	HNY21541FT585G	11543	HNY21541FT585M	10568	
150 x 41 x 55	2	19	HNY15041FT585W	8288	"P" Option N/A	HNY15041FT585G	7948	HNY15041FT585M	7298	
85 x 37 x 55	1	11	HNY8537FT585W	4523	"P" Option N/A	HNY8537FT585G	4353	HNY8537FT585M	4028	

2 Select a worksurface finish <a href="#">View finish details</a>								
WWP	WBW	GEC	LW01	MEC				
PO01	WSW	GWL	LW02	MOC				
PO02	WEC	LP01	LW04	MSW				
PO03	WOW	LP02	LW05	MTW				
PO04	WNO	LF01	LW06	MWL				
PO05	WSO	LF02	LW07					
PO06		LF03						
PO07		LN01						
PO08		LA01						
PO09		LA02						

3 Select feet finish <a href="#">View finish details</a>								
WWP	WBW	WWP	WBW	WWP	WBW			
PO01	WSW	PO01	WSW	PO01	WSW			
PO02	WEC	PO02	WEC	PO02	WEC			
PO03	WOW	PO03	WOW	PO03	WOW			
PO04	WNO	PO04	WNO	PO04	WNO			
PO05	WSO	PO05	WSO	PO05	WSO			
PO06		PO06		PO06				
PO07		PO07		PO07				
PO08		PO08		PO08				
PO09		PO09		PO09				

4 Select an edge <a href="#">View edge details</a>									
Cliff-1 Veneer	Cliff-2 Black	Cliff-3 White	Cliff-1 HPL	Cliff-2 Black	Cliff-3 White	Flat-2 Black	Flat-3 White	Flat-4 Matching	
Flat-1 Veneer	Flat-2 Black	Flat-3 White	Flat-1 HPL	Flat-2 Black	Flat-3 White				

# Honey.

## Linear Workstation Typical Desk with Power Fixed Worksurface

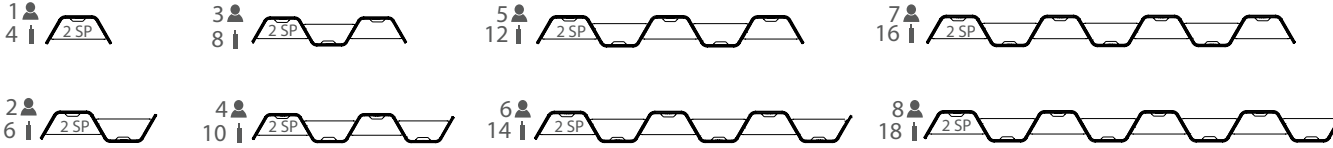

Number of Feet per Typical (MTL10 Option) "SP" Number of Starter Panels per Typical (RSP Option)

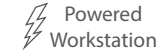
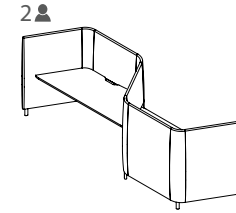

[View statement of line](#)

## Product features.

- HNY7227WT162 Fixed Desk Height worksurfaces, 29" worksurface height
- 5" Solid wood feet - oval shape
- 4 Power outlets with 1 telecom plate, see options below for telecom plate
- Ships KD
- Wire management tray attaches to worksurface top, standard in MFW White, see premium metal finish for options
- Hardwire infeed and jumpers are included in workstations

## Options.

### ACCESSORIES

- K28: Articulating Keyboard w/ Mouse - \$390
- K31-SK: Center drawer w/ skirt - \$310
- K31: Center drawer w/o skirt - \$205

### CONCEALED FLOOR POWER INFEED COVER

- PCEB: White metal finish concealed floor power infeed cover - \$150

### DELETE TOP AND WIRE TRAY

- DFP: Delete fixed top. Deduct \$1335 Veneer (W), \$1165 High Pressure Laminate (G), \$840 Thermally Fused Laminate (M) per top

### METAL FEET

- MTL10: Replace solid wood feet with metal feet, standard MFW White - \$55 ea

### PREMIUM METAL FINISH

- Specify premium metal finish. MFMB: Matte Black, MFS: Silver, MFSS: Salmon Sienna, MFSA: Surfin Aquavert, MFPS: Pistachio, MFOS: Oyster, MFNA: Navy, MFOL: Olive, MFGB: Grey Beige MFGG: Graphite Gray, MFG: Gray
- Premium metal finish for WMT Wire Management Tray - \$75 ea
- Premium metal finish for MTL10 Metal Feet - \$20 ea
- Premium metal finish for PCEB Concealed Floor Power Infeed Cover - \$35

### STARTER PANEL

- RSP: Substitute round starter panel in place of flat starter panel. Must substitute all starters, priced per starter panel - \$83 each. See HNY3555SP888

### TELECOM PLATES

- Each power unit has 1 plate. All telecom connectors sold separately.
- RJ45 (1) - \$35, RJ45 (2) - \$70, RJ45 (3) - \$105, USB (1) - \$70, USB (2) - \$140, RJ45/USB - \$105, RJ45/HDMI - \$190, HDMI/USB - \$205

### WORKSURFACE HEIGHT

- THL42: Modify worksurface height to bar height - N/C

1 Select a model w" x d" x h"	PERSON	yardage	Standard Veneer Top Upholstered Panels - COM\$		Premium Veneer Top Upholstered Panels - COM\$		High Pressure Laminate Top Upholstered Panels - COM\$		Thermally Fused Laminate Top Upholstered Panels - COM\$	
539 x 41 x 55	8	67	HNY53941FP585W	35632	"P" Option N/A	HNY53941FP585G	34272	HNY53941FP585M	31672	
474 x 41 x 55	7	59	HNY47441FP585W	31269	"P" Option N/A	HNY47441FP585G	30079	HNY47441FP585M	27804	
409 x 41 x 55	6	51	HNY40941FP585W	26906	"P" Option N/A	HNY40941FP585G	25886	HNY40941FP585M	23936	
345 x 41 x 55	5	43	HNY34541FP585W	22543	"P" Option N/A	HNY34541FP585G	21693	HNY34541FP585M	20068	
280 x 41 x 55	4	35	HNY28041FP585W	18180	"P" Option N/A	HNY28041FP585G	17500	HNY28041FP585M	16200	
215 x 41 x 55	3	27	HNY21541FP585W	13817	"P" Option N/A	HNY21541FP585G	13307	HNY21541FP585M	12332	
150 x 41 x 55	2	19	HNY15041FP585W	9454	"P" Option N/A	HNY15041FP585G	9114	HNY15041FP585M	8464	
85 x 37 x 55	1	11	HNY8537FP585W	5091	"P" Option N/A	HNY8537FP585G	4921	HNY8537FP585M	4596	

2 Select a worksurface finish	WWP	WBW	GEC	LW01	MEC
<a href="#">View finish details</a>	PO01	WSW	GWL	LW02	MOC
Wire Tray Metal finish Standard in MFW White. See premium finishes for options.	PO02	WEC	LP01	LW04	MSW
	PO03	WOW	LP02	LW05	MTW
	PO04	WNO	LF01	LW06	MWL
	PO05	WSO	LF02	LW07	
	PO06		LF03		
	PO07		LN01		
	PO08		LA01		
	PO09		LA02		

3 Select feet finish	WWP	WBW	WWP	WBW	WWP	WBW
<a href="#">View finish details</a>	PO01	WSW	PO01	WSW	PO01	WSW
	PO02	WEC	PO02	WEC	PO02	WEC
	PO03	WOW	PO03	WOW	PO03	WOW
	PO04	WNO	PO04	WNO	PO04	WNO
	PO05	WSO	PO05	WSO	PO05	WSO
	PO06		PO06		PO06	
	PO07		PO07		PO07	
	PO08		PO08		PO08	
	PO09		PO09		PO09	

  

4 Select a edge	Cliff-1 Veneer	Cliff-2 Black	Cliff-3 White	Flat-1 Veneer	Flat-2 Black	Flat-3 White
<a href="#">View edge details</a>						



# Honey.

S-Shaped Workstation Typical  
Desk with Height Adjustable Worksurface

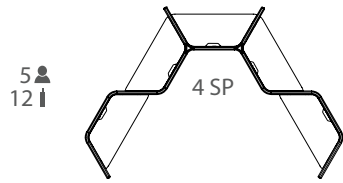

5  
12

4 SP

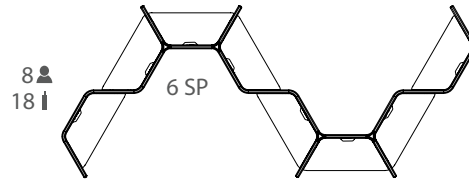

8  
18

6 SP

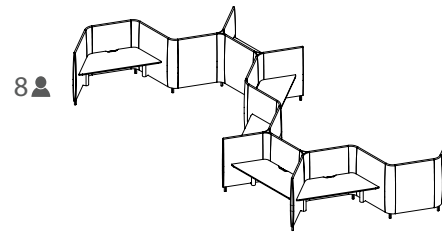

8



Height Adjustable  
Workstation



Powered  
Workstation

Number of Feet per Typical (MTL10 Option) "SP" Number of Starter Panels per Typical (RSP Option)

[View statement of line](#)

## Product features.

- 5" Solid wood feet - oval shape, ships KD
- 4 Power outlets with 1 telecom plate, see options below for telecom plate
- Adjustable height from 27" to 47.5" with a maximum weight capacity of 275 lbs. Lift standard in MFW White, optional MFB Black
- HNY7227WT163 Height Adjustable worksurfaces are included
- Wire management tray attaches to worksurface top, standard in MFW White, see premium metal finish for options

### NOTES

- 1" Gap between worksurface and panels to drop wires below worksurface
- Metal parts include 5 year warranty
- Programmable height adjustable mechanism, motor includes 2 year warranty

## Options.

### ACCESSORIES

- K28: Articulating Keyboard w/ Mouse - \$390
- K31-SK: Center drawer w/ skirt - \$310
- K31: Center drawer w/o skirt - \$205

### CONCEALED FLOOR POWER INFEED COVER

- PCEB: White metal finish concealed floor power infeed cover - \$150

### DELETE TOP AND WIRE TRAY

- DHAT: Delete height adjustable top. Deduct \$3265 Veneer(W), \$3095 High Pressure Laminate(G), \$2770 Thermally Fused Laminate(M) per top

### METAL FEET

- MTL10: Replace solid wood feet with metal feet, standard MFW White - \$55 ea

### PREMIUM METAL FINISH

- Specify premium metal finish. MFMB: Matte Black, MFS: Silver, MFSS: Salmon Sienna, MFSA: Surfing Aquavert, MFPS: Pistachio, MFOS: Oyster, MFNA: Navy, MFOL: Olive, MFGB: Grey Beige MFGG: Graphite Gray, MFG: Gray
- Premium metal finish for WMT Wire Management Tray - \$75 ea
- Premium metal finish for MTL10 Metal Feet - \$20 ea
- Premium metal finish for PCEB Concealed Floor Power Infeed Cover - \$35

### STARTER PANEL

- RSP: Substitute round starter panel in place of flat starter panel. Must substitute all starters, priced per starter panel - \$83 each. See HNY3555SP888

### TELECOM PLATES

- Each power unit has 1 plate. All telecom connectors sold separately.
- RJ45 (1) - \$35, RJ45 (2) - \$70, RJ45 (3) - \$105, USB (1) - \$70, USB (2) - \$140, RJ45/USB - \$105, RJ45/HDMI - \$190, HDMI/USB - \$205

1 Select a model w" x d" x h"	PERSON	yardage	Standard Veneer Top Upholstered Panels - COM\$		Premium Veneer Top Upholstered Panels - COM\$		High Pressure Laminate Top Upholstered Panels - COM\$		Thermally Fused Laminate Top Upholstered Panels - COM\$	
347 x 145 x 55	8	65	HNY347145HA586W	48956	"P" Option N/A	HNY347145HA586G	47596	HNY347145HA586M	44996	
217 x 145 x 55	5	42	HNY217145HA586W	31135	"P" Option N/A	HNY217145HA586G	30285	HNY217145HA586M	28660	

2 Select a worksurface finish <a href="#">View finish details</a>	Metal finish Height adjustable column standard in MFW White. Optional MFB Black.		GEC		LW01		MEC	
	WWP	WBW						
PO01	WSW							MOC
PO02	WEC							MSW
PO03	WOW							MTW
PO04	WNO							MWL
PO05	WSO							
PO06								
PO07								
PO08								
PO09								

3 Select feet finish <a href="#">View finish details</a>	WWP		WBW		WWP		WBW		WWP		WBW	
PO01	WSW											
PO02	WEC											
PO03	WOW											
PO04	WNO											
PO05	WSO											
PO06												
PO07												
PO08												
PO09												

4 Select a edge <a href="#">View edge details</a>	Cliff-1 Veneer			Cliff-2 Black			Cliff-3 White			Flat-2 Black			Flat-3 White			Flat-4 Matching		
Flat-1 Veneer																		
Flat-2 Black																		
Flat-3 White																		

# Honey.

## S-Shaped Workstation Typical Desk with Fixed Worksurface

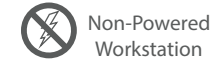
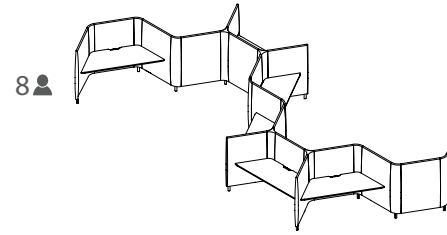
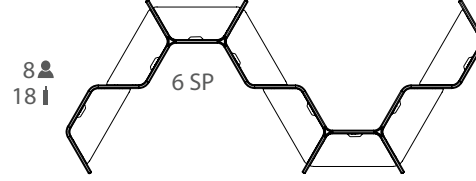
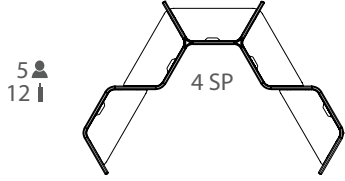

Number of Feet per Typical (MTL10 Option) "SP" Number of Starter Panels per Typical (RSP Option)

[View statement of line](#)

### Product features.

- 5" Solid wood feet - oval shape
- HNY7227WT162 Fixed Desk Height worksurfaces, 29" worksurface height
- Ships KD

### Options.

#### ACCESSORIES

- K28: Articulating Keyboard w/ Mouse - \$390
- K31-SK: Center drawer w/ skirt - \$310
- K31: Center drawer w/o skirt - \$205

#### CONCEALED FLOOR POWER INFEED COVER

- PCEB: White metal finish concealed floor power infeed cover - \$150

#### DELETE TOP

- DFT: Delete fixed top. Deduct \$1125 Veneer(W), \$955 High Pressure Laminate (G), \$630 Thermally Fused Laminate (M) per top

#### METAL FEET

- MTL10: Replace solid wood feet with metal feet, standard MFW White - \$55 ea

#### PREMIUM METAL FINISH

- Specify premium metal finish. MFMB: Matte Black, MFS: Silver, MFSS: Salmon Sienna, MFSA: Surfin Aquavert, MFPS: Pistachio, MFOS: Oyster, MFNA: Navy, MFOL: Olive, MFGB: Grey Beige MFGG: Graphite Gray, MFG: Gray
- Premium metal finish for WMT Wire Management Tray - \$75 ea
- Premium metal finish for MTL10 Metal Feet - \$20 ea
- Premium metal finish for PCEB Concealed Floor Power Infeed Cover - \$35

#### STARTER PANEL

- RSP: Substitute round starter panel in place of flat starter panel. Must substitute all starters, priced per starter panel - \$83 each. See HNY3555SP888

#### WORKSURFACE HEIGHT

- Modify worksurface height to bar height.
- THL-42: Position worksurface at bar height - N/C

#### WIRE TRAY

- WMT: Wire metal tray. Mounts under top and comes standard in MFW White - \$210

1 Select a model w" x d" x h"	person	yardage	Standard Veneer Top Upholstered Panels - COM\$		Premium Veneer Top Upholstered Panels - COM\$		High Pressure Laminate Top Upholstered Panels - COM\$		Thermally Fused Laminate Top Upholstered Panels - COM\$	
347 x 145 x 55	8	65	HNY347145FT586W	29202	"P" Option N/A	HNY347145FT586G	27842	HNY347145FT586M	25242	
217 x 145 x 55	5	42	HNY217145FT586W	18745	"P" Option N/A	HNY217145FT586G	17895	HNY217145FT586M	16270	

2 Select a worksurface finish <a href="#">View finish details</a>								
WWP	WBW				GEC	LW01	MEC	
PO01	WSW				GWL	LW02	MOC	
PO02	WEC				LP01	LW04	MSW	
PO03	WOW				LP02	LW05	MTW	
PO04	WNO				LF01	LW06	MWL	
PO05	WSO				LF02	LW07		
PO06					LF03			
PO07					LN01			
PO08					LA01			
PO09					LA02			

3 Select feet finish <a href="#">View finish details</a>								
WWP	WBW				WWP	WBW		
PO01	WSW				PO01	WSW		
PO02	WEC				PO02	WEC		
PO03	WOW				PO03	WOW		
PO04	WNO				PO04	WNO		
PO05	WSO				PO05	WSO		
PO06					PO06			
PO07					PO07			
PO08					PO08			
PO09					PO09			

4 Select an edge <a href="#">View edge details</a>										
Cliff-1 Veneer	Cliff-2 Black	Cliff-3 White				Cliff-1 HPL	Cliff-2 Black	Cliff-3 White		
Flat-1 Veneer	Flat-2 Black	Flat-3 White				Flat-1 HPL	Flat-2 Black	Flat-3 White		

# Honey.

## S-Shaped Workstation Typical Desk with Power Fixed Worksurface

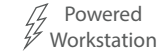
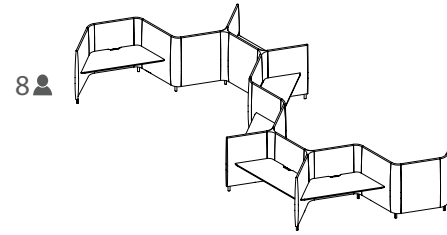
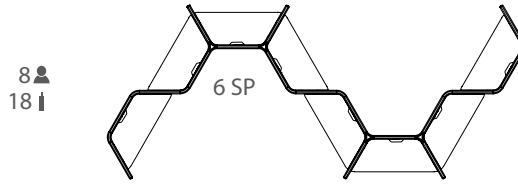
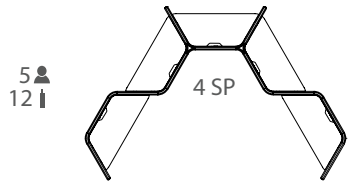

Number of Feet per Typical (MTL10 Option) "SP" Number of Starter Panels per Typical (RSP Option)

[View statement of line](#)

## Product features.

- HNY7227WT162 Fixed Desk Height worksurfaces, 29" worksurface height
- 5" Solid wood feet - oval shape
- 4 Power outlets with 1 telecom plate, see options below for telecom plate
- Ships KD
- Wire management tray attaches to worksurface top, standard in MFW White, see premium metal finish for options
- Hardwire infeed and jumpers are included in workstations

## Options.

### ACCESSORIES

- K28: Articulating Keyboard w/ Mouse - \$390
- K31-SK: Center drawer w/ skirt - \$310
- K31: Center drawer w/o skirt - \$205

### CONCEALED FLOOR POWER INFEED COVER

- PCEB: White metal finish concealed floor power infeed cover - \$150

### DELETE TOP AND WIRE TRAY

- DFP: Delete fixed top. Deduct \$1335 Veneer (W), \$1165 High Pressure Laminate (G), \$840 Thermally Fused Laminate (M) per top

### METAL FEET

- MTL10: Replace solid wood feet with metal feet, standard MFW White - \$55 ea

### PREMIUM METAL FINISH

- Specify premium metal finish. MFMB: Matte Black, MFS: Silver, MFSS: Salmon Sienna, MFSA: Surfing Aquavert, MFPS: Pistachio, MFOS: Oyster, MFNA: Navy, MFOL: Olive, MFGB: Grey Beige MFGG: Graphite Gray, MFG: Gray
- Premium metal finish for WMT Wire Management Tray - \$75 ea
- Premium metal finish for MTL10 Metal Feet - \$20 ea
- Premium metal finish for PCEB Concealed Floor Power Infeed Cover - \$35

### STARTER PANEL

- RSP: Substitute round starter panel in place of flat starter panel. Must substitute all starters, priced per starter panel - \$83 each. See HNY3555SP888

### TELECOM PLATES

- Each power unit has 1 plate. All telecom connectors sold separately.
- RJ45 (1) - \$35, RJ45 (2) - \$70, RJ45 (3) - \$105, USB (1) - \$70, USB (2) - \$140, RJ45/USB - \$105, RJ45/HDMI - \$190, HDMI/USB - \$205

### WORKSURFACE HEIGHT

- THL-42: Modify worksurface height to bar height - N/C

1 Select a model w" x d" x h"	person	yardage	Standard Veneer Top Upholstered Panels - COM\$		Premium Veneer Top Upholstered Panels - COM\$		High Pressure Laminate Top Upholstered Panels - COM\$		Thermally Fused Laminate Top Upholstered Panels - COM\$		
347 x 145 x 55	8	65	HNY347145FP586W	33516	"P" Option N/A	HNY347145FP586G	32156	HNY347145FP586G	29556	HNY347145FP586M	29556
217 x 145 x 55	5	42	HNY217145FP586W	21485	"P" Option N/A	HNY217145FP586G	20635	HNY217145FP586G	19010	HNY217145FP586M	19010

2 Select a worksurface finish										
WWP	WBW				GEC	LW01			MEC	
PO01	WSW				GWL	LW02			MOC	
PO02	WEC				LP01	LW04			MSW	
PO03	WOW				LP02	LW05			MTW	
PO04	WNO				LF01	LW06			MWL	
PO05	WSO				LF02	LW07				
PO06					LF03					
PO07					LN01					
PO08					LA01					
PO09					LA02					

3 Select feet finish										
WWP	WBW				WWP	WBW			WWP	WBW
PO01	WSW				PO01	WSW			PO01	WSW
PO02	WEC				PO02	WEC			PO02	WEC
PO03	WOW				PO03	WOW			PO03	WOW
PO04	WNO				PO04	WNO			PO04	WNO
PO05	WSO				PO05	WSO			PO05	WSO
PO06					PO06				PO06	
PO07					PO07				PO07	
PO08					PO08				PO08	
PO09					PO09				PO09	

4 Select an edge												
Cliff-1 Veneer	Cliff-2 Black	Cliff-3 White			Cliff-1 HPL	Cliff-2 Black	Cliff-3 White			Flat-2 Black	Flat-3 White	Flat-4 Matching
Flat-1 Veneer	Flat-2 Black	Flat-3 White			Flat-1 HPL	Flat-2 Black	Flat-3 White					

# Honey.

120° Lounge  
Lounge with Seat and Back Cushions

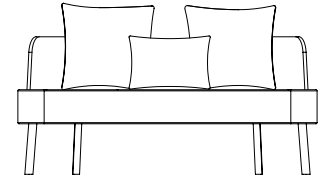

[View statement of line](#)

## Product features.

- 10.5" Solid wood feet - oval shape
- 4" high resiliency foam seat
- 3/4" Bent plywood back with rift cut oak or walnut veneer
- (2) 20" pillows, (1) 16" pillow
- Solid wood base to maximize strength and longevity

1 model	COM	COL	1	2	3	4	5	6	7	8	9	10	11/L1	12	13/L2
HNY0170HPB48	2998	N/A	3183	3274	3365	3456	3547	3638	3729	3820	3911	4002	4093	4184	4366
W x D x H 60 x 26.5 x 27			Upholstery Requirements												
Arm Height:			Fabric yds: 5 1/2 Leather Sq. Ft.: 99												
Seat Height:			Carton Weight: 100												
Inside Seat Depth:															
Inside Seat Width:															

## 2 Select a finish

[View finish details](#)

- WWP Designer White
- PO01 Olive on Oak
- PO02 Aquavert on Oak
- PO03 Mushroom on Oak
- PO04 Burgundy on Oak
- PO05 Ash on Oak
- PO06 Powderder on Oak
- PO07 Pebble on Oak
- PO08 Vapour on Oak
- PO09 Verde on Oak
- WNO Natural Oak on Oak
- WEC Ebony
- WSO Salted Oak on Oak
- WBW Henna Walnut on Walnut
- WSW Smokey Walnut on Walnut
- WOW Clear Walnut on Walnut

- WWP Designer White
- PO01 Olive on Oak
- PO02 Aquavert on Oak
- PO03 Mushroom on Oak
- PO04 Burgundy on Oak

## 3 Combination Fabrics

[View finish details](#)

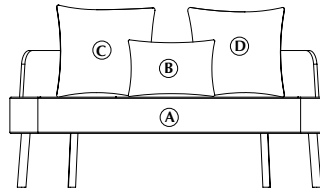

- A Lounge Seat** 2.5 yd. (s)
- B Lounge Pillow** 1 yd.
- C Lounge Pillow** 1 yd.
- D Lounge Pillow** 1 yd.

## Options.

### PREMIUM METAL FINISH

- Specify premium metal finish. MFMB: Matte Black, MFS: Silver, MFSS: Salmon Sienna, MFSA: Surfin Aquavert, MFPS: Pistachio, MFOS: Oyster, MFNA: Navy, MFOL: Olive, MFGB: Grey Beige
- MFGG: Graphite Gray, MFG: Gray
- Premium metal finish for MTL12 metal legs: \$20 ea

### METAL FEET

- MTL12: Replace solid wood legs with metal legs, standard in MFW White - \$75 ea

# Honey.

120° Starter Panel  
Round End



[View statement of line](#)

## Product features.

- 5" Solid wood feet - oval shape

### NOTES

- To configure workstations, customer is required to send drawing

## Options.

### METAL FEET

- MTL10: Replace solid wood feet with metal feet, standard in MFW  
White - \$55 ea

### PREMIUM METAL FINISH

- Specify premium metal finish. MFMB: Matte Black, MFS: Silver, MFSS: Salmon Sienna, MFSA: Surfin Aquavert, MFPS: Pistachio, MFOS: Oyster, MFNA: Navy, MFOL: Olive, MFGB: Grey Beige MFGG: Graphite Gray, MFG: Gray  
- Premium metal finish for MTL10: Metal feet \$20 per foot

1 model	COM	COL	1	2	3	4	5	6	7	8	9	10	11	12	13
HNY3555SP888	866	N/A	977	1032	1087	1142	1197	1252	1307	1362	1417	1472	1527	1582	1692
W x D x H 35 x 3 x 55			Upholstery Requirements Fabric yds: 3 Leather Sq. Ft.: N/A Carton Weight: 20												

## 2

[View finish details](#)

- WWP Designer White
- PO01 Olive on Oak
- PO02 Aquavert on Oak
- PO03 Mushroom on Oak
- PO04 Burgundy on Oak
- PO05 Ash on Oak
- PO06 Powderder on Oak
- PO07 Pebble on Oak
- PO08 Vapour on Oak
- PO09 Verde on Oak
- WNO Natural Oak on Oak
- WEC Ebony
- WSO Salted Oak on Oak
- WBW Henna Walnut on Walnut
- WSW Smokey Walnut on Walnut
- WOW Clear Walnut on Walnut

## 3

Select a back finish

[View finish details](#)

Finish N/A

## 4

Combination Fabrics

Combination  
Fabric Option  
Not Available

# Honey.

120° Starter Panel  
Flat End

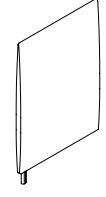

[View statement of line](#)

## Product features.

- 5" Solid wood feet - oval shape

### NOTES

- To configure workstations, customer is required to send drawing

## Options.

### METAL FEET

- MTL10: Replace solid wood feet with metal feet, standard in MFW  
White - \$55 ea

### PREMIUM METAL FINISH

- Specify premium metal finish. MFMB: Matte Black, MFS: Silver, MFSS: Salmon Sienna, MFSA: Surfin Aquavert, MFPS: Pistachio, MFOS: Oyster, MFNA: Navy, MFOL: Olive, MFGB: Grey Beige MFGG: Graphite Gray, MFG: Gray  
- Premium metal finish for MTL10: Metal feet \$20 per foot

1 model	COM	COL	1	2	3	4	5	6	7	8	9	10	11	12	13
HNY3555SP889	783	N/A	894	949	1004	1059	1114	1169	1224	1279	1334	1389	1444	1499	1609
W x D x H 35 x 3 x 55			Upholstery Requirements Fabric yds: 3 Leather Sq. Ft.: N/A Carton Weight: 20												

## 2

[View finish details](#)

- WWP Designer White
- PO01 Olive on Oak
- PO02 Aquavert on Oak
- PO03 Mushroom on Oak
- PO04 Burgundy on Oak
- PO05 Ash on Oak
- PO06 Powderder on Oak
- PO07 Pebble on Oak
- PO08 Vapour on Oak
- PO09 Verde on Oak
- WNO Natural Oak on Oak
- WEC Ebony
- WSO Salted Oak on Oak
- WBW Henna Walnut on Walnut
- WSW Smokey Walnut on Walnut
- WOW Clear Walnut on Walnut

## 3

Select a back finish

[View finish details](#)

Finish N/A

## 4

Combination Fabrics

Combination  
Fabric Option  
Not Available

# Honey.

120° Corner Panel Connector  
Two Corner Panel



[View statement of line](#)

## Product features.

- 5" Solid wood feet - oval shape

### NOTES

- To configure workstations, customer is required to send drawing

## Options.

### METAL FEET

- MTL10: Replace solid wood feet with metal feet, standard in MFW  
White - \$55 ea

### PREMIUM METAL FINISH

- Specify premium metal finish. MFMB: Matte Black, MFS: Silver, MFSS: Salmon Sienna, MFSA: Surfin Aquavert, MFPS: Pistachio, MFOS: Oyster, MFNA: Navy, MFOL: Olive, MFGB: Grey Beige MFGG: Graphite Gray, MFG: Gray  
- Premium metal finish for MTL10: Metal feet \$20 per foot

1 model	COM	COL	1	2	3	4	5	6	7	8	9	10	11	12	13
HNY0955CP890	512	N/A	549	567	585	603	621	639	657	675	693	711	729	747	783
W x D x H 9 x 9 x 55			Upholstery Requirements Fabric yds: 1 Leather Sq. Ft.: N/A Carton Weight: 10												

## 2

[View finish details](#)

- WWP Designer White
- PO01 Olive on Oak
- PO02 Aquavert on Oak
- PO03 Mushroom on Oak
- PO04 Burgundy on Oak
- PO05 Ash on Oak
- PO06 Powderder on Oak
- PO07 Pebble on Oak
- PO08 Vapour on Oak
- PO09 Verde on Oak
- WNO Natural Oak on Oak
- WEC Ebony
- WSO Salted Oak on Oak
- WBW Henna Walnut on Walnut
- WSW Smokey Walnut on Walnut
- WOW Clear Walnut on Walnut

## 3

Select a back finish  
[View finish details](#)

Finish N/A

## 4

Combination Fabrics

Combination  
Fabric Option  
Not Available

# Honey.

120° Corner Panel Connector  
Three Corner Panel



[View statement of line](#)

## Product features.

- 5" Solid wood feet - oval shape

### NOTES

- To configure workstations, customer is required to send drawing

## Options.

### METAL FEET

- MTL10: Replace solid wood feet with metal feet, standard in MFW  
White - \$55 ea

### PREMIUM METAL FINISH

- Specify premium metal finish. MFMB: Matte Black, MFS: Silver, MFSS: Salmon Sienna, MFSA: Surfin Aquavert, MFPS: Pistachio, MFOS: Oyster, MFNA: Navy, MFOL: Olive, MFGB: Grey Beige MFGG: Graphite Gray, MFG: Gray  
- Premium metal finish for MTL10: Metal feet \$20 per foot

1 model	COM	COL	1	2	3	4	5	6	7	8	9	10	11	12	13
HNY0855CP891	630	N/A	686	713	740	767	794	821	848	875	902	929	956	983	1037
W x D x H 8 x 8 x 55			Upholstery Requirements Fabric yds: 1.5 Leather Sq. Ft.: N/A Carton Weight: 10												

## 2

[View finish details](#)

- WWP Designer White
- PO01 Olive on Oak
- PO02 Aquavert on Oak
- PO03 Mushroom on Oak
- PO04 Burgundy on Oak
- PO05 Ash on Oak
- PO06 Powderder on Oak
- PO07 Pebble on Oak
- PO08 Vapour on Oak
- PO09 Verde on Oak
- WNO Natural Oak on Oak
- WEC Ebony
- WSO Salted Oak on Oak
- WBW Henna Walnut on Walnut
- WSW Smokey Walnut on Walnut
- WOW Clear Walnut on Walnut

## 3

Select a back finish  
[View finish details](#)

Finish N/A

## 4

Combination Fabrics

Combination  
Fabric Option  
Not Available



# Honey.

In-Line Panel Connector  
Straight Run Connector



[View statement of line](#)

## Product features.

- 5" Solid wood feet - oval shape

### NOTES

- To configure workstations, customer is required to send drawing

## Options.

### METAL FEET

- MTL10: Replace solid wood feet with metal feet, standard in MFV  
White - \$55 ea

### PREMIUM METAL FINISH

- Specify premium metal finish. MFMB: Matte Black, MFS: Silver, MFSS: Salmon Sienna, MFSA: Surfin Aquavert, MFPS: Pistachio, MFOS: Oyster, MFNA: Navy, MFOL: Olive, MFGB: Grey Beige MFGG: Graphite Gray, MFG: Gray  
- Premium metal finish for MTL10: Metal feet \$20 per foot

1 model	COM	COL	1	2	3	4	5	6	7	8	9	10	11	12	13
HNY0955CP886	446	N/A	483	501	519	537	555	573	591	609	627	645	663	681	717
W x D x H 9 x 3 x 55			Upholstery Requirements Fabric yds: 1 Leather Sq. Ft.: N/A Carton Weight: 20												

## 2

[View finish details](#)

- WWP Designer White
- PO01 Olive on Oak
- PO02 Aquavert on Oak
- PO03 Mushroom on Oak
- PO04 Burgundy on Oak
- PO05 Ash on Oak
- PO06 Powerder on Oak
- PO07 Pebble on Oak
- PO08 Vapour on Oak
- PO09 Verde on Oak
- WNO Natural Oak on Oak
- WEC Ebony
- WSO Salted Oak on Oak
- WBW Henna Walnut on Walnut
- WSW Smokey Walnut on Walnut
- WOW Clear Walnut on Walnut

## 3

Select a back finish  
[View finish details](#)

Finish N/A

## 4

Combination Fabrics

Combination  
Fabric Option  
Not Available

# Honey.

120° Adder Panel  
No Power Access

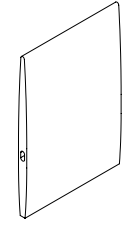

[View statement of line](#)

## Product features.

- Adder panel

### NOTES

- To configure workstations, customer is required to send drawing
- Panel overall height is 55" with feet. Panel overall height without feet is 50"

1 model	COM	COL	1	2	3	4	5	6	7	8	9	10	11	12	13
HNY3450AP894	808	N/A	919	974	1029	1084	1139	1194	1249	1304	1359	1414	1469	1524	1634
W x D x H 34 x 3 x 50			Upholstery Requirements Fabric yds: 3 Leather Sq. Ft.: N/A Carton Weight: 20												

2 [View finish details](#)  
Finish N/A

3 Select a back finish [View finish details](#)

WWP  
PO01  
PO02  
PO03  
PO04  
PO05  
PO06  
PO07  
PO08  
PO09  
WBW  
WEC  
WOW  
WNO  
WSO  
TSLV

4 Combination Fabrics

Combination  
Fabric Option  
Not Available

# Honey.

120° Adder Access Panel  
Single Sided Access

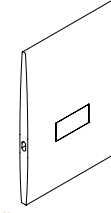

[View statement of line](#)

## Product features.

- Panel features access panel for wire management

### NOTES

- To configure workstations, customer is required to send drawing
- Panel overall height is 55" with feet. Panel overall height without feet is 50"
- Removable panel allows wire access for cable management

1 model	COM	COL	1	2	3	4	5	6	7	8	9	10	11	12	13
HNY3450AP895	858	N/A	969	1024	1079	1134	1189	1244	1299	1354	1409	1464	1519	1574	1684
W x D x H 34 x 3 x 50			Upholstery Requirements Fabric yds: 3 Leather Sq. Ft.: N/A Carton Weight: 20												

2 [View finish details](#)  
Finish N/A

3 Select a back finish [View finish details](#)  
 WWP  
 PO01  
 PO02  
 PO03  
 PO04  
 PO05  
 PO06  
 PO07  
 PO08  
 PO09  
 WBW  
 WEC  
 WOW  
 WNO  
 WSO  
 TSLV

4 Combination Fabrics  
  
 Combination  
 Fabric Option  
 Not Available

# Honey.

120° Single Sided Power Panel  
Power Panel

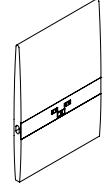

[View statement of line](#)

## Product features.

- 4 power outlets with 1 telecom plate, see options below for telecom plate

### NOTES

- To configure workstations, customer is required to send drawing
- Panel overall height is 55" with feet. Panel overall height without feet is 50"
- Jumper(s) or hardwired infeed must be selected to power workstations. See options below.

## Options.

### JUMPER(S) AND INFEEED

- Specify Jumper or Infeed to power workstations
- JC42: 42" Length jumper, passes through corner post connecting panel to panel - \$110.
- JC96: 96" Length jumper, passes through 1 adder panel connecting 3 panels - \$170
- JC150: 150" Length jumper passes through 2 adder panels connecting 4 panels - \$220.
- JC204: 204" Length jumper passes through corner post connecting 3 panels - \$275
- HPF120: 120" hardwired power feed -\$190.

### TELECOM PLATES

- Each power unit has 1 plate. All telecom connectors sold separately.
- RJ25 (1) - \$35, RJ45 (2) - \$70, RJ45 (3) - \$105, USB (1) - \$70, USB (2) - \$140, RJ45/USB - \$105, RJ45/HDMI - \$190, HDMI/USB - \$205

1 model	COM	COL	1	2	3	4	5	6	7	8	9	10	11	12	13
HNY3450PP892	976	N/A	1087	1142	1197	1252	1307	1362	1417	1472	1527	1582	1637	1692	1802
W x D x H 34 x 3 x 50			Upholstery Requirements Fabric yds: 3 Leather Sq. Ft.: N/A Carton Weight: 20												

## 2

[View finish details](#)

Finish N/A

## 3

Select a back finish

[View finish details](#)

- WWP
- PO01
- PO02
- PO03
- PO04
- PO05
- PO06
- PO07
- PO08
- PO09
- WBW
- WEC
- WOW
- WNO
- WSO
- TSLV

## 4

Combination Fabrics

Combination  
Fabric Option  
Not Available

# Honey.

120° Double Sided Power Panel  
Power Panel

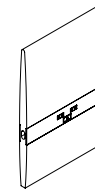

[View statement of line](#)

## Product features.

- Double sided power panel, each panel side features 4 power outlets with 1 telecom plate. See options below for telecom plate

### NOTES

- To configure workstations, customer is required to send drawing
- Panel overall height is 55" with feet. Panel overall height without feet is 50"
- Jumper(s) or hardwired infeed must be selected to power workstations. See options below.

## Options.

### JUMPER(S) AND INFEED

- Specify Jumper or Infeed to power workstations
- JC42: 42" Length jumper, passes through corner post connecting panel to panel - \$110.
- JC96: 96" Length jumper, passes through 1 adder panel connecting 3 panels - \$170
- JC150: 150" Length jumper passes through 2 adder panels connecting 4 panels - \$220.
- JC204: 204" Length jumper passes through corner post connecting 3 panels - \$275
- HPF120: 120" hardwired power feed -\$190.

### TELECOM PLATES

- Each power unit has 1 plate. All telecom connectors sold separately.
- RJ25 (1) - \$35, RJ45 (2) - \$70, RJ45 (3) - \$105, USB (1) - \$70, USB (2) - \$140, RJ45/USB - \$105, RJ45/HDMI - \$190, HDMI/USB - \$205

1 model	COM	COL	1	2	3	4	5	6	7	8	9	10	11	12	13
HNY3450PP893	1045	N/A	1156	1211	1266	1321	1376	1431	1486	1541	1596	1651	1706	1761	1871
W x D x H 34 x 3 x 50			Upholstery Requirements Fabric yds: 3 Leather Sq. Ft.: N/A Carton Weight: 20												

2 Select a finish  
[View finish details](#)  
Finish N/A

3 Select a back finish  
[View finish details](#)

- WWP
- PO01
- PO02
- PO03
- PO04
- PO05
- PO06
- PO07
- PO08
- PO09
- WBW
- WEC
- WOW
- WNO
- WSO
- TSLV

4 Combination Fabrics  
Combination  
Fabric Option  
Not Available

# Honey.

Concealed Floor Power Infeed Cover  
Power Cable Entry Box

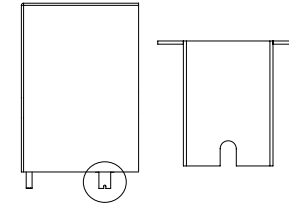

Shown on  
HNY3555SP889  
Panel not included

[View statement of line](#)

## Product features.

- Conceals wire infeed from the floor and mounts to the bottom of honey panels
- White metal finish standard

### NOTES

- PANEL NOT INCLUDED

## Options.

### PREMIUM METAL FINISH - POWER BOX

- Specify metal finish upcharge. MFB Black, MFMB: Matte Black, MFS: Silver, MFSS: Salmon Sienna, MFSA: Surfin Aquavert, MFPS: Pistachio, MFOS: Oyster, MFNA: Navy, MFOL: Olive, MFGB: Grey Beige MFGG: Graphite Gray, MFG: Gray - \$35

1 Select a model		person	weight	Power Infeed Cover	
w" x d" x h"					
5 x 2 x 6				PCEB	150

2 Select a finish		person	weight	Power Infeed Cover	
MFW				WWP	WBW
<a href="#">View finish details</a>				PO01	WEC
Metal finish				PO02	WOW
Standard in MFW				PO03	WNO
White. See premium				PO04	WSO
finishes for options.				PO05	TSLV
				PO06	
				PO07	
				PO08	
				PO09	

3 Select a edge		person	weight	Power Infeed Cover	
<a href="#">View edge details</a>				Edge	N/A

4		person	weight	Power Infeed Cover	
<a href="#">View hardware details</a>				Hardware	N/A

# Honey.

120° Worksurface Top  
Worksurface with Fixed Top

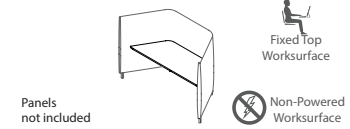

[View statement of line](#)

## Product features.

- 1" Thick top
- Bar height 42", desk height 29"
- Ships KD

### NOTES

- PANELS NOT INCLUDED

## Options.

### WIRE TRAY / PREMIUM METAL FINISH

- WMT: Wire metal tray. Mounts under top and comes standard in MFW White - \$210

### PREMIUM METAL FINISH

- Specify premium metal finish. MFMB: Matte Black, MFS: Silver, MFSS: Salmon Sienna, MFSA: Surfin Aquavert, MFPS: Pistachio, MFOS: Oyster, MFNA: Navy, MFOL: Olive, MFGB: Grey Beige MFGG: Graphite Gray, MFG: Gray
- Premium metal finish for WMT wire management tray - \$75 ea

1 Select a model w" x d" x h"	weight	Standard Veneer Top	Premium Veneer Top	High Pressure Laminate Top	Thermally Fused Laminate Top
<b>Bar Height 42"</b> 72 x 26 x 1	60	HNY7226WT160W 1125	"P" Option N/A	HNY7226WT160G 955	HNY7226WT160M 630
63.5 x 19 x 1	50	HNY6319WT160W 945	"P" Option N/A	HNY6319WT160G 805	HNY6319WT160M 485
<b>Desk Height 29"</b> 72 x 26 x 1	60	HNY7226WT162W 1125	"P" Option N/A	HNY7226WT162G 955	HNY7226WT162M 630
63.5 x 19 x 1	50	HNY6319WT162W 945	"P" Option N/A	HNY6319WT162G 805	HNY6319WT162M 485

[View finish details](#)

[View finish details](#)

2 Select a finish					
	WWP	WBW	GEC	LA02	MEC
	PO01	WSW	GWL	LW01	MOC
	PO02	WEC	LP01	LW02	MSW
	PO03	WOW	LP02	LW04	MTW
	PO04	WNO	LF01	LW05	MWL
	PO05	WSO	LF02	LW06	
	PO06		LF03	LW07	
	PO07		LN01		
	PO08		LA01		
	PO09				

3 Select a edge				
	Cliff-1 Veneer	Cliff-2 Black	Cliff-3 White	
	Flat-1 Veneer	Flat-2 Black	Flat-3 White	

4 Select hardware			
	Hardware N/A	Hardware N/A	Hardware N/A

# Honey.

120° Worksurface Top  
 Worksurface with Height Adjustable Top

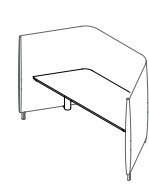

Panels  
not included

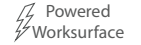

[View statement of line](#)

## Product features.

- "W/G" worksurfaces are 1" thick, "M" worksurfaces are 1-1/8" thick
- Lift standard in MFW White, optional MFB Black
- Ships KD
- Wire management tray attaches to worksurface top, standard in MFW White, see premium metal finish for options















### NOTES

- 1" Gap between worksurface and panels to drop wires below work-surface
- Metal parts include 5 year warranty
- Programmable height adjustable mechanism, motor includes 2 year warranty
- Height adjustable top with mechanism and wire tray only, panels not included

## Options.

### PREMIUM METAL FINISH

- Specify premium metal finish. MFMB: Matte Black, MFS: Silver, MFSS: Salmon Sienna, MFSA: Surfin Aquavert, MFPS: Pistachio, MFOS: Oyster, MFNA: Navy, MFOL: Olive, MFGB: Grey Beige MFGG: Graphite Gray, MFG: Gray
- Premium metal finish for WMT wire management tray - \$75 ea

1 Select a model w" x d" x h"	person weight	Standard Veneer Top		Premium Veneer Top		High Pressure Laminate Top		Thermally Fused Laminate Top	
72 x 27 x 1	120	HNY7227WT163W	3265	"P" Option N/A		HNY7227WT163G	3095	HNY7227WT163M	2770
62 x 18 x 1	90	HNY6218WT163W	3085	"P" Option N/A		HNY6218WT163G	2945	HNY6218WT163M	2625
2 Select a finish <a href="#">View finish details</a> Metal finish Height adjustable column standard in MFW White. Optional MFB Black.		WWP WBSW PO01 WSW PO02 WEC PO03 WOW PO04 WNO PO05 WSO PO06 PO07 PO08 PO09				GEC LW01 GWL LW02 LP01 LW04 LP02 LW05 LF01 LW06 LF02 LW07 LF03 LN01 LA01 LA02		MEC MOC MSW MTW MWL	
3 Select a edge <a href="#">View edge details</a>		 Cliff-1 Veneer  Cliff-2 Black  Cliff-3 White   Flat-1 Veneer  Flat-2 Black  Flat-3 White		 Cliff-1 HPL  Cliff-2 Black  Cliff-3 White   Flat-1 HPL  Flat-2 Black  Flat-3 White		 Flat-1  Flat-2 Black  Flat-3 White			
4 Select hardware <a href="#">View hardware details</a>		Hardware N/A				Hardware N/A		Hardware N/A	



# Honey.

Fixed Triangular Table  
Fixed Triangular Table - Sitting Height

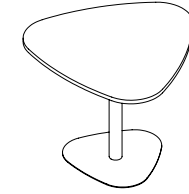















## Product features.

- 1" Thick top
- Standard white metal base

## Options.

### PREMIUM METAL FINISH - TABLE BASE

- Specify metal finish for table base
- MFMB: Matte Black, MFS: Silver, MFSS: Salmon Sienna, MFSA: Surfing Aquavert, MFPS: Pistachio, MFOS: Oyster, MFNA: Navy, MFOL: Olive, MFGB: Grey Beige MFGG: Graphite Gray, MFG: Gray - \$175

1 Select a model w" x d" x h"	person	weight	Standard Veneer Top Metal Base		Premium Veneer Top Metal Base		High Pressure Laminate Top Metal Base		Thermally Fused Laminate Top Metal Base		
30 x 30 x 29		50	HNY3029TR379W	965	"P" Option N/A	HNY3029TR379G	965	HNY3029TR379M	772		
25 x 24 x 24		45	HNY2425TR379W	910	"P" Option N/A	HNY2425TR379G	910	HNY2425TR379M	730		
24 x 24 x 20		40	HNY2420TR379W	825	"P" Option N/A	HNY2420TR379G	825	HNY2420TR379M	645		
18 x 18 x 17		30	HNY1817TR379W	725	"P" Option N/A	HNY1817TR379G	725	HNY1817TR379M	557		
2 Select a finish <i>View finish details</i> Metal finish Standard in MFW White. See premium finishes for options.			WWP PO01			GEC LW01		MEC			
			PM01 PO02			GWL LW02		MOC			
			PM02 PO03			LP01 LW04		MSW			
			PM03 PO04			LP02 LW05		MTW			
			PM04 PO05			LF01 LW06		MWL			
			PM05 PO06			LF02 LW07					
			PM06 PO07			LF03					
			PM07 PO08			LN01					
			PM08 PO09			LA01					
			PM10			LA02					
3 Select a edge <i>View edge details</i>											
			Cliff-1 Veneer	Cliff-2 Black	Cliff-3 White	Cliff-1 HPL	Cliff-2 Black	Cliff-3 White	Flat-2 Black	Flat-3 White	Flat-4 Matching
											
			Flat-1 Veneer	Flat-2 Black	Flat-3 White	Flat-1 HPL	Flat-2 Black	Flat-3 White			
4 Select hardware <i>View hardware details</i>			Hardware N/A			Hardware N/A			Hardware N/A		

# Honey.

Fixed Circular Table  
Fixed Circular Table - Sitting Height

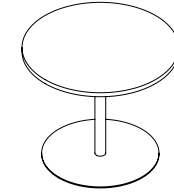















## Product features.

- 1" Thick top
- Standard white metal base

## Options.

### PREMIUM METAL FINISH - TABLE BASE

- Specify metal finish for table base
- MFMB: Matte Black, MFS: Silver, MFSS: Salmon Sienna, MFSA: Surfing Aquavert, MFPS: Pistachio, MFOS: Oyster, MFNA: Navy, MFOL: Olive, MFGB: Grey Beige MFGG: Graphite Gray, MFG: Gray - \$175

1 Select a model w" x d" x h"	person	weight	Standard Veneer Top Metal Base		Premium Veneer Top Metal Base		High Pressure Laminate Top Metal Base		Thermally Fused Laminate Top Metal Base		
30 DIA x 29		50	HNY3029RD379W	944	"P" Option N/A	HNY3029RD379G	944	HNY3029RD379M	737		
25 DIA x 24		45	HNY2425RD379W	910	"P" Option N/A	HNY2425RD379G	910	HNY2425RD379M	730		
24 DIA x 20		40	HNY2420RD379W	825	"P" Option N/A	HNY2420RD379G	825	HNY2420RD379M	645		
18 DIA x 17		30	HNY1817RD379W	754	"P" Option N/A	HNY1817RD379G	745	HNY1817RD379M	592		
2 Select a finish <i>View finish details</i> Metal finish Standard in MFW White. See premium finishes for options.			WWP PO01			GEC LW01		MEC			
			PM01 PO02			GWL LW02		MOC			
			PM02 PO03			LP01 LW04		MSW			
			PM03 PO04			LP02 LW05		MTW			
			PM04 PO05			LF01 LW06		MWL			
			PM05 PO06			LF02 LW07					
			PM06 PO07			LF03					
			PM07 PO08			LN01					
			PM08 PO09			LA01					
			PM10			LA02					
3 Select a edge <i>View edge details</i>			 Cliff-1 Veneer	 Cliff-2 Black	 Cliff-3 White	 Cliff-1 HPL	 Cliff-2 Black	 Cliff-3 White	 Flat-2 Black	 Flat-3 White	 Flat-4 Matching
			 Flat-1 Veneer	 Flat-2 Black	 Flat-3 White	 Flat-1 HPL	 Flat-2 Black	 Flat-3 White			
4 Select hardware <i>View hardware details</i>			Hardware N/A			Hardware N/A			Hardware N/A		

# Honey.

120° Worksurface Privacy Screen  
*Worksurface Veneer Privacy Screen*

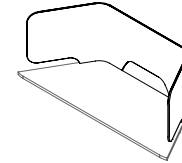

Top  
not included

[View statement of line](#)

## Product features.

- Screens feature veneer on both sides with rounded corners
- 1/2" Thick screen
- Screen attaches to worksurface top

1 Select a model		person	weight	Worksurface Screen			
w" x d" x h"				Standard Veneer Privacy Screen			
69 x 24 x 24			30	VS64W	1785		

2 Select a finish		
		PO01 WEC
	<a href="#">View finish details</a>	PO02 WOW
		PO03 WNO
		PO04 WSO
		PO05 TSLV
		PO06
		PO07
		PO08
		PO09
		WBW

3 Select a edge		
	<a href="#">View edge details</a>	
		Flat

4 Select hardware		
	<a href="#">View hardware details</a>	Hardware
		N/A

# Honey.

120° Worksurface Privacy Screen  
*Worksurface Acrylic Privacy Screen*



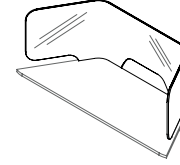

Top  
not included

## Product features.

- Acrylic screens with rounded corners
- 1/4" Thick screen
- Screen attaches to worksurface top

### NOTES

- Matte acrylic is not a writable surface

1 Select a model w" x d" x h"	person	weight	Worksurface Screen Frosted Acrylic		Worksurface Screen Matte White Acrylic		Worksurface Screen Matte Black Acrylic	
			AS64AF	1015	AS64AW	1060	AS64AB	1060
69 x 24 x 24		20						
2 Select a acrylic finish <i>View finish details</i>	AF			AW			AB	
3 Select a edge <i>View edge details</i>	 Flat			 Flat			 Flat	
4 Select hardware <i>View hardware details</i>	Hardware N/A			Hardware N/A			Hardware N/A	

# Honey.

120° 64" Wide Push-In Storage Credenza  
Storage Credenza with Sliding Doors

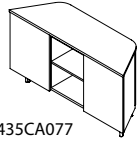

HNY6435CA077

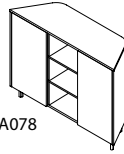

HNY6448CA078

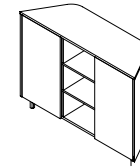

1 Select a model w" x d" x h"	person	weight	Standard Veneer Case Solid Wood Feet		Premium Veneer Case Solid Wood Feet		High Pressure Laminate Case Solid Wood Feet		Thermally Fused Laminate Case Solid Wood Feet	
			64 x 20 x 48		180	HNY6448CA077W	4021	"P" Option N/A	HNY6448CA077G	3655
64 x 20 x 35		140	HNY6435CA077W	3578	"P" Option N/A	HNY6435CA077G	3253	HNY6435CA077M	2480	

2 Select a case & feet finish <i>View finish details</i>	Case Finishes		Feet Finishes		Case Finishes	Feet Finishes		Case Finishes	Feet Finishes	
		WWP	PO01	WSW		WBP	WBW		MEC	WWP
	PM01	PO02	WEC	PO01	WSW	MSW	PO02	WEC	MTW	PO03
	PM02	PO03	WOW	PO02	WEC	MWL	PO04	WNO		PO05
	PM03	PO04	WNO	PO03	WOW		PO06	PO06		PO07
	PM04	PO05	WSO	PO04	WNO		PO08	PO08		PO09
	PM05	PO06		PO05	WSO		PM10	WBW		PO09
	PM06	PO07		PO06						
	PM07	PO08		PO07						
	PM08	PO09		PO08						
	PM10	WBW		PO09						

3 Select a edge <i>View edge details</i>	Case Finishes		Feet Finishes		Case Finishes	Feet Finishes		Case Finishes	Feet Finishes	
		Flat				Flat				Flat

4 Select hardware <i>View hardware details</i>	Case Finishes		Feet Finishes		Case Finishes	Feet Finishes	
		Hardware	N/A				Hardware

## Product features.

- 5" Solid wood feet - oval shape
- Dividers and shelves are finished to match case
- Sliding doors

### NOTES

- Not to be used as freestanding in open plan must slide into 120° panels

## Options.

### GROMMETS (VERTICAL SURFACE)

- Standard location - \$50 each
- Black Plastic Vertical Surface: TM50-C (Bottom Center)
- Non-Standard Location - \$95 each
- Black Plastic Vertical Surface: TM50-NS

### PREMIUM METAL FINISH

- Specify premium metal finish. MFMB: Matte Black, MFS: Silver, MFSS: Salmon Sienna, MFSA: Surfin Aquavert, MFPS: Pistachio, MFOS: Oyster, MFNA: Navy, MFOL: Olive, MFGB: Grey Beige MFGG: Graphite Gray, MFG: Gray
- Premium metal finish for MTL11 Metal Feet: \$20 ea

### METAL FEET

- MTL11: Replace solid wood feet with metal feet, standard in MFW White - \$300 per wardrobe

# Honey.

120° Open Storage Credenza  
Open Storage Credenza



HNY6435CA074W

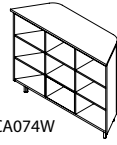

HNY6448CA074W

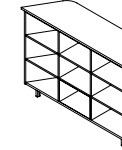

1 Select a model w" x d" x h"	person	weight	Standard Veneer Case Solid Wood Feet		Premium Veneer Case Solid Wood Feet		High Pressure Laminate Case Solid Wood Feet		Thermally Fused Laminate Case Solid Wood Feet	
64 x 20 x 48		150	HNY6448CA074W	2998	"P" Option N/A	HNY6448CA074G	2725	HNY6448CA074M	1725	
64 x 20 x 35		120	HNY6435CA074W	2666	"P" Option N/A	HNY6435CA074G	2424	HNY6435CA074M	1425	

2 Select a case & feet finish <i>View finish details</i>	Case Finishes		Feet Finishes	
		WWP	PO01	WSW
	PM01	PO02	WEC	PO01
	PM02	PO03	WOW	PO02
	PM03	PO04	WNO	PO03
	PM04	PO05	WSO	PO04
	PM05	PO06		PO05
	PM06	PO07		PO06
	PM07	PO08		PO07
	PM08	PO09		PO08
	PM10	WBW		PO09

3 Select a edge <i>View edge details</i>	Case Finishes		Feet Finishes	
		GEC	LW01	WWP
	GWL	LW02	PO01	WSW
	LP01	LW04	PO02	WEC
	LP02	LW05	PO03	WOW
	LF01	LW06	PO04	WNO
	LF02	LW07	PO05	WSO
	LF03		PO06	
	LN01		PO07	
	LA01		PO08	
	LA02		PO09	

4 Select hardware <i>View hardware details</i>	Case Finishes		Feet Finishes	
		MEC	WWP	WBW
	MOC	PO01	WSW	
	MSW	PO02	WEC	
	MTW	PO03	WOW	
	MWL	PO04	WNO	
		PO05	WSO	
		PO06		
		PO07		
		PO08		
		PO09		

## Product features.

- 5" Solid wood feet - oval shape
- Dividers and shelves are finished to match case

### NOTES

- Not to be used as freestanding in open plan must slide into 120° panels

## Options.

### GROMMETS (VERTICAL SURFACE)

- Standard location - \$50 each
- Black Plastic Vertical Surface: TM50-C (Bottom Center)
- Non-Standard Location - \$95 each
- Black Plastic Vertical Surface: TM50-NS

### PREMIUM METAL FINISH

- Specify premium metal finish. MFMB: Matte Black, MFS: Silver, MFSS: Salmon Sienna, MFSA: Surfin Aquavert, MFPS: Pistachio, MFOS: Oyster, MFNA: Navy, MFOL: Olive, MFGB: Grey Beige MFGG: Graphite Gray, MFG: Gray
- Premium metal finish for MTL11 Metal Feet: \$20 ea

### METAL FEET

- MTL11: Replace solid wood feet with metal feet, standard in MFW White - \$300 per wardrobe

# Honey.

Single Sided Open Storage Tower  
Open Storage Tower with Left File / Wardrobe Access

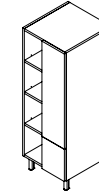

1 Select a model w" x d" x h"	person	weight	Standard Veneer Case Solid Wood Feet		Premium Veneer Case Solid Wood Feet		High Pressure Laminate Case Solid Wood Feet		Thermally Fused Laminate Case Solid Wood Feet			
20 x 20 x 55		200	HNY2055TW300W	2741	"P" Option N/A		HNY2055TW300G	2492	HNY2055TW300M	1702		
2 Select a case & feet finish <a href="#">View finish details</a>	Case Finishes		Feet Finishes		Case Finishes		Feet Finishes		Case Finishes		Feet Finishes	
	WWP	PO01	WSW	WWP	WBW	GEC	LW01	WWP	WBW	MEC	WWP	WBW
	PM01	PO02	WEC	PO01	WSW	GWL	LW02	PO01	WSW	MOC	PO01	WSW
	PM02	PO03	WOW	PO02	WEC	LP01	LW04	PO02	WEC	MSW	PO02	WEC
	PM03	PO04	WNO	PO03	WOW	LP02	LW05	PO03	WOW	MTW	PO03	WOW
	PM04	PO05	WSO	PO04	WNO	LF01	LW06	PO04	WNO	MWL	PO04	WNO
	PM05	PO06		PO05	WSO	LF02	LW07	PO05	WSO		PO05	WSO
	PM06	PO07		PO06		LF03		PO06			PO06	
	PM07	PO08		PO07		LN01		PO07			PO07	
	PM08	PO09		PO08		LA01		PO08			PO08	
	PM10	WBW		PO09		LA02		PO09			PO09	
3 Select a edge <a href="#">View edge details</a>	Flat		Flat		Flat		Flat		Flat		Flat	
	Flat		Flat		Flat		Flat		Flat		Flat	
4 Select hardware <a href="#">View hardware details</a>	Hardware		Hardware		Hardware		Hardware		Hardware		Hardware	
	N/A		N/A		N/A		N/A		N/A		N/A	

## Product features.

- 5" Solid wood feet - oval shape
- Three fixed open shelves, pull out drawer and wardrobe
- Dividers and shelves are finished to match case
- Full extension drawers
- Finished tops
- Soft close suspensions
- Touch latch doors

## Options.

### DOOR

- D2: Door Lock - \$100 per door set
- D6: Delete doors - n/c
- D9SC: Soft Close Door Hinges - \$20 per door

### DRAWER

- P33: Wood Drawer Upgrade - \$45 per drawer
- D2: Door Lock - \$100 per door set

### PREMIUM METAL FINISH

- Specify premium metal finish. MFMB: Matte Black, MFS: Silver, MFSS: Salmon Sienna, MFSA: Surfing Aquavert, MFPS: Pistachio, MFOS: Oyster, MFNA: Navy, MFOL: Olive, MFGB: Grey Beige MFGG: Graphite Gray, MFG: Gray
- Premium metal finish for MTL11 Metal Feet: \$80 per wardrobe

### METAL FEET

- MTL11: Replace solid wood feet with metal feet, standard in MFW White - \$300 per wardrobe

# Honey.

Single Sided Open Storage Tower  
Open Storage Tower with Right File / Wardrobe Access

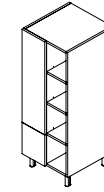

1 Select a model w" x d" x h"	person	weight	Standard Veneer Case Solid Wood Feet		Premium Veneer Case Solid Wood Feet		High Pressure Laminate Case Solid Wood Feet		Thermally Fused Laminate Case Solid Wood Feet			
20 x 20 x 55		200	HNY2055TW301W	2741	"P" Option N/A		HNY2055TW301G	2492	HNY2055TW301M	1702		
2 Select a case & feet finish <a href="#">View finish details</a>	Case Finishes		Feet Finishes		Case Finishes		Feet Finishes		Case Finishes		Feet Finishes	
	WWP	PO01	WSW	WWP	WBW	GEC	LW01	WWP	WBW	MEC	WWP	WBW
	PM01	PO02	WEC	PO01	WSW	GWL	LW02	PO01	WSW	MOC	PO01	WSW
	PM02	PO03	WOW	PO02	WEC	LP01	LW04	PO02	WEC	MSW	PO02	WEC
	PM03	PO04	WNO	PO03	WOW	LP02	LW05	PO03	WOW	MTW	PO03	WOW
	PM04	PO05	WSO	PO04	WNO	LF01	LW06	PO04	WNO	MWL	PO04	WNO
	PM05	PO06		PO05	WSO	LF02	LW07	PO05	WSO		PO05	WSO
	PM06	PO07		PO06		LF03		PO06			PO06	
	PM07	PO08		PO07		LN01		PO07			PO07	
	PM08	PO09		PO08		LA01		PO08			PO08	
	PM10	WBW		PO09		LA02		PO09			PO09	
3 Select a edge <a href="#">View edge details</a>	Flat		Flat		Flat		Flat		Flat		Flat	
	Flat		Flat		Flat		Flat		Flat		Flat	
4 Select hardware <a href="#">View hardware details</a>	Hardware		Hardware		Hardware		Hardware		Hardware		Hardware	
	N/A		N/A		N/A		N/A		N/A		N/A	

## Product features.

- 5" Solid wood feet - oval shape
- Three fixed open shelves, pull out drawer and wardrobe
- Dividers and shelves are finished to match case
- Full extension drawers
- Finished tops
- Soft close suspensions
- Touch latch doors

## Options.

### DOOR

- D2: Door Lock - \$100 per door set
- D6: Delete doors - n/c
- D9SC: Soft Close Door Hinges - \$20 per door

### DRAWER

- P33: Wood Drawer Upgrade - \$45 per drawer
- D2: Door Lock - \$100 per door set

### PREMIUM METAL FINISH

- Specify premium metal finish. MFMB: Matte Black, MFS: Silver, MFSS: Salmon Sienna, MFSA: Surfing Aquavert, MFPS: Pistachio, MFOS: Oyster, MFNA: Navy, MFOL: Olive, MFGB: Grey Beige MFGG: Graphite Gray, MFG: Gray
- Premium metal finish for MTL11 Metal Feet: \$80 per wardrobe

### METAL FEET

- MTL11: Replace solid wood feet with metal feet, standard in MFW White - \$300 per wardrobe



# Honey.

Two Person Double Sided - Freestanding Shared Storage  
All-in-One Cabinet-Double Sided

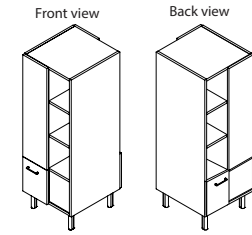

## Product features.

- 5" Solid wood feet - oval shape
- Comes with three fixed shelves and pull out drawer on each side
- Full extension drawers
- Soft close suspensions
- Finished tops
- Touch latch doors

### NOTES

- Unit is designed for open plan use
- Sold as one unit

## Options.

### DOOR

- D2: Door Lock - \$100 per door set
- D6: Delete doors - n/c
- D9SC: Soft Close Door Hinges - \$20 per door

### DRAWER

- P33: Wood Drawer Upgrade - \$45 per drawer
- D2: Door Lock - \$100 per door set

### PREMIUM METAL FINISH

- Specify premium metal finish. MFMB: Matte Black, MFS: Silver, MFSS: Salmon Sienna, MFSA: Surfin Aquavert, MFPS: Pistachio, MFOS: Oyster, MFNA: Navy, MFOL: Olive, MFGB: Grey Beige MFGG: Graphite Gray, MFG: Gray
- Premium metal finish for MTL11 Metal Feet: \$80

### METAL FEET

- MTL11: Replace solid wood feet with metal feet, standard in MFW White - \$300 per wardrobe

1 Select a model	person	weight	Standard Veneer Solid Wood Case	Premium Veneer Solid Wood Case	High Pressure Laminate Solid Wood Case	Thermally Fused Laminate Solid Wood Case																																																																	
w" x d" x h" 20 x 20 x 55	2	200	HNY2055TW299W 3157	"P" Option N/A	HNY2055TW299G 2870	HNY2055TW299M 1960																																																																	
2 Select a case & feet finish <i>View finish details</i>			<table border="1"> <thead> <tr> <th>Case Finishes</th> <th>Feet Finishes</th> </tr> </thead> <tbody> <tr><td>WWP PO01 WSW</td><td>WWP WBW</td></tr> <tr><td>PM01 PO02 WEC</td><td>PO01 WSW</td></tr> <tr><td>PM02 PO03 WOW</td><td>PO02 WEC</td></tr> <tr><td>PM03 PO04 WNO</td><td>PO03 WOW</td></tr> <tr><td>PM04 PO05 WSO</td><td>PO04 WNO</td></tr> <tr><td>PM05 PO06</td><td>PO05 WSO</td></tr> <tr><td>PM06 PO07</td><td>PO06</td></tr> <tr><td>PM07 PO08</td><td>PO07</td></tr> <tr><td>PM08 PO09</td><td>PO08</td></tr> <tr><td>PM10 WBW</td><td>PO09</td></tr> </tbody> </table>	Case Finishes	Feet Finishes	WWP PO01 WSW	WWP WBW	PM01 PO02 WEC	PO01 WSW	PM02 PO03 WOW	PO02 WEC	PM03 PO04 WNO	PO03 WOW	PM04 PO05 WSO	PO04 WNO	PM05 PO06	PO05 WSO	PM06 PO07	PO06	PM07 PO08	PO07	PM08 PO09	PO08	PM10 WBW	PO09	<table border="1"> <thead> <tr> <th>Case Finishes</th> <th>Feet Finishes</th> </tr> </thead> <tbody> <tr><td>GEC LW01 WWP WBW</td><td></td></tr> <tr><td>GWL LW02 PO01 WSW</td><td></td></tr> <tr><td>LP01 LW04 PO02 WEC</td><td></td></tr> <tr><td>LP02 LW05 PO03 WOW</td><td></td></tr> <tr><td>LF01 LW06 PO04 WNO</td><td></td></tr> <tr><td>LF02 LW07 PO05 WSO</td><td></td></tr> <tr><td>LF03</td><td>PO06</td></tr> <tr><td>LN01</td><td>PO07</td></tr> <tr><td>LA01</td><td>PO08</td></tr> <tr><td>LA02</td><td>PO09</td></tr> </tbody> </table>	Case Finishes	Feet Finishes	GEC LW01 WWP WBW		GWL LW02 PO01 WSW		LP01 LW04 PO02 WEC		LP02 LW05 PO03 WOW		LF01 LW06 PO04 WNO		LF02 LW07 PO05 WSO		LF03	PO06	LN01	PO07	LA01	PO08	LA02	PO09	<table border="1"> <thead> <tr> <th>Case Finishes</th> <th>Feet Finishes</th> </tr> </thead> <tbody> <tr><td>MEC</td><td>WWP WBW</td></tr> <tr><td>MOC</td><td>PO01 WSW</td></tr> <tr><td>MSW</td><td>PO02 WEC</td></tr> <tr><td>MTW</td><td>PO03 WOW</td></tr> <tr><td>MWL</td><td>PO04 WNO</td></tr> <tr><td></td><td>PO05 WSO</td></tr> <tr><td></td><td>PO06</td></tr> <tr><td></td><td>PO07</td></tr> <tr><td></td><td>PO08</td></tr> <tr><td></td><td>PO09</td></tr> </tbody> </table>	Case Finishes	Feet Finishes	MEC	WWP WBW	MOC	PO01 WSW	MSW	PO02 WEC	MTW	PO03 WOW	MWL	PO04 WNO		PO05 WSO		PO06		PO07		PO08		PO09
Case Finishes	Feet Finishes																																																																						
WWP PO01 WSW	WWP WBW																																																																						
PM01 PO02 WEC	PO01 WSW																																																																						
PM02 PO03 WOW	PO02 WEC																																																																						
PM03 PO04 WNO	PO03 WOW																																																																						
PM04 PO05 WSO	PO04 WNO																																																																						
PM05 PO06	PO05 WSO																																																																						
PM06 PO07	PO06																																																																						
PM07 PO08	PO07																																																																						
PM08 PO09	PO08																																																																						
PM10 WBW	PO09																																																																						
Case Finishes	Feet Finishes																																																																						
GEC LW01 WWP WBW																																																																							
GWL LW02 PO01 WSW																																																																							
LP01 LW04 PO02 WEC																																																																							
LP02 LW05 PO03 WOW																																																																							
LF01 LW06 PO04 WNO																																																																							
LF02 LW07 PO05 WSO																																																																							
LF03	PO06																																																																						
LN01	PO07																																																																						
LA01	PO08																																																																						
LA02	PO09																																																																						
Case Finishes	Feet Finishes																																																																						
MEC	WWP WBW																																																																						
MOC	PO01 WSW																																																																						
MSW	PO02 WEC																																																																						
MTW	PO03 WOW																																																																						
MWL	PO04 WNO																																																																						
	PO05 WSO																																																																						
	PO06																																																																						
	PO07																																																																						
	PO08																																																																						
	PO09																																																																						
3 Select a edge <i>View edge details</i>																																																																							
4 Select hardware <i>View hardware details</i>																																																																							

# Honey.

Open Plan Mobile Pedestal  
Mobile B/F Desk Pedestal With Casters

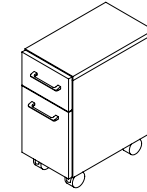

## Product features.

- Product features.
- 3" Hollow wheel caster
  - Anti-tilt safety feature
  - Finished all sides and top - open plan
  - Full extension drawers
  - Soft close suspension











































## Options.

- CUSHION**
- BC10: Bench Cushion
  - Specify fabric grade (.5 yd. required)

- DRAWER**
- P33: Wood Drawer Upgrade - \$45 per drawer
  - D2: Door Lock - \$100 per door set

## BC10 Cushion fabric grades.

COM	COL	1	2	3
203	222	240	258	276
4	5	6	7	8
294	312	330	348	366
9	10	11	12	13
384	402	420	438	474

1 Select a model w" x d" x h"	person	weight	Standard Veneer Pedestal	Premium Veneer Pedestal	High Pressure Laminate Pedestal	Thermally Fused Laminate Pedestal
10 x 18 x 23		40	HNY1119PD423W 1140	"P" Option N/A	HNY1119PD423G 1095	HNY1119PD423M 975
2 Select a finish <i>View finish details</i>			WWP PO01 WSW PM01 PO02 WEC PM02 PO03 WOW PM03 PO04 WNO PM04 PO05 WSO PM05 PO06 PM06 PO07 PM07 PO08 PM08 PO09 PM10 WBW		GEC LW01 GWL LW02 LP01 LW04 LP02 LW05 LF01 LW06 LF02 LW07 LF03 LNO1 LA01 LA02	MEC MOC MSW MTW MWL
3 Select a edge <i>View edge details</i>			 Cliff-1 Veneer  Cliff-2 Black  Cliff-3 White  Flat-1 Veneer  Flat-2 Black  Flat-3 White		 Cliff-1 HPL  Cliff-2 Black  Cliff-3 White  Flat-1 HPL  Flat-2 Black  Flat-3 White	 Flat-2 Black  Flat-3 White  Flat-4 Matching
4 Select hardware <i>View hardware details</i>			 PL-115 Matte Black  PL-116 Matte Nickel  PL-260 Aluminum  PL-261 White  PL-406 Gloss White  PL-407 Matte Chrome  PL-506 Gloss White  PL-507 Matte Chrome  Finger Pull		 PL-115 Matte Black  PL-116 Matte Nickel  PL-260 Aluminum  PL-261 White  PL-406 Gloss White  PL-407 Matte Chrome  PL-506 Gloss White  PL-507 Matte Chrome  Finger Pull	 PL-115 Matte Black  PL-116 Matte Nickel  PL-260 Aluminum  PL-261 White  PL-406 Gloss White  PL-407 Matte Chrome  PL-506 Gloss White  PL-507 Matte Chrome  Finger Pull

## Honey Options.



COMPUTER SUPPORT  
*single monitor arm*

Style Number	List Price
MA1	280

### Specifications

- Available in black or silver
- Desk clamp and mounting included
- Easy assembly and flexibility
- Elastic painting process for a durable and beautiful finish
- Gas spring tension adjustment for counter-balance height adjustment for monitors 1-8 KG
- Gas spring tested to 50,000 repetitions
- Hidden cable management



COMPUTER SUPPORT  
*double monitor arm*

Style Number	List Price
MA2	450

### Specifications

- Available in black or silver
- Desk clamp and mounting included
- Easy assembly and flexibility
- Elastic painting process for a durable and beautiful finish
- Gas spring tension adjustment for counter-balance height adjustment for monitors 1-8 KG
- Gas spring tested to 50,000 repetitions
- Hidden cable management

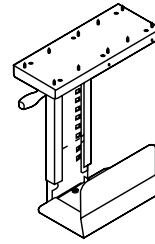

COMPUTER SUPPORT  
*cpu retractable cradle*

Style Number	List Price
K18	205

### Specifications

- Black Metal CPU Carriage
- Full 360° swivel capability allows easy access to rear of CPU for cables / wires
- Track allows 8- 1/2" extension
- Width Adjustment 5-1/2" to 9-1/4"
- Height adjustment 14- 5/8" to 20- 1/2"
- Black epoxy finish

- Notes
- Factory Installed

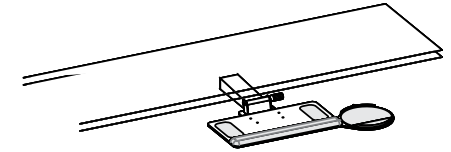

COMPUTER SUPPORT  
*articulating keyboard tray*

Style Number	List Price
Factory Installed K28	390
Field Installed K28F	415

### Specifications

- Adjusts effortlessly - A simple one-handed motion allows the keyboard to be repositioned instantly, without the use of locks or levers
- Encourages low-risk postures - Maximizes adjustability within a safe operating range.
- Will last a lifetime - Exceeds all applicable BIFMA Standards and comes with a lifetime guarantee.

- Notes
- Available on: Freestanding Desk
  - Factory Installed (standard)
  - FIELD INSTALL - \$415

## Honey Options.



### DOOR MODIFICATIONS *soft close door hinge*

Style Number	List Price
D9SC	20 Per door

### Specifications

- Snap onto standard door hinge
- Requires (2) per door
- Max door height 43"
- Factory installed where specified
- Individually shipped for field installation

#### Notes

- Specify Each Item To Have Slow Close Feature

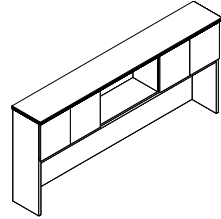

### DOOR MODIFICATIONS *delete doors*

Style Number	List Price
D6	N/C

### Specifications

- Standard Door overheads and cabinets can have door deleted for open access. Modification of hinge rails and structural components are made face ready.

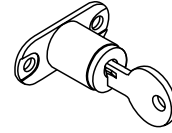

### DOOR MODIFICATIONS *panel door lock*

Style Number	List Price
D2	100 Per door set

### Specifications

- Door Locks - 1 Door w/ Lock, Other Door w/ Catch Latch
- Contact Customer Service regarding limited lock locations and keying.

#### Notes

- Available on: Panel Doors, Wood Frame Doors, and Silverluma doors

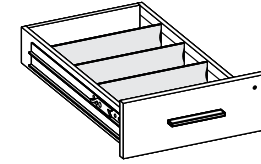

### DRAWER OPTIONS *box drawer accessories*

Style Number	List Price
Wood Drawer Dividers w/ Clips K-DIV	SET OF 3 - 30
Single Tray - Utility Tray K-Sut	35 ea.

### Specifications

- K-DIV Extra Wood Drawer Dividers with Clips, Top Box drawers standard with 1 divider
- K-SUT Single Tray - Utility Tray, Specify Legal or Letter drawer width

## Honey Options.

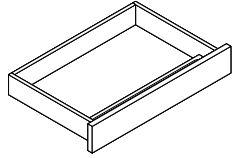

### DRAWER OPTIONS *finished center drawer*

Style Number	List Price
K31	205
Add Skirt Option K31-SK	310

### Specifications

- Veneer drawer front finished to match unit W or G style veneer.
- Ball bearing smooth operation
- Drawer has lifetime guarantee
- Standard with matching wood grain pencil tray
- Laminate drawer front to match laminate unit (M style)

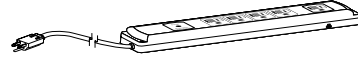

### POWER / DATA *power supply cordset*

Style Number	List Price
PD717	100

### Specifications

- SIZE: 10.75" L x 2.0" W x 1.06" H
- (5) Outlets w/ 10' cord
- Surge suppression (720 Joules)
- 15 Amp breaker
- Available on: Vertical Panels, Cabinet Interiors, and under tops

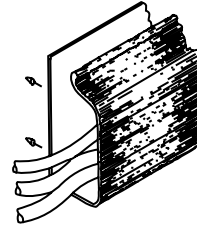

### WIRE MANAGEMENT *horizontal j-channel wire management raceway*

Style Number	List Price
W1	80 Per 4' section

### Specifications

- 4" section for field installation.
- The "J" shape black thermoplastic wire raceway may be added to specified worksurface tops to provide concealed channeling of wires to and from worksurface grommets. For use in open kneespace areas, raceway is attachable to top of back panel with pan head screws. Interior dimensions are 1" x 1- 1/2" providing ample storage for multiple wires and excess cable. Front of raceway flexes out for easy cord insertion.

#### Notes

- Units w/ Wire Channel Standard.
- Field Installation

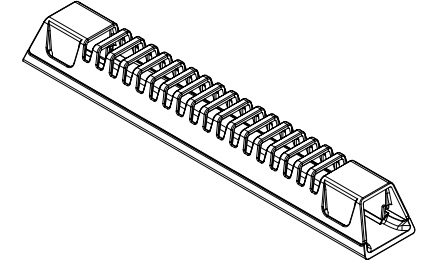

### WIRE MANAGEMENT *horizontal wire management raceway*

Style Number	List Price
W21	35

### Specifications

- 10"W x 1.5"D x 1.25"H
- Grey Wire Manager (10.5")
- Power and data cables can be discretely housed and managed with the W21 Gray Wire Manager. This can be mounted in any location to metal frame or underside of conference tables and runs cables through a 1" channel from power module to hollow steel legs. This keeps cables organized under the table top. Release clips make it simple to snap on and off the Wire Manager for easy organization and access after attached to the table

#### Notes

- Field installed

# Honey Options.



WIRE MANAGEMENT  
horizontal u-channel wire management raceway

Style Number	List Price
W2A	80 Per 4' section

## Specifications

- 4' section for field installation.

### Notes

- Units w/ Wire Channel Standard.
- Field Installation

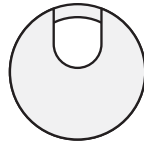

WIRE MANAGEMENT  
standard location grommets - factory installed

Style Number	List Price
Standard Location Grommet	
Black	
TM30	50
Silver	
TM31	50
White	
TM34	50

## Specifications

- 1 -5/8" Metal Grommet

### Notes

- \*Units w/ Grommets Standard Are Noted Under Standard Features. Grommets Match Pull Finish - Standard (Unless Specified Otherwise)

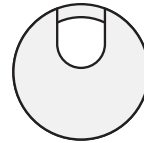

WIRE MANAGEMENT  
non-standard location grommets - factory installed

Style Number	List Price
Non-Standard Location Grommet	
Black	
TM30 -NS	95
Silver	
TM31 -NS	95
White	
TM34 -NS	95

## Specifications

- 1 -5/8" Metal Grommet

### Notes

- \*Units w/ Grommets Standard Are Noted Under Standard Features. Grommets Match Pull Finish - Standard (Unless Specified Otherwise)

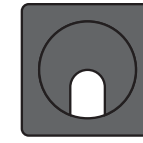

WIRE MANAGEMENT  
black plastic vertical surface grommets - factory installed

Style Number	List Price
Standard Location Grommet	
TM50-C	50
Non-Standard Location Grommet	
TM50-NS	95

## Specifications

- 2 " Black Plastic Grommet

### Notes

- Standard Location is Bottom Center

## power & data options.

Aircharge wireless charging grommet

Style Number	List Price
 ACWG WIRELESS GROMMET	\$195

## Specifications

- › When used with GROVE Tables an additional \$350 LIST will apply for the special cutout required.
- › AirCharge offers a convenient way to charge any Qi compatible smartphone or device without the need to carry charging cables or find an available power outlet.
- › The Aircharge is powered by the latest Qi compliant IC offering reliable and efficient wireless charging in a convenient 3" grommet hub. Simply place your phone on the Aircharge and an LED will confirm pairing and begin wireless charging.
- › Recess: Efficient space conservation and quick access
- › Input: DC 5V (with included AC power adapter), DC 9V, 1.67A (with optional QC 2.0 power adapter)
- › Output: 5 watts Max. with DC 5V, 2A power adapter, 10 watts Max. with QC 2.0 power adapter
- › Qi V1.2 compliant IC
- › Charging distance: 6mm Max.

Available: All DARRAN collections



## power & data options.

Cove power unit - non-linking

Style Number	List Price
 PD-COVE PLUG Non-linking version	\$550

### Specifications

- › Size 5.75"L x 2.5"W
- › (2) 15 Amp Receptacles and (2) USB charging ports
- › Surface Mount
- › 108" Cord
- › Standard Silver Finish, Available in White or Black Finish upon request
- › ETL Listed

Available: All DARRAN collections





## power & data options.

Soba wire manager

Style Number	List Price
STARTER UNITS	
SCDW	\$200
White wire manager	
SCDB	\$200
Black wire manager	

## Specifications



- › Dimensions: 9ft x 9in x 3.15in
- › Zips up, bundles and routes loose, messy cables into a single tube
- › Routes and guides cables behind desks, TVs, and anywhere cables tend to get messy
- › Accommodates large or small cables, up to three cables at once
- › Support channels, used to route cables, include powerful adhesive backing which allows easy attachment to surfaces.

Available: All DARRAN collections



## power & data options.

VILLA Power unit with daisylink

Style Number	List Price
STARTER UNITS	
 VIL-DCH HARDWIRED	\$600
Includes (1) Villa unit with 120" Hardwire Infeed	
 VIL-DCP PLUG	\$695
Includes (1) Villa with Plug Infeed - Includes 72" Cord and 32" Infeed Jumper for 104" total cord infeed	
ADDITIONAL LINKING UNITS	
VIL-DCL ADDITIONAL	\$590
(Includes linking Villa and Jumper cable up to 96")	

## Specifications

- › Size: Top Grommet 5.68"L X 3.39"W; Under Top 12"L x 3.13"W x 3.08"D
- › (4) Power receptacles; (2) surface and (2) undersurface, (2) 2.1A USB charging ports and (1) Knockout for RJ45 Data Port
- › Surface Mount
- › Daisy Chain - Hardwire Max (10) Units, Plug/Corded Max (5) Units
- › Standard Silver Finish, Black Finish available upon request
- › UL or ETL Certified

Available: All DARRAN collections, excludes grove

RJ45 Knockout	
RJ45 (1)	\$35

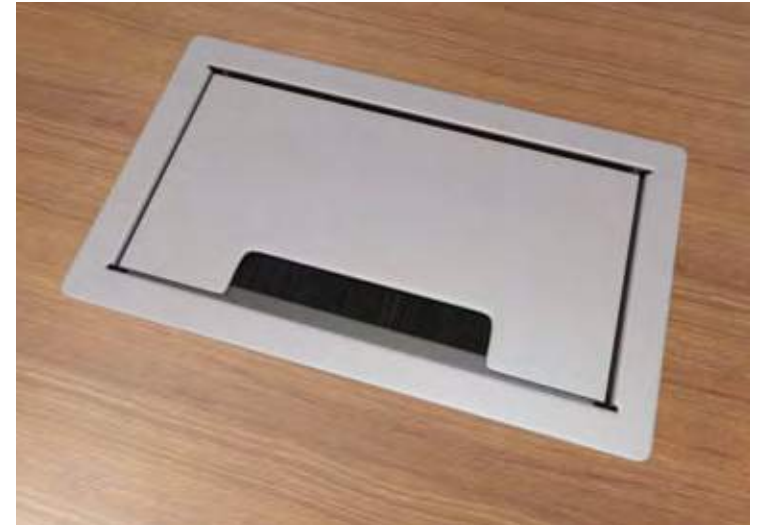

## power & data options.

Tully power unit

Style Number	List Price
 PD-TULLY	\$320
Select power block to link workstations	

### Specifications

- › 5.5" W x 3.2" H x 1.81" D
- › Finish: Smooth molded plastic integrated within a single piece cover
- › Mounts to the edge of your work surface, with no table cut outs or installation required.
- › (2) Power receptacles, (2) USB 2.1 Amp ports
- › 72" Cord (10' cord available, contact customer service).
- › Standard in White. Available in gray, black, neon red, harvest pumpkin, light green, daisy blue.
- › UL310, Class 2, FCC Part 15A approved
- › Clamp accessory accomodates table thickness from .75"-1.5"

Available: Honey, EdgeWorks, NSS Open, Rail, Rail Open Office, Thinking Quietly.

#### Power Block

With 120" hardwire power cord.

Two Pack Power Block System: 2PPBS	\$390
Four Pack Power Block System: 4PPBS	\$750
Six Pack Power Block System: 6PPBS	\$1100

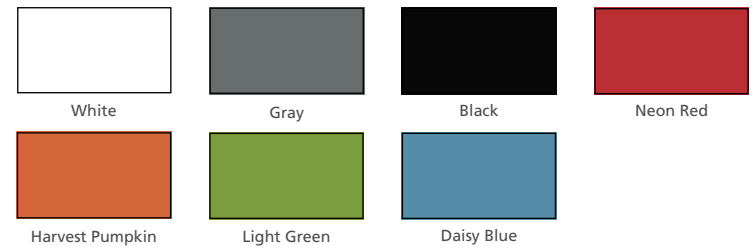

## power & data options.

### Keno power unit

Style Number

List Price



PD-KENO

\$195

Select power block to link workstations

## Specifications

- > Size 5.5" L x 2.125" W x 2.5" H
- > 2 TR AC Outlets
- > 1 4.2A USB module w/ 2 charging ports
- > 10' Power cord

Available: Honey, EdgeWorks, NSS Open, Rail, Rail Open Office, Thinking Quietly

### Telecom Plates

With 120" hardwire power cord.

Two Pack Power Block System: 2PPBS \$390

Four Pack Power Block System: 4PPBS \$750

Six Pack Power Block System: 6PPBS \$1100



White



Black

## power & data options.

Nuuk single power unit with undersurface mount

Style Number	List Price
 PD-NUUK1-UM	\$290











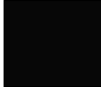













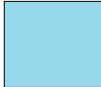

### Specifications

- > 1 AC receptacle with (1.5A) and fast-charging (2.4A) USB ports for rapid re-charging
- > 6' Power cord, available in black or white
- > Optional fabric woven cord in Graphite or Ivory - \$50
- > UL962A listed
- > UL1310 listed power supply
- > Size: 4.44" L x 4.11" x 2.33H
- > Undersurface mount



Available: On all DARRAN collections



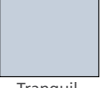

#### Step 1: Select Body Color

 White	 Black	 Cayenne	 Clementine	 Cranberry
 Currant	 Dijon	 Eggplant	 Forest	 Goldenrod
 Grape	 Gulf	 Kiwi	 Maize	 Marine
 Merlot	 Ocean	 Paprika	 Pineapple	 Porcelain
 Pumpkin	 Punch	 Raisin	 Silver-Sage	 Silver
 Sky	 Spruce	 Teal	 Tranquil	

#### Step 2: Select AC Receptacle Color

 White	 Linen	 Black
--	--	--

#### Step 3: Select Cord Color

 Ivory +\$50	 Graphite +\$50	 Black	 White
--	---	--	--

## power & data options.

Nuuk dual power unit with undersurface mount

Style Number	List Price
 PD-NUUK2-UM	\$335



### Specifications

- > 2 AC receptacle with (1.5A) and fast-charging (2.4A) USB ports for rapid re-charging
- > 6' Power cord, available in black or white
- > Optional fabric woven cord in Graphite or Ivory - \$50
- > UL962A listed
- > UL1310 listed power supply
- > Size: 6.11" L x 4.11" W x 2.33" H
- > Undersurface mount



Available: All DARRAN collections





#### Step 1: Select Body Color

 White	 Black	 Cayenne	 Clementine	 Cranberry
 Currant	 Dijon	 Eggplant	 Forest	 Goldenrod
 Grape	 Gulf	 Kiwi	 Maize	 Marine
 Merlot	 Ocean	 Paprika	 Pineapple	 Porcelain
 Pumpkin	 Punch	 Raisin	 Silver-Sage	 Silver
 Sky	 Spruce	 Teal	 Tranquil	

#### Step 2: Select AC Receptacle Color

 White	 Linen	 Black
--	--	--

#### Step 3: Select Cord Color

 Ivory +\$50	 Graphite +\$50	 Black	 White
--	---	--	--

## power & data options.

Nuuk single power unit with clamp

Style Number	List Price
 PD-NUUK1-CL	\$325

### Specifications

- > 1 AC receptacle with (1.5A) and fast-charging (2.4A) USB ports for rapid re-charging
- > 6' Power cord, available in black or white
- > Optional fabric woven cord in Graphite or Ivory - \$50
- > UL962A listed
- > UL1310 listed power supply
- > Size: 4.44"L x 4.35"W x 3.03"H
- > Clamp mount: clamps onto surfaces of 3/4-1-1/4" thickness



Available: On all DARRAN collections, excluding Grove

#### Step 1: Select Body Color

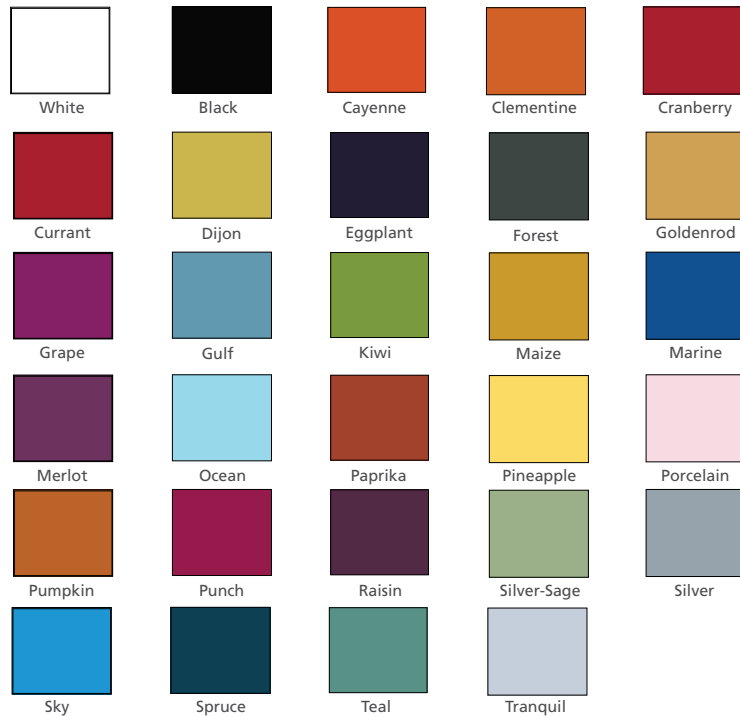

#### Step 2: Select AC Receptacle Color



#### Step 3: Select Cord Color



## power & data options.

Nuuk dual power unit with clamp

Style Number

List Price



PD-NUUK2-CL

\$375

## Specifications

- > 2 AC receptacle with (1.5A) and fast-charging (2.4A) USB ports for rapid re-charging
- > 6' Power cord, available in black or white
- > Optional fabric woven cord in Graphite or Ivory - \$50
- > UL962A listed
- > UL1310 listed power supply
- > Size: 6.11"L x 4.35"W x 2.33"H
- > Clamp mount: clamps onto surfaces of 3/4-1-1/4" thickness

Available: All DARRAN collections, excluding Grove

### Step 1: Select Body Color



White



Black



Cayenne



Clementine



Cranberry



Currant



Dijon



Eggplant



Forest



Goldenrod



Grape



Gulf



Kiwi



Maize



Marine



Merlot



Ocean



Paprika



Pineapple



Porcelain



Pumpkin



Punch



Raisin



Silver-Sage



Silver



Sky



Spruce



Teal



Tranquil

### Step 2: Select AC Receptacle Color



White



Linen



Black

### Step 3: Select Cord Color



Ivory +\$50



Graphite +\$50



Black



White





# Jamestown price list



# Jamestown price list revisions

Date Page Modification Description



## Jamestown table of contents

Statement of Line	
Features & Advantages .....	1
Finishes   Specifications .....	3
Edges   Pulls   Knobs.....	4
Grommets   Grommet Reference.....	5
Ganging   Height Reference .....	6
Modesty Reference   Grain Direction .....	7
Drawer Dimensions   FILING Reference .....	8
Double Pedestal Desk.....	9
Table Desk .....	11
Single Pedestal Desk .....	12
Service Desk.....	14
Returns.....	15
Bridges .....	17
Freestanding Credenzas .....	18
Workstation Credenzas.....	24
Single Height Freestanding Overheads .....	26
Double Height Freestanding Overheads.....	28
Overhead Accessories .....	30
Single Height Wall Hung Overheads.....	34
Wall Hung Accessories .....	36
Overhead Bookcases .....	41
Vertical Full Towers.....	43
Bookcases.....	45
Options.....	47
Power & Data .....	62

# Jamestown statement of line

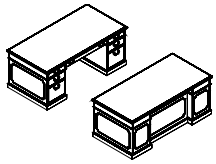

PAGE 9  
Double Pedestal Desks

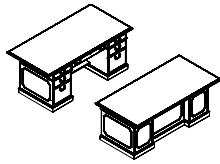

PAGE 10  
Double Pedestal Desks

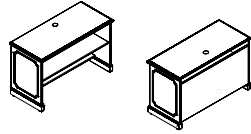

PAGE 11  
Table Desks

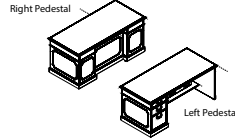

PAGE 12  
Workstation Desk

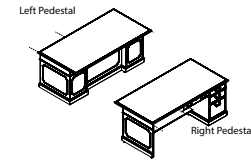

PAGE 13  
Workstation Desk

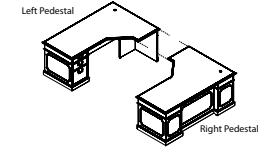

PAGE 14  
Service Workstation Desk

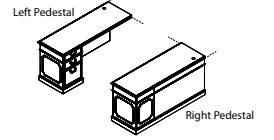

PAGE 15  
"L" Workstation Returns

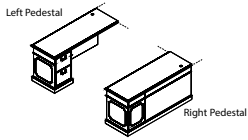

PAGE 16  
"L" Workstation Returns

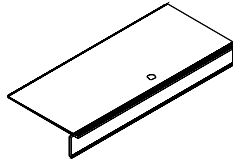

PAGE 17  
"U" Workstation Bridges

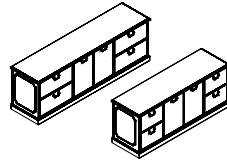

PAGE 18  
Credenzas

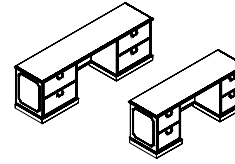

PAGE 19  
Credenzas

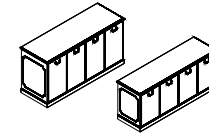

PAGE 20  
Storage Credenza

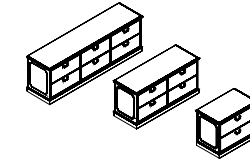

PAGE 21  
Lateral File Credenzas

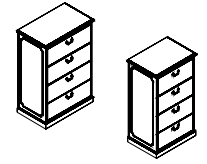

PAGE 22  
Lateral File Credenzas

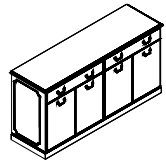

PAGE 23  
Buffet Credenza

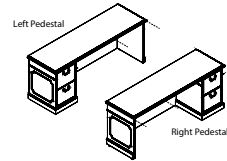

PAGE 24  
Workstation Credenzas

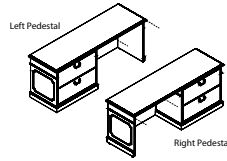

PAGE 25  
Workstation Credenzas

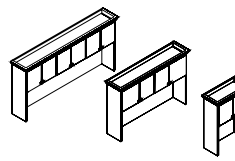

PAGE 26  
Single Height Overheads

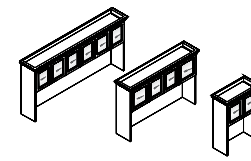

PAGE 27  
Single Height Overheads

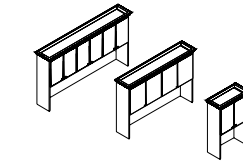

PAGE 28  
Double Height Overheads

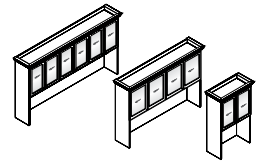

PAGE 29  
Double Height Overheads

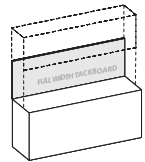

PAGE 30  
Overhead Tackboards

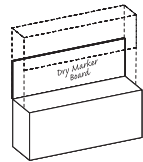

PAGE 31  
Overhead Dry Marker Boards

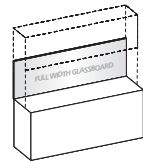

PAGE 32  
Overhead Glassboards

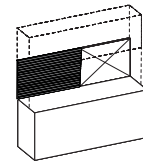

PAGE 33  
Overhead Slat Wall

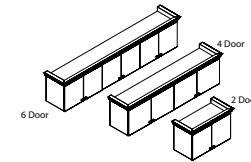

PAGE 34  
Single Height Wall Hung Overheads

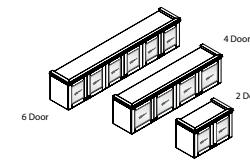

PAGE 35  
Single Height Wall Hung Overheads

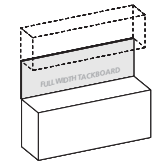

PAGE 36  
Wall Hung Tackboards

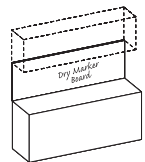

PAGE 37  
Wall Hung Dry Marker Boards

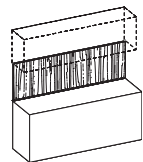

PAGE 38  
Wall Hung Veneer Panels

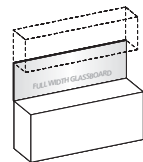

PAGE 39  
Wall Hung Glassboards

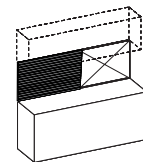

PAGE 40  
Wall Hung Slat Wall

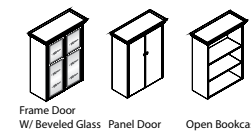

PAGE 41  
Single Height Overhead

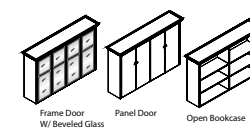

PAGE 42  
Single Height Overhead

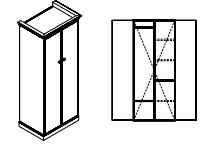

PAGE 43  
Tower Cabinets



# Jamestown statement of line

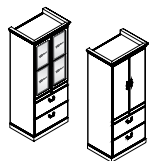

PAGE 44  
Tower Cabinets

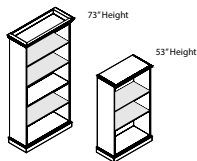

PAGE 45  
Bookcases

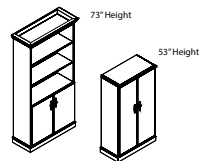

PAGE 46  
Bookcases



## Jamestown features & advantages

### Veneer

DARRAN only uses HPVA AA Grade Flat Cut Cherry and Walnut Veneers. All veneers are selected and matched for balance and consistency.

### Veneer Tops

Jamestown veneer tops feature a 45-pound density substrate with balanced 3-ply construction. Tops are 1-5/16" thick on MDF core comprised of 100% recycled and recovered wood fibers. All veneer tops are slipmatched and feature a 3mm external solid hardwood band or profile edge.

### Laminate Tops

Jamestown high-pressure laminate tops feature a 45-pound density substrate with balanced 3-ply construction. Tops are 1-5/16" thick on MDF core comprised of 100% recycled and recovered wood fibers. All high pressure laminate tops are available with a profile edge, laminate self-edge or 2mm PVC edge band. Laminates in wood grain patterns feature a fine grain texture that features the polish and luxe of a real wood veneer with a subtle narrow grain structure.

### Cleaning wood & laminate

In addition to regular dusting, give your furniture an occasional cleaning in accordance with our cleaning instructions. DARRAN wood and laminate products can be cleaned with a soft cloth and a mild soap and water mixture. Use approximately 32 oz of water mixed with one tablespoon of dish soap, always wiping with the grain. Dry with a soft cloth, going with the grain, to avoid spotting or streaking.

Wood products should be waxed periodically using a non-wax liquid; please do not use any waxy polish or cleaner. Interior of drawers may also be cleaned with mild soap and water mixture, or any household cleaner that is not petroleum or thinner-based.

### Chassis & pedestal

Chassis components are 3/4" thick core of particle board or MDF rated EPP/SCS/CARB-II material with 3-ply balanced construction. Pedestal and Cabinets feature dowel construction reinforced with steel bracket plates, wood cleats, screws and glue. All units are standard with 1" adjustable glides that allow for leveling of units that are secured in solid wood glide blocks to prevent tear out.

### Overhead cabinet construction

#### Freestanding & wall mount

Freestanding Overhead storage cabinets are constructed of 1" and 3/4" thick core of particle board or MDF rated EPP/SCS/CARB-II material with 3-ply balanced construction. Panels are attached with cam fasteners in conjunction with dowels securely adhered with glue. All surface mount cabinets connect to work surface with anti-slip

tape. Wall mount cabinets are mounted to the wall with steel "z" bracket attachment method using 5mm euro screws to attach to the back of the cabinet. All units ship with a steel "z" bracket. This bracket is mounted to the wall by field installers. Installers are responsible for selecting and supplying appropriate fasteners for wall conditions.

### Bookcase construction

All chassis (sides, back, top and bottom panels) are constructed with 3/4" thick core of particle board or MDF rated EPP/SCS/CARB-II material with 3-ply balanced construction. Panels are attached with cam-lock fasteners in conjunction with dowels securely adhered with glue. Shelves on all units are 3/4" thick balance 3 ply panels. Optional heavy duty shelves are 1" thick lumber core balanced 5 ply construction.

### Tackboards

Wall mount tackboards are constructed of .75" thick fiberboard. The fabric is precisely aligned and fitted to the tackboard with a sock on cover. Overhead storage tackboards are constructed of .75" thick fiberboard. The fabric is precisely aligned and fitted to the tackboard and adhered to the rigid hardboard with staples. Wall mount cabinets are mounted to the wall with steel "z" bracket attachment method using 5mm euro screws to attach to the back of the cabinet. All units ship with a steel "z" bracket. This bracket is mounted to the wall by field installers. Installers are responsible for selecting and supplying appropriate fasteners for wall conditions.

### Adjustable glides

Glides provide 1" of vertical leveling adjustment. Glide bottom is durable metal. Glides are secured in solid wood blocks that are screwed and glued for durability.

### Drawers

All drawers are constructed of four sides and a bottom, which are attached to a drawer front with screws for easy removal. Drawer fronts are vertically matched in balanced sets. Pencil trays are standard in all box drawers. Drawers are constructed of maple veneer 1/2" thick material for drawer sides, fronts and backs with a UV finish for maximum durability. Drawer bottoms are 3/16" thick 3-ply maple veneer. Drawer boxes are assembled at each corner with dowel joinery for maximum drawer strength. Lifetime free replacement warranty.

### Standard Wood Drawers

Optional hardwood veneer plywood drawers feature banded top and bottom edges for smoothness. Drawers are dowel joint construction with a UV cured finish over maple veneers, plus a lifetime free replacement guarantee.

## Jamestown features & advantages

### Drawer Fronts

Drawer fronts are vertically matched in balanced sets. Doors feature vertical veneer bookmatched horizontally in sets of 2 / 4 and 6 doors. All drawers and doors have traditional scallop profile edge shape. All tower fronts matched in vertical sets.

### Suspensions

All casegoods utilize cold rolled steel zinc plated high-grade drawer suspensions. Box and File drawers are full extension, featuring steel ball bearings for a smoother quieter range of motion with soft close operation and are rated 100lbs. Lateral file drawers are a progressive action full extension suspension with the soft close operation and is rated at 150lbs. Lateral files include anti tip mechanism that will allow only one drawer at a time to be opened. All suspensions are soft close and are warranted for the lifetime of the product.

### Hinges

Units with doors include 95 degree swing hinges.

### Filing

Jamestown features metal file frames around the perimeter of the drawers with cross bars secured to the drawer sides to support hanging files. A metal adjustable cross bar is standard with all file drawers to support letter/legal filing front to back or side to side. File drawers have one adjustable cross bar and lateral files have two adjustable cross bars. See filing reference for details.

### Locks

Locks are Standard on all drawers below the worksurface. Random lock cores are installed at the factory. Some units may be shipped with the same key number. Locks are Silver, Black or Bronze and match pull finish unless otherwise specified.

DARRAN will also send lock cores separately to the dealer at your request. These units will be send with an empty lock core and the Dealer will receive a shipment of the requested lock core/keys.

### Keying

Keying is available either factory or field installed. Factory installed keying is random.

### Wire management

Wire management capabilities include standard and optional worksurface grommets. Specify W-1 under surface wire channels for organization and management of all communication wires and cords. Horizontal J-Channel wire management (Sku: W-1) is sold separately to conceal wire under worksurfaces.

### Grommets

Metal grommets are provided to match the drawer pull selection. Grommet is available in black, silver, white or antique brass. Must specify standard or non-standard location. Black plastic grommets are available as an option for vertical applications.

### Powerports

A large selection of power pods are available and handle power, data, docking stations and communication. See options section for selection..

### LED tasklights

LED task lighting provides high efficiency, low energy lighting with a long life. Recessed light is encased in silver aluminum channel with milk lense and rounded end caps. Lights are factory installed.

Product specifications listed below:

- Diffuser creates a softer light and eliminates hot spots
- Touch dimmer switch
- Can be "daisy chained" up to 90W
- 4.6 watts per foot
- 120 LEDs per meter
- Certification: UL Listed
- 50,000 hour life span.

Color Temp is 4000K

## Jamestown finishes | specifications

STANDARD VENEER	PREMIUM VENEER	HIGH PRESSURE LAMINATE	THERMALLY FUSED LAMINATE
WAC Amber Cherry .....	N/A .....	GAC Amber Cherry.....	N/A
WRC Caramel Cherry.....	N/A .....	N/A .....	N/A
WIC Crimson Cherry .....	N/A .....	GIC Crimson Cherry .....	N/A
WHC Honey Cherry .....	N/A .....	GHC Honey Cherry .....	N/A
WOC Koko Cherry.....	N/A .....	GOC Koko Cherry.....	N/A
WEW Executive Walnut.....	N/A .....	GEW Executive Walnut.....	N/A
WGW Gunstock Walnut.....	N/A .....	N/A .....	N/A
WBW Henna Walnut.....	N/A .....	N/A .....	N/A
WSW Smokey Walnut.....	N/A .....	N/A.....	N/A
WNW Natural Walnut .....	N/A .....	GNW Natural Walnut .....	N/A

Send 3x3 or larger finish chip for color match. Custom finish upcharge is 3% or \$250 Net (whichever is greater).

### Finish

ENVI-CT Green Certified European Technology Coatings Finish.



Jamestown edges | pulls | knobs

**Jamestown Edge**  
 Hardwood Rim Band Species Same As  
 Surface Veneer

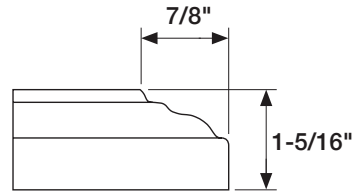

**Hookup edge profile**  
 Coped Edge

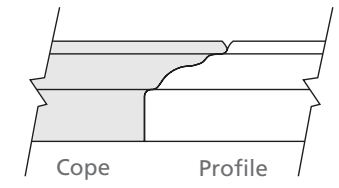

**Hardwood beltline molding**

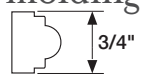

**Scalloped molding**

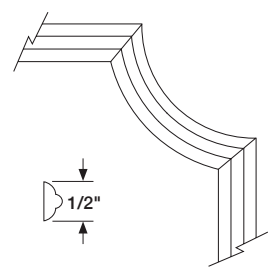

**Pulls/knobs**  
 Factory Installed

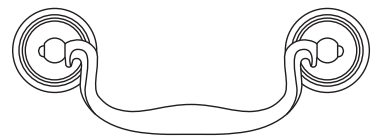

PL-5 Antique Brass  
 PL-50 Brushed Pewter

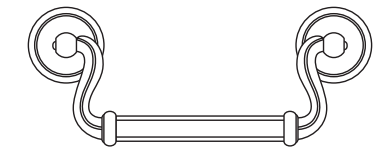

PL-4 Antique Brass

**Cornice top profile**

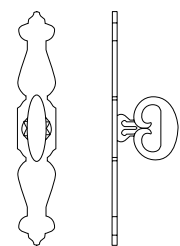
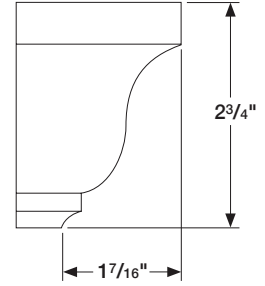

DK-5 Antique Brass  
 DK-50 Brushed Pewter

**Base profile**

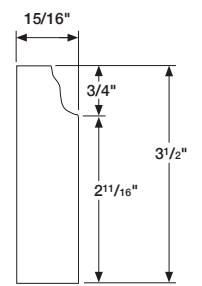

**Drawer/door edge profile**

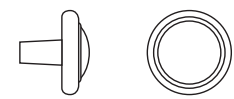
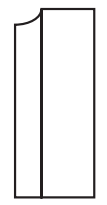

DK-4  
 Antique Brass

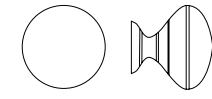

DK-114  
 Brush Pewter

# Jamestown grommets | grommet reference

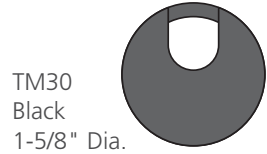

TM30  
Black  
1-5/8" Dia.

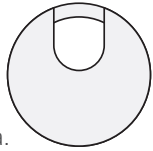

TM31  
Silver  
1-5/8" Dia.

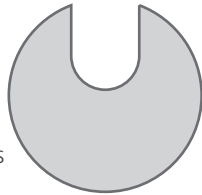

TM33  
Antique Brass  
2-1/2" Dia.

## Optional grommets

Factory Installed

Grommets (Standard Location)

Specify Color and Left/Right/Center - \$50 ea.

- Black: TM30-R (Right), TM30-L (Left), TM30-C (Center)

- Silver: TM31-R (Right), TM31-L (Left), TM31-C (Center)

- Antique Brass: TM33-R (Right), TM33-L (Left), TM33-C (Center)

Grommets (Non-Standard Location)

Provide drawing w/ Grommet Location and Specify Color - \$95 ea.

- Black: TM30-NS

- Silver: TM31-NS

- Antique Brass: TM33-NS

TM50  
Black  
1-5/8" Dia.

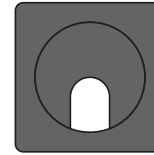

## Grommets (vertical surface)

Standard Location - \$50 ea.

- Black Plastic Vertical Surface: TM50-C (Bottom Center)

Non-Standard Location - \$95 ea.

- Black Plastic Vertical Surface: TM50-NS

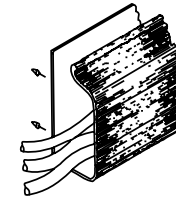

W1

## Horizontal J-Channel

Horizontal J-Channel wire management (Sku: W-1) is sold separately to conceal wire under worksurfaces.

## Standard grommet location reference



Desk  
Specify Right or Left Grommet

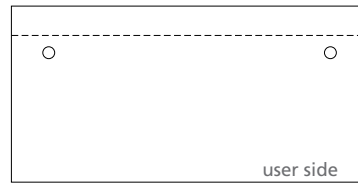

6" Overhang Desk  
Specify Right or Left Grommet

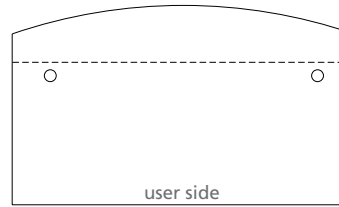

6"/12" Bow Front Desk  
Specify Right or Left Grommet



Bullet Conference Desk (Right Post)  
Center Grommet

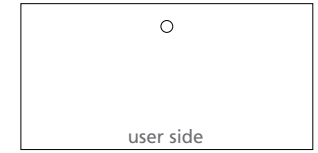

Bridge  
Center Grommet

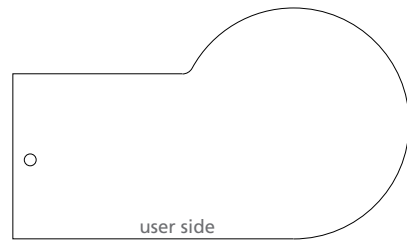

P Conference Desk (Right Post)  
Center Grommet



Return (Left Pedestal Shown)  
Right Pedestal - Left Grommet  
Left Pedestal - Right Grommet



Workstation Credenza  
Center Kneespace Grommet

## Jamestown ganging | height reference

### Ganging – flush cut modification

30”H Casegood Worksurface & Base Ganging Modifications

To gang two casegood units, each unit end to be ganged must be flush cut modified for gapless surfaces and cabinet chassis.

Order Option:

- FC-B: Flush Unit Both Sides(Facing) for Ganging - \$100
- FC-L: Flush Unit Left (Facing) for Ganging - \$100
- FC-R: Flush Unit Right (Facing) for Ganging - \$100

Flush cut modification per unit includes all modifications to gang to one end or both ends when units are ganged. Modification includes tops, base and molding. Modification reduces width size approximately 1” per end.

Overhead consoles and towers are offered freestanding and ganging – inclusive of flush cut modifications.

Example:

JCM3124CA104W Two Drawer Lateral File (Left) Flush Cut Right – FC-R...\$100

JCM7224CA054W Kneespace Credenza (Right) Flush Cut Left – FC-L...\$100

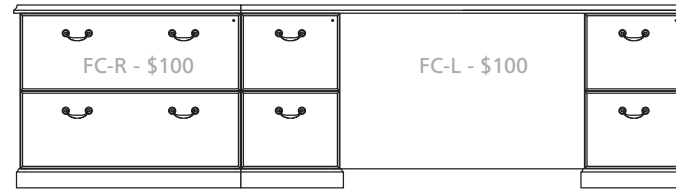

## Height reference

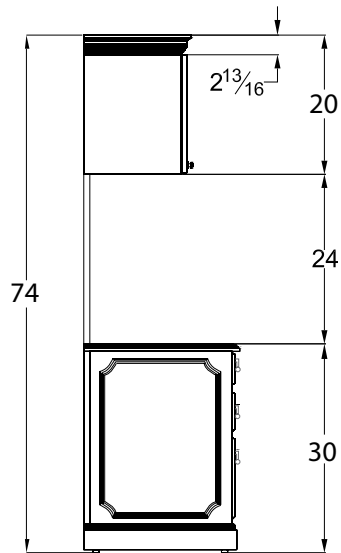

Typical Single Height Side Profile Wall Hung Overhead

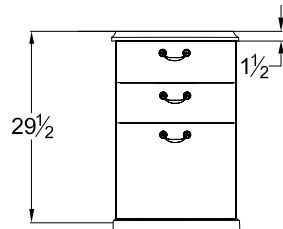

Pedestal Front Profile Box/Box/File

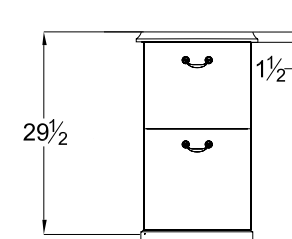

Pedestal Front Profile File/File

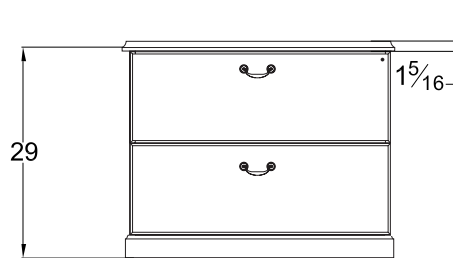

Pedestal Front Profile Lateral File

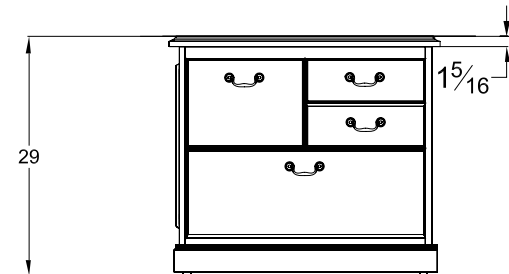

Pedestal Front Profile Multi-File

# Jamestown modesty reference | grain direction

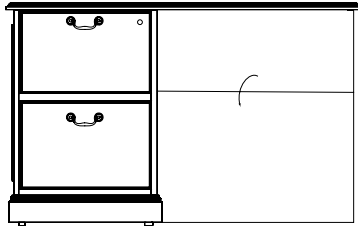

**M34**  
Drop Door Tech Modesty

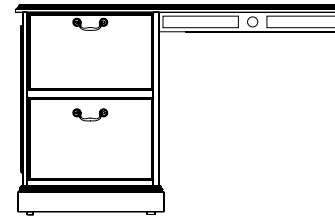

**M51**  
Open Back Modesty with 4" Wire Management Rail

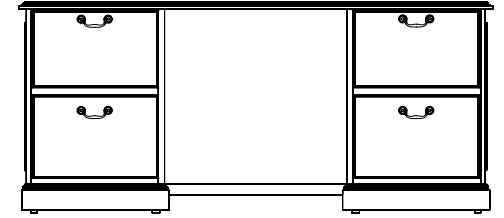

**M37**  
Fixed Full Modesty

## Grain direction

Veneer chassis parts are vertical grain. The backs of Thermally Fused Laminate overheads, wall hungs, wall hung shelves and flush chassis desks are horizontal grain. Bridges, returns, and credenza kneespace Thermally Fused Laminate backs over 60" are horizontal grain. Doors feature vertical veneer bookmatched horizontally in sets of 2,4, and 6 doors. Tower fronts are matched in vertical sets.

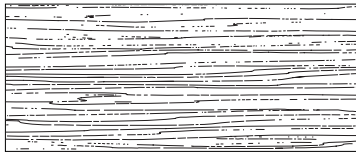

Desk

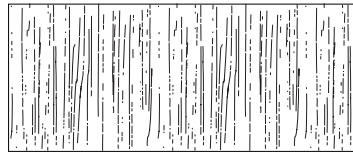

Runoff Desk  
Grain Direction on TFL  
Units Above 66" runs end to end

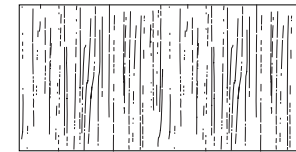

Bridge  
Grain Direction on TFL  
Units Above 66" runs end to end

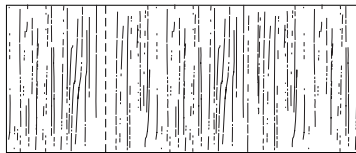

Return  
Grain Direction on TFL Units Above 66" runs end to end

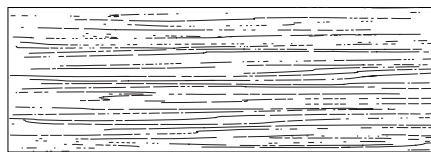

Credenza

# Jamestown drawer dimensions | filing reference

## Interior drawer dimensions

UNIT DEPTH	DRAWER	OVERALL DIM			INTERIOR DIM			NOTES
		W	D	H	W	D	H	
15-5/8" Letter	36" Shallow Box	13-1/8	19-11/16	2-9/16	12-1/8	18-11/16	2	Units less than 72"
	36" Box	13-1/8	19-11/16	4	12-1/8	18-11/16	3-7/16	Units less than 72"
	36" File	13-1/8	19-11/16	9-13/16	12-1/8	18-11/16	9-5/16	Units less than 72"
	30" Shallow Box	13-1/8	19-11/16	2-9/16	12-1/8	18-11/16	2	Units less than 72"
	30" Box	13-1/8	19-11/16	4	12-1/8	18-11/16	3-7/16	Units less than 72"
	30" File	13-1/8	19-11/16	9-13/16	12-1/8	18-11/16	9-5/16	Units less than 72"
	24" Shallow Box	13-1/8	16-1/16	2-9/16	12-1/8	15-1/16	2	Units less than 72"
	24" Box	13-1/8	16-1/16	4	12-1/8	15-1/16	3-7/16	Units less than 72"
	24" File	13-1/8	16-1/16	9-13/16	12-1/8	15-1/16	9-5/16	Units less than 72"
	18-9/16" Legal	36" Shallow Box	16-1/16	19-11/16	2-9/16	15-1/16	18-11/16	2
36" Box		16-1/6	19-11/16	4	12-1/8	18-11/16	3-7/16	Units 72" & above
36" File		16-1/6	19-11/16	9-13/16	12-1/8	18-11/16	9-5/16	Units 72" & above
30" Shallow Box		16-1/16	19-11/16	2-9/16	15-1/16	18-11/16	2	Units less than 72"
30" Box		16-1/6	19-11/16	4	12-1/8	18-11/16	3-7/16	Units 72" & above
30" File		16-1/6	19-11/16	9-13/16	12-1/8	18-11/16	9-5/16	Units 72" & above
24" Shallow Box		16-1/16	16-1/16	2-9/16	15-1/16	15-1/16	2	Units less than 72"
24" Box		16-1/6	16-1/16	4	12-1/8	15-1/16	3-7/16	Units less than 72"
24" File		16-1/6	16-1/16	9-13/16	12-1/8	15-1/16	9-5/16	Units less than 72"
29" Lateral		24" File	26-1/2	16-1/16	9-13/16	25-1/2	15-1/16	9-5/16
35" Lateral	24" File	32-1/2	16-1/16	9-13/16	31-1/2	15-1/16	9-5/16	Workstation Credenzas over 83"

## Filing reference

### Filing for 24" depth units

13 1/8" Wide File Drawer - 16 1/16" Deep

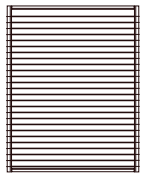

Letter Front to Back

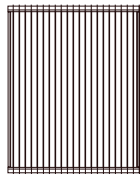

Legal Side to Side with File Rail

### Filing for 30" & 36" depth units

13 1/8" Wide File Drawer - 19 11/16" Deep

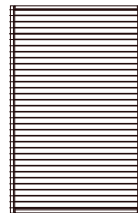

Letter Front to Back

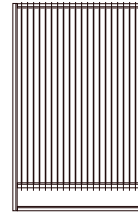

Legal Side to Side with File Rail

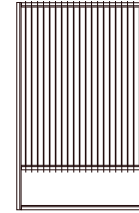

Letter Side to Side with File Rail

### 29" Lateral file drawer

26-1/2" Wide File Drawer - 16-1/16" Deep

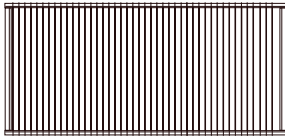

Legal Side to Side

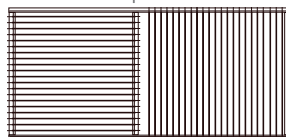

Legal Side to Side Letter Front to Back with File Rail

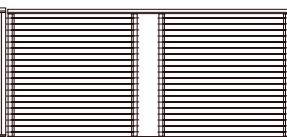

Letter Front to Back with File Rail

### 35" Lateral file drawer

32-1/2" Wide File Drawer - 16-1/16" Deep

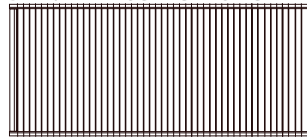

Legal Side to Side

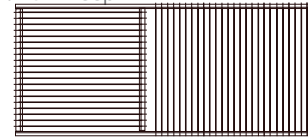

Legal Side to Side Letter Front to Back with File Rail

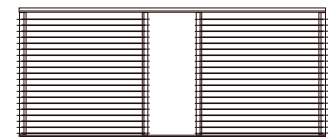

Letter Front to Back with File Rail

# Jamestown.

Double Pedestal Desks  
Executive / Breakfront

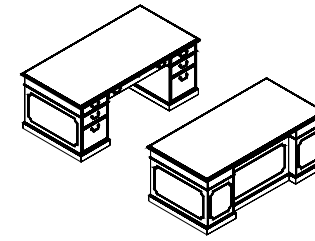

## 1 Select a model

w" x d" x h"	weight	Standard Veneer Top Standard Veneer Chassis	Premium Veneer Top Premium Veneer Chassis	High Pressure Laminate Top Veneer Chassis	Thermally Fused Laminate Top Thermally Fused Laminate Chassis
84 x 36 x 30	395	JCM8436DD000W 5486	"P" Option N/A	JCM8436DD000G 5486	"M" Option N/A
72 x 36 x 30	325	JCM7236DD000W 4740	"P" Option N/A	JCM7236DD000G 4740	"M" Option N/A
72 x 30 x 30	300	JCM7230DD000W 4626	"P" Option N/A	JCM7230DD000G 4626	"M" Option N/A
66 x 36 x 30	300	JCM6636DD000W 4626	"P" Option N/A	JCM6636DD000G 4626	"M" Option N/A
66 x 30 x 30	315	JCM6630DD000W 4122	"P" Option N/A	JCM6630DD000G 4122	"M" Option N/A
60 x 30 x 30	290	JCM6030DD000W 3966	"P" Option N/A	JCM6030DD000G 3966	"M" Option N/A

[View statement of line](#)

## 2 Select a finish

[View finish details](#)

WAC  
WRC  
WIC  
WHC  
WOC  
WEW  
WGW  
WBW  
WNW

GAC  
GIC  
GHC  
GOC  
GEW  
GNW

## 3 Select a edge

[View edge details](#)



## 4 Select hardware

[View hardware details](#)



## Product features.

- 6" Recessed modesty
- Box/Box/File
- Front profile shaped all edges
- Full extension wood drawers - locking
- Kneespace storage shelf
- Laminate pull out writing shelf
- Soft close suspension drawer(s)
- Traditional center drawer standard

## Options.

### ACCESSORIES

- K21: Traditional pull-out drawer w/ keyboard tray - \$470

### GROMMET (STANDARD LOCATION)

Specify Color and Location Right/Left - \$50 ea.

- Black: TM30-R (Right), TM30-L (Left)
- Silver: TM31-R (Right), TM31-L (Left)
- Antique Brass: TM33-R (Right), TM33-L (Left)

### GROMMETS (NON-STANDARD LOCATION)

Provide drawing w/ Grommet Location and Specify Color - \$95 ea.

- TM30-NS: Black Specify Location
- TM31-NS: Silver Specify Location
- TM33-NS: Antique Brass Specify Location

### LOCKING

- CL-01: Central locking - \$160

### MOLDING

- DSM1: Delete Scalloped Only - Deduct \$95

### WORKSTATION

- CP-3: Client pull out on approach - \$445

# Jamestown.

Double Pedestal Desks  
Overhang / Breakfront

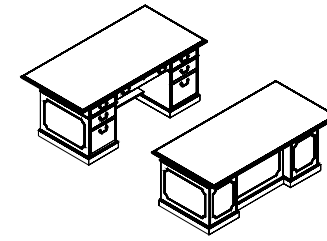

1 Select a model w" x d" x h"	weight	Standard Veneer Top Standard Veneer Chassis		Premium Veneer Top Premium Veneer Chassis		High Pressure Laminate Top Veneer Chassis		Thermally Fused Laminate Top Thermally Fused Laminate Chassis	
		<b>72 x 36 Chassis</b> 84 x 42 x 30	410	JCM8442DD037W	5887	"P" Option N/A	JCM8442DD037G	5887	"M" Option N/A
<b>72 x 30 Chassis</b> 84 x 36 x 30	375	JCM8436DD037W	5199	"P" Option N/A	JCM8436DD037G	5199	"M" Option N/A		
<b>66 x 30 Chassis</b> 72 x 36 x 30	325	JCM7236DD037W	4740	"P" Option N/A	JCM7236DD037G	4740	"M" Option N/A		
<b>66 x 24</b> 72 x 30 x 30	280	JCM7230DD037W	4512	"P" Option N/A	JCM7230DD037G	4512	"M" Option N/A		

2 Select a finish <i>View finish details</i>	WAC WRC WIC WHC WOC WEW WGW WBW WNW	GAC GIC GHC GOC GEW GNW

3 Select an edge <i>View edge details</i>	Traditional	Traditional

4 Select hardware <i>View hardware details</i>	PL-4 Antique Brass	PL-5 Antique Brass PL-50 Brushed Pewter	PL-4 Antique Brass	PL-5 Antique Brass PL-50 Brushed Pewter

[View statement of line](#)

## Product features.

- 6" Recessed modesty
- Beltline molding
- Box/Box/File
- Full extension wood drawers - locking
- Kneespace storage shelf
- Laminate pull out writing shelf
- Soft close suspension drawer(s)
- Traditional center drawer standard

### NOTES

- 6" overhang on approach

## Options.

### ACCESSORIES

- K21: Traditional pull-out drawer w/ keyboard tray - \$470

### GROMMET (STANDARD LOCATION)

Specify Color and Location Right/Left - \$50 ea.

- Black: TM30-R (Right), TM30-L (Left)
- Silver: TM31-R (Right), TM31-L (Left)
- Antique Brass: TM33-R (Right), TM33-L (Left)

### GROMMETS (NON-STANDARD LOCATION)

Provide drawing w/ Grommet Location and Specify Color - \$95 ea.

- TM30-NS: Black Specify Location
- TM31-NS: Silver Specify Location
- TM33-NS: Antique Brass Specify Location

### LOCKING

- CL-01: Central locking - \$160



### MOLDING

- DSM1: Delete Scalloped Only - Deduct \$95

# Jamestown.

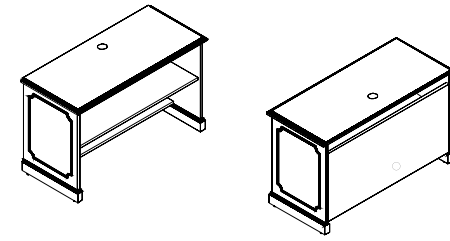
Table Desks  
Computer Table



1 Select a model w" x d" x h"	weight	Standard Veneer Top Standard Veneer Chassis		Premium Veneer Top Premium Veneer Chassis		High Pressure Laminate Top Veneer Chassis		Thermally Fused Laminate Top Thermally Fused Laminate Chassis	
		48 x 24 x 30	130	JCM4824AU225W	2277	"P" Option N/A	JCM4824AU225G	2277	"M" Option N/A
42 x 24 x 30	120	JCM4224AU225W	2198	"P" Option N/A	JCM4224AU225G	2198	"M" Option N/A	"M" Option N/A	
36 x 24 x 30	110	JCM3624AU225W	2143	"P" Option N/A	JCM3624AU225G	2143	"M" Option N/A	"M" Option N/A	
2 Select a finish <a href="#">View finish details</a>		WAC WRC WIC WHC WOC WEW WGW WBW WSW WNW				GAC GIC GHC GOC GEW GNW			
3 Select an edge <a href="#">View edge details</a>		 Traditional				 Traditional			
4 Select hardware <a href="#">View hardware details</a>		Hardware N/A				Hardware N/A			

[View statement of line](#)

## Product features.

- 1 Standard grommet - matches pull finish or specify black TM30, silver TM31 or antique brass TM33
- 6" D Foot rest/adjustable storage shelf
- Paper/wire access back
- Vertical surface grommet - TM50 Black

## Options.

### ACCESSORIES

- K28: Articulating keyboard w/ mouse pad - \$390
- CST20: Add 4 locking 2" diameter casters to computer table - \$140

### GROMMET (STANDARD LOCATION)

Specify Color and Location Right/Left - \$50 ea.

- Black: TM30-R (Right), TM30-L (Left), TM30-C (Center)
- Silver: TM31-R (Right), TM31-L (Left), TM31-C (Center)
- Antique Brass: TM33-R (Right), TM33-L (Left), TM33-C (Center)

### GROMMETS (NON-STANDARD LOCATION)

Provide drawing w/ Grommet Location and Specify Color - \$95 ea.

- TM30-NS: Black Specify Location
- TM31-NS: Silver Specify Location
- TM33-NS: Antique Brass Specify Location

### MOLDING

- DSM2: Delete Scalloped Only - Deduct \$50



# Jamestown.

Workstation Desk

Breakfront - Single Pedestal - Flush Top

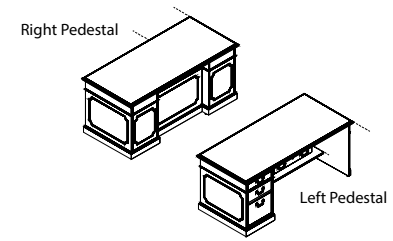

[View statement of line](#)

1 Select a model w" x d" x h"	weight	Standard Veneer Top		Premium Veneer Top		High Pressure Laminate Top		Thermally Fused Laminate Top	
		Standard Veneer Chassis		Premium Veneer Chassis		Veneer Chassis		Thermally Fused Laminate Chassis	
<b>Left Pedestal</b>									
72 x 36 x 30	275	JCM7236DS009W	4645	"P" Option N/A		JCM7236DS009G	4645	"M" Option N/A	
72 x 30 x 30	265	JCM7230DS009W	3779	"P" Option N/A		JCM7230DS009G	3779	"M" Option N/A	
66 x 36 x 30	265	JCM6636DS009W	4538	"P" Option N/A		JCM6636DS009G	4538	"M" Option N/A	
66 x 30 x 30	225	JCM6630DS009W	3744	"P" Option N/A		JCM6630DS009G	3744	"M" Option N/A	
<b>Right Pedestal</b>									
72 x 36 x 30	275	JCM7236DS010W	4645	"P" Option N/A		JCM7236DS010G	4645	"M" Option N/A	
72 x 30 x 30	265	JCM7230DS010W	3779	"P" Option N/A		JCM7230DS010G	3779	"M" Option N/A	
66 x 36 x 30	265	JCM6636DS010W	4538	"P" Option N/A		JCM6636DS010G	4538	"M" Option N/A	
66 x 30 x 30	225	JCM6630DS010W	3744	"P" Option N/A		JCM6630DS010G	3744	"M" Option N/A	
2 Select a finish <a href="#">View finish details</a>		WAC				GAC			
		WRC				GIC			
		WIC				GHC			
		WHC				GOC			
		WOC				GEW			
		WEW				GNW			
		WGW							
		WBW							
		WNW							
3 Select a edge <a href="#">View edge details</a>									
		Traditional				Traditional			
4 Select hardware <a href="#">View hardware details</a>									
		PL-4 Antique Brass				PL-4 Antique Brass		PL-5 Antique Brass	
								PL-50 Brushed Pewter	

## Product features.

- Box/Box/File
- Center drawer standard
- Full extension drawers - locking
- Kneespace storage shelf
- Laminate pull out writing shelf
- Soft close suspension drawer(s)

## Options.

### ACCESSORIES

- K28: Articulating keyboard w/ mouse pad - \$390

### DRAWERS

- K21: Traditional Pull out drawer w/ keyboard tray - \$470

### GROMMET (STANDARD LOCATION)

Specify Color and Location Right/Left - \$50 ea.

- Black: TM30-R (Right), TM30-L (Left)
- Silver: TM31-R (Right), TM31-L (Left)
- Antique Brass: TM33-R (Right), TM33-L (Left)

### GROMMETS (NON-STANDARD LOCATION)

Provide drawing w/ Grommet Location and Specify Color - \$95 ea.

- TM30-NS: Black Specify Location
- TM31-NS: Silver Specify Location
- TM33-NS: Antique Brass Specify Location

### LOCKING

- CL-01: Central locking - \$160

### MOLDING

- DSM1: Delete Scalloped Only - Deduct - \$95

### WORKSTATION

- CP-3: Client pull out on approach - \$445

# Jamestown.

Workstation Desk

Breakfront - Single Pedestal W/ Molding Overhang Top

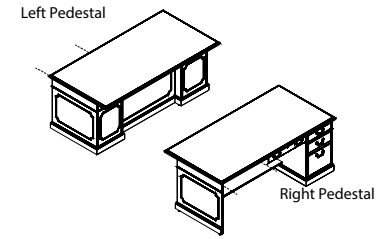

[View statement of line](#)

1 Select a model w" x d" x h"	weight	Standard Veneer Top		Premium Veneer Top		High Pressure Laminate Top		Thermally Fused Laminate Top	
		Standard Veneer Chassis		Premium Veneer Chassis		Veneer Chassis		Thermally Fused Laminate Chassis	
<b>Left Pedestal</b>									
72 x 36 x 30	275	JCM7236DS634W	4434	"P" Option N/A		JCM7236DS634G	4434	"M" Option N/A	
72 x 30 x 30	255	JCM7230DS634W	3850	"P" Option N/A		JCM7230DS634G	3850	"M" Option N/A	
66 x 36 x 30	260	JCM6636DS634W	4242	"P" Option N/A		JCM6636DS634G	4242	"M" Option N/A	
66 x 30 x 30	225	JCM6630DS634W	3567	"P" Option N/A		JCM6630DS634G	3567	"M" Option N/A	
<b>Right Pedestal</b>									
72 x 36 x 30	275	JCM7236DS633W	4434	"P" Option N/A		JCM7236DS633G	4434	"M" Option N/A	
72 x 30 x 30	255	JCM7230DS633W	3850	"P" Option N/A		JCM7230DS633G	3850	"M" Option N/A	
66 x 36 x 30	260	JCM6636DS633W	4242	"P" Option N/A		JCM6636DS633G	4242	"M" Option N/A	
66 x 30 x 30	225	JCM6630DS633W	3567	"P" Option N/A		JCM6630DS633G	3567	"M" Option N/A	
2 Select a finish <a href="#">View finish details</a>		WAC WRC WIC WHC WOC WEW WGW WBW WNW				GAC GIC GHC GOC GEW GNW			
3 Select an edge <a href="#">View edge details</a>		Traditional				Traditional			
4 Select hardware <a href="#">View hardware details</a>		PL-4 Antique Brass                  PL-5 Antique Brass PL-50 Brushed Pewter				PL-4 Antique Brass                  PL-5 Antique Brass PL-50 Brushed Pewter			

## Product features.

- Box/Box/File
- Center drawer standard
- Full extension drawers - locking
- Kneespace storage shelf
- Laminate pull out writing shelf
- Soft close suspension drawer(s)

### NOTES

- 6" overhang on approach
- For 72 x 36 x 30 Chassis Size is 70 x 30
- For 66 x 36 x 30 Chassis Size is 64 x 30
- For 72 x 30 x 30 Chassis Size is 70 x 24
- For 66 x 30 x 30 Chassis Size is 64 x 24

## Options.

### ACCESSORIES

- K28: Articulating keyboard w/ mouse pad - \$390

### DRAWERS

- K21: Traditional Pull out drawer w/ keyboard tray - \$470

### GROMMET (STANDARD LOCATION)

- Specify Color and Location Right/Left - \$50 ea.
- Black: TM30-R (Right), TM30-L (Left)
  - Silver: TM31-R (Right), TM31-L (Left)
  - Antique Brass: TM33-R (Right), TM33-L (Left)

### GROMMETS (NON-STANDARD LOCATION)

- Provide drawing w/ Grommet Location and Specify Color - \$95 ea.
- TM30-NS: Black Specify Location
  - TM31-NS: Silver Specify Location
  - TM33-NS: Antique Brass Specify Location

### LOCKING

- CL-01: Central locking - \$160

### MOLDING

- DSM1: Delete Scalloped Only - Deduct - \$95

# Jamestown.

Service Workstation Desk  
Breakfront - Single Pedestal - Service Desk

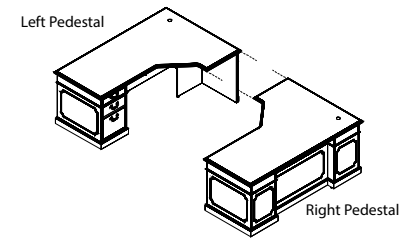

[View statement of line](#)

1 Select a model w" x d" x h"	weight	Standard Veneer Top Standard Veneer Chassis		Premium Veneer Top Premium Veneer Chassis		High Pressure Laminate Top Veneer Chassis		Thermally Fused Laminate Top Thermally Fused Laminate Chassis	
		<b>Left Pedestal</b> 72 x 30/48 x 30	325	JCM7248DS754W	4895	"P" Option N/A		JCM7248DS754G	4895
<b>Right Pedestal</b> 72 x 30/48 x 30	325	JCM7248DS753W	4895	"P" Option N/A		JCM7248DS753G	4895	"M" Option N/A	
2 Select a finish <a href="#">View finish details</a>		WAC WRC WIC WHC WOC WEW WGW WBW WNW				GAC GIC GHC GOC GEW GNW			
3 Select a edge <a href="#">View edge details</a>		Traditional				Traditional			
4 Select hardware <a href="#">View hardware details</a>		PL-4 Antique Brass PL-5 Antique Brass PL-50 Brushed Pewter				PL-4 Antique Brass PL-5 Antique Brass PL-50 Brushed Pewter			

## Product features.

- 1 Standard grommet - matches pull finish or specify black TM30, silver TM31 or antique brass TM33
- Box/Box/File
- Full extension drawers - locking
- Kneespace storage Shelves
- Laminate pull out writing shelf

## Options.

### ACCESSORIES

- K28: Articulating keyboard w/ mouse pad - \$390

### DRAWER

- K17: Traditional center drawer - \$235
- K21: Traditional Pull out drawer w/ keyboard tray - \$470

### GROMMETS (NON-STANDARD LOCATION)

- Provide drawing w/ Grommet Location and Specify Color - \$95 ea.
- TM30-NS: Black Specify Location
  - TM31-NS: Silver Specify Location
  - TM33-NS: Antique Brass Specify Location

### MOLDING

- DSM1: Delete Scalloped Only - Deduct \$95

### SERVICE DESK

- T90: Hardwood Edge Curve User Side - \$620
- T91: Hardwood Edge Approach Side Bowfront Edge - \$310

# Jamestown.

"L" Workstation Returns

Box/Box/File - Full Modesty/Base W/ Molding

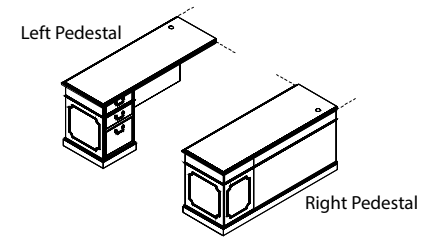

## 1 Select a model

w" x d" x h"

weight	Standard Veneer Top		Premium Veneer Top		High Pressure Laminate Top		Thermally Fused Laminate Top	
	Standard Veneer Chassis		Premium Veneer Chassis		Veneer Chassis		Thermally Fused Laminate Chassis	
<b>Left Pedestal</b>								
60 x 24 x 30	165	JCM6024RE207W	2826	"P" Option N/A	JCM6024RE207G	2826	"M" Option N/A	
48 x 24 x 30	150	JCM4824RE207W	2677	"P" Option N/A	JCM4824RE207G	2677	"M" Option N/A	
42 x 24 x 30	140	JCM4224RE207W	2578	"P" Option N/A	JCM4224RE207G	2578	"M" Option N/A	
<b>Right Pedestal</b>								
60 x 24 x 30	165	JCM6024RE209W	2826	"P" Option N/A	JCM6024RE209G	2826	"M" Option N/A	
48 x 24 x 30	150	JCM4824RE209W	2677	"P" Option N/A	JCM4824RE209G	2677	"M" Option N/A	
42 x 24 x 30	140	JCM4224RE209W	2578	"P" Option N/A	JCM4224RE209G	2578	"M" Option N/A	

[View statement of line](#)

## 2 Select a finish

[View finish details](#)

WAC  
WRC  
WIC  
WHC  
WOC  
WEW  
WGW  
WBW  
WNW

GAC  
GIC  
GHC  
GOC  
GEW  
GNW

## 3 Select a edge

[View edge details](#)



## 4 Select hardware

[View hardware details](#)



## Product features.

- 1 Standard grommet - matches pull finish or specify black TM30, silver TM31 or antique brass TM33
- Coped ends for flush surface transition
- Fixed full modesty
- Full extension drawers - locking
- Soft close suspension drawer(s)

### NOTES

- Left pedestal gets right grommet
- Right pedestal gets left grommet

## Options.

### ACCESSORIES

- K28: Articulating keyboard w/ mouse pad - \$390

### DRAWER

- K17: Traditional center drawer - \$235
- P40B: extra Box/Box/File or File/File to Kneespace - \$1025

### FLUSH CUT

- FC-R: Flush Unit Right (Facing) for Ganging - \$100
- FC-L: Flush Unit Left (Facing) for Ganging - \$100

### GROMMETS (NON-STANDARD LOCATION)

- Provide drawing w/ Grommet Location and Specify Color - \$95 ea.
- TM30-NS: Black Specify Location
  - TM31-NS: Silver Specify Location
  - TM33-NS: Antique Brass Specify Location

### MODESTY

- M34T: "W" "G" Style Drop Door Tech Modesty - \$130
- M51: Open Back Modesty with Wire Mgmt Rail - Deduct \$95

### MOLDING

- DSM2: Beltline only/ Delete scalloped molding - Deduct \$50

# Jamestown.

"L" Workstation Returns  
File/File - Full Modesty/Base W/Molding

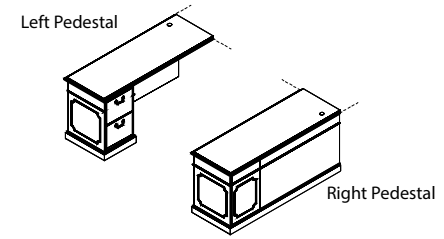

[View statement of line](#)

1 Select a model w" x d" x h"	weight	Standard Veneer Top Standard Veneer Chassis		Premium Veneer Top Premium Veneer Chassis		High Pressure Laminate Top Veneer Chassis		Thermally Fused Laminate Top Thermally Fused Laminate Chassis	
		<b>Left Pedestal</b>							
60 x 24 x 30	180	JCM6024RE195W	2826	"P" Option N/A		JCM6024RE195G	2826	"M" Option N/A	
48 x 24 x 30	160	JCM4824RE195W	2677	"P" Option N/A		JCM4824RE195G	2677	"M" Option N/A	
42 x 24 x 30	150	JCM4224RE195W	2578	"P" Option N/A		JCM4224RE195G	2578	"M" Option N/A	
<b>Right Pedestal</b>									
60 x 24 x 30	180	JCM6024RE196W	2826	"P" Option N/A		JCM6024RE196G	2826	"M" Option N/A	
48 x 24 x 30	160	JCM4824RE196W	2677	"P" Option N/A		JCM4824RE196G	2677	"M" Option N/A	
42 x 24 x 30	150	JCM4224RE196W	2578	"P" Option N/A		JCM4224RE196G	2578	"M" Option N/A	

2 Select a finish <a href="#">View finish details</a>	3 Select an edge <a href="#">View edge details</a>	4 Select hardware <a href="#">View hardware details</a>
WAC WRC WIC WHC WOC WEW WGW WBW WNW	Traditional	PL-4 Antique Brass
GAC GIC GHC GOC GEW GNW	Traditional	PL-5 Antique Brass PL-50 Brushed Pewter

## Product features.

- 1 Standard grommet - matches pull finish or specify black TM30, silver TM31 or antique brass TM33
- Coped ends for flush surface transition
- Fixed full modesty
- Full extension drawers - locking
- Soft close suspension drawer(s)

### NOTES

- Left pedestal gets right grommet
- Right pedestal gets left grommet

## Options.

### ACCESSORIES

- K28: Articulating keyboard w/ mouse pad - \$390

### DRAWER

- K17: Traditional center drawer - \$235
- P40B: extra Box/Box/File or File/File to Kneespace - \$1025

### FLUSH CUT

- FC-R: Flush Unit Right (Facing) for Ganging - \$100
- FC-L: Flush Unit Left (Facing) for Ganging - \$100

### GROMMETS (NON-STANDARD LOCATION)

- Provide drawing w/ Grommet Location and Specify Color - \$95 ea.
- TM30-NS: Black Specify Location
  - TM31-NS: Silver Specify Location
  - TM33-NS: Antique Brass Specify Location

### MODESTY

- M34T: "W" "G" Style Drop Door Tech Modesty - \$130
- M51: Open Back Modesty with Wire Mgmt Rail - Deduct \$95

### MOLDING



- DSM2: Beltline only/ Delete scalloped molding - Deduct \$50

# Jamestown.

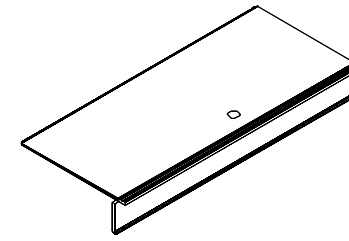
"U" Workstation Bridges  
Open Back Bridge



[View statement of line](#)

1 Select a model		Standard Veneer Top Standard Veneer Chassis		Premium Veneer Top Premium Veneer Chassis		High Pressure Laminate Top Veneer Chassis		Thermally Fused Laminate Top Thermally Fused Laminate Chassis	
w" x d" x h"	weight								
48 x 24 x 30	70	JCM4824BR151W	1406	"P" Option N/A		JCM4824BR151G	1406	"M" Option N/A	
42 x 24 x 30	65	JCM4224BR151W	1317	"P" Option N/A		JCM4224BR151G	1317	"M" Option N/A	
36 x 24 x 30	45	JCM3624BR151W	1225	"P" Option N/A		JCM3624BR151G	1225	"M" Option N/A	
2 Select a finish		WAC		GAC		GIC			
<a href="#">View finish details</a>		WRC		GHC		GOC			
		WIC		GOC		GEW			
		WHC		GNW					
		WOC							
		WEW							
		WGW							
		WBW							
		WNW							
3 Select a edge									
<a href="#">View edge details</a>		Traditional		Traditional					
4 Select hardware		Hardware		Hardware		Hardware			
<a href="#">View hardware details</a>		N/A		N/A		N/A			

## Product features.

- 4"H back rail - open back
- Center grommet standard
- Coped ends for flush surface transition
- Metal grommet matches pull finish, unless specified otherwise

## Options.

### ACCESSORIES

- K28: Articulating keyboard w/ mouse pad - \$390

### DRAWER

- K17: Traditional center drawer - \$235

### GROMMETS (NON-STANDARD LOCATION)

Provide drawing w/ Grommet Location and Specify Color - \$95 ea.

- TM30-NS: Black Specify Location
- TM31-NS: Silver Specify Location
- TM33-NS: Antique Brass Specify Location





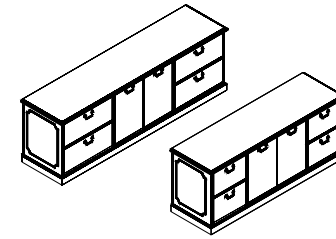

### MODESTY

- M37: "W" "G" Style Fixed Full Modesty w/ Molding - \$130
- M34T-O: "W" "G" Style Drop Door Tech Modesty - \$310

# Jamestown.

Credenzas  
File/File/Storage



1 Select a model w" x d" x h"	weight	Standard Veneer Top	Premium Veneer Top	High Pressure Laminate Top	Thermally Fused Laminate Top
		Standard Veneer Chassis	Premium Veneer Chassis	Veneer Chassis	Thermally Fused Laminate Chassis
<b>File/ File</b> 72 x 24 x 30	280	JCM7224CA050W 3938	"P" Option N/A	JCM7224CA050G 3938	"M" Option N/A
66 x 24 x 30	250	JCM6624CA050W 3751	"P" Option N/A	JCM6624CA050G 3751	"M" Option N/A
<b>Lateral File</b> 89 x 24 x 30	425	JCM8924CA651W 7020	"P" Option N/A	JCM8924CA651G 7020	"M" Option N/A
<b>2 Select a finish</b> <i>View finish details</i>	WAC WRC WIC WHC WOC WEW WGW WBW WSW WNW			GAC GIC GHC GOC GEW GNW	
<b>3 Select a edge</b> <i>View edge details</i>	 Traditional			 Traditional	
<b>4 Select hardware</b> <i>View hardware details</i>	 PL-4 Antique Brass	 PL-5 Antique Brass PL-50 Brushed Pewter		 PL-4 Antique Brass	 PL-5 Antique Brass PL-50 Brushed Pewter

[View statement of line](#)

## Product features.

- 1 Adjustable veneer shelf behind door set
- File/File n/a w/ beltline molding
- Fronts profile shaped all edges
- Full pedestals feature File/File
- Full extension drawers - locking
- Soft close suspension drawer(s)

### NOTES

- Unit not designed for open plan use, standard with unfinished back.
- Select OPB Option for Open Plan application.

## Options.

### DOOR

- D2: Door Lock - \$100 per door set
- D6: Delete Doors - n/c
- D9SC: Soft Close Door Hinges - \$20 per door

### DRAWER

- P6: Modify File/File to Box/Box/File - \$55 per pedestal
- PL-DBL: Add second pull to lateral file drawer - \$20 per Pull

### FLUSH CUT

- FC-B: Flush Unit Both Sides(Facing) for Ganging - \$100
- FC-R: Flush Unit Right (Facing) for Ganging - \$100
- FC-L: Flush Unit Left (Facing) for Ganging - \$100

### GROMMET (STANDARD LOCATION)

- Specify Color and Location (Right/Left/Center) - \$50 ea.
- Black: TM30-R (Right), TM30-L (Left), TM30-C (Center)
- Silver: TM31-R (Right), TM31-L (Left), TM31-C (Center)
- Antique Brass: TM33-R (Right), TM33-L (Left), TM33-C (Center)

### MOLDING

- DSM1: Delete Scalloped Only - Deduct \$95
- SPM10: Add scallop panel molding to doors - \$70 per door
- Open Plan – Finished Back
- OPB: "W" "G" Style - Modify Unit for Open Plan Application - \$295







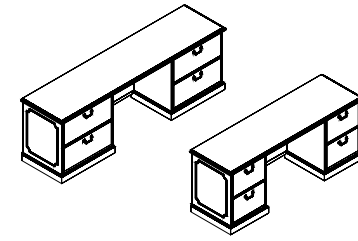



# Jamestown.

Credenzas

Kneespace - File/File



[View statement of line](#)

1 Select a model w" x d" x h"	weight	Standard Veneer Top		Premium Veneer Top		High Pressure Laminate Top		Thermally Fused Laminate Top	
		Standard Veneer Chassis		Premium Veneer Chassis		Veneer Chassis		Thermally Fused Laminate Chassis	
<b>Lateral File</b> 89 x 24 x 30	315	JCM8924CA052W	5626	"P" Option N/A		JCM8924CA052G	5626	"M" Option N/A	
<b>File/ File</b> 72 x 24 x 30	250	JCM7224CA054W	3782	"P" Option N/A		JCM7224CA054G	3782	"M" Option N/A	
66 x 24 x 30	220	JCM6624CA054W	3628	"P" Option N/A		JCM6624CA054G	3628	"M" Option N/A	
2 Select a finish <a href="#">View finish details</a>		WAC				GAC			
		WRC				GIC			
		WIC				GHC			
		WHC				GOC			
		WOC				GEW			
		WEW				GNW			
		WGW							
		WBW							
		WNW							
3 Select a edge <a href="#">View edge details</a>				Traditional				Traditional	
4 Select hardware <a href="#">View hardware details</a>				PL-4 Antique Brass				PL-5 Antique Brass	
				PL-50 Brushed Pewter				PL-4 Antique Brass	
				PL-50 Brushed Pewter				PL-5 Antique Brass	
				PL-50 Brushed Pewter				PL-50 Brushed Pewter	

## Product features.

- File/File
- Fronts profile shaped all edges
- Full extension drawers - locking
- Kneespace with full back panel
- Soft close suspension drawer(s)

### NOTES

- Unit not designed for open plan use, standard with unfinished back. Select OPB Option for Open Plan application.

## Options.

### ACCESSORIES

- K28: Articulating keyboard w/ mouse pad - \$390

### DRAWER

- K17: Traditional center drawer - \$235
- K21: Traditional Pull out drawer w/ keyboard tray - \$470
- PL-DBL: Add second pull to lateral file drawer - \$20 per Pull

### FLUSH CUT

- FC-B: Flush Unit Both Sides(Facing) for Ganging - \$100
- FC-R: Flush Unit Right (Facing) for Ganging - \$100
- FC-L: Flush Unit Left (Facing) for Ganging - \$100

### GROMMET (STANDARD LOCATION)

- Specify Color - \$50 ea.
- Black: TM30-C (Center)
  - Silver: TM31-C (Center)
  - Antique Brass: TM33-C (Center)

### GROMMETS (NON-STANDARD LOCATION)

- Provide drawing w/ Grommet Location and Specify Color - \$95 ea.
- TM30-NS: Black Specify Location
  - TM31-NS: Silver Specify Location
  - TM33-NS: Antique Brass Specify Location

### LOCKING

- CL-01: Central locking - \$160
- Only available when K17 specified

### MODESTY

- M34T: "W" "G" Style Drop Door Tech Modesty - \$130
- M51: Open Back Modesty with Wire Mgmt Rail - Deduct \$95

### MOLDING

- DSM1: Delete Scalloped Only - Deduct \$95

### OPEN PLAN – FINISHED BACK

- OPB: "W" "G" Style - Modify Unit for Open Plan Application - \$295



# Jamestown.

Storage Credenza  
Storage Credenza

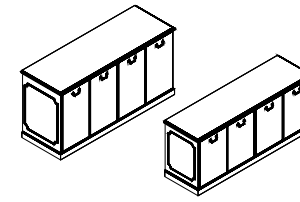

## 1 Select a model w" x d" x h"

weight	Standard Veneer Top		Premium Veneer Top		High Pressure Laminate Top		Thermally Fused Laminate Top	
	Standard Veneer Chassis		Premium Veneer Chassis		Veneer Chassis		Thermally Fused Laminate Chassis	
<b>36" Height</b>								
89 x 24 x 36	340	JCM8924CA124W	6506	"P" Option N/A	JCM8924CA124G	6506	"M" Option N/A	
72 x 24 x 36	260	JCM7224CA124W	5359	"P" Option N/A	JCM7224CA124G	5359	"M" Option N/A	
66 x 24 x 36	260	JCM6624CA124W	5245	"P" Option N/A	JCM6624CA124G	5245	"M" Option N/A	
60 x 24 x 36	245	JCM6024CA124W	5189	"P" Option N/A	JCM6024CA124G	5189	"M" Option N/A	
37 x 24 x 36	130	JCM3724CA124W	2735	"P" Option N/A	JCM3724CA124G	2735	"M" Option N/A	
<b>30" Height</b>								
89 x 24 x 30	320	JCM8924CA125W	5900	"P" Option N/A	JCM8924CA125G	5900	"M" Option N/A	
72 x 24 x 30	250	JCM7224CA125W	4754	"P" Option N/A	JCM7224CA125G	4754	"M" Option N/A	
66 x 24 x 30	240	JCM6624CA125W	4638	"P" Option N/A	JCM6624CA125G	4638	"M" Option N/A	
60 x 24 x 30	225	JCM6024CA125W	4581	"P" Option N/A	JCM6024CA125G	4581	"M" Option N/A	
37 x 24 x 30	120	JCM3724CA125W	2370	"P" Option N/A	JCM3724CA125G	2370	"M" Option N/A	

[View statement of line](#)

## 2 Select a finish [View finish details](#)

- WAC
- WRC
- WIC
- WHC
- WOC
- WEW
- WGW
- WBW
- WSW
- WNW

- GAC
- GIC
- GHC
- GOC
- GEW
- GNW

## 3 Select an edge [View edge details](#)



## 4 Select hardware [View hardware details](#)



## Product features.

- 1 Adjustable veneer shelf behind door set

### NOTES

- Unit not designed for open plan use, standard with unfinished back.
- Select OPB Option for Open Plan application.

## Options.

### ACCESSORIES

- REF-01: Modify storage section for refrigerator (Open back/water mat) - \$205

### DOOR

- D2: Door Lock - \$100 per door set
- D6: Delete Doors - n/c
- D9SC: Soft Close Door Hinges - \$20 per door

### FLUSH CUTS

- FC-B: Flush Unit Both Sides(Facing) for Ganging - \$100
- FC-R: Flush Unit Right (Facing) for Ganging - \$100
- FC-L: Flush Unit Left(Facing) for Ganging - \$100

### GROMMET (STANDARD LOCATION)

- Specify Color and Location (Right/Left/Center) - \$50 ea.
- Black: TM30-R (Right), TM30-L (Left), TM30-C (Center)
- Silver: TM31-R (Right), TM31-L (Left), TM31-C (Center)
- Antique Brass: TM33-R (Right), TM33-L (Left), TM33-C (Center)

### GROMMETS (NON-STANDARD LOCATION)

Provide drawing w/ Grommet Location and Specify Color - \$95 ea.

- TM30-NS: Black Specify Location
- TM31-NS: Silver Specify Location
- TM33-NS: Antique Brass Specify Location

### Molding

- DSM1: Delete Scalloped Only - Deduct \$95

Open Plan – Finished Back

- OPB: "W" "G" Style - Modify Unit for Open Plan Application - \$295

# Jamestown.

Lateral File Credenzas  
6/4/2 Drawer

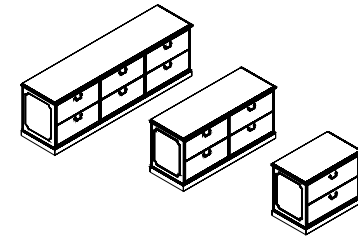

[View statement of line](#)

1 Select a model w" x d" x h"	weight	Standard Veneer Top Standard Veneer Chassis		Premium Veneer Top Premium Veneer Chassis		High Pressure Laminate Top Veneer Chassis		Thermally Fused Laminate Top Thermally Fused Laminate Chassis	
		<b>6 Drawer</b> 89 x 24 x 30	440	JCM8924CA104W	7168	"P" Option N/A		JCM8924CA104G	7168
<b>4 Drawer</b> 72 x 24 x 30	290	JCM7224CA104W	4709	"P" Option N/A		JCM7224CA104G	4709	"M" Option N/A	
60 x 24 x 30	250	JCM6024CA104W	4557	"P" Option N/A		JCM6024CA104G	4557	"M" Option N/A	
<b>2 Drawer</b> 37 x 24 x 30	165	JCM3724CA104W	2402	"P" Option N/A		JCM3724CA104G	2402	"M" Option N/A	
31 x 24 x 30	150	JCM3124CA104W	2298	"P" Option N/A		JCM3124CA104G	2298	"M" Option N/A	
2 Select a finish <a href="#">View finish details</a>		WAC WRC WIC WHC WOC WEW WGW WBW WNW				GAC GIC GHC GOC GEW GNW			
3 Select a edge <a href="#">View edge details</a>		Traditional				Traditional			
4 Select hardware <a href="#">View hardware details</a>		PL-4 Antique Brass PL-5 Antique Brass PL-50 Brushed Pewter				PL-4 Antique Brass PL-5 Antique Brass PL-50 Brushed Pewter			

## Product features.

- Full extension drawers - locking
- Legal/Letter Filing
- Soft close suspension drawer(s)
- Top profile shaped 3 sides

### NOTES

- Unit not designed for open plan use, standard with unfinished back. Select OPB Option for Open Plan application.

## Options.

### DRAWER

- PL-DBL: Add second pull to lateral file drawer - \$20 per Pull

### FLUSH CUT

- FC-B: Flush Unit Both Sides(Facing) for Ganging - \$100
- FC-R: Flush Unit Right (Facing) for Ganging - \$100
- FC-L: Flush Unit Left(Facing) for Ganging - \$100

### MOLDING

- DSM1: Delete Scalloped Only - Deduct - \$95





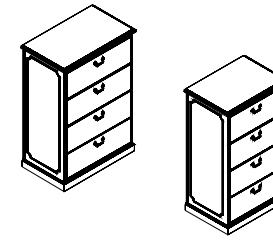

### OPEN PLAN – FINISHED BACK

- OPB: "W" "G" Style - Modify Unit for Open Plan Application - \$295

# Jamestown.

Lateral File Credenzas  
Lateral File



1 Select a model w" x d" x h"	weight	Standard Veneer Top Standard Veneer Chassis		Premium Veneer Top Premium Veneer Chassis		High Pressure Laminate Top Veneer Chassis		Thermally Fused Laminate Top Thermally Fused Laminate Chassis		
		<b>Four Drawer</b> 37 x 24 x 54 31 x 24 x 54	250 230	JCM3724FI111W 4018 JCM3124FI111W 3860	"P" Option N/A "P" Option N/A	JCM3724FI111G 4018 JCM3124FI111G 3860	"M" Option N/A "M" Option N/A			
2 Select a finish <i>View finish details</i>		WAC WRC WIC WHC WOC WEW WGW WBW WNW				GAC GIC GHC GOC GEW GNW				
3 Select an edge <i>View edge details</i>		 Traditional				 Traditional				
4 Select hardware <i>View hardware details</i>		 PL-4 Antique Brass  PL-5 Antique Brass PL-50 Brushed Pewter				 PL-4 Antique Brass  PL-5 Antique Brass PL-50 Brushed Pewter				

[View statement of line](#)

## Product features.

- Full extension drawers - locking
- Legal/Letter Filing
- Soft close suspension drawer(s)
- Top profile shaped 3 sides

### NOTES

- Unit not designed for open plan use, standard with unfinished back. Select OPB Option for Open Plan application.

## Options.

### DRAWER

- PL-DBL: Add second pull to lateral file drawer - \$20 per Pull

### FLUSH CUT

- FC-B: Flush Unit Both Sides(Facing) for Ganging - \$100
- FC-R: Flush Unit Right (Facing) for Ganging - \$100
- FC-L: Flush Unit Left(Facing) for Ganging - \$100

### MOLDING

- DSM1: Delete Scalloped Only - Deduct - \$95

### OPEN PLAN – FINISHED BACK

- OPB: "W" "G" Style - Modify Unit for Open Plan Application - \$295

# Jamestown.

Buffet Credenza  
Buffet Credenza

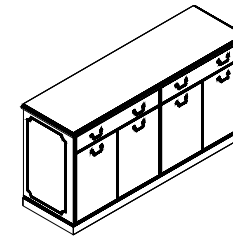

1 Select a model w" x d" x h"	weight	Standard Veneer Top Standard Veneer Chassis		Premium Veneer Top Premium Veneer Chassis		High Pressure Laminate Top Veneer Chassis		Thermally Fused Laminate Top Thermally Fused Laminate Chassis	
		72 x 24 x 36 37 x 24 x 36	300 150	JCM7224CA126W JCM3724CA126W	6127 3197	"P" Option N/A "P" Option N/A		JCM7224CA126G JCM3724CA126G	6127 3197
2 Select a finish <a href="#">View finish details</a>		WAC WRC WIC WHC WOC WEW WGW WBW WSW WNW				GAC GIC GHC GOC GEW GNW			
3 Select a edge <a href="#">View edge details</a>		Traditional				Traditional			
4 Select hardware <a href="#">View hardware details</a>		PL-4 Antique Brass PL-5 Antique Brass PL-50 Brushed Pewter				PL-4 Antique Brass PL-5 Antique Brass PL-50 Brushed Pewter			

[View statement of line](#)

## Product features.

- 1 Adjustable veneer shelf behind door set
- Full extension drawers - locking
- Soft close suspension drawer(s)
- Utility drawer w/ felt liner

### NOTES

- Unit not designed for open plan use, standard with unfinished back.  
Select OPB Option for Open Plan application.

## Options.

### DOOR

- D2: Door Lock - \$100 per door set
- D6: Delete Doors - n/c
- D9SC: Soft Close Door Hinges - \$20 per door

### FLUSH CUT

- FC-B: Flush Unit Both Sides(Facing) for Ganging - \$100
- FC-R: Flush Unit Right (Facing) for Ganging - \$100
- FC-L: Flush Unit Left(Facing) for Ganging - \$100

### MOLDING

- DSM1: Delete Scalloped Only - Deduct - \$95

### OPEN PLAN – FINISHED BACK

- OPB: "W" "G" Style - Modify Unit for Open Plan Application - \$295

# Jamestown.

Workstation Credenzas  
File/File W/ Molding

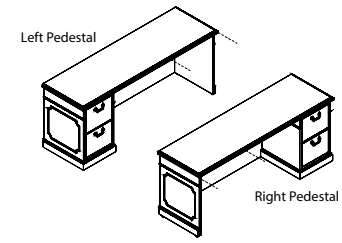

## 1 Select a model w" x d" x h"

	weight	Standard Veneer Top Standard Veneer Chassis	Premium Veneer Top Premium Veneer Chassis	High Pressure Laminate Top Veneer Chassis	Thermally Fused Laminate Top Thermally Fused Laminate Chassis
<b>Left Pedestal</b>					
72 x 24 x 30	175	JCM7224CA086W 3477	"P" Option N/A	JCM7224CA086G 3477	"M" Option N/A
66 x 24 x 30	160	JCM6624CA086W 3321	"P" Option N/A	JCM6624CA086G 3321	"M" Option N/A
<b>Right Pedestal</b>					
72 x 24 x 30	175	JCM7224CA087W 3477	"P" Option N/A	JCM7224CA087G 3477	"M" Option N/A
66 x 24 x 30	160	JCM6624CA087W 3321	"P" Option N/A	JCM6624CA087G 3321	"M" Option N/A

[View statement of line](#)

## 2 Select a finish [View finish details](#)

WAC  
WRC  
WIC  
WHC  
WOC  
WEW  
WGW  
WBW  
WNW

GAC  
GIC  
GHC  
GOC  
GEW  
GNW

## 3 Select a edge [View edge details](#)



## 4 Select hardware [View hardware details](#)



## Product features.

- File drawer reinforced for extra storage capacity
- Full extension drawers - locking
- Full panel modesty
- Legal/Letter filing
- Soft close suspension drawer(s)

### NOTES

- Unit not designed for open plan use, standard with unfinished back. Select OPB Option for Open Plan application.

## Options.

### ACCESSORIES

- K28: Articulating keyboard w/ mouse pad - \$390

### DRAWER

- P6: Modify File/File to Box/Box/File - \$55 per pedestal
- P40B: extra Box/Box/File or File/File to Kneespace - \$1025

### FLUSH CUT

- FC-B: Flush Unit Both Sides(Facing) for Ganging - \$100
- FC-R: Flush Unit Right (Facing) for Ganging - \$100
- FC-L: Flush Unit Left (Facing) for Ganging - \$100

### GROMMET (STANDARD LOCATION)

- Specify Color - \$50 ea.
- Black: TM30-C (Center)
- Silver: TM31-C (Center)
- Antique Brass: TM33-C (Center)

### GROMMETS (NON-STANDARD LOCATION)

- Provide drawing w/ Grommet Location and Specify Color - \$95 ea.
- TM30-NS: Black Specify Location
- TM31-NS: Silver Specify Location
- TM33-NS: Antique Brass Specify Location

### MODESTY

- M34T: "W" "G" Style Drop Door Tech Modesty - \$130
- M51: Open Back Modesty with Wire Mgmt Rail - Deduct \$95

### MOLDING

- DSM2: Beltline only/ Delete scalloped molding - Deduct \$50

### OPEN PLAN - FINISHED BACK

- OPB: Modify Unit for Open Plan Application - \$295

# Jamestown.

Workstation Credenzas  
Lateral File W/ Molding

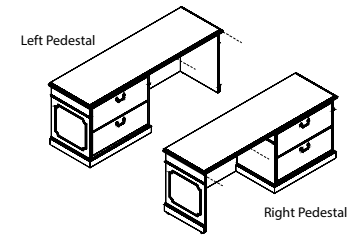

[View statement of line](#)

1 Select a model w" x d" x h"	weight	Standard Veneer Top Standard Veneer Chassis		Premium Veneer Top Premium Veneer Chassis		High Pressure Laminate Top Veneer Chassis		Thermally Fused Laminate Top Thermally Fused Laminate Chassis	
		<b>Left Pedestal</b> 89 x 24 x 30 72 x 24 x 30 66 x 24 x 30	240 200 185	JCM8924CA066W JCM7224CA066W JCM6624CA066W	4324 4018 3860	"P" Option N/A "P" Option N/A "P" Option N/A	JCM8924CA066G JCM7224CA066G JCM6624CA066G	4324 4018 3860	"M" Option N/A "M" Option N/A "M" Option N/A
<b>Right Pedestal</b> 89 x 24 x 30 72 x 24 x 30 66 x 24 x 30	240 200 185	JCM8924CA067W JCM7224CA067W JCM6624CA067W	4324 4018 3860	"P" Option N/A "P" Option N/A "P" Option N/A	JCM8924CA067G JCM7224CA067G JCM6624CA067G	4324 4018 3860	"M" Option N/A "M" Option N/A "M" Option N/A		
<b>2 Select a finish</b> <a href="#">View finish details</a>		WAC WRC WIC WHC WOC WEW WGW WBW WNW			GAC GIC GHC GOC GEW GNW				
<b>3 Select a edge</b> <a href="#">View edge details</a>		Traditional			Traditional				
<b>4 Select hardware</b> <a href="#">View hardware details</a>		PL-4 Antique Brass PL-5 Antique Brass PL-50 Brushed Pewter			PL-4 Antique Brass PL-5 Antique Brass PL-50 Brushed Pewter				

## Product features.

- Full extension drawers - locking
- Full back panel
- Lateral file drawer reinforced for extra storage capacity
- Legal/Letter filing
- Soft close suspension drawer(s)

### NOTES

- Center drawers/keyboards n/a on 72" / 66" - 2 drawer lateral file credenzas
- Unit not designed for open plan use, standard with unfinished back. Select OPB Option for Open Plan application.

## Options.

### ACCESSORIES

- K28: Articulating keyboard w/ mouse pad - \$390

### DRAWER

- P40B: extra Box/Box/File or File/File to Kneespace - \$1025
- PL-DBL: Add second pull to lateral file drawer - \$20 per Pull

### FLUSH CUT

- FC-B: Flush Unit Both Sides(Facing) for Ganging - \$100
- FC-R: Flush Unit Right (Facing) for Ganging - \$100
- FC-L: Flush Unit Left (Facing) for Ganging - \$100

### GROMMET (STANDARD LOCATION)

- Specify Color - \$50 ea.
- Black: TM30-C (Center)
  - Silver: TM31-C (Center)
  - Antique Brass: TM33-C (Center)

### GROMMETS (NON-STANDARD LOCATION)

- Provide drawing w/ Grommet Location and Specify Color - \$95 ea.
- TM30-NS: Black Specify Location
  - TM31-NS: Silver Specify Location
  - TM33-NS: Antique Brass Specify Location

### MODESTY

- M34T: "W" "G" Style Drop Door Tech Modesty - \$130
- M51: Open Back Modesty with Wire Mgmt Rail - Deduct \$95

### MOLDING

- DSM2: Beltline only/ Delete scalloped molding - Deduct \$50

### OPEN PLAN - FINISHED BACK

- OPB: Modify Unit for Open Plan Application - \$295

# Jamestown.

Single Height Overheads  
Panel Door With Cornice Top

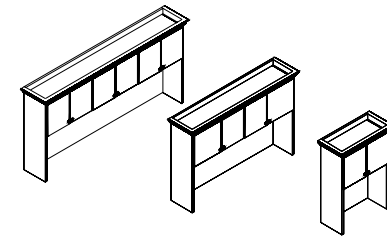

1 Select a model w" x d" x h"	weight	Standard Veneer Top Standard Veneer Chassis	Premium Veneer Top Premium Veneer Chassis	High Pressure Laminate Top Veneer Chassis	Thermally Fused Laminate Top Thermally Fused Laminate Chassis
<b>6 Door</b>					
93 x 15 x 44	375	JCM93440H325W 5823	"P" Option N/A	"G" Option N/A	"M" Option N/A
87 x 15 x 44	325	JCM87440H325W 5396	"P" Option N/A	"G" Option N/A	"M" Option N/A
<b>4 Door</b>					
70 x 15 x 44	250	JCM70440H325W 4806	"P" Option N/A	"G" Option N/A	"M" Option N/A
64 x 15 x 44	220	JCM64440H325W 4515	"P" Option N/A	"G" Option N/A	"M" Option N/A
58 x 15 x 44	190	JCM58440H325W 4366	"P" Option N/A	"G" Option N/A	"M" Option N/A
<b>2 Door</b>					
35 x 15 x 44	150	JCM35440H325W 3050	"P" Option N/A	"G" Option N/A	"M" Option N/A
29 x 15 x 44	140	JCM29440H325W 2759	"P" Option N/A	"G" Option N/A	"M" Option N/A

[View statement of line](#)

2 Select a finish <a href="#">View finish details</a>	
WAC	
WRC	
WIC	
WHC	
WOC	
WEW	
WGW	
WBW	
WNW	

3 Select a edge <a href="#">View edge details</a>	Edge
N/A	

4 Select hardware <a href="#">View hardware details</a>	
	DK-114 Brushed Pewter
	DK-4 Antique Brass
	DK-5 Antique Brass
	DK-50 Brushed Pewter

## Product features.

- 23 -3/4" Under cabinet clearance
- Back is painted black
- Cornice top
- Grommet hole in top of overhead back panel for Task light cord
- Interior cabinet depth 12.5"

### NOTES

- Unit has black back panel and is not designed for Open Plan use. Select OPB Option for Open Plan application

## Options.

### DOOR

- D2: Door Lock - \$100 per door set
- D6: Delete Doors - n/c
- D9SC: Soft Close Door Hinges - \$20 per door

### FLUSH CUT

- FC-B: Flush Unit Both Sides(Facing) for Ganging - \$100
- FC-R: Flush Unit Right (Facing) for Ganging - \$100
- FC-L: Flush Unit Left (Facing) for Ganging - \$100

### GROMMETS (VERTICAL SURFACE)

- Standard Location - \$50 ea.
- Black Plastic Vertical Surface: TM50-C (Bottom Center)
- Non-Standard Location - \$95 ea.
- Black Plastic Vertical Surface: TM50-NS

### TASK LIGHTING (RECESSED)

- Overhead tasklight cord is located on the right facing side. If the opposite location is required please contact customer service.
- LT-LED24R: 24" LED Task light - \$190
- LT-LED48R: 48" LED Task light - \$245
- LT-LED60R: 60" LED Task light - \$310
- LT-LED72R: 72" LED Task light - \$335

### OPEN PLAN – FINISHED BACK

- OPB: "W" "G" Style - Modify Unit for Open Plan Application - \$395

# Jamestown.

Single Height Overheads  
Frame Door With Beveled Glass Cornice Top

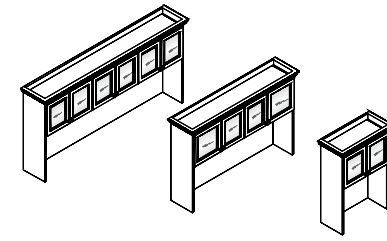

[View statement of line](#)

1 Select a model w" x d" x h"	weight	Standard Veneer Top Standard Veneer Chassis		Premium Veneer Top Premium Veneer Chassis		High Pressure Laminate Top Veneer Chassis		Thermally Fused Laminate Top Thermally Fused Laminate Chassis	
		<b>6 Door</b>							
93 x 15 x 44	375	JCM9344OH447W	6114	"P" Option N/A		"G" Option N/A		"M" Option N/A	
87 x 15 x 44	325	JCM8744OH447W	5685	"P" Option N/A		"G" Option N/A		"M" Option N/A	
<b>4 Door</b>									
70 x 15 x 44	250	JCM7044OH447W	4956	"P" Option N/A		"G" Option N/A		"M" Option N/A	
64 x 15 x 44	220	JCM6444OH447W	4663	"P" Option N/A		"G" Option N/A		"M" Option N/A	
58 x 15 x 44	190	JCM5844OH447W	4366	"P" Option N/A		"G" Option N/A		"M" Option N/A	
<b>2 Door</b>									
35 x 15 x 44	150	JCM3544OH447W	3200	"P" Option N/A		"G" Option N/A		"M" Option N/A	
29 x 15 x 44	140	JCM2944OH447W	2903	"P" Option N/A		"G" Option N/A		"M" Option N/A	





  

2 Select a finish <a href="#">View finish details</a>	
	WAC
	WRC
	WIC
	WHC
	WOC
	WEW
	WGW
	WBW
	WNW

3 Select a edge <a href="#">View edge details</a>	Edge
	N/A

4 Select hardware <a href="#">View hardware details</a>		
		
	DK-114 Brushed Pewter	DK-4 Antique Brass
		
	DK-5 Antique Brass	DK-50 Brushed Pewter

## Product features.

- 23 -3/4" Under cabinet clearance
- Back is painted black
- Beveled clear glass
- Cornice top
- Grommet hole in top of overhead back panel for task light cord
- Interior cabinet depth 12.5"
- Solid wood door frame

### NOTES

- Unit has black back panel and is not designed for Open Plan use. Select OPB Option for Open Plan application

## Options.

### DOOR

- D2: Door Lock - \$100 per door set
- D6: Delete Doors - n/c
- D9SC: Soft Close Door Hinges - \$20 per door
- D35: Optional Wood Panel Insert - \$35 per individual panel insert

### FLUSH CUT

- FC-B: Flush Unit Both Sides(Facing) for Ganging - \$100
- FC-R: Flush Unit Right (Facing) for Ganging - \$100
- FC-L: Flush Unit Left (Facing) for Ganging - \$100

### GROMMETS (VERTICAL SURFACE)

- Standard Location - \$50 ea.
- Black Plastic Vertical Surface: TM50-C (Bottom Center)
- Non-Standard Location - \$95 ea.
- Black Plastic Vertical Surface: TM50-NS

### INTERIOR CABINET LIGHTING

- LEDPK starter kit includes Infeed, 1 Puck Interior Light and the ability to daisy chain up to 6 total Puck Lights
- LEDPK: LED Puck Starter Kit - \$310
- PK: 1 LED Interior Light - \$130

### TASK LIGHTING (RECESSED)

- Overhead tasklight cord is located on the right facing side. If the opposite location is required please contact customer service.
- LT-LED24R: 24" LED Task light - \$190
- LT-LED48R: 48" LED Task light - \$245
- LT-LED60R: 60" LED Task light - \$310
- LT-LED72R: 72" LED Task light - \$335

### OPEN PLAN – FINISHED BACK

- OPB: "W" "G" Style - Modify Unit for Open Plan Application - \$395



# Jamestown.

Double Height Overheads  
Overhead Panel Doors/Cornice Top

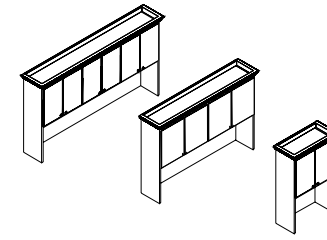

1 Select a model w" x d" x h"	weight	Standard Veneer Top		Premium Veneer Top		High Pressure Laminate Top		Thermally Fused Laminate Top	
		Standard Veneer Chassis		Premium Veneer Chassis		Veneer Chassis		Thermally Fused Laminate Chassis	
<b>6 Door (3 Section)</b>									
93 x 15 x 51	335	JCM9351OH325W	6697	"P" Option N/A		"G" Option N/A		"M" Option N/A	
87 x 15 x 51	325	JCM8751OH325W	6205	"P" Option N/A		"G" Option N/A		"M" Option N/A	
<b>4 Door (2 Section)</b>									
83 x 15 x 51	300	JCM8351OH325W	5985	"P" Option N/A		"G" Option N/A		"M" Option N/A	
76 x 15 x 51	275	JCM7651OH325W	5814	"P" Option N/A		"G" Option N/A		"M" Option N/A	
70 x 15 x 51	250	JCM7051OH325W	5527	"P" Option N/A		"G" Option N/A		"M" Option N/A	
64 x 15 x 51	250	JCM6451OH325W	5193	"P" Option N/A		"G" Option N/A		"M" Option N/A	
58 x 15 x 51	215	JCM5851OH325W	5020	"P" Option N/A		"G" Option N/A		"M" Option N/A	
47 x 15 x 51	185	JCM4751OH325W	3852	"P" Option N/A		"G" Option N/A		"M" Option N/A	
<b>2 Door (1 Section)</b>									
35 x 15 x 51	160	JCM3551OH325W	3508	"P" Option N/A		"G" Option N/A		"M" Option N/A	
29 x 15 x 51	140	JCM2951OH325W	3173	"P" Option N/A		"G" Option N/A		"M" Option N/A	

[View statement of line](#)

2 Select a finish <a href="#">View finish details</a>	WAC
	WRC
WIC	
WHC	
WOC	
WEW	
WGW	
WBW	
WNW	

3 Select a edge <a href="#">View edge details</a>	Edge
	N/A

4 Select hardware <a href="#">View hardware details</a>	DK-114 Brushed Pewter	DK-4 Antique Brass
	DK-5 Antique Brass DK-50 Brushed Pewter	

## Product features.

- 21 -1/2" Under cabinet clearance
- Back is painted black
- Cornice top
- Grommet hole in top of overhead back panel for Task light cord
- Finished wood shelves
- Interior shelf depth 12.5"

### NOTES

- Unit has black back panel and is not designed for Open Plan use. Select OPB Option for Open Plan application

## Options.

### DOOR

- D2: Door Lock - \$100 per door set
- D6: Delete Doors - n/c
- D9SC: Soft Close Door Hinges - \$20 per door

### FLUSH CUT

- FC-B: Flush Unit Both Sides(Facing) for Ganging - \$100
- FC-R: Flush Unit Right (Facing) for Ganging - \$100
- FC-L: Flush Unit Left (Facing) for Ganging - \$100

### GROMMETS (VERTICAL SURFACE)

- Standard Location - \$50 ea.
- Black Plastic Vertical Surface: TM50-C (Bottom Center)
- Non-Standard Location - \$95 ea.
- Black Plastic Vertical Surface: TM50-NS

### TASK LIGHTING (RECESSED)

- Overhead tasklight cord is located on the right facing side. If the opposite location is required please contact customer service.
- LT-LED24R: 24" LED Task light - \$190
- LT-LED48R: 48" LED Task light - \$245
- LT-LED60R: 60" LED Task light - \$310
- LT-LED72R: 72" LED Task light - \$335

### OPEN PLAN – FINISHED BACK

- OPB: "W" "G" Style - Modify Unit for Open Plan Application - \$395

### SHELVES

- S714F: Replace standard shelves with heavy duty 1" thick wood shelf - \$80 per shelf

# Jamestown.

Double Height Overheads  
Wood Frame Door With Beveled Glass/Cornice Top

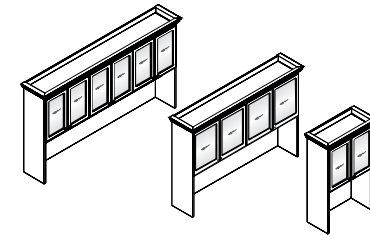





1 Select a model w" x d" x h"	weight	Standard Veneer Top Standard Veneer Chassis	Premium Veneer Top Premium Veneer Chassis	High Pressure Laminate Top Veneer Chassis	Thermally Fused Laminate Top Thermally Fused Laminate Chassis
<b>6 Door (3 Section)</b>					
93 x 15 x 51	335	JCM9351OH447W 7031	"P" Option N/A	"G" Option N/A	"M" Option N/A
87 x 15 x 51	325	JCM8751OH447W 6538	"P" Option N/A	"G" Option N/A	"M" Option N/A
<b>4 Door (2 Section)</b>					
70 x 15 x 51	250	JCM7051OH447W 5698	"P" Option N/A	"G" Option N/A	"M" Option N/A
64 x 15 x 51	250	JCM6451OH447W 5362	"P" Option N/A	"G" Option N/A	"M" Option N/A
58 x 15 x 51	215	JCM5851OH447W 5020	"P" Option N/A	"G" Option N/A	"M" Option N/A
<b>2 Door (1 Section)</b>					
35 x 15 x 51	160	JCM3551OH447W 3681	"P" Option N/A	"G" Option N/A	"M" Option N/A
29 x 15 x 51	140	JCM2951OH447W 3338	"P" Option N/A	"G" Option N/A	"M" Option N/A

*View statement of line*

2 Select a finish <i>View finish details</i>	
	WAC
	WRC
	WIC
	WHC
	WOC
	WEW
	WGW
	WBW
	WNW

3 Select a edge <i>View edge details</i>	Edge
	N/A

4 Select hardware <i>View hardware details</i>	
	 DK-114 Brushed Pewter  DK-4 Antique Brass
	 DK-5 Antique Brass  DK-50 Brushed Pewter

## Product features.

- 21 -1/2" Under cabinet clearance
- Back is painted black
- Beveled clear glass
- Cornice top
- Finished wood shelves
- Grommet hole in top of overhead back panel for Task light cord
- Interior shelf depth 12.5"
- Solid wood door frame

### NOTES

- Unit has black back panel and is not designed for Open Plan use. Select OPB Option for Open Plan application

## Options.

### DOOR

- D2: Door Lock - \$100 per door set
- D6: Delete Doors - n/c
- D95C: Soft Close Door Hinges - \$20 per door
- D35: Optional Wood Panel Insert - \$35 per individual panel insert

### FLUSH CUT

- FC-B: Flush Unit Both Sides(Facing) for Ganging - \$100
- FC-R: Flush Unit Right (Facing) for Ganging - \$100
- FC-L: Flush Unit Left (Facing) for Ganging - \$100

### GROMMETS (VERTICAL SURFACE)

- Standard Location - \$50 ea.
- Black Plastic Vertical Surface: TM50-C (Bottom Center)
- Non-Standard Location - \$95 ea.
- Black Plastic Vertical Surface: TM50-NS

### INTERIOR CABINET LIGHTING

- LEDPK starter kit includes Infeed, 1 Puck Interior Light and the ability to daisy chain up to 6 total Puck Lights
- LEDPK: LED Puck Starter Kit - \$310
- PK: 1 LED Interior Light - \$130

### TASK LIGHTING (RECESSED)

- Overhead tasklight cord is located on the right facing side. If the opposite location is required please contact customer service.
- LT-LED24R: 24" LED Task light - \$190
- LT-LED48R: 48" LED Task light - \$245
- LT-LED60R: 60" LED Task light - \$310
- LT-LED72R: 72" LED Task light - \$335

### OPEN PLAN – FINISHED BACK

- OPB: "W" "G" Style - Modify Unit for Open Plan Application - \$395

### SHELVES

- GS14F: Replace Standard Shelves with Glass Shelves - \$90 per shelf
- S714F: Replace standard shelves with heavy duty 1" thick wood shelf - \$80 per shelf

# Jamestown tackboards.

## Overhead tackboard Full width tackboards

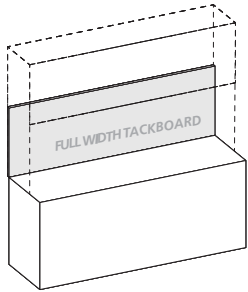

Product Width	Panel Dimension	SKU	COM	1	2	3	4	5	6	7	8	9	10	11/L1	12	13/L2
93"	91 x .75 x 21	FTOC9121	379	480	531	582	633	684	735	786	837	888	939	990	1041	1143
87"	85 x .75 x 21	FTOC8521	358	449	497	545	593	641	689	737	785	833	881	929	977	1073
83"	81 x .75 x 21	FTOC8121	336	428	474	520	566	612	658	704	750	796	842	888	934	1026
76"	74 x .75 x 21	FTOC7421	309	392	435	478	521	564	607	650	693	736	779	822	865	951
70"	68 x .75 x 21	FTOC6821	282	361	401	441	481	521	561	601	641	681	721	761	801	881
64"	62 x .75 x 21	FTOC6221	256	330	366	402	438	474	510	546	582	618	654	690	726	798
58"	56 x .75 x 21	FTOC5621	234	299	331	363	395	427	459	491	523	555	587	619	651	715
47"	45 x .75 x 21	FTOC4521	187	242	269	296	323	350	377	404	431	458	485	512	539	593
35"	33 x .75 x 21	FTOC3321	141	180	200	220	240	260	280	300	320	340	360	380	400	440
29"	27 x .75 x 21	FTOC2721	112	149	166	183	200	217	234	251	268	285	302	319	336	370

### Standard Features

- Constructed of .5" thick fiberboard
- Fabric is precisely aligned and fitted to the tackboard
- Adhered to the rigid hardboard with staples
- Hung with Z-Strip mounting system

### Notes

- Fabric Tack Panels are raised 3" from bottom edge when TM50 grommet is ordered

## Overhead tackboard Half width tackboards

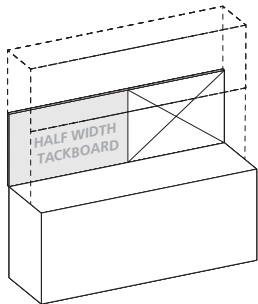

Product Width	Panel Dimension	SKU	COM	1	2	3	4	5	6	7	8	9	10	11/L1	12	13/L2
93 Half Width	45.5 x .75 x 21	FTOC4521	189	240	266	292	318	344	370	396	422	448	474	500	526	578
87 Half Width	42.5 x .75 x 21	FTOC4221	179	225	249	273	297	321	345	369	393	417	441	465	489	537
83 Half Width	40.5 x .75 x 21	FTOC4021	168	214	237	260	283	306	329	352	375	398	421	444	467	513
76 Half Width	37 x .75 x 21	FTOC3721	155	196	217	238	259	280	301	322	343	364	385	406	427	469
70 Half Width	34 x .75 x 21	FTOC3421	141	180	200	220	240	260	280	300	320	340	360	380	400	440
64 Half Width	31 x .75 x 21	FTOC3121	128	165	183	201	219	237	255	273	291	309	327	345	363	399

### Standard Features

- Constructed of .5" thick fiberboard
- Fabric is precisely aligned and fitted to the tackboard
- Adhered to the rigid hardboard with staples
- Hung with Z-Strip mounting system

### Notes

- Half width tackboards can be specified and combined with a Veneer Panel, Marker Board, Slat Wall or Glass Board. See "Half Width" items under product width.
- Specify right or left facing tackboard
- Fabric Tack Panels are raised 3" from bottom edge when TM50 grommet is ordered

## Jamestown tackboards.

Overhead dry marker board  
Full width dry marker board

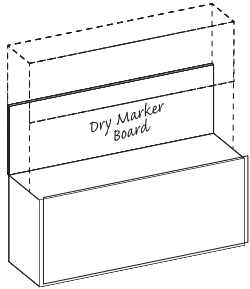

Product Width	Panel Dimension	SKU	List
93	91 x .5 x 21	DMOC9121	1136
87	85 x .5 x 21	DMOC8521	1061
83	81 x .5 x 21	DMOC8121	1011
76	74 x .5 x 21	DMOC7421	924
70	68 x .5 x 21	DMOC6821	849
64	62 x .5 x 21	DMOC6221	774
58	56 x .5 x 21	DMOC5621	699
47	45 x .5 x 21	DMOC4521	587
35	33 x .5 x 21	DMOC3321	437
29	27 x .5 x 21	DMOC2721	337

### Standard Features

- Dry marker panel has edge trim molding
- Standard magnetic surface

- Hung with Z-Strip mounting system

Overhead dry marker board  
Half width dry marker board

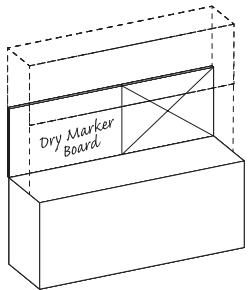

Product Width	Panel Dimension	SKU	List
93 Half Width	45.5 x .5 x 21	DMOC4521	555
87 Half Width	42.5 x .5 x 21	DMOC4221	518
83 Half Width	40.5 x .5 x 21	DMOC4021	493
76 Half Width	37 x .5 x 21	DMOC3721	449
70 Half Width	34 x .5 x 21	DMOC3421	437
64 Half Width	31 x .5 x 21	DMOC3121	374

### Standard Features

- Dry marker panel has edge trim molding
- Standard magnetic surface
- Hung with Z-Strip mounting system

### Notes

- Half width dry marker boards can be specified and combined with a Tackboard, Veneer Panel, Slat Wall or Glass Board. See "Half Width" items under product width.
- Specify right or left facing dry marker board

## Jamestown tackboards.

Overhead glassboard  
Full width glassboard

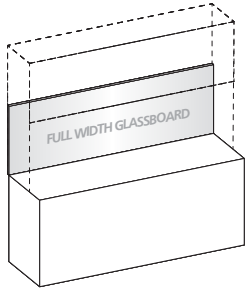

Product Width	Panel Dimension	SKU	List
93	91 x .5 x 21	GBOC9121	2382
87	85 x .5 x 21	GBOC8521	2236
83	81 x .5 x 21	GBOC8121	2138
76	74 x .5 x 21	GBOC7421	1969
70	68 x .5 x 21	GBOC6821	1822
64	62 x .5 x 21	GBOC6221	1676
58	56 x .5 x 21	GBOC5621	1531
47	45 x .5 x 21	GBOC4521	1264
35	33 x .5 x 21	GBOC3321	972
29	27 x .5 x 21	GBOC2721	826

Standard Features  
- 4 mm tempered glass

Notes  
- Earth magnets are required to hold items securely in place  
- Hung with Z-Strip mounting system  
- Use glass cleaner or alcohol to clean  
- Standard dry erase markers may be used

Overhead glassboard  
Half width glassboard

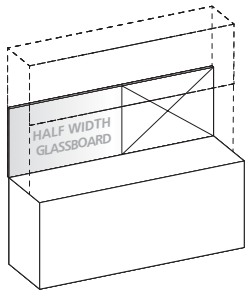

Product Width	Panel Dimension	SKU	List
93 Half Width	45.5 x .5 x 21	GBOC4521	1251
87 Half Width	42.5 x .5 x 21	GBOC4221	1178
83 Half Width	40.5 x .5 x 21	GBOC4021	1129
76 Half Width	37 x .5 x 21	GBOC3721	985
70 Half Width	34 x .5 x 21	GBOC3421	972
64 Half Width	31 x .5 x 21	GBOC3121	899

Standard Features  
- 4 mm tempered glass

Notes  
- Half width glassboards can be specified and combined with a Tackboard, Veneer panel, Marker Board or Slat Wall. See "Half Width" items under product width.  
- Specify right or left facing glassboard  
- Use glass cleaner or alcohol to clean  
- Standard dry erase markers may be used  
- Earth magnets are required to hold items securely in place  
- Hung with Z-Strip mounting system

# Jamestown tackboards.

Overhead slat wall  
*Half width slat wall*

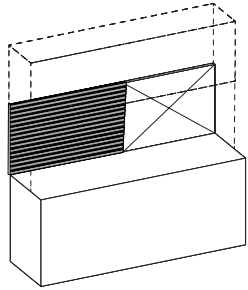

Product Width	Panel Dimension	SKU	List
93 Half Width	45.5 x .5 x 21	SWOC4521	463
87 Half Width	42.5 x .5 x 21	SWOC4221	432
83 Half Width	40.5 x .5 x 21	SWOC4021	411
76 Half Width	37 x .5 x 21	SWOC3721	374
70 Half Width	34 x .5 x 21	SWOC3421	343
64 Half Width	31 x .5 x 21	SWOC3121	312

### Standard Features

- Available in silver or black
- For use on 42"/43" height consoles
- Hung with Z-Strip mounting system

### Notes

- Half width slat walls can be specified and combined with a Tackboard, Veneer panel, Marker Board or Glassboard. See "Half Width" items under product width.
- Specify right or left facing slat wall

# Jamestown.

Single Height Wall Hung Overheads  
Panel Door - 6/4/2 Door

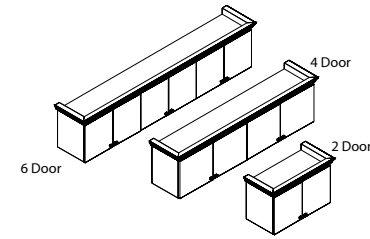

1 Select a model w" x d" x h"	weight	Standard Veneer Top Standard Veneer Chassis		Premium Veneer Top Premium Veneer Chassis		High Pressure Laminate Top Veneer Chassis		Thermally Fused Laminate Top Thermally Fused Laminate Chassis	
		<b>6 Door</b>							
93 x 15 x 20	190	JCM9320WH330W	4975	"P" Option N/A	"G" Option N/A	"M" Option N/A	"M" Option N/A	"M" Option N/A	"M" Option N/A
87 x 15 x 20	175	JCM8720WH330W	4703	"P" Option N/A	"G" Option N/A	"M" Option N/A	"M" Option N/A	"M" Option N/A	"M" Option N/A
<b>4 Door</b>									
70 x 15 x 20	145	JCM7020WH330W	3711	"P" Option N/A	"G" Option N/A	"M" Option N/A	"M" Option N/A	"M" Option N/A	"M" Option N/A
64 x 15 x 20	130	JCM6420WH330W	3574	"P" Option N/A	"G" Option N/A	"M" Option N/A	"M" Option N/A	"M" Option N/A	"M" Option N/A
58 x 15 x 20	120	JCM5820WH330W	3413	"P" Option N/A	"G" Option N/A	"M" Option N/A	"M" Option N/A	"M" Option N/A	"M" Option N/A
<b>2 Door</b>									
35 x 15 x 20	75	JCM3520WH330W	2086	"P" Option N/A	"G" Option N/A	"M" Option N/A	"M" Option N/A	"M" Option N/A	"M" Option N/A
29 x 15 x 20	65	JCM2920WH330W	1986	"P" Option N/A	"G" Option N/A	"M" Option N/A	"M" Option N/A	"M" Option N/A	"M" Option N/A

2 Select a finish <i>View finish details</i>	Edge	
	WAC	N/A
WRC	N/A	
WIC	N/A	
WHC	N/A	
WOC	N/A	
WEW	N/A	
WGW	N/A	
WBW	N/A	
WNW	N/A	

3 Select a edge <i>View edge details</i>	Edge	
		N/A

4 Select hardware <i>View hardware details</i>	DK-114 Brushed Pewter		DK-4 Antique Brass	

*View statement of line*

## Product features.

- Back is painted black
- Cornice top
- Interior cabinet depth 12"
- Wall mount rail included

### NOTES

- Proper installation is critical to ensure safety from possible falling cabinets. The factory assumes no liability for damage or injury from The following: installation into non-load bearing or unlevel walls. Improper fasteners used in installation. Overloading of cabinets resulting in failures of wall and surrounding structures, fasteners, or cabinet construction. Misuse of cabinets for intended purposes.

## Options.

### DOOR

- D2: Door Lock - \$100 per door set
- D6: Delete Doors - n/c
- D95C: Soft Close Door Hinges - \$20 per door

### FLUSH CUT

- FC-B: Flush Unit Both Sides(Facing) for Ganging - \$100
- FC-R: Flush Unit Right (Facing) for Ganging - \$100
- FC-L Flush Unit Left (Facing) for Ganging - \$100

### TASK LIGHTING (RECESSED)

- Overhead tasklight cord is located on the right facing side. If the opposite location is required please contact customer service.
- LT-LED24R: 24" LED Task light - \$190
  - LT-LED48R: 48" LED Task light - \$245
  - LT-LED60R: 60" LED Task light - \$310
  - LT-LED72R: 72" LED Task light - \$335
  - LC24: Linking Task light cable - \$25

# Jamestown.

Single Height Wall Hung Overheads  
Wood Frame Beveled Glass - 6/4/2 Door

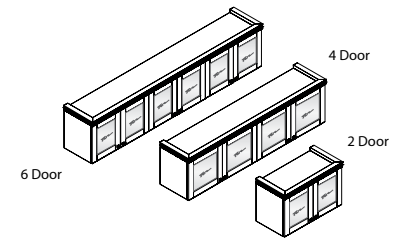

## 1 Select a model

w" x d" x h"

weight	Standard Veneer Top		Premium Veneer Top		High Pressure Laminate Top		Thermally Fused Laminate Top	
	Standard Veneer Chassis		Premium Veneer Chassis		Veneer Chassis		Thermally Fused Laminate Chassis	
<b>6 Door</b>								
93 x 15 x 20	190	JCM9320WH329W	5794	"P" Option N/A	"G" Option N/A	"M" Option N/A	"M" Option N/A	
87 x 15 x 20	175	JCM8720WH329W	5521	"P" Option N/A	"G" Option N/A	"M" Option N/A	"M" Option N/A	
<b>4 Door</b>								
70 x 15 x 20	145	JCM7020WH329W	4298	"P" Option N/A	"G" Option N/A	"M" Option N/A	"M" Option N/A	
64 x 15 x 20	130	JCM6420WH329W	4120	"P" Option N/A	"G" Option N/A	"M" Option N/A	"M" Option N/A	
58 x 15 x 20	120	JCM5820WH329W	3958	"P" Option N/A	"G" Option N/A	"M" Option N/A	"M" Option N/A	
<b>2 Door</b>								
35 x 15 x 20	75	JCM3520WH329W	2359	"P" Option N/A	"G" Option N/A	"M" Option N/A	"M" Option N/A	
29 x 15 x 20	65	JCM2920WH329W	2259	"P" Option N/A	"G" Option N/A	"M" Option N/A	"M" Option N/A	

[View statement of line](#)

## Product features.

- Back is painted black
- Beveled clear glass
- Cornice top
- Interior cabinet depth 12"
- Mounting wall rail included
- Solid wood door frame

### NOTES

- Proper installation is critical to ensure safety from possible falling cabinets. The factory assumes no liability for damage or injury from The following: installation into non-load bearing or unlevel walls. Improper fasteners used in installation. Overloading of cabinets resulting in failures of wall and surrounding structures, fasteners, or cabinet construction. Misuse of cabinets for intended purposes.

## Options.

### DOOR

- D2: Door Lock - \$100 per door set
- D6: Delete Doors - n/c
- D95C: Soft Close Door Hinges - \$20 per door
- D35: Replace glass panel insert with veneer panel insert - \$35 per door

### FLUSH CUT

- FC-B: Flush Unit Both Sides(Facing) for Ganging - \$100
- FC-R: Flush Unit Right (Facing) for Ganging - \$100
- FC-L: Flush Unit Left(Facing) for Ganging - \$100

### INTERIOR CABINET LIGHTING

- LEDPK starter kit includes Infeed, 1 Puck Interior Light and the ability to daisy chain up to 6 total Puck Lights
- LEDPK: LED Puck Starter Kit - \$310
- PK: 1 LED Interior Light - \$130

### TASK LIGHTING (RECESSED)

- Overhead tasklight cord is located on the right facing side. If the opposite location is required please contact customer service.
- LT-LED24R: 24" LED Task light - \$190
- LT-LED48R: 48" LED Task light - \$245
- LT-LED60R: 60" LED Task light - \$310
- LT-LED72R: 72" LED Task light - \$335
- LC24: Linking Task light cable - \$25

## 2 Select a finish

[View finish details](#)

WAC  
WRC  
WIC  
WHC  
WOC  
WEW  
WGW  
WBW  
WNW

## 3 Select a edge

[View edge details](#)

Edge  
N/A

## 4 Select hardware

[View hardware details](#)

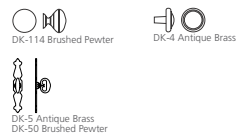



# Jamestown tackboards.

## Wall hung tackboards Full width tackboards

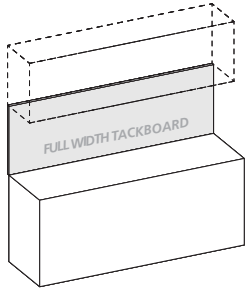

Product Width	Panel Dimension	SKU	COM	1	2	3	4	5	6	7	8	9	10	11/L1	12	13/L2
93	93 x .75 x 24	FTWH9324	465	576	627	678	729	780	831	882	933	984	1035	1086	1137	1239
87	87 x .75 x 24	FTWH8724	448	539	587	635	683	731	779	827	875	923	971	1019	1067	1163
83	83 x .75 x 24	FTWH8324	422	514	560	606	652	698	744	790	836	882	928	974	1020	1112
76	76 x .75 x 24	FTWH7624	388	471	514	557	600	643	686	729	772	815	858	901	944	1030
70	70 x .75 x 24	FTWH7024	355	434	474	514	554	594	634	674	714	754	794	834	874	954
64	64 x .75 x 24	FTWH6424	322	396	432	468	504	540	576	612	648	684	720	756	792	864
58	58 x .75 x 24	FTWH5824	294	359	391	423	455	487	519	551	583	615	647	679	711	775
47	47 x .75 x 24	FTWH4724	236	291	318	345	372	399	426	453	480	507	534	561	588	642
35	35 x .75 x 24	FTWH3524	176	217	237	257	277	297	317	337	357	377	397	417	437	477
29	29 x .75 x 24	FTWH2924	142	179	196	213	230	247	264	281	298	315	332	349	366	400

### Standard Features

- Constructed of .5" thick fiberboard
- Fabric is precisely aligned and fitted to the tackboard
- Adhered to the rigid hardboard with staples

- Hung with Z-Strip mounting system

## Wall hung tackboards Half width tackboards

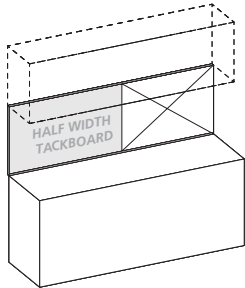

Product Width	Panel Dimension	SKU	COM	1	2	3	4	5	6	7	8	9	10	11/L1	12	13/L2
93 Half Width	46.5 x .75 x 24	FTWH4624	233	288	313	338	363	388	413	438	463	488	513	538	563	613
87 Half Width	43.5 x .75 x 24	FTWH4324	225	270	294	318	342	366	390	414	438	462	486	510	534	582
83 Half Width	41.5 x .75 x 24	FTWH4124	211	257	280	303	326	349	372	395	418	441	464	487	510	556
76 Half Width	38 x .75 x 24	FTWH3824	194	235	256	277	298	319	340	361	382	403	424	445	466	508
70 Half Width	35 x .75 x 24	FTWH3524	178	217	237	257	277	297	317	337	357	377	397	417	437	477
64 Half Width	32 x .75 x 24	FTWH3224	161	198	216	234	252	270	288	306	324	342	360	378	396	432

### Standard Features

- Constructed of .5" thick fiberboard
- Fabric is precisely aligned and fitted to the tackboard
- Adhered to the rigid hardboard with staples
- Hung with Z-Strip mounting system

### Notes

- Half width tackboards can be specified and combined with a Veneer Panel, Marker Board, Slat Wall or Glass Board. See "Half Width" items under product width.
- Specify right or left facing tackboard

## Jamestown tackboards.

Wall hung dry marker board  
Full width dry marker board

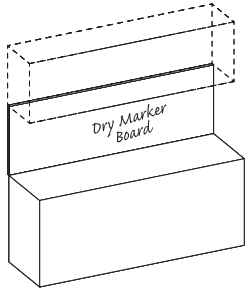

PRODUCT WIDTH	PANEL DIMENSION	SKU	LIST
Product Width	Panel Dimension	SKU	List
93	93 x .75 x 24	DMWH9324	1161
87	87 x .75 x 24	DMWH8724	1086
83	83 x .75 x 24	DMWH8324	1023
76	76 x .75 x 24	DMWH7624	948
70	70 x .75 x 24	DMWH7024	874
64	64 x .75 x 24	DMWH6424	799
58	58 x .75 x 24	DMWH5824	724
47	47 x .75 x 24	DMWH4724	587
35	35 x .75 x 24	DMWH3524	437
29	29 x .75 x 24	DMWH2924	362

### Standard Features

- Dry marker panel has edge trim molding

- Standard magnetic surface
- Hung with Z-Strip mounting system

Wall hung dry marker board  
Half width dry marker board

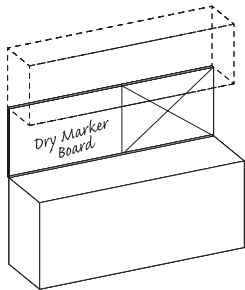

Product Width	Panel Dimension	SKU	List
93 Half Width	46.5 x .75 x 24	DMWH4624	580
87 Half Width	43.5 x .75 x 24	DMWH4324	543
83 Half Width	41.5 x .75 x 24	DMWH4124	518
76 Half Width	38 x .75 x 24	DMWH3824	474
70 Half Width	35 x .75 x 24	DMWH3524	437
64 Half Width	32 x .75 x 24	DMWH3224	399

### Standard Features

- Dry marker panel has edge trim molding
- Standard magnetic surface
- Hung with Z-Strip mounting system

### Notes

- Half width dry marker boards can be specified and combined with a Tackboard, Veneer Panel, Slat Wall or Glass Board. See "Half Width" items under product width.
- Specify right or left facing dry marker board

## Jamestown tackboards.

Wall hung veneer panel  
Full width veneer panel

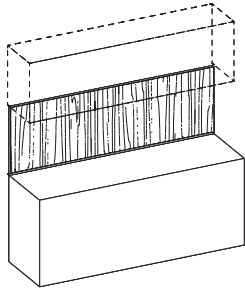

Product Width	Panel Dimension	SKU	List
93	93 x .75 x 24	VPWH9324	967
87	87 x .75 x 24	VPWH8724	905
83	83 x .75 x 24	VPWH8324	853
76	76 x .75 x 24	VPWH7624	790
70	70 x .75 x 24	VPWH7024	728
64	64 x .75 x 24	VPWH6424	666
58	58 x .75 x 24	VPWH5824	603
47	47 x .75 x 24	VPWH4724	489
35	35 x .75 x 24	VPWH3524	364
29	29 x .75 x 24	VPWH2924	302

### Standard Features

- Hung with Z-Strip mounting system

### Notes

- Veneer edges.
- Vertical wire channels on back for task light cords
- Steel mounting wall channel is recessed for flush mounting
- Can be used with or without overhead cabinet
- Required for other accessory panels

Wall hung veneer panel  
Half width veneer panel

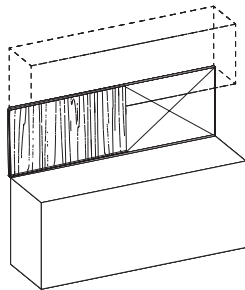

Product Width	Panel Dimension	SKU	List
93 Half Width	46.5 x .75 x 24	VPWH4624	484
87 Half Width	43.5 x .75 x 24	VPWH4324	452
83 Half Width	41.5 x .75 x 24	VPWH4124	432
76 Half Width	38 x .75 x 24	VPWH3824	395
70 Half Width	35 x .75 x 24	VPWH3524	364
64 Half Width	32 x .75 x 24	VPWH3224	333

### Standard Features

- Veneer edges
- Vertical wire channels on back for task light cords
- Steel mounting wall channel is recessed for flush mounting
- Hung with Z-Strip mounting system

### Notes

- Half width veneer panels can be specified and combined with a Tackboard, Marker Board, Slat Wall or Glass Board. See "Half Width" items under product width.
- Specify right or left facing veneer panel
- Can be used with or without overhead cabinet
- Required for other accessory panels

# Jamestown tackboards.

Wall hung glassboard  
Full width glassboards

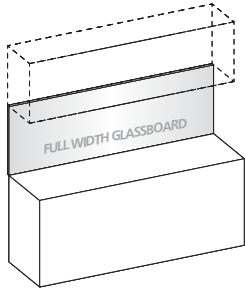

Product Width	Panel Dimension	SKU	List
93	93 x .75 x 24	GBWH9324	2753
87	87 x .75 x 24	GBWH8724	2586
83	83 x .75 x 24	GBWH8324	2475
76	76 x .75 x 24	GBWH7624	2281
70	70 x .75 x 24	GBWH7024	2114
64	64 x .75 x 24	GBWH6424	1948
58	58 x .75 x 24	GBWH5824	1780
47	47 x .75 x 24	GBWH4724	1476
35	35 x .75 x 24	GBWH3524	1142
29	29 x .75 x 24	GBWH3924	976

Standard Features  
- 4 mm tempered glass

Notes-

- Standard dry erase markers may be used
- Earth magnets are required to hold items securely in place
- Hung with Z-Strip mounting system
- Use glass cleaner or alcohol to clean

Wall hung glassboard  
Half width glassboards

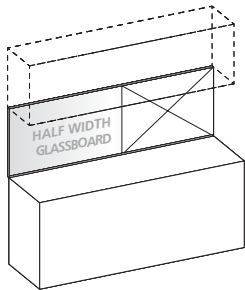

Product Width	Panel Dimension	SKU	List
93 Half Width	46.5 x .75 x 24	GBWH4624	1461
87 Half Width	43.5 x .75 x 24	GBWH4324	1378
83 Half Width	41.5 x .75 x 24	GBWH4124	1323
76 Half Width	38 x .75 x 24	GBWH3824	1232
70 Half Width	35 x .75 x 24	GBWH3524	1142
64 Half Width	32 x .75 x 24	GBWH3224	1059

Standard Features  
- 4 mm tempered glass

Notes

- Half width glassboards can be specified and combined with a Tackboard, Veneer panel, Marker Board or Slat Wall. See "Half Width" items under product width.
- Specify right or left facing glassboard-
- Use glass cleaner or alcohol to clean
- Standard dry erase markers may be used
- Earth magnets are required to hold items securely in place
- Hung with Z-Strip mounting system

# Jamestown tackboards.

Wall hung slat wall  
Half width slat wall

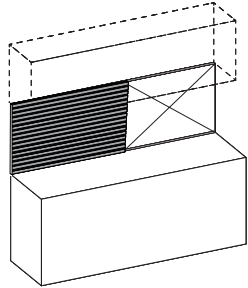

Product Width	Panel Dimension	SKU	List
93 Half Width	46.5 x .75 x 24	SWWH4624	484
87 Half Width	43.5 x .75 x 24	SWWH4324	452
83 Half Width	41.5 x .75 x 24	SWWH4124	432
76 Half Width	38 x .75 x 24	SWWH3824	395
70 Half Width	35 x .75 x 24	SWWH3524	364
64 Half Width	32 x .75 x 24	SWWH3224	333

### Standard Features

- Available in silver or black
- Hung with Z-Strip mounting system

### Notes

- Half width slat walls can be specified and combined with a Tackboard, Veneer panel - Marker Board or Glassboard. See "Half Width" items under product width.
- Specify right or left facing slat wall
- For use on 42"/43" height consoles

# Jamestown.

Single Height Overhead  
35"/29" Bookcase / Hutch Overhead With Cornice Top

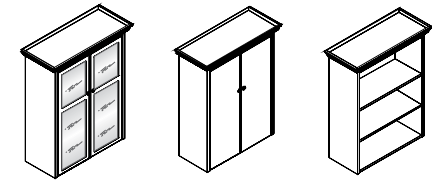

Frame Door W/ Beveled Glass Panel Door Open Bookcase

[View statement of line](#)

1 Select a model w" x d" x h"	weight	Standard Veneer Top		Premium Veneer Top		High Pressure Laminate Top		Thermally Fused Laminate Top	
		Standard Veneer Chassis		Premium Veneer Chassis		Veneer Chassis		Thermally Fused Laminate Chassis	
<b>Frame Door w/ Beveled Glass</b>									
35 x 15 x 44	120	JCM3544OH552W	2916	"P" Option N/A	"G" Option N/A	"G" Option N/A	"M" Option N/A	"M" Option N/A	"M" Option N/A
29 x 15 x 44	115	JCM2944OH552W	2766	"P" Option N/A	"G" Option N/A	"G" Option N/A	"M" Option N/A	"M" Option N/A	"M" Option N/A
35 x 15 x 51	150	JCM3551OH552W	3042	"P" Option N/A	"G" Option N/A	"G" Option N/A	"M" Option N/A	"M" Option N/A	"M" Option N/A
29 x 15 x 51	145	JCM2951OH552W	2891	"P" Option N/A	"G" Option N/A	"G" Option N/A	"M" Option N/A	"M" Option N/A	"M" Option N/A
<b>Panel Door</b>									
35 x 15 x 44	130	JCM3544OH570W	2766	"P" Option N/A	"G" Option N/A	"G" Option N/A	"M" Option N/A	"M" Option N/A	"M" Option N/A
29 x 15 x 44	125	JCM2944OH570W	2618	"P" Option N/A	"G" Option N/A	"G" Option N/A	"M" Option N/A	"M" Option N/A	"M" Option N/A
35 x 15 x 51	160	JCM3551OH570W	2887	"P" Option N/A	"G" Option N/A	"G" Option N/A	"M" Option N/A	"M" Option N/A	"M" Option N/A
29 x 15 x 51	155	JCM2951OH570W	2744	"P" Option N/A	"G" Option N/A	"G" Option N/A	"M" Option N/A	"M" Option N/A	"M" Option N/A
<b>Open Bookcase</b>									
35 x 15 x 44	100	JCM3544OH551W	2034	"P" Option N/A	"G" Option N/A	"G" Option N/A	"M" Option N/A	"M" Option N/A	"M" Option N/A
29 x 15 x 44	90	JCM2944OH551W	1886	"P" Option N/A	"G" Option N/A	"G" Option N/A	"M" Option N/A	"M" Option N/A	"M" Option N/A
35 x 15 x 51	130	JCM3551OH551W	2130	"P" Option N/A	"G" Option N/A	"G" Option N/A	"M" Option N/A	"M" Option N/A	"M" Option N/A
29 x 15 x 51	120	JCM2951OH551W	2017	"P" Option N/A	"G" Option N/A	"G" Option N/A	"M" Option N/A	"M" Option N/A	"M" Option N/A
<b>2 Select a finish</b>									
		WAC							
		WRC							
		WIC							
		WHC							
		WOC							
		WEW							
		WGW							
		WBW							
		WNW							
<b>3 Select an edge</b>									
		Edge							
		N/A							
<b>4 Select hardware</b>									
		DK-114 Brushed Pewter		DK-4 Antique Brass					
		DK-5 Antique Brass		DK-50 Brushed Pewter					

## Product features.

- 2 Adjustable finished shelves
- Back is painted black
- Cornice top
- Interior shelf depth 12"

### NOTES

- Unit has black back panel and is not designed for Open Plan use. Select OPB Option for Open Plan application

## Options.

### DOOR

- D2: Door Lock - \$100 per door set
- D9SC: Soft Close Door Hinges - \$20 per door
- D35: Optional Wood Panel Insert - \$35 per individual panel insert (OH552 product only)

### FLUSH CUT

- FC-B: Flush Unit Both Sides(Facing) for Ganging - \$100
- FC-R: Flush Unit Right (Facing) for Ganging - \$100
- FC-L: Flush Unit Left (Facing) for Ganging - \$100

### INTERIOR CABINET LIGHTING

- LEDPK starter kit includes Infeed, 1 Puck Interior Light and the ability to daisy chain up to 6 total Puck Lights
- LEDPK: LED Puck Starter Kit - \$310
- PK: 1 LED Interior Light - \$130

### OPEN PLAN – FINISHED BACK

- OPB: "W" "G" Style - Modify Unit for Open Plan Application - \$395

### SHELVES

- GS14F: Replace Standard Shelves with Glass Shelf - \$90 per shelf
- S714F: Replace standard shelves with heavy duty 1" thick wood shelf - \$80 per shelf

# Jamestown.

Single Height Overhead  
70" Bookcase/Hutch Overhead With Cornice Top

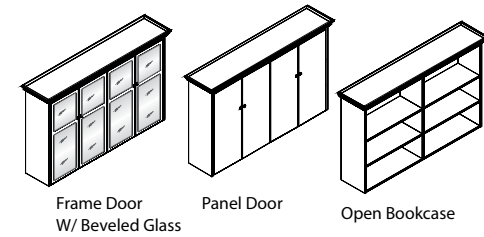

[View statement of line](#)

1 Select a model w" x d" x h"	weight	Standard Veneer Top Standard Veneer Chassis		Premium Veneer Top Premium Veneer Chassis		High Pressure Laminate Top Veneer Chassis		Thermally Fused Laminate Top Thermally Fused Laminate Chassis	
		<b>Frame Door w/ Beveled Glass</b>							
70 x 15 x 44	250	JCM7044OH552W	5246	"P" Option N/A		"G" Option N/A		"M" Option N/A	
70 x 15 x 51	300	JCM7051OH552W	6084	"P" Option N/A		"G" Option N/A		"M" Option N/A	
<b>Panel Door</b>									
70 x 15 x 44	260	JCM7044OH570W	4806	"P" Option N/A		"G" Option N/A		"M" Option N/A	
70 x 15 x 51	310	JCM7051OH570W	5572	"P" Option N/A		"G" Option N/A		"M" Option N/A	
<b>Open Bookcase</b>									
70 x 15 x 44	200	JCM7044OH551W	3486	"P" Option N/A		"G" Option N/A		"M" Option N/A	
70 x 15 x 51	250	JCM7051OH551W	4042	"P" Option N/A		"G" Option N/A		"M" Option N/A	

2 Select a finish <a href="#">View finish details</a>	WAC
	WRC
	WIC
	WHC
	WOC
	WEW
	WGW
	WBW
WNW	

3 Select a edge <a href="#">View edge details</a>	Edge
	N/A

4 Select hardware <a href="#">View hardware details</a>	DK-114 Brushed Pewter	DK-4 Antique Brass
	DK-5 Antique Brass	DK-50 Brushed Pewter

## Product features.

- 4 Adjustable finished shelves
- Shipped assembled
- Back is painted black
- Cornice top
- Interior shelf depth 12"

### NOTES

- Unit has black back panel and is not designed for Open Plan use. Select OPB Option for Open Plan application

## Options.

### DOOR

- D2: Door Lock - \$100 per door set
- D95C: Soft Close Door Hinges - \$20 per door
- D35: Optional Wood Panel Insert - \$35 per individual panel insert (OH552 product only)

### FLUSH CUT

- FC-B: Flush Unit Both Sides(Facing) for Ganging - \$100
- FC-R: Flush Unit Right (Facing) for Ganging - \$100
- FC-L: Flush Unit Left (Facing) for Ganging - \$100

### INTERIOR CABINET LIGHTING

- LEDPK starter kit includes Infeed, 1 Puck Interior Light and the ability to daisy chain up to 6 total Puck Lights
- LEDPK: LED Puck Starter Kit - \$310
- PK: 1 LED Interior Light - \$130

### OPEN PLAN – FINISHED BACK

- OPB: "W" "G" Style - Modify Unit for Open Plan Application - \$395

### SHELVES

- GS14F: Replace Standard Shelves with Glass Shelf - \$90 per shelf
- S714F: Replace standard shelves with heavy duty 1" thick wood shelf - \$80 per shelf

# Jamestown.

Tower Cabinets  
Wardrobe / Storage Tower

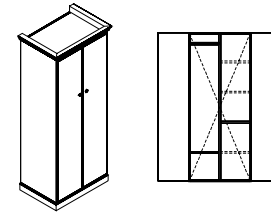

## 1 Select a model

w" x d" x h"	weight	Standard Veneer Top Standard Veneer Chassis	Premium Veneer Top Premium Veneer Chassis	High Pressure Laminate Top Veneer Chassis	Thermally Fused Laminate Top Thermally Fused Laminate Chassis
29 x 24 x 77	310	JCM2977TW275W 5745	"P" Option N/A	"G" Option N/A	"M" Option N/A
29 x 24 x 84	350	JCM2984TW275W 6444	"P" Option N/A	"G" Option N/A	"M" Option N/A
35 x 24 x 77	325	JCM3577TW275W 6107	"P" Option N/A	"G" Option N/A	"M" Option N/A
35 x 24 x 84	365	JCM3584TW275W 6662	"P" Option N/A	"G" Option N/A	"M" Option N/A

[View statement of line](#)

## 2 Select a finish

[View finish details](#)

- WAC
- WRC
- WIC
- WHC
- WOC
- WEW
- WGW
- WBW
- WNW

## 3 Select a edge

[View edge details](#)

- Edge
- N/A

## 4 Select hardware

[View hardware details](#)



## Product features.

- 2 fixed shelves
- 3 Adjustable shelves
- Cornice top
- Standard non-locking
- Wardrobe w/ coat rod & hook
- Panel doors w/ pulls

### NOTES

- Unit has black back panel and is not designed for Open Plan use. Select OPB Option for Open Plan application

## Options.

### DOOR

- D2: Lock door - \$100 per door
- D9SC: Soft Close Door Hinges - \$20 per door

### FLUSH CUT

- FC-B: Flush Unit Both Sides(Facing) for Ganging - \$100
- FC-R: Flush Unit Right (Facing) for Ganging - \$100
- FC-L Flush Unit Left(Facing) for Ganging - \$100

### OPEN PLAN – FINISHED BACK

- OPB: Finished Back - \$395

### SHELVES

- MOD-31: Delete center partition & half shelves and add 2 full shelves - \$295



# Jamestown.

Tower Cabinets  
Lateral File / Storage Tower

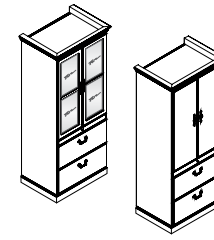

## 1 Select a model

w" x d" x h"

weight	Standard Veneer Top		Premium Veneer Top		High Pressure Laminate Top		Thermally Fused Laminate Top	
	Standard Veneer Chassis		Premium Veneer Chassis		Veneer Chassis		Thermally Fused Laminate Chassis	
<b>Panel Wood Door</b>								
29 x 24 x 77	325	JCM2977TW281W	6089	"P" Option N/A	"G" Option N/A	"M" Option N/A		
29 x 24 x 84	365	JCM2984TW281W	6788	"P" Option N/A	"G" Option N/A	"M" Option N/A		
35 x 24 x 77	340	JCM3577TW281W	6450	"P" Option N/A	"G" Option N/A	"M" Option N/A		
35 x 24 x 84	380	JCM3584TW281W	7006	"P" Option N/A	"G" Option N/A	"M" Option N/A		
<b>Beveled Glass Door</b>								
29 x 24 x 77	325	JCM2977TW312W	6765	"P" Option N/A	"G" Option N/A	"M" Option N/A		
29 x 24 x 84	365	JCM2984TW312W	7625	"P" Option N/A	"G" Option N/A	"M" Option N/A		

[View statement of line](#)

## 2 Select a finish

[View finish details](#)

- WAC
- WRC
- WIC
- WHC
- WOC
- WEW
- WGW
- WBW
- WNV

## 3 Select a edge

[View edge details](#)

- Edge
- N/A

## 4 Select hardware

[View hardware details](#)



## Product features.

- 2 Lateral files
- Back is painted black
- Central Lock
- Cornice top
- Doors/Drawers feature shaped edges

### NOTES

- Unit has black back panel and is not designed for Open Plan use. Select OPB Option for Open Plan application

## Options.

### DOOR

- D2: Lock door - \$100 per door
- D35: Optional Wood Panel Insert - \$35 per insert (TW312 Only)

### DRAWER

- PL-DBL: Add second pull to lateral file drawer - \$20 per Pull

### FLUSH CUT

- FC-B: Flush Unit Both Sides(Facing) for Ganging - \$100
- FC-R: Flush Unit Right (Facing) for Ganging - \$100
- FC-L Flush Unit Left(Facing) for Ganging - \$100

### INTERIOR CABINET LIGHTING

- LEDPK starter kit includes Infeed, 1 Puck Interior Light and the ability to daisy chain up to 6 total Puck Lights
- LEDPK: LED Puck Starter Kit - \$310
- PK: 1 LED Interior Light - \$130

### OPEN PLAN – FINISHED BACK

- OPB: Finished Back - \$395

### STORAGE

- S20: Add vertical center partitions to storage area for half wardrobe/half storage - \$205

### SHELVES

- GS14F: Replace Standard Shelves with Glass Shelf - \$90 per shelf

# Jamestown.

Bookcases  
Open Bookcases

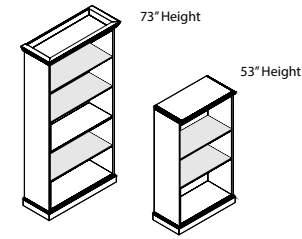

## 1 Select a model

w" x d" x h"

weight	Standard Veneer Top Standard Veneer Chassis		Premium Veneer Top Premium Veneer Chassis	High Pressure Laminate Top Veneer Chassis	Thermally Fused Laminate Top Thermally Fused Laminate Chassis
	35 x 14 x 73	160	JCM3573BK250W 2984	"P" Option N/A	"G" Option N/A
35 x 14 x 53	115	JCM3553BK250W 1817	"P" Option N/A	"G" Option N/A	"M" Option N/A
29 x 14 x 73	150	JCM2973BK250W 2834	"P" Option N/A	"G" Option N/A	"M" Option N/A
29 x 14 x 53	105	JCM2953BK250W 1668	"P" Option N/A	"G" Option N/A	"M" Option N/A

[View statement of line](#)

## 2 Select a finish

[View finish details](#)

- WAC
- WRC
- WIC
- WHC
- WOC
- WEW
- WGW
- WBW
- WNW

## 3 Select a edge

[View edge details](#)



## 4 Select hardware

[View hardware details](#)

Hardware  
N/A

## Product features.

- 53" w/ 2 adjustable shelves
- 73" w/ 1 fixed and 3 adjustable shelves
- Back is painted black
- Interior shelf depth 12"
- "W" styles - 53" H units finished top, 73" H units black painted top

### NOTES

- Tops add 2" to dimensions
- Unit has black back panel and is not designed for Open Plan use. Select OPB Option for Open Plan application

## Options.

### FLUSH CUT

- FC-B: Flush Unit Both Sides(Facing) for Ganging - \$100
- FC-R: Flush Unit Right (Facing) for Ganging - \$100
- FC-L: Flush Unit Left (Facing) for Ganging - \$100

### INTERIOR CABINET LIGHTING

- LEDPK starter kit includes Infeed, 1 Puck Interior Light and the ability to daisy chain up to 6 total Puck Lights
- LEDPK: LED Puck Starter Kit - \$310
- PK: 1 LED Interior Light - \$130

### OPEN PLAN – FINISHED BACK

- OPB: "W" "G" Style - Modify Unit for Open Plan Application - \$395

### SHELVES

- ADS14F: Add standard wood shelf - \$110
- GS14F: Replace Standard Shelves with Glass Shelves - \$90 per shelf
- S714F: Replace standard shelves with heavy duty 1" thick wood shelf - \$80 per shelf

# Jamestown.

Bookcases

Panel Door Bookcases

## 1 Select a model

w" x d" x h"	weight	Standard Veneer Top Standard Veneer Chassis	Premium Veneer Top Premium Veneer Chassis	High Pressure Laminate Top Veneer Chassis	Thermally Fused Laminate Top Thermally Fused Laminate Chassis
35 x 14 x 81	205	JCM3581BK251W 3561	"P" Option N/A	"G" Option N/A	"M" Option N/A
35 x 14 x 73	175	JCM3573BK251W 3274	"P" Option N/A	"G" Option N/A	"M" Option N/A
35 x 14 x 53	135	JCM3553BK251W 2109	"P" Option N/A	"G" Option N/A	"M" Option N/A
29 x 14 x 81	195	JCM2981BK251W 3412	"P" Option N/A	"G" Option N/A	"M" Option N/A
29 x 14 x 73	165	JCM2973BK251W 3126	"P" Option N/A	"G" Option N/A	"M" Option N/A
29 x 14 x 53	125	JCM2953BK251W 1960	"P" Option N/A	"G" Option N/A	"M" Option N/A

## 2 Select a finish

[View finish details](#)

WAC  
WRC  
WIC  
WHC  
WOC  
WEW  
WGW  
WBW  
WNW

## 3 Select a edge

[View edge details](#)



## 4 Select hardware

[View hardware details](#)

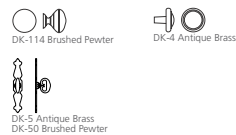

[View statement of line](#)

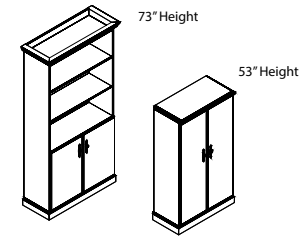

## Product features.

- 53" w/ 2 adjustable shelves
- 73" w/ 1 fixed and 3 adjustable shelves
- 81" w/ 1 fixed and 3 adjustable shelves
- Back is painted black
- Doors with profile edge shape
- Interior shelf depth 12"
- "W" styles - 53" H units finished top, 73" H units black painted top

### NOTES

- Tops add 2" to dimensions
- Unit has black back panel and is not designed for Open Plan use. Select OPB Option for Open Plan application

## Options.

### DOOR

- D2: Lock door - \$100 per door
- D9SC: Soft Close Door Hinges - \$20 per door
- DGL-01: Wood frame door with glass panel insert for a 53" high bookcase - \$160 per door

### FLUSH CUT

- FC-B: Flush Unit Both Sides(Facing) for Ganging - \$100
- FC-R: Flush Unit Right (Facing) for Ganging - \$100
- FC-L: Flush Unit Left (Facing) for Ganging - \$100

### INTERIOR CABINET LIGHTING

- LEDPK starter kit includes Infeed, 1 Puck Interior Light and the ability to daisy chain up to 6 total Puck Lights
- LEDPK: LED Puck Starter Kit - \$310
- PK: 1 LED Interior Light - \$130

### OPEN PLAN – FINISHED BACK

- OPB: "W" "G" Style - Modify Unit for Open Plan Application - \$395

### SHELVES

- ADS14F: Add standard wood shelf - \$110
- GS14F: Replace Standard Shelves with Glass Shelf - \$90 per shelf
- S714F: Replace standard shelves with heavy duty 1" thick wood shelf - \$80 per shelf

## Jamestown options.



COMPUTER SUPPORT  
*single monitor arm*

Style Number	List Price
MA1	280

### Specifications

- Available in black or silver
- Desk clamp and mounting included
- Easy assembly and flexibility
- Elastic painting process for a durable and beautiful finish
- Gas spring tension adjustment for counter-balance height adjustment for monitors 1-8 KG
- Gas spring tested to 50,000 repetitions
- Hidden cable management



COMPUTER SUPPORT  
*double monitor arm*

Style Number	List Price
MA2	450

### Specifications

- Available in black or silver
- Desk clamp and mounting included
- Easy assembly and flexibility
- Elastic painting process for a durable and beautiful finish
- Gas spring tension adjustment for counter-balance height adjustment for monitors 1-8 KG
- Gas spring tested to 50,000 repetitions
- Hidden cable management



COMPUTER SUPPORT  
*triple monitor arm*

Style Number	List Price
MA3	530

### Specifications

- Available in black or silver
- Desk clamp and mounting included
- Easy assembly and flexibility
- Elastic painting process for a durable and beautiful finish
- Gas spring tension adjustment for counter-balance height adjustment for monitors 1-8 KG
- Gas spring tested to 50,000 repetitions
- Hidden cable management



COMPUTER SUPPORT  
*quadruple monitor arm*

Style Number	List Price
MA4	705

### Specifications

- Available in black
- Desk clamp and mounting included
- Easy assembly and flexibility
- Elastic painting process for a durable and beautiful finish
- Gas spring tension adjustment for counter-balance height adjustment for monitors 1-8 KG
- Gas spring tested to 50,000 repetitions
- Hidden cable management

# Jamestown options.

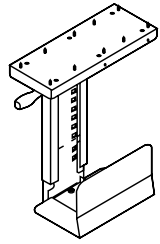

## COMPUTER SUPPORT *cpu retractable cradle*

Style Number	List Price
K18	205

### Specifications

- Black Metal CPU Carriage
- Full 360° swivel capability allows easy access to rear of CPU for cables / wires
- Track allows 8- 1/2" extension
- Width Adjustment 5-1/2" to 9-1/4"
- Height adjustment 14- 5/8" to 20- 1/2"
- Black epoxy finish

- Notes
- Factory Installed

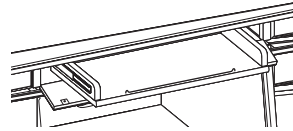

## COMPUTER SUPPORT *traditional pull-out drawer with keyboard tray*

Style Number	List Price
K21	470

### Specifications

- Available on:  
Desk 72"-66"  
Kneespace Credenza 72"-66"  
Workstation Credenza 72" single pedestal only
- Traditional Pull-out Drawer w/Keyboard Tray



## DOOR MODIFICATIONS *soft close door hinge*

Style Number	List Price
D9SC	20 Per door

### Specifications

- Snap onto standard door hinge
- Requires (2) per door
- Max door height 43"
- Factory installed where specified
- Individually shipped for field installation

- Notes
- Specify Each Item To Have Slow Close Feature

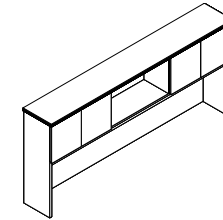

## DOOR MODIFICATIONS *delete doors*

Style Number	List Price
D6	N/C

### Specifications

- Standard Door overheads and cabinets can have door deleted for open access. Modification of hinge rails and structural components are made face ready.

# Jamestown options.

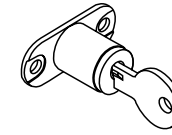
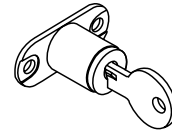
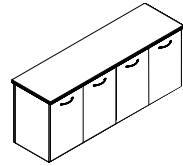
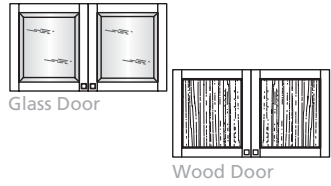

**DOOR MODIFICATIONS**  
*replace glass panel insert with veneer panel insert*

Style Number	List Price
D35	35 Per door

## Specifications

- Replace glass panel insert with veneer panel insert

**Notes**

- Not Available on "M" skus
- Glass door has beveled glass
- Wood door w/ veneer insert - only available on "W" style

**DOOR MODIFICATIONS**  
*delete doors/replace black laminate shelf w/ finished shelf*

Style Number	List Price
D6A	N/C

## Specifications

- Delete doors and replace black laminate shelf with finished shelf

**Notes**

- Available on: All Storage "W"/"G" Style Credenzas.

**DOOR MODIFICATIONS**  
*panel door lock*

Style Number	List Price
D2	100 Per door set

## Specifications

- Door Locks - 1 Door w/ Lock, Other Door w/ Catch Latch
- Contact Customer Service regarding limited lock locations and keying.

**Notes**

- Available on: Panel Doors, Wood Frame Doors, and Silverluma doors

**DOOR MODIFICATIONS**  
*glass door lock*

Style Number	List Price
D2-G	205 Per door set

## Specifications

- Door Locks - 1 Door w/ Lock, Other Door w/ Catch Latch
- Contact Customer Service regarding limited lock locations and keying.

**Notes**

- Available on: Glass Doors

# Jamestown options.

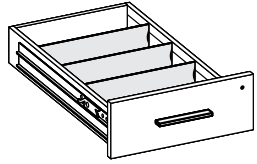

## DRAWER OPTIONS *box drawer accessories*

Style Number	List Price
Wood Drawer Dividers w/ Clips K-DIV	SET OF 3 - 30
Single Tray - Utility Tray K-SUT	35 ea.

### Specifications

- K-DIV Extra Wood Drawer Dividers with Clips, Top Box drawers standard with 1 divider
- K-SUT Single Tray - Utility Tray, Specify Legal or Letter drawer width

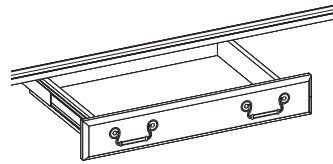

## DRAWER OPTIONS *traditional center drawer*

Style Number	List Price
K17	235
Add Skirt Option K17-SK	340

### Specifications

- Standard on desks in Jamestown Collection. Optional center drawers available for bullet conference desk, kneespace credenzas and corner units. 3 ply hardwood drawer / dowel construction profile shaped drawer front. Specify pull choice.

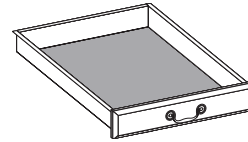

## DRAWER OPTIONS - BOTTOM COVER *black dura-leather drawer bottom covers*

Style Number	List Price
P2	80

### Specifications

- Center drawer and Box/Tray drawers are covered in Black Duraleather that adds a prestigious touch.

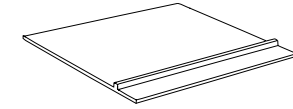

## DRAWER OPTIONS - BOTTOM COVER *felt bottom center drawer insert liner*

Style Number	List Price
K3	100

### Specifications

- Inserts into center drawer and features divider for open pen and pencil storage. Removable for easy cleaning.
- Adds a luxurious touch to center drawers.
- Color: Dark Brown Coal

# Jamestown options.

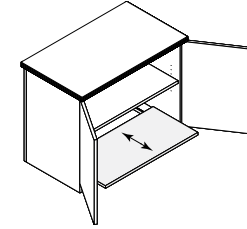
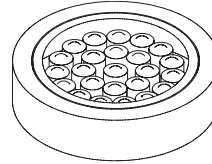

## GLASSBOARD ACCESSORIES *glassboard accessory kit*

Style Number	List Price
GBKIT	290

### Specifications

- 8 Earth magnets, 1 magnetic marker cup holder and 1 magnetic dry eraser

## RECESSED LIGHTING *lt-led task light*

Style Number	List Price
24" Task light LT-LED24R	190
48" Task light LT-LED48R	245
60" Task light LT-LED60R	310
72" Task light LT-LED72R	335

### Specifications

- 6.5' Power cord. Switch with touch dimmer
- 36 LEDs per foot
- 4.6 Watts per foot
- 91 Lumens per watt
- Please note when ganging.

## LIGHTING *led interior cabinet puck light*

Style Number	List Price
Starter Kit LEDPK	310
1 LED Interior Puck Light PK	130

### Specifications

- Starter kit includes Infeed, 1 Puck Interior Light and the ability to daisy chain up to 6 total Puck Lights
- (1) LED Puck Light with 30W power drive and switch
- Recessed fixture
- 12V linking cord 98"L
- Silver finish
- 50,000 hour life
- 2 watt per light

#### Notes

- Available on: Overhead/Tower Units with glass doors or no doors
- Power drive included, Light only

## PEDESTAL MODIFICATIONS *black laminate printer pullout bottom shelf*

Style Number	List Price
PPOS	225

### Specifications

- Black Laminate pullout shelf on suspension
- Black grommet
- Adjustable Shelf



# Jamestown options.

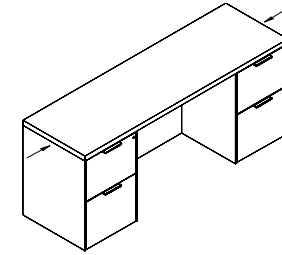
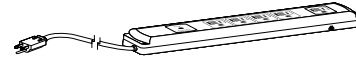
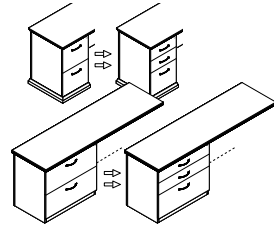
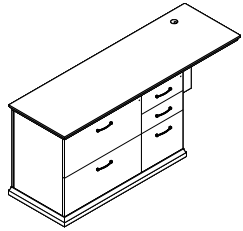

## PEDESTAL MODIFICATIONS

*add veneer kneespace cabinets - base*

Style Number	List Price
Add Box/Box/File or File/File P40B	1025
Add Lateral File 29" W P41B	1255
Add Multi-File - 31" W P42B	1255
Add Storage With Doors 29"W P43B	1140
Add CPU /Printer Cabinet - Open P44B	1140

### Specifications

- Multi-file specify Box/Box Left or Right

#### Notes

- Add additional Standard Cabinets To Kneespace Area.

## PEDESTAL MODIFICATIONS

*modify drawer configurations*

Style Number	List Price
File/File to Box/Box/File P6	55 Per ped
Box/Box/File to File/File P6	55 Per ped
Lateral File to 2 Box Drawers P8	100 Per ped

### Specifications

- Modify File/File To Box/Box/File - Any Unit

## POWER / DATA

*power supply cordset*

Style Number	List Price
PD717	100

### Specifications

- SIZE: 10.75"L x 2.0"W x 1.06"H
- (5) Outlets w/ 10' cord
- Surge suppression (720 Joules)
- 15 Amp breaker
- Available on: Vertical Panels, Cabinet Interiors, and under tops

## PRODUCT MODIFICATIONS

*modify width - open kneespace*

Style Number	List Price
MOD-1	125

### Specifications

- Modify width down on any unit with an open kneespace: desk, workstation credenza, bridge, return

## Jamestown options.

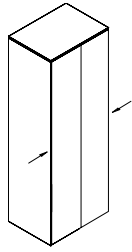

PRODUCT MODIFICATIONS  
*modify width - open/closed storage*

Style Number	List Price
MOD-2	250

### Specifications

- Modify width down on any unit with open or closed storage section: overheads, wall hung units, storage credenzas, towers

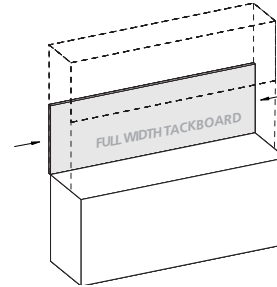

PRODUCT MODIFICATIONS  
*modify width - tackboard, slat wall, veneer panel, or a glassboard*

Style Number	List Price
MOD-4	50

### Specifications

- Modify width down on tackboard, slat wall, veneer panel, or a overhead glassboard

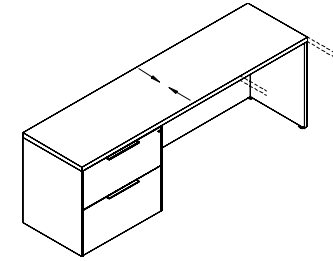

PRODUCT MODIFICATIONS  
*modify depth - decrease depth*

Style Number	List Price
MOD-5	125

### Specifications

- Modify depth down (minimum depth for a unit with drawers is 21" D)

Notes  
 - Ex. 24" to 21", 30" to 24", and 36" to 30"

## Jamestown options.

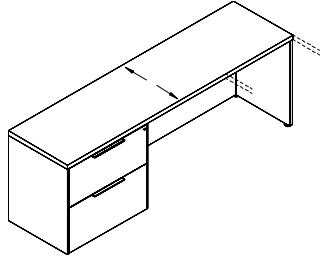

### PRODUCT MODIFICATIONS *modify depth - increase depth*

Style Number	List Price
MOD-6	Add 10%

### Specifications

- Increase depth by no more than 6"

Notes

- Ex. 24" to 30", 30" to 36", and 36" to 42"
- Add 10% to the unit you want to increase the depth of by no more than 6"

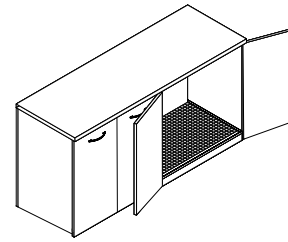

### PRODUCT MODIFICATIONS *modify height*

Style Number	List Price
MOD-7	Contact for pricing

### Specifications

- Modify height of a unit

### REFRIGERATOR MODIFICATION *refrigerator cabinet modification*

Style Number	List Price
REF01	205

### Specifications

- Open back cutout for venting
- Moisture sponge mat
- Contaminate ledge
- Contact customer service for maximum refrigerator size (Changes based on unit).

Notes

- Available on: 36" and 42" Storage Credenzas

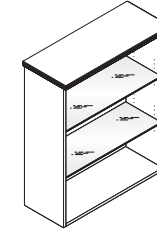

### SHELF MODIFICATIONS *glass shelves - tempered full width 26" - 35"*

Style Number	List Price
26"W - 35"W x 14"D Shelf GS14F	90

### Specifications

- Glass Shelves Replace Wood Shelf In Open Or Glass Door Cabinet. Also Order Interior Cabinet Lighting.

# Jamestown options.

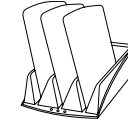
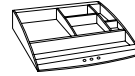
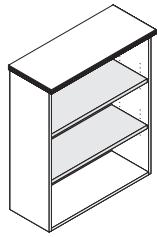
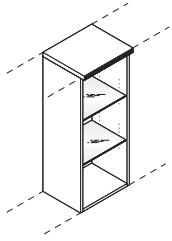

## SHELF MODIFICATIONS

*tempered glass shelves for half cabinet 17- 1/2" widths*

Style Number	List Price
14-1/2"W - 17- 1/2"W x 14"D Shelf GS14H	70 ea.

### Specifications

- Glass Shelves Replace Wood Shelf In Open Or Glass Door Cabinet. Also Order Interior Cabinet Lighting.

**Notes**

- Replace only adjustable shelves between cabinet light and fixed lower wood shelf.

## SHELF MODIFICATIONS

*heavy duty solid wood bookcase replacement shelves*

Style Number	List Price
1" Wood Shelf 14" Deep S714F	80 ea.
1" Wood Shelf 24" Deep S714FX	160 ea.

### Specifications

- 1" Solid Lumber Core Shelves Replace Standard 3/4" Plywood Adjustable And Fixed Shelves

## SLAT WALL ACCESSORIES

*slat wall accessory tray*

Style Number	List Price
SWA9	50

### Specifications

- Specify Black Or Matte Silver

## SLAT WALL ACCESSORIES

*slat wall folder tray*

Style Number	List Price
SWA7	50

### Specifications

- Specify Black Or Matte Silver

# Jamestown options.

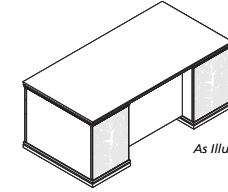
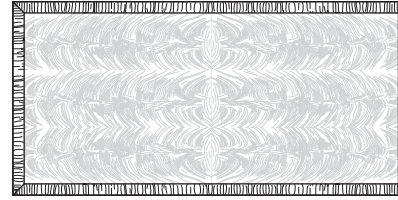
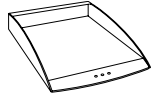

As Illustrated: (2) FCC1

Desk Approach  
Pedestal Fronts

## SLAT WALL ACCESSORIES *slat wall paper tray*

Style Number	List Price
SWA2	40

### Specifications

- Specify Black Or Matte Silver

## SLAT WALL ACCESSORIES *slat wall pencil holder*

Style Number	List Price
SWA4	30

### Specifications

- Specify Black Or Matte Silver

## SPECIALTY VENEER ACCENTS *croch mahogany infield with mitered border*

Style Number	List Price
TCB-1 - 84 x 36/42	1975
TCB-2 - 72 x 36/42	1870
TCB-3 - 72 x 30/36	1765

### Specifications

- Center balanced butt and book matched croch mahogany
- 35 sheen non-rubbed finish ensures maximum durability

## SPECIALTY VENEER ACCENTS *croch mahogany desk pedestal fronts*

Style Number	List Price
FCC1	205 Per ped

### Specifications

- Center balanced butt and book matched croch mahogany
- 35 sheen non-rubbed finish ensures maximum durability

# Jamestown options.

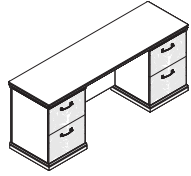

Box/Box/File or File/File  
Drawer Fronts



All Three Illustrations Represent: (1) FCC2



Both Illustrations  
Represent: FCC3



52" Center Balance Butt  
& Bookmatch

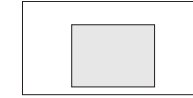

RECTANGLE INLAY

## SPECIALTY VENEER ACCENTS *crotch mahogany drawer fronts*

Style Number	List Price
FCC1	205 Per ped

### Specifications

- Center balanced butt and book matched crotch mahogany
- 35 sheen non-rubbed finish ensures maximum durability

## SPECIALTY VENEER ACCENTS *crotch mahogany double width panel fronts*

Style Number	List Price
FCC2	415 Per panel set

### Specifications

- Center balanced butt and book matched crotch mahogany
- 35 sheen non-rubbed finish ensures maximum durability

## SPECIALTY VENEER ACCENTS *crotch mahogany double width/ double height fronts*

Style Number	List Price
FCC3	935 Per panel set

### Specifications

- Center balanced butt and book matched crotch mahogany
- 35 sheen non-rubbed finish ensures maximum durability

## SPECIALTY VENEER ACCENTS *rectangle inlay - recesses dura-leather writing surface*

Style Number	List Price
RL-29A	935

### Specifications

- Recessed inlay desk pads are covered with Alomost Leather from Paul Brayton Designs.
- DARRAN will gladly custom quote other inlay materials ie: solid surfaces, biocomposites, metallic laminates, or genuine leather to match seating

## Jamestown options.

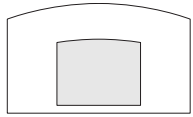

BOWFRONT INLAY

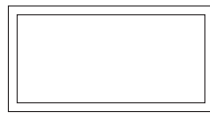

RECTANGLE INLAY

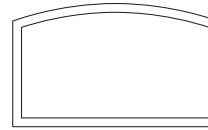

CURVED INLAY

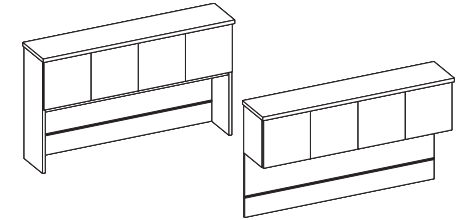

### SPECIALTY VENEER ACCENTS

*bowfront inlay - recesses dura-leather writing surface*

Style Number	List Price
RL-31A	1035

### Specifications

- Recessed inlay desk pads are covered with Alomost Leather from Paul Brayton Designs.
- DARRAN will gladly custom quote other inlay materials ie: solid surfaces, biocomposites, metallic laminates, or genuine leather to match seating

### SPECIALTY VENEER ACCENTS

*rectangle inlay - ebony hardwood inlay detail*

Style Number	List Price
T10SA	935

### Specifications

- 3/16" x 3/16" thick hardwood ebony inlay is handfitted and glued into routed top and sanded flush with surface
- Inlay is finished over with all finish steps

Notes  
- Ebony inlay not recommended in: Koko Cherry

### SPECIALTY VENEER ACCENTS

*bowfront inlay - ebony hardwood inlay detail*

Style Number	List Price
T11SA	1035

### Specifications

- 3/16" x 3/16" thick hardwood ebony inlay is handfitted and glued into routed top and sanded flush with surface
- Inlay is finished over with all finish steps

Notes  
- Ebony inlay not recommended in: Koko Cherry

### TOOL CHANNEL ACCESSORIES

*recessed aluminum tool channel*

Style Number	List Price
ATB02	5 per 1"W

### Specifications

- Anodized aluminum finish
- Fully recessed
- Finish matches anodized aluminum accessories
- Can be specified with fabric tack surface mounted above channel

Notes  
- If using tool channel with wallhung overhead, a veneer panel must be specified.

# Jamestown options.



TOOL CHANNEL ACCESSORIES  
*iphone holder*

Style Number	List Price
ATB31	125

## Specifications

- For Console/Wall Hung Back Panels With Optional Tool Bar
- 18 Gauge Steel - Stamp Formed
- Silver Powdercoat Finish
- 5" x 3 -3/4"W
- Non-slip Neoprene pad



TOOL CHANNEL ACCESSORIES  
*large shelf*

Style Number	List Price
ATB35	130

## Specifications

- 12"W x 10"D



TOOL CHANNEL ACCESSORIES  
*pencil pen holder*

Style Number	List Price
ATB38	120

## Specifications

- For Console/Wall Hung Back Panels With Optional Tool Bar
- 18 Gauge Steel - Stamp Formed
- Silver Powdercoat Finish
- 5"H x 4"W x 4"D



TOOL CHANNEL ACCESSORIES  
*tablet holder*

Style Number	List Price
ATB30	145

## Specifications

- For Console/Wall Hung Back Panels With Optional Tool Bar
- 18 Gauge Steel - Stamp Formed
- Silver Powdercoat Finish
- 10" x 8"W
- Non-slip Neoprene pad



## Jamestown options.

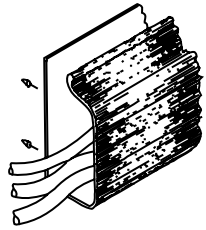

### WIRE MANAGEMENT *horizontal j-channel wire management raceway*

Style Number	List Price
W1	80 Per 4' section

### Specifications

- 4' section for field installation.
- The "J" shape black thermoplastic wire raceway may be added to specified worksurface tops to provide concealed channeling of wires to and from worksurface grommets. For use in open kneespace areas, raceway is attachable to top of back panel with pan head screws. Interior dimensions are 1" x 1- 1/2" providing ample storage for multiple wires and excess cable. Front of raceway flexes out for easy cord insertion.

#### Notes

- Units w/ Wire Channel Standard.
- Field Installation

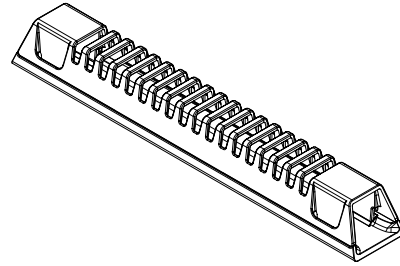

### WIRE MANAGEMENT *horizontal wire management raceway*

Style Number	List Price
W21	35

### Specifications

- 10"W x 1.5"D x 1.25"H
- Grey Wire Manager (10.5")
- Power and data cables can be discretely housed and managed with the W21 Gray Wire Manager. This can be mounted in any location to metal frame or underside of conference tables and runs cables through a 1" channel from power module to hollow steel legs. This keeps cables organized under the table top. Release clips make it simple to snap on and off the Wire Manager for easy organization and access after attached to the table

#### Notes

- Field installed

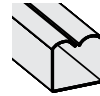

### WIRE MANAGEMENT *horizontal u-channel wire management raceway*

Style Number	List Price
W2A	80 Per 4' section

### Specifications

- 4' section for field installation.

#### Notes

- Units w/ Wire Channel Standard.
- Field Installation



### WIRE MANAGEMENT *coil wire manager*

Style Number	List Price
W18	160

### Specifications

- Weighted Base, Table attachment plate
- 39- 1/2" Length
- Black

#### Notes

- Location

# Jamestown options.

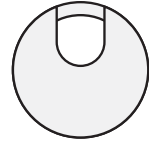
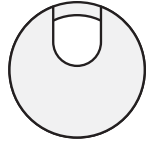

## WIRE MANAGEMENT

*standard location grommets - factory installed*

Style Number	List Price
Standard Location Grommet	
Black	
TM30	50
Silver	
TM31	50
Antique Brass	
TM33	50

## Specifications

- 1 -5/8" Metal Grommet

### Notes

- \*Units w/ Grommets Standard Are Noted Under Standard Features. Grommets Match Pull Finish - Standard (Unless Specified Otherwise)

## WIRE MANAGEMENT

*non-standard location grommets - factory installed*

Style Number	List Price
Non-Standard Location Grommet	
Black	
TM30 -NS	95
Silver	
TM31 -NS	95
Antique Brass	
TM33 -NS	95

## Specifications

- 1 -5/8" Metal Grommet

### Notes

- \*Units w/ Grommets Standard Are Noted Under Standard Features. Grommets Match Pull Finish - Standard (Unless Specified Otherwise)

## WIRE MANAGEMENT

*black plastic vertical surface grommets - factory installed*

Style Number	List Price
Standard Location Grommet	
TM50-C	50
Non-Standard Location Grommet	
TM50-NS	95

## Specifications

- 2 " Black Plastic Grommet

### Notes

- Standard Location is Bottom Center

## power & data options.

Aircharge wireless charging grommet

Style Number	List Price
 ACWG WIRELESS GROMMET	\$195

## Specifications

- › When used with GROVE Tables an additional \$350 LIST will apply for the special cutout required.
- › AirCharge offers a convenient way to charge any Qi compatible smartphone or device without the need to carry charging cables or find an available power outlet.
- › The Aircharge is powered by the latest Qi compliant IC offering reliable and efficient wireless charging in a convenient 3" grommet hub. Simply place your phone on the Aircharge and an LED will confirm pairing and begin wireless charging.
- › Recess: Efficient space conservation and quick access
- › Input: DC 5V (with included AC power adapter), DC 9V, 1.67A (with optional QC 2.0 power adapter)
- › Output: 5 watts Max. with DC 5V, 2A power adapter, 10 watts Max. with QC 2.0 power adapter
- › Qi V1.2 compliant IC
- › Charging distance: 6mm Max.

Available: All DARRAN collections



## power & data options.

Cove power unit - non-linking

Style Number	List Price
 PD-COVE PLUG	\$550
Non-linking version	

### Specifications

- › Size 5.75" L x 2.5" W
- › (2) 15 Amp Receptacles and (2) USB charging ports
- › Surface Mount
- › 108" Cord
- › Standard Silver Finish, Available in White or Black Finish upon request
- › ETL Listed

Available: All DARRAN collections



## power & data options.

Cove corded series

Style Number

List Price



PD-COVE-PKO

\$800

## Specifications

- › Size 9.5" L x 2.5" W x 3.18" D
- › When used with GROVE Tables an additional \$350 LIST will apply for the special cutout required.
- › (2) Power Receptacles, (2) 2.1 Amp USB charging ports and (1) Telecom Plate Knockout
- › Surface Mount
- › 108" Cord
- › Standard Silver Finish, Available in White or Black Finish upon request
- › ETL Listed

Available: All DARRAN collections

### Telecom Plates

RJ45 (1)	\$35
RJ45 (2)	\$70
RJ45 (3)	\$105
USB (1)	\$70
USB (2)	\$140
RJ11/RJ45	\$70
RJ45/USB	\$105
RJ45/HDMI	\$190
HDMI/DVI	\$325
HDMI/USB	\$205
HDMI/VGA	\$240
VGA/MINI-STEREO	\$155
VGA/USB	\$175

This pod can have up to 1 total plates.

\*All telecom connectors sold separately.



## power & data options.

Soba wire manager

Style Number	List Price
STARTER UNITS	
SCDW	\$200
White wire manager	
SCDB	\$200
Black wire manager	

## Specifications

- › Dimensions: 9ft x 9in x 3.15in
- › Zips up, bundles and routes loose, messy cables into a single tube
- › Routes and guides cables behind desks, TVs, and anywhere cables tend to get messy
- › Accommodates large or small cables, up to three cables at once
- › Support channels, used to route cables, include powerful adhesive backing which allows easy attachment to surfaces.

Available: All DARRAN collections



## power & data options.

VILLA Power unit - non-linking

Style Number	List Price
 VIL-C PLUG	\$515
Non-Linking	

### Specifications

- › Size: Top Grommet 5.68" L X 3.39"W; Under Top 12"L x 3.13"W x 3.08"D
- › (2) Power receptacles; (2) USB charging ports and (1) Knockouts for RJ45 Data Ports
- › Surface Mount
- › 72" Cord (Longer cord available, contact Customer Service)
- › Standard Silver Finish, Black Finish available upon request
- › UL or ETL Certified

Available: All DARRAN collections, excludes Grove

RJ45 Knockout	
RJ45 (1)	\$35

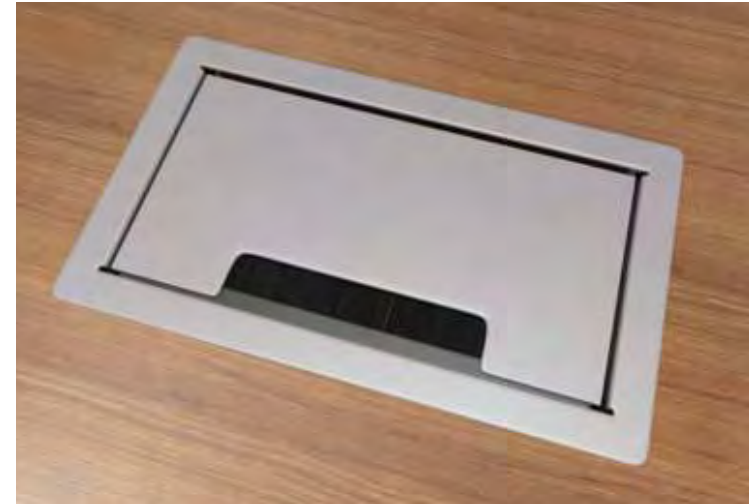

# Not so square office price list





## Not so square table of contents

Statement of Line	
Features & Advantages .....	1
Finishes   Specifications .....	3
Edges   Pulls .....	4
Grommets   Grommet Reference .....	5
Ganging   Height Reference .....	6
Metal Legs .....	8
Modesty Reference   Grain Direction .....	9
Drawer Dimensions   FILING Reference .....	10
Double Pedestal Desk .....	11
Table Desk .....	12
Freestanding Desks .....	13
Single Pedestal Desk .....	14
Conference Desk .....	15
Runoff Desk .....	17
Returns .....	18
Bridges .....	21
Freestanding Credenzas .....	22
Workstation Credenzas .....	23
Bench Cabinets .....	30
Pedestals .....	31
Single Height Freestanding Overheads .....	32
Double Height Freestanding Overheads .....	35
Overhead Accessories .....	37
Single Height Wall Hung Overheads .....	41
Double Height Wall Hung Overheads .....	44
Wall Hung Accessories .....	47
Wall Hung Overheads .....	52
Overhead Bookcases .....	54
Vertical Half Towers .....	55
Vertical Full Towers .....	58
Bookcases .....	60
Options .....	61
Power & Data .....	74

# Not so square statement of line

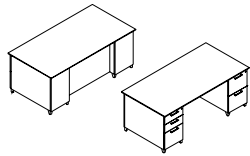

PAGE 11  
Freestanding Desks

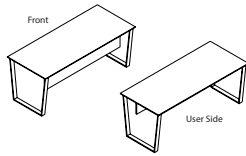

PAGE 12  
Freestanding Desks

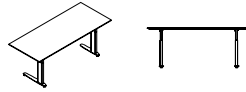

PAGE 13  
Freestanding Desks

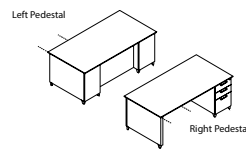

PAGE 14  
Freestanding Workstation Desks

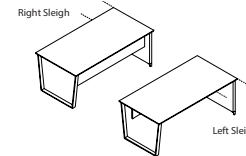

PAGE 15  
Conference Workstation Desks

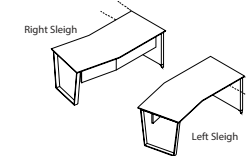

PAGE 16  
Conference Workstation Desks

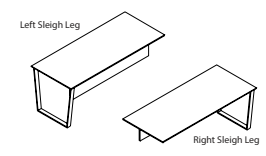

PAGE 17  
Runoff Conference Workstation Desks

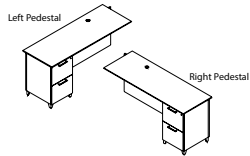

PAGE 18  
"L" Workstation Returns

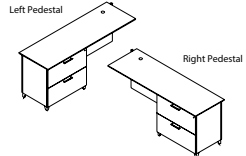

PAGE 19  
"L" Workstation Returns

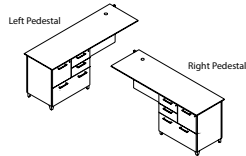

PAGE 20  
"L" Workstation Returns

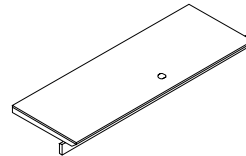

PAGE 21  
Workstation Bridges

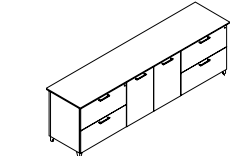

PAGE 22  
Freestanding Lateral File Credenzas

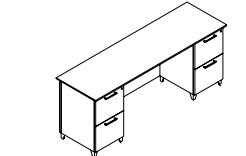

PAGE 23  
File Credenzas

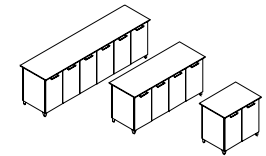

PAGE 24  
Freestanding Storage Credenzas

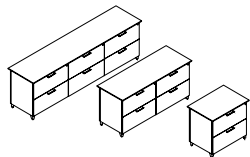

PAGE 25  
Freestanding Lateral File Credenzas

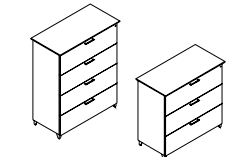

PAGE 26  
Freestanding Lateral File Credenzas

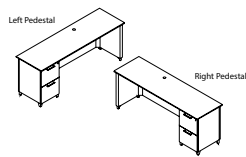

PAGE 27  
Workstation Credenzas

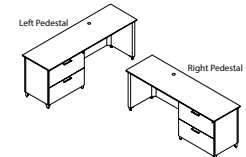

PAGE 28  
Workstation Credenzas

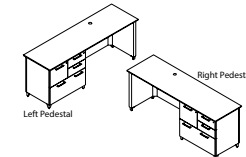

PAGE 29  
Workstation Credenzas

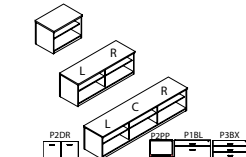

PAGE 30  
Bench Cabinets

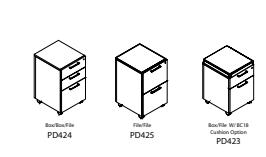

PAGE 31  
Freestanding Mobile Pedestal

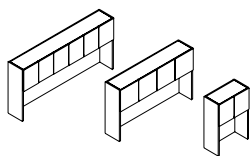

PAGE 32  
Single Storage Overhead Consoles

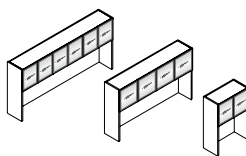

PAGE 33  
Single Storage Overhead Consoles

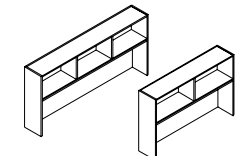

PAGE 34  
Single Storage Overhead Consoles

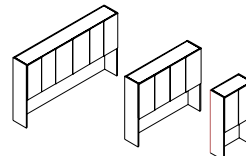

PAGE 35  
Double Height Overhead Consoles

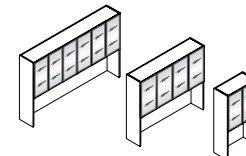

PAGE 36  
Double Height Overhead Consoles

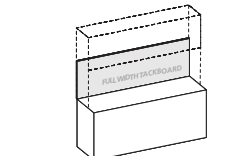

PAGE 37  
Overhead Tackboards

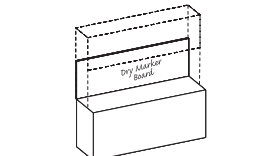

PAGE 38  
Overhead Dry Marker Boards

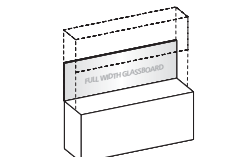

PAGE 39  
Overhead Glassboards

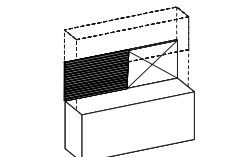

PAGE 40  
Overhead Slat Wall

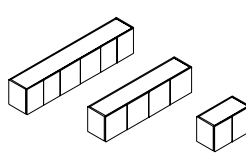

PAGE 41  
Single Height Wall Hung Overheads

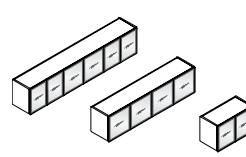

PAGE 42  
Single Height Wall Hung Overheads

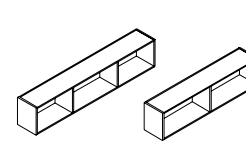

PAGE 43  
Single Height Wall Hung Overheads

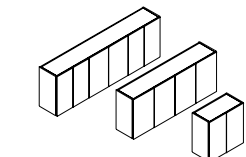

PAGE 44  
Double Height Wall Hung Overheads

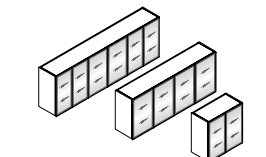

PAGE 45  
Double Height Wall Hung Overheads

# Not so square statement of line

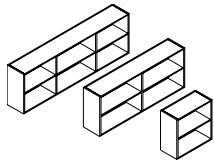

PAGE 46  
Double Height Wall Hung Overheads

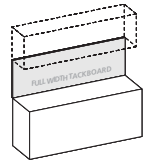

PAGE 47  
Wall Hung Tackboards

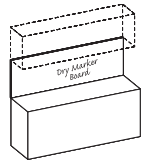

PAGE 48  
Wall Hung Dry Marker Boards

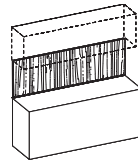

PAGE 49  
Wall Hung Veneer Panels

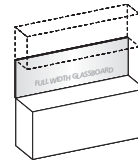

PAGE 50  
Wall Hung Glassboards

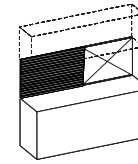

PAGE 51  
Wall Hung Slat Wall

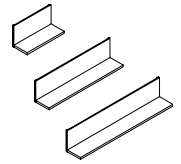

PAGE 52  
Single Height Wall Hung Overheads

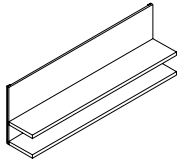

PAGE 53  
Double Height Wall Hung Overheads

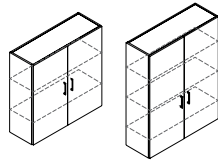

PAGE 54  
Overhead Bookcases

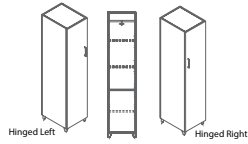

PAGE 55  
Freestanding Half Towers

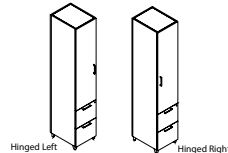

PAGE 56  
Freestanding Half Towers

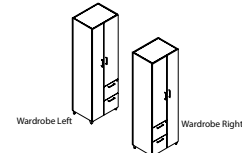

PAGE 57  
Freestanding Towers

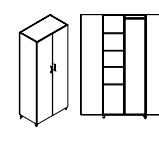

PAGE 58  
Freestanding Towers

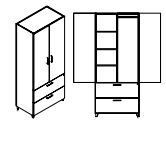

PAGE 59  
Freestanding Towers

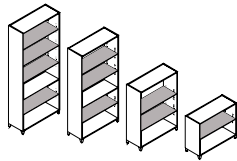

PAGE 60  
Open Bookcases

## Not so square features & advantages

### Veneer

DARRAN only uses HPVA AA Grade Flat Cut Cherry, Maple, and Walnut Veneers and AA Grade Quartered Oak Veneers. Not SO square is also available in double cut reconstituted walnut and oak patterns made from rapidly renewable wood veneer providing a repeatable consistent straight grain pattern. All veneers are selected and matched for balance and consistency.

### Veneer Tops

Not SO square veneer tops feature a 45-pound density substrate with balanced 3-ply construction. Tops are 1-5/16" thick on MDF core comprised of 100% recycled and recovered wood fibers. All veneer tops are slipmatched and feature a 3mm external solid hardwood band or profile edge.

### Laminate Tops

Not SO square high-pressure laminate tops feature a 45-pound density substrate with balanced 3-ply construction. Tops are 1-5/16" thick on MDF core comprised of 100% recycled and recovered wood fibers. All high pressure laminate tops are available with a profile edge, laminate self-edge or 2mm PVC edge band. Laminates in wood grain patterns feature a fine grain texture that features the polish and luxe of a real wood veneer with a subtle narrow grain structure.

### TFL tops

Thermally Fused Laminate tops feature a 45-pound density substrate with balanced 3-ply construction. Tops are 1-1/8" thick on MDF core that is comprised of 100% recycled and recovered wood fibers. All Thermally Fused Laminate tops are available with a 2mm flat PVC band. Laminates in wood grain patterns feature Timberline Texture providing the grain pattern of wood.

### Cleaning wood & laminate

In addition to regular dusting, give your furniture an occasional cleaning in accordance with our cleaning instructions. DARRAN wood and laminate products can be cleaned with a soft cloth and a mild soap and water mixture. Use approximately 32 oz of water mixed with one tablespoon of dish soap, always wiping with the grain. Dry with a soft cloth, going with the grain, to avoid spotting or streaking.

Wood products should be waxed periodically using a non-wax liquid; please do not use any waxy polish or cleaner. Interior of drawers may also be cleaned with mild soap and water mixture, or any household cleaner that is not petroleum or thinner-based.

### Chassis & pedestal

Chassis components are 3/4" thick core of particle board or MDF rated EPP/SCS/CARB-II material with 3-ply balanced construction. Pedestal and Cabinets feature dowel construction reinforced with steel bracket plates, wood cleats, screws and glue.

All units are standard with 1" adjustable glides that allow for leveling of units that are secured in solid wood glide blocks to prevent tearout.

### Overhead cabinet construction

#### Freestanding & wall mount

Freestanding Overhead storage cabinets are constructed of 1" and 3/4" thick core of particle board or MDF rated EPP/SCS/CARB-II material with 3-ply balanced construction. Panels are attached with cam fasteners in conjunction with dowels securely adhered with PVAc glue. All surface mount cabinets connect to work surface with anti-slip tape. Wall mount cabinets are mounted to the wall with steel "z" bracket attachment method using 5mm euro screws to attach to the back of the cabinet. All units ship with a steel "z" bracket. This bracket is mounted to the wall by field installers. Installers are responsible for selecting and supplying appropriate fasteners for wall conditions.

### Bookcase Construction

All chassis (sides, back, top and bottom panels) are constructed with 3/4" thick core of particle board or MDF rated EPP/SCS/CARB-II material with 3-ply balanced construction. Panels are attached with cam-lock fasteners in conjunction with dowels securely adhered with glue. Shelves on all units are 3/4" thick balance 3 ply panels. Optional heavy duty shelves are 1" thick lumber core balanced 5 ply construction.

### Tackboards

Wall mount tackboards are constructed of .75" thick fiberboard. The fabric is precisely aligned and fitted to the tackboard with a sock on cover. Overhead storage tackboards are constructed of .75" thick fiberboard. The fabric is precisely aligned and fitted to the tackboard and adhered to the rigid hardboard with staples. Wall mount cabinets are mounted to the wall with steel "z" bracket attachment method using 5mm euro screws to attach to the back of the cabinet. All units ship with a steel "z" bracket. This bracket is mounted to the wall by field installers. Installers are responsible for selecting and supplying appropriate fasteners for wall conditions.

### Adjustable glides

Glides provide 1" of vertical leveling adjustment. Glide bottom is durable metal. Glides are secured in solid wood blocks that are screwed and glued for durability.

### Drawers

All drawers are constructed with mitre joint/dowel construction in a natural maple finish with four sides and a bottom, which are attached to a drawer front with screws for easy removal. Drawer fronts are vertically matched in balanced sets. Pencil trays are standard in all box drawers. Drawers are constructed of 1/2" thick wood grained wrapped 5 sided miter-folded construction with 1/4" thick hardboard bottoms reinforced for heavy weight capacity. Drawers have been tested and pass BIFMA 50,000

## Not so square features & advantages

cycle test. All drawers are guaranteed lifetime with free replacement warranty.

### Optional wood drawers

Optional hardwood veneer plywood drawers feature banded top and bottom edges for smoothness. Drawers are dowel joint construction with a UV cured finish over maple veneers, plus a lifetime free replacement guarantee.

Optional Wood Drawer (Any Size) – Option Code P33...\$45 List Price Per Drawer

### Drawer fronts

Drawer fronts are vertically matched in balanced sets. Doors feature vertical veneer bookmatched horizontally in sets of 2 / 4 and 6 doors. All drawers and doors have traditional scallop profile edge shape. All tower fronts matched in vertical sets.

### Suspensions

All casegoods utilize cold rolled steel zinc plated high-grade drawer suspensions. All suspensions are warranted for the lifetime of the product. Box and File drawers are full extension, featuring steel ball bearings for a smoother quieter range of motion and are rated 100lbs. Lateral file drawers are a progressive action full extension suspension and is rated at 150lbs. Veneer and High Pressure laminate casegoods feature soft close suspension. Thermally Fused Laminate casegoods feature standard suspensions. Lateral files include anti tip mechanism that allow only one drawer to be opened at a time.

### Hinges

Units with doors include 95 degree swing hinges.

### Filing

Not SO square features a highly durable black plastic extrusion that is securely fastened into a route on top of the drawer to support hanging files. An adjustable crossbar is provided for all file drawers that enables legal/letter filing front to back or side-to-side based on the drawer size..

Jamestown, Prado, and Rift feature metal file frames around the perimeter of the drawers with cross bars secured to the drawer sides to support hanging files. A metal adjustable cross bar is standard with all file drawers to support letter/legal filing front to back or side to side. File drawers have one adjustable cross bar and lateral files have two adjustable cross bars. See filing reference for details.

### Locks

Locks are Standard on all drawers below the worksurface. Random lock cores are installed at the factory. Some units may be shipped with the same key number. Locks are Silver, Black or Bronze and match pull finish unless otherwise specified.

DARRAN will also send lock cores separately to the dealer at your request. These units will be send with an empty lock core and the Dealer will receive a shipment of the requested lock core/keys.

### Keying

Keying is available either factory or field installed. Factory installed keying is random.

### Wire management

Wire management capabilities include standard and optional worksurface grommets. Specify W-1 under surface wire channels for organization and management of all communication wires and cords. Horizontal J-Channel wire management (Sku: W-1) is sold separately to conceal wire under worksurfaces.

### Grommets

Metal grommets are provided to match the drawer pull selection. Grommet is available in black, silver or white. Must specify standard or non-standard location. Black plastic grommets are available as an option for vertical applications.

### Powerports

A large selection of power pods are available and handle power, data, docking stations and communication. See options section for selection.

### LED tasklights

LED task lighting provides high efficiency, low energy lighting with a long life. Recessed light is encased in silver aluminum channel with milk lense and rounded end caps. Lights are factory installed. Product specifications listed below:

- Diffuser creates a softer light and eliminates hot spots
- Touch dimmer switch
- Can be "daisy chained" up to 90W
- 4.6 watts per foot
- 120 LEDs per meter
- Certification: UL Listed
- 50,000 hour life span.

Color Temp is 4000K

## Not so square finishes | specifications

STANDARD VENEER	PREMIUM VENEER	HIGH PRESSURE LAMINATE	THERMALLY FUSED LAMINATE
WAC Amber Cherry.....	N/A.....	GAC Amber Cherry.....	MAC Amber Cherry
WRC Caramel Cherry.....	N/A.....	N/A.....	N/A
WIC Crimson Cherry.....	N/A.....	GIC Crimson Cherry.....	N/A
WEC Ebony on Cherry.....	N/A.....	GEC Ebony.....	MEC Ebony
WHC Honey Cherry.....	N/A.....	GHC Honey Cherry.....	MHC Honey Cherry
WOC KoKo Cherry.....	N/A.....	GOC KoKo Cherry.....	MOC KoKo Cherry
WAM Alabaster Maple.....	N/A.....	GAM Alabaster Maple.....	N/A
WCM Clear Maple.....	N/A.....	GCM Clear Maple.....	N/A
WWM Wheat Maple.....	N/A.....	GWM Wheat Maple.....	N/A
WEW Executive Walnut.....	N/A.....	GEW Executive Walnut.....	N/A
WGW Gunstock Walnut.....	N/A.....	N/A.....	MGW Gunstock Walnut
WBW Henna Walnut.....	N/A.....	N/A.....	N/A
WSW Smokey Walnut.....	N/A.....	N/A.....	N/A
WNW Natural Walnut.....	N/A.....	GNW Natural Walnut.....	N/A
N/A.....	WBO Blush Oak.....	N/A.....	N/A
N/A.....	WMO Mocha Oak.....	N/A.....	N/A
N/A.....	WSO Salted Oak.....	N/A.....	N/A
N/A.....	TBCO Baby's Cheek.....	N/A.....	N/A
N/A.....	TBSW Brown Sugar.....	N/A.....	N/A
N/A.....	TSTV Studio Teak Walnut.....	GSTV Studio Teak Walnut +10%.....	MTW Studio Teak Walnut
N/A.....	TSMV Seattle Mist Walnut.....	N/A.....	N/A
N/A.....	TSLV Skyline Walnut.....	GSLV Skyline Walnut +10%.....	MSW Skyline Walnut
WWP Designer White Paint.....	N/A.....	GWL Designer White.....	MWL Designer White

HPL TOPS ON TFL PRODUCTS Add 10% - Available with flat edge only

Send 3x3 or larger finish chip for color match. Custom finish upcharge is 3% or \$250 Net (whichever is greater).

### Finish

ENVI-CT Green Certified European Technology Coatings

Finish.

# Not so square edges

## Standard profile NSS Edge

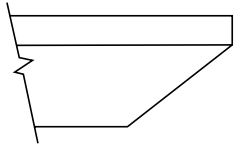

**NSS Bevel**  
"W" 3mm Solid Hardwood Band  
"G" HPL Self Edge



**NSS Bevel**  
"M" 2mm PVC Edge with Black Foil



## PVC Edgeband

NSS Bevel edge overhang profile is standard on all exposed undersurface edges and black bevel to provide a floating appearance.

## Finger pulls (optional)

Arrow indicates finger pull location

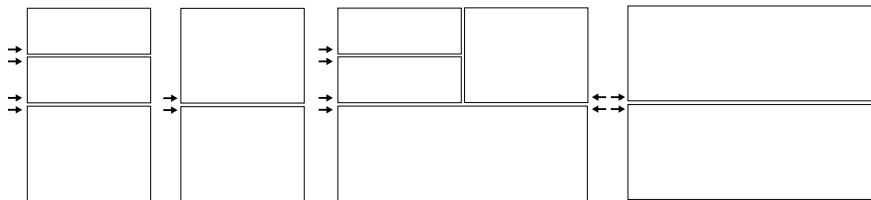

b/b/f

f/f

multi

lateral/lateral

## Pulls/knobs Factory Installed

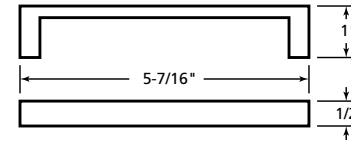

PL-115 Matte Black  
PL-116 Matte Nickel

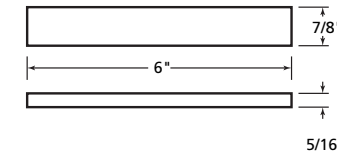

PL-210 Anodized Aluminum

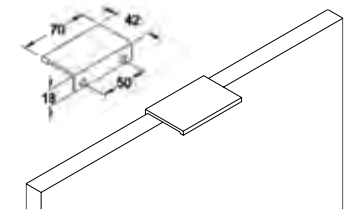

PL-260 Anodized Aluminum  
PL-261 White  
(Drawers Only)



Finger Pull

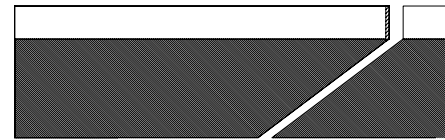

## Bridge/return hookup edge

Hookup tops feature reverse cope shaping for custom flush surface appearance and improved use.

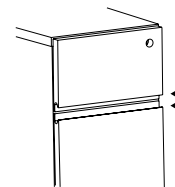

finger pull side view

Not so square grommets | grommet reference

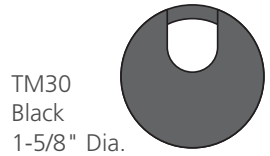

TM30  
Black  
1-5/8" Dia.

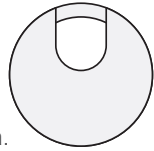

TM31  
Silver  
1-5/8" Dia.

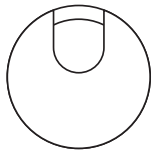

TM34  
White  
1-5/8" Dia.

Optional grommets

Factory Installed

Grommets (Standard Location)

Specify Color and Left/Right/Center - \$50 ea.

- Black: TM30-R (Right), TM30-L (Left), TM30-C (Center)

- Silver: TM31-R (Right), TM31-L (Left), TM31-C (Center)

- White: TM34-R (Right), TM34-L (Left), TM34-C (Center)

Grommets (Non-Standard Location)

Provide drawing w/ Grommet Location and Specify Color - \$95 ea.

- Black: TM30-NS

- Silver: TM31-NS

- White: TM34-NS

TM50  
Black  
1-5/8" Dia.



Grommets (vertical surface)

Standard Location - \$50 ea.

- Black Plastic Vertical Surface: TM50-C (Bottom Center)

Non-Standard Location - \$95 ea.

- Black Plastic Vertical Surface: TM50-NS

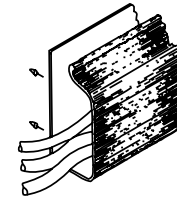

Horizontal J-channel

Horizontal J-Channel wire management (Sku: W-1) is sold separately to conceal wire under worksurfaces.

W1

Standard grommet location reference



Desk  
Specify Right or Left Grommet

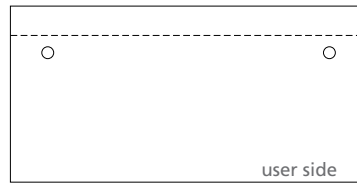

6" Overhang Desk  
Specify Right or Left Grommet

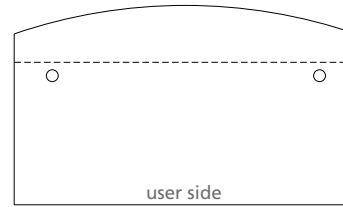

6"/12" Bow Front Desk  
Specify Right or Left Grommet



Bullet Conference Desk (Right Post)  
Center Grommet

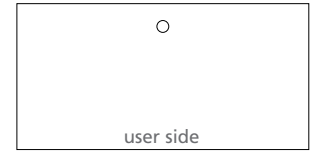

Bridge  
Center Grommet

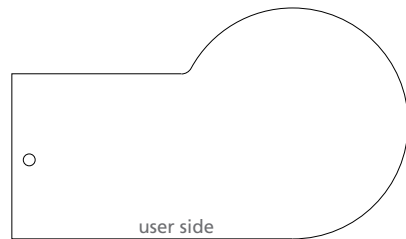

P Conference Desk (Right Post)  
Center Grommet

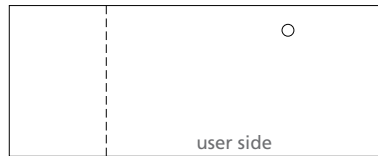

Return (Left Pedestal Shown)  
Right Pedestal - Left Grommet  
Left Pedestal - Right Grommet



Workstation Credenza  
Center Kneespace Grommet



## Not so square ganging | height reference

### Ganging – flush cut modification

30" H Casegood Worksurface & Base Ganging Modifications

To gang two casegood units, each unit end to be ganged must be flush cut modified for gapless surfaces and cabinet chassis.

Order Option:

- FC-B: Flush Unit Both Sides(Facing) for Ganging - \$100
- FC-L: Flush Unit Left (Facing) for Ganging - \$100
- FC-R: Flush Unit Right (Facing) for Ganging - \$100

Flush cut modification per unit includes all modifications to gang to one end or both ends when units are ganged. Modification includes tops, base and molding. Modification reduces width size approximately 1" per end.

Example:

NSS3121100W Two Drawer Lateral File (Left) Flush Cut Right – FC-R...\$100

NSS7221054 Kneespace Credenza (Right) Flush Cut Left – FC-L...\$100

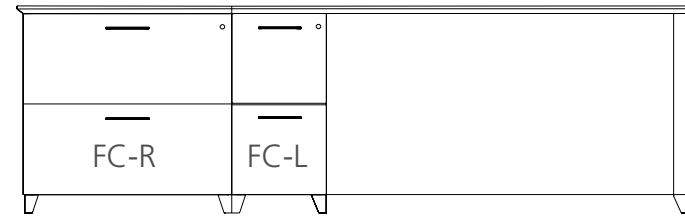

## Height reference

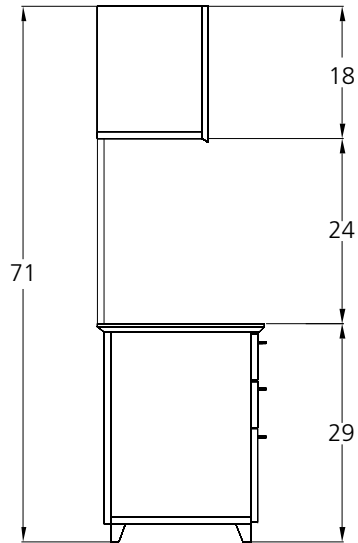

Typical Single Height Side Profile Wall Hung Overhead

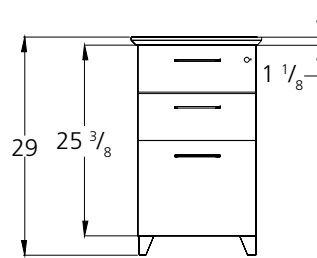

Pedestal Front Profile Box/Box/File

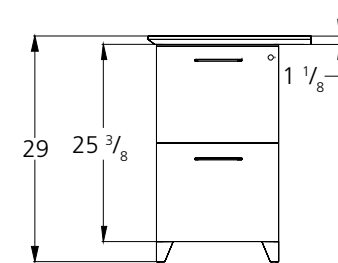

Pedestal Front Profile File/File

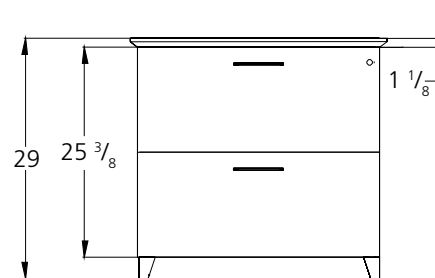

Pedestal Front Profile Lateral File

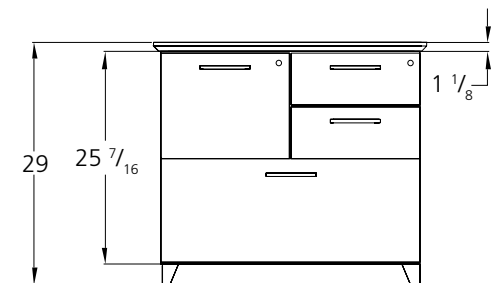

Pedestal Front Profile Multi-File

## Not so square ganging

### Credenzas, overheads and towers

Towers and overheads are standard flat top for easy ganging. No modification needed.

Credenza must be specified for flush cut ends when ganging to towers.

Credenza width matches overhead width when both credenza ends are flush cut.

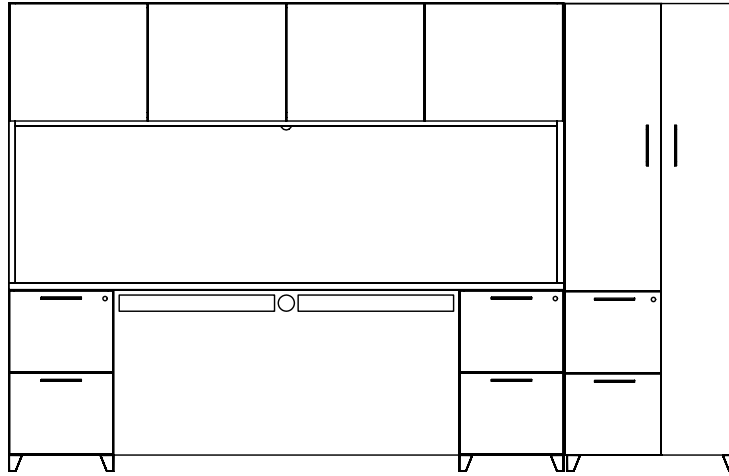

Order Option Number: FCG2 Flush Cut Modification . . . \$55 Per Unit.  
A drawing must be submitted to specify if one or both sides are to be flush cut.

# Not so square metal leg

CABINET ANGULAR FOOT  
Cast Angular Foot

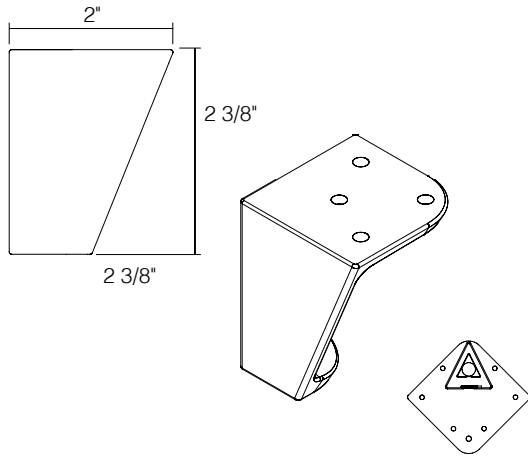

DESK ANGULAR POST

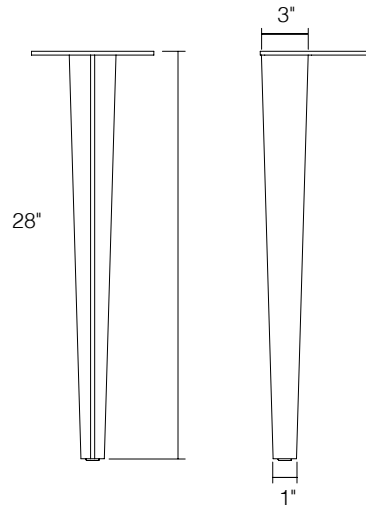

DESK ANGULAR SLEIGH BASE

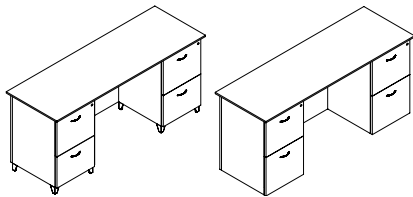
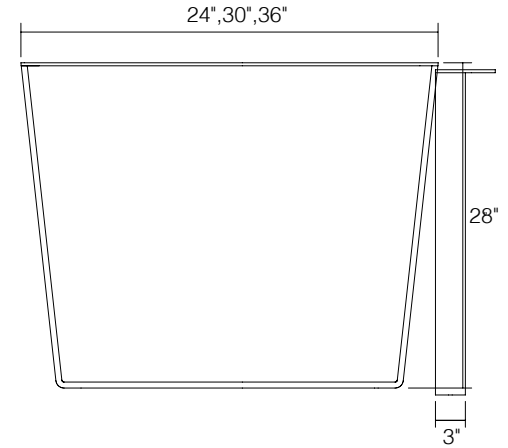

Option: Delete Feet/Extended Fronts

Standard metal feet can be deleted on any unit. Delete foot option extends chassis cabinets to floor. Drawer/Door fronts are extended to within 3/8" of full cabinet height when delete foot option is specified.

Delete Foot Chassis Modification Option:  
D8. . .deduct \$50

## Not so square modesty reference | grain direction

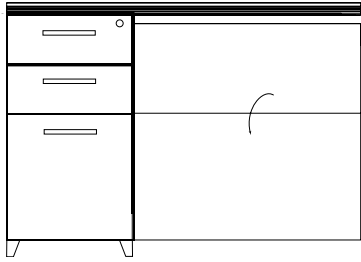

**M34**  
Drop Door Tech Modesty

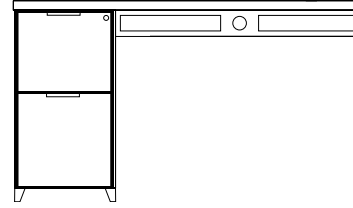

**M51**  
Open Back Modesty with 4"  
Wire Management Rail

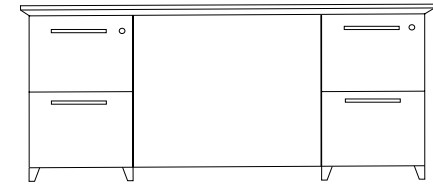

**M37**  
Fixed Full Modesty

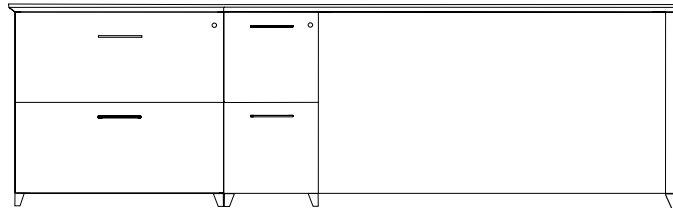

## Grain direction

Veneer chassis parts are vertical grain. The backs of Thermally Fused Laminate overheads, wall hungs, wall hung shelves and flush chassis desks are horizontal grain. Bridges, returns, and credenza kneespace Thermally Fused Laminate backs over 60" are horizontal grain. Doors feature vertical veneer bookmatched horizontally in sets of 2, 4, and 6 doors. Tower fronts are matched in vertical sets.

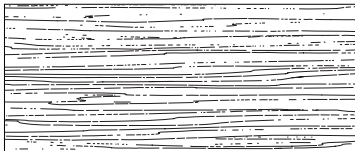

Desk

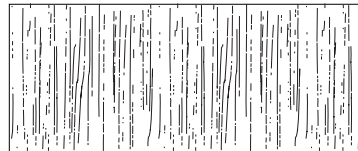

Runoff Desk  
Grain Direction on TFL Units  
Above 60" runs end to end

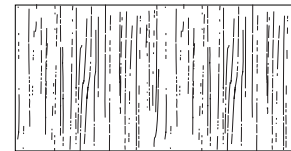

Bridge  
Grain Direction on TFL Units  
Above 60" runs end to end



Credenza

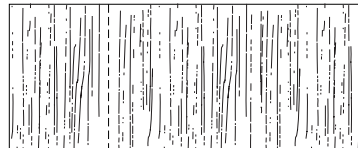

Return  
Grain Direction on TFL Units  
Above 60" runs end to end

# Not so square drawer dimensions | filing reference

## Interior drawer dimensions

UNIT DEPTH	DRAWER TYPE	OVERALL DIMENSIONS			INTERIOR DRAWER DIMENSIONS			NOTES
		W	D	H	W	D	H	
15-5/8" Letter	36" Box	13-1/8	19-11/16	4	12-1/8	18-11/16	3-7/16	Units less than 72"
	36" File	13-1/8	19-11/16	9-13/16	12-1/8	18-11/16	9-5/16	Units less than 72"
	30" Box	13-1/8	19-11/16	4	12-1/8	18-11/16	3-7/16	Units less than 72"
	30" File	13-1/8	19-11/16	9-13/16	12-1/8	18-11/16	9-5/16	Units less than 72"
	24" Box	13-1/8	16-1/16	4	12-1/8	15-1/16	3-7/16	Units less than 72"
	24" File	13-1/8	16-1/16	9-13/16	12-1/8	15-1/16	9-5/16	Units less than 72"
29" Lateral	24" Box	26-1/2	16-1/16	4	25-1/2	15-1/16	3-7/16	Workstation Credenzas less than 82"
	24" File	26-1/2	16-1/16	9-13/16	25-1/2	15-1/16	9-5/16	Workstation Credenzas less than 82"
31" Lateral	24" File	28-9/16	16-1/16	9-13/16	27-9/16	15-1/16	9-5/16	Multi-File Lateral File
35" Lateral	24" Box	32-1/2	16-1/16	4	31-1/2	15-1/16	3-7/16	Workstation Credenzas over 83"
	24" File	32-1/2	16-1/16	9-13/16	31-1/2	15-1/16	9-5/16	Workstation Credenzas over 83"
41" Lateral	24" File	38-1/2	16-1/16	9-13/16	37-1/2	15-1/16	9-5/16	Wood Drawer Only

### Filing for 24" Depth Units

13" Wide File Drawer - 16" Deep

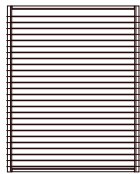

Letter Front to Back

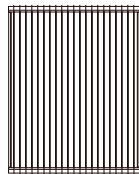

Legal Side to Side with File Rail

### 29" Lateral File Drawer

26-1/2" Wide File Drawer - 16-1/16" Deep

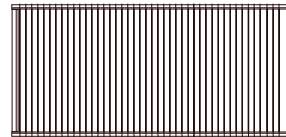

Legal Side to Side

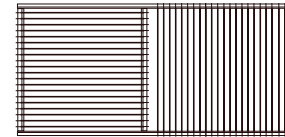

Legal Side to Side Letter Front to Back with File Rail

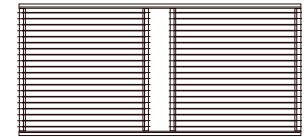

Letter Front to Back with File Rail

### Filing for 30" & 36" Depth Units

13" Wide File Drawer - 20" Deep

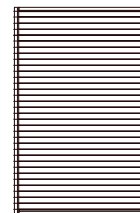

Letter Front to Back

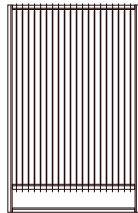

Legal Side to Side with File Rail

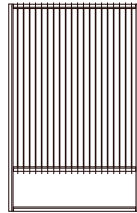

Letter Side to Side with File Rail

### 35" Lateral File Drawer

32-1/2" Wide File Drawer - 16-1/16" Deep

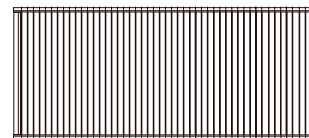

Legal Side to Side

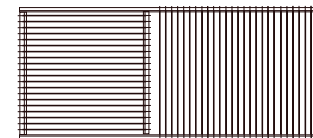

Legal Side to Side Letter Front to Back with File Rail

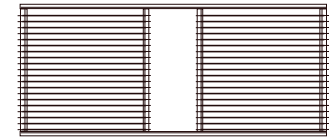

Letter Front to Back with File Rail

# NOT SO square office.

Freestanding Desks

Breakfront - Full Pedestal With Modesty Panel

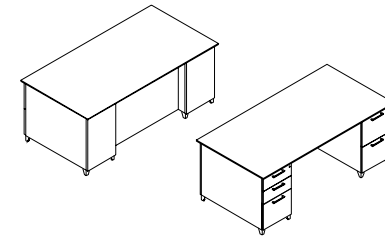

[View statement of line](#)

1 Select a model w" x d" x h"	weight	Standard Veneer Top		Premium Veneer Top		High Pressure Laminate Top		Thermally Fused Laminate Top	
		Standard Veneer Chassis		Premium Veneer Chassis		Veneer Chassis		Thermally Fused Laminate Chassis	
84 x 36 x 29	350	NSS8436DD000W	4096	NSS8436DD000P	4506	NSS8436DD000G	4096	NSS8436DD000M	2771
72 x 36 x 29	315	NSS7236DD000W	3807	NSS7236DD000P	4188	NSS7236DD000G	3807	NSS7236DD000M	2672
72 x 30 x 29	295	NSS7230DD000W	3633	NSS7230DD000P	3997	NSS7230DD000G	3633	NSS7230DD000M	2636
66 x 30 x 29	270	NSS6630DD000W	3599	NSS6630DD000P	3959	NSS6630DD000G	3599	NSS6630DD000M	2578

2 Select a finish  
[View finish details](#)

Metal finish  
MFS Silver. Additional metal finishes are available, see options.

- WAC WGW
- WRC WBW
- WIC WSW
- WEC WNW
- WHC WWP
- WOC
- WAM
- WCM
- WWW
- WEW

3 Select an edge  
[View edge details](#)



- TBCO
- TBSW
- TSTV
- TSMV
- TSLV
- TOBW
- WBO
- WMO
- WSO



- GAC GNW
- GIC GSTV +10%
- GEC GSLV +10%
- GHC GWL
- GOC
- GAM
- GCM
- GWM
- GEW



- MAC
- MEC
- MHC
- MOC
- MGW
- MTW
- MSW
- MWL



4 Select hardware  
[View hardware details](#)

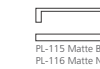
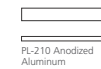
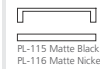
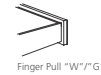
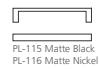
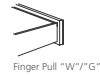
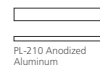
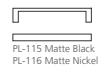

## Product features.

- 6" recessed modesty
- Breakfront modesty
- Locking drawers
- Soft close suspension drawer(s)
- Standard Silver Feet (optional White, Black)

## Options.

### ACCESSORIES

- K28: Articulating Keyboard w/ Mouse - \$390
- K31: Center Drawer w/out Pull - \$205

### CHASSIS

- MODCX: Modify breakfront chassis to flush front chassis - n/c

### DRAWER

- P6: Modify File/File to Box/Box/File - \$55 per pedestal
- P33: Wood Drawer Upgrade - \$45 per drawer
- WPD3061: Designer White - \$80 per pedestal

### FEET

- D8: Delete feet (extend fronts to floor) - n/c

### GROMMETS (STANDARD LOCATION)

Specify Color and Location Right/Left - \$50 ea.

- Black: TM30-R (Right), TM30-L (Left)
- Silver: TM31-R (Right), TM31-L (Left)
- White: TM34-R (Right), TM34-L (Left)

Grommets (Non-Standard Location)

Provide drawing w/ Grommet Location and Specify Color - \$95 ea.

- Black: TM30-NS
- Silver: TM31-NS
- White: TM34-NS

Modesty

- HM51: Half Modesty - \$205
- HM39: SilverLuma frame/frost (Half Modesty) - \$340

Premium Finish Option

- Specify foot metal finish color - \$130 per unit. Contact customer service
- MFB: Black, MFW: White

# NOT SO square office.

Freestanding Desks  
Table Desk With Sleigh Base

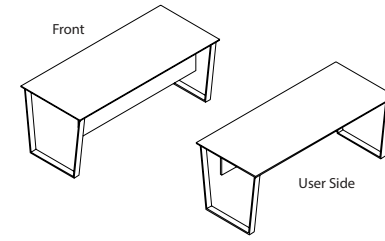

## 1 Select a model

w" x d" x h"

weight	Standard Veneer Top		Premium Veneer Top		High Pressure Laminate Top		Thermally Fused Laminate Top	
	Standard Veneer Chassis		Premium Veneer Chassis		Veneer Chassis		Thermally Fused Laminate Chassis	
72 x 36 x 29	150	NSS7236DT107W 3543	NSS7236DT107P 3898	NSS7236DT107G 3543	NSS7236DT107M 2117			
72 x 30 x 29	135	NSS7230DT107W 3391	NSS7230DT107P 3731	NSS7230DT107G 3391	NSS7230DT107M 2046			
66 x 30 x 29	125	NSS6630DT107W 3347	NSS6630DT107P 3682	NSS6630DT107G 3347	NSS6630DT107M 1971			

[View statement of line](#)

## 2 Select a finish

[View finish details](#)

**Metal finish**  
MFS Silver. Additional metal finishes are available, see options.

WAC	WGW
WRC	WBW
WIC	WSW
WEC	WNW
WHC	WWP
WOC	
WAM	
WCM	
WWW	
WEW	

TBCO
TBSW
TSTV
TSMV
TSLV
TOBW
WBO
WMO
WSO

GAC	GNW
GIC	GSTV +10%
GEC	GSLV +10%
GHC	GWL
GOC	
GAM	
GCM	
GWM	
GEW	

MAC
MEC
MHC
MOC
MGW
MTW
MSW
MWL

## 3 Select a edge

[View edge details](#)



## 4 Select hardware

[View hardware details](#)

Hardware
N/A

Hardware
N/A

Hardware
N/A

Hardware
N/A

## Product features.

- Half modesty panel standard
- Freestanding use
- Standard table desk sleigh base is silver metal finish (optional white or black)

## Options.

### ACCESSORIES

- K28: Articulating Keyboard w/ Mouse - \$390
- K31: Center Drawer w/out Pull - \$205
- W17: Wire Mgmt. Cover matches leg finish - \$80

### GROMMETS (STANDARD LOCATION)

- Specify Color and Location Right/Left - \$50 ea.
- Black: TM30-R (Right), TM30-L (Left)
  - Silver: TM31-R (Right), TM31-L (Left)
  - White: TM34-R (Right), TM34-L (Left)

### GROMMETS (NON-STANDARD LOCATION)

- Provide drawing w/ Grommet Location and Specify Color - \$95 ea.
- Black: TM30-NS
  - Silver: TM31-NS
  - White: TM34-NS





### PREMIUM FINISH OPTION

- Specify foot metal finish color - \$160 per unit. Contact customer service
- MFB: Black, MFW: White

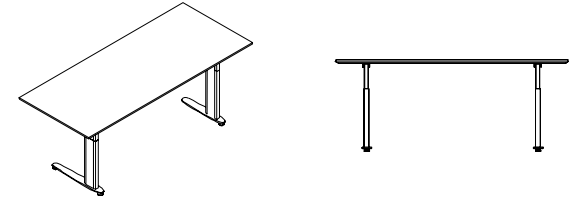
# NOT SO square office.

Freestanding Desks  
Adjustable Desk / Motorized



1 Select a model w" x d" x h"	weight	Standard Veneer Top Standard Veneer Chassis		Premium Veneer Top Premium Veneer Chassis		High Pressure Laminate Top Veneer Chassis		Thermally Fused Laminate Top Thermally Fused Laminate Chassis	
		72 x 30 x 29-48	230	NSS7230DT090W	3700	NSS7230DT090P	4070	NSS7230DT090G	3700
66 x 30 x 29-48	215	NSS6630DT090W	3678	NSS6630DT090P	4046	NSS6630DT090G	3678	NSS6630DT090M	2419
60 x 30 x 29-48	200	NSS6030DT090W	3656	NSS6030DT090P	4022	NSS6030DT090G	3656	NSS6030DT090M	2357
2 Select a finish <i>View finish details</i>		WAC	WGW	TBCO		GAC	GNW	MAC	
		WRC	WBW	TBSW		GIC	GSTV +10%	MEC	
		WIC	WSW	TSTV		GEC	GSLV +10%	MHC	
		WEC	WNW	TSMV		GHC	GWL	MOC	
		WHC	WWP	TSLV		GOC		MGW	
		WOC		TOBW		GAM		MTW	
		WAM		WBO		GCM		MSW	
		WCM		WMO		GWM		MWL	
		WWW		WSO		GEW			
		WEW							
3 Select an edge <i>View edge details</i>			NSS Bevel		NSS Bevel		NSS Bevel		NSS Bevel
4 Select hardware <i>View hardware details</i>		Hardware		Hardware		Hardware		Hardware	
		N/A		N/A		N/A		N/A	

[View statement of line](#)

## Product features.

- Adjustable height base - silver, white or black
- Electronic mechanism with programmable lift
- Unit includes 72" power cord

### NOTES

- Shipped KD

## Options.

### ACCESSORIES

- K28: Articulating Keyboard w/ Mouse - \$390
- K31: Center Drawer w/out Pull - \$205
- W18: Coil Cable Manager - \$160

### GROMMETS (STANDARD LOCATION)

- Specify Color and Location Right/Left - \$50 ea.
- Black: TM30-R (Right), TM30-L (Left)
  - Silver: TM31-R (Right), TM31-L (Left)
  - White: TM34-R (Right), TM34-L (Left)

### GROMMETS (NON-STANDARD LOCATION)

- Provide drawing w/ Grommet Location and Specify Color - \$95 ea.
- Black: TM30-NS
  - Silver: TM31-NS
  - White: TM34-NS

### MODESTY

- HM3: Veneer Half Modesty - \$260 (For "W" and "G")
- HM3M: Melamine Half Modesty - \$205 (For "M")



# NOT SO square office.

Freestanding Workstation Desks  
Breakfront Single Pedestal

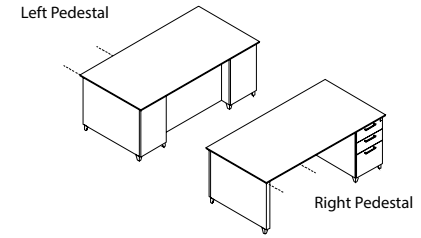

1 Select a model w" x d" x h"	weight	Standard Veneer Top Standard Veneer Chassis		Premium Veneer Top Premium Veneer Chassis		High Pressure Laminate Top Veneer Chassis		Thermally Fused Laminate Top Thermally Fused Laminate Chassis	
		<b>Left Pedestal</b>							
72 x 36 x 29	300	NSS7236DS009W	3718	NSS7236DS009P	4090	NSS7236DS009G	3718	NSS7236DS009M	2250
72 x 30 x 29	270	NSS7230DS009W	3550	NSS7230DS009P	3905	NSS7230DS009G	3550	NSS7230DS009M	2195
66 x 30 x 29	260	NSS6630DS009W	3520	NSS6630DS009P	3872	NSS6630DS009G	3520	NSS6630DS009M	2153
<b>Right Pedestal</b>									
72 x 36 x 29	300	NSS7236DS010W	3718	NSS7236DS010P	4090	NSS7236DS010G	3718	NSS7236DS010M	2250
72 x 30 x 29	270	NSS7230DS010W	3550	NSS7230DS010P	3905	NSS7230DS010G	3550	NSS7230DS010M	2195
66 x 30 x 29	260	NSS6630DS010W	3520	NSS6630DS010P	3872	NSS6630DS010G	3520	NSS6630DS010M	2153

2 Select a finish	Standard Veneer Top		Premium Veneer Top		High Pressure Laminate Top		Thermally Fused Laminate Top	
<i>View finish details</i>	WAC	WGW	TBCO	GAC	GNW	MAC	MEC	
<b>Metal finish</b>	WRC	WBW	TBSW	GIC	GSTV +10%	MHC	MOC	
MFS Silver. Additional metal finishes are available, see options.	WIC	WSW	TSTV	GEC	GSLV +10%	MTW	MSW	
	WEC	WNW	TSMV	GHC	GWL	MWL		
	WHC	WWP	TSLV	GOC				
	WOC		TOBW	GAM				
	WAM		WBO	GCM				
	WCM		WMO	GWM				
	WWW		WSO	GEW				
	WEW							

3 Select an edge	Standard Veneer Top		Premium Veneer Top		High Pressure Laminate Top		Thermally Fused Laminate Top	
<i>View edge details</i>		NSS Bevel						

4 Select hardware	Standard Veneer Top		Premium Veneer Top		High Pressure Laminate Top		Thermally Fused Laminate Top	
<i>View hardware details</i>		PL-115 Matte Black PL-116 Matte Nickel		PL-210 Anodized Aluminum		PL-115 Matte Black PL-116 Matte Nickel		PL-210 Anodized Aluminum
		PL-260 Anodized Aluminum PL-261 White		Finger Pull "W"/"G"		PL-260 Anodized Aluminum PL-261 White		Finger Pull "W"/"G"

View statement of line

## Product features.

- 6" recessed modesty
- Full extension drawers - locking
- Soft close suspension drawer(s)
- Standard Silver Feet (optional White, Black)

## Options.

### ACCESSORIES

- K28: Articulating Keyboard w/ Mouse - \$390
- K31: Center Drawer - \$205

### CHASSIS

- MODCX-1: Modify breakfront chassis to flush front chassis w/ 6" overhang top - n/c

### DRAWER

- P33: Wood Drawer Upgrade - \$45 per drawer
- WPD3061: Designer White - \$80 per pedestal

### FEET

- D8: Delete feet (extend fronts to floor) - n/c

### GROMMETS (STANDARD LOCATION)

Specify Color and Location Right/Left - \$50 ea.

- Black: TM30-R (Right), TM30-L (Left)
- Silver: TM31-R (Right), TM31-L (Left)
- White: TM34-R (Right), TM34-L (Left)

Grommets (Non-Standard Location)

Provide drawing w/ Grommet Location and Specify Color - \$95 ea.

- Black: TM30-NS
- Silver: TM31-NS
- White: TM34-NS

Modesty

- HM39: SilverLuma frame/frost (Half Modesty) - \$340
- HM51: Half Modesty - \$205

Premium Finish Option

- Specify foot metal finish color - \$160 per unit. Contact customer service

- MFB: Black, MFW: White

# NOT SO square office.

Conference Workstation Desks  
Rectangle Top With Sleigh Base

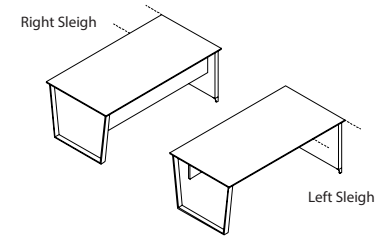

[View statement of line](#)

1 Select a model w" x d" x h"	weight	Standard Veneer Top Standard Veneer Chassis		Premium Veneer Top Premium Veneer Chassis		High Pressure Laminate Top Veneer Chassis		Thermally Fused Laminate Top Thermally Fused Laminate Chassis	
		<b>Right Sleigh Leg</b> 72 x 36 x 29 72 x 30 x 29 66 x 30 x 29 60 x 24 x 29 54 x 24 x 29	165 145 125 115 105	NSS7236DC766W NSS7230DC766W NSS6630DC766W NSS6024DC766W NSS5424DC766W	3386 3234 3201 2081 2058	NSS7236DC766P NSS7230DC766P NSS6630DC766P NSS6024DC766P NSS5424DC766P	3725 3558 3522 2290 2264	NSS7236DC766G NSS7230DC766G NSS6630DC766G NSS6024DC766G NSS5424DC766G	3386 3234 3201 2081 2058
<b>Left Sleigh Leg</b> 72 x 36 x 29 72 x 30 x 29 66 x 30 x 29 60 x 24 x 29 54 x 24 x 29	165 145 125 115 105	NSS7236DC767W NSS7230DC767W NSS6630DC767W NSS6024DC767W NSS5424DC767W	3386 3234 3201 2081 2058	NSS7236DC767P NSS7230DC767P NSS6630DC767P NSS6024DC767P NSS5424DC767P	3725 3558 3522 2290 2264	NSS7236DC767G NSS7230DC767G NSS6630DC767G NSS6024DC767G NSS5424DC767G	3386 3234 3201 2081 2058	NSS7236DC767M NSS7230DC767M NSS6630DC767M NSS6024DC767M NSS5424DC767M	2036 1920 1861 1819 1777
<b>2 Select a finish</b> <a href="#">View finish details</a>  Metal finish MFS Silver. Additional metal finishes are available, see options.		WAC WRC WIC WEC WHC WOC WAM WCM WWM WEW	WGW WBW WSW WNW WWP	TBCO TBSW TSTV TSMV TSLV TOBW WBO WMO WSO	GAC GIC GEC GHC GOC GAM GCM GWM GEW	GNW GSTV +10% GSLV +10% GWL	MAC MEC MHC MOC MGW MTW MSW MWL		
<b>3 Select an edge</b> <a href="#">View edge details</a>		NSS Bevel		NSS Bevel	NSS Bevel		NSS Bevel		
<b>4 Select hardware</b> <a href="#">View hardware details</a>		Hardware N/A		Hardware N/A	Hardware N/A		Hardware N/A		

## Product features.

- 2" thick end panel
- Angular silver metal sleigh base
- Half modesty
- Standard Silver Feet and Base (optional White, Black)

### NOTES

- K28 and K31 will not fit on 24" deep units w/ half modesty

## Options.

### ACCESSORIES

- K31: Center drawer - \$205
- K28: Articulating Keyboard w/ Mouse - \$390
- W17: Wire Mgmt. Cover, matches leg finish - \$80

### GROMMETS (STANDARD LOCATION)

Specify Color - \$50 ea.

- Black: TM30-C (Center)
- Silver: TM31-C (Center)
- White: TM34-C (Center)

### GROMMETS (NON-STANDARD LOCATION)

Provide drawing w/ Grommet Location and Specify Color - \$95 ea.

- Black: TM30-NS
- Silver: TM31-NS
- White: TM34-NS

### MODESTY

- DM: Delete half modesty - n/c
- HM45: SilverLuma frame/frost insert (half modesty) - \$415

### PREMIUM FINISH OPTION

- Specify foot metal finish color - \$160 per unit. Contact customer service
- MFB: Black, MFW: White

# NOT SO square office.

Conference Workstation Desks  
Angular Top With Sleigh Base

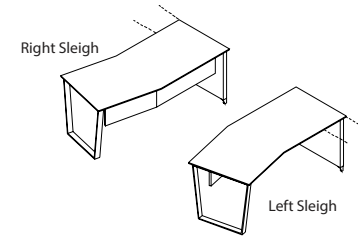

[View statement of line](#)

1 Select a model w" x d" x h"	weight	Standard Veneer Top Standard Veneer Chassis		Premium Veneer Top Premium Veneer Chassis		High Pressure Laminate Top Veneer Chassis		Thermally Fused Laminate Top Thermally Fused Laminate Chassis	
		<b>Left Sleigh leg</b> 84 x 30/36 x 29 72 x 30/36 x 29	180 155	NSS8436DC785W NSS7236DC785W	3774 3442	NSS8436DC785P NSS7236DC785P	4152 3787	NSS8436DC785G NSS7236DC785G	3774 3442
<b>Right Sleigh leg</b> 84 x 30/36 x 29 72 x 30/36 x 29	180 155	NSS8436DC784W NSS7236DC784W	3774 3442	NSS8436DC784P NSS7236DC784P	4152 3787	NSS8436DC784G NSS7236DC784G	3774 3442	NSS8436DC784M NSS7236DC784M	2583 2406
<b>2 Select a finish</b> <a href="#">View finish details</a>		WAC WRC WIC WEC WHC WOC WAM WCM WWW WEW	WGWW WBW WSW WNW WWP	TBCO TBSW TSTV TSMV TSLV TOBW WBO WMO WSO		GAC GIC GEC GHC GOC GAM GCM GWM GEW	GNW GSTV +10% GSLV +10% GWL	MAC MEC MHC MOC MGW MTW MSW MWL	
<b>3 Select an edge</b> <a href="#">View edge details</a>		NSS Bevel		NSS Bevel		NSS Bevel		NSS Bevel	
<b>4 Select hardware</b> <a href="#">View hardware details</a>		Hardware N/A		Hardware N/A		Hardware N/A		Hardware N/A	

## Product features.

- 2" thick end panel with metal legs
- Angled half modesty
- Standard Silver Feet and Base (optional White, Black)

## Options.

### ACCESSORIES

- K31: Center drawer - \$205
- K28: Articulating Keyboard w/ Mouse - \$390
- W17: Wire Mgmt. Cover, matches leg finish - \$80

### GROMMETS (STANDARD LOCATION)

- Specify Color - \$50 ea.
- Black: TM30-C (Center)
  - Silver: TM31-C (Center)
  - White: TM34-C (Center)

### GROMMETS (NON-STANDARD LOCATION)

- Provide drawing w/ Grommet Location and Specify Color - \$95 ea.
- Black: TM30-NS
  - Silver: TM31-NS
  - White: TM34-NS

### MODESTY

- DM: Delete half modesty - n/c

### PREMIUM FINISH OPTION



- Specify foot metal finish color - \$160 per unit. Contact customer service
- MFB: Black, MFW: White

# NOT SO square office.

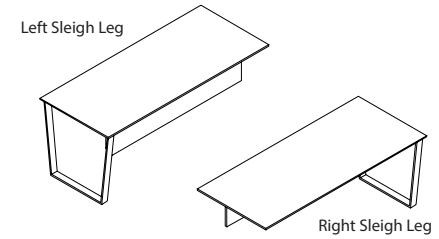
Runoff Conference Workstation Desks  
Rectangle Runoff Desk With Sleigh Base



[View statement of line](#)

1 Select a model w" x d" x h"	weight	Standard Veneer Top Standard Veneer Chassis		Premium Veneer Top Premium Veneer Chassis		High Pressure Laminate Top Veneer Chassis		Thermally Fused Laminate Top Thermally Fused Laminate Chassis				
		<b>Right Sleigh Leg</b> 72 x 30 x 29 66 x 30 x 29 60 x 30 x 29 54 x 24 x 29 <b>Left Sleigh Leg</b> 72 x 30 x 29 66 x 30 x 29 60 x 30 x 29 54 x 24 x 29	95 85 75 70 95 85 75 70	NSS7230DR770W NSS6630DR770W NSS6030DR770W NSS5424DR770W NSS7230DR771W NSS6630DR771W NSS6030DR771W NSS5424DR771W	2903 2880 2858 1834 2903 2880 2858 1834	NSS7230DR770P NSS6630DR770P NSS6030DR770P NSS5424DR770P NSS7230DR771P NSS6630DR771P NSS6030DR771P NSS5424DR771P	3194 3168 3144 2018 3194 3168 3144 2018	NSS7230DR770G NSS6630DR770G NSS6030DR770G NSS5424DR770G NSS7230DR771G NSS6630DR771G NSS6030DR771G NSS5424DR771G	2903 2880 2858 1834 2903 2880 2858 1834	NSS7230DR770M NSS6630DR770M NSS6030DR770M NSS5424DR770M NSS7230DR771M NSS6630DR771M NSS6030DR771M NSS5424DR771M	1437 1340 1295 1227 1437 1340 1295 1227	
<b>2 Select a finish</b> <a href="#">View finish details</a> Metal finish MFS Silver. Additional metal finishes are available, see options.	WAC WRC WIC WEC WHC WOC WAM WCM WWM WEW	WGW WBW WSW WNW WWP	TBCO TBSW TSTV TSMV TSLV TOBW WBO WMO WSO	GAC GIC GEC GHC GOC GAM GCM GWM GEW	GNW GSTV +10% GSLV +10% GWL	MAC MEC MHC MOC MGW MTW MSW MWL	 Narrow Bevel	 Wide Bevel	Hardware N/A	Hardware N/A	Hardware N/A	Hardware N/A

## Product features.

- Half modesty standard
- Standard Silver Base (optional White, Black)

### NOTES

- When Specifying Runoff Desk w/ Bench Credenzas, You Must: Specify Runoff Desk Bench Support.
- K28 and K31 will not fit on 24" deep units w/ half modesty
- Hooks to freestanding unit

## Options.

### ACCESSORIES

- K28: Articulating Keyboard w/ Mouse - \$390
- K31: Center Drawer - \$205
- W17: Wire Mgmt. Cover, matches leg finish - \$80

### BENCH SUPPORT

- 23BRL30: 30" Bench Support - "W" and "G" \$195 - "M" \$130
- 23BRL24: 24" Bench Support - "W" and "G" \$155 - "M" \$115

### GROMMETS (STANDARD LOCATION)

- Specify Color - \$50 ea.
- Black: TM30-C (Center)
  - Silver: TM31-C (Center)
  - White: TM34-C (Center)

### GROMMETS (NON-STANDARD LOCATION)

- Provide drawing w/ Grommet Location and Specify Color - \$95 ea.
- Black: TM30-NS
  - Silver: TM31-NS
  - White: TM34-NS

### MODESTY

- DM: Delete Half Modesty - n/c
- HM45: SilverLuma frame/frost insert (half modesty) - \$395 Premium Finish Option
- Specify foot metal finish color - \$160 per unit. Contact customer service
- MFB: Black, MFW: White

# NOT SO square office.

"L" Workstation Returns  
File/File

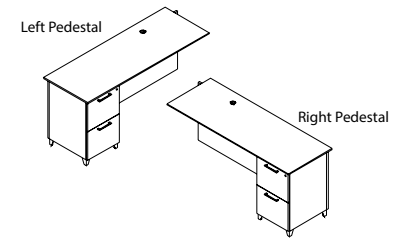

## 1 Select a model

w" x d" x h"

weight	Standard Veneer Top Standard Veneer Chassis		Premium Veneer Top Premium Veneer Chassis		High Pressure Laminate Top Veneer Chassis		Thermally Fused Laminate Top Thermally Fused Laminate Chassis	
<b>Left Pedestal</b>								
60 x 22 x 29	160	NSS6022RE195W 2885	NSS6022RE195P 3174	NSS6022RE195G 2885	NSS6022RE195M 1574			
54 x 22 x 29	145	NSS5422RE195W 2868	NSS5422RE195P 3155	NSS5422RE195G 2868	NSS5422RE195M 1499			
48 x 22 x 29	135	NSS4822RE195W 2761	NSS4822RE195P 3038	NSS4822RE195G 2761	NSS4822RE195M 1440			
42 x 22 x 29	125	NSS4222RE195W 2723	NSS4222RE195P 2996	NSS4222RE195G 2723	NSS4222RE195M 1403			
<b>Right Pedestal</b>								
60 x 22 x 29	160	NSS6022RE196W 2885	NSS6022RE196P 3174	NSS6022RE196G 2885	NSS6022RE196M 1574			
54 x 22 x 29	145	NSS5422RE196W 2868	NSS5422RE196P 3155	NSS5422RE196G 2868	NSS5422RE196M 1499			
48 x 22 x 29	135	NSS4822RE196W 2761	NSS4822RE196P 3038	NSS4822RE196G 2761	NSS4822RE196M 1440			
42 x 22 x 29	125	NSS4222RE196W 2723	NSS4222RE196P 2996	NSS4222RE196G 2723	NSS4222RE196M 1403			

[View statement of line](#)

## 2 Select a finish

[View finish details](#)

**Metal finish**  
MFS Silver. Additional metal finishes are available, see options.

WAC	WGW
WRC	WBW
WIC	WSW
WEC	WNW
WHC	WWP
WOC	
WAM	
WCM	
WWW	
WEW	

TBCO
TBSW
TSTV
TSMV
TSLV
TOBW
WBO
WMO
WSO

GAC	GNW
GIC	GSTV +10%
GEC	GSLV +10%
GHC	GWL
GOC	
GAM	
GCM	
GWM	
GEW	

MAC
MEC
MHC
MOC
MGW
MTW
MSW
MWL

## 3 Select a edge

[View edge details](#)



## 4 Select hardware

[View hardware details](#)



## Product features.

- All drawers lock
- Standard full fixed modesty panel
- Standard metal grommet matches pull finish
- Standard silver feet (optional White, Black)
- Soft close suspension drawer(s)

### NOTES

- Laminate version "M" standard w/ open plan back
- Returns with Grommets in top will automatically have wire channel and outfeed holes in back.
- Unit not designed for open plan use. Select OPB for Open Plan application
- Left pedestal gets right grommet
- Right pedestal gets left grommet

## Options.

### ACCESSORIES

- K28: Articulating Keyboard w/ Mouse - \$390

### DRAWER

- P6: Modify File/File to Box/Box/File - \$55 per pedestal
- P33: Wood Drawer Upgrade - \$45 per drawer
- P40W: extra Box/Box/File or File/File to Knee space - \$910
- P40M: extra Box/Box/File or File/File to Knee space - \$720
- WPD3061: Designer White - \$80 per pedestal

### FEET

- D8: Delete feet (extend fronts to floor) - n/c

### FLUSH CUT

- FC-L: Flush Unit Left (Facing) for Ganging - \$55
- FC-R: Flush Unit Right(Facing) for Ganging - \$55

### GROMMETS (NON-STANDARD LOCATION)

Provide drawing w/ Grommet Location and Specify Color - \$95 ea.

- Black: TM30-NS
- Silver: TM31-NS
- White: TM34-NS

### Modesty

- M34T: "W" "G" Style Drop Door Tech Modesty - \$130
- M34TM: "M" Style Drop Door Tech Modesty - \$130
- M51: Open Back Modesty with Wire Mgmt Rail - Deduct \$95
- Open Plan - Finished Back

- OPB: "W" "G" Style - Modify Unit for Open Plan Application - \$295 Premium Finish Option

- Specify foot metal finish color - \$160 per unit. Contact customer service

- MFB: Black, MFW: White

# NOT SO square office.

"L" Workstation Returns  
Lateral File

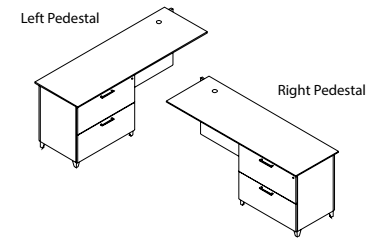

1 Select a model w" x d" x h"	weight	Standard Veneer Top Standard Veneer Chassis		Premium Veneer Top Premium Veneer Chassis		High Pressure Laminate Top Veneer Chassis		Thermally Fused Laminate Top Thermally Fused Laminate Chassis	
		<b>Left Pedestal</b>							
72 x 22 x 29	200	NSS7222RE187W	3065	NSS7222RE187P	3372	NSS7222RE187G	3065	NSS7222RE187M	1839
66 x 22 x 29	190	NSS6622RE187W	3037	NSS6622RE187P	3341	NSS6622RE187G	3037	NSS6622RE187M	1766
60 x 22 x 29	180	NSS6022RE187W	2992	NSS6022RE187P	3292	NSS6022RE187G	2992	NSS6022RE187M	1693
54 x 22 x 29	170	NSS5422RE187W	2965	NSS5422RE187P	3262	NSS5422RE187G	2965	NSS5422RE187M	1624
<b>Right Pedestal</b>									
72 x 22 x 29	200	NSS7222RE188W	3065	NSS7222RE188P	3372	NSS7222RE188G	3065	NSS7222RE188M	1839
66 x 22 x 29	190	NSS6622RE188W	3037	NSS6622RE188P	3341	NSS6622RE188G	3037	NSS6622RE188M	1766
60 x 22 x 29	180	NSS6022RE188W	2992	NSS6022RE188P	3292	NSS6022RE188G	2992	NSS6022RE188M	1693
54 x 22 x 29	170	NSS5422RE188W	2965	NSS5422RE188P	3262	NSS5422RE188G	2965	NSS5422RE188M	1624
48 x 22 x 29	165	NSS4822RE188W	2891	NSS4822RE188P	3181	NSS4822RE188G	2891	NSS4822RE188M	1572

2 Select a finish	WAC		WGW	TBCO	GAC	GNW	MAC
<i>View finish details</i>	WRC	WBW		TBSW	GIC	GSTV +10%	MEC
<b>Metal finish</b>	WIC	WSW		TSTV	GEC	GSLV +10%	MHC
MFS Silver. Additional metal finishes are available, see options.	WEC	WNW		TSMV	GHC	GWL	MOC
	WHC	WWP		TSLV	GOC		MGW
	WOC			TOBV	GAM		MTW
	WAM			WBO	GCM		MSW
	WCM			WMO	GWM		MWL
	WWW			WSO	GEW		
	WEW						

3 Select a edge	NSS Bevel		NSS Bevel		NSS Bevel		NSS Bevel	
<i>View edge details</i>								

4 Select hardware	PL-115 Matte Black PL-116 Matte Nickel		PL-210 Anodized Aluminum		PL-115 Matte Black PL-116 Matte Nickel		PL-210 Anodized Aluminum		PL-115 Matte Black PL-116 Matte Nickel		PL-210 Anodized Aluminum	
<i>View hardware details</i>												

[View statement of line](#)

## Product features.

- Full modesty panel
- Full extension drawers - locking
- Standard metal grommet matches pull finish
- Soft close suspension drawer(s)
- Standard Silver Feet (optional White, Black)

### NOTES

- Keyboard not available on noted 48" /54" units. Returns with Grommets in top will automatically have wire channel and outfeed holes in back.
- Laminate version "M" standard w/ open plan back
- Unit not designed for open plan use. Select OPB for Open Plan application
- Left pedestal gets right grommet
- Right pedestal gets left grommet

## Options.

### ACCESSORIES

- K28: Articulating Keyboard w/ Mouse - \$390

### DRAWER

- P33: Wood Drawer Upgrade - \$45 per drawer
- P40W: extra Box/Box/File or File/File to Knee space - \$910
- P40M: extra Box/Box/File or File/File to Knee space - \$720
- WPD3061: Designer White - \$80 per pedestal

### FEET

- D8: Delete feet (extend fronts to floor) - n/c

### FLUSH CUT

- FC-L: Flush Unit Left (Facing) for Ganging - \$55
- FC-R: Flush Unit Right(Facing) for Ganging - \$55

### GROMMETS (NON-STANDARD LOCATION)

Provide drawing w/ Grommet Location and Specify Color - \$95 ea.

- Black: TM30-NS
- Silver: TM31-NS
- White: TM34-NS

### Modesty

- M34T: "W" "G" Style Drop Door Tech Modesty - \$130
- M34TM: "M" Style Drop Door Tech Modesty - \$130
- M51: Open Back Modesty with Wire Mgmt Rail - Deduct \$95
- Open Plan – Finished Back
- OPB: "W" "G" Style - Modify Unit for Open Plan Application - \$295

### Premium Finish Option

- Specify foot metal finish color - \$160 per unit. Contact customer service
- MFB: Black, MFW: White

# NOT SO square office.

"L" Workstation Returns  
Multi-File

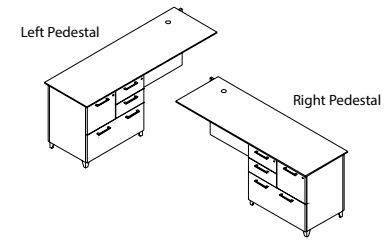

1 Select a model w" x d" x h"	weight	Standard Veneer Top Standard Veneer Chassis		Premium Veneer Top Premium Veneer Chassis		High Pressure Laminate Top Veneer Chassis		Thermally Fused Laminate Top Thermally Fused Laminate Chassis	
		<b>Left Pedestal</b>							
72 x 22 x 29	200	NSS7222RE218W	3149	NSS7222RE218P	3464	NSS7222RE218G	3149	NSS7222RE218M	1943
66 x 22 x 29	190	NSS6622RE218W	3122	NSS6622RE218P	3435	NSS6622RE218G	3122	NSS6622RE218M	1870
60 x 22 x 29	180	NSS6022RE218W	3077	NSS6022RE218P	3385	NSS6022RE218G	3077	NSS6022RE218M	1796
54 x 22 x 29	170	NSS5422RE218W	3049	NSS5422RE218P	3354	NSS5422RE218G	3049	NSS5422RE218M	1731
48 x 22 x 29	165	NSS4822RE218W	2975	NSS4822RE218P	3273	NSS4822RE218G	2975	NSS4822RE218M	1678
<b>Right Pedestal</b>									
72 x 22 x 29	200	NSS7222RE219W	3149	NSS7222RE219P	3464	NSS7222RE219G	3149	NSS7222RE219M	1943
66 x 22 x 29	190	NSS6622RE219W	3122	NSS6622RE219P	3435	NSS6622RE219G	3122	NSS6622RE219M	1870
60 x 22 x 29	180	NSS6022RE219W	3077	NSS6022RE219P	3385	NSS6022RE219G	3077	NSS6022RE219M	1796
54 x 22 x 29	170	NSS5422RE219W	3049	NSS5422RE219P	3354	NSS5422RE219G	3049	NSS5422RE219M	1731
48 x 22 x 29	165	NSS4822RE219W	2975	NSS4822RE219P	3273	NSS4822RE219G	2975	NSS4822RE219M	1678

2 Select a finish	WAC		WGW	TBCO	GAC	GNW	MAC
<i>View finish details</i>	WRC	WBW		TBSW	GIC	GSTV +10%	MEC
<b>Metal finish</b>	WIC	WSW		TSTV	GEC	GSLV +10%	MHC
MFS Silver. Additional metal finishes are available, see options.	WEC	WNW		TSMV	GHC	GWL	MOC
	WHC	WWP		TSLV	GOC		MGW
	WOC			TOBW	GAM		MTW
	WAM			WBO	GCM		MSW
	WCM			WMO	GWM		MWL
	WWW			WSO	GEW		
	WEW						

3 Select a edge	NSS Bevel		NSS Bevel		NSS Bevel	
<i>View edge details</i>						

4 Select hardware	PL-115 Matte Black PL-116 Matte Nickel		PL-210 Anodized Aluminum		PL-115 Matte Black PL-116 Matte Nickel		PL-210 Anodized Aluminum		PL-115 Matte Black PL-116 Matte Nickel		PL-210 Anodized Aluminum	
<i>View hardware details</i>												
	PL-260 Anodized Aluminum PL-261 White		Finger Pull "W"/"G"		PL-260 Anodized Aluminum PL-261 White		Finger Pull "W"/"G"		PL-260 Anodized Aluminum PL-261 White		Finger Pull "W"/"G"	

View statement of line

## Product features.

- Full modesty panel
- Full extension drawers - locking
- Pedestal is 31" W
- Soft close suspension drawer(s)
- Standard metal grommet matches pull finish
- Standard Silver Feet (optional White, Black)

### NOTES

- Keyboard not available on noted 48" /54" units. Returns with Grommets in top will automatically have wire channel and outfeed holes in back.
- Laminate version "M" standard w/ open plan back
- Unit not designed for open plan use. Select OPB for Open Plan application
- Left pedestal gets right grommet
- Right pedestal gets left grommet

## Options.

### ACCESSORIES

- K28: Articulating Keyboard w/ Mouse - \$390

### DRAWER

- P33: Wood Drawer Upgrade - \$45 per drawer
- P40W: extra Box/Box/File or File/File to Knee space - \$910
- P40M: extra Box/Box/File or File/File to Knee space - \$720
- WPD3061: Designer White - \$80 per pedestal

### FEET

- D8: Delete feet (extend fronts to floor) - n/c

### FLUSH CUT

- FC-B: Flush Unit Both Sides(Facing) for Ganging - \$55
- FC-L: Flush Unit Left (Facing) for Ganging - \$55
- FC-R: Flush Unit Right(Facing) for Ganging - \$55

### GROMMETS (NON-STANDARD LOCATION)

Provide drawing w/ Grommet Location and Specify Color - \$95 ea.

- Black: TM30-NS
- Silver: TM31-NS
- White: TM34-NS

### Modesty

- M34T: "W" "G" Style Drop Door Tech Modesty - \$130
- M34TM: "M" Style Drop Door Tech Modesty - \$130
- M51: Open Back Modesty with Wire Mgmt Rail - Deduct \$95

### Open Plan – Finished Back

- OPB: "W" "G" Style - Modify Unit for Open Plan Application - \$295

### Premium Finish Option

- Specify foot metal finish color - \$160 per unit. Contact customer service
- MFB: Black, MFW: White

# NOT SO square office.

Workstation Bridges  
Open Back Bridge

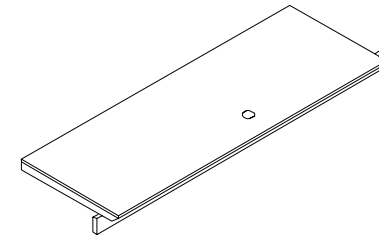

1 Select a model w" x d" x h"	weight	Standard Veneer Top Standard Veneer Chassis		Premium Veneer Top Premium Veneer Chassis		High Pressure Laminate Top Veneer Chassis		Thermally Fused Laminate Top Thermally Fused Laminate Chassis	
		48 x 22 x 29	55	NSS4822BR151W	608	NSS4822BR151P	669	NSS4822BR151G	608
42 x 22 x 29	391	NSS4222BR151W	574	NSS4222BR151P	632	NSS4222BR151G	574	NSS4222BR151M	484
36 x 22 x 29	363	NSS3622BR151W	546	NSS3622BR151P	601	NSS3622BR151G	546	NSS3622BR151M	449

2 Select a finish <i>View finish details</i>	Standard Veneer Top		Premium Veneer Top		High Pressure Laminate Top		Thermally Fused Laminate Top	
	<i>View finish details</i>	WAC	WGW	TBCO	GAC	GNW	MAC	MEC
	WRC	WBW	TBSW	GIC	GSTV +10%	MHC	MOC	
	WIC	WSW	TSTV	GEC	GSLV +10%	MGW	MTW	
	WEC	WNW	TSMV	GHC	GWL	MSW	MWL	
	WHC	WWP	TSLV	GOC				
	WOC		TOBW	GAM				
	WAM		WBO	GCM				
	WCM		WMO	GWM				
	WWW		WSO	GEW				
	WEW							

3 Select an edge <i>View edge details</i>	Standard Veneer Top		Premium Veneer Top		High Pressure Laminate Top		Thermally Fused Laminate Top	
	<i>View edge details</i>	NSS Bevel		NSS Bevel		NSS Bevel		NSS Bevel

4 Select hardware <i>View hardware details</i>	Standard Veneer Top		Premium Veneer Top		High Pressure Laminate Top		Thermally Fused Laminate Top	
	<i>View hardware details</i>	Hardware N/A		Hardware N/A		Hardware N/A		Hardware N/A

*View statement of line*

## Product features.

- Metal grommet matches pull finish
- Standard open back 4" wire management rail

## Options.

### ACCESSORIES

- K28: Articulating Keyboard w/ Mouse - \$390
- K31: Center Drawer - \$205

### GROMMETS (NON-STANDARD LOCATION)

Provide drawing w/ Grommet Location and Specify Color - \$95 ea.

- Black: TM30-NS
- Silver: TM31-NS
- White: TM34-NS

### MODESTY

- M34T: "W" "G" Style Drop Door Tech Modesty - \$130
- M34TM: "M" Style Drop Door Tech Modesty - \$130
- M37: "W" "G" Style Fixed Full Modesty - \$130
- M37M: "M" Style Fixed Full Modesty - \$80



# NOT SO square office.

Freestanding Lateral File Credenzas  
Lateral File/Storage

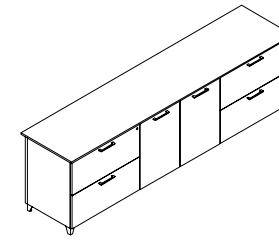

## 1 Select a model

w" x d" x h"

weight	Standard Veneer Top		Premium Veneer Top		High Pressure Laminate Top		Thermally Fused Laminate Top	
	Standard Veneer Chassis		Premium Veneer Chassis		Veneer Chassis		Thermally Fused Laminate Chassis	
95 x 22 x 29	350	NSS9522CA651W 4467	NSS9522CA651P 4914	NSS9522CA651G 4467	NSS9522CA651M 3430			
89 x 22 x 29	330	NSS8922CA651W 4398	NSS8922CA651P 4838	NSS8922CA651G 4398	NSS8922CA651M 3324			

[View statement of line](#)

## 2 Select a finish

[View finish details](#)

**Metal finish**  
MFS Silver. Additional metal finishes are available, see options.

WAC	WGW
WRC	WBW
WIC	WSW
WEC	WNW
WHC	WWP
WOC	
WAM	
WCM	
WWW	
WEW	

TBCO
TBSW
TSTV
TSMV
TSLV
TOBW
WBO
WMO
WSO

GAC	GNW
GIC	GSTV +10%
GEC	GSLV +10%
GHC	GWL
GOC	
GAM	
GCM	
GWM	
GEW	

MAC
MEC
MHC
MOC
MGW
MTW
MSW
MWL

## 3 Select a edge

[View edge details](#)



## 4 Select hardware

[View hardware details](#)

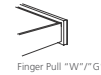
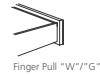
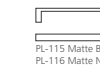
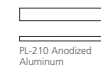
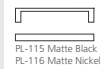
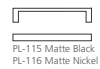
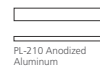
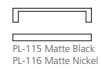

## Product features.

- Full height storage has black laminate adjustable shelf
- Full extension drawers - locking
- Soft close suspension drawer(s)
- Standard Silver Feet (optional White, Black)

### NOTES

- Unit not designed for open plan use. Select OPB for Open Plan application

## Options.

### DOOR

- D2: Door Lock per door set - \$100
- D6A: "W"/"G" Styles - Delete Doors and replace black laminate shelf with finished shelf - n/c
- D9SC: Soft Close Door Hinges - \$20 per door

### DRAWER

- P33: Wood Drawer Upgrade - \$45 per drawer
- WPD3061: Designer White - \$80 per pedestal

### FEET

- D8: Delete feet (extend fronts to floor) - n/c

### FLUSH CUT

- FC-B: Flush Unit Both Sides(Facing) for Ganging - \$55
- FC-L: Flush Unit Left (Facing) for Ganging - \$55
- FC-R: Flush Unit Right(Facing) for Ganging - \$55

### GROMMETS (STANDARD LOCATION)

- Specify Color and Location (Right/Left/Center) - \$50 ea.
- Black: TM30-R (Right), TM30-L (Left), TM30-C (Center)
- Silver: TM31-R (Right), TM31-L (Left), TM31-C (Center)
- White: TM34-R (Right), TM34-L (Left), TM34-C (Center)

### Grommets (Non-Standard Location)

- Provide drawing w/ Grommet Location and Specify Color - \$95 ea.
- Black: TM30-NS
- Silver: TM31-NS
- White: TM34-NS

### Open Plan – Finished Back

- OPB: "W" "G" Style - Modify Unit for Open Plan Application - \$295 Shelf
- S714F: Heavy Duty Lumber 1" Shelves - \$80 per shelf ("M" Styles - n/a)

### Premium Finish Option

- Specify foot metal finish color - \$160 per unit. Contact customer service
- MFB: Black, MFW: White

# NOT SO square office.

File Credenzas  
File/File/Kneespace

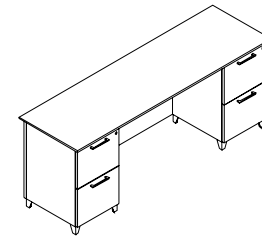

**1 Select a model**  
w" x d" x h"

weight	Standard Veneer Top		Premium Veneer Top		High Pressure Laminate Top		Thermally Fused Laminate Top				
	Standard Veneer Chassis		Premium Veneer Chassis		Veneer Chassis		Thermally Fused Laminate Chassis				
84 x 22 x 29	240	NSS8422CA054W 3560	NSS8422CA054P 3916	NSS8422CA054G 3560	NSS8422CA054M 2345	NSS7222CA054W 3296	NSS7222CA054P 3626	NSS7222CA054G 3296	NSS7222CA054M 2192		
72 x 22 x 29	220	NSS7222CA054W 3296	NSS7222CA054P 3626	NSS7222CA054G 3296	NSS7222CA054M 2192	66 x 24 x 29	210	NSS6622CA054W 3261	NSS6622CA054P 3588	NSS6622CA054G 3261	NSS6622CA054M 2150
66 x 24 x 29	210	NSS6622CA054W 3261	NSS6622CA054P 3588	NSS6622CA054G 3261	NSS6622CA054M 2150	60 x 24 x 29	200	NSS6022CA054W 3229	NSS6022CA054P 3552	NSS6022CA054G 3229	NSS6022CA054M 2118

[View statement of line](#)

**2 Select a finish**  
[View finish details](#)

Metal finish  
MFS Silver. Additional metal finishes are available, see options.

WAC	WGW
WRC	WBW
WIC	WSW
WEC	WNW
WHC	WWP
WOC	
WAM	
WCM	
WWW	
WEW	

TBCO	GAC	GNW
TBSW	GIC	GSTV +10%
TSTV	GEC	GSLV +10%
TSMV	GHC	GWL
TSLV	GOC	
TOBW	GAM	
WBO	GCM	
WMO	GWM	
WSO	GEW	

MAC
MEC
MHC
MOC
MGW
MTW
MSW
MWL

**3 Select a edge**  
[View edge details](#)

	NSS Bevel
--	-----------

	NSS Bevel
--	-----------

	NSS Bevel
--	-----------

	NSS Bevel
--	-----------

**4 Select hardware**  
[View hardware details](#)

	PL-115 Matte Black PL-116 Matte Nickel		PL-210 Anodized Aluminum
	PL-260 Anodized Aluminum PL-261 White		Finger Pull "W"/"G"

	PL-115 Matte Black PL-116 Matte Nickel		PL-210 Anodized Aluminum
	PL-260 Anodized Aluminum PL-261 White		Finger Pull "W"/"G"

	PL-115 Matte Black PL-116 Matte Nickel		PL-210 Anodized Aluminum
	PL-260 Anodized Aluminum PL-261 White		Finger Pull "W"/"G"

	PL-115 Matte Black PL-116 Matte Nickel		PL-210 Anodized Aluminum
	PL-260 Anodized Aluminum PL-261 White		Finger Pull "W"/"G"

## Product features.

- Full modesty back
- Full extension drawers - locking
- Soft close suspension drawer(s)
- Standard Silver Feet (optional White, Black)

### NOTES

- If a grommet is located in top surface over open knee space, an out-feed hole will be provided in modesty panel
- Unit not designed for open plan use. Select OPB for Open Plan application

## Options.

### ACCESSORIES

- K28: Articulating Keyboard w/ Mouse - \$390

### DRAWER

- P6: Modify File/File to Box/Box/File - \$55 per pedestal
- P33: Wood Drawer Upgrade - \$45 per drawer
- WPD3061: Designer White - \$80 per pedestal

### FEET

- D8: Delete feet (extend fronts to floor) - n/c

### FLUSH CUT

- FC-B: Flush Unit Both Sides(Facing) for Ganging - \$55
- FC-L: Flush Unit Left (Facing) for Ganging - \$55
- FC-R: Flush Unit Right(Facing) for Ganging - \$55

### GROMMETS (STANDARD LOCATION)

- Specify Color - \$50 ea.
- Black: TM30-C (Center)
- Silver: TM31-C (Center)
- White: TM34-C (Center)
- Grommets (Non-Standard Location)
- Provide drawing w/ Grommet Location and Specify Color - \$95 ea.
- Black: TM30-NS
- Silver: TM31-NS
- White: TM34-NS

### Modesty

- M34T: "W" "G" Style Drop Door Tech Modesty - \$130
- M34TM: "M" Style Drop Door Tech Modesty - \$130
- M51: Open Back Modesty with Wire Mgmt Rail - Deduct \$95
- Open Plan - Finished Back
- OPB: "W" "G" Style - Modify Unit for Open Plan Application - \$295
- Premium Finish Option
- Specify foot metal finish color - \$160 per unit. Contact customer service
- MFB: Black, MFW: White

# NOT SO square office.

Freestanding Storage Credenzas  
Storage

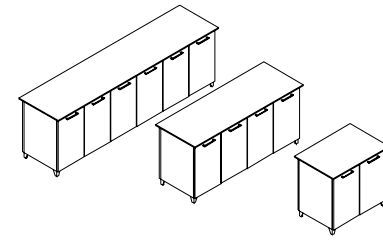

[View statement of line](#)

1 Select a model w" x d" x h"	weight	Standard Veneer Top Standard Veneer Chassis		Premium Veneer Top Premium Veneer Chassis		High Pressure Laminate Top Veneer Chassis		Thermally Fused Laminate Top Thermally Fused Laminate Chassis	
		<b>3 Section</b> 95 x 22 x 29 89 x 22 x 29 <b>2 Section</b> 72 x 22 x 29 60 x 22 x 29 <b>1 Section</b> 37 x 22 x 29 31 x 22 x 29	325 300 275 250 145 135	NSS9522CA125W NSS8922CA125W NSS7222CA125W NSS6022CA125W NSS3722CA125W NSS3122CA125W	4302 4230 3454 3353 1846 1744	NSS9522CA125P NSS8922CA125P NSS7222CA125P NSS6022CA125P NSS3722CA125P NSS3122CA125P	4733 4653 3800 3689 2031 1919	NSS9522CA125G NSS8922CA125G NSS7222CA125G NSS6022CA125G NSS3722CA125G NSS3122CA125G	4302 4230 3454 3353 1846 1744

2 Select a finish <a href="#">View finish details</a>	Metal finish MFS Silver. Additional metal finishes are available, see options.		TBCO TBSW TSTV TSMV TSLV TOBW WBO WMO WSO	GAC GIC GEC GHC GOC GAM GCM GWM GEW	GNW GSTV +10% GSLV +10% GWL	MAC MEC MHC MOC MGW MTW MSW MWL
	WAC WRC WIC WEC WHC WOC WAM WCM WWW WEW	WGW WBW WSW WNW WWP				

3 Select a edge <a href="#">View edge details</a>	NSS Bevel		NSS Bevel		NSS Bevel	

4 Select hardware <a href="#">View hardware details</a>	PL-115 Matte Black PL-116 Matte Nickel		PL-210 Anodized Aluminum		PL-115 Matte Black PL-116 Matte Nickel		PL-210 Anodized Aluminum		PL-115 Matte Black PL-116 Matte Nickel		PL-210 Anodized Aluminum	

## Product features.

- Full height storage has 1 adjustable black laminate shelf per section
- Standard Silver Feet (optional White, Black)

### NOTES

- Unit not designed for open plan use. Select OPB for Open Plan application

## Options.

### DOOR

- D2: Door lock (only available in panel door) - \$100 per door set
- D6A: "W"/"G" Styles - Delete Doors and replace black laminate shelf with finished shelf - n/c
- D9SC: Soft Close Door Hinges - \$20 per door
- WPD3061: Designer White - \$80 per door

### FEET

- D8: Delete feet (extend fronts to floor) - n/c

### FLUSH CUT

- FC-B: Flush Unit Both Sides(Facing) for Ganging - \$55
- FC-L: Flush Unit Left (Facing) for Ganging - \$55
- FC-R: Flush Unit Right(Facing) for Ganging - \$55

### GROMMETS (STANDARD LOCATION)

- Specify Color and Location (Right/Left/Center) - \$50 ea.
- Black: TM30-R (Right), TM30-L (Left), TM30-C (Center)
  - Silver: TM31-R (Right), TM31-L (Left), TM31-C (Center)
  - White: TM34-R (Right), TM34-L (Left), TM34-C (Center)

### GROMMETS (NON-STANDARD LOCATION)

- Provide drawing w/ Grommet Location and Specify Color - \$95 ea.
- Black: TM30-NS
  - Silver: TM31-NS
  - White: TM34-NS
- Grommets (Vertical Surface)  
Standard Location - \$50 ea.
- Black Plastic Vertical Surface: TM50-C (Bottom Center)
- Non-Standard Location - \$95 ea.
- Black Plastic Vertical Surface: TM50-NS
- Open Plan – Finished Back
- OPB: "W" "G" Style - Modify Unit for Open Plan Application - \$295 Premium Finish Option
  - Specify foot metal finish color - \$160 per unit. Contact customer service
  - MFB: Black, MFW: White

# NOT SO square office.

Freestanding Lateral File Credenzas  
Horizontal Lateral File

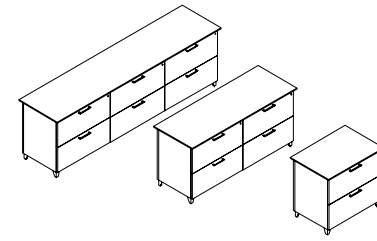

[View statement of line](#)

1 Select a model w" x d" x h"	weight	Standard Veneer Top Standard Veneer Chassis		Premium Veneer Top Premium Veneer Chassis		High Pressure Laminate Top Veneer Chassis		Thermally Fused Laminate Top Thermally Fused Laminate Chassis	
		<b>6 Drawer</b> 95 x 22 x 29 89 x 22 x 29	370 350	NSS9522CA104W NSS8922CA104W	4545 4482	NSS9522CA104P NSS8922CA104P	5000 4931	NSS9522CA104G NSS8922CA104G	4545 4482
<b>4 Drawer</b> 72 x 22 x 29 60 x 22 x 29	315 275	NSS7222CA104W NSS6022CA104W	3611 3510	NSS7222CA104P NSS6022CA104P	3973 3861	NSS7222CA104G NSS6022CA104G	3611 3510	NSS7222CA104M NSS6022CA104M	2597 2525
<b>2 Drawer</b> 43 x 22 x 29 37 x 22 x 29 31 x 22 x 29	175 160 150	NSS4322CA104W NSS3722CA104W NSS3122CA104W	2104 1919 1846	NSS4322CA104P NSS3722CA104P NSS3122CA104P	2315 2111 2031	NSS4322CA104G NSS3722CA104G NSS3122CA104G	2104 1919 1846	NSS4322CA104M NSS3722CA104M NSS3122CA104M	1642 1519 1477

2 Select a finish <a href="#">View finish details</a>	Metal finish MFS Silver. Additional metal finishes are available, see options.		TBCO TBSW TSTV TSMV TSLV TOBW WBO WMO WSO	GAC GIC GEC GHC GOC GAM GCM GWM GEW	GNW GSTV +10% GSLV +10% GWL	MAC MEC MHC MOC MGW MTW MSW MWL
		WAC WRC WIC WEC WHC WOC WAM WCM WWW WEW				

3 Select a edge <a href="#">View edge details</a>	NSS Bevel		NSS Bevel		NSS Bevel	

4 Select hardware <a href="#">View hardware details</a>	PL-115 Matte Black PL-116 Matte Nickel		PL-210 Anodized Aluminum		PL-115 Matte Black PL-116 Matte Nickel		PL-210 Anodized Aluminum		PL-115 Matte Black PL-116 Matte Nickel		PL-210 Anodized Aluminum	
	PL-260 Anodized Aluminum PL-261 White	Finger Pull "W"/"G"	PL-260 Anodized Aluminum PL-261 White	Finger Pull "W"/"G"	PL-260 Anodized Aluminum PL-261 White	Finger Pull "W"/"G"	PL-260 Anodized Aluminum PL-261 White	Finger Pull "W"/"G"	PL-260 Anodized Aluminum PL-261 White	Finger Pull "W"/"G"	PL-260 Anodized Aluminum PL-261 White	Finger Pull "W"/"G"

## Product features.

- Anti-tip safety feature (31"-72")
- Full extension drawers - locking
- Soft close suspension drawer(s)
- Standard Silver Feet (optional White, Black)

### NOTES

- Unit not designed for open plan use. Select OPB for Open Plan application

## Options.

### DRAWER

- P33: Wood Drawer Upgrade - \$45 per drawer
- WPD3061: Designer White - \$80 per pedestal

### FEET

- D8: Delete feet (extend fronts to floor) - n/c

### FLUSH CUT

- FC-B: Flush Unit Both Sides(Facing) for Ganging - \$55
- FC-L: Flush Unit Left (Facing) for Ganging - \$55
- FC-R: Flush Unit Right(Facing) for Ganging - \$55

### OPEN PLAN – FINISHED BACK

- OPB: "W" "G" Style - Modify Unit for Open Plan Application - \$295

### PREMIUM FINISH OPTION

- Specify foot metal finish color - \$160 per unit. Contact customer service
- MFB: Black, MFW: White

# NOT SO square office.

Freestanding Lateral File Credenzas  
Vertical Lateral File

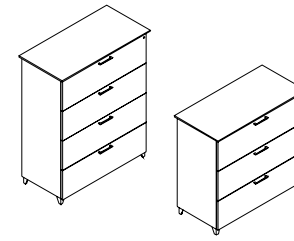

[View statement of line](#)

1 Select a model w" x d" x h"	weight	Standard Veneer Top Standard Veneer Chassis		Premium Veneer Top Premium Veneer Chassis		High Pressure Laminate Top Veneer Chassis		Thermally Fused Laminate Top Thermally Fused Laminate Chassis	
		<b>4 Drawer</b> 43 x 22 x 54 37 x 22 x 54 31 x 22 x 54 <b>3 Drawer</b> 43 x 22 x 42 37 x 22 x 42 31 x 22 x 42	290 270 245 255 235 215	NSS4322FI111W NSS3722FI111W NSS3122FI111W NSS4322FI112W NSS3722FI112W NSS3122FI112W	3858 3645 3510 3588 3386 3261	NSS4322FI111P NSS3722FI111P NSS3122FI111P NSS4322FI112P NSS3722FI112P NSS3122FI112P	4244 4010 3861 3947 3725 3588	NSS4322FI111G NSS3722FI111G NSS3122FI111G NSS4322FI112G NSS3722FI112G NSS3122FI112G	3858 3645 3510 3588 3386 3261

2 Select a finish <a href="#">View finish details</a>	Metal finish MFS Silver. Additional metal finishes are available, see options.		TBCO TBSW TSTV TSMV TSLV TOBW WBO WMO WSO	GAC GIC GEC GHC GOC GAM GCM GWM GEW	GNW GSTV +10% GSLV +10% GWL	MAC MEC MHC MOC MGW MTW MSW MWL
	WAC WRC WIC WEC WHC WOC WAM WCM WWW WEW	WGW WBW WSW WNW WWP				

3 Select a edge <a href="#">View edge details</a>	NSS Bevel		NSS Bevel		NSS Bevel	

4 Select hardware <a href="#">View hardware details</a>	PL-115 Matte Black PL-116 Matte Nickel		PL-210 Anodized Aluminum		PL-115 Matte Black PL-116 Matte Nickel		PL-210 Anodized Aluminum		PL-115 Matte Black PL-116 Matte Nickel		PL-210 Anodized Aluminum	

## Product features.

- Anti-tip safety feature
- Full extension drawers - locking
- Soft close suspension drawer(s)
- Standard Silver Feet (optional White, Black)

### NOTES

- Unit not designed for open plan use. Select OPB for Open Plan application

## Options.

### DRAWER

- P33: Wood Drawer Upgrade - \$45 per drawer
- WPD3061: Designer White - \$80 per pedestal

### FEET

- D8: Delete feet (extend fronts to floor) - n/c

### FLUSH CUT

- FC-B: Flush Unit Both Sides(Facing) for Ganging - \$55
- FC-L: Flush Unit Left (Facing) for Ganging - \$55
- FC-R: Flush Unit Right(Facing) for Ganging - \$55

### OPEN PLAN – FINISHED BACK

- OPB: "W" "G" Style - Modify Unit for Open Plan Application - \$295

### PREMIUM FINISH OPTION

- Specify foot metal finish color - \$160 per unit. Contact customer service
- MFB: Black, MFW: White

# NOT SO square office.

Workstation Credenzas  
File/File

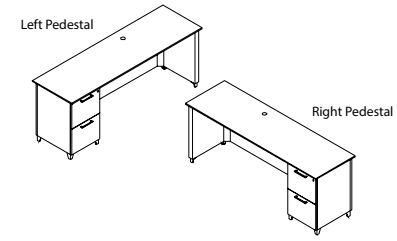

## 1 Select a model

w" x d" x h"

weight	Standard Veneer Top Standard Veneer Chassis		Premium Veneer Top Premium Veneer Chassis		High Pressure Laminate Top Veneer Chassis		Thermally Fused Laminate Top Thermally Fused Laminate Chassis	
<b>Left Pedestal</b>								
89 x 22 x 29	220	NSS8922CA086W 3442	NSS8922CA086P 3787	NSS8922CA086G 3442	NSS8922CA086M 2191			
84 x 22 x 29	210	NSS8422CA086W 3386	NSS8422CA086P 3725	NSS8422CA086G 3386	NSS8422CA086M 2043			
72 x 22 x 29	200	NSS7222CA086W 3127	NSS7222CA086P 3440	NSS7222CA086G 3127	NSS7222CA086M 1892			
66 x 22 x 29	190	NSS6622CA086W 3094	NSS6622CA086P 3404	NSS6622CA086G 3094	NSS6622CA086M 1844			
<b>Right Pedestal</b>								
89 x 22 x 29	220	NSS8922CA087W 3442	NSS8922CA087P 3787	NSS8922CA087G 3442	NSS8922CA087M 2191			
84 x 22 x 29	210	NSS8422CA087W 3386	NSS8422CA087P 3725	NSS8422CA087G 3386	NSS8422CA087M 2043			
72 x 22 x 29	200	NSS7222CA087W 3127	NSS7222CA087P 3440	NSS7222CA087G 3127	NSS7222CA087M 1892			
66 x 22 x 29	190	NSS6622CA087W 3094	NSS6622CA087P 3404	NSS6622CA087G 3094	NSS6622CA087M 1844			

View statement of line

## 2 Select a finish

View finish details

WAC	WGW
WRC	WBW
WIC	WSW
WEC	WNW
WHC	WWP
WOC	
WAM	
WCM	
WWW	
WEW	

Metal finish  
MFS Silver. Additional metal finishes are available, see options.

## 3 Select an edge

View edge details



## 4 Select hardware

View hardware details

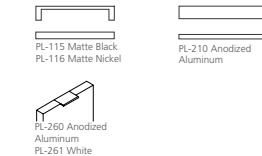
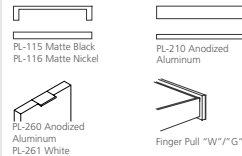
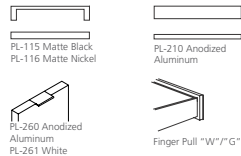
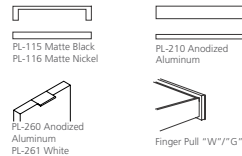

## Product features.

- Full modesty back
- Full extension drawers - locking
- Outfeed hole standard in back of credenza
- Soft close suspension drawer(s)
- Standard metal grommet matches pull finish
- Standard Silver Feet (optional White, Black)

### NOTES

- Laminated version "M" standard w/ open plan back
- Unit not designed for open plan use. Select OPB for Open Plan application

## Options.

### ACCESSORIES

- K28: Articulating Keyboard w/ Mouse - \$390

### DRAWER

- P6: Modify File/File to Box/Box/File - \$55 per pedestal
- P33: Wood Drawer Upgrade - \$45 per drawer
- P40W: extra Box/Box/File or File/File to Knee space - \$910
- P40M: extra Box/Box/File or File/File to Knee space - \$720
- WPD3061: Designer White - \$80 per door

### FEET

- D8: Delete feet (extend fronts to floor) - n/c

### FLUSH CUT

- FC-B: Flush Unit Both Sides(Facing) for Ganging - \$55
- FC-L: Flush Unit Left (Facing) for Ganging - \$55
- FC-R: Flush Unit Right(Facing) for Ganging - \$55

### GROMMETS (NON-STANDARD LOCATION)

Provide drawing w/ Grommet Location and Specify Color - \$95 ea.

- Black: TM30-NS
- Silver: TM31-NS
- White: TM34-NS

### Modesty

- M34T: "W" "G" Style Drop Door Tech Modesty - \$130
- M34TM: "M" Style Drop Door Tech Modesty - \$130
- M51: Open Back Modesty with Wire Mgmt Rail - Deduct \$95

### Open Plan - Finished Back

- OPB: "W" "G" Style - Modify Unit for Open Plan Application - \$195 Premium Finish Option

- Specify foot metal finish color - \$160 per unit. Contact customer service

- MFB: Black, MFW: White

# NOT SO square office.

Workstation Credenzas  
Lateral File

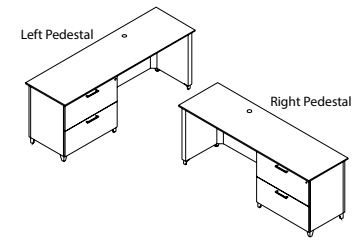

1 Select a model  
w" x d" x h"

weight	Standard Veneer Top Standard Veneer Chassis		Premium Veneer Top Premium Veneer Chassis		High Pressure Laminate Top Veneer Chassis		Thermally Fused Laminate Top Thermally Fused Laminate Chassis	
<b>Left Pedestal</b>								
95 x 22 x 29	265	NSS9522CA066W 3617	NSS9522CA066P 3979	NSS9522CA066G 3617	NSS9522CA066M 2414			
89 x 22 x 29	250	NSS8922CA066W 3578	NSS8922CA066P 3936	NSS8922CA066G 3578	NSS8922CA066M 2294			
84 x 22 x 29	240	NSS8422CA066W 3465	NSS8422CA066P 3812	NSS8422CA066G 3465	NSS8422CA066M 2154			
72 x 22 x 29	230	NSS7222CA066W 3240	NSS7222CA066P 3564	NSS7222CA066G 3240	NSS7222CA066M 2012			
66 x 22 x 29	215	NSS6622CA066W 3206	NSS6622CA066P 3527	NSS6622CA066G 3206	NSS6622CA066M 1966			
<b>Right Pedestal</b>								
95 x 22 x 29	265	NSS9522CA067W 3617	NSS9522CA067P 3979	NSS9522CA067G 3617	NSS9522CA067M 2414			
89 x 22 x 29	250	NSS8922CA067W 3578	NSS8922CA067P 3936	NSS8922CA067G 3578	NSS8922CA067M 2294			
84 x 22 x 29	240	NSS8422CA067W 3465	NSS8422CA067P 3812	NSS8422CA067G 3465	NSS8422CA067M 2154			
72 x 22 x 29	230	NSS7222CA067W 3240	NSS7222CA067P 3564	NSS7222CA067G 3240	NSS7222CA067M 2012			
66 x 22 x 29	215	NSS6622CA067W 3206	NSS6622CA067P 3527	NSS6622CA067G 3206	NSS6622CA067M 1966			

View statement of line

2 Select a finish  
View finish details

Metal finish  
MFS Silver. Additional metal finishes are available, see options.

- WAC WGW
- WRC WBW
- WIC WSW
- WEC WNW
- WHC WWP
- WOC
- WAM
- WCM
- WWW
- WEW

- TBCO
- TBSW
- TSTV
- TSMV
- TSLV
- TOBV
- WBO
- WMO
- WSO

- GAC GNW
- GIC GSTV +10%
- GEC GSLV +10%
- GHC GWL
- GOC
- GAM
- GCM
- GWM
- GEW

- MAC
- MEC
- MHC
- MOC
- MGW
- MTW
- MSW
- MWL

3 Select a edge  
View edge details



4 Select hardware  
View hardware details

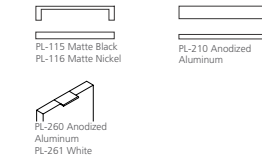
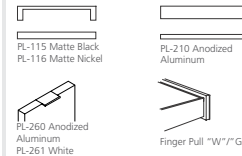
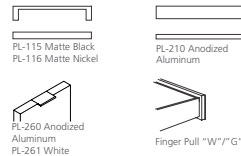
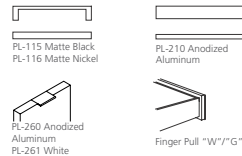

## Product features.

- All drawers lock
- File drawers extend 100% with cushion in-out stops - full access
- Full modesty back
- Outfeed hole standard in back of credenza
- Soft close suspension drawer(s)
- Standard metal grommet matches pull finish
- Standard Silver Feet (optional White, Black)

### NOTES

- 96, 90, 84 W units have 35W lateral
- 72 and 66 W units have 29W lateral
- Keyboard not available on 66"W Lateral File/Multi-File Units
- Unit not designed for open plan use. Select OPB for Open Plan application

## Options.

### ACCESSORIES

- K28: Articulating Keyboard w/ Mouse - \$390

### DRAWER

- P33: Wood Drawer Upgrade - \$45 per drawer
- P40W: extra Box/Box/File or File/File to Knee space - \$910 (n/a on 66")
- P40M: extra Box/Box/File or File/File to Knee space - \$720 (n/a on 66")
- WPD3061: Designer White - \$80 per door

### FEET

- D8: Delete feet (extend fronts to floor) - n/c

### FLUSH CUT

- FC-B: Flush Unit Both Sides(Facing) for Ganging - \$55
- FC-L: Flush Unit Left (Facing) for Ganging - \$55
- FC-R: Flush Unit Right(Facing) for Ganging - \$55

### GROMMETS (NON-STANDARD LOCATION)

- Provide drawing w/ Grommet Location and Specify Color - \$95 ea.
- Black: TM30-NS
  - Silver: TM31-NS
  - White: TM34-NS

### Modesty

- M34T: "W" "G" Style Drop Door Tech Modesty - \$130
- M34TM: "M" Style Drop Door Tech Modesty - \$130
- M51: Open Back Modesty with Wire Mgmt Rail - Deduct \$95

### Open Plan - Finished Back

- OPB: "W" "G" Style - Modify Unit for Open Plan Application - \$195

### Premium Finish Option

- Specify foot metal finish color - \$160 per unit. Contact customer service

- MFB: Black, MFW: White

# NOT SO square office.

Workstation Credenzas  
Multi-File

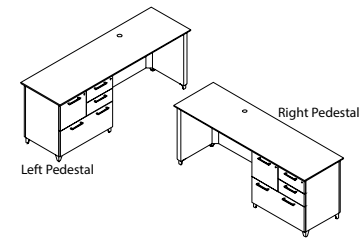

## 1 Select a model

w" x d" x h"

weight	Standard Veneer Top Standard Veneer Chassis		Premium Veneer Top Premium Veneer Chassis		High Pressure Laminate Top Veneer Chassis		Thermally Fused Laminate Top Thermally Fused Laminate Chassis	
	<b>Left Pedestal</b>							
95 x 22 x 29	265	NSS9522CA667W 3700	NSS9522CA667P 4070	NSS9522CA667G 3700	NSS9522CA667M 2436			
89 x 22 x 29	250	NSS8922CA667W 3662	NSS8922CA667P 4029	NSS8922CA667G 3662	NSS8922CA667M 2403			
84 x 22 x 29	240	NSS8422CA667W 3550	NSS8422CA667P 3905	NSS8422CA667G 3550	NSS8422CA667M 2264			
72 x 22 x 29	230	NSS7222CA667W 3324	NSS7222CA667P 3657	NSS7222CA667G 3324	NSS7222CA667M 2121			
*66 x 22 x 29	215	NSS6622CA667W 3291	NSS6622CA667P 3621	NSS6622CA667G 3291	NSS6622CA667M 2075			
<b>Right Pedestal</b>								
95 x 22 x 29	265	NSS9522CA668W 3700	NSS9522CA668P 4070	NSS9522CA668G 3700	NSS9522CA668M 2436			
89 x 22 x 29	250	NSS8922CA668W 3662	NSS8922CA668P 4029	NSS8922CA668G 3662	NSS8922CA668M 2403			
84 x 22 x 29	240	NSS8422CA668W 3550	NSS8422CA668P 3905	NSS8422CA668G 3550	NSS8422CA668M 2264			
72 x 22 x 29	230	NSS7222CA668W 3324	NSS7222CA668P 3657	NSS7222CA668G 3324	NSS7222CA668M 2121			
*66 x 22 x 29	215	NSS6622CA668W 3291	NSS6622CA668P 3621	NSS6622CA668G 3291	NSS6622CA668M 2075			

View statement of line

## 2 Select a finish

View finish details

Metal finish  
MFS Silver. Additional metal finishes are available, see options.

WAC	WGW
WRC	WBW
WIC	WSW
WEC	WNW
WHC	WWP
WOC	
WAM	
WCM	
WWW	
WEW	

## 3 Select a edge

View edge details



## 4 Select hardware

View hardware details

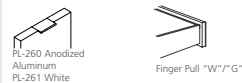

## Product features.

- Full modesty back
- Full extension drawers - locking
- Outfeed hole standard in back of credenza
- Soft close suspension drawer(s)
- Standard metal grommet matches pull finish
- Standard Silver Feet (optional White, Black)

### NOTES

- Keyboard not available on 66"W Lateral File/Multi-File Units
- Unit not designed for open plan use. Select OPB for Open Plan application

## Options.

### ACCESSORIES

- K28: Articulating Keyboard w/ Mouse - \$390

### DRAWER

- P33: Wood Drawer Upgrade - \$45 per drawer
- P40W: extra Box/Box/File or File/File to Knee space - \$910 (n/a on 66")
- P40M: extra Box/Box/File or File/File to Knee space - \$720 (n/a on 66")
- WPD3061: Designer White - \$80 per door

### FEET

- D8: Delete feet (extend fronts to floor) - n/c

### FLUSH CUT

- FC-B: Flush Unit Both Sides(Facing) for Ganging - \$55
- FC-L: Flush Unit Left (Facing) for Ganging - \$55
- FC-R: Flush Unit Right(Facing) for Ganging - \$55

### GROMMETS (NON-STANDARD LOCATION)

Provide drawing w/ Grommet Location and Specify Color - \$95 ea.

- Black: TM30-NS
- Silver: TM31-NS
- White: TM34-NS

### Modesty

- M34T: "W" "G" Style Drop Door Tech Modesty - \$130
- M34TM: "M" Style Drop Door Tech Modesty - \$130
- M51: Open Back Modesty with Wire Mgmt Rail - Deduct \$95
- Open Plan - Finished Back
- OPB: "W" "G" Style - Modify Unit for Open Plan Application - \$195
- Premium Finish Option

- Specify foot metal finish color - \$160 per unit. Contact customer service

- MFB: Black, MFW: White



# NOT SO square office.

Bench Cabinets  
One / Two / Three Section Storage

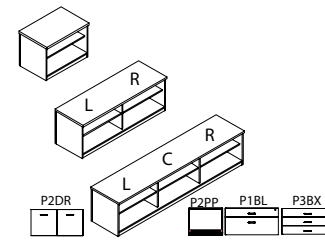

1 Select a model w" x d" x h"	weight	Standard Veneer Top Standard Veneer Chassis		Premium Veneer Top Premium Veneer Chassis		High Pressure Laminate Top Veneer Chassis		Thermally Fused Laminate Top Thermally Fused Laminate Chassis	
		<b>Three Section</b> 93.5 x 20 x 23 87.5 x 20 x 23	300 290	NSS9320CA063W NSS8720CA063W	3538 3274	NSS9320CA063P NSS8720CA063P	3892 3602	NSS9320CA063G NSS8720CA063G	3538 3274
<b>Two Section</b> 70.5 x 20 x 23 58.5 x 20 x 23	225 210	NSS7020CA063W NSS5820CA063W	2340 2205	NSS7020CA063P NSS5820CA063P	2574 2426	NSS7020CA063G NSS5820CA063G	2340 2205	NSS7020CA063M NSS5820CA063M	1737 1612
<b>One Section</b> 35.5 x 20 x 23 29.5 x 20 x 23	95 90	NSS3520CA063W NSS2920CA063W	1231 1198	NSS3520CA063P NSS2920CA063P	1355 1318	NSS3520CA063G NSS2920CA063G	1231 1198	NSS3520CA063M NSS2920CA063M	710 679

2 Select a finish <i>View finish details</i>	Standard Veneer Top		Premium Veneer Top		High Pressure Laminate Top		Thermally Fused Laminate Top	
	WAC WRC WIC WEC WHC WOC WAM WCM WWW WEW	WGW WBW WSW WNW WWP	TBCO TBSW TSTV TSMV TSLV TOBW WBO WMO WSO	GAC GIC GEC GHC GOC GAM GCM GWM GEW	GNW GSTV +10% GSLV +10% GWL	MAC MEC MHC MOC MGW MTW MSW MWL	Edge N/A	Edge N/A

4 Select hardware <i>View hardware details</i>	Standard Veneer Top		Premium Veneer Top		High Pressure Laminate Top		Thermally Fused Laminate Top	
	Hardware N/A	Hardware N/A	Hardware N/A	Hardware N/A	Hardware N/A	Hardware N/A	Hardware N/A	Hardware N/A

[View statement of line](#)

## Product features.

- 1 1/8" top with flat edges
- Open plan - back
- Standard open storage with shelves

### NOTES

- To use Runoff Desk with Bench Cabinets, order Bench Runoff Support Ends: see Runoff Desk
- Bench Cushion Top factory installed as specified
- Standard without legs
- For drawers, storage and printer cabinets select options below

## Options.

### CABINET

- P1BL: Box/Lateral File - \$315 M / \$620 W
- P2DR: Storage Door - \$185 M / \$290 W
- P2PP: Open Printer Pullout - \$235 M / \$340 W
- P3BX: Three Box Drawers - \$315 M / \$515 W

### CUSHION

- BC20: Bench Cushion
- Specify location, number of cushions and fabric grade.
- Cushions sold individually w/a max width 35" (to match storage section depth). 29" W requires .75 yd., 35" W requires 1 yd.

### FEET

- MTL50: 4 Silver Feet - \$205

### GROMMETS (STANDARD LOCATION)

- Specify Color and Location (Right/Left/Center) - \$50 ea.
- Black: TM30-R (Right), TM30-L (Left), TM30-C (Center)
- Silver: TM31-R (Right), TM31-L (Left), TM31-C (Center)
- White: TM34-R (Right), TM34-L (Left), TM34-C (Center)

### GROMMETS (NON-STANDARD LOCATION)

- Provide drawing w/ Grommet Location and Specify Color - \$95 ea.
- Black: TM30-NS
- Silver: TM31-NS
- White: TM34-NS
- Grommets (Vertical Surface)
- Standard Location - \$50 ea.
- Black Plastic Vertical Surface: TM50-C (Bottom Center)
- Non-Standard Location - \$95 ea.
- Black Plastic Vertical Surface: TM50-NS
- Shelf
- S714F: Heavy Duty Lumber 1" Shelves - \$80 per shelf ("M" Styles - n/a)

## BC20 Bench Cushion fabric grades.

COM	COL	1	2	3
282	301	319	337	355
4	5	6	7	8
373	391	409	427	445
9	10	11/ L1	12	13/ L2
463	481	499	517	553

# NOT SO square office.

Freestanding Mobile Pedestal  
Mobile Pedestal - Under Surface

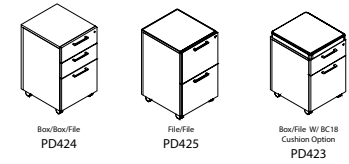

1 Select a model w" x d" x h"	weight	Standard Veneer Top Standard Veneer Chassis		Premium Veneer Top Premium Veneer Chassis		High Pressure Laminate Top Veneer Chassis		Thermally Fused Laminate Top Thermally Fused Laminate Chassis	
		<b>Box/Box/File</b> 16 x 18 x 27	90	NSS1618PD424W	1171	NSS1618PD424P	1289	"G" Option N/A	NSS1618PD424M
<b>File/File</b> 16 x 18 x 27	90	NSS1618PD425W	1171	NSS1618PD425P	1289	"G" Option N/A	NSS1618PD425M	1154	
<b>BOX/FILE</b> 16 x 18 x 27	90	NSS1618PD423W	1080	NSS1618PD423P	1188	"G" Option N/A	NSS1618PD423M	945	

2 Select a finish <i>View finish details</i>	Metal finish MFS Silver. Additional metal finishes are available, see options.		TBCO		MAC	
	WAC	WGW	TBSW	MEC	MHC	MOC
WRC	WBW	TSTV	MHW	MOC	MGW	
WIC	WSW	TSMV	MTW	MSW	MWL	
WEC	WNW	TSLV	WBO			
WHC	WWP	TOBW	WMO			
WOC		WBO	WSO			
WAM		WBO				
WCM		WMO				
WWW		WSO				
WEW						

3 Select an edge <i>View edge details</i>	Edge		Edge		Edge	
	N/A		N/A		N/A	

4 Select hardware <i>View hardware details</i>	PL-115 Matte Black PL-116 Matte Nickel		PL-210 Anodized Aluminum		PL-115 Matte Black PL-116 Matte Nickel		PL-210 Anodized Aluminum	
	PL-260 Anodized Aluminum PL-261 White	Finger Pull "W"/"G"	PL-260 Anodized Aluminum PL-261 White	Finger Pull "W"/"G"	PL-260 Anodized Aluminum PL-261 White	Finger Pull "W"/"G"	PL-260 Anodized Aluminum PL-261 White	Finger Pull "W"/"G"

*View statement of line*

## Product features.

- Anti-tip safety feature
- For open plan use under surfaces
- Full extension drawers - locking
- Soft close suspension drawer(s)

### NOTES

- Pedestal Cushion can be specified on all pedestals, but on Box/ Box/ File and File/File unit will not fit under work surface w/ cushion.

## Options.

### CUSHION

- BC16: Bench Cushion
- Specify fabric grade (1 yd. required)

### DRAWER

- P33: Wood Drawer Upgrade - \$45 per drawer
- WPD3061: Designer White - \$80 per pedestal

### PREMIUM FINISH OPTION

- Specify foot metal finish color - \$30 per foot
- MFB: Black, MFW: White

## BC16 Cushion fabric grades.

COM	COL	1	2	3
224	243	261	279	297
4	5	6	7	8
315	333	351	369	387
9	10	11/ L1	12	13/ L2
405	423	441	459	495

# NOT SO square office.

Single Storage Overhead Consoles  
Panel Door - 6/4/2 Door

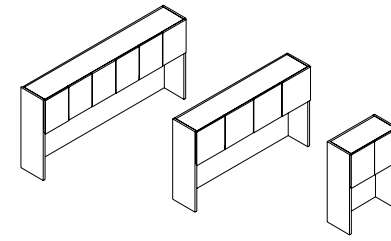

1 Select a model w" x d" x h"	weight	Standard Veneer Top Standard Veneer Chassis		Premium Veneer Top Premium Veneer Chassis		High Pressure Laminate Top Veneer Chassis		Thermally Fused Laminate Top Thermally Fused Laminate Chassis	
		<b>6 Door / 3 Section</b>							
93 x 14 x 42	315	NSS9342OH325W	3583	NSS9342OH325P	3942	"G" Option N/A	NSS9342OH325M	2390	
87 x 14 x 42	285	NSS8742OH325W	3454	NSS8742OH325P	3800	"G" Option N/A	NSS8742OH325M	2259	
<b>4 Door / 2 Section</b>									
83 x 14 x 42	275	NSS8342OH325W	3139	NSS8342OH325P	3453	"G" Option N/A	NSS8342OH325M	1839	
76 x 14 x 42	255	NSS7642OH325W	2924	NSS7642OH325P	3217	"G" Option N/A	NSS7642OH325M	1768	
70 x 14 x 42	240	NSS7042OH325W	2711	NSS7042OH325P	2983	"G" Option N/A	NSS7042OH325M	1510	
64 x 14 x 42	225	NSS6442OH325W	2644	NSS6442OH325P	2909	"G" Option N/A	NSS6442OH325M	1445	
58 x 14 x 42	210	NSS5842OH325W	2576	NSS5842OH325P	2834	"G" Option N/A	NSS5842OH325M	1389	
47 x 14 x 42	190	NSS4742OH325W	2442	NSS4742OH325P	2687	"G" Option N/A	NSS4742OH325M	1266	
<b>2 Door / 1 Section</b>									
35 x 14 x 42	120	NSS3542OH325W	1597	NSS3542OH325P	1757	"G" Option N/A	NSS3542OH325M	812	
29 x 14 x 42	105	NSS2942OH325W	1553	NSS2942OH325P	1709	"G" Option N/A	NSS2942OH325M	772	
<b>2 Select a finish</b> <i>View finish details</i>		WAC	WGW	TBCO			MAC		
		WRC	WBW	TBSW			MEC		
		WIC	WSW	TSTV			MHC		
		WEC	WNW	TSMV			MOC		
		WHC	WWP	TSLV			MGW		
		WOC		TOBW			MTW		
		WAM		WBO			MSW		
		WCM		WMO			MWL		
		WWW		WSO					
		WEW							
<b>3 Select a edge</b> <i>View edge details</i>		Edge		Edge			Edge		
		N/A		N/A			N/A		
<b>4 Select hardware</b> <i>View hardware details</i>		Hardware		Hardware			Hardware		
		N/A		N/A			N/A		

[View statement of line](#)

## Product features.

- Finished top
- Interior cabinet depth 12.5"
- Panel doors with concealed finger pull

### NOTES

- Unit has black back panel and is not designed for Open Plan use.
- Select OPB Option for Open Plan application

## Options.

### DOOR

- D2: Door Lock - \$100 per door set
- D6: Delete Doors - n/c
- D9SC: Soft Close Door Hinges - \$20 per door
- WPD3061: Designer White - \$80 per door

### GROMMETS (VERTICAL SURFACE)

- Standard Location - \$50 ea.
- Black Plastic Vertical Surface: TM50-C (Bottom Center)
- Non-Standard Location - \$95 ea.
- Black Plastic Vertical Surface: TM50-NS

### INTERIOR CABINET LIGHTING

- LEDPK starter kit includes Infeed, 1 Puck Interior Light and the ability to daisy chain up to 6 total Puck Lights
- LED Puck Starter Kit - \$310
- PK: 1 LED Interior Light - \$130

### TASK LIGHTING (RECESSED)

- Overhead tasklight cord is located on the right facing side. If the opposite location is required please contact customer service.
- LT-LED24R: 24" LED Task light - \$190
- LT-LED48R: 48" LED Task light - \$245
- LT-LED60R: 60" LED Task light - \$310
- LT-LED72R: 72" LED Task light - \$335

### OPEN PLAN – FINISHED BACK

- OPB: "W" "G" Style - Modify Unit for Open Plan Application - \$295
- OPBM: "M" Style - Modify Unit for Open Plan Application - \$95

# NOT SO square office.

Single Storage Overhead Consoles  
Silverluma Frame Doors / 6/4/2 Door

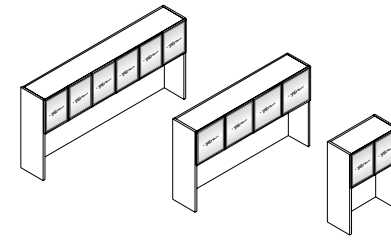

1 Select a model w" x d" x h"	weight	Standard Veneer Top Standard Veneer Chassis		Premium Veneer Top Premium Veneer Chassis		High Pressure Laminate Top Veneer Chassis		Thermally Fused Laminate Top Thermally Fused Laminate Chassis	
		<b>6 Door / 3 Section</b> 93 x 14 x 42 87 x 14 x 42	315 285	NSS9342OH321W NSS8742OH321W	4022 3921	NSS9342OH321P NSS8742OH321P	4425 4314	"G" Option N/A "G" Option N/A	NSS9342OH321M NSS8742OH321M
<b>4 Door / 2 Section</b> 83 x 14 x 42 76 x 14 x 42 70 x 14 x 42 64 x 14 x 42 58 x 14 x 42 47 x 14 x 42	275 255 240 225 210 190	NSS8342OH321W NSS7642OH321W NSS7042OH321W NSS6442OH321W NSS5842OH321W NSS4742OH321W	3870 3363 3127 3005 2924 2818	NSS8342OH321P NSS7642OH321P NSS7042OH321P NSS6442OH321P NSS5842OH321P NSS4742OH321P	4257 3700 3440 3306 3217 3100	"G" Option N/A "G" Option N/A "G" Option N/A "G" Option N/A "G" Option N/A "G" Option N/A	NSS8342OH321M NSS7642OH321M NSS7042OH321M NSS6442OH321M NSS5842OH321M NSS4742OH321M	2083 2013 1757 1693 1636 1513	
<b>2 Door / 1 Section</b> 35 x 14 x 42 29 x 14 x 42	120 105	NSS3542OH321W NSS2942OH321W	1812 1705	NSS3542OH321P NSS2942OH321P	1994 1876	"G" Option N/A "G" Option N/A	NSS3542OH321M NSS2942OH321M	936 895	
<b>2 Select a finish</b> <i>View finish details</i>		WAC WRC WIC WEC WHC WOC WAM WCM WWW WEW	WGW WBW WSW WNW WWP	TBCO TBSW TSTV TSMV TSLV TOBW WBO WMO WSO			MAC MEC MHC MOC MGW MTW MSW MWL		
<b>3 Select a edge</b> <i>View edge details</i>		Edge N/A		Edge N/A			Edge N/A		
<b>4 Select hardware</b> <i>View hardware details</i>		Hardware N/A		Hardware N/A			Hardware N/A		

[View statement of line](#)

## Product features.

- Finished top
- Interior cabinet depth 12.5"
- SilverLuma frame doors with frosted acrylic inserts

### NOTES

- Unit has black back panel and is not designed for Open Plan use.
- Select OPB Option for Open Plan application

## Options.

### DOOR

- D2: Door Lock - \$100 per door set
- D6: Delete Doors - n/c
- D9SC: Soft Close Door Hinges - \$20 per door

### GROMMETS (VERTICAL SURFACE)

- Standard Location - \$50 ea.
- Black Plastic Vertical Surface: TM50-C (Bottom Center)
- Non-Standard Location - \$95 ea.
- Black Plastic Vertical Surface: TM50-NS

### INTERIOR CABINET LIGHTING

- LEDPK starter kit includes Infeed, 1 Puck Interior Light and the ability to daisy chain up to 6 total Puck Lights
- LED Puck Starter Kit - \$310
- PK: 1 LED Interior Light - \$130

### TASK LIGHTING (RECESSED)

- Overhead tasklight cord is located on the right facing side. If the opposite location is required please contact customer service.
- LT-LED24R: 24" LED Task light - \$190
- LT-LED48R: 48" LED Task light - \$245
- LT-LED60R: 60" LED Task light - \$310
- LT-LED72R: 72" LED Task light - \$335

### OPEN PLAN – FINISHED BACK

- OPB: "W" "G" Style - Modify Unit for Open Plan Application - \$295
- OPBM: "M" Style - Modify Unit for Open Plan Application - \$95

# NOT SO square office.

Single Storage Overhead Consoles  
Open Storage Console

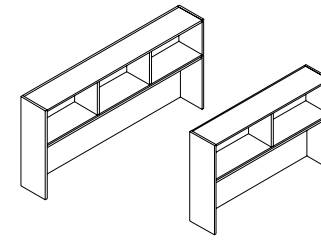

1 Select a model w" x d" x h"	weight	Standard Veneer Top Standard Veneer Chassis		Premium Veneer Top Premium Veneer Chassis		High Pressure Laminate Top Veneer Chassis		Thermally Fused Laminate Top Thermally Fused Laminate Chassis	
		<b>3 Section</b> 93 x 14 x 42 87 x 14 x 42 83 x 14 x 42 76 x 14 x 42 <b>2 Section</b> 70 x 14 x 42 64 x 14 x 42 58 x 14 x 42	310 280 265 250 240 225 205	NSS9342OH346W NSS8742OH346W NSS8342OH346W NSS7642OH346W NSS7042OH346W NSS6442OH346W NSS5842OH346W	3274 3240 3212 2767 2554 2492 2452	NSS9342OH346P NSS8742OH346P NSS8342OH346P NSS7642OH346P NSS7042OH346P NSS6442OH346P NSS5842OH346P	3602 3564 3534 3044 2810 2742 2698	"G" Option N/A "G" Option N/A "G" Option N/A "G" Option N/A "G" Option N/A "G" Option N/A "G" Option N/A	NSS9342OH346M NSS8742OH346M NSS8342OH346M NSS7642OH346M NSS7042OH346M NSS6442OH346M NSS5842OH346M
<b>2 Select a finish</b> <i>View finish details</i>	WAC WRC WIC WEC WHC WOC WAM WCM WWM WEW	WGW WBW WSW WNW WWP	TBCO TBSW TSTV TSMV TSLV TOBW WBO WMO WSO	Edge N/A	Edge N/A	MAC MEC MHC MOC MGW MTW MSW MWL	Edge N/A	Hardware N/A	Hardware N/A
<b>4 Select hardware</b> <i>View hardware details</i>	Hardware N/A	Hardware N/A	Hardware N/A	Hardware N/A	Hardware N/A	Hardware N/A	Hardware N/A	Hardware N/A	Hardware N/A

[View statement of line](#)

## Product features.

- Finished top
- Interior cabinet depth 12.5"

### NOTES

- 1 or 2 optional door available
- Sliding Doors Will Not Pass Each Other
- Unit has black back panel and is not designed for Open Plan use.
- Select OPB Option for Open Plan application

## Options.

### GROMMETS (VERTICAL SURFACE)

- Standard Location - \$50 ea.
- Black Plastic Vertical Surface: TM50-C (Bottom Center)
- Non-Standard Location - \$95 ea.
- Black Plastic Vertical Surface: TM50-NS

### INTERIOR CABINET LIGHTING

- LEDPK starter kit includes Infeed, 1 Puck Interior Light and the ability to daisy chain up to 6 total Puck Lights
- LED Puck Starter Kit - \$310
- PK: 1 LED Interior Light - \$130

### OPEN PLAN – FINISHED BACK

- OPB: "W" "G" Style - Modify Unit for Open Plan Application - \$295
- OPBM: "M" Style - Modify Unit for Open Plan Application - \$95

### SLIDING DOOR

- SLD17LD: Laminate Door - \$205 per door
- SLD17FD: SilverLuma / Frost Door ("W", "M" only) - \$365 per door
- SLD17WD: Wood Door - \$260 per door

### TASK LIGHTING (RECESSED)

- Overhead tasklight cord is located on the right facing side. If the opposite location is required please contact customer service.
- LT-LED24R: 24" LED Task light - \$190
- LT-LED48R: 48" LED Task light - \$245
- LT-LED60R: 60" LED Task light - \$310
- LT-LED72R: 72" LED Task light - \$335

# NOT SO square office.

Double Height Overhead Consoles  
Panel Door

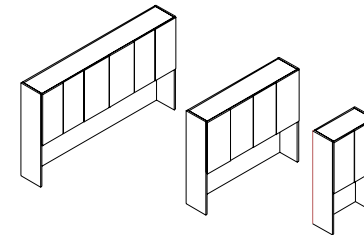

1 Select a model w" x d" x h"	weight	Standard Veneer Top Standard Veneer Chassis		Premium Veneer Top Premium Veneer Chassis		High Pressure Laminate Top Veneer Chassis		Thermally Fused Laminate Top Thermally Fused Laminate Chassis																																									
		<p><b>6 Door / 3 Section</b></p> <p>93 x 14 x 54    300    NSS9354OH325W    4072    NSS9354OH325P    4480    "G" Option N/A    NSS9354OH325M    2911</p> <p>87 x 14 x 54    290    NSS8754OH325W    3949    NSS8754OH325P    4344    "G" Option N/A    NSS8754OH325M    2799</p> <p>83 x 14 x 54    280    NSS8354OH325W    3892    NSS8354OH325P    4282    "G" Option N/A    NSS8354OH325M    2254</p> <p><b>4 Door / 2 Section</b></p> <p>70 x 14 x 54    250    NSS7054OH325W    3313    NSS7054OH325P    3645    "G" Option N/A    NSS7054OH325M    2034</p> <p>64 x 14 x 54    230    NSS6454OH325W    3127    NSS6454OH325P    3440    "G" Option N/A    NSS6454OH325M    1965</p> <p>58 x 14 x 54    215    NSS5854OH325W    3037    NSS5854OH325P    3341    "G" Option N/A    NSS5854OH325M    1697</p> <p><b>2 Door / 1 Section</b></p> <p>35 x 14 x 54    160    NSS3554OH325W    1865    NSS3554OH325P    2052    "G" Option N/A    NSS3554OH325M    1109</p> <p>29 x 14 x 54    150    NSS2954OH325W    1799    NSS2954OH325P    1979    "G" Option N/A    NSS2954OH325M    1073</p>																																															
<p><b>2 Select a finish</b> <i>View finish details</i></p> <table border="0"> <tr> <td>WAC</td><td>WGW</td><td>TBCO</td><td>MAC</td> </tr> <tr> <td>WRC</td><td>WBW</td><td>TBSW</td><td>MEC</td> </tr> <tr> <td>WIC</td><td>WSW</td><td>TSTV</td><td>MHC</td> </tr> <tr> <td>WEC</td><td>WNW</td><td>TSMV</td><td>MOC</td> </tr> <tr> <td>WHC</td><td>WWP</td><td>TSLV</td><td>MGW</td> </tr> <tr> <td>WOC</td><td></td><td>TOBW</td><td>MTW</td> </tr> <tr> <td>WAM</td><td></td><td>WBO</td><td>MSW</td> </tr> <tr> <td>WCM</td><td></td><td>WMO</td><td>MWL</td> </tr> <tr> <td>WWM</td><td></td><td>WSO</td><td></td> </tr> <tr> <td>WEW</td><td></td><td></td><td></td> </tr> </table>										WAC	WGW	TBCO	MAC	WRC	WBW	TBSW	MEC	WIC	WSW	TSTV	MHC	WEC	WNW	TSMV	MOC	WHC	WWP	TSLV	MGW	WOC		TOBW	MTW	WAM		WBO	MSW	WCM		WMO	MWL	WWM		WSO		WEW			
WAC	WGW	TBCO	MAC																																														
WRC	WBW	TBSW	MEC																																														
WIC	WSW	TSTV	MHC																																														
WEC	WNW	TSMV	MOC																																														
WHC	WWP	TSLV	MGW																																														
WOC		TOBW	MTW																																														
WAM		WBO	MSW																																														
WCM		WMO	MWL																																														
WWM		WSO																																															
WEW																																																	
<p><b>3 Select a edge</b> <i>View edge details</i></p> <table border="0"> <tr> <td>Edge</td><td></td><td>Edge</td><td>Edge</td> </tr> <tr> <td>N/A</td><td></td><td>N/A</td><td>N/A</td> </tr> </table>										Edge		Edge	Edge	N/A		N/A	N/A																																
Edge		Edge	Edge																																														
N/A		N/A	N/A																																														
<p><b>4 Select hardware</b> <i>View hardware details</i></p> <table border="0"> <tr> <td>Hardware</td><td></td><td>Hardware</td><td>Hardware</td> </tr> <tr> <td>N/A</td><td></td><td>N/A</td><td>N/A</td> </tr> </table>										Hardware		Hardware	Hardware	N/A		N/A	N/A																																
Hardware		Hardware	Hardware																																														
N/A		N/A	N/A																																														

[View statement of line](#)

## Product features.

- Finished top
- 1 Adjustable shelf behind each door section
- Interior cabinet depth 12.5"
- Interior shelf depth 12"
- Panel doors with concealed finger pull

### NOTES

- Unit has black back panel and is not designed for Open Plan use.
- Select OPB Option for Open Plan application.

## Options.

### DOOR

- D2: Door Lock - \$100 per door set
- D6: Delete Doors - n/c
- D9SC: Soft Close Door Hinges - \$20 per door
- WPD3061: Designer White - \$80 per door

### GROMMETS (VERTICAL SURFACE)

- Standard Location - \$50 ea.
- Black Plastic Vertical Surface: TM50-C (Bottom Center)
- Non-Standard Location - \$95 ea.
- Black Plastic Vertical Surface: TM50-NS

### INTERIOR CABINET LIGHTING

- LEDPK starter kit includes Infeed, 1 Puck Interior Light and the ability to daisy chain up to 6 total Puck Lights
- LED Puck Starter Kit - \$310
- PK: 1 LED Interior Light - \$130

### TASK LIGHTING (RECESSED)

- Overhead tasklight cord is located on the right facing side. If the opposite location is required please contact customer service.
- LT-LED24R: 24" LED Task light - \$190
- LT-LED48R: 48" LED Task light - \$245
- LT-LED60R: 60" LED Task light - \$310
- LT-LED72R: 72" LED Task light - \$335

### OPEN PLAN – FINISHED BACK

- OPB: "W" "G" Style - Modify Unit for Open Plan Application - \$295
- OPBM: "M" Style - Modify Unit for Open Plan Application - \$95 Shelf
- GS14H: Replace Standard Shelves with Glass Shelves - \$70 per shelf
- S714F: Heavy Duty Lumber 1" Shelves - \$80 per shelf ("M" Styles - n/a)

# NOT SO square office.

Double Height Overhead Consoles  
Silverluma Frame 6/4/2 Doors

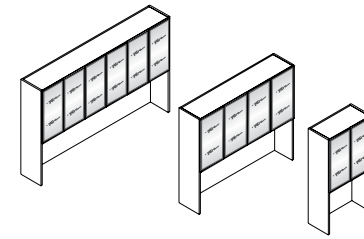

1 Select a model w" x d" x h"	weight	Standard Veneer Top Standard Veneer Chassis		Premium Veneer Top Premium Veneer Chassis		High Pressure Laminate Top Veneer Chassis		Thermally Fused Laminate Top Thermally Fused Laminate Chassis	
		<b>6 Door / 3 Section</b> 93 x 14 x 54 87 x 14 x 54 <b>4 Door / 2 Section</b> 70 x 14 x 54 64 x 14 x 54 58 x 14 x 54 <b>2 Door / 1 Section</b> 35 x 14 x 54 29 x 14 x 54	300 290 250 230 215 160 150	NSS9354OH321W NSS8754OH321W NSS7054OH321W NSS6454OH321W NSS5854OH321W NSS3554OH321W NSS2954OH321W	4995 4791 4162 3685 3515 2228 2081	NSS9354OH321P NSS8754OH321P NSS7054OH321P NSS6454OH321P NSS5854OH321P NSS3554OH321P NSS2954OH321P	5495 5271 4579 4054 3867 2451 2290	"G" Option N/A "G" Option N/A "G" Option N/A "G" Option N/A "G" Option N/A "G" Option N/A	NSS9354OH321M NSS8754OH321M NSS7054OH321M NSS6454OH321M NSS5854OH321M NSS3554OH321M NSS2954OH321M
2 Select a finish <i>View finish details</i>	WAC WRC WIC WEC WHC WOC WAM WCM WWM WEW	WGW WBW WSW WNW WWP	TBCO TBSW TSTV TSMV TSLV TOBW WBO WMO WSO	Edge N/A	Edge N/A	MAC MEC MHC MOC MGW MTW MSW MWL	Edge N/A	Hardware N/A	Hardware N/A
3 Select a edge <i>View edge details</i>	Edge N/A								
4 Select hardware <i>View hardware details</i>	Hardware N/A								

*View statement of line*

## Product features.

- Finished top
- 1 Adjustable shelf per section standard
- Interior cabinet depth 12.5"
- Interior shelf depth 12"
- Silverluma doors w/ frosted acrylic inserts

### NOTES

- Unit has black back panel and is not designed for Open Plan use.
- Select OPB Option for Open Plan application.

## Options.

### DOOR

- D2: Door Lock - \$100 per door set
- D6: Delete Doors - n/c
- D9SC: Soft Close Door Hinges - \$20 per door

### GROMMETS (VERTICAL SURFACE)

- Standard Location - \$50 ea.
- Black Plastic Vertical Surface: TM50-C (Bottom Center)
- Non-Standard Location - \$95 ea.
- Black Plastic Vertical Surface: TM50-NS

### INTERIOR CABINET LIGHTING

- LEDPK starter kit includes Infeed, 1 Puck Interior Light and the ability to daisy chain up to 6 total Puck Lights
- LED Puck Starter Kit - \$310
- PK: 1 LED Interior Light - \$130

### TASK LIGHTING (RECESSED)

- Overhead tasklight cord is located on the right facing side. If the opposite location is required please contact customer service.
- LT-LED24R: 24" LED Task light - \$190
- LT-LED48R: 48" LED Task light - \$245
- LT-LED60R: 60" LED Task light - \$310
- LT-LED72R: 72" LED Task light - \$335

### OPEN PLAN – FINISHED BACK

- OPB: "W" "G" Style - Modify Unit for Open Plan Application - \$295
- OPBM: "M" Style - Modify Unit for Open Plan Application - \$95 Shelf
- GS14F: Replace Standard Shelves with Glass Shelves - \$90 per shelf
- S714F: Heavy Duty Lumber 1" Shelves - \$80 per shelf ("M" Styles - n/a)

# NSS Office tackboards.

Overhead tackboard  
Full width tackboards

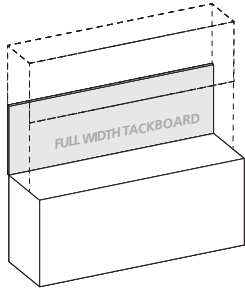

Product Width	Panel Dimension	SKU	COM	1	2	3	4	5	6	7	8	9	10	11/L1	12	13/L2
93	91 x .75 x 21	FTOC9121	379	480	531	582	633	684	735	786	837	888	939	990	1041	1143
87	85 x .75 x 21	FTOC8521	358	449	497	545	593	641	689	737	785	833	881	929	977	1073
83	81 x .75 x 21	FTOC8121	336	428	474	520	566	612	658	704	750	796	842	888	934	1026
76	74 x .75 x 21	FTOC7421	309	392	435	478	521	564	607	650	693	736	779	822	865	951
70	68 x .75 x 21	FTOC6821	282	361	401	441	481	521	561	601	641	681	721	761	801	881
64	62 x .75 x 21	FTOC6221	256	330	366	402	438	474	510	546	582	618	654	690	726	798
58	56 x .75 x 21	FTOC5621	234	299	331	363	395	427	459	491	523	555	587	619	651	715
47	45 x .75 x 21	FTOC4521	187	242	269	296	323	350	377	404	431	458	485	512	539	593
35	33 x .75 x 21	FTOC3321	141	180	200	220	240	260	280	300	320	340	360	380	400	440
29	27 x .75 x 21	FTOC2721	112	149	166	183	200	217	234	251	268	285	302	319	336	370

**Standard Features**

- Constructed of .5" thick fiberboard
- Fabric is precisely aligned and fitted to the tackboard
- Adhered to the rigid hardboard with staples
- Hung with Z-Strip mounting system

**Notes**

- Fabric Tack Panels are raised 3" from bottom edge when TM50 grommet is ordered

Overhead tackboard  
Half width tackboards

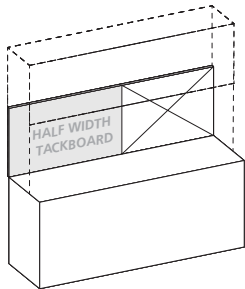

Product Width	Panel Dimension	SKU	COM	1	2	3	4	5	6	7	8	9	10	11/L1	12	13/L2
93 Half Width	45.5 x .75 x 21	FTOC4521	189	240	266	292	318	344	370	396	422	448	474	500	526	578
87 Half Width	42.5 x .75 x 21	FTOC4221	179	225	249	273	297	321	345	369	393	417	441	465	489	537
83 Half Width	40.5 x .75 x 21	FTOC4021	168	214	237	260	283	306	329	352	375	398	421	444	467	513
76 Half Width	37 x .75 x 21	FTOC3721	155	196	217	238	259	280	301	322	343	364	385	406	427	469
70 Half Width	34 x .75 x 21	FTOC3421	141	180	200	220	240	260	280	300	320	340	360	380	400	440
64 Half Width	31 x .75 x 21	FTOC3121	128	165	183	201	219	237	255	273	291	309	327	345	363	399

**Standard Features**

- Constructed of .5" thick fiberboard
- Fabric is precisely aligned and fitted to the tackboard
- Adhered to the rigid hardboard with staples
- Hung with Z-Strip mounting system

**Notes**

- Half width tackboards can be specified and combined with a Veneer Panel, Marker Board, Slat Wall or Glass Board. See "Half Width" items under product width.
- Specify right or left facing tackboard
- Fabric Tack Panels are raised 3" from bottom edge when TM50 grommet is ordered.



## NSS Office tackboards.

Overhead dry marker board  
Full width dry marker board

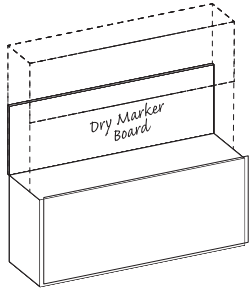

Product Width	Panel Dimension	SKU	List
93	91 x .5 x 21	DMOC9121	1136
87	85 x .5 x 21	DMOC8521	1061
83	81 x .5 x 21	DMOC8121	1011
76	74 x .5 x 21	DMOC7421	924
70	68 x .5 x 21	DMOC6821	849
64	62 x .5 x 21	DMOC6221	774
58	56 x .5 x 21	DMOC5621	699
47	45 x .5 x 21	DMOC4521	587
35	33 x .5 x 21	DMOC3321	437
29	27 x .5 x 21	DMOC2721	337

### Standard Features

- Dry marker panel has edge trim molding
- Standard magnetic surface
- Hung with Z-Strip mounting system

Overhead dry marker board  
Half width dry marker board

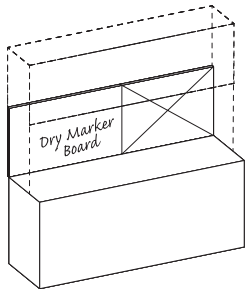

Product Width	Panel Dimension	SKU	List
93 Half Width	45.5 x .5 x 21	DMOC4521	555
87 Half Width	42.5 x .5 x 21	DMOC4221	518
83 Half Width	40.5 x .5 x 21	DMOC4021	493
76 Half Width	37 x .5 x 21	DMOC3721	449
70 Half Width	34 x .5 x 21	DMOC3421	437
64 Half Width	31 x .5 x 21	DMOC3121	374

### Standard Features

- Dry marker panel has edge trim molding
- Standard magnetic surface
- Hung with Z-Strip mounting system

### Notes

- Half width dry marker boards can be specified and combined with a Tackboard, Veneer Panel, Slat Wall or Glass Board. See "Half Width" items under product width.
- Specify right or left facing dry marker board

## NSS Office tackboards.

Overhead glassboard  
Full width glassboard

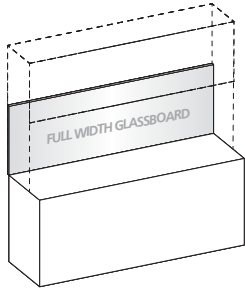

Product Width	Panel Dimension	SKU	List
93	91 x .5 x 21	GBOC9121	2382
87	85 x .5 x 21	GBOC8521	2236
83	81 x .5 x 21	GBOC8121	2138
76	74 x .5 x 21	GBOC7421	1969
70	68 x .5 x 21	GBOC6821	1822
64	62 x .5 x 21	GBOC6221	1676
58	56 x .5 x 21	GBOC5621	1531
47	45 x .5 x 21	GBOC4521	1264
35	33 x .5 x 21	GBOC3321	972
29	27 x .5 x 21	GBOC2721	826

### Standard Features

- 4 mm tempered glass
- Use glass cleaner or alcohol to clean
- Standard dry erase markers may be used

### Notes

- Earth magnets are required to hold items securely in place
- Hung with Z-Strip mounting system
- Use glass cleaner or alcohol to clean
- Standard dry erase markers may be used

Overhead glassboard  
Half width glassboard

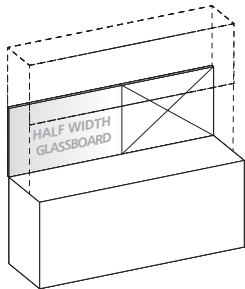

Product Width	Panel Dimension	SKU	List
93 Half Width	45.5 x .5 x 21	GBOC4521	1251
87 Half Width	42.5 x .5 x 21	GBOC4221	1178
83 Half Width	40.5 x .5 x 21	GBOC4021	1129
76 Half Width	37 x .5 x 21	GBOC3721	985
70 Half Width	34 x .5 x 21	GBOC3421	972
64 Half Width	31 x .5 x 21	GBOC3121	899

### Standard Features

- 4 mm tempered glass
- Hung with Z-Strip mounting system

### Notes

- Half width glassboards can be specified and combined with a Tackboard, Veneer panel, Marker Board or Slat Wall. See "Half Width" items under product width.
- Specify right or left facing glassboard
- Use glass cleaner or alcohol to clean
- Standard dry erase markers may be used
- Earth magnets are required to hold items securely in place

## NSS Office tackboards.

Overhead slat wall  
Half width slat wall

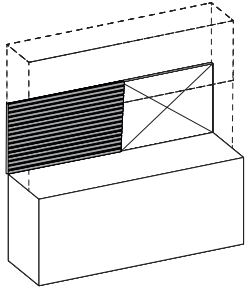

Product Width	Panel Dimension	SKU	List
93 Half Width	45.5 x .5 x 21	SWOC4521	463
87 Half Width	42.5 x .5 x 21	SWOC4221	432
83 Half Width	40.5 x .5 x 21	SWOC4021	411
76 Half Width	37 x .5 x 21	SWOC3721	374
70 Half Width	34 x .5 x 21	SWOC3421	343
64 Half Width	31 x .5 x 21	SWOC3121	300

### Standard Features

- Available in silver or black
- Hung with Z-Strip mounting system

### Notes

- Half width slat walls can be specified and combined with a Tackboard, Veneer panel, Marker Board or Glassboard. See "Half Width" items under product width.
- Specify right or left facing slat wall
- For use on 42"/43" height consoles
- Specify right or left facing slat wall

# NOT SO square office.

Single Height Wall Hung Overheads  
Panel Doors

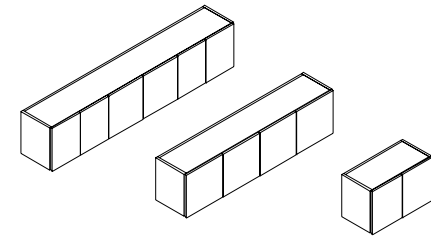

[View statement of line](#)

1 Select a model w" x d" x h"	weight	Standard Veneer Top Standard Veneer Chassis		Premium Veneer Top Premium Veneer Chassis		High Pressure Laminate Top Veneer Chassis		Thermally Fused Laminate Top Thermally Fused Laminate Chassis																																									
		<p><b>6 Door / 3 Section</b></p> <p>93 x 14 x 18    240    NSS9318WH330W    3347    NSS9318WH330P    3682    "G" Option N/A    NSS9318WH330M    2357</p> <p>87 x 14 x 18    225    NSS8718WH330W    3217    NSS8718WH330P    3539    "G" Option N/A    NSS8718WH330M    2228</p> <p><b>4 Door / 2 Section</b></p> <p>83 x 14 x 18    210    NSS8318WH330W    3144    NSS8318WH330P    3459    "G" Option N/A    NSS8318WH330M    1754</p> <p>76 x 14 x 18    195    NSS7618WH330W    3088    NSS7618WH330P    3397    "G" Option N/A    NSS7618WH330M    1626</p> <p>70 x 14 x 18    180    NSS7018WH330W    2581    NSS7018WH330P    2840    "G" Option N/A    NSS7018WH330M    1503</p> <p>64 x 14 x 18    160    NSS6418WH330W    2542    NSS6418WH330P    2797    "G" Option N/A    NSS6418WH330M    1457</p> <p>58 x 14 x 18    135    NSS5818WH330W    2503    NSS5818WH330P    2754    "G" Option N/A    NSS5818WH330M    1412</p> <p>47 x 14 x 18    125    NSS4718WH330W    1913    NSS4718WH330P    2105    "G" Option N/A    NSS4718WH330M    1345</p> <p><b>2 Door / 1 Section</b></p> <p>35 x 14 x 18    75    NSS3518WH330W    1435    NSS3518WH330P    1579    "G" Option N/A    NSS3518WH330M    957</p> <p>29 x 14 x 18    65    NSS2918WH330W    1412    NSS2918WH330P    1554    "G" Option N/A    NSS2918WH330M    917</p>																																															
<p><b>2 Select a finish</b> <a href="#">View finish details</a></p> <table border="0"> <tr> <td>WAC</td><td>WGW</td><td>TBCO</td><td>MAC</td> </tr> <tr> <td>WRC</td><td>WBW</td><td>TBSW</td><td>MEC</td> </tr> <tr> <td>WIC</td><td>WSW</td><td>TSTV</td><td>MHC</td> </tr> <tr> <td>WEC</td><td>WNW</td><td>TSMV</td><td>MOC</td> </tr> <tr> <td>WHC</td><td>WWP</td><td>TSLV</td><td>MGW</td> </tr> <tr> <td>WOC</td><td></td><td>TOBW</td><td>MTW</td> </tr> <tr> <td>WAM</td><td></td><td>WBO</td><td>MSW</td> </tr> <tr> <td>WCM</td><td></td><td>WMO</td><td>MWL</td> </tr> <tr> <td>WWW</td><td></td><td>WSO</td><td></td> </tr> <tr> <td>WEW</td><td></td><td></td><td></td> </tr> </table>										WAC	WGW	TBCO	MAC	WRC	WBW	TBSW	MEC	WIC	WSW	TSTV	MHC	WEC	WNW	TSMV	MOC	WHC	WWP	TSLV	MGW	WOC		TOBW	MTW	WAM		WBO	MSW	WCM		WMO	MWL	WWW		WSO		WEW			
WAC	WGW	TBCO	MAC																																														
WRC	WBW	TBSW	MEC																																														
WIC	WSW	TSTV	MHC																																														
WEC	WNW	TSMV	MOC																																														
WHC	WWP	TSLV	MGW																																														
WOC		TOBW	MTW																																														
WAM		WBO	MSW																																														
WCM		WMO	MWL																																														
WWW		WSO																																															
WEW																																																	
<p><b>3 Select a edge</b> <a href="#">View edge details</a></p> <table border="0"> <tr> <td>Edge</td><td>Edge</td><td>Edge</td><td>Edge</td> </tr> <tr> <td>N/A</td><td>N/A</td><td>N/A</td><td>N/A</td> </tr> </table>										Edge	Edge	Edge	Edge	N/A	N/A	N/A	N/A																																
Edge	Edge	Edge	Edge																																														
N/A	N/A	N/A	N/A																																														
<p><b>4 Select hardware</b> <a href="#">View hardware details</a></p> <table border="0"> <tr> <td>Hardware</td><td>Hardware</td><td>Hardware</td><td>Hardware</td> </tr> <tr> <td>N/A</td><td>N/A</td><td>N/A</td><td>N/A</td> </tr> </table>										Hardware	Hardware	Hardware	Hardware	N/A	N/A	N/A	N/A																																
Hardware	Hardware	Hardware	Hardware																																														
N/A	N/A	N/A	N/A																																														

## Product features.

- Finished top
- Interior cabinet depth 12"
- Mounting wall rail included
- Panel doors with concealed finger pull

### NOTES

- Proper installation is critical to ensure safety from possible falling cabinets. The factory assumes no liability for damage or injury from The following: installation into non-load bearing or unlevel walls. Improper fasteners used in installation. Overloading of cabinets resulting in failures of wall and surrounding structures, fasteners, or cabinet construction. Misuse of cabinets for intended purposes.

## Options.

### DOOR

- D2: Door Lock - \$100 per door set
- D6: Delete Doors - n/c
- D95C: Soft Close Door Hinges - \$20 per door
- WPD3061: Designer White - \$80 per door

### INTERIOR CABINET LIGHTING

- LEDPK starter kit includes Infeed, 1 Puck Interior Light and the ability to daisy chain up to 6 total Puck Lights
- LED Puck Starter Kit - \$310
  - PK: 1 LED Interior Light - \$130

### TASK LIGHTING (RECESSED)

- Overhead tasklight cord is located on the right facing side. If the opposite location is required please contact customer service.
- LT-LED24R: 24" LED Task light - \$190
  - LT-LED48R: 48" LED Task light - \$245
  - LT-LED60R: 60" LED Task light - \$310
  - LT-LED72R: 72" LED Task light - \$335
  - LC24: Linking Task light cable - \$25

# NOT SO square office.

Single Height Wall Hung Overheads  
Silverluma Frame / Doors

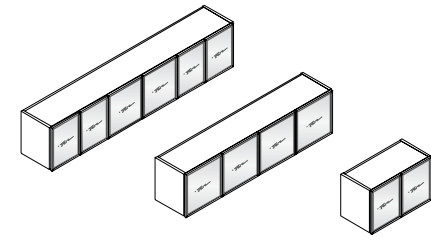

[View statement of line](#)

1 Select a model w" x d" x h"	weight	Standard Veneer Top		Premium Veneer Top		High Pressure Laminate Top		Thermally Fused Laminate Top	
		Standard Veneer Chassis		Premium Veneer Chassis		Veneer Chassis		Thermally Fused Laminate Chassis	
<b>6 Door / 3 Section</b>									
93 x 15 x 18	240	NSS9318WH331W	3785	NSS9318WH331P	4164	"G" Option N/A		NSS9318WH331M	2767
87 x 15 x 18	225	NSS8718WH331W	3712	NSS8718WH331P	4084	"G" Option N/A		NSS8718WH331M	2638
<b>4 Door / 2 Section</b>									
83 x 15 x 18	210	NSS8318WH331W	3633	NSS8318WH331P	3997	"G" Option N/A		NSS8318WH331M	2031
76 x 15 x 18	195	NSS7618WH331W	3583	NSS7618WH331P	3942	"G" Option N/A		NSS7618WH331M	1901
70 x 15 x 18	180	NSS7018WH331W	2992	NSS7018WH331P	3292	"G" Option N/A		NSS7018WH331M	1772
64 x 15 x 18	160	NSS6418WH331W	2897	NSS6418WH331P	3187	"G" Option N/A		NSS6418WH331M	1727
58 x 15 x 18	135	NSS5818WH331W	2807	NSS5818WH331P	3088	"G" Option N/A		NSS5818WH331M	1682
47 x 15 x 18	125	NSS4718WH331W	2147	NSS4718WH331P	2362	"G" Option N/A		NSS4718WH331M	1620
<b>2 Door / 1 Section</b>									
35 x 15 x 18	75	NSS3518WH331W	1637	NSS3518WH331P	1801	"G" Option N/A		NSS3518WH331M	1069
29 x 15 x 18	65	NSS2918WH331W	1564	NSS2918WH331P	1721	"G" Option N/A		NSS2918WH331M	1030
<b>2 Select a finish</b> <a href="#">View finish details</a>		WAC	WGW	TBCO				MAC	
		WRC	WBW	TBSW				MEC	
		WIC	WSW	TSTV				MHC	
		WEC	WNW	TSMV				MOC	
		WHC	WWP	TSLV				MGW	
		WOC		TOBW				MTW	
		WAM		WBO				MSW	
		WCM		WMO				MWL	
		WWW		WSO					
		WEW							
<b>3 Select a edge</b> <a href="#">View edge details</a>		Edge		Edge				Edge	
		N/A		N/A				N/A	
<b>4 Select hardware</b> <a href="#">View hardware details</a>		Hardware		Hardware				Hardware	
		N/A		N/A				N/A	

## Product features.

- Finished top
- Interior cabinet depth 12"
- Mounting wall rail included
- Silverluma doors w/ frosted acrylic inserts

### NOTES

- Proper installation is critical to ensure safety from possible falling cabinets. The factory assumes no liability for damage or injury from The following: installation into non-load bearing or unlevel walls. Improper fasteners used in installation. Overloading of cabinets resulting in failures of wall and surrounding structures, fasteners, or cabinet construction. Misuse of cabinets for intended purposes.

## Options.

### DOOR

- D2: Door Lock - \$100 per door set
- D6: Delete Doors - n/c
- D95C: Soft Close Door Hinges - \$20 per door

### INTERIOR CABINET LIGHTING

LEDPK starter kit includes Infeed, 1 Puck Interior Light and the ability to daisy chain up to 6 total Puck Lights

- LED Puck Starter Kit - \$310
- PK: 1 LED Interior Light - \$130

### TASK LIGHTING (RECESSED)

Overhead tasklight cord is located on the right facing side. If the opposite location is required please contact customer service.

- LT-LED24R: 24" LED Task light - \$190
- LT-LED48R: 48" LED Task light - \$245
- LT-LED60R: 60" LED Task light - \$310
- LT-LED72R: 72" LED Task light - \$335
- LC24: Linking Task light cable - \$25

# NOT SO square office.

Single Height Wall Hung Overheads  
Open Storage Cabinet

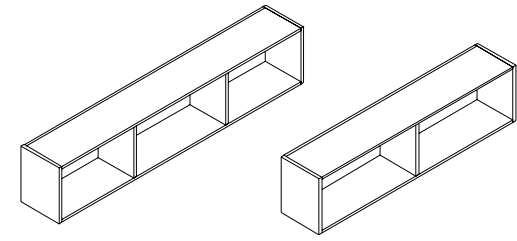

1 Select a model w" x d" x h"	weight	Standard Veneer Top		Premium Veneer Top		High Pressure Laminate Top		Thermally Fused Laminate Top	
		Standard Veneer Chassis		Premium Veneer Chassis		Veneer Chassis		Thermally Fused Laminate Chassis	
<b>3 Section</b>									
93 x 14 x 18	225	NSS9318WH332W	3083	NSS9318WH332P	3392	"G" Option N/A	NSS9318WH332M	1999	
87 x 14 x 18	210	NSS8718WH332W	3054	NSS8718WH332P	3360	"G" Option N/A	NSS8718WH332M	1870	
83 x 14 x 18	200	NSS8318WH332W	3026	NSS8318WH332P	3329	"G" Option N/A	NSS8318WH332M	1402	
76 x 14 x 18	185	NSS7618WH332W	2992	NSS7618WH332P	3292	"G" Option N/A	NSS7618WH332M	1331	
<b>2 Section</b>									
70 x 14 x 18	170	NSS7018WH332W	2447	NSS7018WH332P	2692	"G" Option N/A	NSS7018WH332M	1262	
64 x 14 x 18	150	NSS6418WH332W	2408	NSS6418WH332P	2649	"G" Option N/A	NSS6418WH332M	1220	
58 x 14 x 18	125	NSS5818WH332W	2374	NSS5818WH332P	2612	"G" Option N/A	NSS5818WH332M	1173	
47 x 14 x 18	115	NSS4718WH332W	1772	NSS4718WH332P	1950	"G" Option N/A	NSS4718WH332M	1106	
<b>1 Section</b>									
35 x 14 x 18	60	NSS3518WH332W	1333	NSS3518WH332P	1467	"G" Option N/A	NSS3518WH332M	825	
29 x 14 x 18	50	NSS2918WH332W	1317	NSS2918WH332P	1449	"G" Option N/A	NSS2918WH332M	786	
<b>2 Select a finish</b> <i>View finish details</i>									
		WAC	WGW	TBCO			MAC		
		WRC	WBW	TBSW			MEC		
		WIC	WSW	TSTV			MHC		
		WEC	WNW	TSMV			MOC		
		WHC	WWP	TSLV			MGW		
		WOC		TOBW			MTW		
		WAM		WBO			MSW		
		WCM		WMO			MWL		
		WWW		WSO					
		WEW							
<b>3 Select an edge</b> <i>View edge details</i>									
		Edge		Edge			Edge		
		N/A		N/A			N/A		
<b>4 Select hardware</b> <i>View hardware details</i>									
		Hardware		Hardware			Hardware		
		N/A		N/A			N/A		

*View statement of line*

## Product features.

- Finished top
- Interior cabinet depth 12"
- Mounting wall rail included

### NOTES

- Proper installation is critical to ensure safety from possible falling cabinets. The factory assumes no liability for damage or injury from the following: installation into non-load bearing or unlevel walls. Improper fasteners used in installation. Overloading of cabinets resulting in failures of wall and surrounding structures, fasteners, or cabinet construction. Misuse of cabinets for intended purposes.
- Sliding doors will not pass each other

## Options.

### SLIDING DOOR

- SLD17LD: Laminate Door - \$205 per door
- SLD17FD: SilverLuma / Frost Door ("W", "M" only) - \$365 per door
- SLD17WD: Wood Door - \$260 per door

### INTERIOR CABINET LIGHTING

- LEDPK starter kit includes Infeed, 1 Puck Interior Light and the ability to daisy chain up to 6 total Puck Lights
- LED Puck Starter Kit - \$310
- PK: 1 LED Interior Light - \$130

### TASK LIGHTING (RECESSED)

- Overhead tasklight cord is located on the right facing side. If the opposite location is required please contact customer service.
- LT-LED24R: 24" LED Task light - \$190
- LT-LED48R: 48" LED Task light - \$245
- LT-LED60R: 60" LED Task light - \$310
- LT-LED72R: 72" LED Task light - \$335
- LC24: Linking Task light cable - \$25

# NOT SO square office.

Double Height Wall Hung Overheads  
Panel Doors

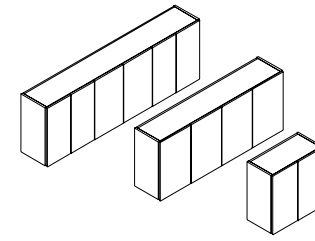

1 Select a model w" x d" x h"	weight	Standard Veneer Top Standard Veneer Chassis		Premium Veneer Top Premium Veneer Chassis		High Pressure Laminate Top Veneer Chassis		Thermally Fused Laminate Top Thermally Fused Laminate Chassis																																									
		<p><b>6 Door / 3 Section</b></p> <p>93 x 14 x 29    265    NSS9329WH330W    3892    NSS9329WH330P    4282    "G" Option N/A    NSS9329WH330M    2896</p> <p>87 x 14 x 29    250    NSS8729WH330W    3830    NSS8729WH330P    4213    "G" Option N/A    NSS8729WH330M    2767</p> <p><b>4 Door / 2 Section</b></p> <p>83 x 14 x 29    235    NSS8329WH330W    3774    NSS8329WH330P    4152    "G" Option N/A    NSS8329WH330M    2048</p> <p>70 x 14 x 29    220    NSS7029WH330W    3183    NSS7029WH330P    3502    "G" Option N/A    NSS7029WH330M    1941</p> <p>64 x 14 x 29    200    NSS6429WH330W    3156    NSS6429WH330P    3472    "G" Option N/A    NSS6429WH330M    1899</p> <p>58 x 14 x 29    180    NSS5829WH330W    3094    NSS5829WH330P    3404    "G" Option N/A    NSS5829WH330M    1822</p> <p><b>2 Door / 1 Section</b></p> <p>35 x 14 x 29    85    NSS3529WH330W    1671    NSS3529WH330P    1839    "G" Option N/A    NSS3529WH330M    1305</p> <p>29 x 14 x 29    75    NSS2929WH330W    1632    NSS2929WH330P    1796    "G" Option N/A    NSS2929WH330M    1266</p>																																															
<p><b>2 Select a finish</b> <i>View finish details</i></p> <table border="0"> <tr> <td>WAC</td><td>WGW</td><td>TBCO</td><td>MAC</td> </tr> <tr> <td>WRC</td><td>WBW</td><td>TBSW</td><td>MEC</td> </tr> <tr> <td>WIC</td><td>WSW</td><td>TSTV</td><td>MHC</td> </tr> <tr> <td>WEC</td><td>WNW</td><td>TSMV</td><td>MOC</td> </tr> <tr> <td>WHC</td><td>WWP</td><td>TSLV</td><td>MGW</td> </tr> <tr> <td>WOC</td><td></td><td>TOBW</td><td>MTW</td> </tr> <tr> <td>WAM</td><td></td><td>WBO</td><td>MSW</td> </tr> <tr> <td>WCM</td><td></td><td>WMO</td><td>MWL</td> </tr> <tr> <td>WWM</td><td></td><td>WSO</td><td></td> </tr> <tr> <td>WEW</td><td></td><td></td><td></td> </tr> </table>										WAC	WGW	TBCO	MAC	WRC	WBW	TBSW	MEC	WIC	WSW	TSTV	MHC	WEC	WNW	TSMV	MOC	WHC	WWP	TSLV	MGW	WOC		TOBW	MTW	WAM		WBO	MSW	WCM		WMO	MWL	WWM		WSO		WEW			
WAC	WGW	TBCO	MAC																																														
WRC	WBW	TBSW	MEC																																														
WIC	WSW	TSTV	MHC																																														
WEC	WNW	TSMV	MOC																																														
WHC	WWP	TSLV	MGW																																														
WOC		TOBW	MTW																																														
WAM		WBO	MSW																																														
WCM		WMO	MWL																																														
WWM		WSO																																															
WEW																																																	
<p><b>3 Select a edge</b> <i>View edge details</i></p> <table border="0"> <tr> <td>Edge</td><td></td><td>Edge</td><td>Edge</td> </tr> <tr> <td>N/A</td><td></td><td>N/A</td><td>N/A</td> </tr> </table>										Edge		Edge	Edge	N/A		N/A	N/A																																
Edge		Edge	Edge																																														
N/A		N/A	N/A																																														
<p><b>4 Select hardware</b> <i>View hardware details</i></p> <table border="0"> <tr> <td>Hardware</td><td></td><td>Hardware</td><td>Hardware</td> </tr> <tr> <td>N/A</td><td></td><td>N/A</td><td>N/A</td> </tr> </table>										Hardware		Hardware	Hardware	N/A		N/A	N/A																																
Hardware		Hardware	Hardware																																														
N/A		N/A	N/A																																														

*View statement of line*

## Product features.

- 1 Adjustable shelf per section standard
- Black painted top
- Interior cabinet depth 12"
- Interior shelf depth 11.5"
- Mounting rails included
- Panel doors with concealed finger pull

### NOTES

- Proper installation is critical to ensure safety from possible falling cabinets. The factory assumes no liability for damage or injury from The following: installation into non-load bearing or unlevel walls. Improper fasteners used in installation. Overloading of cabinets resulting in failures of wall and surrounding structures, fasteners, or cabinet construction. Misuse of cabinets for intended purposes.

## Options.

### DOOR

- D2: Door Lock - \$100 per door set
- D6: Delete Doors - n/c
- D95C: Soft Close Door Hinges - \$20 per door
- WPD3061: Designer White - \$80 per door

### INTERIOR CABINET LIGHTING

LEDPK starter kit includes Infeed, 1 Puck Interior Light and the ability to daisy chain up to 6 total Puck Lights

- LED Puck Starter Kit - \$310
- PK: 1 LED Interior Light - \$130

### TASK LIGHTING (RECESSED)

Overhead tasklight cord is located on the right facing side. If the opposite location is required please contact customer service.

- LT-LED24R: 24" LED Task light - \$190
- LT-LED48R: 48" LED Task light - \$245
- LT-LED60R: 60" LED Task light - \$310
- LT-LED72R: 72" LED Task light - \$335
- LC24: Linking Task light cable - \$25

### SHELF

- GS14F: Replace Standard Shelves with Glass Shelves - \$90 per shelf
- S714F: Heavy Duty Lumber 1" Shelves - \$80 per shelf ("M" Styles - n/a)

# NOT SO square office.

Double Height Wall Hung Overheads  
Silverluma Frame / Doors

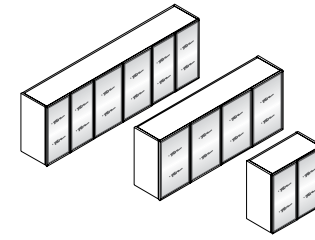

1 Select a model w" x d" x h"	weight	Standard Veneer Top Standard Veneer Chassis		Premium Veneer Top Premium Veneer Chassis		High Pressure Laminate Top Veneer Chassis		Thermally Fused Laminate Top Thermally Fused Laminate Chassis																																									
		<p><b>6 Door / 3 Section</b></p> <p>93 x 14 x 29    265    NSS9329WH331W    4809    NSS9329WH331P    5290    "G" Option N/A    NSS9329WH331M    3579</p> <p>87 x 14 x 29    250    NSS8729WH331W    4663    NSS8729WH331P    5130    "G" Option N/A    NSS8729WH331M    3451</p> <p><b>4 Door / 2 Section</b></p> <p>70 x 14 x 29    220    NSS7029WH331W    3819    NSS7029WH331P    4201    "G" Option N/A    NSS7029WH331M    2200</p> <p>64 x 14 x 29    200    NSS6429WH331W    3718    NSS6429WH331P    4090    "G" Option N/A    NSS6429WH331M    2354</p> <p>58 x 14 x 29    180    NSS5829WH331W    3572    NSS5829WH331P    3930    "G" Option N/A    NSS5829WH331M    2278</p> <p><b>2 Door / 1 Section</b></p> <p>35 x 14 x 29    85    NSS3529WH331W    2025    NSS3529WH331P    2228    "G" Option N/A    NSS3529WH331M    1526</p> <p>29 x 14 x 29    75    NSS2929WH331W    1913    NSS2929WH331P    2105    "G" Option N/A    NSS2929WH331M    1493</p>																																															
<p><b>2 Select a finish</b> <i>View finish details</i></p> <table border="0"> <tr> <td>WAC</td><td>WGW</td><td>TBCO</td><td>MAC</td> </tr> <tr> <td>WRC</td><td>WBW</td><td>TBSW</td><td>MEC</td> </tr> <tr> <td>WIC</td><td>WSW</td><td>TSTV</td><td>MHC</td> </tr> <tr> <td>WEC</td><td>WNW</td><td>TSMV</td><td>MOC</td> </tr> <tr> <td>WHC</td><td>WWP</td><td>TSLV</td><td>MGW</td> </tr> <tr> <td>WOC</td><td></td><td>TOBW</td><td>MTW</td> </tr> <tr> <td>WAM</td><td></td><td>WBO</td><td>MSW</td> </tr> <tr> <td>WCM</td><td></td><td>WMO</td><td>MWL</td> </tr> <tr> <td>WWM</td><td></td><td>WSO</td><td></td> </tr> <tr> <td>WEW</td><td></td><td></td><td></td> </tr> </table>										WAC	WGW	TBCO	MAC	WRC	WBW	TBSW	MEC	WIC	WSW	TSTV	MHC	WEC	WNW	TSMV	MOC	WHC	WWP	TSLV	MGW	WOC		TOBW	MTW	WAM		WBO	MSW	WCM		WMO	MWL	WWM		WSO		WEW			
WAC	WGW	TBCO	MAC																																														
WRC	WBW	TBSW	MEC																																														
WIC	WSW	TSTV	MHC																																														
WEC	WNW	TSMV	MOC																																														
WHC	WWP	TSLV	MGW																																														
WOC		TOBW	MTW																																														
WAM		WBO	MSW																																														
WCM		WMO	MWL																																														
WWM		WSO																																															
WEW																																																	
<p><b>3 Select an edge</b> <i>View edge details</i></p> <table border="0"> <tr> <td>Edge</td><td></td><td>Edge</td><td>Edge</td> </tr> <tr> <td>N/A</td><td></td><td>N/A</td><td>N/A</td> </tr> </table>										Edge		Edge	Edge	N/A		N/A	N/A																																
Edge		Edge	Edge																																														
N/A		N/A	N/A																																														
<p><b>4 Select hardware</b> <i>View hardware details</i></p> <table border="0"> <tr> <td>Hardware</td><td></td><td>Hardware</td><td>Hardware</td> </tr> <tr> <td>N/A</td><td></td><td>N/A</td><td>N/A</td> </tr> </table>										Hardware		Hardware	Hardware	N/A		N/A	N/A																																
Hardware		Hardware	Hardware																																														
N/A		N/A	N/A																																														

[View statement of line](#)

## Product features.

- Black painted top
- Interior cabinet depth 12"
- Interior shelf depth 11.5"
- Mounting rails included
- Silverluma doors w/ frosted acrylic inserts

### NOTES

- 1 Adjustable Shelf per section
- Proper installation is critical to ensure safety from possible falling cabinets. The factory assumes no liability for damage or injury from the following: installation into non-load bearing or unlevel walls. Improper fasteners used in installation. Overloading of cabinets resulting in failures of wall and surrounding structures, fasteners, or cabinet construction. Misuse of cabinets for intended purposes.

## Options.

### DOOR

- D2: Door Lock - \$100 per door set
- D6: Delete Doors - n/c
- D9SC: Soft Close Door Hinges - \$20 per door

### INTERIOR CABINET LIGHTING

- LEDPK starter kit includes Infeed, 1 Puck Interior Light and the ability to daisy chain up to 6 total Puck Lights
- LED Puck Starter Kit - \$310
  - PK: 1 LED Interior Light - \$130

### TASK LIGHTING (RECESSED)

- Overhead tasklight cord is located on the right facing side. If the opposite location is required please contact customer service.
- LT-LED24R: 24" LED Task light - \$190
  - LT-LED48R: 48" LED Task light - \$245
  - LT-LED60R: 60" LED Task light - \$310
  - LT-LED72R: 72" LED Task light - \$335
  - LC24: Linking Task light cable - \$25

### SHELF

- GS14F: Replace Standard Shelves with Glass Shelves - \$90 per shelf
- S714F: Heavy Duty Lumber 1" Shelves - \$80 per shelf ("M" Styles - n/a)



# NOT SO square office.

Double Height Wall Hung Overheads  
Open Storage Cabinet

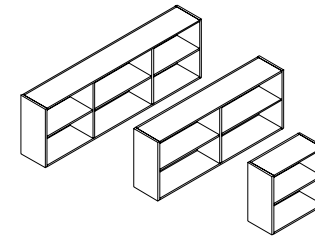

1 Select a model w" x d" x h"	weight	Standard Veneer Top Standard Veneer Chassis		Premium Veneer Top Premium Veneer Chassis		High Pressure Laminate Top Veneer Chassis		Thermally Fused Laminate Top Thermally Fused Laminate Chassis	
		<p><b>3 Section</b></p> <p>93 x 14 x 29    215    NSS9329WH332W    3520    NSS9329WH332P    3872    "G" Option N/A    NSS9329WH332M    2336</p> <p>87 x 14 x 29    200    NSS8729WH332W    3454    NSS8729WH332P    3800    "G" Option N/A    NSS8729WH332M    2206</p> <p>83 x 14 x 29    190    NSS8329WH332W    3391    NSS8329WH332P    3731    "G" Option N/A    NSS8329WH332M    1678</p> <p><b>2 Section</b></p> <p>70 x 14 x 29    180    NSS7029WH332W    2897    NSS7029WH332P    3187    "G" Option N/A    NSS7029WH332M    1560</p> <p>64 x 14 x 29    170    NSS6429WH332W    2840    NSS6429WH332P    3124    "G" Option N/A    NSS6429WH332M    1529</p> <p>58 x 14 x 29    150    NSS5829WH332W    2773    NSS5829WH332P    3051    "G" Option N/A    NSS5829WH332M    1454</p> <p><b>1 Section</b></p> <p>35 x 14 x 29    70    NSS3529WH332W    1548    NSS3529WH332P    1703    "G" Option N/A    NSS3529WH332M    1119</p> <p>29 x 14 x 29    60    NSS2929WH332W    1513    NSS2929WH332P    1665    "G" Option N/A    NSS2929WH332M    1080</p>							
2 Select a finish <i>View finish details</i>		WAC	WGW	TBCO	MAC				
		WRC	WBW	TBSW	MEC				
		WIC	WSW	TSTV	MHC				
		WEC	WNW	TSMV	MOC				
		WHC	WWP	TSLV	MGW				
		WOC		TOBW	MTW				
		WAM		WBO	MSW				
		WCM		WMO	MWL				
		WWW		WSO					
		WEW							
3 Select an edge <i>View edge details</i>		Edge		Edge	Edge				
		N/A		N/A	N/A				
4 Select hardware <i>View hardware details</i>		Hardware		Hardware	Hardware				
		N/A		N/A	N/A				

*View statement of line*

## Product features.

- 1 Adjustable shelf per section
- Black painted top
- Interior cabinet depth 12"
- Interior shelf depth 11.5"
- Mounting rails included

### NOTES

- 1 or 2 Optional Doors Available
- Sliding doors will not pass each other

## Options.

### SLIDING DOOR

- SLD29LD: Laminate Door - \$260 per door
- SLD29FD: SilverLuma / Frost Door ("W", "M" only) - \$415 per door
- SLD29WD: Wood Door - \$310 per door

### TASK LIGHTING (RECESSED)

- Overhead tasklight cord is located on the right facing side. If the opposite location is required please contact customer service.
- LT-LED24R: 24" LED Task light - \$190
  - LT-LED48R: 48" LED Task light - \$245
  - LT-LED60R: 60" LED Task light - \$310
  - LT-LED72R: 72" LED Task light - \$335
  - LC24: Linking Task light cable - \$25

### SHELF

- GS14F: Replace Standard Shelves with Glass Shelves - \$90 per shelf
- S714F: Heavy Duty Lumber 1" Shelves - \$80 per shelf ("M" Styles - n/a)

## NSS Office tackboards.

### Wall hung tackboards Full width tackboards

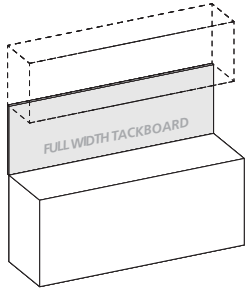

Product Width	Panel Dimension	SKU	COM	1	2	3	4	5	6	7	8	9	10	11/L1	12	13/L2
93"	93 x .75 x 24	FTWH9324	465	576	627	678	729	780	831	882	933	984	1035	1086	1137	1239
87"	87 x .75 x 24	FTWH8724	448	539	587	635	683	731	779	827	875	923	971	1019	1067	1163
83"	83 x .75 x 24	FTWH8324	422	514	560	606	652	698	744	790	836	882	928	974	1020	1112
76"	76 x .75 x 24	FTWH7624	388	471	514	557	600	643	686	729	772	815	858	901	944	1030
70"	70 x .75 x 24	FTWH7024	355	434	474	514	554	594	634	674	714	754	794	834	874	954
64"	64 x .75 x 24	FTWH6424	322	396	432	468	504	540	576	612	648	684	720	756	792	864
58"	58 x .75 x 24	FTWH5824	294	359	391	423	455	487	519	551	583	615	647	679	711	775
47"	47 x .75 x 24	FTWH4724	236	291	318	345	372	399	426	453	480	507	534	561	588	642
35"	35 x .75 x 24	FTWH3524	176	217	237	257	277	297	317	337	357	377	397	417	437	477
29"	29 x .75 x 24	FTWH2924	142	179	196	213	230	247	264	281	298	315	332	349	366	400

#### Standard Features

- Constructed of .5" thick fiberboard
- Fabric is precisely aligned and fitted to the tackboard
- Adhered to the rigid hardboard with staples

### Wall hung tackboards Half width tackboards

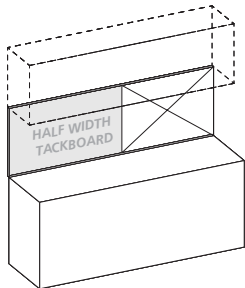

Product Width	Panel Dimension	SKU	COM	1	2	3	4	5	6	7	8	9	10	11/L1	12	13/L2
93 Half Width	46.5 x .75 x 24	FTWH4624	233	288	313	338	363	388	413	438	463	488	513	538	563	613
87 Half Width	43.5 x .75 x 24	FTWH4324	225	270	294	318	342	366	390	414	438	462	486	510	534	582
83 Half Width	41.5 x .75 x 24	FTWH4124	211	257	280	303	326	349	372	395	418	441	464	487	510	556
76 Half Width	38 x .75 x 24	FTWH3824	194	235	256	277	298	319	340	361	382	403	424	445	466	508
70 Half Width	35 x .75 x 24	FTWH3524	178	217	237	257	277	297	317	337	357	377	397	417	437	477
64 Half Width	32 x .75 x 24	FTWH3224	161	198	216	234	252	270	288	306	324	342	360	378	396	432

#### Standard Features

- Constructed of .5" thick fiberboard
- Fabric is precisely aligned and fitted to the tackboard
- Adhered to the rigid hardboard with staples
- Hung with Z-Strip mounting system

#### Notes

- Half width tackboards can be specified and combined with a Veneer Panel, Marker Board, Slat Wall or Glass Board. See "Half Width" items under product width.
- Specify right or left facing tackboard

## NSS Office tackboards.

Wall hung dry marker board  
Full width dry marker board

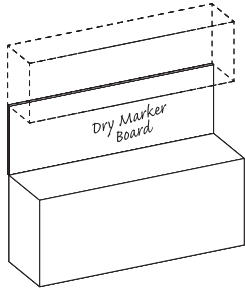

Product Width	Panel Dimension	SKU	List
93	93 x .75 x 24	DMWH9324	1161
87	87 x .75 x 24	DMWH8724	1086
83	83 x .75 x 24	DMWH8324	1023
76	76 x .75 x 24	DMWH7624	948
70	70 x .75 x 24	DMWH7024	874
64	64 x .75 x 24	DMWH6424	799
58	58 x .75 x 24	DMWH5824	724
47	47 x .75 x 24	DMWH4724	587
35	35 x .75 x 24	DMWH3524	437
29	29 x .75 x 24	DMWH2924	362

### Standard Features

- Dry marker panel has edge trim molding
- Standard magnetic surface
- Hung with Z-Strip mounting system

Wall hung dry marker board  
Half width dry marker board

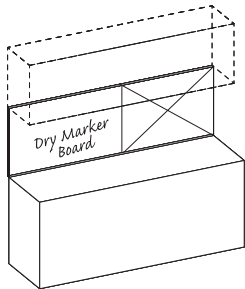

Product Width	Panel Dimension	SKU	List
93 Half Width	46.5 x .75 x 24	DMWH4624	580
87 Half Width	43.5 x .75 x 24	DMWH4324	543
83 Half Width	41.5 x .75 x 24	DMWH4124	518
76 Half Width	38 x .75 x 24	DMWH3824	474
70 Half Width	35 x .75 x 24	DMWH3524	437
64 Half Width	32 x .75 x 24	DMWH3224	399

### Standard Features

- Dry marker panel has edge trim molding
- Standard magnetic surface
- Hung with Z-Strip mounting system

### Notes

- Half width dry marker boards can be specified and combined with a Tackboard, Veneer Panel, Slat Wall or Glass Board. See "Half Width" items under product width.
- Specify right or left facing dry marker board

## NSS Office tackboards.

Wall hung veneer panel  
*Full width veneer panel*

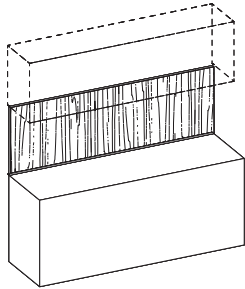

Product Width	Panel Dimension	SKU	List
93	93 x .75 x 24	VPWH9324	967
87	87 x .75 x 24	VPWH8724	905
83	83 x .75 x 24	VPWH8324	853
76	76 x .75 x 24	VPWH7624	790
70	70 x .75 x 24	VPWH7024	728
64	64 x .75 x 24	VPWH6424	666
58	58 x .75 x 24	VPWH5824	603
47	47 x .75 x 24	VPWH4724	489
35	35 x .75 x 24	VPWH3524	364
29	29 x .75 x 24	VPWH2924	302

### Standard Features

- Veneer edges

### Notes

- Vertical wire channels on back for task light cords
- Steel mounting wall channel is recessed for flush mounting
- Hung with Z-Strip mounting system
- Can be used with or without overhead cabinet
- Required for other accessory panels

Wall hung veneer panel  
*Hang width veneer panel*

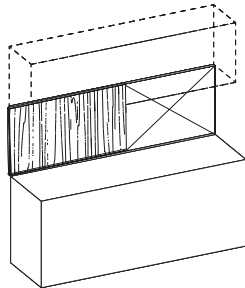

Product Width	Panel Dimension	SKU	List
93 Half Width	46.5 x .75 x 24	VPWH4624	484
87 Half Width	43.5 x .75 x 24	VPWH4324	452
83 Half Width	41.5 x .75 x 24	VPWH4124	432
76 Half Width	38 x .75 x 24	VPWH3824	395
70 Half Width	35 x .75 x 24	VPWH3524	364
64 Half Width	32 x .75 x 24	VPWH3224	333

### Standard Features

- Veneer edges
- Vertical wire channels on back for task light cords
- Steel mounting wall channel is recessed for flush mounting
- Hung with Z-Strip mounting system

### Notes

- Half width veneer panels can be specified and combined with a Tackboard, Marker Board, Slat Wall or Glass Board. See "Half Width" items under product width.
- Specify right or left facing veneer panel
- Can be used with or without overhead cabinet
- Required for other accessory panels

## NSS Office tackboards.

Wall hung glassboard  
Full width glassboards

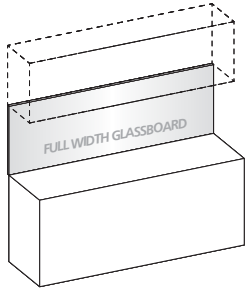

Product Width	Panel Dimension	SKU	List
93	93 x .75 x 24	GBWH9324	2753
87	87 x .75 x 24	GBWH8724	2586
83	83 x .75 x 24	GBWH8324	2475
76	76 x .75 x 24	GBWH7624	2281
70	70 x .75 x 24	GBWH7024	2114
64	64 x .75 x 24	GBWH6424	1948
58	58 x .75 x 24	GBWH5824	1780
47	47 x .75 x 24	GBWH4724	1476
35	35 x .75 x 24	GBWH3524	1142
29	29 x .75 x 24	GBWH2924	976

Standard Features  
- 4 mm tempered glass

Notes  
- Earth magnets are required to hold items securely in place  
- Hung with Z-Strip mounting system  
- Use glass cleaner or alcohol to clean  
- Standard dry erase markers may be used

Wall hung glassboard  
Half width glassboards

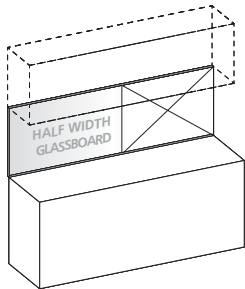

Product Width	Panel Dimension	SKU	List
93 Half Width	46.5 x .75 x 24	GBWH4624	1461
87 Half Width	43.5 x .75 x 24	GBWH4324	1378
83 Half Width	41.5 x .75 x 24	GBWH4124	1323
76 Half Width	38 x .75 x 24	GBWH3824	1232
70 Half Width	35 x .75 x 24	GBWH3524	1142
64 Half Width	32 x .75 x 24	GBWH3224	1059

Standard Features  
- 4 mm tempered glass  
- Hung with Z-Strip mounting system

Notes  
- Half width glassboards can be specified and combined with a Tackboard, Veneer panel, Marker Board or Slat Wall. See "Half Width" items under product width.  
- Must specify Right or left facing glassboard  
- Use glass cleaner or alcohol to clean  
- Standard dry erase markers may be used  
- Earth magnets are required to hold items securely in place

## NSS Office tackboards.

Wall hung slat wall  
Half width slat wall

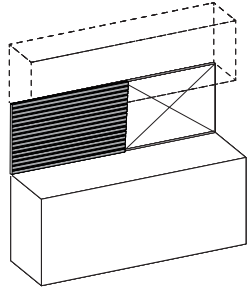

Product Width	Panel Dimension	SKU	List
93 Half Width	46.5 x .75 x 24	SWWH4624	484
87 Half Width	43.5 x .75 x 24	SWWH4324	452
83 Half Width	41.5 x .75 x 24	SWWH4124	432
76 Half Width	38 x .75 x 24	SWWH3824	395
70 Half Width	35 x .75 x 24	SWWH3524	364
64 Half Width	32 x .75 x 24	SWWH3224	333

### Standard Features

- Available in silver or black
- Hung with Z-Strip mounting system

### Notes

- Half width slat walls can be specified and combined with a Tackboard, Veneer panel, Marker Board or Glassboard. See "Half Width" items under product width.
- Specify right or left facing slat wall
- For use on 42"/43" height consoles

# NOT SO square office.

Single Height Wall Hung Overheads  
Open Endless Shelf Single Height

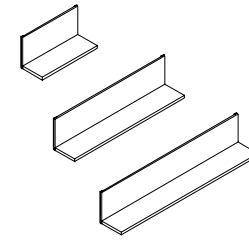

1 Select a model w" x d" x h"	weight	Standard Veneer Top Standard Veneer Chassis		Premium Veneer Top Premium Veneer Chassis		High Pressure Laminate Top Veneer Chassis		Thermally Fused Laminate Top Thermally Fused Laminate Chassis	
		93 x 14 x 18	100	NSS9318WH336W	2711	NSS9318WH336P	2983	"G" Option N/A	NSS9318WH336M
87 x 14 x 18	95	NSS8718WH336W	2542	NSS8718WH336P	2797	"G" Option N/A	NSS8718WH336M	1582	
83 x 14 x 18	90	NSS8318WH336W	2429	NSS8318WH336P	2672	"G" Option N/A	NSS8318WH336M	1531	
76 x 14 x 18	85	NSS7618WH336W	2233	NSS7618WH336P	2457	"G" Option N/A	NSS7618WH336M	1481	
70 x 14 x 18	80	NSS7018WH336W	2065	NSS7018WH336P	2272	"G" Option N/A	NSS7018WH336M	1446	
64 x 14 x 18	75	NSS6418WH336W	1896	NSS6418WH336P	2086	"G" Option N/A	NSS6418WH336M	1357	
58 x 14 x 18	70	NSS5818WH336W	1727	NSS5818WH336P	1900	"G" Option N/A	NSS5818WH336M	1294	
48 x 14 x 18	50	NSS4818WH336W	1497	NSS4818WH336P	1647	"G" Option N/A	NSS4818WH336M	1046	
35 x 14 x 18	35	NSS3518WH336W	1148	NSS3518WH336P	1263	"G" Option N/A	NSS3518WH336M	860	
29 x 14 x 18	30	NSS2918WH336W	980	NSS2918WH336P	1078	"G" Option N/A	NSS2918WH336M	792	
2 Select a finish <i>View finish details</i>		WAC	WGW	TBCO			MAC		
		WRC	WBW	TBSW			MEC		
		WIC	WSW	TSTV			MHC		
		WEC	WNW	TSMV			MOC		
		WHC	WWP	TSLV			MGW		
		WOC		TOBW			MTW		
		WAM		WBO			MSW		
		WCM		WMO			MWL		
		WWW		WSO					
		WEW							
3 Select a edge <i>View edge details</i>		Edge		Edge			Edge		
		N/A		N/A			N/A		
4 Select hardware <i>View hardware details</i>		Hardware		Hardware			Hardware		
		N/A		N/A			N/A		

[View statement of line](#)

## Product features.

- Mounting rails included

### NOTES

- Proper installation is critical to ensure safety from possible falling cabinets. The factory assumes no liability for damage or injury from the following: installation into non-load bearing or unlevel walls. Improper fasteners used in installation. Overloading of cabinets resulting in failures of wall and surrounding structures, fasteners, or cabinet construction. Misuse of cabinets for intended purposes.
- Max load per inch is 3lbs

## Options.

### TASK LIGHTING (RECESSED)

- Overhead tasklight cord is located on the right facing side. If the opposite location is required please contact customer service.
- LT-LED24R: 24" LED Task light - \$190
  - LT-LED48R: 48" LED Task light - \$245
  - LT-LED60R: 60" LED Task light - \$310
  - LT-LED72R: 72" LED Task light - \$335
  - LC24: Linking Task light cable - \$25

# NOT SO square office.

Double Height Wall Hung Overheads  
Open Endless Shelf Double Height

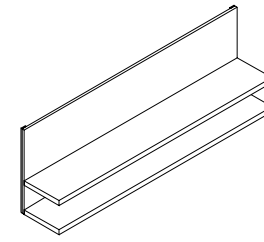

1 Select a model w" x d" x h"	weight	Standard Veneer Top		Premium Veneer Top		High Pressure Laminate Top		Thermally Fused Laminate Top	
		Standard Veneer Chassis		Premium Veneer Chassis		Veneer Chassis		Thermally Fused Laminate Chassis	
93 x 14 x 29	160	NSS9329WH336W	3212	NSS9329WH336P	3534	"G" Option N/A		NSS9329WH336M	1934
87 x 14 x 29	150	NSS8729WH336W	3010	NSS8729WH336P	3311	"G" Option N/A		NSS8729WH336M	1868
83 x 14 x 29	140	NSS8329WH336W	2875	NSS8329WH336P	3163	"G" Option N/A		NSS8329WH336M	1802
76 x 14 x 29	130	NSS7629WH336W	2638	NSS7629WH336P	2902	"G" Option N/A		NSS7629WH336M	1740
70 x 14 x 29	120	NSS7029WH336W	2436	NSS7029WH336P	2680	"G" Option N/A		NSS7029WH336M	1698
64 x 14 x 29	110	NSS6429WH336W	2233	NSS6429WH336P	2457	"G" Option N/A		NSS6429WH336M	1591
58 x 14 x 29	100	NSS5829WH336W	2031	NSS5829WH336P	2235	"G" Option N/A		NSS5829WH336M	1515
48 x 14 x 29	80	NSS4829WH336W	1754	NSS4829WH336P	1930	"G" Option N/A		NSS4829WH336M	1219
35 x 14 x 29	60	NSS3529WH336W	1338	NSS3529WH336P	1472	"G" Option N/A		NSS3529WH336M	994
29 x 14 x 29	50	NSS2929WH336W	1137	NSS2929WH336P	1251	"G" Option N/A		NSS2929WH336M	913
2 Select a finish <i>View finish details</i>		WAC	WGW	TBCO				MAC	
		WRC	WBW	TBSW				MEC	
		WIC	WSW	TSTV				MHC	
		WEC	WNW	TSMV				MOC	
		WHC	WWP	TSLV				MGW	
		WOC		TOBW				MTW	
		WAM		WBO				MSW	
		WCM		WMO				MWL	
		WWW		WSO					
		WEW							
3 Select an edge <i>View edge details</i>		Edge		Edge				Edge	
		N/A		N/A				N/A	
4 Select hardware <i>View hardware details</i>		Hardware		Hardware				Hardware	
		N/A		N/A				N/A	

[View statement of line](#)

## Product features.

- Mounting rails included

### NOTES

- Proper installation is critical to ensure safety from possible falling cabinets. The factory assumes no liability for damage or injury from the following: installation into non-load bearing or unlevel walls. Improper fasteners used in installation. Overloading of cabinets resulting in failures of wall and surrounding structures, fasteners, or cabinet construction. Misuse of cabinets for intended purposes.
- Max load per inch is 6lbs

## Options.

### TASK LIGHTING (RECESSED)

- Overhead tasklight cord is located on the right facing side. If the opposite location is required please contact customer service.
- LT-LED24R: 24" LED Task light - \$190
  - LT-LED48R: 48" LED Task light - \$245
  - LT-LED60R: 60" LED Task light - \$310
  - LT-LED72R: 72" LED Task light - \$335
  - LC24: Linking Task light cable - \$25



# NOT SO square office.

Overhead Bookcases  
Panel Doors / Storage

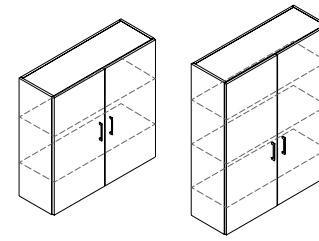

[View statement of line](#)

1 Select a model w" x d" x h"	weight	Standard Veneer Top Standard Veneer Chassis		Premium Veneer Top Premium Veneer Chassis		High Pressure Laminate Top Veneer Chassis		Thermally Fused Laminate Top Thermally Fused Laminate Chassis	
		<b>42" Height</b> 42 x 14 x 42 35 x 14 x 42 29 x 14 x 42 <b>54" Height</b> 42 x 14 x 54 35 x 14 x 54 29 x 14 x 54	150 130 120 165 145 135	NSS4242OH383W NSS3542OH383W NSS2942OH383W NSS4254OH383W NSS3554OH383W NSS2954OH383W	2115 1840 1767 2317 2019 1941	NSS4242OH383P NSS3542OH383P NSS2942OH383P NSS4254OH383P NSS3554OH383P NSS2954OH383P	2327 2024 1944 2549 2221 2136	"G" Option N/A "G" Option N/A "G" Option N/A "G" Option N/A "G" Option N/A "G" Option N/A	NSS4242OH383M NSS3542OH383M NSS2942OH383M NSS4254OH383M NSS3554OH383M NSS2954OH383M
2 Select a finish <a href="#">View finish details</a>	WAC    WGW WRC    WBW WIC    WSW WEC    WNW WHC    WWP WOC WAM WCM WWW WEW	TBCO TBSW TSTV TSMV TSLV TOBW WBO WMO WSO	MAC MEC MHC MOC MGW MTW MSW MWL	Edge N/A	Edge N/A	Edge N/A			
3 Select a edge <a href="#">View edge details</a>	PL-115 Matte Black PL-116 Matte Nickel PL-210 Anodized Aluminum	PL-115 Matte Black PL-116 Matte Nickel PL-210 Anodized Aluminum	PL-115 Matte Black PL-116 Matte Nickel PL-210 Anodized Aluminum	PL-115 Matte Black PL-116 Matte Nickel PL-210 Anodized Aluminum	Touch Latch	Touch Latch	Touch Latch		
4 Select hardware <a href="#">View hardware details</a>									

## Product features.

- 54" H unit has 1 adjustable shelf behind door
- Adjustable shelves (Full Storage), 42" - 2 shelves, 54" - 3 shelves
- Interior shelf depth 12"
- Interior cabinet depth 12.5"
- "W" styles - 42" H units finished top, 54" H units black painted top

### NOTES

- 1 Lock needed
- Unit has black back panel and is not designed for Open Plan use. Select OPB Option for Open Plan application.

## Options.

### DOOR

- D2: Door Lock - \$100 per door set
- D6: Delete Doors - n/c
- D9SC: Soft Close Door Hinges - \$20 per door
- WPD3061: Designer White - \$80 per door

### INTERIOR CABINET LIGHTING

- LEDPK starter kit includes Infeed, 1 Puck Interior Light and the ability to daisy chain up to 6 total Puck Lights
- LED Puck Starter Kit - \$310
- PK: 1 LED Interior Light - \$130

### OPEN PLAN - FINISHED BACK

- OPB: "W" "G" Style - Modify Unit for Open Plan Application - \$295
- OPBM: "M" Style - Modify Unit for Open Plan Application - \$95

### SHELF

- S714F: Heavy Duty Lumber 1" Shelves - \$80 per shelf ("M" Styles - n/a)
- G514F: Replace Standard Shelves with Glass Shelves - \$90 per shelf

# NOT SO square office.

Freestanding Half Towers  
Wardrobe / Storage

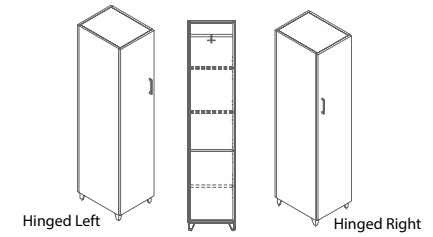

## 1 Select a model

w" x d" x h"

weight	Standard Veneer Top Standard Veneer Chassis		Premium Veneer Top Premium Veneer Chassis		High Pressure Laminate Top Veneer Chassis		Thermally Fused Laminate Top Thermally Fused Laminate Chassis	
	<b>Door Hinged Left</b>							
16 x 21 x 83	180	NSS1683TW283W 3217	NSS1683TW283P 3539	"G" Option N/A	NSS1683TW283M 1540			
16 x 21 x 71	165	NSS1671TW283W 3060	NSS1671TW283P 3366	"G" Option N/A	NSS1671TW283M 1363			
<b>Door Hinged Right</b>								
16 x 21 x 83	180	NSS1683TW284W 3217	NSS1683TW284P 3539	"G" Option N/A	NSS1683TW284M 1540			
16 x 21 x 71	165	NSS1671TW284W 3060	NSS1671TW284P 3366	"G" Option N/A	NSS1671TW284M 1363			

*View statement of line*

## 2 Select a finish

*View finish details*

**Metal finish**  
MFS Silver. Additional metal finishes are available, see options.

WAC	WGW
WRC	WBW
WIC	WSW
WEC	WNW
WHC	WWP
WOC	
WAM	
WCM	
WWW	
WEW	

TBCO
TBSW
TSTV
TSMV
TSLV
TOBW
WBO
WMO
WSO

MAC
MEC
MHC
MOC
MGW
MTW
MSW
MWL

## 3 Select a edge

*View edge details*

Edge
N/A

Edge
N/A

Edge
N/A

## 4 Select hardware

*View hardware details*



## Product features.

- Interior cabinet depth 12.5"
- Full extension drawers
- Locking drawers
- Standard fixed shelf with 3 adjustable shelves (83")
- Standard fixed shelf with 3 adjustable shelves (71")
- Standard Silver Feet (optional White, Black)
- "W" styles - 71" H units finished top, 83" H units black painted top

### NOTES

- Flush cut credenza ends when ganging towers to credenza
- Unit has black back panel and is not designed for Open Plan use. Select OPB Option for Open Plan application.

## Options.

### DOOR

- D2: Door Lock - \$100 per door set
- D6: Delete Doors - n/c
- D9SC: Soft Close Door Hinges - \$20 per door
- WPD3061: Designer White - \$80 per door

### FEET

- D8: Delete feet (extend fronts to floor) - n/c

### OPEN PLAN – FINISHED BACK

- OPB: "W" "G" Style - Modify Unit for Open Plan Application - \$295
- OPBM: "M" Style - Modify Unit for Open Plan Application - \$95

### PREMIUM FINISH OPTION

- MFB: Black metal finish - \$30 per foot
- MFW: White metal finish - \$30 per foot

# NOT SO square office.

Freestanding Half Towers  
Storage / File

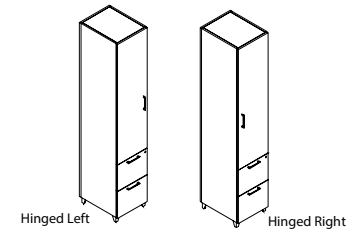

## 1 Select a model

w" x d" x h"

weight	Standard Veneer Top Standard Veneer Chassis		Premium Veneer Top Premium Veneer Chassis		High Pressure Laminate Top Veneer Chassis		Thermally Fused Laminate Top Thermally Fused Laminate Chassis	
<b>Door Hinged Left</b>								
16 x 21 x 83	190	NSS1683TW291W 3353	NSS1683TW291P 3689	"G" Option N/A	NSS1683TW291M 1858			
16 x 21 x 71	175	NSS1671TW291W 3190	NSS1671TW291P 3509	"G" Option N/A	NSS1671TW291M 1682			
<b>Door Hinged Right</b>								
16 x 21 x 83	190	NSS1683TW292W 3353	NSS1683TW292P 3689	"G" Option N/A	NSS1683TW292M 1858			
16 x 21 x 71	175	NSS1671TW292W 3190	NSS1671TW292P 3509	"G" Option N/A	NSS1671TW292M 1682			

[View statement of line](#)

## 2 Select a finish

[View finish details](#)

**Metal finish**  
MFS Silver. Additional metal finishes are available, see options.

WAC	WGW
WRC	WBW
WIC	WSW
WEC	WNW
WHC	WWP
WOC	
WAM	
WCM	
WWW	
WEW	

TBCO  
TBSW  
TSTV  
TSMV  
TSLV  
TOBW  
WBO  
WMO  
WSO

MAC  
MEC  
MHC  
MOC  
MGW  
MTW  
MSW  
MWL

## 3 Select a edge

[View edge details](#)

Edge  
N/A

Edge  
N/A

Edge  
N/A

## 4 Select hardware

[View hardware details](#)

Hardware  
N/A



## Product features.

- Interior cabinet depth 12.5"
- Soft close suspension drawer(s)
- Standard fixed shelf with 2 adjustable shelves (71")
- Standard fixed shelf with 3 adjustable shelves (83")
- Standard Silver Feet (optional White, Black)
- "W" styles - 71" H units finished top, 83" H units black painted top

### NOTES

- Flush cut credenza ends when ganging towers to credenza
- Unit has black back panel and is not designed for Open Plan use. Select OPB Option for Open Plan application.

## Options.

### DOOR

- D2: Door Lock - \$100 per door set
- D6: Delete Doors - n/c
- D9SC: Soft Close Door Hinges - \$20 per door
- WPD3061: Designer White - \$80 per door

### DRAWER

- P6: Modify File/File to Box/Box/File - \$55 per pedestal
- P33: Wood Drawer Upgrade - \$45 per drawer

### FEET

- D8: Delete feet (extend fronts to floor) - n/c

### OPEN PLAN – FINISHED BACK

- OPB: "W" "G" Style - Modify Unit for Open Plan Application - \$295
- OPBM: "M" Style - Modify Unit for Open Plan Application - \$95

### PREMIUM FINISH OPTION

- Specify foot metal finish color - \$160 per unit. Contact customer service
- MFB: Black, MFW: White

# NOT SO square office.

Freestanding Towers  
Storage / File- Mini-Wardrobe

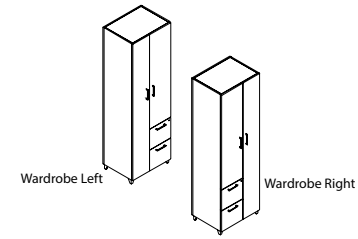

1 Select a model w" x d" x h"	weight	Standard Veneer Top Standard Veneer Chassis		Premium Veneer Top Premium Veneer Chassis		High Pressure Laminate Top Veneer Chassis		Thermally Fused Laminate Top Thermally Fused Laminate Chassis	
		<b>Wardrobe Left</b> 26 x 21 x 83 26 x 21 x 71	265 240	NSS2683TW293W NSS2671TW293W	4027 3847	NSS2683TW293P NSS2671TW293P	4430 4232	"G" Option N/A "G" Option N/A	
<b>Wardrobe Right</b> 26 x 21 x 83 26 x 21 x 71	265 240	NSS2683TW294W NSS2671TW294W	4027 3847	NSS2683TW294P NSS2671TW294P	4430 4232	"G" Option N/A "G" Option N/A		NSS2683TW294M NSS2671TW294M	2128 1895
<b>2 Select a finish</b> <i>View finish details</i>		WAC WRC WIC	WGW WBW WSW	TBCO TBSW TSTV				MAC MEC MHC	
<b>Metal finish</b> MFS Silver. Additional metal finishes are available, see options.		WEC WHC WOC WAM WCM WWW WEW	WNW WWP	TSMV TSLV TOBW WBO WMO WSO				MOC MGW MTW MSW MWL	
<b>3 Select a edge</b> <i>View edge details</i>		Edge N/A		Edge N/A				Edge N/A	
<b>4 Select hardware</b> <i>View hardware details</i>									

*View statement of line*

## Product features.

- Interior cabinet depth 12.5"
- Full extension drawers
- Locking drawers
- Soft close suspension drawer(s)
- Standard fixed shelf with 2 adjustable shelves (71")
- Standard fixed shelf with 3 adjustable shelves (83")
- Standard Silver Feet (optional White, Black)
- "W" styles - 71" H units finished top, 83" H units black painted top

### NOTES

- Flush cut credenza ends when ganging towers to credenza

## Options.

### DOOR

- D2: Door Lock - \$100 per door set
- D6: Delete Doors - n/c
- D9SC: Soft Close Door Hinges - \$20 per door
- WPD3061: Designer White - \$80 per door

### DRAWER

- P6: Modify File/File to Box/Box/File - \$55 per pedestal
- P33: Wood Drawer Upgrade - \$45 per drawer

### FEET

- D8: Delete feet (extend fronts to floor) - n/c

### OPEN PLAN – FINISHED BACK

- OPB: "W" "G" Style - Modify Unit for Open Plan Application - \$295
- OPBM: "M" Style - Modify Unit for Open Plan Application - \$95

### PREMIUM FINISH OPTION

- Specify foot metal finish color - \$160 per unit. Contact customer service
- MFB: Black, MFW: White

# NOT SO square office.

Freestanding Towers  
Wardrobe / Storage Full Tower

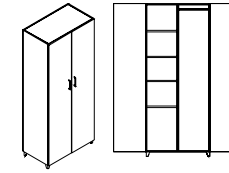

View statement of line

1 Select a model w" x d" x h"	weight	Standard Veneer Top Standard Veneer Chassis		Premium Veneer Top Premium Veneer Chassis		High Pressure Laminate Top Veneer Chassis		Thermally Fused Laminate Top Thermally Fused Laminate Chassis	
		<b>83" Height</b> 35 x 21 x 83 29 x 21 x 83	310 265	NSS3583TW275W NSS2983TW275W	4320 4038	NSS3583TW275P NSS2983TW275P	4752 4442	"G" Option N/A "G" Option N/A	NSS3583TW275M NSS2983TW275M
<b>71" Height</b> 35 x 21 x 71 29 x 21 x 71	285 240	NSS3571TW275W NSS2971TW275W	3865 3583	NSS3571TW275P NSS2971TW275P	4252 3942	"G" Option N/A "G" Option N/A	NSS3571TW275M NSS2971TW275M	1886 1821	
2 Select a finish <i>View finish details</i>  Metal finish MFS Silver. Additional metal finishes are avail- able, see options.	WAC    WGW WRC    WBW WIC    WSW WEC    WNW WHC    WWP WOC WAM WCM WWW WEW		TBCO TBSW TSTV TSMV TSLV TOBW WBO WMO WSO				MAC MEC MHC MOC MGW MTW MSW MWL		
	Edge N/A		Edge N/A				Edge N/A		
3 Select a edge <i>View edge details</i>									
4 Select hardware <i>View hardware details</i>	<p>PL-115 Matte Black PL-116 Matte Nickel</p> <p>PL-210 Anodized Aluminum</p>		<p>PL-115 Matte Black PL-116 Matte Nickel</p> <p>PL-210 Anodized Aluminum</p>		<p>PL-115 Matte Black PL-116 Matte Nickel</p> <p>PL-210 Anodized Aluminum</p>		<p>PL-115 Matte Black PL-116 Matte Nickel</p> <p>PL-210 Anodized Aluminum</p>		
	<p>PL-260 Anodized Aluminum PL-261 White</p> <p>Touch Latch</p>		<p>PL-260 Anodized Aluminum PL-261 White</p> <p>Touch Latch</p>		<p>PL-260 Anodized Aluminum PL-261 White</p> <p>Touch Latch</p>		<p>PL-260 Anodized Aluminum PL-261 White</p> <p>Touch Latch</p>		

## Product features.

- 3 adjustable shelves, 2 fixed
- Interior cabinet depth 12.5"
- Standard 2 fixed shelves with 2 adjustable shelves (71")
- Standard 2 fixed shelves with 3 adjustable shelves (83")
- Standard Silver Feet (optional White, Black)
- Wardrobe left, storage right
- "W" styles - 71" H units finished top, 83" H units black painted top

### NOTES

- Flush cut credenza ends when ganging towers to credenza
- Unit has black back panel and is not designed for Open Plan use.
- Select OPB Option for Open Plan application.
- When specifying MOD310P, 1 lock needed

## Options.

### DOOR

- D2: Door Lock - \$100 per door set
- D6: Delete Doors - n/c
- D9SC: Soft Close Door Hinges - \$20 per door
- WPD3061: Designer White - \$80 per door

### FEET

- D8: Delete feet (extend fronts to floor) - n/c

### OPEN PLAN – FINISHED BACK

- OPB: "W" "G" Style - Modify Unit for Open Plan Application - \$295
- OPBM: "M" Style - Modify Unit for Open Plan Application - \$95

### SHELF

- MOD310P: Delete Center Partition / Add (3 - 71" / 4 - 83") Full Width Adj. Shelves & (1) Fixed - \$295

### PREMIUM FINISH OPTION

- Specify foot metal finish color - \$160 per unit. Contact customer service
- MFB: Black, MFW: White

# NOT SO square office.

Freestanding Towers  
Storage / File Full Tower

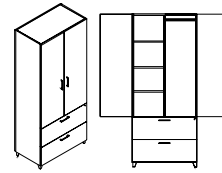

## 1 Select a model

w" x d" x h"

weight	Standard Veneer Top Standard Veneer Chassis		Premium Veneer Top Premium Veneer Chassis		High Pressure Laminate Top Veneer Chassis		Thermally Fused Laminate Top Thermally Fused Laminate Chassis	
	<b>83" Height</b> 35 x 21 x 83 29 x 21 x 83	350 325	NSS3583TW281W NSS2983TW281W	4561 4331	NSS3583TW281P NSS2983TW281P	5018 4765	"G" Option N/A "G" Option N/A	NSS3583TW281M NSS2983TW281M
<b>71" Height</b> 35 x 21 x 71 29 x 21 x 71	325 295	NSS3571TW281W NSS2971TW281W	4072 3870	NSS3571TW281P NSS2971TW281P	4480 4257	"G" Option N/A "G" Option N/A	NSS3571TW281M NSS2971TW281M	2180 2130

View statement of line

## 2 Select a finish

View finish details

WAC	WGW
WRC	WBW
WIC	WSW
WEC	WNW
WHC	WWP
WOC	
WAM	
WCM	
WWW	
WEW	

Metal finish  
MFS Silver. Additional metal finishes are available, see options.

TBCO
TBSW
TSTV
TSMV
TSLV
TOBW
WBO
WMO
WSO

MAC
MEC
MHC
MOC
MGW
MTW
MSW
MWL

## 3 Select a edge

View edge details

Edge
N/A

Edge
N/A

Edge
N/A

## 4 Select hardware

View hardware details

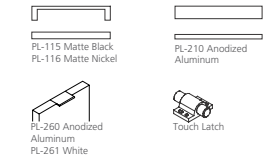
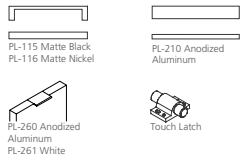
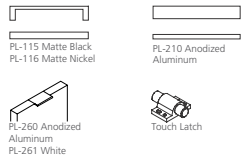

## Product features.

- 71" has 2 adj. shelves / 1 fixed shelf
- 83" has 3 adj. shelves / 1 fixed shelf
- Adjustable shelf per door section
- Full extension drawers
- Locking drawers
- Soft close suspension drawer(s)
- Standard Silver Feet (optional White, Black)
- "W" styles - 71" H units finished top, 83" H units black painted top
- Wardrobe left, storage right

### NOTES

- Flush cut credenza ends when ganging towers to credenza
- Unit has black back panel and is not designed for Open Plan use. Select OPB Option for Open Plan application.

## Options.

### DOOR

- D2: Door Lock - \$100 per door set
- D6: Delete Doors - n/c
- D9SC: Soft Close Door Hinges - \$20 per door
- WPD3061: Designer White - \$80 per door

### DRAWER

- P33: Wood Drawer Upgrade - \$45 per drawer

### FEET

- D8: Delete feet (extend fronts to floor) - n/c

### OPEN PLAN – FINISHED BACK

- OPB: "W" "G" Style - Modify Unit for Open Plan Application - \$295
- OPBM: "M" Style - Modify Unit for Open Plan Application - \$95

### SHELF

- MOD300P: Delete Center Partition / Add 2 (71") or 3 (83") Full Width Adj. Shelves - \$295
- Premium Finish Option
- Specify foot metal finish color - \$160 per unit. Contact customer service
- MFB: Black, MFW: White

# NOT SO square office.

Open Bookcases  
Freestanding

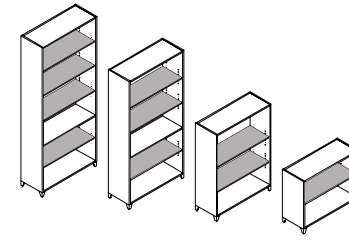

1 Select a model w" x d" x h"	weight	Standard Veneer Top Standard Veneer Chassis		Premium Veneer Top Premium Veneer Chassis		High Pressure Laminate Top Veneer Chassis		Thermally Fused Laminate Top Thermally Fused Laminate Chassis	
		<b>35" Width</b> 35 x 14 x 83 35 x 14 x 71 35 x 14 x 60 35 x 14 x 48 35 x 14 x 29 <b>29" Width</b> 29 x 14 x 83 29 x 14 x 71 29 x 14 x 60 29 x 14 x 48 29 x 14 x 29	195 175 155 120 95 190 170 150 115 90	NSS3583BK250W NSS3571BK250W NSS3560BK250W NSS3548BK250W NSS3529BK250W NSS2983BK250W NSS2971BK250W NSS2960BK250W NSS2948BK250W NSS2929BK250W	3104 2796 2487 1694 1503 2885 2599 2312 1575 1396	NSS3583BK250P NSS3571BK250P NSS3560BK250P NSS3548BK250P NSS3529BK250P NSS2983BK250P NSS2971BK250P NSS2960BK250P NSS2948BK250P NSS2929BK250P	3415 3076 2736 1864 1654 3174 2859 2544 1733 1536	"G" Option N/A "G" Option N/A "G" Option N/A "G" Option N/A "G" Option N/A "G" Option N/A "G" Option N/A "G" Option N/A "G" Option N/A "G" Option N/A	NSS3583BK250M NSS3571BK250M NSS3560BK250M NSS3548BK250M NSS3529BK250M NSS2983BK250M NSS2971BK250M NSS2960BK250M NSS2948BK250M NSS2929BK250M
<b>2 Select a finish</b> <i>View finish details</i>  <b>Metal finish</b> MFS Silver. Additional metal finishes are available, see options.	WAC WRC WIC WEC WHC WOC WAM WCM WWM WEW  Edge N/A	WGW WBW WSW WNW WWP	TBCO TBSW TSTV TSMV TSLV TOBW WBO WMO WSO	Edge N/A	MAC MEC MHC MOC MGW MTW MSW MWL	Edge N/A	Hardware N/A	Hardware N/A	
<b>4 Select hardware</b> <i>View hardware details</i>	Hardware N/A		Hardware N/A		Hardware N/A		Hardware N/A		

*View statement of line*

## Product features.

- 3/4" thick back
- Interior shelf depth 12"
- Metal legs standard
- Standard Silver Feet (optional White, Black)
- "W" styles - 29", 48", 60", and 71" H units finished top, 83" H units black painted top

### NOTES

- Adjustable shelves shaded in gray
- For bookcase unit to align w/ work surface specify storage Credenza on pg 13 and delete doors.
- Unit has black back panel and is not designed for Open Plan use. Select OPB Option for Open Plan application.

## Options.

### FEET

- D8: Delete feet - n/c

### INTERIOR CABINET LIGHTING

- LEDPK starter kit includes Infeed, 1 Puck Interior Light and the ability to daisy chain up to 6 total Puck Lights
- LED Puck Starter Kit - \$310
- PK: 1 LED Interior Light - \$130

### OPEN PLAN – FINISHED BACK

- OPB: "W" "G" Style - Modify Unit for Open Plan Application - \$295
- OPBM: "M" Style - Modify Unit for Open Plan Application - \$95

### SHELF

- GS14F: Replace Standard Shelves with Glass Shelves - \$90 per shelf
- S714F: Heavy Duty Lumber 1" Shelves - \$80 per shelf ("M" Styles - n/a)

### PREMIUM FINISH OPTION

- Specify foot metal finish color - \$160 per unit. Contact customer service
- MFB: Black, MFW: White

Not so square options.



COMPUTER SUPPORT  
*single monitor arm*

Style Number	List Price
MA1	280

### Specifications

- Available in black or silver
- Desk clamp and mounting included
- Easy assembly and flexibility
- Elastic painting process for a durable and beautiful finish
- Gas spring tension adjustment for counter-balance height adjustment for monitors 1-8 KG
- Gas spring tested to 50,000 repetitions
- Hidden cable management



COMPUTER SUPPORT  
*double monitor arm*

Style Number	List Price
MA2	450

### Specifications

- Available in black or silver
- Desk clamp and mounting included
- Easy assembly and flexibility
- Elastic painting process for a durable and beautiful finish
- Gas spring tension adjustment for counter-balance height adjustment for monitors 1-8 KG
- Gas spring tested to 50,000 repetitions
- Hidden cable management



COMPUTER SUPPORT  
*triple monitor arm*

Style Number	List Price
MA3	530

### Specifications

- Available in black or silver
- Desk clamp and mounting included
- Easy assembly and flexibility
- Elastic painting process for a durable and beautiful finish
- Gas spring tension adjustment for counter-balance height adjustment for monitors 1-8 KG
- Gas spring tested to 50,000 repetitions
- Hidden cable management



COMPUTER SUPPORT  
*quadruple monitor arm*

Style Number	List Price
MA4	705

### Specifications

- Available in black
- Desk clamp and mounting included
- Easy assembly and flexibility
- Elastic painting process for a durable and beautiful finish
- Gas spring tension adjustment for counter-balance height adjustment for monitors 1-8 KG
- Gas spring tested to 50,000 repetitions
- Hidden cable management



## Not so square options.

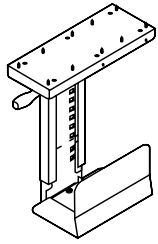

COMPUTER SUPPORT  
*cpu retractable cradle*

Style Number	List Price
K18	205

### Specifications

- Black Metal CPU Carriage
- Full 360° swivel capability allows easy access to rear of CPU for cables / wires
- Track allows 8- 1/2" extension
- Width Adjustment 5-1/2" to 9-1/4"
- Height adjustment 14- 5/8" to 20- 1/2"
- Black epoxy finish

- Notes
- Factory Installed

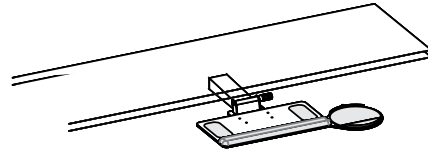

COMPUTER SUPPORT  
*articulating keyboard tray*

Style Number	List Price
Factory Installed K28	395
Field Installed K28F	415

### Specifications

- Adjusts effortlessly - A simple one-handed motion allows the keyboard to be repositioned instantly, without the use of locks or levers
- Encourages low-risk postures - Maximizes adjustability within a safe operating range.
- Will last a lifetime - Exceeds all applicable BIFMA Standards and comes with a lifetime guarantee.

- Notes
- Available on: Freestanding Desk
  - Factory Installed (standard)
  - FIELD INSTALL - \$415



DOOR MODIFICATIONS  
*soft close door hinge*

Style Number	List Price
D9SC	20 Per door

### Specifications

- Snap onto standard door hinge
- Requires (2) per door
- Max door height 43"
- Factory installed where specified
- Individually shipped for field installation

- Notes
- Specify Each Item To Have Slow Close Feature

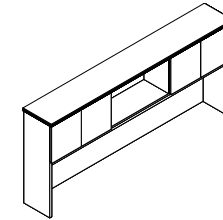

DOOR MODIFICATIONS  
*delete doors*

Style Number	List Price
D6	N/C

### Specifications

- Standard Door overheads and cabinets can have door deleted for open access. Modification of hinge rails and structural components are made face ready.

## Not so square options.

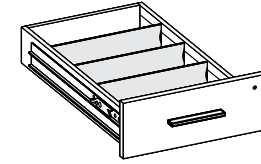
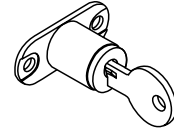
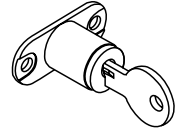
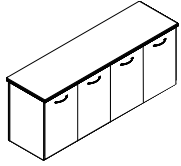

### DOOR MODIFICATIONS

*delete doors/replace black laminate shelf w/ finished shelf*

Style Number	List Price
D6A	N/C

### Specifications

- Delete doors and replace black laminate shelf with finished shelf

#### Notes

- Available on: All Storage "W"/"G" Style Credenzas.

### DOOR MODIFICATIONS

*panel door lock*

Style Number	List Price
D2	100 Per door set

### Specifications

- Door Locks - 1 Door w/ Lock, Other Door w/ Catch Latch
- Contact Customer Service regarding limited lock locations and keying.

#### Notes

- Available on: Panel Doors, Wood Frame Doors, and Silverluma doors

### DOOR MODIFICATIONS

*glass door lock*

Style Number	List Price
D2-G	205 Per door set

### Specifications

- Door Locks - 1 Door w/ Lock, Other Door w/ Catch Latch
- Contact Customer Service regarding limited lock locations and keying.

#### Notes

- Available on: Glass Doors

### DRAWER OPTIONS

*box drawer accessories*

Style Number	List Price
Wood Drawer Dividers w/ Clips K-DIV	SET OF 3 - 30
Single Tray - Utility Tray K-Sut	35 ea.

### Specifications

- K-DIV Extra Wood Drawer Dividers with Clips, Top Box drawers standard with 1 divider
- K-SUT Single Tray - Utility Tray, Specify Legal or Letter drawer width

## Not so square options.

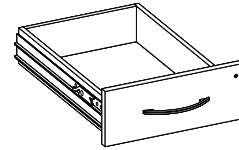
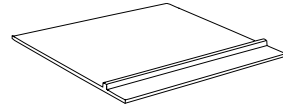
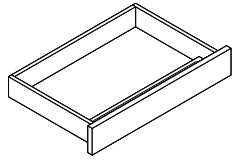

### DRAWER OPTIONS *finished center drawer*

Style Number	List Price
K31	205
Add Skirt Option K31-SK	310

### Specifications

- Veneer drawer front finished to match unit W or G style veneer.
- Ball bearing smooth operation
- Drawer has lifetime guarantee
- Standard with matching wood grain pencil tray
- Laminate drawer front to match laminate unit (M style)

### DRAWER OPTIONS - BOTTOM COVER *felt bottom center drawer insert liner*

Style Number	List Price
K3	100

### Specifications

- Inserts into center drawer and features divider for open pen and pencil storage. Removable for easy cleaning.
- Adds a luxurious touch to center drawers.
- Color: Dark Brown Coal

### DRAWER OPTIONS - UPGRADE *wood drawer upgrade*

Style Number	List Price
P33	45 Per drawer

### Specifications

- Dowel joint construction
- Hardwood veneer multi-ply drawer
- UV finish
- 1/4" Wood veneer bottoms
- File drawer bottoms are five block reinforced for heavy weight capacity
- Lifetime guaranteed

### GLASSBOARD ACCESSORIES *glassboard accessory kit*

Style Number	List Price
GBKIT	290

### Specifications

- 8 Earth magnets, 1 magnetic marker cup holder and 1 magnetic dry eraser

## Not so square options.

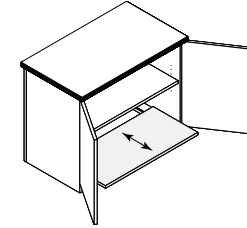
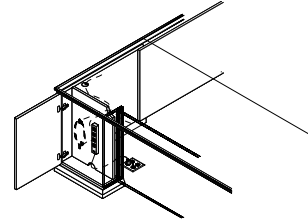
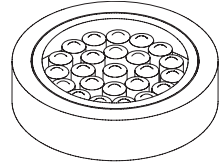

### RECESSED LIGHTING *lt-led task light*

Style Number	List Price
24" Task light LT-LED24R	190
48" Task light LT-LED48R	245
60" Task light LT-LED60R	310
72" Task light LT-LED72R	335

### Specifications

- 6.5' Power cord. Switch with touch dimmer
- 36 LEDs per foot
- 4.6 Watts per foot
- 91 Lumens per watt
- Please note when ganging.
- Overhead tasklight cord is located on the right facing side. If the opposite location is required please contact customer service.

### LIGHTING *led interior cabinet puck light*

Style Number	List Price
Starter Kit LEDPK	310
1 LED Interior Puck Light PK	130

### Specifications

- Starter kit includes Infeed, 1 Puck Interior Light and the ability to daisy chain up to 6 total Puck Lights
- (1) LED Puck Light with 30W power drive and switch
- Recessed fixture
- 12V linking cord 98"L
- Silver finish
- 50,000 hour life
- 2 watt per light

#### Notes

- Available on: Overhead/Tower Units with glass doors or no doors
- Power drive included, Light only

### PEDESTAL MODIFICATIONS *breakfront pedestal with wire management cavity door*

Style Number	List Price
PC10 Power Supply Cordset PD717	100
	100

### Specifications

- Hinged pedestal front door offers easy access for wire management
- Wire hooks provide wire coil storage
- Wire access openings allow access to floor, cabinets interior and kneespace
- Cabinet interior is black finish
- Top grommet is positioned over cavity for access ease
- (Power Strip Optional)

#### Notes

- Breakfront Chassis Only

### PEDESTAL MODIFICATIONS *black laminate printer pullout bottom shelf*

Style Number	List Price
PPOS	225

### Specifications

- Black Laminate pullout shelf on suspension
- Black grommet
- Adjustable Shelf

## Not so square options.

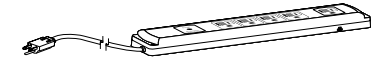
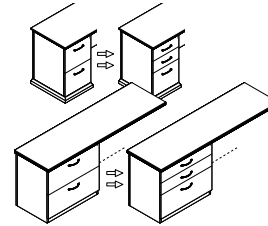
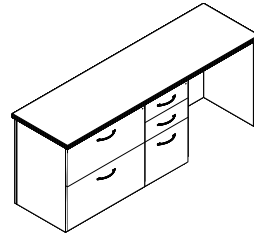
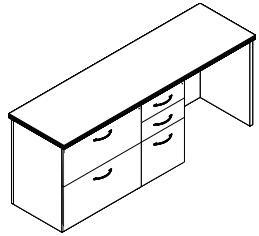

### PEDESTAL MODIFICATIONS

*add veneer kneespace cabinets - no base*

Style Number	List Price
Add Box/Box/File or File/File P40W	910
Add Lateral File 29" W P41W	1025
Add Multi-File - 31"W P42W	1140
Add Storage With Doors 29"W P43W	1025
Add CPU /Printer Cabinet - Open P44W	1025

### Specifications

- Multi-file specify Box/Box Left or Right

#### Notes

- Add additional Standard Cabinets To Kneespace Area.

### PEDESTAL MODIFICATIONS

*add melamine (tfl) kneespace cabinets - no base*

Style Number	List Price
Add Box/Box/File or File/File P40M	720
Add Lateral File 29" W P41M	890
Add Multi-File - 31"W P42M	1005
Add Storage With Doors 29"W P43M	800
Add CPU /Printer Cabinet - Open P44M	915

### Specifications

- Multi-file specify Box/Box Left or Right

#### Notes

- Available on: TFL products  
- Add additional Standard Cabinets To Kneespace Area.

### PEDESTAL MODIFICATIONS

*modify drawer configurations*

Style Number	List Price
File/File to Box/Box/File P6	55 Per ped
Box/Box/File to File/File P6	55 Per ped
Lateral File to 2 Box Drawers P8	100 Per ped

### Specifications

- Modify File/File To Box/Box/File - Any Unit

### POWER / DATA

*power supply cordset*

Style Number	List Price
PD717	100

### Specifications

- SIZE: 10.75"L x 2.0"W x 1.06"H  
- (5) Outlets w/ 10' cord  
- Surge suppression (720 Joules)  
- 15 Amp breaker  
- Available on: Vertical Panels, Cabinet Interiors, and under tops

Not so square options.

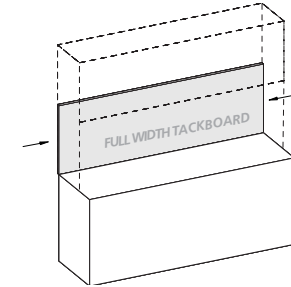
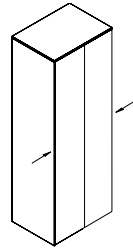
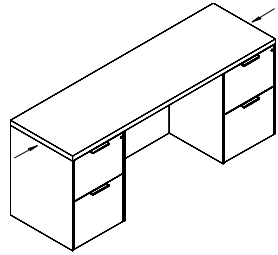

PRODUCT MODIFICATIONS  
 modify width - open kneespace

Style Number	List Price
MOD-1	125

Specifications

- Modify width down on any unit with an open kneespace: desk, workstation credenza, bridge, return

PRODUCT MODIFICATIONS  
 modify width - open/closed storage

Style Number	List Price
MOD-2	250

Specifications

- Modify width down on any unit with open or closed storage section: overheads, wall hung units, storage credenzas, towers

PRODUCT MODIFICATIONS  
 modify width - outside of mod-1, mod-2

Style Number	List Price
MOD-3	Contact for pricing

Specifications

- Width modification outside of MOD-1 & MOD-2

PRODUCT MODIFICATIONS  
 modify width - tackboard, slat wall, veneer panel, or a glassboard

Style Number	List Price
MOD-4	50

Specifications

- Modify width down on tackboard, slat wall, veneer panel, or a overhead glassboard

## Not so square options.

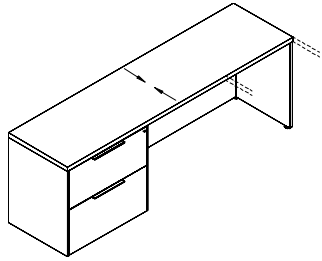

PRODUCT MODIFICATIONS  
*modify depth - decrease depth*

Style Number	List Price
MOD-5	125

### Specifications

- Modify depth down (minimum depth for a unit with drawers is 21" D)

Notes  
- Ex. 24" to 21", 30" to 24", and 36" to 30"

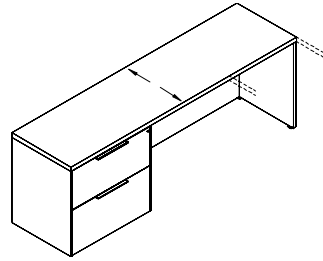

PRODUCT MODIFICATIONS  
*modify depth - increase depth*

Style Number	List Price
MOD-6	Add 10%

### Specifications

- Increase depth by no more than 6"

Notes  
- Ex. 24" to 30", 30" to 36", and 36" to 42"  
- Add 10% to the unit you want to increase the depth of by no more than 6"

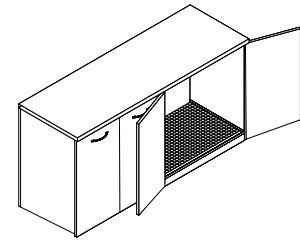

REFRIGERATOR MODIFICATION  
*refrigerator cabinet modification*

Style Number	List Price
REF01	205

### Specifications

- Open back cutout for venting
- Moisture sponge mat
- Contaminate ledge
- Contact customer service for maximum refrigerator size (Changes based on unit).

Notes  
- Available on: 36" and 42" Storage Credenzas

Not so square options.

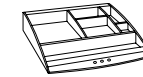
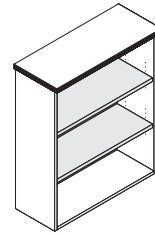
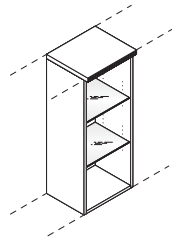
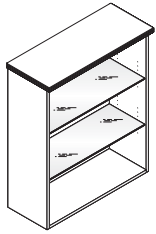

**SHELF MODIFICATIONS**  
*glass shelves - tempered full width*  
 26" - 35"

Style Number	List Price
26"W - 35"W x 14"D Shelf GS14F	90

**Specifications**

- Glass Shelves Replace Wood Shelf In Open Or Glass Door Cabinet. Also Order Interior Cabinet Lighting.

**SHELF MODIFICATIONS**  
*tempered glass shelves for half cabinet 17- 1/2" widths*

Style Number	List Price
14-1/2"W - 17- 1/2"W x 14"D Shelf GS14H	70 ea.

**Specifications**

- Glass Shelves Replace Wood Shelf In Open Or Glass Door Cabinet. Also Order Interior Cabinet Lighting.

**Notes**  
 - Replace only adjustable shelves between cabinet light and fixed lower wood shelf.

**SHELF MODIFICATIONS**  
*heavy duty solid wood bookcase replacement shelves*

Style Number	List Price
1" Wood Shelf 14" Deep S714F	80 ea.
1" Wood Shelf 24" Deep S714FX	160 ea.

**Specifications**

- 1" Solid Lumber Core Shelves Replace Standard 3/4" Plywood Adjustable And Fixed Shelves

**SLAT WALL ACCESSORIES**  
*slat wall accessory tray*

Style Number	List Price
SWA9	50

**Specifications**

- Specify Black Or Matte Silver



Not so square options.

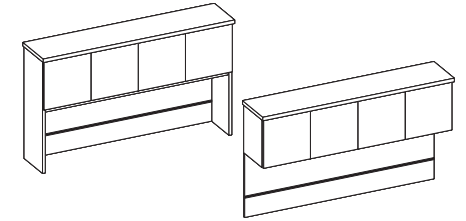
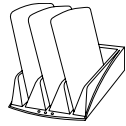

SLAT WALL ACCESSORIES  
*slat wall folder tray*

Style Number	List Price
SWA7	50

**Specifications**

- Specify Black Or Matte Silver

SLAT WALL ACCESSORIES  
*slat wall paper tray*

Style Number	List Price
SWA2	40

**Specifications**

- Specify Black Or Matte Silver

SLAT WALL ACCESSORIES  
*slat wall pencil holder*

Style Number	List Price
SWA4	30

**Specifications**

- Specify Black Or Matte Silver

TOOL CHANNEL ACCESSORIES  
*recessed aluminum tool channel*

Style Number	List Price
ATB02	5 per 1"W

**Specifications**

- Anodized aluminum finish
- Fully recessed
- Finish matches anodized aluminum accessories
- Can be specified with fabric tack surface mounted above channel

Notes

- If using tool channel with wallhung overhead, a veneer panel must be specified.

Not so square options.

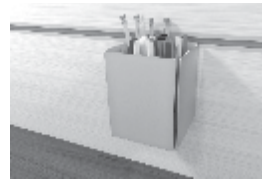
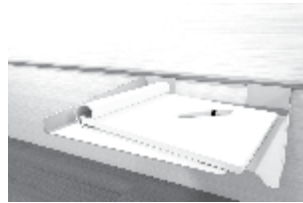

TOOL CHANNEL ACCESSORIES  
*iphone holder*

Style Number	List Price
ATB31	125

**Specifications**

- For Console/Wall Hung Back Panels With Optional Tool Bar
- 18 Gauge Steel - Stamp Formed
- Silver Powdercoat Finish
- 5" x 3 -3/4"W
- Non-slip Neoprene pad

TOOL CHANNEL ACCESSORIES  
*large shelf*

Style Number	List Price
ATB35	135

**Specifications**

- 12"W x 10"D

TOOL CHANNEL ACCESSORIES  
*pencil pen holder*

Style Number	List Price
ATB38	120

**Specifications**

- For Console/Wall Hung Back Panels With Optional Tool Bar
- 18 Gauge Steel - Stamp Formed
- Silver Powdercoat Finish
- 5"H x 4"W x 4"D

TOOL CHANNEL ACCESSORIES  
*tablet holder*

Style Number	List Price
ATB30	145

**Specifications**

- For Console/Wall Hung Back Panels With Optional Tool Bar
- 18 Gauge Steel - Stamp Formed
- Silver Powdercoat Finish
- 10" x 8"W
- Non-slip Neoprene pad

Not so square options.

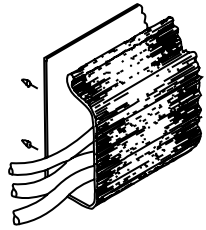

WIRE MANAGEMENT  
*horizontal j-channel wire management raceway*

Style Number	List Price
W1	80 Per 4' section

Specifications

- 4' section for field installation.
- The "J" shape black thermoplastic wire raceway may be added to specified worksurface tops to provide concealed channeling of wires to and from worksurface grommets. For use in open kneespace areas, raceway is attachable to top of back panel with pan head screws. Interior dimensions are 1" x 1- 1/2" providing ample storage for multiple wires and excess cable. Front of raceway flexes out for easy cord insertion.

- Notes
- Units w/ Wire Channel Standard.
  - Field Installation

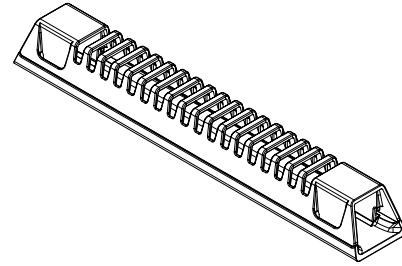

WIRE MANAGEMENT  
*horizontal wire management raceway*

Style Number	List Price
W21	35

Specifications

- 10"W x 1.5"D x 1.25"H
- Grey Wire Manager (10.5")
- Power and data cables can be discretely housed and managed with the W21 Gray Wire Manager. This can be mounted in any location to metal frame or underside of conference tables and runs cables through a 1" channel from power module to hollow steel legs. This keeps cables organized under the table top. Release clips make it simple to snap on and off the Wire Manager for easy organization and access after attached to the table

- Notes
- Field installed



WIRE MANAGEMENT  
*horizontal u-channel wire management raceway*

Style Number	List Price
W2A	80 Per 4' section

Specifications

- 4' section for field installation.
- Notes
- Units w/ Wire Channel Standard.
  - Field Installation



WIRE MANAGEMENT  
*coil wire manager*

Style Number	List Price
W18	160

Specifications

- Weighted Base, Table attachment plate
  - 39- 1/2" Length
  - Black
- Notes
- Location

Not so square options.

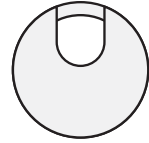
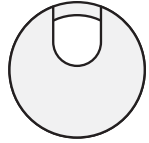

WIRE MANAGEMENT

*standard location grommets - factory installed*

Style Number	List Price
Standard Location Grommet	
Black	
TM30	50
Silver	
TM31	50
Antique Brass	
TM33	50
White	
TM34	50

Specifications

- 1 -5/8" Metal Grommet

Notes

- \*Units w/ Grommets Standard Are Noted Under Standard Features. Grommets Match Pull Finish - Standard (Unless Specified Otherwise)

WIRE MANAGEMENT

*non-standard location grommets - factory installed*

Style Number	List Price
Non-Standard Location Grommet	
Black	
TM30 -NS	95
Silver	
TM31 -NS	95
Antique Brass	
TM33 -NS	95
White	
TM34 -NS	95

Specifications

- 1 -5/8" Metal Grommet

Notes

- \*Units w/ Grommets Standard Are Noted Under Standard Features. Grommets Match Pull Finish - Standard (Unless Specified Otherwise)

WIRE MANAGEMENT

*black plastic vertical surface grommets - factory installed*

Style Number	List Price
Standard Location Grommet	
TM50-C	50
Non-Standard Location Grommet	
TM50-NS	95

Specifications

- 2 " Black Plastic Grommet

Notes

- Standard Location is Bottom Center

## power & data options.

Aircharge wireless charging grommet

Style Number	List Price
 ACWG WIRELESS GROMMET	\$195

## Specifications

- › When used with GROVE Tables an additional \$350 LIST will apply for the special cutout required.
- › AirCharge offers a convenient way to charge any Qi compatible smartphone or device without the need to carry charging cables or find an available power outlet.
- › The Aircharge is powered by the latest Qi compliant IC offering reliable and efficient wireless charging in a convenient 3" grommet hub. Simply place your phone on the Aircharge and an LED will confirm pairing and begin wireless charging.
- › Recess: Efficient space conservation and quick access
- › Input: DC 5V (with included AC power adapter), DC 9V, 1.67A (with optional QC 2.0 power adapter)
- › Output: 5 watts Max. with DC 5V, 2A power adapter, 10 watts Max. with QC 2.0 power adapter
- › Qi V1.2 compliant IC
- › Charging distance: 6mm Max.

Available: All DARRAN collections



## power & data options.

Cove power unit - non-linking

Style Number	List Price
 PD-COVE PLUG	\$550
Non-linking version	

## Specifications

- › Size 5.75" L x 2.5" W
- › (2) 15 Amp Receptacles and (2) USB charging ports
- › Surface Mount
- › 108" Cord
- › Standard Silver Finish, Available in White or Black Finish upon request
- › ETL Listed

Available: All DARRAN collections



## power & data options.

Cove corded series

Style Number	List Price
 PD-COVE-PKO	\$800

## Specifications

- › Size 9.5" L x 2.5" W x 3.18" D
- › When used with GROVE Tables an additional \$350 LIST will apply for the special cutout required.
- › (2) Power Receptacles, (2) 2.1 Amp USB charging ports and (1) Telecom Plate Knockout
- › Surface Mount
- › 108" Cord
- › Standard Silver Finish, Available in White or Black Finish upon request
- › ETL Listed

Available: All DARRAN collections

### Telecom Plates

RJ45 (1)	\$35
RJ45 (2)	\$70
RJ45 (3)	\$105
USB (1)	\$70
USB (2)	\$140
RJ11/RJ45	\$70
RJ45/USB	\$105
RJ45/HDMI	\$190
HDMI/DVI	\$325
HDMI/USB	\$205
HDMI/VGA	\$240
VGA/MINI-STEREO	\$155
VGA/USB	\$175

This pod can have up to 1 total plates.  
\*All telecom connectors sold separately.



## power & data options.

Soba wire manager

Style Number	List Price
STARTER UNITS	
SCDW	\$200
White wire manager	
SCDB	\$200
Black wire manager	

## Specifications

- › Dimensions: 9ft x 9in x 3.15in
- › Zips up, bundles and routes loose, messy cables into a single tube
- › Routes and guides cables behind desks, TVs, and anywhere cables tend to get messy
- › Accommodates large or small cables, up to three cables at once
- › Support channels, used to route cables, include powerful adhesive backing which allows easy attachment to surfaces.

Available: All DARRAN collections

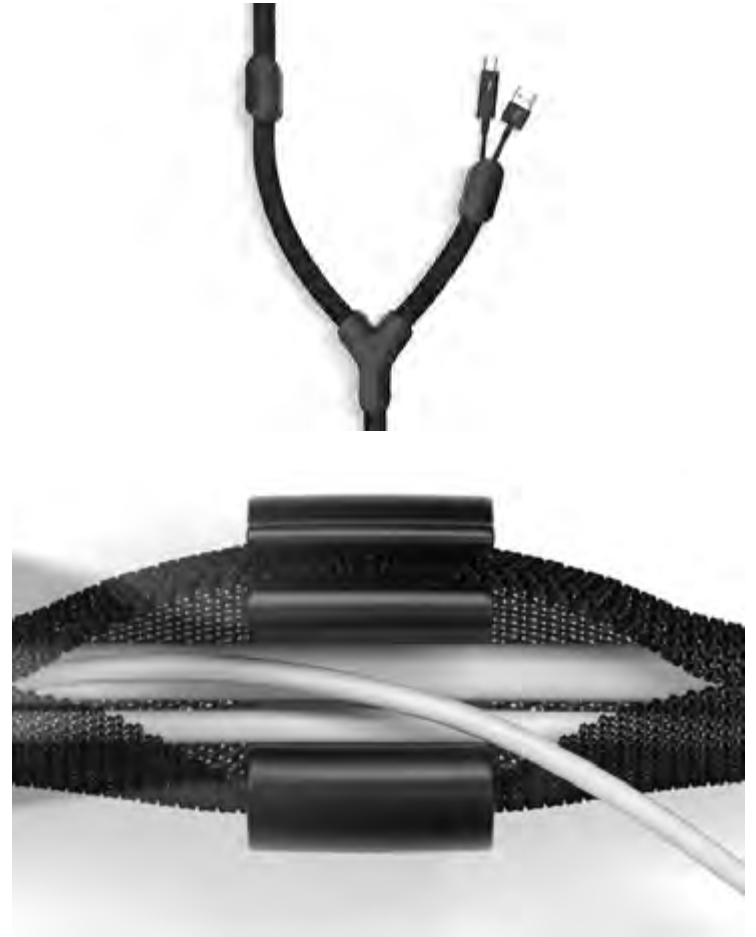



## power & data options.

VILLA Power unit - non-linking

Style Number	List Price
 VIL-C PLUG	\$515
Non-Linking	

### Specifications

- › Size: Top Grommet 5.68" L X 3.39"W; Under Top 12"L x 3.13"W x 3.08"D
- › (2) Power receptacles; (2) USB charging ports and (1) Knockouts for RJ45 Data Ports
- › Surface Mount
- › 72" Cord (Longer cord available, contact Customer Service)
- › Standard Silver Finish, Black Finish available upon request
- › UL or ETL Certified

Available: All DARRAN collections, excludes Grove

RJ45 Knockout	
RJ45 (1)	\$35



Quick ship  
Central Park  
price list



effective july 1, 2021

## Central park quick ship table of contents

Statement of Line .....	2
Freight .....	3
Features   Advantages .....	4
Finishes   specifications.....	6
Grommets   Grommet Reference.....	9
Height Reference .....	10
Modesty Reference .....	11
Doors   Grain Direction.....	12
Drawer Dimensions   FILING Reference .....	13
Double Pedestal Desks .....	14
Single Pedestal Desks.....	17
Conference Desks.....	20
Service Desks .....	21
Returns.....	22
Bridges .....	23
Freestanding Credenzas .....	24
Workstation Credenzas.....	29
Service Credenzas .....	30
Pedestals.....	32
Single Height Freestanding Overheads .....	33
Single Height Wall Hung Overheads .....	36
Overhead Bookcases .....	38
Vertical Half Towers.....	39
Bookcases.....	41
Power & data options.....	42

statement of line.

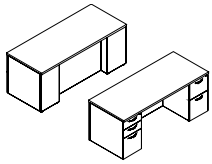

PAGE 14  
Breakfront Chassis Desks

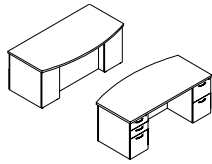

PAGE 15  
Breakfront Chassis Desks

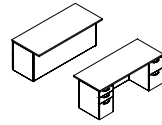

PAGE 16  
Flush Chassis Desks W/ Overhang

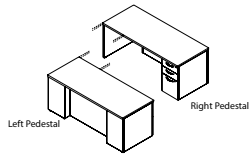

PAGE 17  
Double Breakfront / Single Pedestal Desks

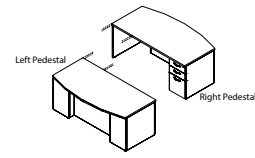

PAGE 18  
Double Breakfront / Single Pedestal Desks

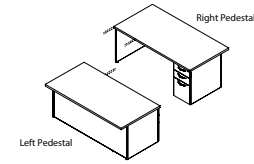

PAGE 19  
Flush Chassis Single Pedestal Desks W/ Overhang Top

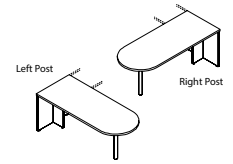

PAGE 20  
Conference Desks

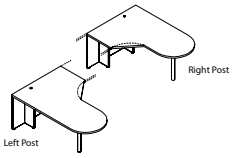

PAGE 21  
Service Workstation Desks

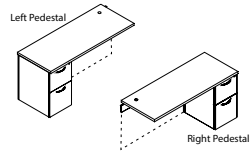

PAGE 22  
"L" Workstation Returns



PAGE 23  
Bridges

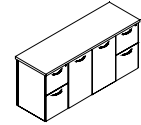

PAGE 24  
Full Pedestal Credenzas

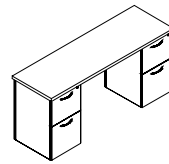

PAGE 25  
Full Pedestal Credenzas

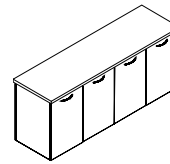

PAGE 26  
Full Pedestal Credenzas

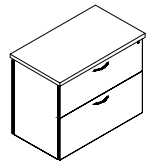

PAGE 27  
Full Pedestal Credenzas



PAGE 28  
Full Pedestal Credenzas

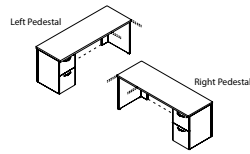

PAGE 29  
Workstation Credenzas

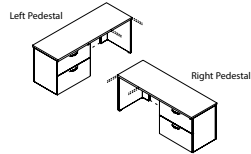

PAGE 30  
Workstation Credenzas

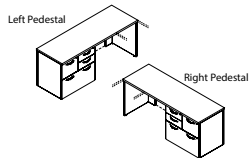

PAGE 31  
Workstation Credenzas

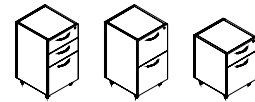

PAGE 32  
Mobile Pedestals

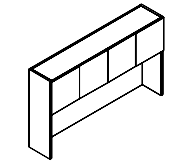

PAGE 33  
Single Storage Overhead Console

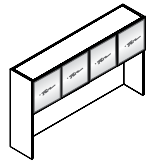

PAGE 34  
Single Storage Overhead Console

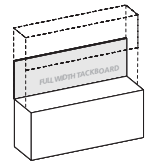

PAGE 35  
Overhead Tackboards

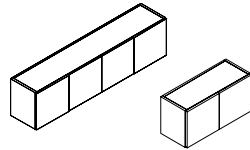

PAGE 36  
Single Height Wall Hung Overheads

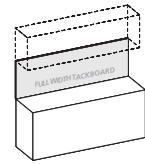

PAGE 37  
Wall Hung Tackboards

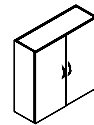

PAGE 38  
Overhead Bookcases

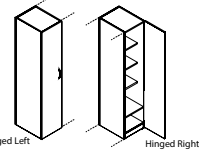

PAGE 39  
Vertical Half Towers

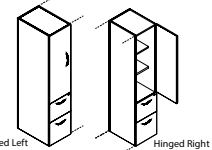

PAGE 40  
Vertical Half Towers

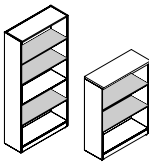

PAGE 41  
Bookcases

## Central park quick ship freight | 15 day quick ship

### Shipping Schedule

DARRAN will make every effort to match shipping requests that are clearly noted on orders. However, the company accepts no liability for failure of delivery and/or delay if the occurrence is outside the control of DARRAN. To ensure specific time arrival, we recommend arranging single stop, designated load carriers. Less than trailer load (LTL) shipments cannot be coordinated for a guaranteed delivery time.

### Prices

- › All prices shown are suggested list prices with freight included where indicated.
- › Freight allows delivery to one qualified destination.
- › Within the Continental USA, all orders above \$1,500 net are shipped FOB factory, freight prepaid and allowed. All orders less than \$1,500 net will be subject to a \$100 net freight charge.
- › If shipment unloading takes longer than the specified 3 hours, a charge of \$100 per hour will be billed.

### Call Before Delivery Request

DARRAN will arrange for carriers to call before delivery when requested.

Important Non-Qualified Destinations DARRAN Prepaid Freight Pricing does not include delivery to:

- › Residential Areas
- › Restricted Commercial Areas
- › No Dock Locations
- › Inside delivery/setup service

Orders received and installed without professional Furniture Installers voids all Warranty Coverage.

### Carrier Selection

DARRAN selects and uses only carriers specialized in furniture transportation. Customer requested carriers can be authorized using Freight Excluded pricing with invoice add-on.

### Express Carriers

DARRAN assumes no responsibility for charges incurred caused by delayed or late deliveries. If a guaranteed delivery time is needed please call DARRAN Customer Service at 1.800.334.7891 for a quote as additional charges will apply. Weekend or after-hours deliveries are subject to additional charges.

### 15 Day Quick Ship

DARRAN provides a 15 Day Quick Ship solution for customers that need a fast delivery on casegoods, conference tables and guest chairs. Available products will have a truck icon listed in front of the product sku. The product should be designated on purchased orders as quick ship.

- › Limited to 20 offices, 10 Conference tables and 30 guest chairs per order.
- › Finishes Available: Amber Cherry, Caramel Cherry, Crimson Cherry, Ebony Cherry, Honey Cherry, KoKo Cherry, Executive Walnut, Gunstock Walnut, Henna Walnut and Natural Walnut.
- › 15 Day Quick Ship promotion is based on orders placed on Friday by 12 noon EST. Orders placed other than this day will result in a 16-20 day lead time. All orders are scheduled for Friday ship dates.
- › All 15 Day Quick Ship orders are subject to inventory levels and credit approval.

## Central park quick ship features & advantages

### Veneer

DARRAN only uses HPVA AA Grade Flat Cut Cherry, Maple, and Walnut Veneers and AA Grade Quartered Oak Veneers. Central park is also available in double cut reconstituted walnut and oak patterns made from rapidly renewable wood veneer providing a repeatable consistent straight grain pattern. All veneers are selected and matched for balance and consistency.

### Veneer tops

Central park veneer tops feature a 45-pound density substrate with balanced 3-ply construction. Tops are 1-5/16" thick on MDF core comprised of 100% recycled and recovered wood fibers. All veneer tops are slipmatched and feature a 3mm external solid hardwood band or profile edge.

### Laminate tops

Central park high-pressure laminate tops feature a 45-pound density substrate with balanced 3-ply construction. Tops are 1-5/16" thick on MDF core comprised of 100% recycled and recovered wood fibers. All high pressure laminate tops are available with a profile edge, laminate self-edge or 2mm PVC edge band. Laminates in wood grain patterns feature a fine grain texture that features the polish and luxe of a real wood veneer with a subtle narrow grain structure.

### TFL tops

Thermally Fused Laminate tops feature a 45-pound density substrate with balanced 3-ply construction. Tops are 1-1/8" thick on MDF core that is comprised of 100% recycled and recovered wood fibers. All Thermally Fused Laminate tops are available with a 2mm flat PVC band. Laminates in wood grain patterns feature Timberline Texture providing the grain pattern of wood.

### Cleaning wood & laminate

In addition to regular dusting, give your furniture an occasional cleaning in accordance with our cleaning instructions. DARRAN wood and laminate products can be cleaned with a soft cloth and a mild soap and water mixture. Use approximately 32 oz of water mixed with one tablespoon of dish soap, always wiping with the grain. Dry with a soft cloth, going with the grain, to avoid spotting or streaking.

Wood products should be waxed periodically using a non-wax liquid; please do not use any waxy polish or cleaner. Interior of drawers may also be cleaned with mild soap and water mixture, or any household cleaner that is not petroleum or thinner-based.

### Chassis & pedestal

Chassis components are 3/4" thick core of particle board or MDF rated EPP/SCS/CARB-II material with 3-ply balanced construction. Pedestal and Cabinets feature dowel

construction reinforced with steel bracket plates, wood cleats, screws and glue. All units are standard with 1" adjustable glides that allow for leveling of units that are secured in solid wood glide blocks to prevent tearout. Overhead cabinet construction.

### Overhead cabinet construction Freestanding & wall mount

Freestanding Overhead storage cabinets are constructed of 1" and 3/4" thick core of particle board or MDF rated EPP/SCS/CARB-II material with 3-ply balanced construction. Panels are attached with cam fasteners in conjunction with dowels securely adhered with PVAc glue. All surface mount cabinets connect to work surface with anti-slip tape. Wall mount cabinets are mounted to the wall with steel "z" bracket attachment method using 5mm euro screws to attach to the back of the cabinet. All units ship with a steel "z" bracket. This bracket is mounted to the wall by field installers. Installers are responsible for selecting and supplying appropriate fasteners for wall conditions.

### Bookcase Construction

All chassis (sides, back, top and bottom panels) are constructed with 3/4" thick core of particle board or MDF rated EPP/SCS/CARB-II material with 3-ply balanced construction. Panels are attached with cam-lock fasteners in conjunction with dowels securely adhered with glue. Shelves on all units are 3/4" thick balance 3 ply panels. Optional heavy duty shelves are 1" thick lumber core balanced 5 ply construction.

### Tackboards

Wall mount tackboards are constructed of .75" thick fiberboard. The fabric is precisely aligned and fitted to the tackboard with a sock on cover. Overhead storage tackboards are constructed of .75" thick fiberboard. The fabric is precisely aligned and fitted to the tackboard and adhered to the rigid hardboard with staples. Wall mount cabinets are mounted to the wall with steel "z" bracket attachment method using 5mm euro screws to attach to the back of the cabinet. All units ship with a steel "z" bracket. This bracket is mounted to the wall by field installers. Installers are responsible for selecting and supplying appropriate fasteners for wall conditions.

### Adjustable glides

Glides provide 1" of vertical leveling adjustment. Glide bottom is durable metal. Glides are secured in solid wood blocks that are screwed and glued for durability.

### Drawers

All drawers are constructed with mitre joint/dowel construction in a natural maple finish with four sides and a bottom, which are attached to a drawer front with screws for easy removal. Drawer fronts are vertically matched in balanced sets. Pencil trays are standard in all box drawers.

## Central park quick ship features & advantages

Drawers are constructed of 1/2" thick wood grained wrapped 5 sided miter-folded construction with 1/4" thick hardboard bottoms reinforced for heavy weight capacity. Drawers have been tested and pass BIFMA 50,000 cycle test. All drawers are guaranteed lifetime with free replacement warranty.

### Drawer fronts

Drawer fronts are vertically matched in balanced sets. Doors feature vertical veneer bookmatched horizontally in sets of 2 / 4 and 6 doors. All drawers and doors have traditional scallop profile edge shape. All tower fronts matched in vertical sets.

### Optional wood drawers

Optional hardwood veneer plywood drawers feature banded top and bottom edges for smoothness. Drawers are dowel joint construction with a UV cured finish over maple veneers, plus a lifetime free replacement guarantee.

Optional Wood Drawer (Any Size) – Option Code P33...\$45 List Price Per Drawer

### Suspensions

All casegoods utilize cold rolled steel zinc plated high-grade drawer suspensions. All suspensions are warranted for the lifetime of the product. Box and File drawers are full extension, featuring steel ball bearings for a smoother quieter range of motion and are rated 100lbs. Lateral file drawers are a progressive action full extension suspension and is rated at 150lbs. Veneer and High Pressure laminate casegoods feature soft close suspension. Thermally Fused Laminate casegoods feature standard suspensions. Lateral files include anti tip mechanism that allow only one drawer to be opened at a time.

### Hinges

Units with doors include 95 degree swing hinges.

### Filing

Central park features a highly durable black plastic extrusion that is securely fastened into a route on top of the drawer to support hanging files. An adjustable crossbar is provided for all file drawers that enables legal/letter filing front to back or side-to-side based on the drawer size.

### Locks

Locks are Standard on all drawers below the worksurface. Random lock cores are installed at the factory. Some units may be shipped with the same key number. Locks are Silver, Black or Bronze and match pull finish unless otherwise specified.

DARRAN will also send lock cores separately to the dealer at your request. These units will be send with an empty lock core and the Dealer will receive a shipment of the requested lock core/keys.

### Keying

Keying is available either factory or field installed. Factory installed keying is random.

### Wire management

Wire management capabilities include standard and optional worksurface grommets. Specify W-1 under surface wire channels for organization and management of all communication wires and cords. Horizontal J-Channel wire management (Sku: W-1) is sold separately to conceal wire under worksurfaces.

### Grommets

Metal grommets are provided to match the drawer pull selection. Grommet is available in black, silver, white or antique brass. Must specify standard or non-standard location. Black plastic grommets are available as an option for vertical applications.

### Powerports

A large selection of power pods are available and handle power, data, docking stations and communication. See options section for selection.

### LED tasklights

LED task lighting provides high efficiency, low energy lighting with a long life. Recessed light is encased in silver aluminum channel with milk lense and rounded end caps. Lights are factory installed. Product specifications listed below:

- Diffuser creates a softer light and eliminates hot spots
- Touch dimmer switch
- Can be "daisy chained" up to 90W
- 4.6 watts per foot
- 120 LEDs per meter
- Certification: UL Listed
- 50,000 hour life span.

Color Temp is 4000K

## Central park quick ship finishes | specifications

STANDARD VENEER	PREMIUM VENEER	HIGH PRESSURE LAMINATE	THERMALLY FUSED LAMINATE
WAC Amber Cherry .....	N/A .....	GAC Amber Cherry .....	MAC Amber Cherry
WRC Caramel Cherry .....	N/A .....	N/A .....	N/A
WIC Crimson Cherry .....	N/A .....	GIC Crimson Cherry .....	N/A
WEC Ebony on Cherry .....	N/A .....	GEC Ebony .....	N/A
WHC Honey Cherry .....	N/A .....	GHC Honey Cherry .....	MHC Honey Cherry
WOC KoKo Cherry .....	N/A .....	GOC KoKo Cherry .....	MOC KoKo Cherry
WEW Executive Walnut .....	N/A .....	GEW Executive Walnut .....	N/A
WGW Gunstock Walnut .....	N/A .....	N/A .....	MGW Gunstock Walnut
WBW Henna Walnut .....	N/A .....	N/A .....	N/A
WSW Smokey Walnut .....	N/A .....	N/A .....	N/A
WNW Natural Walnut .....	N/A .....	GNW Natural Walnut .....	N/A

HPL TOPS ON TFL PRODUCTS Add 10% - Available with flat edge only

### Finish

ENVI-CT Green Certified European Technology Coatings Finish.



## Central park quick ship edges

### "W" & "G" Standard profile

Central Park Edge for "W" and "G" Styles

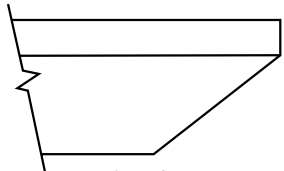

**Ledge\***

"W" 3mm Solid Hardwood Band  
"G" HPL Self Edge

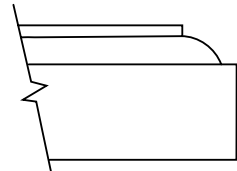

**Classic\***

"W" 3mm Solid Hardwood Band  
"G" HPL Self Edge

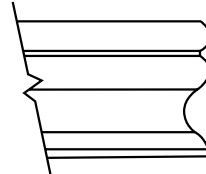

**Cobee**

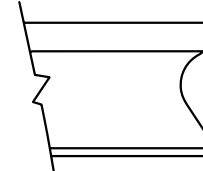

**Cove**

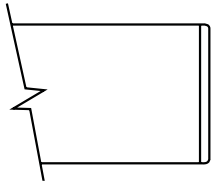

**Flat**

"W" 3mm Solid Hardwood Band  
"G" HPL Self Edge

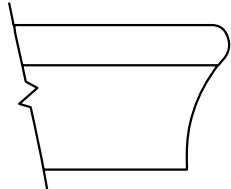

**Knife\***

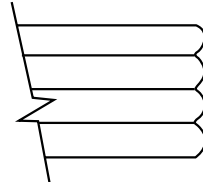

**Reed**

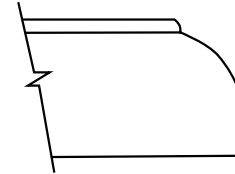

**Waterfall\***

\* Coping edges

### "M" Standard profile

Central Park Edges for "M" Styles

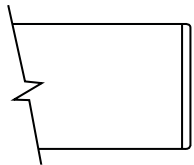

**Flat**

2 mm PVC Edge

# Central park quick ship pulls | knobs

## Pulls/knobs

Factory Installed

\$15 per pull on Overhead and Wall Hung units

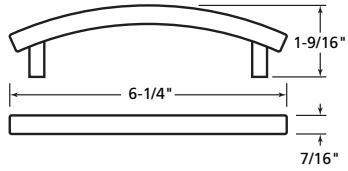

PL-112 Matte Black  
PL-113 Matte Nickel

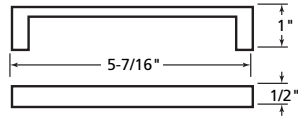

PL-115 Matte Black  
PL-116 Matte Nickel

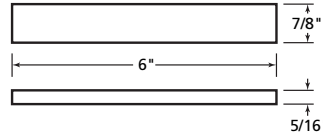

PL-210 Anodized Aluminum

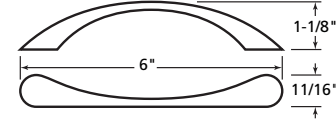

PL-105 Matte Black  
PL-106 Matte Nickel

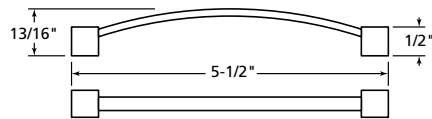

PL-125 Antique Pewter  
PL-126 Antique English  
PL-127 Matte Black

## Finger pulls

Arrow indicates finger pull location

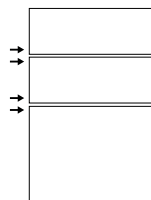

b/b/f

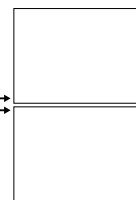

f/f

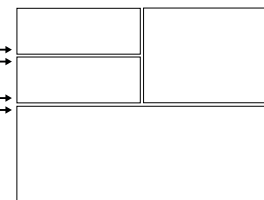

multi



lateral/lateral

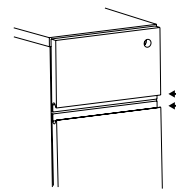

finger pull side view

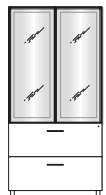

### Silverluma Frame Doors

Open with touch  
latch assist -  
without pulls

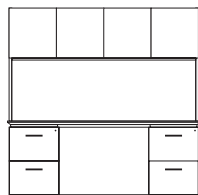

### Overhead Doors

Open with door  
bottom overhang.  
Pulls available on  
request

## Central park quick ship grommets | grommet reference

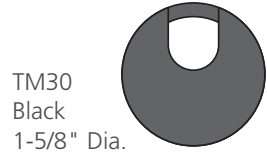

TM30  
Black  
1-5/8" Dia.

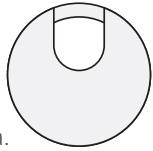

TM31  
Silver  
1-5/8" Dia.

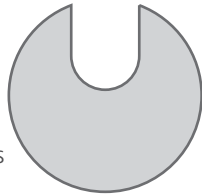

TM33  
Antique Brass  
2-1/2" Dia.

### Optional grommets

Factory Installed

Grommets (Standard Location)

Specify Color and Left/Right/Center - \$50 ea.

- Black: TM30-R (Right), TM30-L (Left), TM30-C (Center)

(Center)

- Silver: TM31-R (Right), TM31-L (Left), TM31-C (Center)

(Center)

- Antique Brass: TM33-R (Right), TM33-L (Left), TM33-C (Center)

(Center)

Grommets (Non-Standard Location)

Provide drawing w/ Grommet Location and Specify

Color - \$95 ea.

- Black: TM30-NS

- Silver: TM31-NS

- Antique Brass: TM33-NS

TM50  
Black  
1-5/8" Dia.

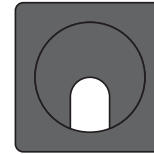

### Grommets (vertical surface)

Standard Location - \$50 ea.

- Black Plastic Vertical Surface: TM50-C (Bottom Center)

Non-Standard Location - \$95 ea.

- Black Plastic Vertical Surface: TM50-NS

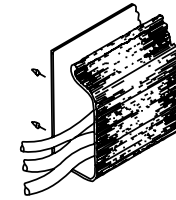

W1

### Horizontal J-channel

Horizontal J-Channel wire management (Sku: W-1) is sold separately to conceal wire under worksurfaces.

## Standard grommet location reference



Desk  
Specify Right or Left Grommet

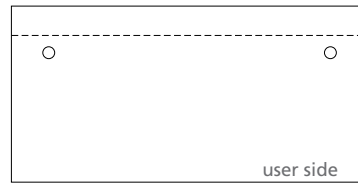

6" Overhang Desk  
Specify Right or Left Grommet

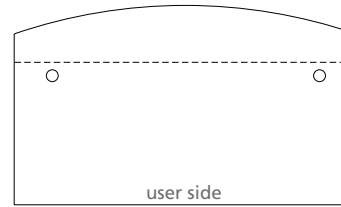

6"/12" Bow Front Desk  
Specify Right or Left Grommet



Bullet Conference Desk (Right Post)  
Center Grommet

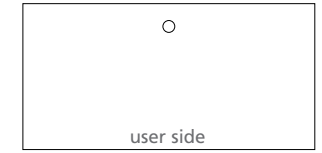

Bridge  
Center Grommet

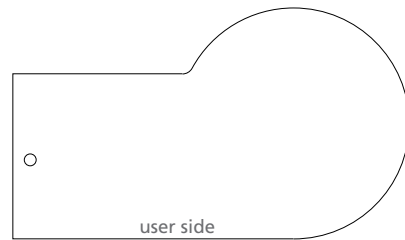

P Conference Desk (Right Post)  
Center Grommet



Return (Left Pedestal Shown)  
Right Pedestal - Left Grommet  
Left Pedestal - Right Grommet



Workstation Credenza  
Center Kneespace Grommet

# Central park quick ship height reference

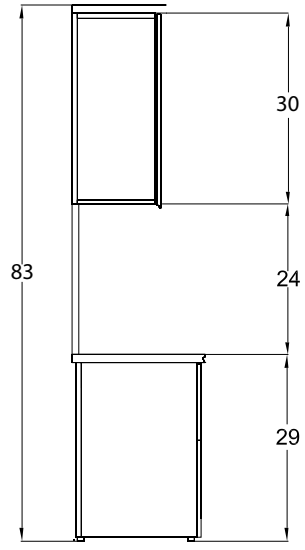

Typical Double Height Side Profile Wall Hung Overhead

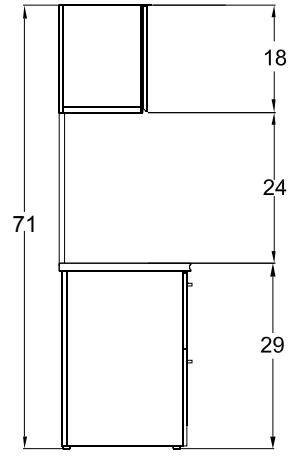

Typical Single Height Side Profile Wall Hung Overhead

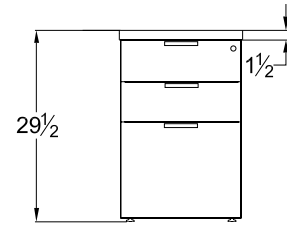

Pedestal Front Profile Box/Box/File

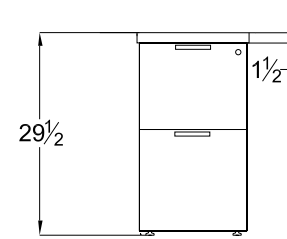

Pedestal Front Profile File/File

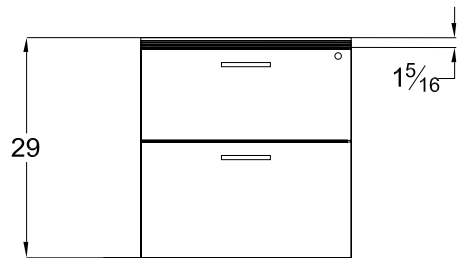

Pedestal Front Profile Lateral File

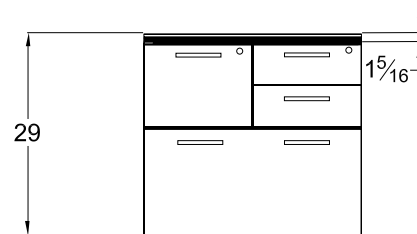

Pedestal Front Profile Multi-File

Central park quick ship modesty reference

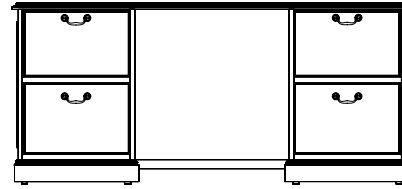
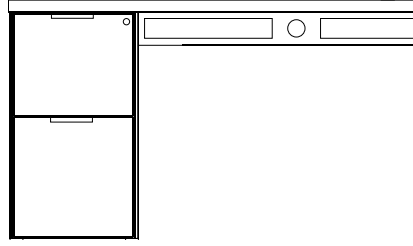
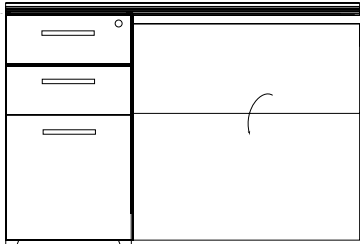

Top View

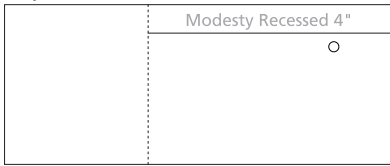

4" **M51**  
Open Back Modesty with 4"  
Wire Management Rail

**M37**  
Fixed Full Modesty

**M34**  
Drop Door Tech Modesty

## Central park quick ship door detail | grain direction

### Panel doors

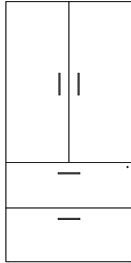

### Silverluma frame with frosted panel

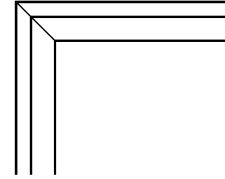
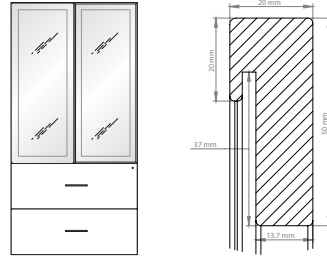

## Grain direction

Veneer chassis parts are vertical grain. The backs of Thermally Fused Laminate overheads, wall hungs, wall hung shelves and flush chassis desks are horizontal grain. Bridges, returns, and credenza kneespace Thermally Fused Laminate backs over 60" are horizontal grain. Doors feature vertical veneer bookmatched horizontally in sets of 2, 4, and 6 doors. Tower fronts are matched in vertical sets.



Desk

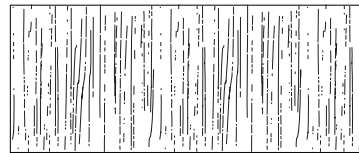

Runoff Desk  
Grain Direction on TFL Units  
Above 60" runs end to end

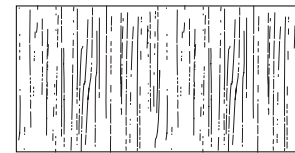

Bridge  
Grain Direction on TFL  
Units Above 60" runs end  
to end

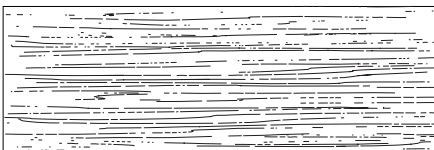

Credenza

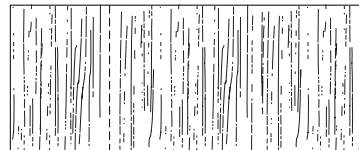

Return  
Grain Direction on TFL Units  
Above 60" runs end to end

## Central park quick ship drawer dimensions | filing reference

### Interior drawer dimensions

UNIT DEPTH	DRAWER TYPE	OVERALL DIMENSIONS			INTERIOR DRAWER DIMENSIONS			NOTES
		W	D	H	W	D	H	
15-5/8" Letter	36" Box	13-1/8	19-11/16	4	12-1/8	18-11/16	3-7/16	Units less than 72"
	36" File	13-1/8	19-11/16	9-13/16	12-1/8	18-11/16	9-5/16	Units less than 72"
	30" Box	13-1/8	19-11/16	4	12-1/8	18-11/16	3-7/16	Units less than 72"
	30" File	13-1/8	19-11/16	9-13/16	12-1/8	18-11/16	9-5/16	Units less than 72"
	24" Box	13-1/8	16-1/16	4	12-1/8	15-1/16	3-7/16	Units less than 72"
	24" File	13-1/8	16-1/16	9-13/16	12-1/8	15-1/16	9-5/16	Units less than 72"
29" Lateral	24" Box	26-1/2	16-1/16	4	25-1/2	15-1/16	3-7/16	Workstation Credenzas less than 82"
	24" File	26-1/2	16-1/16	9-13/16	25-1/2	15-1/16	9-5/16	Workstation Credenzas less than 82"
31" Lateral	24" File	28-9/16	16-1/16	9-13/16	27-9/16	15-1/16	9-5/16	Multi-File Lateral File
35" Lateral	24" Box	32-1/2	16-1/16	4	31-1/2	15-1/16	3-7/16	Workstation Credenzas over 83"
	24" File	32-1/2	16-1/16	9-13/16	31-1/2	15-1/16	9-5/16	Workstation Credenzas over 83"
41" Lateral	24" File	38-1/2	16-1/16	9-13/16	37-1/2	15-1/16	9-5/16	Wood Drawer Only

### Filing reference

#### Filing for 24" depth units

13 1/8" Wide File Drawer - 16 1/16" Deep

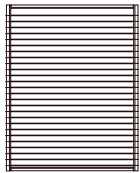

Letter Front to Back

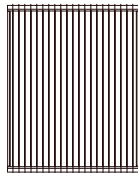

Legal Side to Side with File Rail

#### 29" and 31" Lateral File Drawer

29" : 26-1/2" Wide File Drawer - 16-1/16" Deep

31" : 28 9/16" Wide File Drawer - 16-1/16" Deep

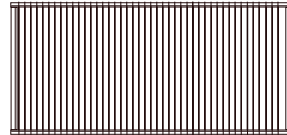

Legal Side to Side

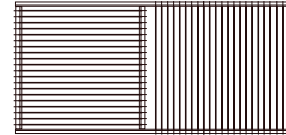

Legal Side to Side Letter Front to Back with File Rail

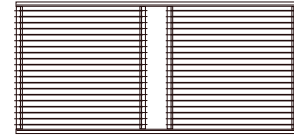

Letter Front to Back with File Rail

#### Filing for 30" & 36" depth units

13 1/8" Wide File Drawer - 19 11/16" Deep

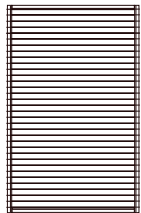

Letter Front to Back

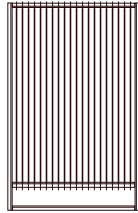

Legal Side to Side with File Rail

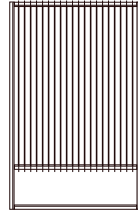

Letter Side to Side with File Rail

#### 35" AND 41" LATERAL FILE DRAWER

35" : 32-1/2" Wide File Drawer - 16-1/16" Deep

41" : 38-1/2" Wide File Drawer - 16 1/16" Deep

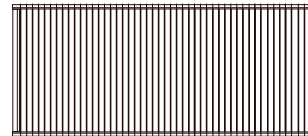

Legal Side to Side

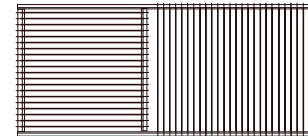

Legal Side to Side Letter Front to Back with File Rail

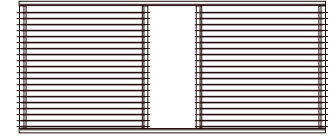

Letter Front to Back with File Rail

# Quick ship - Central park.

Breakfront Chassis Desks  
Double Pedestal Desk

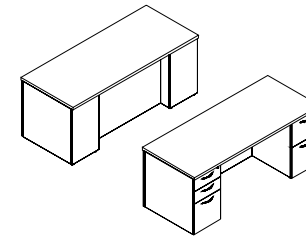

[View statement of line](#)

1 Select a model w" x d" x h"	weight	Standard Veneer Top Standard Veneer Chassis		Premium Veneer Top Premium Veneer Chassis		High Pressure Laminate Top Veneer Chassis		Thermally Fused Laminate Top Thermally Fused Laminate Chassis	
		72 x 36 x 29	315	CPC7236DD000W	3703	"P" Option N/A	CPC7236DD000G	3703	CPC7236DD000M
66 x 30 x 29	270	CPC6630DD000W	3576	"P" Option N/A	CPC6630DD000G	3576	CPC6630DD000M	1916	

2 Select a finish <a href="#">View finish details</a>	Standard Veneer Top		High Pressure Laminate Top		Thermally Fused Laminate Top	
	WAC	WNW	GAC	MAC	MHC	MOC
WRC		GIC				
WIC		GEC				
WEC		GHC				
WHC		GOC				
WOC		GEW				
WEW		GNW				
WGW						
WBW						
WSW						

3 Select an edge <a href="#">View edge details</a>	Standard Veneer Top				High Pressure Laminate Top				Thermally Fused Laminate Top
	Classic	Cobee	Cove	Flat	Classic	Cobee	Cove	Flat	Flat
Knife	Ledge	Reed	Waterfall	Knife	Ledge	Reed	Waterfall		

4 Select hardware <a href="#">View hardware details</a>	Standard Veneer Top		High Pressure Laminate Top		Thermally Fused Laminate Top	
	PL-105 Matte Black PL-106 Matte Nickel	PL-112 Matte Black PL-113 Matte Nickel	PL-105 Matte Black PL-106 Matte Nickel	PL-112 Matte Black PL-113 Matte Nickel	PL-105 Matte Black PL-106 Matte Nickel	PL-112 Matte Black PL-113 Matte Nickel
PL-115 Matte Black PL-116 Matte Nickel	PL-125 Antique Pewter PL-126 Antique English PL-127 Matte Black	PL-115 Matte Black PL-116 Matte Nickel	PL-125 Antique Pewter PL-126 Antique English PL-127 Matte Black	PL-115 Matte Black PL-116 Matte Nickel	PL-125 Antique Pewter PL-126 Antique English PL-127 Matte Black	
PL-210 Anodized Aluminum	Finger Pull "W"/"G"	PL-210 Anodized Aluminum	Finger Pull "W"/"G"	PL-210 Anodized Aluminum		

## Product features.

- Box/Box/File (left)
- Breakfront chassis
- File/File (right)
- Legal/Letter filing
- "W" & "G" SKUs feature soft close suspensions, "M" SKUs feature ball bearing suspensions. Both suspensions are full extension.

### NOTES

- All units are standard w/ flush ends
- Modesty is recessed 6"

## Options.

### ACCESSORIES

- K28: Articulating Keyboard w/ Mouse - \$390
- K31: Center drawer - \$205

### DRAWER

- P6: Modify File/File to Box/Box/File - \$55 per pedestal
- P33: Wood Drawer Upgrade - \$45 per drawer

### GROMMETS (STANDARD LOCATION)

- Specify Color and Left/Right - \$50 ea.
- Black: TM30-R (Right), TM30-L (Left)
  - Silver: TM31-R (Right), TM31-L (Left)
  - Antique Brass: TM33-R (Right), TM33-L (Left)

### GROMMETS (NON-STANDARD LOCATION)

- Provide drawing w/ Grommet Location and Specify Color - \$95 ea.
- Black: TM30-NS
  - Silver: TM31-NS
  - Antique Brass: TM33-NS



# Quick ship - Central park.

Breakfront Chassis Desks  
Bowfront Double Pedestal Desk

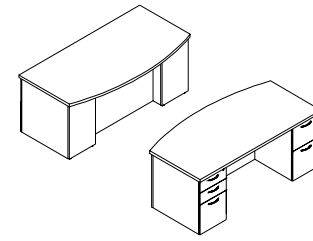

[View statement of line](#)

1 Select a model w" x d" x h"	weight	Standard Veneer Top	Premium Veneer Top	High Pressure Laminate Top	Thermally Fused Laminate Top
		Standard Veneer Chassis	Premium Veneer Chassis	Veneer Chassis	Thermally Fused Laminate Chassis
72 x 30/36 x 29  156	335	CPC7236DD006W 4120	"P" Option N/A	CPC7236DD006G 4120	CPC7236DD006M 2017
2 Select a finish <a href="#">View finish details</a>		WAC WNW WRC WIC WEC WHC WOC WEW GWG WBW WSW		GAC GIC GEC GHC GOC GEW GNW	MAC MHC MOC MGW
3 Select an edge <a href="#">View edge details</a>		Classic Cobee Cove Flat  Knife Ledge Reed Waterfall		Classic Cobee Cove Flat  Knife Ledge Reed Waterfall	Flat
4 Select hardware <a href="#">View hardware details</a>		PL-105 Matte Black PL-106 Matte Nickel  PL-115 Matte Black PL-116 Matte Nickel  PL-210 Anodized Aluminum  Finger Pull "W"/"G"		PL-105 Matte Black PL-106 Matte Nickel  PL-115 Matte Black PL-116 Matte Nickel  PL-210 Anodized Aluminum  Finger Pull "W"/"G"	PL-105 Matte Black PL-112 Matte Black PL-113 Matte Nickel  PL-115 Matte Black PL-116 Matte Nickel  PL-210 Anodized Aluminum  Finger Pull "W"/"G"

## Product features.

- Box/Box/File (left)
- Breakfront chassis
- File/File (right)
- Legal/Letter filing
- "W" & "G" SKUs feature soft close suspensions, "M" SKUs feature ball bearing suspensions. Both suspensions are full extension.

### NOTES

- All units are standard w/ flush ends
- Modesty is recessed 12"
- Overhang 6"

## Options.

### ACCESSORIES

- K28: Articulating Keyboard w/ Mouse - \$390
- K31: Center drawer - \$205

### DRAWER

- P6: Modify File/File to Box/Box/File - \$55 per pedestal
- P33: Wood Drawer Upgrade - \$45 per drawer

### GROMMETS (STANDARD LOCATION)

- Specify Color and Left/Right - \$50 ea.
- Black: TM30-R (Right), TM30-L (Left)
  - Silver: TM31-R (Right), TM31-L (Left)
  - Antique Brass: TM33-R (Right), TM33-L (Left)

### GROMMETS (NON-STANDARD LOCATION)



- Provide drawing w/ Grommet Location and Specify Color - \$95 ea.
- Black: TM30-NS
  - Silver: TM31-NS
  - Antique Brass: TM33-NS

# Quick ship - Central park.

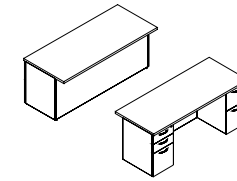
Flush Chassis Desks W/ Overhang  
Full Double Pedestal Desk



[View statement of line](#)

1 Select a model w" x d" x h"	weight	Standard Veneer Top	Premium Veneer Top	High Pressure Laminate Top	Thermally Fused Laminate Top
		Standard Veneer Chassis	Premium Veneer Chassis	Veneer Chassis	Thermally Fused Laminate Chassis
72 x 36 x 29  330		CPC7236DD032W 3546	"P" Option N/A	CPC7236DD032G 3546	CPC7236DD032M 2017
72 x 30 x 29  320		CPC7230DD032W 3426	"P" Option N/A	CPC7230DD032G 3426	CPC7230DD032M 1909
66 x 30 x 29  295		CPC6630DD032W 3295	"P" Option N/A	CPC6630DD032G 3295	CPC6630DD032M 1884

2 Select a finish <a href="#">View finish details</a>	Standard Veneer Top		High Pressure Laminate Top				Thermally Fused Laminate Top										
	WAC	WNW	GAC	GIC	GEC	GHC	GOC	GEW	GNW	MAC	MHC	MOC	MGW				
3 Select a edge <a href="#">View edge details</a>	Classic	Cobee	Cove	Flat	Knife	Ledge	Reed	Waterfall	Classic	Cobee	Cove	Flat	Knife	Ledge	Reed	Waterfall	Flat
	Knife	Ledge	Reed	Waterfall	Knife	Ledge	Reed	Waterfall	Knife	Ledge	Reed	Waterfall	Flat				

4 Select hardware <a href="#">View hardware details</a>	Standard Veneer Top		High Pressure Laminate Top				Thermally Fused Laminate Top						
	PL-105 Matte Black PL-106 Matte Nickel	PL-112 Matte Black PL-113 Matte Nickel	PL-105 Matte Black PL-106 Matte Nickel	PL-112 Matte Black PL-113 Matte Nickel	PL-115 Matte Black PL-116 Matte Nickel	PL-125 Antique Pewter PL-126 Antique English PL-127 Matte Black	PL-210 Anodized Aluminum	Finger Pull "W"/"G"	PL-105 Matte Black PL-106 Matte Nickel	PL-112 Matte Black PL-113 Matte Nickel	PL-115 Matte Black PL-116 Matte Nickel	PL-125 Antique Pewter PL-126 Antique English PL-127 Matte Black	PL-210 Anodized Aluminum

## Product features.

- Box/Box/File (left)
- File/File (right)
- Legal/Letter filing
- "W" & "G" SKUs feature soft close suspensions, "M" SKUs feature ball bearing suspensions. Both suspensions are full extension.

### NOTES

- All units are standard w/ flush ends
- Modesty is recessed 6"
- 36" units have 30" chassis
- 30" units have 24" chassis

## Options.

### ACCESSORIES

- K28: Articulating Keyboard w/ Mouse - \$390
- K31: Center drawer - \$205

### DRAWER

- P6: Modify File/File to Box/Box/File - \$55 per pedestal
- P33: Wood Drawer Upgrade - \$45 per drawer

### GROMMETS (STANDARD LOCATION)

- Specify Color and Left/Right - \$50 ea.
- Black: TM30-R (Right), TM30-L (Left)
  - Silver: TM31-R (Right), TM31-L (Left)
  - Antique Brass: TM33-R (Right), TM33-L (Left)

### GROMMETS (NON-STANDARD LOCATION)

- Provide drawing w/ Grommet Location and Specify Color - \$95 ea.
- Black: TM30-NS
  - Silver: TM31-NS
  - Antique Brass: TM33-NS

# Quick ship - Central park.

Double Breakfront / Single Pedestal Desks  
Single Full Pedestal

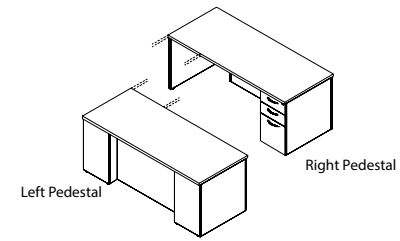

## 1 Select a model

w" x d" x h"

weight	Standard Veneer Top		Premium Veneer Top		High Pressure Laminate Top		Thermally Fused Laminate Top	
	Standard Veneer Chassis		Premium Veneer Chassis		Veneer Chassis		Thermally Fused Laminate Chassis	
<b>Left Pedestal</b>								
72 x 36 x 29	275	CPC7236DS009W	3465	"P" Option N/A	CPC7236DS009G	3465	CPC7236DS009M	1920
66 x 30 x 29	225	CPC6630DS009W	3112	"P" Option N/A	CPC6630DS009G	3112	CPC6630DS009M	1652
<b>Right Pedestal</b>								
72 x 36 x 29	275	CPC7236DS010W	3465	"P" Option N/A	CPC7236DS010G	3465	CPC7236DS010M	1920
66 x 30 x 29	225	CPC6630DS010W	3112	"P" Option N/A	CPC6630DS010G	3112	CPC6630DS010M	1652

[View statement of line](#)

## 2 Select a finish

[View finish details](#)

WAC WNW  
WRC  
WIC  
WEC  
WHC  
WOC  
WEW  
WGW  
WBW  
WSW

GAC  
GIC  
GEC  
GHC  
GOC  
GEW  
GNW

MAC  
MHC  
MOC  
MGW

## 3 Select a edge

[View edge details](#)

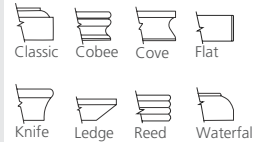

## 4 Select hardware

[View hardware details](#)

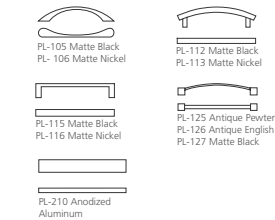
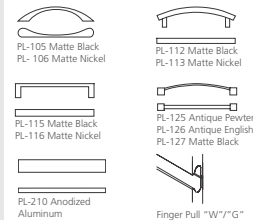
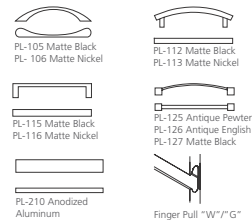

## Product features.

- Box/Box/File
- Full extension drawers - locking
- Hookup hardware
- Legal/Letter filing
- "W" & "G" SKUs feature soft close suspensions, "M" SKUs feature ball bearing suspensions. Both suspensions are full extension.

### NOTES

- 6" Recessed Modesty
- All units are standard w/ flush ends

## Options.

### ACCESSORIES

- K28: Articulating Keyboard w/ Mouse - \$390
- K31: Center drawer - \$205

### DRAWER

- P6: Modify Box/Box/File to File/File - \$55 per pedestal
- P33: Wood Drawer Upgrade - \$45 per drawer

### GROMMETS (STANDARD LOCATION)

- Specify Color and Left/Right - \$50 ea.
- Black: TM30-R (Right), TM30-L (Left)
  - Silver: TM31-R (Right), TM31-L (Left)
  - Antique Brass: TM33-R (Right), TM33-L (Left)

### GROMMETS (NON-STANDARD LOCATION)

- Provide drawing w/ Grommet Location and Specify Color - \$95 ea.
- Black: TM30-NS
  - Silver: TM31-NS
  - Antique Brass: TM33-NS

# Quick ship - Central park.

Double Breakfront / Single Pedestal Desks  
Bowfront Single Full Pedestal

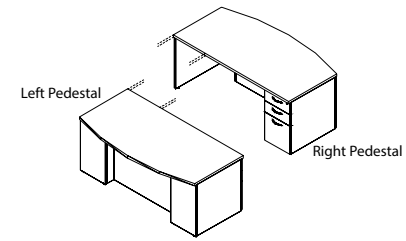

[View statement of line](#)

1 Select a model w" x d" x h"	weight	Standard Veneer Top	Premium Veneer Top	High Pressure Laminate Top	Thermally Fused Laminate Top
		Standard Veneer Chassis	Premium Veneer Chassis	Veneer Chassis	Thermally Fused Laminate Chassis
<b>Left Pedestal</b> 72 x 30/36 x 29  15	285	CPC7236DS017W 3686	"P" Option N/A	CPC7236DS017G 3686	CPC7236DS017M 1768
<b>Right Pedestal</b> 72 x 30/36 x 29  15	285	CPC7236DS018W 3686	"P" Option N/A	CPC7236DS018G 3686	CPC7236DS018M 1768

2 Select a finish <a href="#">View finish details</a>	3 Select a edge <a href="#">View edge details</a>	4 Select hardware <a href="#">View hardware details</a>
WAC WNW WRC WIC WEC WHC WOC WEW GWG WBW WSW	Classic Cobee Cove Flat  Knife Ledge Reed Waterfall	PL-105 Matte Black PL-106 Matte Nickel  PL-115 Matte Black PL-116 Matte Nickel  PL-210 Anodized Aluminum  Finger Pull "W"/"G"
GAC GIC GEC GHC GOC GEW GNW	Classic Cobee Cove Flat  Knife Ledge Reed Waterfall	PL-105 Matte Black PL-106 Matte Nickel  PL-115 Matte Black PL-116 Matte Nickel  PL-210 Anodized Aluminum  Finger Pull "W"/"G"
MAC MHC MOC MGW	Flat	PL-105 Matte Black PL-106 Matte Nickel  PL-115 Matte Black PL-116 Matte Nickel  PL-210 Anodized Aluminum

## Product features.

- Box/Box/File
- Full extension drawers - locking
- Hookup hardware
- Legal/Letter filing
- "W" & "G" SKUs feature soft close suspensions, "M" SKUs feature ball bearing suspensions. Both suspensions are full extension.

### NOTES

- 12" Recessed Modesty
- All units are standard w/ flush ends

## Options.

### ACCESSORIES

- K28: Articulating Keyboard w/ Mouse - \$390
- K31: Center drawer - \$205

### DRAWER

- P6: Modify Box/Box/File to File/File - \$55 per pedestal
- P33: Wood Drawer Upgrade - \$45 per drawer

### GROMMETS (STANDARD LOCATION)

- Specify Color and Left/Right - \$50 ea.
- Black: TM30-R (Right), TM30-L (Left)
  - Silver: TM31-R (Right), TM31-L (Left)
  - Antique Brass: TM33-R (Right), TM33-L (Left)

### GROMMETS (NON-STANDARD LOCATION)







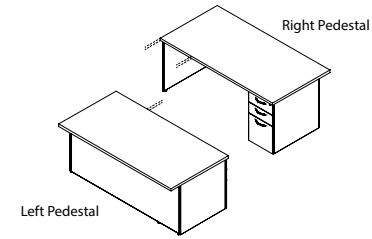



















- Provide drawing w/ Grommet Location and Specify Color - \$95 ea.
- Black: TM30-NS
  - Silver: TM31-NS
  - Antique Brass: TM33-NS

# Quick ship - Central park.

Flush Chassis Single Pedestal Desks W/ Overhang Top  
Single Full Pedestal



View statement of line

1 Select a model w" x d" x h"	weight	Standard Veneer Top	Premium Veneer Top	High Pressure Laminate Top	Thermally Fused Laminate Top	
		Standard Veneer Chassis	Premium Veneer Chassis	Veneer Chassis	Thermally Fused Laminate Chassis	
<b>Left Pedestal</b>						
72 x 36 x 29 	275	CPC7236DS640W	3187	"P" Option N/A	CPC7236DS640M	1768
72 x 30 x 29 	255	CPC7230DS640W	3151	"P" Option N/A	CPC7230DS640M	1661
66 x 30 x 29 	220	CPC6630DS640W	3080	"P" Option N/A	CPC6630DS640M	1620
<b>Right Pedestal</b>						
72 x 36 x 29 	275	CPC7236DS639W	3187	"P" Option N/A	CPC7236DS639M	1768
72 x 30 x 29 	255	CPC7230DS639W	3151	"P" Option N/A	CPC7230DS639M	1661
66 x 30 x 29 	220	CPC6630DS639W	3080	"P" Option N/A	CPC6630DS639M	1620
<b>2 Select a finish</b> <i>View finish details</i>		WAC WNW		GAC	MAC	
		WRC		GIC	MHC	
		WIC		GEC	MOC	
		WEC		GHC	MGW	
		WHC		GOC		
		WOC		GEW		
		WEW		GNW		
		WGW				
		WBW				
		WSW				
<b>3 Select a edge</b> <i>View edge details</i>		 Classic	 Cobee	 Cove	 Flat	
		 Knife	 Ledge	 Reed	 Waterfall	
<b>4 Select hardware</b> <i>View hardware details</i>		 PL-105 Matte Black PL-106 Matte Nickel	 PL-112 Matte Black PL-113 Matte Nickel	 PL-105 Matte Black PL-106 Matte Nickel	 PL-112 Matte Black PL-113 Matte Nickel	
		 PL-115 Matte Black PL-116 Matte Nickel	 PL-125 Antique Pewter PL-126 Antique English PL-127 Matte Black	 PL-115 Matte Black PL-116 Matte Nickel	 PL-125 Antique Pewter PL-126 Antique English PL-127 Matte Black	
		 FL-210 Anodized Aluminum	 Finger Pull "W"/"G"	 FL-210 Anodized Aluminum	 Finger Pull "W"/"G"	

## Product features.

- Box/Box/File
- Full extension drawers - locking
- Hookup hardware
- "W" & "G" SKUs feature soft close suspensions, "M" SKUs feature ball bearing suspensions. Both suspensions are full extension.

### NOTES

- 30"D Has 24"D Chassis
- 36"D Has 30"D Chassis
- 6" Overhang
- All units are standard w/ flush ends

## Options.

### ACCESSORIES

- K28: Articulating Keyboard w/ Mouse - \$390
- K31: Center drawer - \$205

### DRAWER

- P6: Modify Box/Box/File to File/File - \$55 per pedestal
- P33: Wood Drawer Upgrade - \$45 per drawer

### GROMMETS (STANDARD LOCATION)

- Specify Color and Left/Right - \$50 ea.
- Black: TM30-R (Right), TM30-L (Left)
  - Silver: TM31-R (Right), TM31-L (Left)
  - Antique Brass: TM33-R (Right), TM33-L (Left)

### GROMMETS (NON-STANDARD LOCATION)

- Provide drawing w/ Grommet Location and Specify Color - \$95 ea.
- Black: TM30-NS
  - Silver: TM31-NS
  - Antique Brass: TM33-NS

Quick ship - Central park.  
Conference Desks  
Bullet Conference Desk

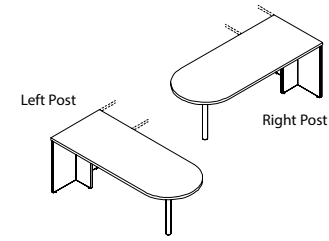

1 Select a model w" x d" x h"	weight	Standard Veneer Top	Premium Veneer Top	High Pressure Laminate Top	Thermally Fused Laminate Top
		Standard Veneer Chassis	Premium Veneer Chassis	Veneer Chassis	Thermally Fused Laminate Chassis
<b>Left Post</b>					
72 x 36 x 29	160	CPC7236DC716W 2892	"P" Option N/A	CPC7236DC716G 2892	CPC7236DC716M 1451
72 x 30 x 29	150	CPC7230DC716W 2779	"P" Option N/A	CPC7230DC716G 2779	CPC7230DC716M 1430
66 x 30 x 29	125	CPC6630DC716W 2734	"P" Option N/A	CPC6630DC716G 2734	CPC6630DC716M 1404
<b>Right Post</b>					
72 x 36 x 29	160	CPC7236DC715W 2892	"P" Option N/A	CPC7236DC715G 2892	CPC7236DC715M 1451
72 x 30 x 29	150	CPC7230DC715W 2779	"P" Option N/A	CPC7230DC715G 2779	CPC7230DC715M 1430
66 x 30 x 29	125	CPC6630DC715W 2734	"P" Option N/A	CPC6630DC715G 2734	CPC6630DC715M 1404
<b>2 Select a finish</b> <i>View finish details</i>		WAC WNW		GAC	MAC
		WRC		GIC	MHC
		WIC		GEC	MOC
<b>Metal finish</b>		WEC		GHC	MGW
MFS Silver (standard),		WHC		GOC	
MFB Black (optional)		WOC		GEW	
		WEW		GNW	
		WGW			
		WBW			
		WSW			
<b>3 Select a edge</b> <i>View edge details</i>		Classic	Cobee	Cove	Flat
		Knife	Ledge	Reed	Waterfall
<b>4 Select hardware</b> <i>View hardware details</i>		Hardware N/A		Hardware N/A	Hardware N/A

[View statement of line](#)

**Product features.**

- 3" Silver anodized aluminum post leg standard (Optional black leg - n/c)
- Hookup hardware
- "T" Panel end

**NOTES**

- All units are standard w/ flush ends
- Not Recommended for Freestanding Use
- "P" Tops and Bullets are not intended to be freestanding
- See Options Sections for Additional Bases Available.

**Options.**

**ACCESSORIES**

- K28: Articulating Keyboard w/ Mouse - \$390
- K31: Center drawer - \$205
- K31-SK: Center drawer w/ skirt - \$310

**GROMMETS (STANDARD LOCATION)**

- Specify Color - \$50 ea.
- Black: TM30-C (Center)
- Silver: TM31-C (Center)
- Antique Brass: TM33-C (Center)

**GROMMETS (NON-STANDARD LOCATION)**

- Provide drawing w/ Grommet Location and Specify Color - \$95 ea.
- Black: TM30-NS
- Silver: TM31-NS
- Antique Brass: TM33-NS

**MODESTY**

- MC50: Full veneer/Laminate modesty - \$185
- MC51: Half veneer/laminate modesty - \$130

Quick ship - Central park.  
Service Workstation Desks  
Bullet Service Desk

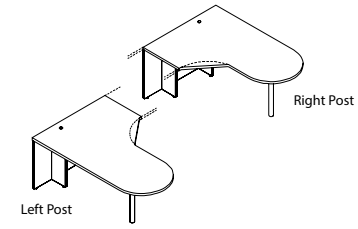

1 Select a model w" x d" x h"	weight	Standard Veneer Top	Premium Veneer Top	High Pressure Laminate Top	Thermally Fused Laminate Top
		Standard Veneer Chassis	Premium Veneer Chassis	Veneer Chassis	Thermally Fused Laminate Chassis
<b>Left Post</b> 72 x 30/48 x 29 <b>Right Post</b> 72 x 30/48 x 29	200	CPC7248DS737W 3365	"P" Option N/A	CPC7248DS737G 3365	CPC7248DS737M 1285
	200	CPC7248DS736W 3365	"P" Option N/A	CPC7248DS736G 3365	CPC7248DS736M 1285
2 Select a finish <i>View finish details</i>		WAC WNW		GAC	MAC
Metal finish MFS Silver (standard), MFB Black (optional)		WRC WIC WEC WHC WOC WEW WGW WBW WSW		GIC GEC GHC GOC GEW GNW	MHC MOC MGW
3 Select a edge <i>View edge details</i>		Classic Cobee Cove Flat Knife Ledge Reed Waterfall		Classic Cobee Cove Flat Knife Ledge Reed Waterfall	Flat
4 Select hardware <i>View hardware details</i>		Hardware N/A		Hardware N/A	Hardware N/A

*View statement of line*

**Product features.**

- 1 Standard grommet - matches pull finish or specify black TM30, silver TM31 or antique brass TM33
- 3" Silver anodized aluminum post leg standard (Optional black leg - n/c)

**NOTES**

- All units are standard w/ flush ends
- See Options Sections For Additional Support Legs Available.

**Options.**

**ACCESSORIES**

- K28: Articulating Keyboard w/ Mouse - \$390
- K31: Center drawer - \$205
- N/A with T80 or T90 options

**GROMMETS (NON-STANDARD LOCATION)**

- Provide drawing w/ Grommet Location and Specify Color - \$95 ea.
- Black: TM30-NS
  - Silver: TM31-NS
  - Antique Brass: TM33-NS

**MODESTY**

- MC50: Full veneer/Laminate modesty - \$185
- MC51: Half veneer/laminate modesty - \$130

**SERVICE DESKS**

- For Ledge, Classic, Cobee, Cove, Flat, Knife, Reed, and Waterfall edges, specify T80 or T81
- T80: Edge Curve User Side - n/c
- T81: Edge Approach Side Bowfront Edge - \$80

**Quick ship - Central park.**  
 "L" Workstation Returns  
 "L" Workstation Return - File/File

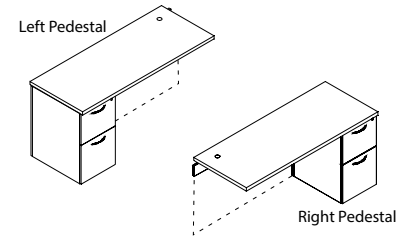

**1 Select a model**  
w" x d" x h"

weight	Standard Veneer Top		Premium Veneer Top		High Pressure Laminate Top		Thermally Fused Laminate Top	
	Standard Veneer Chassis		Premium Veneer Chassis		Veneer Chassis		Thermally Fused Laminate Chassis	
<b>Left Pedestal</b>								
48 x 24 x 29	125	CPC4824RE222W	2125	"P" Option N/A	CPC4824RE222G	2125	CPC4824RE222M	1194
42 x 24 x 29	120	CPC4224RE222W	2068	"P" Option N/A	CPC4224RE222G	2068	CPC4224RE222M	1178
<b>Right Pedestal</b>								
48 x 24 x 29	125	CPC4824RE223W	2125	"P" Option N/A	CPC4824RE223G	2125	CPC4824RE223M	1194
42 x 24 x 29	120	CPC4224RE223W	2068	"P" Option N/A	CPC4224RE223G	2068	CPC4224RE223M	1178

*View statement of line*

**2 Select a finish**  
*View finish details*

WAC	WNW	GAC	MAC
WRC		GIC	MHC
WIC		GEC	MOC
WEC		GHC	MGW
WHC		GOC	
WOC		GEW	
WEW		GNW	
WGW			
WBW			
WSW			

**3 Select a edge**  
*View edge details*

Classic Cobee Cove Flat	Knife Ledge Reed Waterfall	Classic Cobee Cove Flat	Flat
Knife Ledge Reed Waterfall	Knife Ledge Reed Waterfall	Knife Ledge Reed Waterfall	Flat

**4 Select hardware**  
*View hardware details*

PL-105 Matte Black PL-106 Matte Nickel	PL-112 Matte Black PL-113 Matte Nickel	PL-105 Matte Black PL-106 Matte Nickel	PL-112 Matte Black PL-113 Matte Nickel
PL-115 Matte Black PL-116 Matte Nickel	PL-125 Antique Pewter PL-126 Antique English PL-127 Matte Black	PL-115 Matte Black PL-116 Matte Nickel	PL-125 Antique Pewter PL-126 Antique English PL-127 Matte Black
FL-210 Anodized Aluminum	Finger Pull "W"/"G"	FL-210 Anodized Aluminum	Finger Pull "W"/"G"

## Product features.

- 1 Standard grommet - matches pull finish or specify black TM30, silver TM31 or antique brass TM33
- 4"H back rail - open back
- Full extension drawers - locking
- "W" & "G" SKUs feature soft close suspensions, "M" SKUs feature ball bearing suspensions. Both suspensions are full extension.

### NOTES

- All units are standard w/ flush ends
- Grain Direction Runs Front To Back On All "W" Units and Up to 60" on "G" and "M" Units

## Options.

### ACCESSORIES

- K28: Articulating Keyboard w/ Mouse - \$390

### DRAWER

- P33: Wood Drawer Upgrade - \$45 per drawer
- P40W: extra Box/Box/File or File/File to Kneespace - \$910 (W,G)

### GROMMETS (NON-STANDARD LOCATION)

Provide drawing w/ Grommet Location and Specify Color - \$95 ea.

- Black: TM30-NS
- Silver: TM31-NS
- Antique Brass: TM33-NS

### MODESTY

- M37: "W" "G" Style Fixed Full Modesty - \$130
- M37M: "M" Style Fixed Full Modesty - \$80









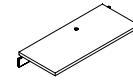











# Quick ship - Central park.

Bridges

Open Back With 4"H Wire Management Rail



[View statement of line](#)

1 Select a model w" x d" x h"	weight	Standard Veneer Top Standard Veneer Chassis		Premium Veneer Top Premium Veneer Chassis		High Pressure Laminate Top Veneer Chassis		Thermally Fused Laminate Top Thermally Fused Laminate Chassis	
		24"D							
48 x 24 x 29 	55	CPC4824BR151W	626	"P" Option N/A		CPC4824BR151G	626	CPC4824BR151M	469
42 x 24 x 29 	50	CPC4224BR151W	590	"P" Option N/A		CPC4224BR151G	590	CPC4224BR151M	447
2 Select a finish <a href="#">View finish details</a>		WAC WNW				GAC		MAC	
		WRC				GIC		MHC	
		WIC				GEC		MOC	
		WEC				GHC		MGW	
		WHC				GOC			
		WOC				GEW			
		WEW				GNW			
		WGW							
		WBW							
		WSW							
3 Select an edge <a href="#">View edge details</a>		 Classic	 Cobee	 Cove	 Flat	 Classic	 Cobee	 Cove	 Flat
		 Knife	 Ledge	 Reed	 Waterfall	 Knife	 Ledge	 Reed	 Waterfall
4 Select hardware <a href="#">View hardware details</a>		Hardware N/A				Hardware N/A		Hardware N/A	

## Product features.

- 1 Standard grommet - matches pull finish or specify black TM30, silver TM31 or antique brass TM33

## Options.

### ACCESSORIES

- K28: Articulating Keyboard w/ Mouse - \$390
- K31: Center drawer - \$205

### GROMMETS (NON-STANDARD LOCATION)

Provide drawing w/ Grommet Location and Specify Color - \$95 ea.

- Black: TM30-NS
- Silver: TM31-NS
- Antique Brass: TM33-NS

### MODESTY

- M37: "W" "G" Style Fixed Full Modesty - \$130
- M37M: "M" Style Fixed Full Modesty - \$80

Quick ship - Central park.  
Full Pedestal Credenzas  
File Storage Credenza

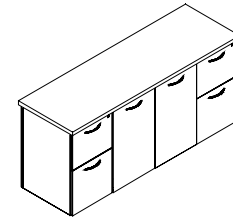

1 Select a model w" x d" x h"	weight	Standard Veneer Top Standard Veneer Chassis		Premium Veneer Top Premium Veneer Chassis		High Pressure Laminate Top Veneer Chassis		Thermally Fused Laminate Top Thermally Fused Laminate Chassis	
		<b>File/ File Storage Credenza</b>							
70 x 24 x 29	155	270	CPC7024CA050W	3437	"P" Option N/A	CPC7024CA050G	3437	CPC7024CA050M	2027
64 x 24 x 29	155	255	CPC6424CA050W	3106	"P" Option N/A	CPC6424CA050G	3106	CPC6424CA050M	2002
2 Select a finish <i>View finish details</i>		WAC	WNW			GAC		MAC	
		WRC				GIC		MHC	
		WIC				GEC		MOC	
		WEC				GHC		MGW	
		WHC				GOC			
		WOC				GEW			
		WEW				GNW			
		WGW							
		WBW							
		WSW							
3 Select a edge <i>View edge details</i>		Edge				Edge		Edge	
		N/A				N/A		N/A	
4 Select hardware <i>View hardware details</i>									
		PL-105 Matte Black PL-106 Matte Nickel	PL-112 Matte Black PL-113 Matte Nickel	PL-115 Matte Black PL-116 Matte Nickel	PL-125 Antique Pewter PL-126 Antique English PL-127 Matte Black	PL-210 Anodized Aluminum	Finger Pull "W"/"G"	PL-105 Matte Black PL-106 Matte Nickel	PL-112 Matte Black PL-113 Matte Nickel

*View statement of line*

**Product features.**

- Black adjustable shelf behind door set
- File/File
- Full extension drawers - locking
- Lateral File anti-tilt
- "W" & "G" SKUs feature soft close suspensions, "M" SKUs feature ball bearing suspensions. Both suspensions are full extension.

**NOTES**

- "M" Styles have matching "M" Finish Shelf
- All units are standard w/ flush ends
- Unit not designed for open plan use, standard with unfinished back. Select OPB Option for Open Plan application.

**Options.**

**DOOR**

- D2: Wood Door Lock - \$100 per door set
- D6A: "W"/"G" Styles - Delete Doors and replace black laminate shelf with finished shelf - n/c
- D9SC: Soft Close Door Hinges - \$20 per door

**DRAWER**

- P6: Modify File/File to Box/Box/File - \$55 per pedestal (CA050 only)
- P33: Wood Drawer Upgrade - \$45 per drawer

**GROMMETS (STANDARD LOCATION)**

- Specify Color and Left/Right/Center - \$50 ea.
- Black: TM30-R (Right), TM30-L (Left), TM30-C (Center)
- Silver: TM31-R (Right), TM31-L (Left), TM31-C (Center)
- Antique Brass: TM33-R (Right), TM33-L (Left), TM33-C (Center)

**GROMMETS (NON-STANDARD LOCATION)**

- Provide drawing w/ Grommet Location and Specify Color - \$95 ea.
- Black: TM30-NS
- Silver: TM31-NS
- Antique Brass: TM33-NS

**GROMMETS (VERTICAL SURFACE)**

- Standard Location - \$50 ea.
- Black Plastic Vertical Surface: TM50-C (Bottom Center)
- Non-Standard Location - \$95 ea.
- Black Plastic Vertical Surface: TM50-NS
- Open Plan - Finished Back
- OPB: "W" "G" Style - Modify Unit for Open Plan Application - \$295
- OPBM: "M" Style - Modify Unit for Open Plan Application - \$195

Quick ship - Central park.  
Full Pedestal Credenzas  
Kneespace Credenza

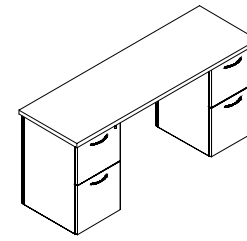

1 Select a model w" x d" x h"	weight	Standard Veneer Top Standard Veneer Chassis		Premium Veneer Top Premium Veneer Chassis		High Pressure Laminate Top Veneer Chassis		Thermally Fused Laminate Top Thermally Fused Laminate Chassis																																																																																																					
		<p><b>File/File Kneespace Credenza</b></p> <p>70 x 24 x 29  220 CPC7024CA054W 3173 64 x 24 x 29  210 CPC6424CA054W 3095</p>																																																																																																											
<p><b>2 Select a finish</b> <i>View finish details</i></p> <table border="0"> <tr> <td>WAC</td> <td>WNW</td> <td colspan="2"></td> <td colspan="2"></td> <td colspan="2"></td> <td colspan="2"></td> </tr> <tr> <td>WRC</td> <td></td> <td colspan="2"></td> <td colspan="2"></td> <td colspan="2"></td> <td colspan="2"></td> </tr> <tr> <td>WIC</td> <td></td> <td colspan="2"></td> <td colspan="2"></td> <td colspan="2"></td> <td colspan="2"></td> </tr> <tr> <td>WEC</td> <td></td> <td colspan="2"></td> <td colspan="2"></td> <td colspan="2"></td> <td colspan="2"></td> </tr> <tr> <td>WHC</td> <td></td> <td colspan="2"></td> <td colspan="2"></td> <td colspan="2"></td> <td colspan="2"></td> </tr> <tr> <td>WOC</td> <td></td> <td colspan="2"></td> <td colspan="2"></td> <td colspan="2"></td> <td colspan="2"></td> </tr> <tr> <td>WEW</td> <td></td> <td colspan="2"></td> <td colspan="2"></td> <td colspan="2"></td> <td colspan="2"></td> </tr> <tr> <td>WGW</td> <td></td> <td colspan="2"></td> <td colspan="2"></td> <td colspan="2"></td> <td colspan="2"></td> </tr> <tr> <td>WBSW</td> <td></td> <td colspan="2"></td> <td colspan="2"></td> <td colspan="2"></td> <td colspan="2"></td> </tr> <tr> <td>WSW</td> <td></td> <td colspan="2"></td> <td colspan="2"></td> <td colspan="2"></td> <td colspan="2"></td> </tr> </table>										WAC	WNW									WRC										WIC										WEC										WHC										WOC										WEW										WGW										WBSW										WSW									
WAC	WNW																																																																																																												
WRC																																																																																																													
WIC																																																																																																													
WEC																																																																																																													
WHC																																																																																																													
WOC																																																																																																													
WEW																																																																																																													
WGW																																																																																																													
WBSW																																																																																																													
WSW																																																																																																													
<p><b>3 Select a edge</b> <i>View edge details</i></p> <table border="0"> <tr> <td>Edge</td> <td>N/A</td> <td colspan="2"></td> <td colspan="2"></td> <td colspan="2"></td> <td colspan="2"></td> </tr> <tr> <td>N/A</td> <td></td> <td colspan="2"></td> <td colspan="2"></td> <td colspan="2"></td> <td colspan="2"></td> </tr> </table>										Edge	N/A									N/A																																																																																									
Edge	N/A																																																																																																												
N/A																																																																																																													
<p><b>4 Select hardware</b> <i>View hardware details</i></p> <table border="0"> <tr> <td></td> <td></td> <td></td> <td></td> <td></td> <td></td> <td></td> <td></td> <td></td> <td></td> <td></td> <td></td> </tr> <tr> <td>PL-105 Matte Black PL-106 Matte Nickel</td> <td>PL-112 Matte Black PL-113 Matte Nickel</td> <td>PL-115 Matte Black PL-116 Matte Nickel</td> <td>PL-125 Antique Pewter PL-126 Antique English PL-127 Matte Black</td> <td>PL-210 Anodized Aluminum</td> <td>Finger Pull "W"/"G"</td> <td>PL-105 Matte Black PL-106 Matte Nickel</td> <td>PL-112 Matte Black PL-113 Matte Nickel</td> <td>PL-115 Matte Black PL-116 Matte Nickel</td> <td>PL-125 Antique Pewter PL-126 Antique English PL-127 Matte Black</td> <td>PL-210 Anodized Aluminum</td> <td>Finger Pull "W"/"G"</td> </tr> </table>																						PL-105 Matte Black PL-106 Matte Nickel	PL-112 Matte Black PL-113 Matte Nickel	PL-115 Matte Black PL-116 Matte Nickel	PL-125 Antique Pewter PL-126 Antique English PL-127 Matte Black	PL-210 Anodized Aluminum	Finger Pull "W"/"G"	PL-105 Matte Black PL-106 Matte Nickel	PL-112 Matte Black PL-113 Matte Nickel	PL-115 Matte Black PL-116 Matte Nickel	PL-125 Antique Pewter PL-126 Antique English PL-127 Matte Black	PL-210 Anodized Aluminum	Finger Pull "W"/"G"																																																																												
PL-105 Matte Black PL-106 Matte Nickel	PL-112 Matte Black PL-113 Matte Nickel	PL-115 Matte Black PL-116 Matte Nickel	PL-125 Antique Pewter PL-126 Antique English PL-127 Matte Black	PL-210 Anodized Aluminum	Finger Pull "W"/"G"	PL-105 Matte Black PL-106 Matte Nickel	PL-112 Matte Black PL-113 Matte Nickel	PL-115 Matte Black PL-116 Matte Nickel	PL-125 Antique Pewter PL-126 Antique English PL-127 Matte Black	PL-210 Anodized Aluminum	Finger Pull "W"/"G"																																																																																																		

*View statement of line*

**Product features.**

- Full extension drawers - locking
- Kneespace w/ 4" H wire management rail channel - Open back
- File/File
- "W" & "G" SKUs feature soft close suspensions, "M" SKUs feature ball bearing suspensions. Both suspensions are full extension.

**NOTES**

- All units are standard w/ flush ends
- Unit not designed for open plan use, standard with unfinished back.
- Select OPB Option for Open Plan application.

**Options.**

**ACCESSORIES**

- K28: Articulating Keyboard w/ Mouse - \$390

**DRAWER**

- P6: Modify File/File to Box/Box/File - \$55 per pedestal (CA054 only)
- P33: Wood Drawer Upgrade - \$45 per drawer

**GROMMETS (STANDARD LOCATION)**

- Specify Color - \$50 ea.
- Black: TM30-C (Center)
  - Silver: TM31-C (Center)
  - Antique Brass: TM33-C (Center)

**GROMMETS (NON-STANDARD LOCATION)**

- Provide drawing w/ Grommet Location and Specify Color - \$95 ea.
- Black: TM30-NS
  - Silver: TM31-NS
  - Antique Brass: TM33-NS

**MODESTY**

- M37: "W" "G" Style Fixed Full Modesty - \$130
  - M37M: "M" Style Fixed Full Modesty - \$80
- Open Plan – Finished Back
- OPB: "W" "G" Style - Modify Unit for Open Plan Application - \$295
  - OPBM: "M" Style - Modify Unit for Open Plan Application - \$195



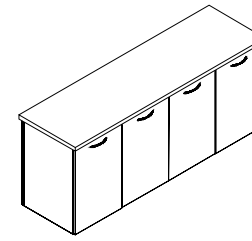

Quick ship - Central park.  
Full Pedestal Credenzas  
Storage Credenza













1 Select a model w" x d" x h"	weight	Standard Veneer Top Standard Veneer Chassis		Premium Veneer Top Premium Veneer Chassis		High Pressure Laminate Top Veneer Chassis		Thermally Fused Laminate Top Thermally Fused Laminate Chassis	
		70 x 24 x 29	225	CPC7024CA125W	3357	"P" Option N/A		CPC7024CA125G	3357

[View statement of line](#)

2 Select a finish <a href="#">View finish details</a>	WAC WNW	
		WRC
	WIC	
	WEC	
	WHC	
	WOC	
	WEW	
	WGW	
	WBW	
	WSW	
3 Select a edge <a href="#">View edge details</a>	Edge	
	N/A	

4 Select hardware <a href="#">View hardware details</a>	 PL-105 Matte Black PL-106 Matte Nickel		 PL-112 Matte Black PL-113 Matte Nickel	
		 PL-115 Matte Black PL-116 Matte Nickel	 PL-125 Antique Pewter PL-126 Antique English PL-127 Matte Black	
	 FL-210 Anodized Aluminum			

GAC	MAC
GIC	MHC
GEC	MOC
GHC	MGW
GOC	
GEW	
GNW	
Edge	Edge
N/A	N/A

 PL-105 Matte Black PL-106 Matte Nickel	 PL-112 Matte Black PL-113 Matte Nickel	 PL-105 Matte Black PL-106 Matte Nickel	 PL-112 Matte Black PL-113 Matte Nickel
 PL-115 Matte Black PL-116 Matte Nickel	 PL-125 Antique Pewter PL-126 Antique English PL-127 Matte Black	 PL-115 Matte Black PL-116 Matte Nickel	 PL-125 Antique Pewter PL-126 Antique English PL-127 Matte Black
 FL-210 Anodized Aluminum		 FL-210 Anodized Aluminum	

## Product features.

- Black adjustable shelf behind door set

### NOTES

- "M" Styles have matching "M" Finish Shelf
- All units are standard w/ flush ends
- Unit not designed for open plan use, standard with unfinished back. Select OPB Option for Open Plan application.

## Options.

### DOOR

- D2: Wood Door Lock - \$100 per door set
- D6A: "W"/"G" Styles - Delete Doors and replace black laminate shelf with finished shelf - n/c
- D9SC: Soft Close Door Hinges - \$20 per door

### GROMMETS (STANDARD LOCATION)

- Specify Color and Left/Right/Center - \$50 ea.
- Black: TM30-R (Right), TM30-L (Left), TM30-C (Center)
  - Silver: TM31-R (Right), TM31-L (Left), TM31-C (Center)

### GROMMETS (NON-STANDARD LOCATION)

- Provide drawing w/ Grommet Location and Specify Color - \$95 ea.
- Black: TM30-NS
  - Silver: TM31-NS
  - Antique Brass: TM33-NS

### GROMMETS (VERTICAL SURFACE)

- Standard Location - \$50 ea.
- Black Plastic Vertical Surface: TM50-C (Bottom Center)
  - Non-Standard Location - \$95 ea.
  - Black Plastic Vertical Surface: TM50-NS



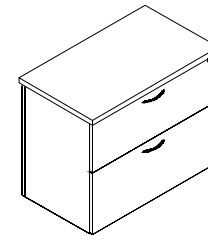

### OPEN PLAN - FINISHED BACK

- OPB: "W" "G" Style - Modify Unit for Open Plan Application - \$295
- OPBM: "M" Style - Modify Unit for Open Plan Application - \$195

**Quick ship - Central park.**  
Full Pedestal Credenzas  
Horizontal Lateral File



*View statement of line*

1 Select a model w" x d" x h"	weight	Standard Veneer Top Standard Veneer Chassis		Premium Veneer Top Premium Veneer Chassis		High Pressure Laminate Top Veneer Chassis		Thermally Fused Laminate Top Thermally Fused Laminate Chassis	
		35 x 24 x 29  	160	CPC3524CA104W	2025	"P" Option N/A		CPC3524CA104G	2025
29 x 24 x 29  	145	CPC2924CA104W	1844	"P" Option N/A		CPC2924CA104G	1844	CPC2924CA104M	1178













  

2 Select a finish <i>View finish details</i>	WAC WNW		GAC		MAC	
	WRC		GIC		MHC	
	WIC		GEC		MOC	
	WEC		GHC		MGW	
	WHC		GOC			
	WOC		GEW			
	WEW		GNW			
	WGW					
	WBW					
	WSW					

3 Select a edge <i>View edge details</i>	Edge N/A		Edge N/A		Edge N/A	
---	-------------	--	-------------	--	-------------	--

4 Select hardware <i>View hardware details</i>	 PL-105 Matte Black PL-106 Matte Nickel		 PL-112 Matte Black PL-113 Matte Nickel		 PL-105 Matte Black PL-106 Matte Nickel		 PL-112 Matte Black PL-113 Matte Nickel	
	 PL-115 Matte Black PL-116 Matte Nickel		 PL-125 Antique Pewter PL-126 Antique English PL-127 Matte Black		 PL-115 Matte Black PL-116 Matte Nickel		 PL-125 Antique Pewter PL-126 Antique English PL-127 Matte Black	
	 FL-210 Anodized Aluminum		 Finger Pull "W"/"G"		 FL-210 Anodized Aluminum		 Finger Pull "W"/"G"	

**Product features.**

- Anti-tilt safety feature
- Full extension drawers - locking
- Legal/Double letter filing
- "W" & "G" SKUs feature soft close suspensions, "M" SKUs feature ball bearing suspensions. Both suspensions are full extension.

**NOTES**

- All units are standard w/ flush ends
- Unit not designed for open plan use, standard with unfinished back. Select OPB Option for Open Plan application.

**Options.**

**DRAWER**

- P33: Wood Drawer Upgrade - \$45 per drawer

**OPEN PLAN – FINISHED BACK**

- OPB: "W" "G" Style - Modify Unit for Open Plan Application - \$295
- OPBM: "M" Style - Modify Unit for Open Plan Application - \$195

**Quick ship - Central park.**  
Full Pedestal Credenzas  
Vertical Lateral File

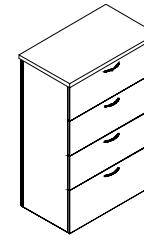

1 Select a model w" x d" x h"	weight	Standard Veneer Top Standard Veneer Chassis		Premium Veneer Top Premium Veneer Chassis		High Pressure Laminate Top Veneer Chassis		Thermally Fused Laminate Top Thermally Fused Laminate Chassis	
		4 Drawer 35 x 24 x 54  156	270	CPC3524FI111W	3354	"P" Option N/A		CPC3524FI111G	3354
2 Select a finish <i>View finish details</i>		WAC	WNW			GAC		MAC	
		WRC				GIC		MHC	
		WIC				GEC		MOC	
		WEC				GHC		MGW	
		WHC				GOC			
		WOC				GEW			
		WEW				GNW			
		WGW							
		WBW							
		WSW							
3 Select a edge <i>View edge details</i>		Edge				Edge		Edge	
		N/A				N/A		N/A	
4 Select hardware <i>View hardware details</i>		 PL-105 Matte Black PL-106 Matte Nickel	 PL-112 Matte Black PL-113 Matte Nickel	 PL-115 Matte Black PL-116 Matte Nickel	 PL-125 Antique Pewter PL-126 Antique English PL-127 Matte Black	 FL-210 Anodized Aluminum	 Finger Pull "W"/"G"	 PL-105 Matte Black PL-106 Matte Nickel	 PL-112 Matte Black PL-113 Matte Nickel
		 PL-115 Matte Black PL-116 Matte Nickel	 PL-125 Antique Pewter PL-126 Antique English PL-127 Matte Black	 FL-210 Anodized Aluminum	 Finger Pull "W"/"G"	 PL-105 Matte Black PL-106 Matte Nickel	 PL-112 Matte Black PL-113 Matte Nickel	 PL-115 Matte Black PL-116 Matte Nickel	 PL-125 Antique Pewter PL-126 Antique English PL-127 Matte Black
		 FL-210 Anodized Aluminum	 Finger Pull "W"/"G"	 PL-105 Matte Black PL-106 Matte Nickel	 PL-112 Matte Black PL-113 Matte Nickel	 PL-115 Matte Black PL-116 Matte Nickel	 PL-125 Antique Pewter PL-126 Antique English PL-127 Matte Black	 FL-210 Anodized Aluminum	 Finger Pull "W"/"G"

*View statement of line*

**Product features.**

- Anti-tilt safety feature
- Full extension drawers - locking
- Legal/Double letter filing
- "W" & "G" SKUs feature soft close suspensions, "M" SKUs feature ball bearing suspensions. Both suspensions are full extension.

**NOTES**

- All units are standard w/ flush ends
- Unit not designed for open plan use, standard with unfinished back. Select OPB Option for Open Plan application.

**Options.**

**DRAWER**

- P33: Wood Drawer Upgrade - \$45 per drawer

**OPEN PLAN – FINISHED BACK**

- OPB: "W" "G" Style - Modify Unit for Open Plan Application - \$295
- OPBM: "M" Style - Modify Unit for Open Plan Application - \$195

Quick ship - Central park.  
Workstation Credenzas  
"U" Workstation Credenza - File / File

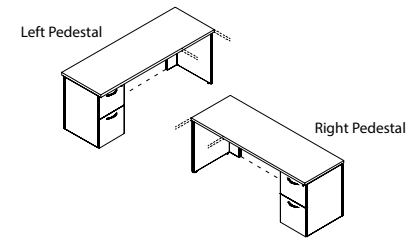

**1 Select a model**  
w" x d" x h"

weight	Standard Veneer Top		Premium Veneer Top		High Pressure Laminate Top		Thermally Fused Laminate Top	
	Standard Veneer Chassis		Premium Veneer Chassis		Veneer Chassis		Thermally Fused Laminate Chassis	
<b>Left Pedestal</b>								
70 x 24 x 29	180	CPC7024CA086W	2313	"P" Option N/A	CPC7024CA086G	2313	CPC7024CA086M	1367
64 x 24 x 29	170	CPC6424CA086W	2276	"P" Option N/A	CPC6424CA086G	2276	CPC6424CA086M	1351
<b>Right Pedestal</b>								
70 x 24 x 29	180	CPC7024CA087W	2313	"P" Option N/A	CPC7024CA087G	2313	CPC7024CA087M	1367
64 x 24 x 29	170	CPC6424CA087W	2276	"P" Option N/A	CPC6424CA087G	2276	CPC6424CA087M	1351

[View statement of line](#)

**2 Select a finish**  
[View finish details](#)

WAC	WNW	GAC	MAC
WRC		GIC	MHC
WIC		GEC	MOC
WEC		GHC	MGW
WHC		GOC	
WOC		GEW	
WEW		GNW	
WGW			
WBW			
WSW			

**3 Select a edge**  
[View edge details](#)

Edge	Edge	Edge	Edge
N/A	N/A	N/A	N/A

**4 Select hardware**  
[View hardware details](#)

<p>PL-105 Matte Black PL-106 Matte Nickel</p> <p>PL-115 Matte Black PL-116 Matte Nickel</p> <p>PL-210 Anodized Aluminum</p> <p>Finger Pull "W"/"G"</p>	<p>PL-112 Matte Black PL-113 Matte Nickel</p> <p>PL-125 Antique Pewter PL-126 Antique English PL-127 Matte Black</p> <p>Finger Pull "W"/"G"</p>	<p>PL-105 Matte Black PL-106 Matte Nickel</p> <p>PL-115 Matte Black PL-116 Matte Nickel</p> <p>PL-210 Anodized Aluminum</p> <p>Finger Pull "W"/"G"</p>	<p>PL-112 Matte Black PL-113 Matte Nickel</p> <p>PL-125 Antique Pewter PL-126 Antique English PL-127 Matte Black</p> <p>Finger Pull "W"/"G"</p>
--	---	--	---

**Product features.**

- 4"H back rail - open back
- Full extension drawers - locking
- Hookup hardware
- Legal/Double letter filing
- "W" & "G" SKUs feature soft close suspensions, "M" SKUs feature ball bearing suspensions. Both suspensions are full extension.

**NOTES**

- All units are standard w/ flush ends
- Unit not designed for open plan use, standard with unfinished back. Select OPB Option for Open Plan application.

**Options.**

**ACCESSORIES**

- K28: Articulating Keyboard w/ Mouse - \$390

**DRAWER**

- P6: Modify File/File to Box/Box/File - \$55 per pedestal
- P33: Wood Drawer Upgrade - \$45 per drawer
- P40W: extra Box/Box/File or File/File to Kneespace - \$910 (W, G)
- P40M: extra Box/Box/File or File/File to Kneespace - \$720 (M)

**GROMMETS (STANDARD LOCATION)**

- Specify Color - \$50 ea.
- Black: TM30-C (Center)
  - Silver: TM31-C (Center)
  - Antique Brass: TM33-C (Center)

**GROMMETS (NON-STANDARD LOCATION)**

- Provide drawing w/ Grommet Location and Specify Color - \$95 ea.
- Black: TM30-NS
  - Silver: TM31-NS
  - Antique Brass: TM33-NS

**MODESTY**

- M37: "W" "G" Style Fixed Full Modesty - \$130
- M37M: "M" Style Fixed Full Modesty - \$80
- Open Plan - Finished Back
- OPB: "W" "G" Style - Modify Unit for Open Plan Application - \$295
- OPBM: "M" Style - Modify Unit for Open Plan Application - \$195

Quick ship - Central park.  
Workstation Credenzas  
"U" Workstation Credenza - Lateral File

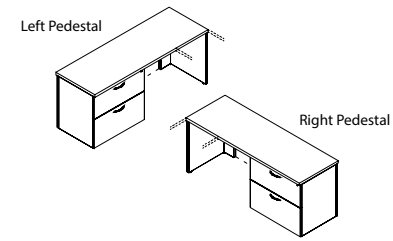

1 Select a model w" x d" x h"	weight	Standard Veneer Top Standard Veneer Chassis		Premium Veneer Top Premium Veneer Chassis		High Pressure Laminate Top Veneer Chassis		Thermally Fused Laminate Top Thermally Fused Laminate Chassis	
<b>Left Pedestal</b>									
* 70 x 24 x 29	215	CPC7024CA066W	2612	"P" Option N/A		CPC7024CA066G	2612	CPC7024CA066M	1504
* 64 x 24 x 29	200	CPC6424CA066W	2578	"P" Option N/A		CPC6424CA066G	2578	CPC6424CA066M	1488
<b>Right Pedestal</b>									
* 70 x 24 x 29	215	CPC7024CA067W	2612	"P" Option N/A		CPC7024CA067G	2612	CPC7024CA067M	1504
* 64 x 24 x 29	200	CPC6424CA067W	2578	"P" Option N/A		CPC6424CA067G	2578	CPC6424CA067M	1488
<i>View statement of line</i>									
2 Select a finish <i>View finish details</i>		WAC	WNW			GAC		MAC	
		WRC				GIC		MHC	
		WIC				GEC		MOC	
		WEC				GHC		MGW	
		WHC				GOC			
		WOC				GEW			
		WEW				GNW			
		WGW							
		WBW							
		WSW							
3 Select a edge <i>View edge details</i>		Edge				Edge		Edge	
		N/A				N/A		N/A	
4 Select hardware <i>View hardware details</i>									
		PL-105 Matte Black PL-106 Matte Nickel	PL-112 Matte Black PL-113 Matte Nickel			PL-105 Matte Black PL-106 Matte Nickel	PL-112 Matte Black PL-113 Matte Nickel	PL-105 Matte Black PL-106 Matte Nickel	PL-112 Matte Black PL-113 Matte Nickel
	PL-115 Matte Black PL-116 Matte Nickel	PL-125 Antique Pewter PL-126 Antique English PL-127 Matte Black			PL-115 Matte Black PL-116 Matte Nickel	PL-125 Antique Pewter PL-126 Antique English PL-127 Matte Black	PL-115 Matte Black PL-116 Matte Nickel	PL-115 Matte Black PL-116 Matte Nickel	PL-125 Antique Pewter PL-126 Antique English PL-127 Matte Black
	PL-210 Anodized Aluminum	Finger Pull "W"/"G"			PL-210 Anodized Aluminum	Finger Pull "W"/"G"	PL-210 Anodized Aluminum	PL-210 Anodized Aluminum	Finger Pull "W"/"G"

Product features.

- 4"H back rail - open back
- Full extension drawers - locking
- Hookup hardware
- Legal/Double letter filing
- "W" & "G" SKUs feature soft close suspensions, "M" SKUs feature ball bearing suspensions. Both suspensions are full extension.

NOTES

- (\*) Denotes Units w/ Kneespace Not Sufficient For Keyboard
- All units are standard w/ flush ends
- Unit not designed for open plan use, standard with unfinished back. Select OPB Option for Open Plan application.

Options.

ACCESSORIES

- K28: Articulating Keyboard w/ Mouse - \$390

DRAWER

- P33: Wood Drawer Upgrade - \$45 per drawer
- P40W: extra Box/Box/File or File/File to Kneespace - \$910 (N/A on 58") (W,G)
- P40M: extra Box/Box/File or File/File to Kneespace - \$720 (N/A on 58") (M)

GROMMETS (STANDARD LOCATION)

- Specify Color - \$50 ea.
- Black: TM30-C (Center)
- Silver: TM31-C (Center)
- Antique Brass: TM33-C (Center)

GROMMETS (NON-STANDARD LOCATION)

- Provide drawing w/ Grommet Location and Specify Color - \$95 ea.
- Black: TM30-NS
- Silver: TM31-NS
- Antique Brass: TM33-NS

MODESTY

- M37: "W" "G" Style Fixed Full Modesty - \$130
- M37M: "M" Style Fixed Full Modesty - \$80
- Open Plan - Finished Back
- OPB: "W" "G" Style - Modify Unit for Open Plan Application - \$295
- OPBM: "M" Style - Modify Unit for Open Plan Application - \$195



**Quick ship - Central park.**  
 Workstation Credenzas  
 "U" Workstation Credenza - Multi-File

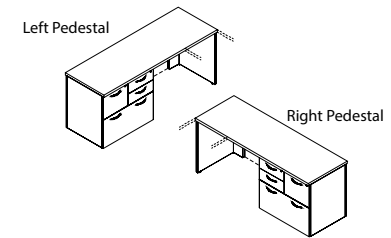

1 Select a model w" x d" x h"	weight	Standard Veneer Top Standard Veneer Chassis	Premium Veneer Top Premium Veneer Chassis	High Pressure Laminate Top Veneer Chassis	Thermally Fused Laminate Top Thermally Fused Laminate Chassis
<b>Left Pedestal</b>					
* 70 x 24 x 29	215	CPC7024CA667W 2987	"P" Option N/A	CPC7024CA667G 2987	CPC7024CA667M 1580
* 64 x 24 x 29	200	CPC6424CA667W 2950	"P" Option N/A	CPC6424CA667G 2950	CPC6424CA667M 1565
<b>Right Pedestal</b>					
* 70 x 24 x 29	215	CPC7024CA668W 2987	"P" Option N/A	CPC7024CA668G 2987	CPC7024CA668M 1580
* 64 x 24 x 29	200	CPC6424CA668W 2950	"P" Option N/A	CPC6424CA668G 2950	CPC6424CA668M 1565

*View statement of line*

2 Select a finish <i>View finish details</i>						
	WAC	WNW	GAC		MAC	
	WRC		GIC		MHC	
	WIC		GEC		MOC	
	WEC		GHC		MGW	
	WHC		GOC			
	WOC		GEW			
	WEW		GNW			
	WGW					
	WBW					
	WSW					
3 Select an edge <i>View edge details</i>	Edge		Edge		Edge	
	N/A		N/A		N/A	

4 Select hardware <i>View hardware details</i>						
	PL-105 Matte Black PL-106 Matte Nickel	PL-112 Matte Black PL-113 Matte Nickel	PL-105 Matte Black PL-106 Matte Nickel	PL-112 Matte Black PL-113 Matte Nickel	PL-105 Matte Black PL-106 Matte Nickel	PL-112 Matte Black PL-113 Matte Nickel
	PL-115 Matte Black PL-116 Matte Nickel	PL-125 Antique Pewter PL-126 Antique English PL-127 Matte Black	PL-115 Matte Black PL-116 Matte Nickel	PL-125 Antique Pewter PL-126 Antique English PL-127 Matte Black	PL-115 Matte Black PL-116 Matte Nickel	PL-125 Antique Pewter PL-126 Antique English PL-127 Matte Black
	PL-210 Anodized Aluminum	Finger Pull "W"/"G"	PL-210 Anodized Aluminum	Finger Pull "W"/"G"	PL-210 Anodized Aluminum	Finger Pull "W"/"G"

**Product features.**

- 4"H back rail - open back
- Full extension drawers - locking
- Hookup hardware
- Multi-file provides legal-double letter filing
- "W" & "G" SKUs feature soft close suspensions, "M" SKUs feature ball bearing suspensions. Both suspensions are full extension.

**NOTES**

- (\*) Denotes Units w/ Kneespace Not Sufficient For Keyboard
- All units are standard w/ flush ends
- Unit not designed for open plan use, standard with unfinished back. Select OPB Option for Open Plan application.

**Options.**

**ACCESSORIES**

- K28: Articulating Keyboard w/ Mouse - \$390

**DRAWER**

- P33: Wood Drawer Upgrade - \$45 per drawer
- P40W: extra Box/Box/File or File/File to Kneespace - \$910 (N/A on 58") (W,G)
- P40M: extra Box/Box/File or File/File to Kneespace - \$720 (N/A on 58") (M)

**GROMMETS (STANDARD LOCATION)**

- Specify Color - \$50 ea.
- Black: TM30-C (Center)
- Silver: TM31-C (Center)
- Antique Brass: TM33-C (Center)

**GROMMETS (NON-STANDARD LOCATION)**

- Provide drawing w/ Grommet Location and Specify Color - \$95 ea.
- Black: TM30-NS
- Silver: TM31-NS
- Antique Brass: TM33-NS

**MODESTY**

- M37: "W" "G" Style Fixed Full Modesty - \$130
- M37M: "M" Style Fixed Full Modesty - \$80
- Open Plan - Finished Back
- OPB: "W" "G" Style - Modify Unit for Open Plan Application - \$295
- OPBM: "M" Style - Modify Unit for Open Plan Application - \$195

# Quick ship - Central park.

Mobile Pedestals

Open Plan Mobile Desk Pedestal With Casters

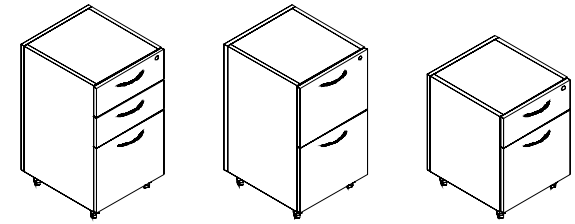

DARRAN™

1 Select a model w" x d" x h"	weight	Standard Veneer Top Standard Veneer Chassis		Premium Veneer Top Premium Veneer Chassis		High Pressure Laminate Top Veneer Chassis		Thermally Fused Laminate Top Thermally Fused Laminate Chassis	
		<b>Box/Box/File</b> 16 x 18 x 27  70	CPC1618PD424W	1427	"P" Option N/A	"G" Option N/A	CPC1618PD424M	1037	
<b>File/File</b> 16 x 18 x 27  70	CPC1618PD425W	1427	"P" Option N/A	"G" Option N/A	CPC1618PD425M	1037			
<b>Box/File</b> 16 x 18 x 23  55	CPC1618PD423W	1341	"P" Option N/A	"G" Option N/A	CPC1618PD423M	969			

*View statement of line*

2 Select a finish <i>View finish details</i>	WAC		WNW	GAC	GIC	GEC	GHC	GOC	GEW	GNW	MAC	MHC	MOC	MGW
	3 Select a edge <i>View edge details</i>	WEC	WHC											

4 Select hardware <i>View hardware details</i>	 PL-105 Matte Black PL-106 Matte Nickel		 PL-112 Matte Black PL-113 Matte Nickel		 PL-115 Matte Black PL-116 Matte Nickel		 PL-125 Antique Pewter PL-126 Antique English PL-127 Matte Black		 FL-210 Anodized Aluminum	 Finger Pull "W"/"G"

## Product features.

- Anti-tilt safety feature
- Finished all sides and top - open plan
- Full extension drawers - locking
- "W" & "G" SKUs feature soft close suspensions, "M" SKUs feature ball bearing suspensions. Both suspensions are full extension.

### NOTES

- Pedestal Cushion can be specified on all pedestals, but on Box/ Box/ File and File/File unit will not fit under work surface w/ cushion.

## Options.

### CUSHION

- BC16: Bench cushion
- Specify fabric grade (1 yd. required)

### DRAWER

- P33: Wood Drawer Upgrade - \$45 per drawer

## BC16 Cushion fabric grades.

COM	COL	1	2	3
224	N/A	261	279	297
4	5	6	7	8
315	333	351	369	387
9	10	11/ L1	12	13/ L2
405	423	441	459	495

**Quick ship - Central park.**  
Single Storage Overhead Console  
14" D Panel Door - 2/4/6 Section

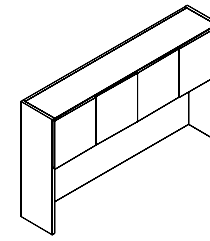

1 Select a model w" x d" x h"	weight	Standard Veneer Top	Premium Veneer Top	High Pressure Laminate Top	Thermally Fused Laminate Top
		Standard Veneer Chassis	Premium Veneer Chassis	Veneer Chassis	Thermally Fused Laminate Chassis
<b>4 Door / 2 Section</b>					
83 x 14 x 42  15	275	CPC8342OH325W 2995	"P" Option N/A	"G" Option N/A	CPC8342OH325M 1661
76 x 14 x 42  15	255	CPC7642OH325W 2772	"P" Option N/A	"G" Option N/A	CPC7642OH325M 1595
70 x 14 x 42  15	240	CPC7042OH325W 2562	"P" Option N/A	"G" Option N/A	CPC7042OH325M 1367
64 x 14 x 42  15	225	CPC6442OH325W 2537	"P" Option N/A	"G" Option N/A	CPC6442OH325M 1306
47 x 14 x 42  15	190	CPC4742OH325W 2416	"P" Option N/A	"G" Option N/A	CPC4742OH325M 1143
<b>2 Select a finish</b> <i>View finish details</i>		WAC WNW		GAC	MAC
		WRC		GIC	MHC
		WIC		GEC	MOC
		WEC		GHC	MGW
		WHC		GOC	
		WOC		GEW	
		WEW		GNW	
		WGW			
		WBW			
		WSW			
<b>3 Select an edge</b> <i>View edge details</i>		Edge		Edge	Edge
		N/A		N/A	N/A
<b>4 Select hardware</b> <i>View hardware details</i>					
		Finger Pull "W"/"G"		Finger Pull "W"/"G"	Finger Pull "W"/"G"

[View statement of line](#)

**Product features.**

- Finished top
- Interior cabinet depth 12.5"
- Panel doors with concealed finger pull

**NOTES**

- All units are standard w/ flush ends
- Unit has black back panel and is not designed for Open Plan use. Select OPB Option for Open Plan application

**Options.**

**DOOR**

- D2: Door Lock - \$100 per door set
- D6: Delete doors - n/c
- D9SC: Soft Close Door Hinges - \$20 per door

**GROMMETS (VERTICAL SURFACE)**

- Standard Location - \$50 ea.
- Black Plastic Vertical Surface: TM50-C (Bottom Center)
- Non-Standard Location - \$95 ea.
- Black Plastic Vertical Surface: TM50-NS

**TASK LIGHTING (RECESSED)**

- Overhead tasklight cord is located on the right facing side. If the opposite location is required please contact customer service.
- LT-LED24R: 24" LED Task light - \$190
- LT-LED48R: 48" LED Task light - \$245
- LT-LED60R: 60" LED Task light - \$310
- LT-LED72R: 72" LED Task light - \$335

**OPEN PLAN – FINISHED BACK**

- OPB: "W" "G" Style - Modify Unit for Open Plan Application - \$295
- OPBM: "M" Style - Modify Unit for Open Plan Application - \$195

# Quick ship - Central park.

Single Storage Overhead Console

14" D Silverluma Frame Doors / Frosted Inserts - 2/4/6 Section

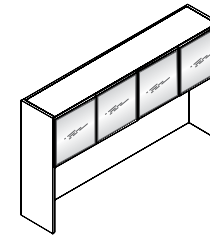

1 Select a model		Standard Veneer Top		Premium Veneer Top		High Pressure Laminate Top		Thermally Fused Laminate Top	
w" x d" x h"		Standard Veneer Chassis		Premium Veneer Chassis		Veneer Chassis		Thermally Fused Laminate Chassis	
<b>4 Door / 2 Section</b>									
70 x 14 x 42	→ 155	240	CPC7042OH321W	3071	"P" Option N/A	"G" Option N/A		CPC7042OH321M	1590
64 x 14 x 42	→ 155	225	CPC6442OH321W	3047	"P" Option N/A	"G" Option N/A		CPC6442OH321M	1529
2 Select a finish		WAC WNW				GAC		MAC	
<i>View finish details</i>		WRC				GIC		MHC	
		WIC				GEC		MOC	
		WEC				GHC		MGW	
		WHC				GOC			
		WOC				GEW			
		WEW				GNW			
		WGW							
		WBW							
		WSW							
3 Select an edge		Edge				Edge		Edge	
<i>View edge details</i>		N/A				N/A		N/A	
4 Select hardware		Hardware				Hardware		Hardware	
<i>View hardware details</i>		N/A				N/A		N/A	

[View statement of line](#)

## Product features.

- Finished top
- Interior cabinet depth 12.5"
- SilverLuma frame doors with frosted inserts

### NOTES

- Unit has black back panel and is not designed for Open Plan use.
- Select OPB Option for Open Plan application

## Options.

### DOOR

- D2: Door Lock - \$100 per door set
- D9SC: Soft Close Door Hinges - \$20 per door

### GROMMETS (VERTICAL SURFACE)

- Standard Location - \$50 ea.
- Black Plastic Vertical Surface: TM50-C (Bottom Center)
- Non-Standard Location - \$95 ea.
- Black Plastic Vertical Surface: TM50-NS

### INTERIOR CABINET LIGHT

- LEDPK starter kit includes Infeed, 1 Puck Interior Light and the ability to daisy chain up to 6 total Puck Lights
- LEDPK: LED Puck Starter Kit - \$310
- PK: 1 LED Interior Light - \$130 ea.

### TASK LIGHTING (RECESSED)

- Overhead tasklight cord is located on the right facing side. If the opposite location is required please contact customer service.
- LT-LED24R: 24" LED Task light - \$190
- LT-LED48R: 48" LED Task light - \$245
- LT-LED60R: 60" LED Task light - \$310
- LT-LED72R: 72" LED Task light - \$335

### OPEN PLAN – FINISHED BACK

- OPB: "W" "G" Style - Modify Unit for Open Plan Application - \$295
- OPBM: "M" Style - Modify Unit for Open Plan Application - \$195

## Central park tackboards.

### Overhead tackboards Full width tackboards

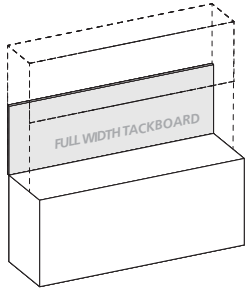

Product Width	Panel Dimension	SKU	COM	1	2	3	4	5	6	7	8	9	10	11/L1	12	13/L2
105"	103 x .5 x 21	FTOC10321	421	541	600	659	718	777	836	895	954	1013	1072	1131	1190	1308
99"	97 x .5 x 21	FTOC9721	399	510	565	620	675	730	785	840	895	950	1005	1060	1115	1225
93"	91 x .75 x 21	FTOC9121	379	480	531	582	633	684	735	786	837	888	939	990	1041	1143
87"	85 x .75 x 21	FTOC8521	358	449	497	545	593	641	689	737	785	833	881	929	977	1073
83"	81 x .75 x 21	FTOC8121	336	428	474	520	566	612	658	704	750	796	842	888	934	1026
76"	74 x .75 x 21	FTOC7421	309	392	435	478	521	564	607	650	693	736	779	822	865	951
70"	68 x .75 x 21	FTOC6821	282	361	401	441	481	521	561	601	641	681	721	761	801	881
64"	62 x .75 x 21	FTOC6221	256	330	366	402	438	474	510	546	582	618	654	690	726	798
58"	56 x .75 x 21	FTOC5621	234	299	331	363	395	427	459	491	523	555	587	619	651	715
47"	45 x .75 x 21	FTOC4521	187	242	269	296	323	350	377	404	431	458	485	512	539	593
35"	33 x .75 x 21	FTOC3321	141	180	200	220	240	260	280	300	320	340	360	380	400	440
29"	27 x .75 x 21	FTOC2721	112	149	166	183	200	217	234	251	268	285	302	319	336	370

### Overhead tackboards Half width tackboards

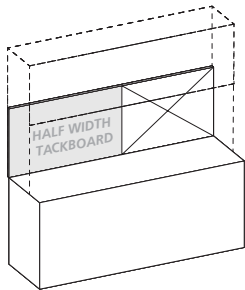

#### Standard Features

- Constructed of .5" thick fiberboard
- Hung with Z-Strip mounting system

- Fabric is precisely aligned and fitted to the tackboard
- Adhered to the rigid hardboard with glue

Product Width	Panel Dimension	SKU	COM	1	2	3	4	5	6	7	8	9	10	11/L1	12	13/L2
105 Half Width	52.5 x .75 x 21	FTOC5221	211	271	301	331	361	391	421	451	481	511	541	571	601	661
99 Half Width	49.5 x .75 x 21	FTOC4921	200	256	284	312	340	368	396	424	452	480	508	536	564	620
93 Half Width	46.5 x .75 x 21	FTOC4621	189	240	266	292	318	344	370	396	422	448	474	500	526	578
87 Half Width	43.5 x .75 x 21	FTOC4321	179	225	249	273	297	321	345	369	393	417	441	465	489	537
83 Half Width	41.5 x .75 x 21	FTOC4121	168	214	237	260	283	306	329	352	375	398	421	444	467	513
76 Half Width	38 x .75 x 21	FTOC3821	155	196	217	238	259	280	301	322	343	364	385	406	427	469
70 Half Width	35 x .75 x 21	FTOC3521	141	180	200	220	240	260	280	300	320	340	360	380	400	440
64 Half Width	32 x .75 x 21	FTOC3221	128	165	183	201	219	237	255	273	291	309	327	345	363	399

#### Standard Features

- Constructed of .5" thick fiberboard
- Fabric is precisely aligned and fitted to the tackboard
- Adhered to the rigid hardboard with glue
- Hung with Z-Strip mounting system

#### Notes

- Half width tackboards can be specified and combined with Marker Board, Slat Wall and Glass Board options. See "Half Width" items under product width.
- Must specify right or left facing tackboard

**Quick ship - Central park.**  
 Single Height Wall Hung Overheads  
 14" D Panel Doors - 1/2/3 Section

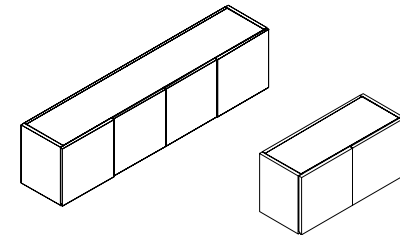

[View statement of line](#)

1 Select a model w" x d" x h"	weight	Standard Veneer Top Standard Veneer Chassis		Premium Veneer Top Premium Veneer Chassis		High Pressure Laminate Top Veneer Chassis		Thermally Fused Laminate Top Thermally Fused Laminate Chassis	
		<b>4 Door / 2 Section</b>							
83 x 14 x 18	210	CPC8318WH330W	3144	"P" Option N/A		"G" Option N/A		CPC8318WH330M	1585
76 x 14 x 18	195	CPC7618WH330W	3088	"P" Option N/A		"G" Option N/A		CPC7618WH330M	1467
70 x 14 x 18	180	CPC7018WH330W	2581	"P" Option N/A		"G" Option N/A		CPC7018WH330M	1356
64 x 14 x 18	160	CPC6418WH330W	2542	"P" Option N/A		"G" Option N/A		CPC6418WH330M	1316
47 x 14 x 18	125	CPC4718WH330W	1913	"P" Option N/A		"G" Option N/A		CPC4718WH330M	1215
<b>2 Door / 1 Section</b>									
35 x 14 x 18	75	CPC3518WH330W	1435	"P" Option N/A		"G" Option N/A		CPC3518WH330M	864
29 x 14 x 18	65	CPC2918WH330W	1412	"P" Option N/A		"G" Option N/A		CPC2918WH330M	828
<b>2 Select a finish</b> <a href="#">View finish details</a>		WAC	WSW			GAC		MAC	
		WRC	WNW			GIC		MHC	
		WIC				GEC		MOC	
		WEC				GHC		MGW	
		WHC				GOC			
		WOC				GEW			
		WEW				GNW			
		WGW							
		WBW							
<b>3 Select a edge</b> <a href="#">View edge details</a>		Edge				Edge		Edge	
		N/A				N/A		N/A	
<b>4 Select hardware</b> <a href="#">View hardware details</a>		"G"/>		"G"/>		"G"/>		"G"/>	

**Product features.**

- Doors fully matched set
- Finished top
- Interior cabinet depth 12"
- Mounting wall rail included
- Panel doors with concealed finger pull

**NOTES**

- All units are standard w/ flush ends
- Proper installation is critical to ensure safety from possible falling cabinets. The factory assumes no liability for damage or injury from the following: installation into non-load bearing or unlevel walls. Improper fasteners used in installation. Overloading of cabinets resulting in failures of wall and surrounding structures, fasteners, or cabinet construction. Misuse of cabinets for intended purposes.

**Options.**

**DOOR**

- D2: Door Lock - \$100 per door set
- D9SC: Soft Close Door Hinges - \$20 per door

**TASK LIGHTING (RECESSED)**

- Overhead tasklight cord is located on the right facing side. If the opposite location is required please contact customer service.
- LT-LED24R: 24" LED Task light - \$190
- LT-LED48R: 48" LED Task light - \$245
- LT-LED60R: 60" LED Task light - \$310
- LT-LED72R: 72" LED Task light - \$335

# Central park tackboards.

Wall hung tackboards  
Full width tackboards

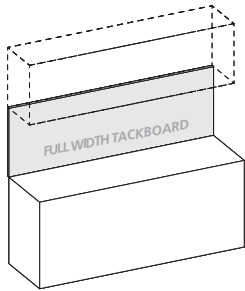

Product Width	Panel Dimension	SKU	COM	1	2	3	4	5	6	7	8	9	10	11/L1	12	13/L2
105	105 x .75 x 24	FTWH10524	530	650	709	768	827	886	945	1004	1063	1122	1181	1240	1299	1417
99	99 x .75 x 24	FTWH9924	502	613	668	723	778	833	888	943	998	1053	1108	1163	1218	1328
93	93 x .75 x 24	FTWH9324	465	576	627	678	729	780	831	882	933	984	1035	1086	1137	1239
87	87 x .75 x 24	FTWH8724	448	539	587	635	683	731	779	827	875	923	971	1019	1067	1163
83	83 x .75 x 24	FTWH8324	422	514	560	606	652	698	744	790	836	882	928	974	1020	1112
76	76 x .75 x 24	FTWH7624	388	471	514	557	600	643	686	729	772	815	858	901	944	1030
70	70 x .75 x 24	FTWH7024	355	434	474	514	554	594	634	674	714	754	794	834	874	954
64	64 x .75 x 24	FTWH6424	322	396	432	468	504	540	576	612	648	684	720	756	792	864
58	58 x .75 x 24	FTWH5824	294	359	391	423	455	487	519	551	583	615	647	679	711	775
47	47 x .75 x 24	FTWH4724	236	291	318	345	372	399	426	453	480	507	534	561	588	642
35	35 x .75 x 24	FTWH3524	176	217	237	257	277	297	317	337	357	377	397	417	437	477
29	29 x .75 x 24	FTWH2924	142	179	196	213	230	247	264	281	298	315	332	349	366	400

**Standard Features**

- Constructed of .5" thick fiberboard
- Fabric is precisely aligned and fitted to the tackboard
- Hung with Z-Strip mounting system

- Adhered to the rigid hardboard with glue

Wall hung tackboards  
Half width tackboards

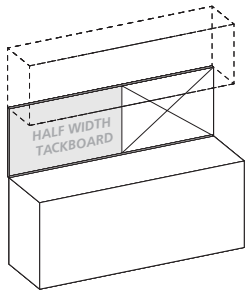

Product Width	Panel Dimension	SKU	COM	1	2	3	4	5	6	7	8	9	10	11/L1	12	13/L2
105 Half Width	52.5 x .75 x 24	FTWH5224	265	325	354	383	412	441	470	499	528	557	586	615	644	702
99 Half Width	49.5 x .75 x 24	FTWH4924	252	307	334	361	388	415	442	469	496	523	550	577	604	658
93 Half Width	46.5 x .75 x 24	FTWH4624	233	288	313	338	363	388	413	438	463	488	513	538	563	613
87 Half Width	43.5 x .75 x 24	FTWH4324	225	270	294	318	342	366	390	414	438	462	486	510	534	582
83 Half Width	41.5 x .75 x 24	FTWH4124	211	257	280	303	326	349	372	395	418	441	464	487	510	556
76 Half Width	38 x .75 x 24	FTWH3824	194	235	256	277	298	319	340	361	382	403	424	445	466	508
70 Half Width	35 x .75 x 24	FTWH3524	178	217	237	257	277	297	317	337	357	377	397	417	437	477
64 Half Width	32 x .75 x 24	FTWH3224	161	198	216	234	252	270	288	306	324	342	360	378	396	432

**Standard Features**

- Constructed of .5" thick fiberboard
- Fabric is precisely aligned and fitted to the tackboard
- Adhered to the rigid hardboard with glue
- Hung with Z-Strip mounting system

**Notes**

- Half width tackboards can be specified and combined with a Veneer Panel, Marker Board, Slat Wall or Glass Board. See "Half Width" items under product width.
- Specify right or left facing tackboard

**Quick ship - Central park.**  
Overhead Bookcases  
14" D Panel Doors / Storage

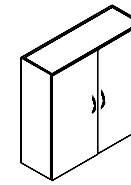

**1 Select a model**  
w" x d" x h"

	weight	Standard Veneer Top Standard Veneer Chassis	Premium Veneer Top Premium Veneer Chassis
35 x 14 x 42 	130	CPC3542OH383W 1901	"P" Option N/A
29 x 14 x 42 	120	CPC2942OH383W 1827	"P" Option N/A







**2 Select a finish**  
*View finish details*

	WAC	WSW
	WRC	WNW
	WIC	
	WEC	
	WHC	
	WOC	
	WEW	
	WGW	
	WBW	

**3 Select a edge**  
*View edge details*

	Edge
	N/A













**4 Select hardware**  
*View hardware details*

 PL-105 Matte Black PL-106 Matte Nickel	 PL-112 Matte Black PL-113 Matte Nickel
 PL-115 Matte Black PL-116 Matte Nickel	 PL-125 Antique Pewter PL-126 Antique English PL-127 Matte Black
 PL-210 Anodized Aluminum	 Touch Latch

*View statement of line*

High Pressure Laminate Top Veneer Chassis	Thermally Fused Laminate Top Thermally Fused Laminate Chassis
"G" Option N/A	CPC3542OH383M 1117
"G" Option N/A	CPC2942OH383M 1088

GAC	MAC
GIC	MHC
GEC	MOC
GHC	MGW
GOC	
GEW	
GNW	
Edge N/A	Edge N/A

 PL-105 Matte Black PL-106 Matte Nickel	 PL-112 Matte Black PL-113 Matte Nickel	 PL-105 Matte Black PL-106 Matte Nickel	 PL-112 Matte Black PL-113 Matte Nickel
 PL-115 Matte Black PL-116 Matte Nickel	 PL-125 Antique Pewter PL-126 Antique English PL-127 Matte Black	 PL-115 Matte Black PL-116 Matte Nickel	 PL-125 Antique Pewter PL-126 Antique English PL-127 Matte Black
 PL-210 Anodized Aluminum	 Touch Latch	 PL-210 Anodized Aluminum	 Touch Latch

**Product features.**

- 42" H Storage w/ 2 Finished adjustable shelves
- 54" H Storage w/ 3 Finished adjustable shelves
- Interior cabinet depth 12.5"
- "W" styles - 42" H units finished top, 54" H units black painted top

**NOTES**

- Unit has black back panel and is not designed for Open Plan use.
- Select OPB Option for Open Plan application

**Options.**

**DOOR**

- D2: Door Lock - \$100 per door
- D6: Delete doors - n/c
- D9SC: Soft Close Door Hinges - \$20 per door

**OPEN PLAN – FINISHED BACK**

- OPB: "W" "G" Style - Modify Unit for Open Plan Application - \$295
- OPBM: "M" Style - Modify Unit for Open Plan Application - \$195



**Quick ship - Central park.**  
Vertical Half Towers  
Storage Wardrobe - Panel Door

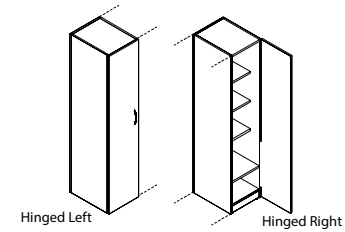

1 Select a model w" x d" x h"	weight	Standard Veneer Top Standard Veneer Chassis		Premium Veneer Top Premium Veneer Chassis		High Pressure Laminate Top Veneer Chassis		Thermally Fused Laminate Top Thermally Fused Laminate Chassis	
		<b>Door Hinged Left</b> 16 x 24 x 71	175	CPC1671TW283W	2683	"P" Option N/A		"G" Option N/A	
<b>Door Hinged Right</b> 16 x 24 x 71	175	CPC1671TW284W	2683	"P" Option N/A		"G" Option N/A		CPC1671TW284M	1335

2 Select a finish <i>View finish details</i>	WAC WSW WRC WNW WIC WEC WHC WOC WEW WGW WBW		GAC GIC GEC GHC GOC GEW GNW		MAC MHC MOC MGW	
3 Select a edge <i>View edge details</i>	Edge N/A		Edge N/A		Edge N/A	

4 Select hardware <i>View hardware details</i>	 PL-105 Matte Black PL-106 Matte Nickel		 PL-112 Matte Black PL-113 Matte Nickel		 PL-105 Matte Black PL-106 Matte Nickel		 PL-112 Matte Black PL-113 Matte Nickel	
	 PL-115 Matte Black PL-116 Matte Nickel		 PL-125 Antique Pewter PL-126 Antique English PL-127 Matte Black		 PL-115 Matte Black PL-116 Matte Nickel		 PL-125 Antique Pewter PL-126 Antique English PL-127 Matte Black	
	 FL-210 Anodized Aluminum		 Touch Latch		 FL-210 Anodized Aluminum		 Touch Latch	

*View statement of line*

**Product features.**

- 71" has 3 finished adjustable shelves/1 fixed
- 83" has 4 finished adjustable shelves/1 fixed
- Wardrobe w/ coat rod & hook
- "W" styles - 71" H units finished top, 83" H units black painted top

**NOTES**

- Unit has black back panel and is not designed for Open Plan use.
- Select OPB Option for Open Plan application

**Options.**

**DOOR**

- D2: Door lock - \$100
- D6: Delete doors - n/c
- D9SC: Soft Close Door Hinges - \$20 per door

**OPEN PLAN – FINISHED BACK**

- OPB: "W" "G" Style - Modify Unit for Open Plan Application - \$295
- OPBM: "M" Style - Modify Unit for Open Plan Application - \$195

**Quick ship - Central park.**  
Vertical Half Towers  
Storage / File - Panel Door

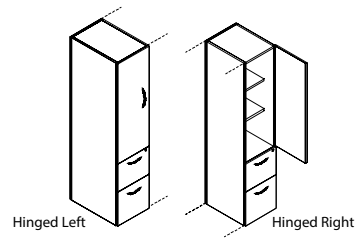

1 Select a model w" x d" x h"	weight	Standard Veneer Top Standard Veneer Chassis		Premium Veneer Top Premium Veneer Chassis		High Pressure Laminate Top Veneer Chassis		Thermally Fused Laminate Top Thermally Fused Laminate Chassis	
		<b>Door Hinged Left</b> 16 x 24 x 71	195	CPC1671TW291W	3145	"P" Option N/A		"G" Option N/A	
<b>Door Hinged Right</b> 16 x 24 x 71	195	CPC1671TW292W	3145	"P" Option N/A		"G" Option N/A		CPC1671TW292M	1606

2 Select a finish <i>View finish details</i>	Standard Veneer Top		High Pressure Laminate Top		Thermally Fused Laminate Top	
	WAC	WSW	GAC	MAC	MAC	
	WRC	WNW	GIC	MHC	MHC	
	WIC		GEC	MOC	MOC	
	WEC		GHC	MGW	MGW	
	WHC		GOC			
	WOC		GEW			
	WEW		GNW			
	WGW					
	WBW					

3 Select a edge <i>View edge details</i>	Standard Veneer Top		High Pressure Laminate Top		Thermally Fused Laminate Top	
	Edge		Edge	Edge	Edge	
	N/A		N/A	N/A	N/A	

4 Select hardware <i>View hardware details</i>	Standard Veneer Top		High Pressure Laminate Top		Thermally Fused Laminate Top	
	PL-105 Matte Black PL-106 Matte Nickel	PL-112 Matte Black PL-113 Matte Nickel	PL-105 Matte Black PL-106 Matte Nickel	PL-112 Matte Black PL-113 Matte Nickel	PL-105 Matte Black PL-106 Matte Nickel	PL-112 Matte Black PL-113 Matte Nickel
	PL-115 Matte Black PL-116 Matte Nickel	PL-125 Antique Pewter PL-126 Antique English PL-127 Matte Black	PL-115 Matte Black PL-116 Matte Nickel	PL-125 Antique Pewter PL-126 Antique English PL-127 Matte Black	PL-115 Matte Black PL-116 Matte Nickel	PL-125 Antique Pewter PL-126 Antique English PL-127 Matte Black
	PL-210 Anodized Aluminum	Touch Latch	PL-210 Anodized Aluminum	Touch Latch	PL-210 Anodized Aluminum	Touch Latch

*View statement of line*

**Product features.**  
 - 71" has 2 finished adjustable shelves  
 - 83" has 3 finished adjustable shelves  
 - Full extension drawers - locking  
 - "W" & "G" SKUs feature soft close suspensions, "M" SKUs feature ball bearing suspensions. Both suspensions are full extension.  
 - "W" styles - 71" H units finished top, 83" H units black painted top

**NOTES**  
 - All units are standard w/ flush ends  
 - Unit has black back panel and is not designed for Open Plan use.  
 - Select OPB Option for Open Plan application

**Options.**  
**DOOR**  
 - D2: Door lock - \$100  
 - D6: Delete doors - n/c  
 - D9SC: Soft Close Door Hinges - \$20 per door  
**DRAWER**  
 - P6: Modify File/File to Box/Box/File - \$55 per pedestal  
 - P33: Wood Drawer Upgrade - \$45 per drawer  
**OPEN PLAN – FINISHED BACK**  
 - OPB: "W" "G" Style - Modify Unit for Open Plan Application - \$295  
 - OPBM: "M" Style - Modify Unit for Open Plan Application - \$195

Quick ship - Central park.  
Bookcases  
14" D Open Bookcase

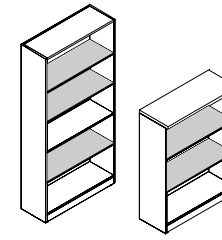

1 Select a model w" x d" x h"	weight	Standard Veneer Top Standard Veneer Chassis		Premium Veneer Top Premium Veneer Chassis		High Pressure Laminate Top Veneer Chassis		Thermally Fused Laminate Top Thermally Fused Laminate Chassis			
		<b>29" Width</b> 29 x 14 x 71 29 x 14 x 48	140	CPC2971BK250W	1888	"P" Option N/A	"G" Option N/A	CPC2971BK250M	1101	CPC2948BK250G	1508
<b>2 Select a finish</b> <a href="#">View finish details</a>	WAC WSW WRC WNW WIC WEC WHC WOC WEW WGW WBW					GAC GIC GEC GHC GOC GEW GNW		MAC MHC MOC MGW			
<b>3 Select a edge</b> <a href="#">View edge details</a>	Classic Cobee Cove Flat  Knife Ledge Reed Waterfall					Classic Cobee Cove Flat  Knife Ledge Reed Waterfall		Flat			
<b>4 Select hardware</b> <a href="#">View hardware details</a>	Hardware N/A					Hardware N/A		Hardware N/A			

[View statement of line](#)

**Product features.**

- 3/4" Thick finished shelves standard
- Interior cabinet depth 12.5"
- "W" styles - 29", 48", and 71" H units finished top, 83" H units black painted top

**NOTES**

- 30.75"H Open Bookcases are NOT meant to gang with desks, returns and credenzas. Unit is higher than regular worksurfaces to allow double binder storage. If matching height is desired, choose CPC3524CA125W or CPC2924CA125W with D6A option
- Adjustable shelves shaded
- Only 29" and 48"H units have profile edge/ shaped top
- Unit has black back panel and is not designed for Open Plan use. Select OPB Option for Open Plan application

**Options.**

**OPEN PLAN – FINISHED BACK**

- OPB: "W" "G" Style - Modify Unit for Open Plan Application - \$295
- OPBM: "M" Style - Modify Unit for Open Plan Application - \$195

## power & data options.

Cove power unit - non-linking

Style Number

List Price



PD-COVE PLUG

\$550

Non-linking version

### Specifications

- › Size 5.75" L x 2.5" W
- › (2) 15 Amp Receptacles and (2) USB charging ports
- › Surface Mount
- › 108" Cord
- › Standard Silver Finish, Available in White or Black Finish upon request
- › ETL Listed

Available: All DARRAN collections



# Rail price list



effective july 1, 2021

## Rail table of contents

Statement of Line	
Features & Advantages .....	1
Finishes   Specifications .....	3
Edges   Pulls .....	4
Grommets   Grommet Reference .....	5
Metal Legs .....	6
Drawer Dimensions   Filing Reference .....	7
Double Pedestal Desk .....	8
Single Pedestal Desk .....	9
Freestanding Desk .....	10
Double Breakfront Desk .....	11
Conference Desk .....	12
Runoff Desk .....	13
Return .....	14
Bridge .....	15
Credenzas .....	16
Open Storage/Pedestal Credenzas .....	18
Full Pedestal Credenzas .....	19
Workstation Credenza .....	20
Modular Pedestals .....	22
Mobile Pedestals .....	23
Sit on Overhead .....	24
Overhead Accessories .....	25
Single Height Wall Hung Overheads .....	29
Wall Hung Accessories .....	30
Single Height Shelves .....	35
Freestanding Half Towers .....	36
Freestanding Towers .....	38
Bookcases .....	39
Shared Storage .....	41
Locker Storage .....	45
Reception .....	47
Options .....	53
Power & Data .....	64

# Rail statement of line

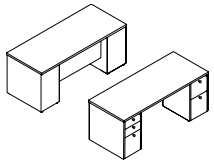

PAGE 8  
Double Pedestal Desks

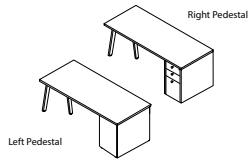

PAGE 9  
Single Pedestal Desks

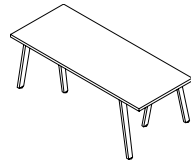

PAGE 10  
Freestanding Desk

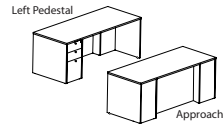

PAGE 11  
Double Breakfront Pedestal Desks

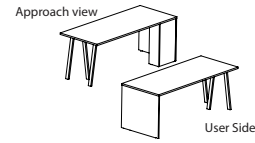

PAGE 12  
Conference Desk

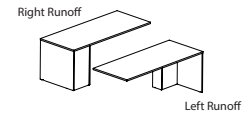

PAGE 13  
Runoff Desk



PAGE 14  
Return

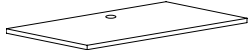

PAGE 15  
Bridge

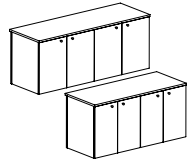

PAGE 16  
Credenza

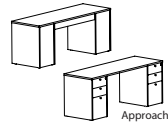

PAGE 17  
Credenza

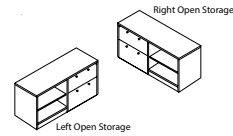

PAGE 18  
Open Storage/Pedestal Credenzas



PAGE 19  
Full Pedestal Credenzas

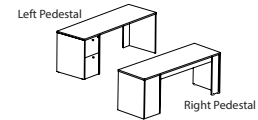

PAGE 20  
Credenza

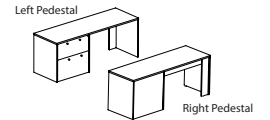

PAGE 21  
Credenza

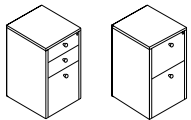

For use under 29"H work surfaces  
PAGE 22  
Modular Pedestals

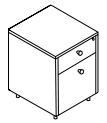

PAGE 23  
Mobile Peds

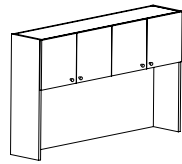

PAGE 24  
Overhead

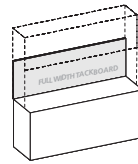

PAGE 25  
Overhead Tackboards

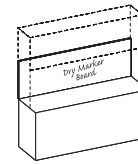

PAGE 26  
Overhead Dry Marker Boards

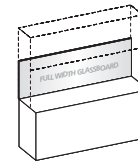

PAGE 27  
Overhead Glassboards

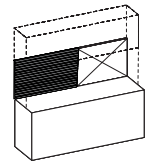

PAGE 28  
Overhead Slat Wall

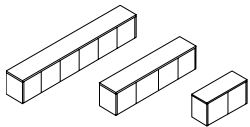

PAGE 29  
Single Height Wall Hung Overheads

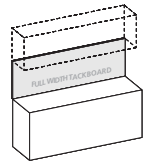

PAGE 30  
Wall Hung Tackboards

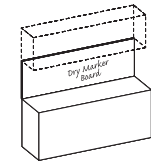

PAGE 31  
Wall Hung Dry Marker Boards

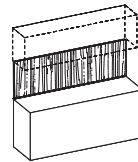

PAGE 32  
Wall Hung Veneer Panels

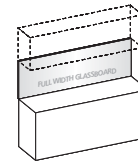

PAGE 33  
Wall Hung Glassboards

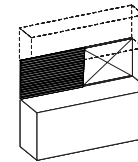

PAGE 34  
Wall Hung Slat Wall

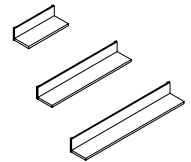

PAGE 35  
Single Height Wall Hung Overheads

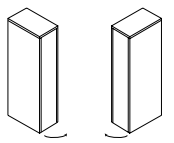

PAGE 36  
Freestanding Half Towers

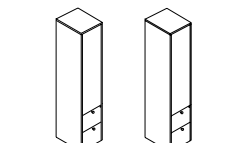

PAGE 37  
Freestanding Half Towers

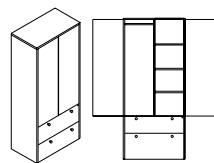

PAGE 38  
Freestanding Towers

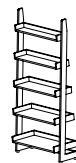

PAGE 39  
Bookcases

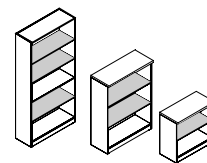

PAGE 40  
Bookcases

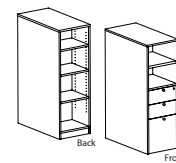

PAGE 41  
Storage

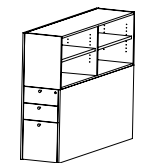

PAGE 42  
Storage

# Rail statement of line

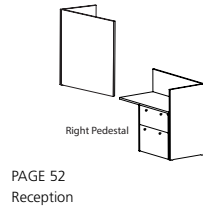
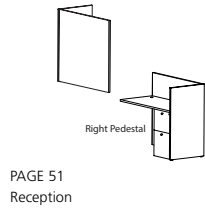
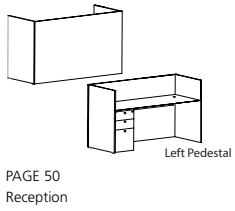
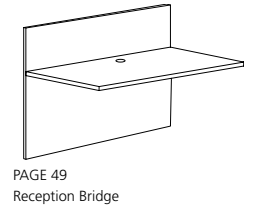
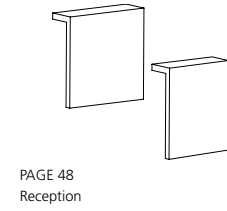
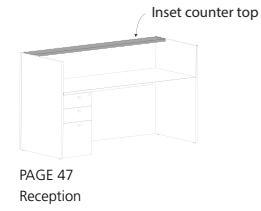
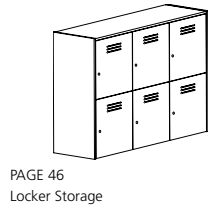
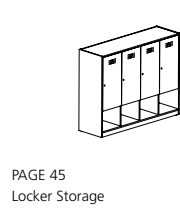
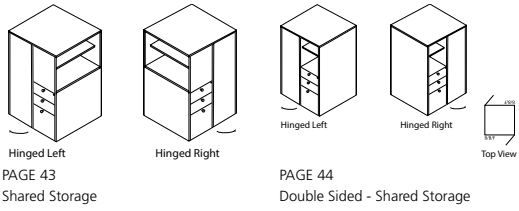



## Rail features & advantages

### Veneer

DARRAN only uses HPVA AA Grade Flat Cut Cherry, Maple, and Walnut Veneers. Rail is also available in double cut reconstituted walnut and oak patterns made from rapidly renewable wood veneer providing a repeatable consistent straight grain pattern. All veneers are selected and matched for balance and consistency.

### Veneer tops

Rail veneer tops feature a 45-pound density substrate with balanced 3-ply construction. Tops are 1-5/16" thick on MDF core comprised of 100% recycled and recovered wood fibers. All veneer tops are slipmatched and feature a 3mm external solid hardwood band or profile edge.

### Laminate tops

Rail high-pressure laminate tops feature a 45-pound density substrate with balanced 3-ply construction. Tops are 1-5/16" thick on MDF core comprised of 100% recycled and recovered wood fibers. All high pressure laminate tops are available with a profile edge, laminate self-edge or 2mm PVC edge band. Laminates in wood grain patterns feature a fine grain texture that features the polish and luxe of a real wood veneer with a subtle narrow grain structure.

### TFL tops

Thermally Fused Laminate tops feature a 45-pound density substrate with balanced 3-ply construction. Tops are 1-1/8" thick on MDF core that is comprised of 100% recycled and recovered wood fibers. All Thermally Fused Laminate tops are available with a 2mm flat PVC band. Laminates in wood grain patterns feature Timberline Texture providing the grain pattern of wood.

### Cleaning wood & laminate

In addition to regular dusting, give your furniture an occasional cleaning in accordance with our cleaning instructions. DARRAN wood and laminate products can be cleaned with a soft cloth and a mild soap and water mixture. Use approximately 32 oz of water mixed with one tablespoon of dish soap, always wiping with the grain. Dry with a soft cloth, going with the grain, to avoid spotting or streaking.

Wood products should be waxed periodically using a non-wax liquid; please do not use any waxy polish or cleaner. Interior of drawers may also be cleaned with mild soap and water mixture, or any household cleaner that is not petroleum or thinner-based.

### Chassis & pedestal

Chassis components are 3/4" thick core of particle board or MDF rated EPP/SCS/CARB-II material with 3-ply balanced construction. Pedestal and Cabinets feature dowel construction reinforced with steel bracket plates, wood cleats, screws and glue. All units are standard with 1" adjustable glides that allow for leveling of units that are

secured in solid wood glide blocks to prevent tearout.

### Overhead cabinet construction

#### Freestanding & wall mount

Freestanding Overhead storage cabinets are constructed of 1" and 3/4" thick core of particle board or MDF rated EPP/SCS/CARB-II material with 3-ply balanced construction. Panels are attached with cam fasteners in conjunction with dowels securely adhered with PVAc glue. All surface mount cabinets connect to work surface with anti-slip tape. Wall mount cabinets are mounted to the wall with steel "z" bracket attachment method using 5mm euro screws to attach to the back of the cabinet. All units ship with a steel "z" bracket. This bracket is mounted to the wall by field installers. Installers are responsible for selecting and supplying appropriate fasteners for wall conditions.

### Bookcase Construction

All chassis (sides, back, top and bottom panels) are constructed with 3/4" thick core of particle board or MDF rated EPP/SCS/CARB-II material with 3-ply balanced construction. Panels are attached with cam-lock fasteners in conjunction with dowels securely adhered with glue. Shelves on all units are 3/4" thick balance 3 ply panels. Optional heavy duty shelves are 1" thick lumber core balanced 5 ply construction.

### Tackboards

Wall mount tackboards are constructed of .75" thick fiberboard. The fabric is precisely aligned and fitted to the tackboard with a sock on cover. Overhead storage tackboards are constructed of .75" thick fiberboard. The fabric is precisely aligned and fitted to the tackboard and adhered to the rigid hardboard with staples. Wall mount cabinets are mounted to the wall with steel "z" bracket attachment method using 5mm euro screws to attach to the back of the cabinet. All units ship with a steel "z" bracket. This bracket is mounted to the wall by field installers. Installers are responsible for selecting and supplying appropriate fasteners for wall conditions.

### Adjustable glides

Glides provide 1" of vertical leveling adjustment. Glide bottom is durable metal. Glides are secured in solid wood blocks that are screwed and glued for durability.

### Drawers

All drawers are constructed with mitre joint/dowel construction in a natural maple finish with four sides and a bottom, which are attached to a drawer front with screws for easy removal. Drawer fronts are vertically matched in balanced sets. Pencil trays are standard in all box drawers. Drawers are constructed of 1/2" thick wood grained wrapped 5 sided miter-folded construction with 1/4" thick hardboard bottoms reinforced for heavy weight capacity. Drawers have been tested and pass BIFMA 50,000 cycle test. All drawers are guaranteed lifetime with free replacement warranty.

## Rail features & advantages

### Drawer fronts

Drawer fronts are vertically matched in balanced sets. Doors feature vertical veneer bookmatched horizontally in sets of 2 / 4 and 6 doors. All drawers and doors have traditional scallop profile edge shape. All tower fronts matched in vertical sets.

### Optional wood drawers

Optional hardwood veneer plywood drawers feature banded top and bottom edges for smoothness. Drawers are dowel joint construction with a UV cured finish over maple veneers, plus a lifetime free replacement guarantee. Optional Wood Drawer (Any Size) – Option Code P33...\$45 List Price Per Drawer

### Suspensions

All casegoods utilize cold rolled steel zinc plated high-grade drawer suspensions. All suspensions are warranted for the lifetime of the product. Box and File drawers are full extension, featuring steel ball bearings for a smoother quieter range of motion and are rated 100lbs. Lateral file drawers are a progressive action full extension suspension and is rated at 150lbs. Veneer and High Pressure laminate casegoods feature soft close suspension. Thermally Fused Laminate casegoods feature standard suspensions. Lateral files include anti tip mechanism that allow only one drawer to be opened at a time.

### Hinges

Units with doors include 95 degree swing hinges.

### Filing

Rail features a highly durable black plastic extrusion that is securely fastened into a route on top of the drawer to support hanging files. An adjustable crossbar is provided for all file drawers that enables legal/letter filing front to back or side-to-side based on the drawer size.

### Locks

Locks are Standard on all drawers below the worksurface. Random lock cores are installed at the factory. Some units may be shipped with the same key number. Locks are Silver, Black or Bronze and match pull finish unless otherwise specified.

DARRAN will also send lock cores separately to the dealer at your request. These units will be send with an empty lock core and the Dealer will receive a shipment of the requested lock core/keys.

### Keying

Keying is available either factory or field installed. Factory installed keying is random.

### Wire management

Wire management capabilities include standard and optional worksurface grommets. Specify W-1 under surface wire channels for organization and management of all communication wires and cords. Horizontal J-Channel wire management (Sku: W-1) is sold separately to conceal wire under worksurfaces.

### Grommets

Metal grommets are provided to match the drawer pull selection. Grommet is available in black or silver. Must specify standard or non-standard location. Black plastic grommets are available as an option for vertical applications.

### Powerports

A large selection of power pods are available and handle power, data, docking stations and communication. See options section for selection.

### LED tasklights

LED task lighting provides high efficiency, low energy lighting with a long life. Recessed light is encased in silver aluminum channel with milk lense and rounded end caps. Lights are factory installed. Product specifications listed below:

- Diffuser creates a softer light and eliminates hot spots
- Touch dimmer switch
- Can be "daisy chained" up to 90W
- 4.6 watts per foot
- 120 LEDs per meter
- Certification: UL Listed
- 50,000 hour life span.

Color Temp is 4000K

## Rail finishes | specifications

STANDARD VENEER	PREMIUM VENEER	HIGH PRESSURE LAMINATE	THERMALLY FUSED LAMINATE
WAC Amber Cherry .....	N/A .....	GAC Amber Cherry .....	MAC Amber Cherry
WEC Ebony on Cherry .....	N/A .....	GEC Ebony .....	MEC Ebony
WOC KoKo Cherry .....	N/A .....	GOC KoKo Cherry .....	MOC KoKo Cherry
WAM Alabaster Maple .....	N/A .....	GAM Alabaster Maple .....	N/A
WCM Clear Maple .....	N/A .....	GCM Clear Maple .....	N/A
WWM Wheat Maple .....	N/A .....	GWM Wheat Maple .....	N/A
WGW Gunstock Walnut .....	N/A .....	N/A .....	MGW Gunstock Walnut
WBW Henna Walnut .....	N/A .....	N/A .....	N/A
WSW Smokey Walnut .....	N/A .....	N/A .....	N/A
WNW Natural Walnut .....	N/A .....	GNW Natural Walnut .....	N/A
N/A .....	TSTV Studio Teak Walnut .....	GSTV Studio Teak Walnut +10% .....	MTW Studio Teak Walnut
N/A .....	TSMV Seattle Mist .....	N/A .....	N/A
N/A .....	TSLV Skyline Walnut .....	GSLV Skyline Walnut +10% .....	MSW Skyline Walnut
WWP Designer White Paint .....	N/A .....	GWL Designer White .....	MWL Designer White

HPL TOPS ON TFL PRODUCTS Add 10% - Available with flat edge only

Send 3x3 or larger finish chip for color match. Custom finish upcharge is 3% or \$250 Net (whichever is greater).

### Finish

ENVI-CT Green Certified European Technology Coatings Finish.

## Rail edges | pulls

### Edge profile Standard

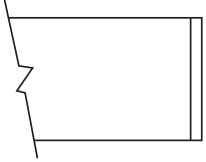

#### Flat

"W" 3mm Solid Hardwood Band  
"G" HPL Self Edge

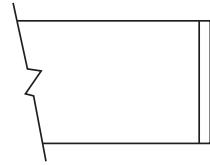

#### Flat

"M" 2mm PVC Edge

### Optional

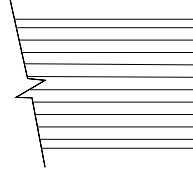

#### Exposed plywood

1 1/4 inch  
Baltic Birch Plywood  
clear coat finish

## Pulls/knobs

Factory Installed Optional

### Standard

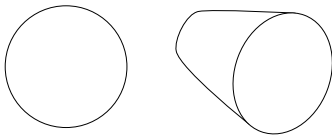

DK-150  
Black

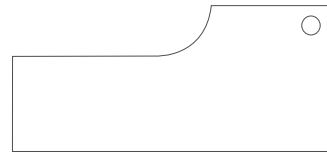

Finger Pull  
Only available on exposed  
plywood

## Grain direction

Veneer chassis parts are vertical grain. The backs of Thermally Fused Laminate overheads, wall hungs, wall hung shelves and flush chassis desks are horizontal grain. Bridges, returns, and credenza kneespace Thermally Fused Laminate backs over 60" are horizontal grain. Doors feature vertical veneer bookmatched horizontally in sets of 2, 4, and 6 doors. Tower fronts are matched in vertical sets.

## Rail grommets | grommet reference

TM30  
Black  
1-5/8" Dia.

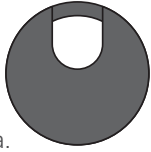

TM31  
Silver  
1-5/8" Dia.

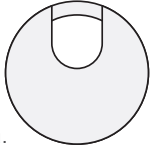

TM60  
Black  
3-1/2" Dia.

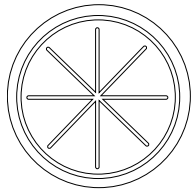

### Optional grommets

Factory Installed

Grommets (Standard Location)

Specify Color and Left/Right/Center - \$50 ea.

- Black: TM30-R (Right), TM30-L (Left), TM30-C (Center)

- Silver: TM31-R (Right), TM31-L (Left), TM31-C (Center)

- Antique Brass: TM33-R (Right), TM33-L (Left), TM33-C (Center)

80mm Optional vertical grommet

Standard Location - \$50 ea.

- Black Plastic wire grommet: TM60-C (bottom center)

Non-Standard Location - \$95 ea.

- Black Plastic wire grommet: TM60-NS

TM50  
Black  
1-5/8" Dia.

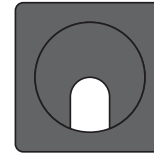

### Grommets (vertical surface)

Standard Location - \$50 ea.

- Black Plastic Vertical Surface: TM50-C (Bottom Center)

Non-Standard Location - \$95 ea.

- Black Plastic Vertical Surface: TM50-NS

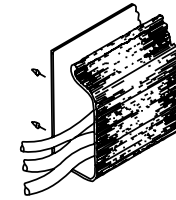

W1

### Horizontal J-channel

Horizontal J-Channel wire management (Sku: W-1) is sold separately to conceal wire under worksurfaces.

## Standard grommet location reference

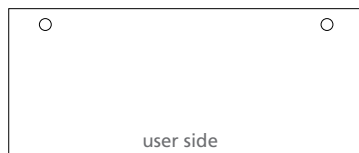

Desk  
Specify Right or Left Grommet



Bridge  
Center Grommet

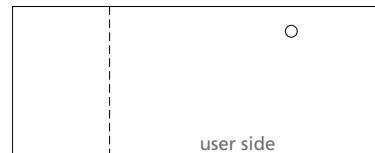

Return (Left Pedestal Shown)  
Right Pedestal - Left Grommet  
Left Pedestal - Right Grommet



Workstation Credenza  
Center Kneespace Grommet

# Rail metal leg

TRESTLE BASE

## Inline trestle base

Width: 24"  
Depth: 9.5"  
Height: 27.75"

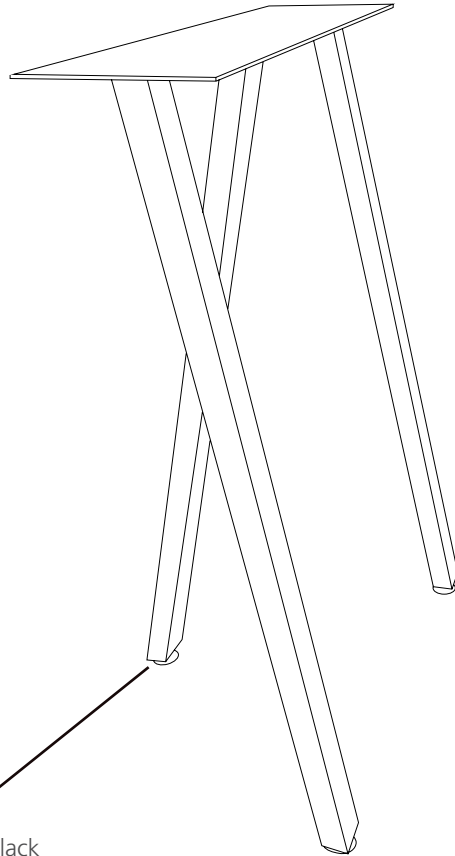

Available finishes are MFB Black and MFR Industrial Metal

Industrial metal finish highlights the imperfections of metal working, including welds and metal color variations. These are not considered defects on this finish.

## Rail drawer dimensions | filing reference

### Interior Drawer Dimensions

UNIT DEPTH	DRAWER TYPE	OVERALL DIMENSIONS			INTERIOR DRAWER DIMENSIONS			NOTES
		W	D	H	W	D	H	
15-5/8" Letter	36" Box	13-1/8	19-11/16	4	12-1/8	18-11/16	3-7/16	Units less than 72"
	36" File	13-1/8	19-11/16	9-13/16	12-1/8	18-11/16	9-5/16	Units less than 72"
	30" Box	13-1/8	19-11/16	4	12-1/8	18-11/16	3-7/16	Units less than 72"
	30" File	13-1/8	19-11/16	9-13/16	12-1/8	18-11/16	9-5/16	Units less than 72"
	24" Box	13-1/8	16-1/16	4	12-1/8	15-1/16	3-7/16	Units less than 72"
	24" File	13-1/8	16-1/16	9-13/16	12-1/8	15-1/16	9-5/16	Units less than 72"
29" Lateral	24" Box	26-1/2	16-1/16	4	25-1/2	15-1/16	3-7/16	Workstation Credenzas less than 82"
	24" File	26-1/2	16-1/16	9-13/16	25-1/2	15-1/16	9-5/16	Workstation Credenzas less than 82"
31" Lateral	24" File	28-9/16	16-1/16	9-13/16	27-9/16	15-1/16	9-5/16	Multi-File Lateral File
35" Lateral	24" Box	32-1/2	16-1/16	4	31-1/2	15-1/16	3-7/16	Workstation Credenzas over 83"
	24" File	32-1/2	16-1/16	9-13/16	31-1/2	15-1/16	9-5/16	Workstation Credenzas over 83"
41" Lateral	24" File	38-1/2	16-1/16	9-13/16	37-1/2	15-1/16	9-5/16	Wood Drawer Onlr

### Filing reference

#### Filing for 24" depth units 13" Wide File Drawer - 16" Deep

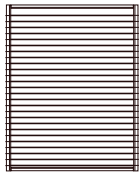

Letter Front to Back

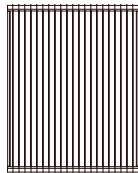

Legal Side to Side with File Rail

#### 29" Lateral file drawer

26-1/2" Wide File Drawer - 16-1/16" Deep

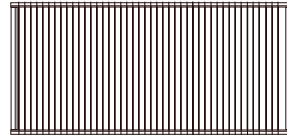

Legal Side to Side

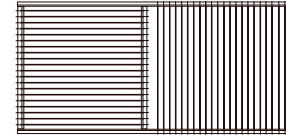

Legal Side to Side Letter Front to Back with File Rail

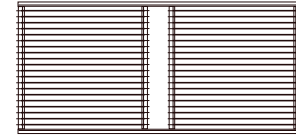

Letter Front to Back with File Rail

#### Filing for 30" & 36" depth units 13" Wide File Drawer - 20" Deep

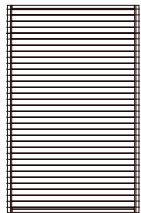

Letter Front to Back

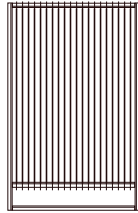

Legal Side to Side with File Rail

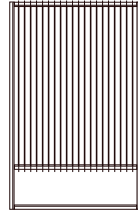

Letter Side to Side with File Rail

#### 35" Lateral file drawer

32-1/2" Wide File Drawer - 16-1/16" Deep

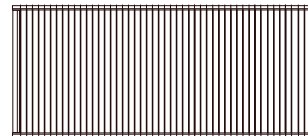

Legal Side to Side

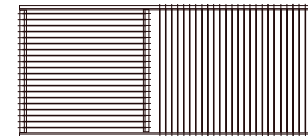

Legal Side to Side Letter Front to Back with File Rail

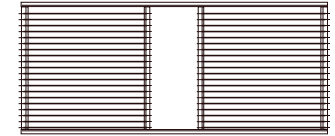

Letter Front to Back with File Rail

# Rail.

## Double Pedestal Desks Double Pedestal Desk

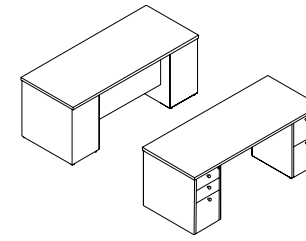

[View statement of line](#)

1 Select a model w" x d" x h"	weight	Standard Veneer Top Standard Veneer Chassis		Premium Veneer Top Premium Veneer Chassis		High Pressure Laminate Top Veneer Chassis		Thermally Fused Laminate Top Thermally Fused Laminate Chassis	
		72 x 30 x 29	300	RAL7230DD000W	3588	RAL7230DD000P	3947	RAL7230DD000G	3588
66 x 30 x 29	270	RAL6630DD000W	3499	RAL6630DD000P	3849	RAL6630DD000G	3499	RAL6630DD000M	2076
60 x 30 x 29	260	RAL6030DD000W	3296	RAL6030DD000P	3626	RAL6030DD000G	3296	RAL6030DD000M	2036

2 Select a finish <a href="#">View finish details</a>	Standard Veneer Top		Premium Veneer Top		High Pressure Laminate Top		Thermally Fused Laminate Top	
		WAC	WWP	TSTV	GAC	GSLV +10%	MAC	
	WEC		TSMV	GEC	GWL	MEC		
	WOC		TSLV	GOC		MOC		
	WAM			GAM		MGW		
	WCM			GCM		MTW		
	WWM			GWM		MSW		
	WGW			GNW		MWL		
	WBW			GSTV				
	WSW			+10%				
	WNW							

3 Select an edge <a href="#">View edge details</a>	Standard Veneer Top		Premium Veneer Top		High Pressure Laminate Top		Thermally Fused Laminate Top	
		Flat	Exposed Plywood	Flat	Flat	Flat	Flat	

4 Select hardware <a href="#">View hardware details</a>	Standard Veneer Top		Premium Veneer Top		High Pressure Laminate Top		Thermally Fused Laminate Top	
		DK-150	Finger Pull	DK-150	DK-150	DK-150	DK-150	

## Product features.

- Box/Box/File (left)
- Breakfront chassis
- File/File (right)
- Half Modesty
- Legal/Letter filing
- Soft close suspension drawer(s)

### NOTES

- All units are standard w/ flush ends
- Modesty is recessed 6"

## Options.

### ACCESSORIES

- K28: Articulating Keyboard w/ Mouse - \$390
- K31: Center drawer w/o skirt - \$205

### DRAWER

- P33: Wood Drawer Upgrade - \$45 per drawer
- P6: Modify File/File to Box/Box/File - \$55 per pedestal
- WPD3061: Designer White - \$80 per pedestal

### GROMMETS (STANDARD LOCATION)

- Specify Color and Left/Right - \$50 ea.
- Black: TM30-R (Right), TM30-L (Left)
- Silver: TM31-R (Right), TM31-L (Left)

### GROMMETS (NON-STANDARD LOCATION)

- Provide drawing w/ Grommet Location and Specify Color - \$95 ea.
- Black: TM30-NS
- Silver: TM31-NS

### PLANK MATCH VENEER

- RPMV: Random Walnut Plank Match Veneer (Horizontal Grain with 25%+ Sap) - Add 10%. Clear coat only.
- Exposed Plywood Edge
- WEPB: Exposed Plywood Edge w/ Baltic Birch Veneer - n/c
- Only available with WCF - Clear Coat Finish



# Rail.

Single Pedestal Desks  
Single Pedestal Desk

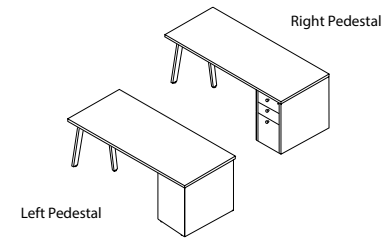

1 Select a model  
w" x d" x h"

weight	Standard Veneer Top		Premium Veneer Top		High Pressure Laminate Top		Thermally Fused Laminate Top	
	Standard Veneer Chassis		Premium Veneer Chassis		Veneer Chassis		Thermally Fused Laminate Chassis	
<b>Left Pedestal</b>								
72 x 30 x 29	255	RAL7230DS619W 3065	RAL7230DS619P 3372	RAL7230DS619G 3065	RAL7230DS619M 1940			
66 x 30 x 29	220	RAL6630DS619W 2990	RAL6630DS619P 3289	RAL6630DS619G 2990	RAL6630DS619M 1890			
60 x 30 x 29	200	RAL6030DS619W 2915	RAL6030DS619P 3207	RAL6030DS619G 2915	RAL6030DS619M 1840			
<b>54 x 30 x 29</b>	180	RAL5430DS619W 2840	RAL5430DS619P 3124	RAL5430DS619G 2840	RAL5430DS619M 1790			
54 x 24 x 29	160	RAL5424DS619W 2595	RAL5424DS619P 2855	RAL5424DS619G 2595	RAL5424DS619M 1740			
<b>Right Pedestal</b>								
72 x 30 x 29	255	RAL7230DS609W 3065	RAL7230DS609P 3372	RAL7230DS609G 3065	RAL7230DS609M 1940			
66 x 30 x 29	220	RAL6630DS609W 2990	RAL6630DS609P 3289	RAL6630DS609G 2990	RAL6630DS609M 1890			
60 x 30 x 29	200	RAL6030DS609W 2915	RAL6030DS609P 3207	RAL6030DS609G 2915	RAL6030DS609M 1840			
54 x 30 x 29	180	RAL5430DS609W 2840	RAL5430DS609P 3124	RAL5430DS609G 2840	RAL5430DS609M 1790			
54 x 24 x 29	160	RAL5424DS609W 2595	RAL5424DS609P 2855	RAL5424DS609G 2595	RAL5424DS609M 1740			

[View statement of line](#)

2 Select a finish  
[View finish details](#)

Metal finish  
MFB Black (standard),  
MFR Industrial (optional)

- WAC WWP
- WEC
- WOC
- WAM
- WCM
- WWM
- WGW
- WBW
- WSW
- WNW

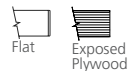

3 Select a edge  
[View edge details](#)

4 Select hardware  
[View hardware details](#)



## Product features.

- Box/Box/File
- Full extension drawers - locking
- Soft close suspension drawer(s)
- Standard base is black metal finish (optional industrial metal finish)

### NOTES

- All units are standard w/ flush ends
- Free standing use

## Options.

### ACCESSORIES

- K28: Articulating Keyboard w/ Mouse - \$390
- K31-SK: Center drawer w/ skirt - \$310
- K31: Center drawer w/o skirt - \$205
- W19: Wire management cover for leg - \$80

### BASES

- D1B: Delete one base - Deduct \$325
- Base(s) can be deleted for hooking to 48" tall units

### DRAWER

- P33: Wood Drawer Upgrade - \$45 per drawer
- P6: Modify Box/Box/File to File/File - \$55 per pedestal
- WPD3061: Designer White - \$80 per pedestal

### GROMMETS (STANDARD LOCATION)

- Specify Color and Left/Right - \$50 ea.
- Black: TM30-R (Right), TM30-L (Left)
  - Silver: TM31-R (Right), TM31-L (Left)

### GROMMETS (NON-STANDARD LOCATION)

- Provide drawing w/ Grommet Location and Specify Color - \$95 ea.
- Black: TM30-NS
  - Silver: TM31-NS
- Modesty
- HM3: Veneer Half Modesty - \$260 (for "W" and "G")
  - HM3M: Melamine Half Modesty - \$205 (For "M")
- Plank Match Veneer
- RPMV: Random Walnut Plank Match Veneer (Horizontal Grain with 25%+ Sap) - Add 10%. Clear coat only.
- Exposed Plywood Edge
- WEPB: Exposed Plywood Edge w/ Baltic Birch Veneer - n/c
  - Only available with WCF - Clear Coat Finish

# Rail.

Freestanding Desk  
Table Desk With Metal Bases

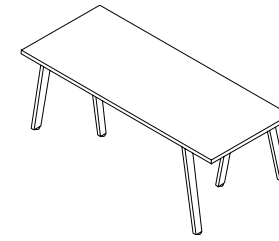

[View statement of line](#)

1 Select a model w" x d" x h"	weight	Standard Veneer Top Standard Veneer Chassis		Premium Veneer Top Premium Veneer Chassis		High Pressure Laminate Top Veneer Chassis		Thermally Fused Laminate Top Thermally Fused Laminate Chassis	
		72 x 30 x 29	135	RAL7230DT098W	3172	RAL7230DT098P	3490	RAL7230DT098G	3172
66 x 30 x 29	125	RAL6630DT098W	3088	RAL6630DT098P	3397	RAL6630DT098G	3088	RAL6630DT098M	1558
60 x 30 x 29	115	RAL6030DT098W	3005	RAL6030DT098P	3306	RAL6030DT098G	3005	RAL6030DT098M	1519
2 Select a finish <a href="#">View finish details</a>		WAC	WWP	TSTV		GAC	GSLV +10%	MAC	
		WEC		TSMV		GEC	GWL	MEC	
Metal finish MFB Black (standard), MFR Industrial (optional)		WOC		TSLV		GOC		MOC	
		WAM				GAM		MGW	
3 Select a edge <a href="#">View edge details</a>		WCM				GCM		MTW	
		WWM				GWM		MSW	
		WGW				GNW		MWL	
		WBW				GSTV	+10%		
		WSW							
		WNW							
4 Select hardware <a href="#">View hardware details</a>									

## Product features.

- Standard base is black metal finish (optional industrial metal finish)

### NOTES

- Freestanding use

## Options.

### ACCESSORIES

- K28: Articulating Keyboard w/ Mouse - \$390
- K31-SK: Center drawer w/ skirt - \$310
- K31: Center drawer w/o skirt - \$205
- W19: Wire management cover for leg - \$80

### BASES

- D1B: Delete one base - Deduct \$325
- D2B: Delete two bases - Deduct \$650
- Base(s) can be deleted for hooking to 48" tall units

### GROMMETS (STANDARD LOCATION)

- Specify Color and Left/Right - \$50 ea.
- Black: TM30-R (Right), TM30-L (Left)
  - Silver: TM31-R (Right), TM31-L (Left)

### GROMMETS (NON-STANDARD LOCATION)

- Provide drawing w/ Grommet Location and Specify Color - \$95 ea.
- Black: TM30-NS
  - Silver: TM31-NS

### MODESTY

- HM3: Veneer Half Modesty - \$260 (for "W" and "G")
- HM3M: Melamine Half Modesty - \$205 (For "M")
- Plank Match Veneer
- RPMV: Random Walnut Plank Match Veneer (Horizontal Grain with 25%+ Sap) - Add 10%. Clear coat only.
- Exposed Plywood Edge
- WEPB: Exposed Plywood Edge w/ Baltic Birch Veneer - n/c
- Only available with WCF - Clear Coat Finish

# Rail.

Double Breakfront Pedestal Desks  
 Double Breakfront Single Pedestal Desk

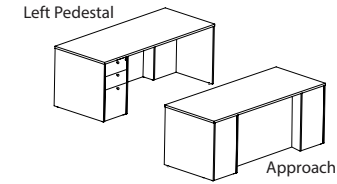

[View statement of line](#)

1 Select a model w" x d" x h"	weight	Standard Veneer Top		Premium Veneer Top		High Pressure Laminate Top		Thermally Fused Laminate Top	
		Standard Veneer Chassis		Premium Veneer Chassis		Veneer Chassis		Thermally Fused Laminate Chassis	
<b>Left Pedestal</b>									
72 x 30 x 29	245	RAL7230DS009W	3347	RAL7230DS009P	3682	RAL7230DS009G	3347	RAL7230DS009M	1873
66 x 30 x 29	205	RAL6630DS009W	3269	RAL6630DS009P	3596	RAL6630DS009G	3269	RAL6630DS009M	1828
60 x 30 x 29	180	RAL6030DS009W	3195	RAL6030DS009P	3515	RAL6030DS009G	3195	RAL6030DS009M	1784
<b>Right Pedestal</b>									
72 x 30 x 29	245	RAL7230DS010W	3347	RAL7230DS010P	3682	RAL7230DS010G	3347	RAL7230DS010M	1873
66 x 30 x 29	205	RAL6630DS010W	3269	RAL6630DS010P	3596	RAL6630DS010G	3269	RAL6630DS010M	1828
60 x 30 x 29	180	RAL6030DS010W	3195	RAL6030DS010P	3515	RAL6030DS010G	3195	RAL6030DS010M	1784

2 Select a finish <a href="#">View finish details</a>	Standard Veneer Top		Premium Veneer Top		High Pressure Laminate Top		Thermally Fused Laminate Top	
	WAC	WWP	TSTV	TSLV	GAC	GSLV +10%	MAC	MEC
	WEC				GEC	GWL	MOC	MGW
	WOC				GOC		MTW	MSW
	WAM				GAM		MWL	
	WCM				GCM			
	WWM				GWM			
	WGW				GNW			
	WBW				GSTV			
	WSW				+10%			
	WNW							

3 Select a edge <a href="#">View edge details</a>	Standard Veneer Top		Premium Veneer Top		High Pressure Laminate Top		Thermally Fused Laminate Top	
	Flat	Exposed Plywood	Flat	Flat	Flat	Flat	Flat	Flat

4 Select hardware <a href="#">View hardware details</a>	Standard Veneer Top		Premium Veneer Top		High Pressure Laminate Top		Thermally Fused Laminate Top	
	DK-150	Finger Pull	DK-150	DK-150	DK-150	DK-150	DK-150	DK-150

## Product features.

- Box/Box/File
- Full extension drawers - locking
- Soft close suspension drawer(s)

### NOTES

- All units are standard w/ flush ends
- Can be used as hookup or freestanding

## Options.

### ACCESSORIES

- K28: Articulating Keyboard w/ Mouse - \$390
- K31: Center drawer w/o skirt - \$205

### CHASSIS

- MODCX: Modify breakfront chassis to flush front chassis - n/c

### DRAWER

- P6: Modify Box/Box/File to File/File - \$55 per pedestal
- P33: Wood Drawer Upgrade - \$50 per drawer
- WPD3061: Designer White drawer fronts - \$80 per pedestal

### GROMMETS (STANDARD LOCATION)

- Specify Color and Left/Right - \$50 ea.
- Black: TM30-R (Right), TM30-L (Left)
  - Silver: TM31-R (Right), TM31-L (Left)

### GROMMETS (NON-STANDARD LOCATION)

- Provide drawing w/ Grommet Location and Specify Color - \$95 ea.
- Black: TM30-NS
  - Silver: TM31-NS
- Plank Match Veneer
- RPMV: Random Walnut Plank Match Veneer (Horizontal Grain with 25%+ Sap) - Add 10%. Clear coat only.
- Exposed Plywood Edge
- WEPB: Exposed Plywood Edge w/ Baltic Birch Veneer - n/c
  - Only available with WCF - Clear Coat Finish

# Rail.

Conference Desk  
Conference Desk With Metal Base And False Pedestal

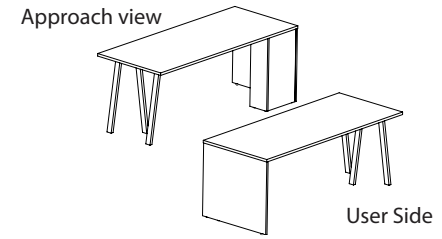

1 Select a model w" x d" x h"	weight	Standard Veneer Top		Premium Veneer Top		High Pressure Laminate Top		Thermally Fused Laminate Top	
		Standard Veneer Chassis		Premium Veneer Chassis		Veneer Chassis		Thermally Fused Laminate Chassis	
<b>Left False Pedestal with Metal Base</b>									
72 x 30 x 29	170	RAL7230DC780W	3060	RAL7230DC780P	3366	RAL7230DC780G	3060	RAL7230DC780M	1490
66 x 30 x 29	160	RAL6630DC780W	2982	RAL6630DC780P	3281	RAL6630DC780G	2982	RAL6630DC780M	1462
60 x 30 x 29	150	RAL6030DC780W	2903	RAL6030DC780P	3194	RAL6030DC780G	2903	RAL6030DC780M	1435
<b>Right False Pedestal with Metal Base</b>									
72 x 30 x 29	170	RAL7230DC781W	3060	RAL7230DC781P	3366	RAL7230DC781G	3060	RAL7230DC781M	1490
66 x 30 x 29	160	RAL6630DC781W	2982	RAL6630DC781P	3281	RAL6630DC781G	2982	RAL6630DC781M	1462
60 x 30 x 29	150	RAL6030DC781W	2903	RAL6030DC781P	3194	RAL6030DC781G	2903	RAL6030DC781M	1435
<b>2 Select a finish</b> <i>View finish details</i>									
		WAC	WWP	TSTV		GAC	GSLV +10%	MAC	
		WEC		TSMV		GEC	GWL	MEC	
		WOC		TSLV		GOC		MOC	
<b>Metal finish</b>		WAM				GAM		MGW	
MFB Black (standard),		WCM				GCM		MTW	
MFR Industrial (optional)		WWM				GWM		MSW	
		WGW				GNW		MWL	
		WBW				GSTV	+10%		
		WSW							
		WNW							
<b>3 Select a edge</b> <i>View edge details</i>									
		Flat	Exposed Plywood	Flat		Flat		Flat	
<b>4 Select hardware</b> <i>View hardware details</i>									
		Hardware		Hardware		Hardware		Hardware	
		N/A		N/A		N/A		N/A	

*View statement of line*

## Product features.

- Standard base is black metal finish (optional industrial metal finish)

### NOTES

- All units are standard w/ flush ends
- Free standing use
- Grain Direction Runs Front To Back On 42"/48"/60" Sizes on "G" and "M" styles and all "W" styles. Grain Runs End To End On 66"/72" Sizes on "G" and "M" styles.
- Unit ships assembled

## Options.

### ACCESSORIES

- K31-SK: Center drawer w/ skirt - \$310
- K28: Articulating Keyboard w/ Mouse - \$390
- K31: Center drawer w/o skirt - \$205
- W19: Wire management cover for leg - \$80

### BASES

- D1B: Delete one base - Deduct \$325
- Base(s) can be deleted for hooking to 48" tall units

### GROMMETS (STANDARD LOCATION)

- Specify Color and Left/Right - \$50 ea.
- Black: TM30-R (Right), TM30-L (Left)
  - Silver: TM31-R (Right), TM31-L (Left)

### GROMMETS (NON-STANDARD LOCATION)

- Provide drawing w/ Grommet Location and Specify Color - \$95 ea.
- Black: TM30-NS
  - Silver: TM31-NS

### MODESTY

- HM3: Veneer Half Modesty - \$260 (for "W" and "G")
- HM3M: Melamine Half Modesty - \$205 (For "M")
- Plank Match Veneer
- RPMV: Random Walnut Plank Match Veneer (Horizontal Grain with 25%+ Sap) - Add 10%. Clear coat only.
- Exposed Plywood Edge
- WEPB: Exposed Plywood Edge w/ Baltic Birch Veneer - n/c
- Only available with WCF - Clear Coat Finish



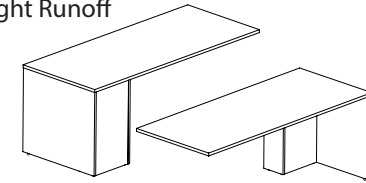

# Rail.

Runoff Desk  
Runoff Desk With False Pedestal

Right Runoff



Left Runoff

1 Select a model w" x d" x h"	weight	Standard Veneer Top		Premium Veneer Top		High Pressure Laminate Top		Thermally Fused Laminate Top	
		Standard Veneer Chassis		Premium Veneer Chassis		Veneer Chassis		Thermally Fused Laminate Chassis	
<b>Left Runoff with False Pedestal Right</b>									
72 x 30 x 29	150	RAL7230DR772W	2610	RAL7230DR772P	2871	RAL7230DR772G	2610	RAL7230DR772M	1041
66 x 30 x 29	140	RAL6630DR772W	2526	RAL6630DR772P	2779	RAL6630DR772G	2526	RAL6630DR772M	1012
60 x 30 x 29	130	RAL6030DR772W	2442	RAL6030DR772P	2687	RAL6030DR772G	2442	RAL6030DR772M	985
<b>Right Runoff with False Pedestal Left</b>									
72 x 30 x 29	150	RAL7230DR773W	2610	RAL7230DR773P	2871	RAL7230DR773G	2610	RAL7230DR773M	1041
66 x 30 x 29	140	RAL6630DR773W	2526	RAL6630DR773P	2779	RAL6630DR773G	2526	RAL6630DR773M	1012
60 x 30 x 29	130	RAL6030DR773W	2442	RAL6030DR773P	2687	RAL6030DR773G	2442	RAL6030DR773M	985
<b>2 Select a finish</b> <i>View finish details</i>									
		WAC	WWP	TSTV		GAC	GSLV +10%	MAC	
		WEC		TSMV		GEC	GWL	MEC	
		WOC		TSLV		GOC		MOC	
		WAM				GAM		MGW	
		WCM				GCM		MTW	
		WWM				GWM		MSW	
		WGW				GNW		MWL	
		WBW				GSTV	+10%		
		WSW							
		WNW							
<b>3 Select a edge</b> <i>View edge details</i>									
									
		Flat		Flat		Flat		Flat	
									
		Exposed Plywood							
<b>4 Select hardware</b> <i>View hardware details</i>									
		Hardware		Hardware		Hardware		Hardware	
		N/A		N/A		N/A		N/A	

[View statement of line](#)

## Product features.

### NOTES

- All units are standard w/ flush ends
- Grain Direction Runs Front To Back On 42"/48"/60" Sizes on "G" and "M" styles and all "W" styles. Grain Runs End To End On 66"/72" Sizes on "G" and "M" styles.
- If grommet is added then unit will become handed
- Unit ships assembled
- Will need to hook to freestanding unit.

## Options.

### ACCESSORIES

- K28: Articulating Keyboard w/ Mouse - \$390
- K31: Center drawer w/o skirt - \$205

### GROMMETS (STANDARD LOCATION)

- Specify Color and Left/Right - \$50 ea.
- Black: TM30-R (Right), TM30-L (Left)
  - Silver: TM31-R (Right), TM31-L (Left)

### GROMMETS (NON-STANDARD LOCATION)

- Provide drawing w/ Grommet Location and Specify Color - \$95 ea.
- Black: TM30-NS
  - Silver: TM31-NS

### MODESTY

- HM3: Veneer Half Modesty - \$260 (for "W" and "G")
- HM3M: Melamine Half Modesty - \$205 (For "M")

### PLANK MATCH VENEER

- RPMV: Random Walnut Plank Match Veneer (Horizontal Grain with 25%+ Sap) - Add 10%. Clear coat only.
- Exposed Plywood Edge
- WEPB: Exposed Plywood Edge w/ Baltic Birch Veneer - n/c
- Only available with WCF - Clear Coat Finish

# Rail.

Return  
Workstation Return Shell

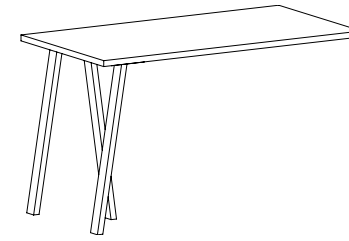

1 Select a model w" x d" x h"	weight	Standard Veneer Top Standard Veneer Chassis		Premium Veneer Top Premium Veneer Chassis		High Pressure Laminate Top Veneer Chassis		Thermally Fused Laminate Top Thermally Fused Laminate Chassis	
		48 x 24 x 29	85	RAL4824RE202W	1503	RAL4824RE202P	1654	RAL4824RE202G	1503
42 x 24 x 29	80	RAL4224RE202W	1468	RAL4224RE202P	1615	RAL4224RE202G	1468	RAL4224RE202M	962

2 Select a finish View finish details	Metal finish MFB Black (standard), MFR Industrial (optional)		TSTV TSMV TSLV	GAC GEC GOC GAM GCM GWM GNW GSTV +10%		MAC MEC MOC MGW MTW MSW MWL
	WAC WEC WOC WAM WCM WWM WGW WBW WSW WNW	WWP		GSLV +10% GWL		

3 Select an edge View edge details	Flat	Exposed Plywood	Flat	Flat	Flat
	Flat	Exposed Plywood	Flat	Flat	Flat

4 Select hardware View hardware details	Hardware N/A	Hardware N/A	Hardware N/A	Hardware N/A
	Hardware N/A	Hardware N/A	Hardware N/A	Hardware N/A

[View statement of line](#)

## Product features.

- Standard base is black metal finish (optional industrial metal finish)
- Hookup hardware

### NOTES

- All units are standard w/ flush ends

## Options.

### ACCESSORIES

- K31-SK: Center drawer w/ skirt - \$310
- K28: Articulating Keyboard w/ Mouse - \$390
- K31: Center drawer w/o skirt - \$205
- W19: Wire management cover for leg - \$80

### GROMMETS (STANDARD LOCATION)

- Specify Color and Left/Right - \$50 ea.
- Black: TM30-R (Right), TM30-L (Left)
- Silver: TM31-R (Right), TM31-L (Left)

### GROMMETS (NON-STANDARD LOCATION)

- Provide drawing w/ Grommet Location and Specify Color - \$95 ea.
- Black: TM30-NS
- Silver: TM31-NS

### MODESTY

- HM3: Veneer Half Modesty - \$260 (for "W" and "G")
- HM3M: Melamine Half Modesty - \$205 (For "M")





### PLANK MATCH VENEER

- RPMV: Random Walnut Plank Match Veneer (Horizontal Grain with 25%+ Sap) - Add 10%. Clear coat only.
- Exposed Plywood Edge
- WEPB: Exposed Plywood Edge w/ Baltic Birch Veneer - n/c
- Only available with WCF - Clear Coat Finish

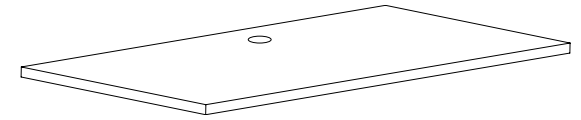
# Rail.

Bridge  
Bridge



1 Select a model w" x d" x h"	weight	Standard Veneer Top Standard Veneer Chassis		Premium Veneer Top Premium Veneer Chassis		High Pressure Laminate Top Veneer Chassis		Thermally Fused Laminate Top Thermally Fused Laminate Chassis	
		48 x 24 x 29	55	RAL4824BR151W	625	RAL4824BR151P	688	RAL4824BR151G	625
42 x 24 x 29	50	RAL4224BR151W	591	RAL4224BR151P	651	RAL4224BR151G	591	RAL4224BR151M	450
2 Select a finish <i>View finish details</i>		WAC	WWP	TSTV		GAC	GSLV +10%	MAC	
		WEC		TSMV		GEC	GWL	MEC	
		WOC		TSLV		GOC		MOC	
		WAM				GAM		MGW	
		WCM				GCM		MTW	
		WWM				GWM		MSW	
		WGW				GNW		MWL	
		WBW				GSTV			
		WSW				+10%			
		WNW							
3 Select a edge <i>View edge details</i>									
		Flat	Exposed Plywood	Flat		Flat		Flat	
4 Select hardware <i>View hardware details</i>		Hardware		Hardware		Hardware		Hardware	
		N/A		N/A		N/A		N/A	

[View statement of line](#)

## Product features.

- 1 Standard grommet - matches pull finish or specify black TM30, silver TM31

## Options.

### GROMMETS (NON-STANDARD LOCATION)

Provide drawing w/ Grommet Location and Specify Color - \$95 ea.

- Black: TM30-NS
- Silver: TM31-NS

### MODESTY

- HM3: Veneer Half Modesty - \$260 (for "W" and "G")
- HM3M: Melamine Half Modesty - \$205 (For "M")

### PLANK MATCH VENEER

- RPMV: Random Walnut Plank Match Veneer (Horizontal Grain with 25%+ Sap) - Add 10%. Clear coat only.

### EXPOSED PLYWOOD EDGE

- WEPB: Exposed Plywood Edge w/ Baltic Birch Veneer - n/c
- Only available with WCF - Clear Coat Finish

# Rail.

Credenza  
Storage Credenza

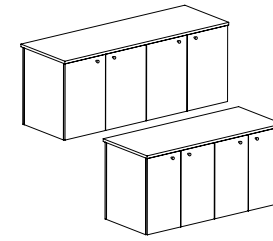

## 1 Select a model w" x d" x h"

weight	Standard Veneer Top Standard Veneer Chassis		Premium Veneer Top Premium Veneer Chassis		High Pressure Laminate Top Veneer Chassis		Thermally Fused Laminate Top Thermally Fused Laminate Chassis	
	72 x 24 x 29	230	RAL7224CA125W 3302	RAL7224CA125P 3633	RAL7224CA125G 3302	RAL6024CA125G 2965	RAL7224CA125M 2025	RAL6024CA125M 1906
60 x 24 x 29	200	RAL6024CA125W 2965	RAL6024CA125P 3262					

[View statement of line](#)

## 2 Select a finish [View finish details](#)

WAC WWP  
WEC  
WOC  
WAM  
WCM  
WWM  
WGW  
WBW  
WSW  
WNW

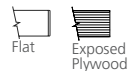

## 3 Select an edge [View edge details](#)

## 4 Select hardware [View hardware details](#)



TSTV  
TSMV  
TSLV



GAC GSLV +10%  
GEC GWL  
GOC  
GAM  
GCM  
GWM  
GNW  
GSTV  
+10%



MAC  
MEC  
MOC  
MGW  
MTW  
MSW  
MWL



## Product features.

- Black adjustable shelf behind door set

### NOTES

- "M" Styles have matching "M" Finish Shelf
- All units are standard w/ flush ends
- Unit not designed for open plan use, standard with unfinished back. Select OPB Option for Open Plan application.

## Options.

### DOOR

- D2: Door Lock - \$100 per door set
- D6A: "W"/"G" Styles - Delete Doors and replace black laminate shelf with finished shelf - n/c
- D9SC: Soft Close Door Hinges - \$20 per door
- WPD3061: Designer White drawer fronts - \$80 per door

### GROMMETS (STANDARD LOCATION)

- Specify Color and Left/Right - \$50 ea.
- Black: TM30-R (Right), TM30-L (Left)
  - Silver: TM31-R (Right), TM31-L (Left)

### GROMMETS (NON-STANDARD LOCATION)

- Provide drawing w/ Grommet Location and Specify Color - \$95 ea.
- Black: TM30-NS
  - Silver: TM31-NS

### GROMMETS (VERTICAL SURFACE)

- Standard Location - \$50 ea.
- Black Plastic Vertical Surface: TM50-C (Bottom Center)
  - TM60: 5.5" from bottom, 3" from back - \$95

### OPEN PLAN – FINISHED BACK

- OPB: "W" "G" Style - Modify Unit for Open Plan Application - \$195
  - OPB: "M" Style - Modify Unit for Open Plan Application - \$95
- Plank Match Veneer
- RPMV: Random Walnut Plank Match Veneer (Horizontal Grain with 25%+ Sap) - Add 10%. Clear coat only.

### Shelf

- S25: Replace Black Laminate Shelf with Finished Shelf - \$80 per shelf ("W" and "G" styles only)

### Exposed Plywood Edge

- WEPB: Exposed Plywood Edge w/ Baltic Birch Veneer - n/c
- Only available with WCF - Clear Coat Finish



# Rail.

Credenza  
Kneespace Credenza

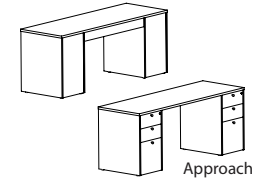

[View statement of line](#)

1 Select a model w" x d" x h"	weight	Standard Veneer Top Standard Veneer Chassis		Premium Veneer Top Premium Veneer Chassis		High Pressure Laminate Top Veneer Chassis		Thermally Fused Laminate Top Thermally Fused Laminate Chassis	
		72 x 24 x 29	225	RAL7224CA054W	3178	RAL7224CA054P	3495	RAL7224CA054G	3178
66 x 24 x 29	215	RAL6624CA054W	3099	RAL6624CA054P	3409	RAL6624CA054G	3099	RAL6624CA054M	1974

2 Select a finish <a href="#">View finish details</a>	Standard Veneer Top		Premium Veneer Top		High Pressure Laminate Top		Thermally Fused Laminate Top	
	WAC	WWP	TSTV	GAC	GSLV +10%	MAC		
WEC		TSMV	GEC	GWL	MEC			
WOC		TSLV	GOC		MOC			
WAM			GAM		MGW			
WCM			GCM		MTW			
WWM			GWM		MSW			
WGW			GNW		MWL			
WBW			GSTV					
WSW			+10%					
WNW								

3 Select a edge <a href="#">View edge details</a>	Standard Veneer Top		Premium Veneer Top		High Pressure Laminate Top		Thermally Fused Laminate Top	
	Flat	Exposed Plywood	Flat	Flat	Flat	Flat		

4 Select hardware <a href="#">View hardware details</a>	Standard Veneer Top		Premium Veneer Top		High Pressure Laminate Top		Thermally Fused Laminate Top	
	DK-150	Finger Pull	DK-150	DK-150	DK-150	DK-150		

## Product features.

- Anti-tilt safety feature
- Full extension drawers - locking
- Kneespace w/ 4" H wire management rail channel - Open back
- Soft close suspension drawer(s)

### NOTES

- All units are standard w/ flush ends
- Freestanding use
- Unit not designed for open plan use, standard with unfinished back. Select OPB Option for Open Plan application.

## Options.

### ACCESSORIES

- K28: Articulating Keyboard w/ Mouse - \$390
- K31: Center drawer w/o skirt - \$205

### DRAWER

- P6: Modify Box/Box/File to File/File - \$55 per pedestal
- P33: Wood Drawer Upgrade - \$45 per drawer
- WPD3061: Designer White drawer fronts - \$80 per pedestal

### GROMMETS (STANDARD LOCATION)

- Specify Color - \$50 ea.
- Black: TM30-C (Center)
  - Silver: TM31-C (Center)

### GROMMETS (NON-STANDARD LOCATION)

- Provide drawing w/ Grommet Location and Specify Color - \$95 ea.
- Black: TM30-NS
  - Silver: TM31-NS

### MODESTY

- M34T-O: "W" "G" Style Drop Door Tech Modesty - \$310
- M34TM-O: "M" Style Drop Door Tech Modesty - \$235
- M37: "W" "G" Style Fixed Full Modesty - \$130
- M37M: "M" Style Fixed Full Modesty - \$80
- Open Plan – Finished Back
- OPB: "W" "G" Style - Modify Unit for Open Plan Application - \$195
- OPB: "M" Style - Modify Unit for Open Plan Application - \$95
- Plank Match Veneer
- RPMV: Random Walnut Plank Match Veneer (Horizontal Grain with 25%+ Sap) - Add 10%. Clear coat only.
- Exposed Plywood Edge
- WEPB: Exposed Plywood Edge w/ Baltic Birch Veneer - n/c
- Only available with WCF - Clear Coat Finish

# Rail.

Open Storage/Pedestal Credenzas  
Horizontal Lateral File

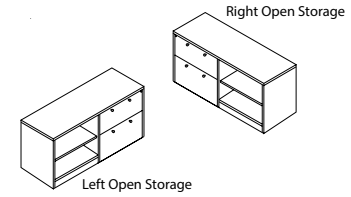

[View statement of line](#)

1 Select a model w" x d" x h"	weight	Standard Veneer Top Standard Veneer Chassis		Premium Veneer Top Premium Veneer Chassis		High Pressure Laminate Top Veneer Chassis		Thermally Fused Laminate Top Thermally Fused Laminate Chassis																																																													
		<p><b>Left Open Storage / Right Lateral File</b></p> <p>72 x 24 x 29    310    RAL7224CA827W    3302    RAL7224CA827P    3633    RAL7224CA827G    3302    RAL7224CA827M    2222</p> <p>60 x 24 x 29    280    RAL6024CA827W    3178    RAL6024CA827P    3496    RAL6024CA827G    3178    RAL6024CA827M    2081</p> <p><b>Right Open Storage / Left Lateral File</b></p> <p>72 x 24 x 29    310    RAL7224CA828W    3302    RAL7224CA828P    3633    RAL7224CA828G    3302    RAL7224CA828M    2222</p> <p>60 x 24 x 29    280    RAL6024CA828W    3178    RAL6024CA828P    3496    RAL6024CA828G    3178    RAL6024CA828M    2081</p>																																																																			
<p><b>2 Select a finish</b> <a href="#">View finish details</a></p> <table border="0"> <tr> <td>WAC</td> <td>WWP</td> <td>TSTV</td> <td>GAC</td> <td>GSLV +10%</td> <td>MAC</td> </tr> <tr> <td>WEC</td> <td></td> <td>TSMV</td> <td>GEC</td> <td>GWL</td> <td>MEC</td> </tr> <tr> <td>WOC</td> <td></td> <td>TSLV</td> <td>GOC</td> <td></td> <td>MOC</td> </tr> <tr> <td>WAM</td> <td></td> <td></td> <td>GAM</td> <td></td> <td>MGW</td> </tr> <tr> <td>WCM</td> <td></td> <td></td> <td>GCM</td> <td></td> <td>MTW</td> </tr> <tr> <td>WWM</td> <td></td> <td></td> <td>GWM</td> <td></td> <td>MSW</td> </tr> <tr> <td>WGW</td> <td></td> <td></td> <td>GNW</td> <td></td> <td>MWL</td> </tr> <tr> <td>WBW</td> <td></td> <td></td> <td>GSTV</td> <td></td> <td></td> </tr> <tr> <td>WSW</td> <td></td> <td></td> <td>+10%</td> <td></td> <td></td> </tr> <tr> <td>WNV</td> <td></td> <td></td> <td></td> <td></td> <td></td> </tr> </table>										WAC	WWP	TSTV	GAC	GSLV +10%	MAC	WEC		TSMV	GEC	GWL	MEC	WOC		TSLV	GOC		MOC	WAM			GAM		MGW	WCM			GCM		MTW	WWM			GWM		MSW	WGW			GNW		MWL	WBW			GSTV			WSW			+10%			WNV					
WAC	WWP	TSTV	GAC	GSLV +10%	MAC																																																																
WEC		TSMV	GEC	GWL	MEC																																																																
WOC		TSLV	GOC		MOC																																																																
WAM			GAM		MGW																																																																
WCM			GCM		MTW																																																																
WWM			GWM		MSW																																																																
WGW			GNW		MWL																																																																
WBW			GSTV																																																																		
WSW			+10%																																																																		
WNV																																																																					
<p><b>3 Select a edge</b> <a href="#">View edge details</a></p> <table border="0"> <tr> <td></td> <td></td> <td></td> <td></td> <td></td> </tr> <tr> <td>Flat</td> <td>Exposed Plywood</td> <td>Flat</td> <td>Flat</td> <td>Flat</td> </tr> </table>															Flat	Exposed Plywood	Flat	Flat	Flat																																																		
Flat	Exposed Plywood	Flat	Flat	Flat																																																																	
<p><b>4 Select hardware</b> <a href="#">View hardware details</a></p> <table border="0"> <tr> <td></td> <td></td> <td></td> <td></td> <td></td> </tr> <tr> <td>DK-150</td> <td>Only available on exposed plywood Finger Pull</td> <td>DK-150</td> <td>DK-150</td> <td>DK-150</td> </tr> </table>															DK-150	Only available on exposed plywood Finger Pull	DK-150	DK-150	DK-150																																																		
DK-150	Only available on exposed plywood Finger Pull	DK-150	DK-150	DK-150																																																																	

## Product features.

- Anti-tilt safety feature
- Full extension drawers - locking
- Legal/Double letter filing
- Soft close suspension drawer(s)

### NOTES

- All units are standard w/ flush ends
- Unit not designed for open plan use, standard with unfinished back.
- Select OPB Option for Open Plan application.

## Options.

### DOOR

- D50: Add 2 doors to open storage - \$260

### DRAWER

- P33: Wood Drawer Upgrade - \$45 per drawer
- WPD3061: Designer White - \$80 per pedestal

### OPEN PLAN – FINISHED BACK

- OPB: "W" "G" Style - Modify Unit for Open Plan Application - \$195
- OPB: "M" Style - Modify Unit for Open Plan Application - \$100

### PLANK MATCH VENEER

- RPMV: Random Walnut Plank Match Veneer (Horizontal Grain with 25%+ Sap) - Add 10%. Clear coat only.

### EXPOSED PLYWOOD EDGE

- WEPB: Exposed Plywood Edge w/ Baltic Birch Veneer - n/c
- Only available with WCF - Clear Coat Finish

# Rail.

Full Pedestal Credenzas  
Horizontal Lateral File



[View statement of line](#)

1 Select a model w" x d" x h"	weight	Standard Veneer Top Standard Veneer Chassis		Premium Veneer Top Premium Veneer Chassis		High Pressure Laminate Top Veneer Chassis		Thermally Fused Laminate Top Thermally Fused Laminate Chassis	
		29 x 24 x 29	145	RAL2924CA104W	1840	RAL2924CA104P	2024	RAL2924CA104G	1840
2 Select a finish <a href="#">View finish details</a>		WAC	WWP	TSTV		GAC	GSLV +10%	MAC	
		WEC		TSMV		GEC	GWL	MEC	
		WOC		TSLV		GOC		MOC	
		WAM				GAM		MGW	
		WCM				GCM		MTW	
		WWM				GWM		MSW	
		WGW				GNW		MWL	
		WBW				GSTV			
		WSW				+10%			
		WNW							
3 Select a edge <a href="#">View edge details</a>									
		Flat	Exposed Plywood	Flat		Flat		Flat	
4 Select hardware <a href="#">View hardware details</a>									
		DK-150	Only available on exposed plywood Finger Pull	DK-150		DK-150		DK-150	

## Product features.

- Anti-tilt safety feature
- Full extension drawers - locking
- Legal/Double letter filing
- Soft close suspension drawer(s)

### NOTES

- All units are standard w/ flush ends
- Unit not designed for open plan use, standard with unfinished back.  
Select OPB Option for Open Plan application.

## Options.

### DRAWER

- P33: Wood Drawer Upgrade - \$45 per drawer
- WPD3061: Designer White - \$80 per pedestal

### OPEN PLAN – FINISHED BACK

- OPB: "W" "G" Style - Modify Unit for Open Plan Application - \$195
- OPB: "M" Style - Modify Unit for Open Plan Application - \$95

### PLANK MATCH VENEER

- RPMV: Random Walnut Plank Match Veneer (Horizontal Grain with 25%+ Sap) - Add 10%. Clear coat only.

### EXPOSED PLYWOOD EDGE

- WEPB: Exposed Plywood Edge w/ Baltic Birch Veneer - n/c
- Only available with WCF - Clear Coat Finish

# Rail.

Credenza  
Workstation Credenza File/File

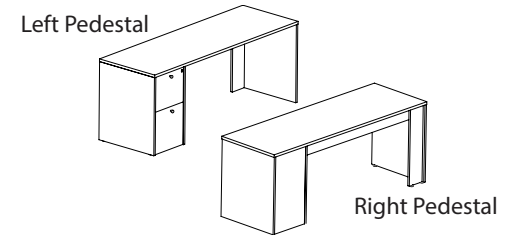

1 Select a model w" x d" x h"	weight	Standard Veneer Top Standard Veneer Chassis		Premium Veneer Top Premium Veneer Chassis		High Pressure Laminate Top Veneer Chassis		Thermally Fused Laminate Top Thermally Fused Laminate Chassis	
		<b>Left Pedestal</b> 72 x 24 x 29 66 x 24 x 29	185 175	RAL7224CA086W RAL6624CA086W	2317 2278	RAL7224CA086P RAL6624CA086P	2549 2506	RAL7224CA086G RAL6624CA086G	2317 2278
<b>Right Pedestal</b> 72 x 24 x 29 66 x 24 x 29	185 175	RAL7224CA087W RAL6624CA087W	2317 2278	RAL7224CA087P RAL6624CA087P	2549 2506	RAL7224CA087G RAL6624CA087G	2317 2278	RAL7224CA087M RAL6624CA087M	1513 1497

2 Select a finish <i>View finish details</i>	WAC WWP		TSTV TSMV TSLV	GAC GSLV +10% GEC GWL		MAC MEC MOC MGW MTW MSW MWL
	WEC WOC WAM WCM WWM WGW WBW WSW WNW					

3 Select a edge <i>View edge details</i>	Flat Exposed Plywood		Flat	Flat	Flat

4 Select hardware <i>View hardware details</i>	DK-150 Finger Pull		DK-150	DK-150	DK-150

[View statement of line](#)

## Product features.

- 4" H back rail - open back
- Full extension drawers - locking
- Hookup hardware
- Legal/Double letter filing
- Soft close suspension drawer(s)

### NOTES

- All units are standard w/ flush ends
- Unit not designed for open plan use, standard with unfinished back.  
Select OPB Option for Open Plan application.

## Options.

### ACCESSORIES

- K28: Articulating Keyboard w/ Mouse - \$390
- K31: Center drawer w/o skirt - \$205

### DRAWER

- P6: Modify File/File to Box/Box/File - \$55 per pedestal
- P33: Wood Drawer Upgrade - \$45 per drawer
- P40W: extra Box/Box/File or File/File to Kneespace - \$910 ("W" and "G")
- P40M: extra Box/Box/File or File/File to Kneespace - \$720 ("M")
- WPD3061: Designer White drawer fronts - \$80 per pedestal

### GROMMETS (STANDARD LOCATION)

- Specify Color - \$50 ea.
- Black: TM30-C (Center)
- Silver: TM31-C (Center)

### MODESTY

- M34T-O: "W" "G" Style Drop Door Tech Modesty - \$310
- M34TM-O: "M" Style Drop Door Tech Modesty - \$235
- M37: "W" "G" Style Fixed Full Modesty - \$130
- M37M: "M" Style Fixed Full Modesty - \$80

### OPEN PLAN – FINISHED BACK

- OPB: "W" "G" Style - Modify Unit for Open Plan Application - \$195
- OPB: "M" Style - Modify Unit for Open Plan Application - \$95
- Plank Match Veneer
- RPMV: Random Walnut Plank Match Veneer (Horizontal Grain with 25%+ Sap) - Add 10%. Clear coat only.
- Exposed Plywood Edge
- WEPB: Exposed Plywood Edge w/ Baltic Birch Veneer - n/c
- Only available with WCF - Clear Coat Finish

# Rail.

Credenza  
Workstation Credenza Lateral File

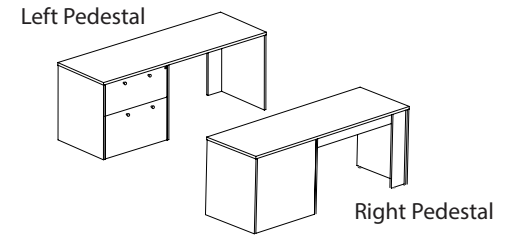

1 Select a model w" x d" x h"	weight	Standard Veneer Top Standard Veneer Chassis		Premium Veneer Top Premium Veneer Chassis		High Pressure Laminate Top Veneer Chassis		Thermally Fused Laminate Top Thermally Fused Laminate Chassis	
		<b>Left Lateral File</b> 72 x 24 x 29 66 x 24 x 29	220 205	RAL7224CA066W RAL6624CA066W	2616 2581	RAL7224CA066P RAL6624CA066P	2877 2840	RAL7224CA066G RAL6624CA066G	2616 2581
<b>Right Lateral File</b> 72 x 24 x 29 66 x 24 x 29	220 205	RAL7224CA067W RAL6624CA067W	2616 2581	RAL7224CA067P RAL6624CA067P	2878 2840	RAL7224CA067G RAL6624CA067G	2616 2581	RAL7224CA067M RAL6624CA067M	1665 1647

2 Select a finish <i>View finish details</i>	WAC WWP		TSTV TSMV TSLV	GAC GSLV +10% GEC GWL		MAC MEC MOC MGW MTW MSW MWL
	WEC WOC WAM WCM WWM WGW WBW WSW WNW					

3 Select a edge <i>View edge details</i>	Flat Exposed Plywood		Flat	Flat	Flat

4 Select hardware <i>View hardware details</i>	DK-150 Finger Pull		DK-150	DK-150	DK-150

*View statement of line*

## Product features.

- 4" H back rail - open back
- Full extension drawers - locking
- Hookup hardware
- Legal/Double letter filing
- Soft close suspension drawer(s)

### NOTES

- All units are standard w/ flush ends
- Unit not designed for open plan use, standard with unfinished back. Select OPB Option for Open Plan application.

## Options.

### DRAWER

- P33: Wood Drawer Upgrade - \$45 per drawer
- P40W: extra Box/Box/File or File/File to Kneespace - \$910 ("W" and "G")
- P40M: extra Box/Box/File or File/File to Kneespace - \$720 ("M")
- WPD3061: Designer White drawer fronts - \$80 per pedestal

### GROMMETS (STANDARD LOCATION)

- Specify Color - \$50 ea.
- Black: TM30-C (Center)
- Silver: TM31-C (Center)

### GROMMETS (NON-STANDARD LOCATION)

- Provide drawing w/ Grommet Location and Specify Color - \$95 ea.
- Black: TM30-NS
- Silver: TM31-NS

### MODESTY

- M34T-O: "W" "G" Style Drop Door Tech Modesty - \$310
- M34TM-O: "M" Style Drop Door Tech Modesty - \$235
- M37: "W" "G" Style Fixed Full Modesty - \$130
- M37M: "M" Style Fixed Full Modesty - \$80

### PLANK MATCH VENEER

- RPMV: Random Walnut Plank Match Veneer (Horizontal Grain with 25%+ Sap) - Add 10%. Clear coat only.
- Open Plan - Finished Back
- OPB: "W" "G" Style - Modify Unit for Open Plan Application - \$195
- OPB: "M" Style - Modify Unit for Open Plan Application - \$95
- Exposed Plywood Edge
- WEPB: Exposed Plywood Edge w/ Baltic Birch Veneer - n/c
- Only available with WCF - Clear Coat Finish

# Rail.

Modular Pedestals  
Undersurface Pedestal

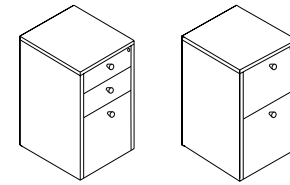

For use under 29"H work surfaces

## Product features.

- Anti-tilt safety feature
- Finished all sides and top - open plan
- Full extension drawers - locking
- Soft close suspension drawer(s)

## Options.

### DRAWER

- P33: Wood Drawer Upgrade - \$45 per drawer
- WPD3061: Designer White - \$80 per pedestal

### PLANK MATCH VENEER

- RPMV: Random Walnut Plank Match Veneer (Horizontal Grain with 25%+ Sap) - Add 10%. Clear coat only.

### EXPOSED PLYWOOD EDGE

- WEPB: Exposed Plywood Edge w/ Baltic Birch Veneer - n/c
- Only available with WCF - Clear Coat Finish

1 Select a model w" x d" x h"	weight	Standard Veneer Top Standard Veneer Chassis		Premium Veneer Top Premium Veneer Chassis		High Pressure Laminate Top Veneer Chassis		Thermally Fused Laminate Top Thermally Fused Laminate Chassis	
		<b>Box/Box/File</b> 16 x 20 x 27	70	RAL1620PD440W	1114	RAL1620PD440P	1226	"G" Option N/A	
<b>File/File</b> 16 x 20 x 27	70	RAL1620PD441W	1114	RAL1620PD441P	1226	"G" Option N/A		RAL1620PD441M	952

2 Select a finish <i>View finish details</i>	Standard Veneer Top		Premium Veneer Top	High Pressure Laminate Top		Thermally Fused Laminate Top	
WAC	WWP		TSTV	GAC	GSLV +10%	MAC	
WEC			TSMV	GEC	GWL	MEC	
WOC			TSLV	GOC		MOC	
WAM				GAM		MGW	
WCM				GCM		MTW	
WWM				GWM		MSW	
WGW				GNW		MWL	
WBW				GSTV	+10%		
WSW							
WNV							

3 Select a edge <i>View edge details</i>	Standard Veneer Top		Premium Veneer Top	High Pressure Laminate Top	Thermally Fused Laminate Top
Flat	Exposed Plywood		Flat	Flat	Flat

4 Select hardware <i>View hardware details</i>	Standard Veneer Top		Premium Veneer Top	High Pressure Laminate Top	Thermally Fused Laminate Top
DK-150	Finger Pull		DK-150	DK-150	DK-150

# Rail.

Mobile Peds  
Mobile Peds - Box File Lock, Casters

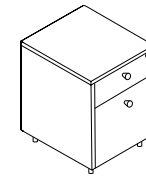

Box/File W/ Cushion  
PD423

[View statement of line](#)

1 Select a model w" x d" x h"	weight	Standard Veneer Top Standard Veneer Chassis		Premium Veneer Top Premium Veneer Chassis		High Pressure Laminate Top Veneer Chassis		Thermally Fused Laminate Top Thermally Fused Laminate Chassis	
		16 x 20 x 22	80	RAL1620PD423W	1080	RAL1620PD423P	1188	"G" Option N/A	

2 Select a finish <a href="#">View finish details</a>	Standard Veneer Top		Premium Veneer Top		High Pressure Laminate Top		Thermally Fused Laminate Top	
	<a href="#">View finish details</a>	WAC WEC WOC WAM WCM WWM WGW WBW WSW WNW	WWP	TSTV TSMV TSLV		GAC GEC GOC GAM GCM GWM GNW GSTV +10%	GSLV +10% GWL	

3 Select a edge <a href="#">View edge details</a>	Standard Veneer Top		Premium Veneer Top		High Pressure Laminate Top		Thermally Fused Laminate Top	
	<a href="#">View edge details</a>	Flat Exposed Plywood		Flat		Flat		Flat

4 Select hardware <a href="#">View hardware details</a>	Standard Veneer Top		Premium Veneer Top		High Pressure Laminate Top		Thermally Fused Laminate Top	
	<a href="#">View hardware details</a>	DK-150 Finger Pull		DK-150		DK-150		DK-150

## Product features.

- File drawers reinforced for heavy storage capacity
- Full extension drawers - locking
- Locking casters are standard
- Soft close suspension drawer(s)

## Options.

### CASTER

- CST20: Industrial caster upgrade - \$100
- Increases height 1.5"

### CUSHION

- BC16: Bench Cushion
- Specify fabric grade (1 yd. required)
- Cushion can only be added to PD423

### DRAWER

- P33: Wood Drawer Upgrade - \$45 per drawer
- WPD3061: Designer White - \$80 per pedestal

### PLANK MATCH VENEER

- RPMV: Random Walnut Plank Match Veneer (Horizontal Grain with 25%+ Sap) - Add 10%. Clear coat only.

### EXPOSED PLYWOOD EDGE

- WEPB: Exposed Plywood Edge w/ Baltic Birch Veneer - n/c
- Only available with WCF - Clear Coat Finish

## BC16 Cushion fabric grades.

COM	COL	1	2	3
224	N/A	261	279	297
4	5	6	7	8
315	333	351	369	387
9	10	11/ L1	12	13/ L2
405	423	441	459	495

# Rail.

Overhead  
Single Storage Overhead Console

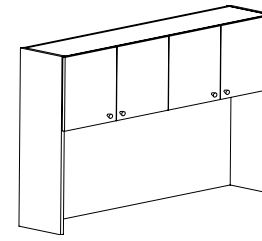

[View statement of line](#)

1 Select a model w" x d" x h"	weight	Standard Veneer Top Standard Veneer Chassis		Premium Veneer Top Premium Veneer Chassis		High Pressure Laminate Top Veneer Chassis		Thermally Fused Laminate Top Thermally Fused Laminate Chassis	
		72 x 14 x 42	245	RAL7242OH325W	2565	RAL7242OH325P	2822	"G" Option N/A	
66 x 14 x 42	230	RAL6642OH325W	2537	RAL6642OH325P	2791	"G" Option N/A		RAL6642OH325M	1446
60 x 14 x 42	215	RAL6042OH325W	2481	RAL6042OH325P	2730	"G" Option N/A		RAL6042OH325M	1390

2 Select a finish <a href="#">View finish details</a>	WAC WWP		TSTV		MAC	
	<a href="#">View finish details</a>	WEC	WWP	TSMV	MEC	MOC
	WOC		TSLV	MOC	MGW	
	WAM			MTW	MSW	
	WCM			MWL		
	WWM					
	WGW					
	WBW					
	WSW					
	WNW					

3 Select a edge <a href="#">View edge details</a>	Flat Exposed Plywood		Flat		Flat	
	<a href="#">View edge details</a>	Flat	Exposed Plywood	Flat	Flat	Flat

4 Select hardware <a href="#">View hardware details</a>	DK-150 Touch Latch		DK-150 Touch Latch		DK-150 Touch Latch	
	<a href="#">View hardware details</a>	DK-150	Touch Latch	DK-150	Touch Latch	DK-150

## Product features.

- Finished top
- Interior cabinet depth 12.5"
- Panel doors with concealed finger pull

### NOTES

- All units are standard w/ flush ends
- Unit has black back panel and is not designed for Open Plan use. Select OPB Option for Open Plan application

## Options.

### DOOR

- D2: Door Lock - \$100 per door set
- D6: Delete Doors - n/c
- D9SC: Soft Close Door Hinges - \$20 per door
- WPD3061: Designer White drawer fronts - \$130 per 2 door section

### GROMMETS (VERTICAL SURFACE)

- Standard Location - \$50 ea.
- Black Plastic Vertical Surface: TM50-C (Bottom Center)
- Non-Standard Location - \$95 ea.
- Black Plastic Vertical Surface: TM50-NS

### OPEN PLAN – FINISHED BACK

- OPB: "W" "G" Style - Modify Unit for Open Plan Application - \$195
- OPB: "M" Style - Modify Unit for Open Plan Application - \$95

### PLANK MATCH VENEER

- RPMV: Random Walnut Plank Match Veneer (Horizontal Grain with 25%+ Sap) - Add 10%. Clear coat only.

### TASK LIGHTING (RECESSED)

Overhead tasklight cord is located on the right facing side. If the opposite location is required please contact customer service.

- LT-LED24R: 24" LED Task light - \$190
- LT-LED48R: 48" LED Task light - \$245
- LT-LED60R: 60" LED Task light - \$310



## Rail tackboards.

Overhead tackboard  
Full width tackboards

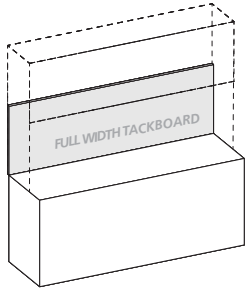

Product Width	Panel Dimension	SKU	COM	1	2	3	4	5	6	7	8	9	10	11/L1	12	13/L2
72"	70 x .75 x 21	FTOC7021	282	361	401	441	481	521	561	601	641	681	721	761	801	881
66"	64 x .75 x 21	FTOC6421	256	330	366	402	438	474	510	546	582	618	654	690	726	798
60"	58 x .75 x 21	FTOC5821	234	299	331	363	395	427	459	491	523	555	587	619	651	715

**Standard Features**

- Constructed of .5" thick fiberboard
- Fabric is precisely aligned and fitted to the tackboard
- Adhered to the rigid hardboard with glue

- Hung with Z-Strip mounting system

Overhead tackboard  
Half width tackboards

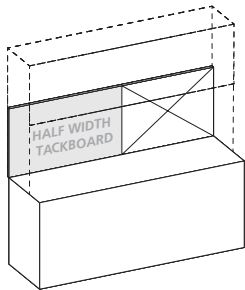

Product Width	Panel Dimension	SKU	COM	1	2	3	4	5	6	7	8	9	10	11/L1	12	13/L2
72 Half Width	36 x .75 x 21	FTOC3621	142	180	200	220	240	260	280	300	320	340	360	380	400	440
66 Half Width	33 x .75 x 21	FTOC3321	128	165	183	201	219	237	255	273	291	309	327	345	363	399

**Standard Features**

- Constructed of .5" thick fiberboard
- Fabric is precisely aligned and fitted to the tackboard
- Adhered to the rigid hardboard with glue
- Hung with Z-Strip mounting system

**Notes**

- Half width tackboards can be specified and combined with Marker Board, Slat Wall and Glass Board options. See "Half Width" items under product width.
- Must specify Right or left facing tackboard

## Rail tackboards.

Overhead dry marker board  
Full width dry marker board

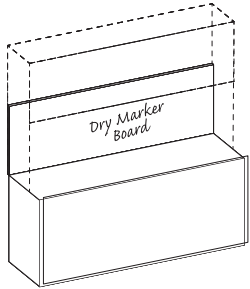

Product Width	Panel Dimension	SKU	List
72"	70 x .5 x 21	DMOC7021	849
66"	64 x .5 x 21	DMOC6421	774
60"	58 x .5 x 21	DMOC5821	699

### Standard Features

- Dry marker panel has edge trim molding
- Standard magnetic surface
- Hung with Z-Strip mounting system

Overhead dry marker board  
Half width dry marker board

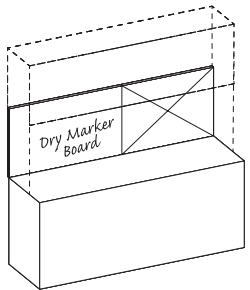

Product Width	Panel Dimension	SKU	List
72 Half Width	35 x .5 x 21	DMOC3521	437
66 Half Width	32 x .5 x 21	DMOC3221	374

### Standard Features

- Dry marker panel has edge trim molding
- Standard magnetic surface
- Hung with Z-Strip mounting system

### Notes

- Half width dry marker boards can be specified and combined with a Tackboard, Veneer Panel, Slat Wall or Glass Board. See "Half Width" items under product width.
- Must specify Right or left facing dry marker board

## Rail tackboards.

### Overhead glassboard Full width glassboards

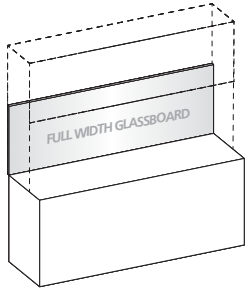

Product Width	Panel Dimension	SKU	List
72"	70 x .5 x 21	GBOC7021	1822
66"	64 x .5 x 21	GBOC6421	1676
60"	58 x .5 x 21	GBOC5821	1531

#### Standard Features

- 4 mm tempered glass
- Hung with Z-Strip mounting system

#### Notes

- Use glass cleaner or alcohol to clean
- Standard dry erase markers may be used
- Earth magnets are required to hold items securely in place

### Overhead glassboard Half width glassboards

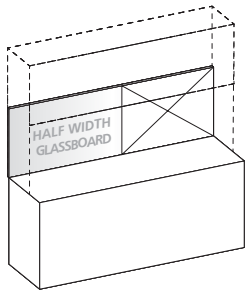

Product Width	Panel Dimension	SKU	List
72 Half Width	35 x .5 x 21	GBOC3521	972
66 Half Width	32 x .5 x 21	GBOC3221	899

#### Standard Features

- 4 mm tempered glass
- Hung with Z-Strip mounting system

#### Notes

- Half width glassboards can be specified and combined with a Tackboard, Veneer panel, Marker Board or Slat Wall. See "Half Width" items under product width.
- Must specify Right or left facing glassboard
- Use glass cleaner or alcohol to clean
- Standard dry erase markers may be used
- Earth magnets are required to hold items securely in place

## Rail tackboards.

Overhead slat wall  
*Half width slat wall*

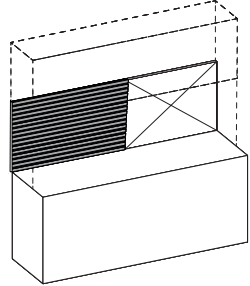

Product Width	Panel Dimension	SKU	List
72 Half Width	34 x .5 x 21	SWOC3421	343
66 Half Width	31 x .5 x 21	SWOC3121	312

### Standard Features

- Available in silver or black
- Hung with Z-Strip mounting system

### Notes

- Half width slat walls can be specified and combined with a Tackboard, Veneer panel, Marker Board or Glassboard. See "Half Width" items under product width.
- Must specify Right or Left position facing slat wall

# Rail.

Single Height Wall Hung Overheads  
14" D Panel Doors - 1/2/3 Section

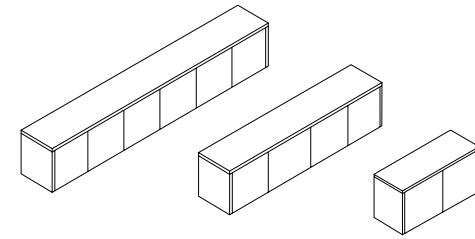

[View statement of line](#)

1 Select a model w" x d" x h"	weight	Standard Veneer Top Standard Veneer Chassis		Premium Veneer Top Premium Veneer Chassis		High Pressure Laminate Top Veneer Chassis	Thermally Fused Laminate Top Thermally Fused Laminate Chassis	
		<b>6 Door / 3 Section</b> 96 x 14 x 18 <b>4 Door / 2 Section</b> 72 x 14 x 18 66 x 14 x 18 60 x 14 x 18 <b>2 Door / 1 Section</b> 36 x 14 x 18 30 x 14 x 18	250 195 160 135 75 65	RAL9618WH330W RAL7218WH330W RAL6618WH330W RAL6018WH330W RAL3618WH330W RAL3018WH330W	3381 2581 2542 2503 1435 1412	RAL9618WH330P RAL7218WH330P RAL6618WH330P RAL6018WH330P RAL3618WH330P RAL3018WH330P	3720 2840 2797 2754 1579 1554	"G" Option N/A "G" Option N/A "G" Option N/A "G" Option N/A "G" Option N/A "G" Option N/A
2 Select a finish <a href="#">View finish details</a>	WAC WEC WOC WAM WCM WWM WGW WBW WSW WNW	WWP	TSTV TSMV TSLV				MAC MEC MOC MGW MTW MSW MWL	
3 Select a edge <a href="#">View edge details</a>	Edge N/A		Edge N/A				Edge N/A	
4 Select hardware <a href="#">View hardware details</a>								

## Product features.

- Doors fully matched set
- Interior cabinet depth 12"
- Mounting wall rail included
- Panel doors with concealed finger pull

### NOTES

- All units are standard w/ flush ends
- Proper installation is critical to ensure safety from possible falling cabinets. The factory assumes no liability for damage or injury from the following: installation into non-load bearing or unlevel walls. Improper fasteners used in installation, overloading of cabinets resulting in failures of wall and surrounding structures, fasteners, or cabinet construction, misuse of cabinets for intended purposes.

## Options.

### DOOR

- D2: Door Lock - \$100 per door set
- D6: Delete Doors - n/c
- D9SC: Soft Close Door Hinges - \$20 per door
- WPD3061: Designer White Fronts - \$130 per 2 door section

### TASK LIGHTING (RECESSED)

Overhead tasklight cord is located on the right facing side. If the opposite location is required please contact customer service.

- LT-LED24R: 24" LED Task light - \$190
- LT-LED48R: 48" LED Task light - \$245
- LT-LED60R: 60" LED Task light - \$310
- LT-LED72R: 72" LED Task light - \$335
- LC24: Linking Task light cable - \$25

### PLANK MATCH VENEER

- RPMV: Random Walnut Plank Match Veneer (Horizontal Grain with 25%+ Sap) - Add 10%. Clear coat only.

### EXPOSED PLYWOOD EDGE

- WEPB: Exposed Plywood Edge w/ Baltic Birch Veneer - n/c
- Only available with WCF - Clear Coat Finish

## Rail tackboards.

Wall hung tackboard  
Full width tackboards

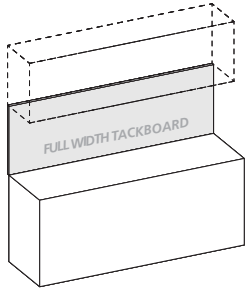

Product Width	Panel Dimension	SKU	COM	1	2	3	4	5	6	7	8	9	10	11/L1	12	13/L2
96	96 x .75 x 24	FTWH9624	465	576	627	678	729	780	831	882	933	984	1035	1086	1137	1239
72	72 x .75 x 24	FTWH7224	355	434	474	514	554	594	634	674	714	754	794	834	874	954
66	66 x .75 x 24	FTWH6624	322	396	432	468	504	540	576	612	648	684	720	756	792	864
60	60 x .75 x 24	FTWH6024	294	359	391	423	455	487	519	551	583	615	647	679	711	775
36	36 x .75 x 24	FTWH3624	176	217	237	257	277	297	317	337	357	377	397	417	437	477
30	30 x .75 x 24	FTWH3024	142	179	196	213	230	247	264	281	298	315	332	349	366	400

### Standard Features

- Constructed of .5" thick fiberboard
- Fabric is precisely aligned and fitted to the tackboard
- Adhered to the rigid hardboard with glue
- Hung with Z-Strip mounting system

Wall hung tackboard  
Half width tackboards

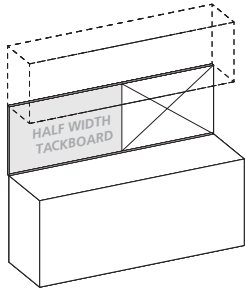

Product Width	Panel Dimension	SKU	COM	1	2	3	4	5	6	7	8	9	10	11/L1	12	13/L2
96 Half Width	48 x .75 x 24	FTWH4824	233	288	313	338	363	388	413	438	463	488	513	538	563	613
72 Half Width	36 x .75 x 24	FTWH3624	178	217	237	257	277	297	317	337	357	377	397	417	437	477
66 Half Width	33 x .75 x 24	FTWH3324	161	198	216	234	252	270	288	306	324	342	360	378	396	432

### Standard Features

- Constructed of .5" thick fiberboard
- Fabric is precisely aligned and fitted to the tackboard
- Adhered to the rigid hardboard with glue
- Hung with Z-Strip mounting system

### Notes

- Half width tackboards can be specified and combined with a Veneer Panel, Marker Board, Slat Wall or Glass Board. See "Half Width" items under product width.
- Must specify Right or left facing tackboard

## Rail tackboards.

Wall hung dry marker board  
Full width dry marker boards

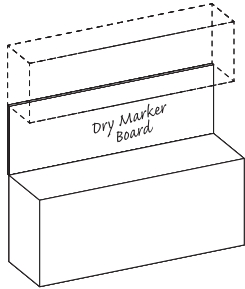

Product Width	Panel Dimension	SKU	List
72	72 x .75 x 24	DMWH7224	874
66	66 x .75 x 24	DMWH6624	799
60	60 x .75 x 24	DMWH6024	724
36	36 x .75 x 24	DMWH3624	437
30	30 x .75 x 24	DMWH3024	362

### Standard Features

- Dry marker panel has edge trim molding
- Standard magnetic surface
- Hung with Z-Strip mounting system

Wall hung dry marker board  
Half width dry marker boards

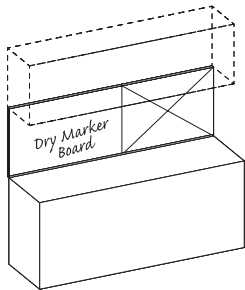

Product Width	Panel Dimension	SKU	List
96 Half Width	48 x .75 x 24	DMWH4824	580
72 Half Width	36 x .75 x 24	DMWH3624	437
66 Half Width	33 x .75 x 24	DMWH3324	399

### Standard Features

- Dry marker panel has edge trim molding
- Standard magnetic surface
- Hung with Z-Strip mounting system

### Notes

- Half width dry marker boards can be specified and combined with a Tackboard, Veneer Panel, Slat Wall or Glass Board. See "Half Width" items under product width
- Must specify Right or left facing dry marker board

## Rail tackboards.

Wall hung veneer panel  
Full width veneer panel

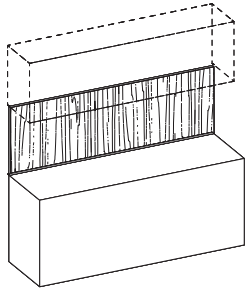

Product Width	Panel Dimension	SKU	List
96	96 x .75 x 24	VPWH9624	967
72	72 x .75 x 24	VPWH7224	728
66	66 x .75 x 24	VPWH6624	666
60	60 x .75 x 24	VPWH6024	603
36	36 x .75 x 24	VPWH3624	364
30	30 x .75 x 24	VPWH3024	302

### Standard Features

- Veneer edges
- Vertical wire channels on back for task light cords
- Steel mounting wall channel is recessed for flush mounting
- Hung with Z-Strip mounting system

### Notes

- Can be used with or without overhead cabinet
- Required for other accessory panels

Wall hung veneer panel  
Half width veneer panel

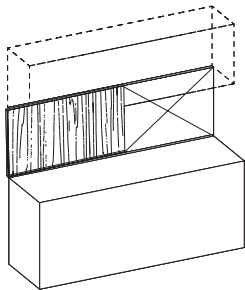

Product Width	Panel Dimension	SKU	List
96 Half Width	48 x .75 x 24	VPWH4824	484
72 Half Width	36 x .75 x 24	VPWH3624	364
66 Half Width	33 x .75 x 24	VPWH3324	333

### Standard Features

- Veneer edges
- Vertical wire channels on back for task light cords
- Steel mounting wall channel is recessed for flush mounting
- Hung with Z-Strip mounting system

### Notes

- Half width veneer panels can be specified and combined with a Tackboard, Marker Board, Slat Wall or Glass Board. See "Half Width" items under product width
- Must specify Right or left facing veneer panel
- Can be used with or without overhead cabinet
- Required for other accessory panels



## Rail tackboards.

Wall hung glassboard  
Full width glassboards

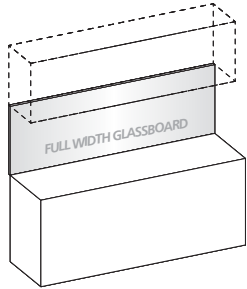

Product Width	Panel Dimension	SKU	List
96	96 x .75 x 24	GBWH9624	2753
72	72 x .75 x 24	GBWH7224	2114
66	66 x .75 x 24	GBWH6624	1948
60	60 x .75 x 24	GBWH6024	1780
36	36 x .75 x 24	GBWH3624	1142
30	30 x .75 x 24	GBWH3024	976

### Standard Features

- 4 mm tempered glass
- Hung with Z-Strip mounting system

### Notes

- Use glass cleaner or alcohol to clean
- Standard dry erase markers may be used
- Earth magnets are required to hold items securely in place

Wall hung glassboard  
Half width glassboards

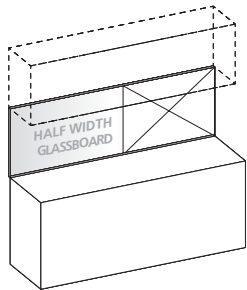

Product Width	Panel Dimension	SKU	List
96 Half Width	48 x .75 x 24	GBWH4824	1461
72 Half Width	36 x .75 x 24	GBWH3624	1142
66 Half Width	33 x .75 x 24	GBWH3324	1059

### Standard Features

- 4 mm tempered glass
- Hung with Z-Strip mounting system

### Notes

- Half width glassboards can be specified and combined with a Tackboard, Veneer panel, Marker Board or Slat Wall. See "Half Width" items under product width
- Must specify Right or Left position facing glassboard
- Use glass cleaner or alcohol to clean
- Standard dry erase markers may be used
- Earth magnets are required to hold items securely in place

## Rail tackboards.

Wall hung slat wall  
*Half width slat wall*

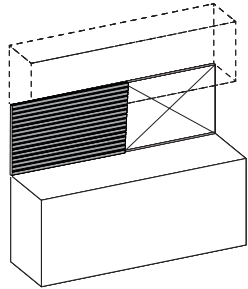

Product Width	Panel Dimension	SKU	List
96 Half Width	48 x .75 x 24	SWWH4824	484
72 Half Width	36 x .75 x 24	SWWH3624	364
66 Half Width	33 x .75 x 24	SWWH3324	333

### Standard Features

- Available in silver or black
- Hung with Z-Strip mounting system

### Notes

- Half width slat walls can be specified and combined with a Tackboard, Veneer panel, Marker Board or Glassboard. See "Half Width" items under product width
- Must specify Right or left facing slat wall

# Rail.

Single Height Wall Hung Overheads  
Open Endless Shelf Single Height

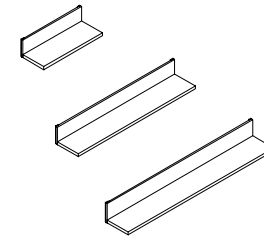

[View statement of line](#)

1 Select a model w" x d" x h"	weight	Standard Veneer Top Standard Veneer Chassis		Premium Veneer Top Premium Veneer Chassis		High Pressure Laminate Top Veneer Chassis	Thermally Fused Laminate Top Thermally Fused Laminate Chassis	
		72 x 12 x 9	85	RAL7209WH336W	1941	RAL7209WH336P	2136	"G" Option N/A
66 x 12 x 9	75	RAL6609WH336W	1777	RAL6609WH336P	1955	"G" Option N/A	RAL6609WH336M	1271
60 x 12 x 9	70	RAL6009WH336W	1620	RAL6009WH336P	1782	"G" Option N/A	RAL6009WH336M	1216
36 x 12 x 9	35	RAL3609WH336W	1080	RAL3609WH336P	1188	"G" Option N/A	RAL3609WH336M	810
30 x 12 x 9	30	RAL3009WH336W	922	RAL3009WH336P	1015	"G" Option N/A	RAL3009WH336M	743
2 Select a finish <a href="#">View finish details</a>		WAC	WWP	TSTV			MAC	
		WEC		TSMV			MEC	
		WOC		TSLV			MOC	
		WAM					MGW	
		WCM					MTW	
		WWW					MSW	
		WGW					MWL	
		WBW						
		WSW						
		WNW						
3 Select a edge <a href="#">View edge details</a>								
		Flat		Flat			Flat	
		Exposed Plywood						
4 Select hardware <a href="#">View hardware details</a>		Hardware		Hardware			Hardware	
		N/A		N/A			N/A	

## Product features.

- Mounting rails included

### NOTES

- Proper installation is critical to ensure safety from possible falling cabinets. The factory assumes no liability for damage or injury from the following: installation into non-load bearing or unlevel walls. Improper fasteners used in installation, overloading of cabinets resulting in failures of wall and surrounding structures, fasteners, or cabinet construction, misuse of cabinets for intended purposes.  
- Max load per inch is 3lbs

## Options.

### EXPOSED PLYWOOD EDGE

- WEPB: Exposed Plywood Edge w/ Baltic Birch Veneer - n/c  
- Only available with WCF - Clear Coat Finish

### PLANK MATCH VENEER

- RPMV: Random Walnut Plank Match Veneer (Horizontal Grain with 25%+ Sap) - Add 10%. Clear coat only.

# Rail.

Freestanding Half Towers  
Wardrobes

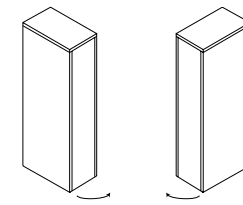

Hinged Right

Hinged Left

*View statement of line*

1 Select a model w" x d" x h"	weight	Standard Veneer Top Standard Veneer Chassis		Premium Veneer Top Premium Veneer Chassis		High Pressure Laminate Top Veneer Chassis	Thermally Fused Laminate Top Thermally Fused Laminate Chassis	
		<b>Left Hinge</b> 10 x 24 x 48	75	RAL1024OP709W	1519	RAL1024OP709P	1671	"G" Option N/A
<b>Right Hinge</b> 10 x 24 x 48	75	RAL1024OP710W	1519	RAL1024OP710P	1671	"G" Option N/A	RAL1024OP710M	1052
<b>2 Select a finish</b> <i>View finish details</i>		WAC WEC WOC WAM WCM WWM WGW WBW WSW WNW	WWP	TSTV TSMV TSLV			MAC MEC MOC MGW MTW MSW MWL	
<b>3 Select a edge</b> <i>View edge details</i>		Flat Exposed Plywood		Flat			Flat	
<b>4 Select hardware</b> <i>View hardware details</i>		Touch Latch		Touch Latch			Touch Latch	

## Product features.

- Coat rod
- Touch latch

## Options.

### DOOR

- D2: Door Lock - \$100 per door

### PLANK MATCH VENEER

- RPMV: Random Walnut Plank Match Veneer (Horizontal Grain with 25%+ Sap) - Add 10%. Clear coat only.

### EXPOSED PLYWOOD EDGE

- WEPB: Exposed Plywood Edge w/ Baltic Birch Veneer - n/c
- Only available with WCF - Clear Coat Finish

# Rail.

Freestanding Half Towers  
Storage / File

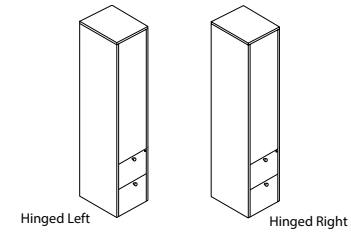

1 Select a model w" x d" x h"	weight	Standard Veneer Top Standard Veneer Chassis		Premium Veneer Top Premium Veneer Chassis		High Pressure Laminate Top Veneer Chassis		Thermally Fused Laminate Top Thermally Fused Laminate Chassis	
		<b>Door Hinged Left</b> 16 x 24 x 71	175	RAL1671TW291W	3132	RAL1671TW291P	3446	"G" Option N/A	
<b>Door Hinged Right</b> 16 x 24 x 71	175	RAL1671TW292W	3132	RAL1671TW292P	3446	"G" Option N/A		RAL1671TW292M	1626

2 Select a finish <i>View finish details</i>	WAC WWP		TSTV		MAC	
	<i>View finish details</i>	WEC		TSMV		MEC
	WOC		TSLV		MOC	
	WAM				MGW	
	WCM				MTW	
	WWM				MSW	
	WGW				MWL	
	WBW					
	WSW					
	WNW					

3 Select a edge <i>View edge details</i>	Flat Exposed Plywood		Flat		Flat	
	<i>View edge details</i>					

4 Select hardware <i>View hardware details</i>	DK-150 Touch Latch		DK-150 Touch Latch		DK-150 Touch Latch	
	<i>View hardware details</i>					

*View statement of line*

## Product features.

- Interior cabinet depth 22"
- Soft close suspension drawer(s)
- Standard fixed shelf with 2 adjustable shelves (71")

### NOTES

- Unit has black back panel and is not designed for Open Plan use. Select OPB Option for Open Plan application.

## Options.

### DOOR

- D2: Door Lock - \$100 per door set
- D6: Delete Doors - n/c
- D9SC: Soft Close Door Hinges - \$20 per door

### DRAWER

- P33: Wood Drawer Upgrade - \$45 per drawer
- P6: Modify File/File to Box/Box/File - \$55 per pedestal
- WPD3061: Designer White - \$80 per pedestal

### OPEN PLAN – FINISHED BACK

- OPB: "W" "G" Style - Modify Unit for Open Plan Application - \$295
- OPBM: "M" Style - Modify Unit for Open Plan Application - \$95

### PLANK MATCH VENEER

- RPMV: Random Walnut Plank Match Veneer (Horizontal Grain with 25%+ Sap) - Add 10%. Clear coat only.

### EXPOSED PLYWOOD EDGE

- WEPB: Exposed Plywood Edge w/ Baltic Birch Veneer - n/c
- Only available with WCF - Clear Coat Finish

# Rail.

Freestanding Towers  
Storage / File Full Tower

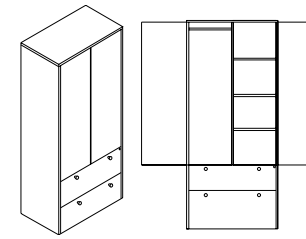

1 Select a model w" x d" x h"	weight	Standard Veneer Top Standard Veneer Chassis		Premium Veneer Top Premium Veneer Chassis		High Pressure Laminate Top Veneer Chassis		Thermally Fused Laminate Top Thermally Fused Laminate Chassis	
		29 x 24 x 71	295	RAL2971TW281W	4230	RAL2971TW281P	4653	"G" Option N/A	RAL2971TW281M
2 Select a finish <i>View finish details</i>	WAC WWP		TSTV		MEC		MAC		
	WEC		TSMV		MOC		MGW		
3 Select a edge <i>View edge details</i>	WOC		TSLV		MSW		MWL		
	WAM		Flat		Touch Latch		Touch Latch		
	WCM		Exposed Plywood		DK-150		DK-150		
	WWM		Flat		Touch Latch		Touch Latch		
	WGW		Flat		Touch Latch		Touch Latch		
	WBW		Flat		Touch Latch		Touch Latch		
	WSW		Flat		Touch Latch		Touch Latch		
	WNW		Flat		Touch Latch		Touch Latch		
	Flat		Flat		Touch Latch		Touch Latch		
	Exposed Plywood		Flat		Touch Latch		Touch Latch		
4 Select hardware <i>View hardware details</i>	DK-150		DK-150		DK-150		DK-150		
	Touch Latch		Touch Latch		Touch Latch		Touch Latch		

[View statement of line](#)

## Product features.

- 71" has 2 adj. shelves / 1 fixed shelf
- Full extension drawers
- Locking drawers
- Soft close suspension drawer(s)

### NOTES

- Unit has black back panel and is not designed for Open Plan use. Select OPB Option for Open Plan application.

## Options.

### DOOR

- D2: Door Lock - \$100 per door set
- D6: Delete Doors - n/c
- D9SC: Soft Close Door Hinges - \$20 per door

### DRAWER

- P33: Wood Drawer Upgrade - \$45 per drawer
- WPD3061: Designer White - \$80 per pedestal

### OPEN PLAN – FINISHED BACK

- OPB: "W" "G" Style - Modify Unit for Open Plan Application - \$295
- OPBM: "M" Style - Modify Unit for Open Plan Application - \$95

### PLANK MATCH VENEER

- RPMV: Random Walnut Plank Match Veneer (Horizontal Grain with 25%+ Sap) - Add 10%. Clear coat only.

### EXPOSED PLYWOOD EDGE

- WEPB: Exposed Plywood Edge w/ Baltic Birch Veneer - n/c
- Only available with WCF - Clear Coat Finish Shelves

- MOD30: 71" Delete center partition & add 1 fixed shelf, 3 adjustable shelves - \$295

# Rail.

Bookcases  
Wall Mount Bookcase

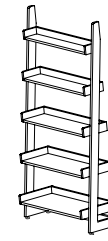

[View statement of line](#)

1 Select a model w" x d" x h"	weight	Exposed Plywood Clear Coat Finish			
30 x 13.75 x 71	75	RAL3071BK254W 1564	"P" Option N/A	"G" Option N/A	"M" Option N/A
2 Select a finish <a href="#">View finish details</a>		WEPP			
3 Select an edge <a href="#">View edge details</a>		Edge N/A			
4 Select hardware <a href="#">View hardware details</a>		Hardware N/A			

## Product features.

- 3/4" Thick finished shelves standard
- Exposed plywood standard
- Interior shelf depth from bottom to top 13", 11", 9", 7", 5"
- Mounting hardware included

### NOTES

- Not meant to gang
- 13" distance between shelves

# Rail.

Bookcases  
14" D Open Bookcase

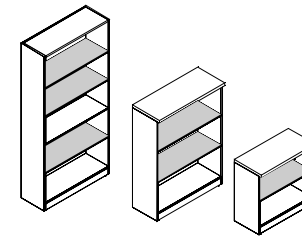

1 Select a model w" x d" x h"	weight	Standard Veneer Top Standard Veneer Chassis		Premium Veneer Top Premium Veneer Chassis		High Pressure Laminate Top Veneer Chassis		Thermally Fused Laminate Top Thermally Fused Laminate Chassis	
		<b>30" Width</b>							
30 x 14 x 71	140	RAL3071BK250W	1888	RAL3071BK250P	2077	"G" Option N/A		RAL3071BK250M	1165
30 x 14 x 48	105	RAL3048BK250W	1508	RAL3048BK250P	1659	RAL3048BK250G	1508	RAL3048BK250M	980
30 x 14 x 30.75	90	RAL3030BK250W	1335	RAL3030BK250P	1469	RAL3030BK250G	1335	RAL3030BK250M	721
2 Select a finish <i>View finish details</i>		WAC	WWP	TSTV		GAC	GSLV +10%	MAC	
		WEC		TSMV		GEC	GWL	MEC	
		WOC		TSLV		GOC		MOC	
		WAM				GAM		MGW	
		WCM				GCM		MTW	
		WWM				GWM		MSW	
		WGW				GNW		MWL	
		WBW				GSTV	+10%		
		WSW							
		WNW							
3 Select a edge <i>View edge details</i>									
		Flat	Exposed Plywood	Flat		Flat		Flat	
4 Select hardware <i>View hardware details</i>		Hardware		Hardware		Hardware		Hardware	
		N/A		N/A		N/A		N/A	

[View statement of line](#)

## Product features.

- 3/4" Thick finished shelves standard
- Interior shelf depth 12"
- "W" styles - 29", 48", and 71" H units finished top

### NOTES

- Adjustable shelves shaded
- Unit has black back panel and is not designed for Open Plan use. Select OPB Option for Open Plan application

## Options.

### INTERIOR CABINET LIGHT

- LEDPK starter kit includes Infeed, 1 Puck Interior Light and the ability to daisy chain up to 6 total Puck Lights
- LEDPK: LED Puck Starter Kit - \$310
- PK: 1 LED Interior Light - \$130 ea.

### OPEN PLAN – FINISHED BACK

- OPB: "W" "G" Style - Modify Unit for Open Plan Application - \$295
- OPB: "M" Style - Modify Unit for Open Plan Application - \$95

### SHELVES

- GS14F: Replace Standard Shelves with Glass Shelves - \$90 per shelf
- S714F: Heavy Duty Lumber 1" Shelves - \$80 per shelf ("M" Styles - n/a)

### PLANK MATCH VENEER

- RPMV: Random Walnut Plank Match Veneer (Horizontal Grain with 25%+ Sap) - Add 10%. Clear coat only.

### EXPOSED PLYWOOD EDGE

- WEPB: Exposed Plywood Edge w/ Baltic Birch Veneer - n/c
- Only available with WCF - Clear Coat Finish



# Rail.

Storage  
All-In-One Two Sided Storage

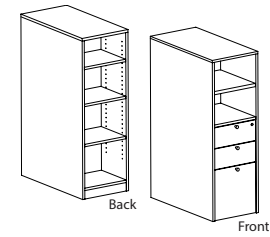

[View statement of line](#)

1 Select a model w" x d" x h"	weight	Standard Veneer Top Standard Veneer Chassis		Premium Veneer Top Premium Veneer Chassis		High Pressure Laminate Top Veneer Chassis		Thermally Fused Laminate Top Thermally Fused Laminate Chassis	
		16 x 30 x 48	160	RAL1648OP738W	2092	RAL1648OP738P	2302	"G" Option N/A	RAL1648OP738M
2 Select a finish <a href="#">View finish details</a>		WAC WEC WOC WAM WCM WWM WGW WBW WSW WNW	WWP	TSTV TSMV TSLV			MAC MEC MOC MGW MTW MSW MWL		
3 Select a edge <a href="#">View edge details</a>		Flat Exposed Plywood		Flat			Flat		
4 Select hardware <a href="#">View hardware details</a>		DK-150 Only available on exposed plywood Finger Pull		DK-150			DK-150		

## Product features.

- Full extension drawers - locking
- Soft close suspension drawer(s)

### NOTES

- Unit is two sided

## Options.

### DRAWER

- P6: Modify Box/Box/File to File/File - \$55 per pedestal
- P33: Wood Drawer Upgrade - \$45 per drawer
- WPD3061: Designer White drawer fronts - \$80 per pedestal

### PLANK MATCH VENEER

- RPMV: Random Walnut Plank Match Veneer (Horizontal Grain with 25%+ Sap) - Add 10%. Clear coat only.

### EXPOSED PLYWOOD EDGE







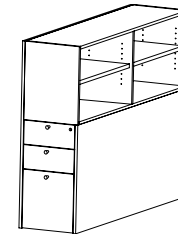

- WEPB: Exposed Plywood Edge w/ Baltic Birch Veneer - n/c
- Only available with WCF - Clear Coat Finish

# Rail.

Storage  
All-In-One Single Side Storage



[View statement of line](#)

1 Select a model w" x d" x h"	weight	Standard Veneer Top Standard Veneer Chassis		Premium Veneer Top Premium Veneer Chassis		High Pressure Laminate Top Veneer Chassis		Thermally Fused Laminate Top Thermally Fused Laminate Chassis	
		<b>All-In-One Single Side Storage Left</b> 16 x 30 x 48      200    RAL1648OP736W    2307 <b>All-In-One Single Side Storage Right</b> 16 x 30 x 48      200    RAL1648OP737W    2307				RAL1648OP736P      2538 RAL1648OP737P      2538	"G" Option N/A "G" Option N/A		RAL1648OP736M      1226 RAL1648OP737M      1226
2 Select a finish <a href="#">View finish details</a>		WAC    WWP WEC WOC WAM WCM WWM WGW WBW WSW WNW		TSTV TSMV TSLV			MAC MEC MOC MGW MTW MSW MWL		
3 Select a edge <a href="#">View edge details</a>		 Flat  Exposed Plywood		 Flat			 Flat		
4 Select hardware <a href="#">View hardware details</a>		 DK-150  Only available on exposed plywood Finger Pull		 DK-150			 DK-150		

## Product features.

- File drawers reinforced for heavy storage capacity
- Finished Back - open plan
- Full extension drawers - locking
- Soft close suspension drawer(s)
- Two units are offered that allows for additional storage away from the work surface - Door Unit and File Unit

## Options.

### DRAWER

- P6: Modify Box/Box/File to File/File - \$55 per pedestal
- P33: Wood Drawer Upgrade - \$45 per drawer
- WPD3061: Designer White drawers and doors - \$80 per pedestal

### GROMMETS (VERTICAL SURFACE)

- Grommet location is 5.5" from bottom, 3" from back
- TM50: 1 5/8" DIA Black standard location grommet - \$50 each
  - TM50: 1 5/8" DIA Black non-standard location grommet - \$95 each
  - TM60: 3 1/2" DIA Black standard location grommet - \$50 each
  - TM60: 3 1/2" DIA Black non-standard location grommet - \$95 each

### PLANK MATCH VENEER

- RPMV: Random Walnut Plank Match Veneer (Horizontal Grain with 25%+ Sap) - Add 10%. Clear coat only.

### EXPOSED PLYWOOD EDGE

- WEPB: Exposed Plywood Edge w/ Baltic Birch Veneer - n/c
- Only available with WCF - Clear Coat Finish

# Rail.

Shared Storage  
All-In-One Cabinet - Single Sided

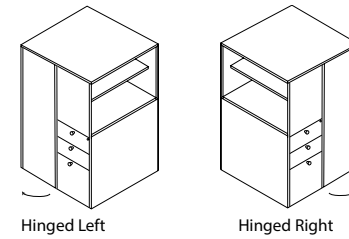

[View statement of line](#)

1 Select a model w" x d" x h"	weight	Standard Veneer Top Standard Veneer Chassis		Premium Veneer Top Premium Veneer Chassis		High Pressure Laminate Top Veneer Chassis		Thermally Fused Laminate Top Thermally Fused Laminate Chassis	
		<b>Left Hinge Wardrobe / Right B/B/F</b> 26 x 30 x 48    250 RAL2648OP704W    3099 <b>Right Hinge Wardrobe / Left B/B/F</b> 26 x 30 x 48    250 RAL2648OP705W    3099				RAL2648OP704P    3409		"G" Option N/A	
				RAL2648OP705P    3409		"G" Option N/A		RAL2648OP705M    1642	

2 Select a finish <a href="#">View finish details</a>	WAC    WWP		TSTV		MAC	
	WEC WOC WAM WCM WWM WGW WBW WSW WNW			TSMV		MEC
			TSLV		MOC	
					MGW	
					MTW	
					MSW	
					MWL	

3 Select a edge <a href="#">View edge details</a>	Flat    Exposed Plywood		Flat		Flat	

4 Select hardware <a href="#">View hardware details</a>	DK-150    Touch Latch		DK-150    Touch Latch		DK-150    Touch Latch	

## Product features.

- File drawers reinforced for heavy storage capacity
- Full extension drawers - locking
- Soft close suspension drawer(s)
- Two units are offered that allows for additional storage away from the work surface - Door Unit and File Unit
- Wardrobes have hanging bar and touch latch doors

## Options.

### DOOR

- D2: Door Lock - \$100 per door set
- D9SC: Soft Close Door Hinges - \$20 per door

### DRAWER

- P33: Wood Drawer Upgrade - \$45 per drawer
- P6: Modify Box/Box/File to File/File - \$55 per pedestal
- WPD3061: Designer White - \$80 per pedestal

### GROMMETS (STANDARD LOCATION)

- TM50: 5.5" from bottom, 3" from back - \$95
- TM60: 5.5" from bottom, 3" from back - \$95

### PLANK MATCH VENEER

- RPMV: Random Walnut Plank Match Veneer (Horizontal Grain with 25%+ Sap) - Add 10%. Clear coat only.

### EXPOSED PLYWOOD EDGE

- WEPB: Exposed Plywood Edge w/ Baltic Birch Veneer - n/c
- Only available with WCF - Clear Coat Finish

# Rail.

Double Sided - Shared Storage  
All-In-One Cabinet - Double Sided

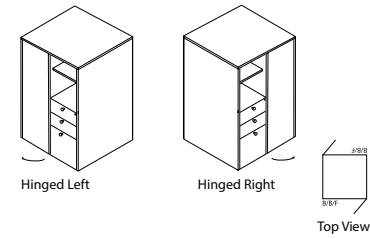

[View statement of line](#)

1 Select a model w" x d" x h"	weight	Standard Veneer Top Standard Veneer Chassis		Premium Veneer Top Premium Veneer Chassis		High Pressure Laminate Top Veneer Chassis		Thermally Fused Laminate Top Thermally Fused Laminate Chassis	
		<b>Left Hinge Wardrobe / Right B/B/F</b> 30.5 x 30 x 48 <b>Right Hinge Wardrobe / Left B/B/F</b> 30.5 x 30 x 48	250 250	RAL3048OP734W 3363 RAL3048OP735W 3363	RAL3048OP734P 3700 RAL3048OP735P 3700	"G" Option N/A "G" Option N/A	RAL3048OP734M 1772 RAL3048OP735M 1772	RAL3048OP734M 1772 RAL3048OP735M 1772	
2 Select a finish <a href="#">View finish details</a>		WAC WWP WEC WOC WAM WCM WWM WGW WBW WSW WNW		TSTV TSMV TSLV		MAC MEC MOC MGW MTW MSW MWL			
3 Select a edge <a href="#">View edge details</a>		Flat Exposed Plywood		Flat		Flat			
4 Select hardware <a href="#">View hardware details</a>		DK-150 Touch Latch		DK-150 Touch Latch		DK-150 Touch Latch			

## Product features.

- File drawers reinforced for heavy storage capacity
- Full extension drawers - locking
- Soft close suspension drawer(s)
- Wardrobes have hanging bar and touch latch doors

## Options.

### DOOR

- D2: Door Lock - \$100 per door set
- D9SC: Soft Close Door Hinges - \$20 per door

### DRAWER

- P33: Wood Drawer Upgrade - \$45 per drawer
- P6: Modify Box/Box/File to File/File - \$55 per pedestal
- WPD3061: Designer White - \$80 per pedestal

### GROMMETS (STANDARD LOCATION)

- TM50(2): Bottom center of each side - \$100 (\$50 each)

### PLANK MATCH VENEER

- RPMV: Random Walnut Plank Match Veneer (Horizontal Grain with 25%+ Sap) - Add 10%. Clear coat only.

### EXPOSED PLYWOOD EDGE

- WEPB: Exposed Plywood Edge w/ Baltic Birch Veneer - n/c
- Only available with WCF - Clear Coat Finish

# Rail.

Locker Storage  
4 Door Locker

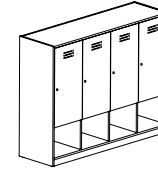

[View statement of line](#)

1 Select a model w" x d" x h"	weight	Standard Veneer Top Standard Veneer Chassis		Premium Veneer Top Premium Veneer Chassis		High Pressure Laminate Top Veneer Chassis		Thermally Fused Laminate Top Thermally Fused Laminate Chassis	
		61 x 18 x 48	300	RAL6148LK717W	3363	RAL6148LK717P	3700	"G" Option N/A	RAL6148LK717M
2 Select a finish <a href="#">View finish details</a>		WAC WWP WEC WOC WAM WCM WWM WGW WBW WSW WNW		TSTV TSMV TSLV				MAC MEC MOC MGW MTW MSW MWL	
3 Select an edge <a href="#">View edge details</a>		Flat Exposed Plywood		Flat				Flat	
4 Select hardware <a href="#">View hardware details</a>		Touch Latch		Touch Latch				Touch Latch	

## Product features.

- Cabinet w/ Coat Hook
- Touch latch standard
- Key lock standard

## Options.

### DOOR

- D3: Combination Lock - \$100 per door
- D9SC: Soft Close Door Hinges - \$20 per door

### PLANK MATCH VENEER

- RPMV: Random Walnut Plank Match Veneer (Horizontal Grain with 25%+ Sap) - Add 10%. Clear coat only.





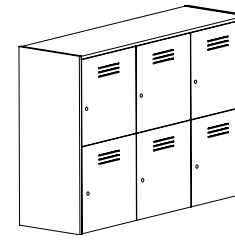

### EXPOSED PLYWOOD EDGE

- WEPB: Exposed Plywood Edge w/ Baltic Birch Veneer - n/c
- Only available with WCF - Clear Coat Finish

# Rail.

Locker Storage  
6 Door Locker



1 Select a model w" x d" x h"	weight	Standard Veneer Top Standard Veneer Chassis		Premium Veneer Top Premium Veneer Chassis		High Pressure Laminate Top Veneer Chassis		Thermally Fused Laminate Top Thermally Fused Laminate Chassis	
		61 x 18 x 48	325	RAL6148LK721W	3543	RAL6148LK721P	3898	"G" Option N/A	RAL6148LK721M
2 Select a finish <i>View finish details</i>		WAC WWP WEC WOC WAM WCM WWM WGW WBW WSW WNW		TSTV TSMV TSLV				MAC MEC MOC MGW MTW MSW MWL	
3 Select a edge <i>View edge details</i>		 Flat  Exposed Plywood		 Flat				 Flat	
4 Select hardware <i>View hardware details</i>		 Touch Latch		 Touch Latch				 Touch Latch	

[View statement of line](#)

## Product features.

- Touch latch standard
- Key lock standard

## Options.

### DOOR

- D3: Combination Lock - \$100 per door
- D9SC: Soft Close Door Hinges - \$20 per door

### PLANK MATCH VENEER

- RPMV: Random Walnut Plank Match Veneer (Horizontal Grain with 25%+ Sap) - Add 10%. Clear coat only.

### EXPOSED PLYWOOD EDGE

- WEPB: Exposed Plywood Edge w/ Baltic Birch Veneer - n/c
- Only available with WCF - Clear Coat Finish

# Rail.

Reception  
Inset Reception Counter Top

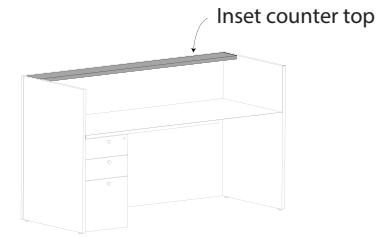

[View statement of line](#)

1 Select a model w" x d" x h"	weight	Standard Veneer Top		Premium Veneer Top		High Pressure Laminate Top		Thermally Fused Laminate Top	
		Standard Veneer Chassis		Premium Veneer Chassis		Veneer Chassis		Thermally Fused Laminate Chassis	
<b>Counter Top for 84" Reception Desk</b>									
82 x 9 x 1.25	35	RAL8209TC513W	1125	RAL8209TC513P	1238	RAL8209TC513G	1125	RAL8209TC513M	586
<b>Counter Top for 72" Reception Desk</b>									
70 x 9 x 1.25	30	RAL7009TC513W	973	RAL7009TC513P	1068	RAL7009TC513G	973	RAL7009TC513M	569
<b>Counter Top for 66" Reception Desk</b>									
64 x 9 x 1.25	25	RAL6409TC513W	940	RAL6409TC513P	1034	RAL6409TC513G	940	RAL6409TC513M	551
2 Select a finish <a href="#">View finish details</a>		WAC	WWP	TSTV		GAC	GSLV +10%	MAC	
		WEC		TSMV		GEC	GWL	MEC	
		WOC		TSLV		GOC		MOC	
		WAM				GAM		MGW	
		WCM				GCM		MTW	
		WWM				GWM		MSW	
		WGW				GNW		MWL	
		WBW				GSTV			
		WSW				+10%			
		WNW							
3 Select a edge <a href="#">View edge details</a>									
		Flat	Exposed Plywood	Flat		Flat		Flat	
4 Select hardware <a href="#">View hardware details</a>		Hardware		Hardware		Hardware		Hardware	
		N/A		N/A		N/A		N/A	

## Product features.

### NOTES

- Customer must specify counter top in order to specify cliff counter
- Recessed counter

## Options.

### GLASS COUNTER

- Soft etch back painted white glass
- SEGW8209 82" Glass counter - \$1190
- SEGW7009 70" Glass Counter - \$1135
- SEGW6409 64" Glass Counter - \$1105

### PLANK MATCH VENEER

- RPMV: Random Walnut Plank Match Veneer (Horizontal Grain with 25%+ Sap) - Add 10%. Clear coat only.

### EXPOSED PLYWOOD EDGE

- WEPB: Exposed Plywood Edge w/ Baltic Birch Veneer - n/c
- Only available with WCF - Clear Coat Finish

# Rail.

Reception  
Solid Surface Cliff Counter

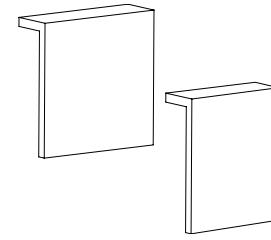

[View statement of line](#)

1 Select a model		weight			
w" x d" x h"					
<b>Cliff Counter Solid Surface</b>					
30 x 10 x 32	40	RAL3010CC514	2678	2946	
20 x 10 x 32	30	RAL2010CC514	2604	2865	
2 Select a finish		N/A			
<a href="#">View finish details</a>					
3 Select a edge		Edge			
<a href="#">View edge details</a>		N/A			
4 Select hardware		Hardware			
<a href="#">View hardware details</a>		N/A			

## Product features.

**NOTES**

- Customer must specify counter top in order to specify cliff counter

## Options.

- **CHOOSE QUARTZ: G10 BLACK PEARL, G38 SEA OAT QUARTZ, G04 WHITE QUARTZ**





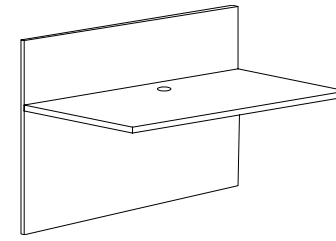

# Rail.

Reception Bridge  
Standard "U" Bridge



[View statement of line](#)

1 Select a model w" x d" x h"	weight	Standard Veneer Top Standard Veneer Chassis		Premium Veneer Top Premium Veneer Chassis		High Pressure Laminate Top Veneer Chassis		Thermally Fused Laminate Top Thermally Fused Laminate Chassis	
		48 x 24 x 42	140	RAL4842RP164W	1012	RAL4842RP164P	1114	RAL4842RP164G	1012
42 x 24 x 42	130	RAL4242RP164W	900	RAL4242RP164P	990	RAL4242RP164G	900	RAL4242RP164M	889
2 Select a finish <a href="#">View finish details</a>		WAC	WWP	TSTV		GAC	GSLV +10%	MAC	
		WEC		TSMV		GEC	GWL	MEC	
		WOC		TSLV		GOC		MOC	
		WAM				GAM		MGW	
		WCM				GCM		MTW	
		WWM				GWM		MSW	
		WGW				GNW		MWL	
		WBW				GSTV			
		WSW				+10%			
		WNV							
3 Select a edge <a href="#">View edge details</a>									
		Flat	Exposed Plywood	Flat		Flat		Flat	
4 Select hardware <a href="#">View hardware details</a>		Hardware		Hardware		Hardware		Hardware	
		N/A		N/A		N/A		N/A	

## Product features.

- 1 Standard grommet - matches pull finish or specify black TM30, silver TM31

## Options.

### GROMMETS (NON-STANDARD LOCATION)

Provide drawing w/ Grommet Location and Specify Color - \$95 ea.

- Black: TM30-NS
- Silver: TM31-NS

### PLANK MATCH VENEER

- RPMV: Random Walnut Plank Match Veneer (Horizontal Grain with 25%+ Sap) - Add 10%. Clear coat only.

### EXPOSED PLYWOOD EDGE

- WEPB: Exposed Plywood Edge w/ Baltic Birch Veneer - n/c
- Only available with WCF - Clear Coat Finish

# Rail.

Reception  
Reception Desk

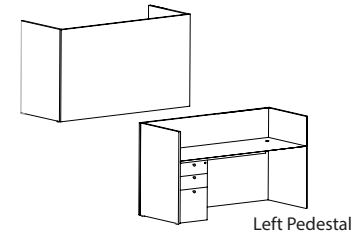

Left Pedestal

[View statement of line](#)

1 Select a model w" x d" x h"	weight	Standard Veneer Top Standard Veneer Chassis		Premium Veneer Top Premium Veneer Chassis		High Pressure Laminate Top Veneer Chassis		Thermally Fused Laminate Top Thermally Fused Laminate Chassis	
		<b>Left Pedestal</b>							
84 x 30 x 42	395	RAL8442RP925W	4933	RAL8442RP925P	5427	RAL8442RP925G	4933	RAL8442RP925M	2188
72 x 30 x 42	350	RAL7242RP925W	4477	RAL7242RP925P	4925	RAL7242RP925G	4477	RAL7242RP925M	2126
66 x 30 x 42	320	RAL6642RP925W	4331	RAL6642RP925P	4765	RAL6642RP925G	4331	RAL6642RP925M	2092
<b>Right Pedestal</b>									
84 x 30 x 42	395	RAL8442RP924W	4933	RAL8442RP924P	5427	RAL8442RP924G	4933	RAL8442RP924M	2188
72 x 30 x 42	350	RAL7242RP924W	4477	RAL7242RP924P	4925	RAL7242RP924G	4477	RAL7242RP924M	2126
66 x 30 x 42	320	RAL6642RP924W	4331	RAL6642RP924P	4765	RAL6642RP924G	4331	RAL6642PP924M	2092
<b>2 Select a finish</b> <a href="#">View finish details</a>		WAC	WWP	TSTV		GAC	GSLV +10%	MAC	
		WEC		TSMV		GEC	GWL	MEC	
		WOC		TSLV		GOC		MOC	
		WAM				GAM		MGW	
		WCM				GCM		MTW	
		WWM				GWM		MSW	
		WGW				GNW		MWL	
		WBW				GSTV	+10%		
		WSW							
		WNV							
<b>3 Select a edge</b> <a href="#">View edge details</a>									
		Flat	Exposed Plywood	Flat		Flat		Flat	
<b>4 Select hardware</b> <a href="#">View hardware details</a>									
		DK-150	Only available on exposed plywood Finger Pull	DK-150		DK-150		DK-150	

## Product features.

- 2 standard grommets - matches pull finish or specify black TM30 or silver TM31
- Full extension drawers - locking
- Soft close suspension drawer(s)
- Optional countertops and façade panel available on following page(s)

## Options.

### ACCESSORIES

- K28: Articulating Keyboard w/ Mouse - \$390
- K31: Center drawer w/o skirt - \$205

### DRAWER

- P6: Modify Box/Box/File to File/File - \$55 per pedestal
- P33: Wood Drawer Upgrade - \$45 per drawer
- WPD3061: Designer White drawer fronts - \$80 per pedestal

### GROMMETS (NON-STANDARD LOCATION)

- Provide drawing w/ Grommet Location and Specify Color - \$95 ea.
- Black: TM30-NS
- Silver: TM31-NS

### PLANK MATCH VENEER

- RPMV: Random Walnut Plank Match Veneer (Horizontal Grain with 25%+ Sap) - Add 10%. Clear coat only.

### EXPOSED PLYWOOD EDGE

- WEPB: Exposed Plywood Edge w/ Baltic Birch Veneer - n/c
- Only available with WCF - Clear Coat Finish

# Rail.

Reception  
Reception Return

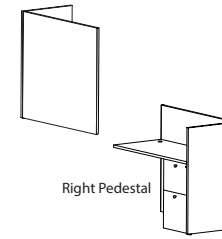

Right Pedestal

[View statement of line](#)

1 Select a model w" x d" x h"	weight	Standard Veneer Top Standard Veneer Chassis		Premium Veneer Top Premium Veneer Chassis		High Pressure Laminate Top Veneer Chassis		Thermally Fused Laminate Top Thermally Fused Laminate Chassis	
		<b>Left Pedestal</b>							
60 x 24 x 42	155	RAL6042RP930W	3005	RAL6042RP930P	3306	RAL6042RP930G	3005	RAL6042RP930M	1575
54 x 24 x 42	145	RAL5442RP930W	2947	RAL5442RP930P	3242	RAL5442RP930G	2947	RAL5442RP930M	1548
48 x 24 x 42	140	RAL4842RP930W	2880	RAL4842RP930P	3168	RAL4842RP930G	2880	RAL4842RP930M	1519
42 x 24 x 42	135	RAL4242RP930W	2824	RAL4242RP930P	3107	RAL4242RP930G	2824	RAL4242RP930M	1490
<b>Right Pedestal</b>									
60 x 24 x 42	155	RAL6042RP931W	3005	RAL6042RP931P	3306	RAL6042RP931G	3005	RAL6042RP931M	1575
54 x 24 x 42	145	RAL5442RP931W	2947	RAL5442RP931P	3242	RAL5442RP931G	2947	RAL5442RP931M	1548
48 x 24 x 42	140	RAL4842RP931W	2880	RAL4842RP931P	3168	RAL4842RP931G	2880	RAL4842RP931M	1519
42 x 24 x 42	135	RAL4242RP931W	2824	RAL4242RP931P	3107	RAL4242RP931G	2824	RAL4242RP931M	1490
<b>2 Select a finish</b> <a href="#">View finish details</a>		WAC WWP		TSTV		GAC GSLV +10%		MAC	
		WEC		TSMV		GEC GWL		MEC	
		WOC		TSLV		GOC		MOC	
		WAM				GAM		MGW	
		WCM				GCM		MTW	
		WWM				GWM		MSW	
		WGW				GNW		MWL	
		WBW				GSTV			
		WSW				+10%			
		WNW							
<b>3 Select a edge</b> <a href="#">View edge details</a>		Flat		Flat		Flat		Flat	
		Exposed Plywood							
<b>4 Select hardware</b> <a href="#">View hardware details</a>		DK-150		DK-150		DK-150		DK-150	
		Only available on exposed plywood Finger Pull							

## Product features.

- 1 Standard grommet - matches pull finish or specify black TM30 or silver TM31
- Finished Back - open plan
- Full extension drawers - locking
- Soft close suspension drawer(s)

## Options.

### ACCESSORIES

- K28: Articulating Keyboard w/ Mouse - \$390
- K31: Center drawer w/o skirt - \$205

### DRAWER

- P6: Modify Box/Box/File to File/File - \$50 per pedestal
- P33: Wood Drawer Upgrade - \$45 per drawer
- WPD3061: Designer White drawer fronts - \$80 per pedestal

### GROMMETS (NON-STANDARD LOCATION)

- Provide drawing w/ Grommet Location and Specify Color - \$95 ea.
- Black: TM30-NS
- Silver: TM31-NS

### PLANK MATCH VENEER

- RPMV: Random Walnut Plank Match Veneer (Horizontal Grain with 25%+ Sap) - Add 10%. Clear coat only.

### EXPOSED PLYWOOD EDGE

- WEPB: Exposed Plywood Edge w/ Baltic Birch Veneer - n/c
- Only available with WCF - Clear Coat Finish

# Rail.

Reception  
Reception Lateral Return

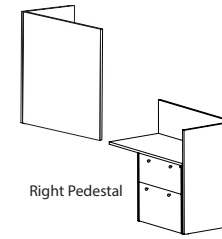

Right Pedestal

[View statement of line](#)

1 Select a model w" x d" x h"	weight	Standard Veneer Top Standard Veneer Chassis		Premium Veneer Top Premium Veneer Chassis		High Pressure Laminate Top Veneer Chassis		Thermally Fused Laminate Top Thermally Fused Laminate Chassis	
		<b>Left Pedestal</b>							
60 x 24 x 42	155	RAL6042RP932W	3403	RAL6042RP932P	3744	"G" Option N/A		RAL6042RP932M	1799
54 x 24 x 42	145	RAL5442RP932W	3342	RAL5442RP932P	3677	"G" Option N/A		RAL5442RP932M	1772
48 x 24 x 42	140	RAL4842RP932W	3274	RAL4842RP932P	3602	"G" Option N/A		RAL4842RP932M	1744
<b>Right Pedestal</b>									
60 x 24 x 42	155	RAL6042RP933W	3403	RAL6042RP933P	3744	"G" Option N/A		RAL6042RP933M	1799
54 x 24 x 42	145	RAL5442RP933W	3342	RAL5442RP933P	3677	"G" Option N/A		RAL5442RP933M	1772
48 x 24 x 42	140	RAL4842RP933W	3274	RAL4842RP933P	3602	"G" Option N/A		RAL4842RP933M	1744
<b>2 Select a finish</b> <a href="#">View finish details</a>		WAC	WWP	TSTV				MAC	
		WEC		TSMV				MEC	
		WOC		TSLV				MOC	
		WAM						MGW	
		WCM						MTW	
		WWM						MSW	
		WGW						MWL	
		WBW							
		WSW							
		WNW							
<b>3 Select a edge</b> <a href="#">View edge details</a>									
		Flat	Exposed Plywood	Flat				Flat	
<b>4 Select hardware</b> <a href="#">View hardware details</a>									
		DK-150	Only available on exposed plywood Finger Pull	DK-150	Only available on exposed plywood Finger Pull			DK-150	

## Product features.

- 1 Standard grommet - matches pull finish or specify black TM30 or silver TM31
- Finished Back - open plan
- Full extension drawers - locking
- Soft close suspension drawer(s)

## Options.

### ACCESSORIES

- K28: Articulating Keyboard w/ Mouse - \$390
- K31: Center drawer w/o skirt - \$205
- K31 N/A on 48" unit

### DRAWER

- P40W: extra Box/Box/File or File/File to Kneespace - \$910 ("W", "G")
- P40M: extra Box/Box/File or File/File to Kneespace - \$720 ("M")
- P33: Wood Drawer Upgrade - \$45 per drawer
- WPD3061: Designer White drawer fronts - \$80 per pedestal

### GROMMETS (NON-STANDARD LOCATION)

- Provide drawing w/ Grommet Location and Specify Color - \$95 ea.
- Black: TM30-NS
  - Silver: TM31-NS

### PLANK MATCH VENEER

- RPMV: Random Walnut Plank Match Veneer (Horizontal Grain with 25%+ Sap) - Add 10%. Clear coat only.

### EXPOSED PLYWOOD EDGE

- WEPB: Exposed Plywood Edge w/ Baltic Birch Veneer - n/c
- Only available with WCF - Clear Coat Finish

Rail options.



COMPUTER SUPPORT  
*single monitor arm*

Style Number	List Price
MA1	280

Specifications

- Available in black or silver
- Desk clamp and mounting included
- Easy assembly and flexibility
- Elastic painting process for a durable and beautiful finish
- Gas spring tension adjustment for counter-balance height adjustment for monitors 1-8 KG
- Gas spring tested to 50,000 repetitions
- Hidden cable management

COMPUTER SUPPORT  
*double monitor arm*

Style Number	List Price
MA2	450

Specifications

- Available in black or silver
- Desk clamp and mounting included
- Easy assembly and flexibility
- Elastic painting process for a durable and beautiful finish
- Gas spring tension adjustment for counter-balance height adjustment for monitors 1-8 KG
- Gas spring tested to 50,000 repetitions
- Hidden cable management

COMPUTER SUPPORT  
*triple monitor arm*

Style Number	List Price
MA3	530

Specifications

- Available in black or silver
- Desk clamp and mounting included
- Easy assembly and flexibility
- Elastic painting process for a durable and beautiful finish
- Gas spring tension adjustment for counter-balance height adjustment for monitors 1-8 KG
- Gas spring tested to 50,000 repetitions
- Hidden cable management

COMPUTER SUPPORT  
*quadruple monitor arm*

Style Number	List Price
MA4	705

Specifications

- Available in black
- Desk clamp and grommet included
- Easy assembly and flexibility
- Elastic painting process for a durable and beautiful finish
- Gas spring tension adjustment for counter-balance height adjustment for monitors 1-8 KG
- Gas spring tested to 50,000 repetitions
- Hidden cable management

## Rail options.

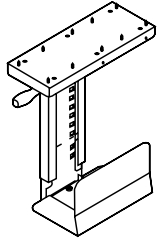

COMPUTER SUPPORT  
*cpu retractable cradle*

Style Number	List Price
K18	205

### Specifications

- Black Metal CPU Carriage
- Full 360° swivel capability allows easy access to rear of CPU for cables / wires
- Track allows 8- 1/2" extension
- Width Adjustment 5-1/2" to 9-1/4"
- Height adjustment 14- 5/8" to 20- 1/2"
- Black epoxy finish

Notes  
- Factory Installed

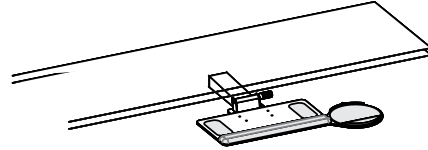

COMPUTER SUPPORT  
*articulating keyboard tray*

Style Number	List Price
Factory Installed K28	395
Field Installed K28F	415

### Specifications

- Adjusts effortlessly - A simple one-handed motion allows the keyboard to be repositioned instantly, without the use of locks or levers
- Encourages low-risk postures - Maximizes adjustability within a safe operating range.
- Will last a lifetime - Exceeds all applicable BIFMA Standards and comes with a lifetime guarantee.

Notes  
- Available on: Freestanding Desk  
- Factory Installed (standard)  
- FIELD INSTALL - \$415



DOOR MODIFICATIONS  
*soft close door hinge*

Style Number	List Price
D9SC	20 Per door

### Specifications

- Snap onto standard door hinge
- Requires (2) per door
- Max door height 43"
- Factory installed where specified
- Individually shipped for field installation

Notes  
- Specify Each Item To Have Slow Close Feature

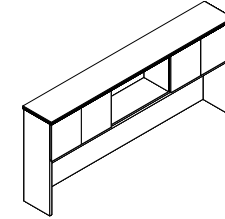

DOOR MODIFICATIONS  
*delete doors*

Style Number	List Price
D6	N/C

### Specifications

- Standard Door overheads and cabinets can have door deleted for open access. Modification of hinge rails and structural components are made face ready.

## Rail options.

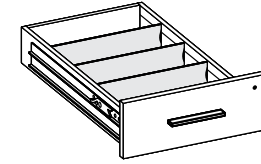
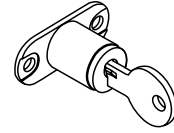
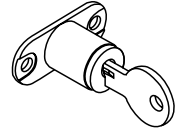
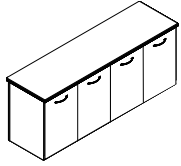

**DOOR MODIFICATIONS**  
*delete doors/replace black laminate shelf w/ finished shelf*

Style Number	List Price
D6A	N/C

### Specifications

- Delete doors and replace black laminate shelf with finished shelf

Notes  
 - Available on: All Storage "W"/"G" Style Credenzas.

**DOOR MODIFICATIONS**  
*panel door lock*

Style Number	List Price
D2	100 Per door set

### Specifications

- Door Locks - 1 Door w/ Lock, Other Door w/ Catch Latch
- Contact Customer Service regarding limited lock locations and keying.

Notes  
 - Available on: Panel Doors, Wood Frame Doors, and Silverluma doors

**DOOR MODIFICATIONS**  
*glass door lock*

Style Number	List Price
D2-G	205 Per door set

### Specifications

- Door Locks - 1 Door w/ Lock, Other Door w/ Catch Latch
- Contact Customer Service regarding limited lock locations and keying.

Notes  
 - Available on: Glass Doors

**DRAWER OPTIONS**  
*box drawer accessories*

Style Number	List Price
Wood Drawer Dividers w/ Clips K-DIV	SET OF 3 - 30
Single Tray - Utility Tray K-Sut	35 ea.

### Specifications

- K-DIV Extra Wood Drawer Dividers with Clips, Top Box drawers standard with 1 divider
- K-SUT Single Tray - Utility Tray, Specify Legal or Letter drawer width

## Rail options.

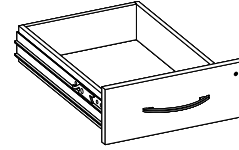
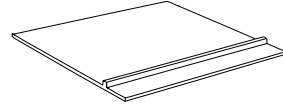
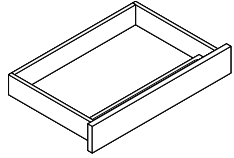

### DRAWER OPTIONS *finished center drawer*

Style Number	List Price
K31	205
Add Skirt Option K31-SK	310

### Specifications

- Veneer drawer front finished to match unit W or G style veneer.
- Ball bearing smooth operation
- Drawer has lifetime guarantee
- Standard with matching wood grain pencil tray
- Laminate drawer front to match laminate unit (M style)

### DRAWER OPTIONS - BOTTOM COVER *felt bottom center drawer insert liner*

Style Number	List Price
K3	100

### Specifications

- Inserts into center drawer and features divider for open pen and pencil storage. Removable for easy cleaning.
- Adds a luxurious touch to center drawers.
- Color: Dark Brown Coal

### DRAWER OPTIONS - UPGRADE *wood drawer upgrade*

Style Number	List Price
P33	45 Per drawer

### Specifications

- Dowel joint construction
- Hardwood veneer multi-ply drawer
- UV finish
- 1/4" Wood veneer bottoms
- File drawer bottoms are five block reinforced for heavy weight capacity
- Lifetime guaranteed

### GLASSBOARD ACCESSORIES *glassboard accessory kit*

Style Number	List Price
GBKIT	290

### Specifications

- 8 Earth magnets, 1 magnetic marker cup holder and 1 magnetic dry eraser



## Rail options.

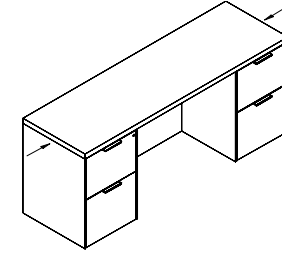
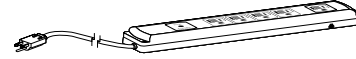
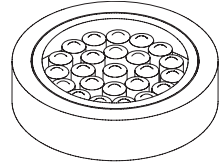

### RECESSED LIGHTING *lt-led task light*

Style Number	List Price
24" Task light LT-LED24R	190
48" Task light LT-LED48R	245
60" Task light LT-LED60R	310
72" Task light LT-LED72R	335

### Specifications

- 6.5' Power cord. Switch with touch dimmer
- 36 LEDs per foot
- 4.6 Watts per foot
- 91 Lumens per watt
- Please note when ganging.
- Overhead tasklight cord is located on the right facing side. If the opposite location is required please contact customer service.

### LIGHTING *led interior cabinet puck light*

Style Number	List Price
Starter Kit LEDPK	310
1 LED Interior Puck Light PK	130

### Specifications

- Starter kit includes Infeed, 1 Puck Interior Light and the ability to daisy chain up to 6 total Puck Lights
- (1) LED Puck Light with 30W power drive and switch
- Recessed fixture
- 12V linking cord 98"L
- Silver finish
- 50,000 hour life
- 2 watt per light

#### Notes

- Available on: Overhead/Tower Units with glass doors or no doors
- Power drive included, Light only

### POWER / DATA *power supply cordset*

Style Number	List Price
PD717	100

### Specifications

- SIZE: 10.75"L x 2.0"W x 1.06"H
- (5) Outlets w/ 10' cord
- Surge suppression (720 Joules)
- 15 Amp breaker
- Available on: Vertical Panels, Cabinet Interiors, and under tops

### PRODUCT MODIFICATIONS *modify width - open kneespace*

Style Number	List Price
MOD-1	125

### Specifications

- Modify width down on any unit with an open kneespace: desk, workstation credenza, bridge, return

## Rail options.

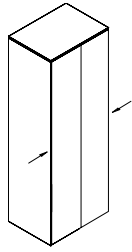

PRODUCT MODIFICATIONS  
*modify width - open/closed storage*

Style Number	List Price
MOD-2	250

### Specifications

- Modify width down on any unit with open or closed storage section: overheads, wall hung units, storage credenzas, towers

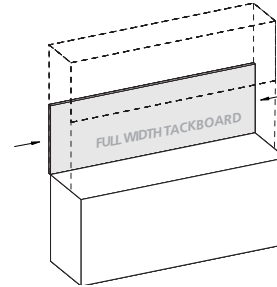

PRODUCT MODIFICATIONS  
*modify width - tackboard, slat wall, veneer panel, or a glassboard*

Style Number	List Price
MOD-4	50

### Specifications

- Modify width down on tackboard, slat wall, veneer panel, or a overhead glassboard

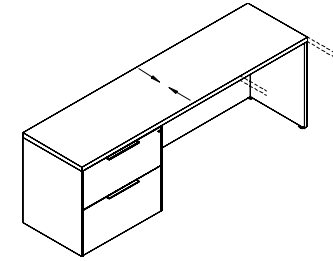

PRODUCT MODIFICATIONS  
*modify depth - decrease depth*

Style Number	List Price
MOD-5	125

### Specifications

- Modify depth down (minimum depth for a unit with drawers is 21" D)

Notes  
 - Ex. 24" to 21", 30" to 24", and 36" to 30"

## Rail options.

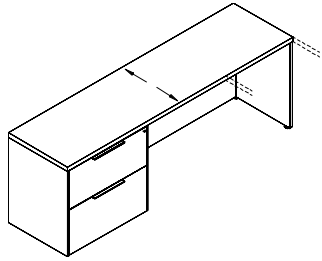

### PRODUCT MODIFICATIONS *modify depth - increase depth*

Style Number	List Price
MOD-6	Add 10%

### Specifications

- Increase depth by no more than 6"

#### Notes

- Ex. 24" to 30", 30" to 36", and 36" to 42"
- Add 10% to the unit you want to increase the depth of by no more than 6"

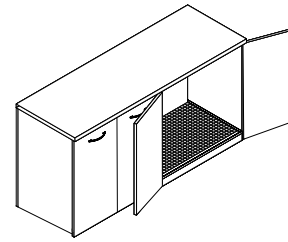

### PRODUCT MODIFICATIONS *modify height*

Style Number	List Price
MOD-7	Contact for pricing

### Specifications

- Modify height of a unit

### REFRIGERATOR MODIFICATION *refrigerator cabinet modification*

Style Number	List Price
REF01	205

### Specifications

- Open back cutout for venting
- Moisture sponge mat
- Contaminate ledge
- Contact customer service for maximum refrigerator size (Changes based on unit).

#### Notes

- Available on: 36" and 42" Storage Credenzas

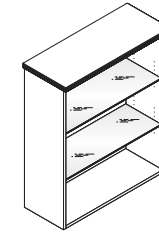

### SHELF MODIFICATIONS *glass shelves - tempered full width 26" - 35"*

Style Number	List Price
26"W - 35"W x 14"D Shelf GS14F	90

### Specifications

- Glass Shelves Replace Wood Shelf In Open Or Glass Door Cabinet. Also Order Interior Cabinet Lighting.

## Rail options.

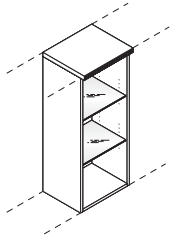

### SHELF MODIFICATIONS *tempered glass shelves for half cabinet 17- 1/2" widths*

Style Number	List Price
14-1/2"W - 17- 1/2"W x 14"D Shelf GS14H	70 ea.

### Specifications

- Glass Shelves Replace Wood Shelf In Open Or Glass Door Cabinet. Also Order Interior Cabinet Lighting.

#### Notes

- Replace only adjustable shelves between cabinet light and fixed lower wood shelf.

### TOOL CHANNEL ACCESSORIES *iphone holder*

Style Number	List Price
ATB31	125

### Specifications

- For Console/Wall Hung Back Panels With Optional Tool Bar  
 - 18 Gauge Steel - Stamp Formed  
 - Silver Powdercoat Finish  
 - 5" x 3 -3/4"W  
 - Non-slip Neoprene pad

### TOOL CHANNEL ACCESSORIES *large shelf*

Style Number	List Price
ATB35	135

### Specifications

- 12"W x 10"D

### TOOL CHANNEL ACCESSORIES *pencil pen holder*

Style Number	List Price
ATB38	120

### Specifications

- For Console/Wall Hung Back Panels With Optional Tool Bar  
 - 18 Gauge Steel - Stamp Formed  
 - Silver Powdercoat Finish  
 - 5"H x 4"W x 4"D

## Rail options.

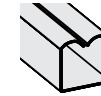
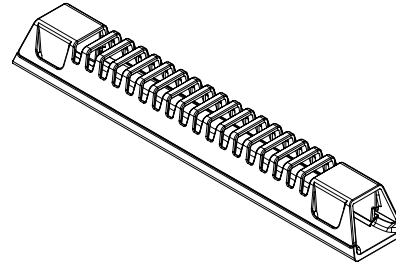
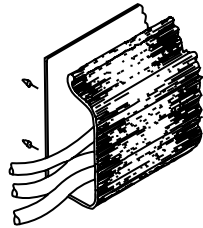

### TOOL CHANNEL ACCESSORIES *tablet holder*

Style Number	List Price
ATB30	145

### Specifications

- For Console/Wall Hung Back Panels With Optional Tool Bar
- 18 Gauge Steel - Stamp Formed
- Silver Powdercoat Finish
- 10" x 8"W
- Non-slip Neoprene pad

### WIRE MANAGEMENT *horizontal j-channel wire management raceway*

Style Number	List Price
W1	80 Per 4' section

### Specifications

- 4' section for field installation.
- The "J" shape black thermoplastic wire raceway may be added to specified worksurface tops to provide concealed channeling of wires to and from worksurface grommets. For use in open kneespace areas, raceway is attachable to top of back panel with pan head screws. Interior dimensions are 1" x 1- 1/2" providing ample storage for multiple wires and excess cable. Front of raceway flexes out for easy cord insertion.

- Notes
- Units w/ Wire Channel Standard.
  - Field Installation

### WIRE MANAGEMENT *horizontal wire management raceway*

Style Number	List Price
W21	35

### Specifications

- 10"W x 1.5"D x 1.25"H
- Grey Wire Manager (10.5")
- Power and data cables can be discretely housed and managed with the W21 Gray Wire Manager. This can be mounted in any location to metal frame or underside of conference tables and runs cables through a 1" channel from power module to hollow steel legs. This keeps cables organized under the table top. Release clips make it simple to snap on and off the Wire Manager for easy organization and access after attached to the table

- Notes
- Field installed

### WIRE MANAGEMENT *horizontal u-channel wire management raceway*

Style Number	List Price
W2A	80 Per 4' section

### Specifications

- 4' section for field installation.
- Notes
- Units w/ Wire Channel Standard.
  - Field Installation

Rail options.

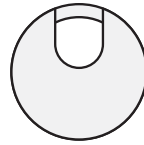
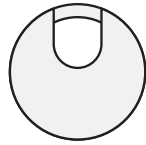

WIRE MANAGEMENT  
*coil wire manager*

Style Number	List Price
W18	160

Specifications

- Weighted Base, Table attachment plate
- 39- 1/2" Length
- Black

- Notes
- Location

WIRE MANAGEMENT  
*standard location grommets - factory installed*

Style Number	List Price
Standard Location Grommet	
Black	
TM30	50
Silver	
TM31	50
Antique Brass	
TM33	50
White	
TM34	50

Specifications

- 1 -5/8" Metal Grommet

- Notes
- \*Units w/ Grommets Standard Are Noted Under Standard Features. Grommets Match Pull Finish - Standard (Unless Specified Otherwise)

WIRE MANAGEMENT  
*non-standard location grommets - factory installed*

Style Number	List Price
Non-Standard Location Grommet	
Black	
TM30 -NS	95
Silver	
TM31 -NS	95
Antique Brass	
TM33 -NS	95
White	
TM34 -NS	95

Specifications

- 1 -5/8" Metal Grommet

- Notes
- \*Units w/ Grommets Standard Are Noted Under Standard Features. Grommets Match Pull Finish - Standard (Unless Specified Otherwise)

WIRE MANAGEMENT  
*black plastic vertical surface grommets - factory installed*

Style Number	List Price
Standard Location Grommet	
TM50-C	50
Non-Standard Location Grommet	
TM50-NS	95

Specifications

- 2 " Black Plastic Grommet

- Notes
- Standard Location is Bottom Center

## power & data options.

Aircharge wireless charging grommet

Style Number

List Price



ACWG WIRELESS GROMMET

\$195

## Specifications

- › When used with GROVE Tables an additional \$350 LIST will apply for the special cutout required.
- › AirCharge offers a convenient way to charge any Qi compatible smartphone or device without the need to carry charging cables or find an available power outlet.
- › The Aircharge is powered by the latest Qi compliant IC offering reliable and efficient wireless charging in a convenient 3" grommet hub. Simply place your phone on the Aircharge and an LED will confirm pairing and begin wireless charging.
- › Recess: Efficient space conservation and quick access
- › Input: DC 5V (with included AC power adapter), DC 9V, 1.67A (with optional QC 2.0 power adapter)
- › Output: 5 watts Max. with DC 5V, 2A power adapter, 10 watts Max. with QC 2.0 power adapter
- › Qi V1.2 compliant IC
- › Charging distance: 6mm Max.

Available: All DARRAN collections



## power & data options.

Cove power unit - non-linking

Style Number	List Price
 PD-COVE PLUG	\$550
Non-linking version	

### Specifications

- › Size 5.75" L x 2.5" W
- › (2) 15 Amp Receptacles and (2) USB charging ports
- › Surface Mount
- › 108" Cord
- › Standard Silver Finish, Available in White or Black Finish upon request
- › ETL Listed

Available: All DARRAN collections





## power & data options.

Cove corded series

Style Number	List Price
 PD-COVE-PKO	\$800

## Specifications

- › Size 9.5" L x 2.5" W x 3.18" D
- › When used with GROVE Tables an additional \$350 LIST will apply for the special cutout required.
- › (2) Power Receptacles, (2) 2.1 Amp USB charging ports and (1) Telecom Plate Knockout
- › Surface Mount
- › 108" Cord
- › Standard Silver Finish, Available in White or Black Finish upon request
- › ETL Listed

Available: All DARRAN collections

### Telecom Plates

RJ45 (1)	\$35
RJ45 (2)	\$70
RJ45 (3)	\$105
USB (1)	\$70
USB (2)	\$140
RJ11/RJ45	\$70
RJ45/USB	\$105
RJ45/HDMI	\$190
HDMI/DVI	\$325
HDMI/USB	\$205
HDMI/VGA	\$240
VGA/MINI-STEREO	\$155
VGA/USB	\$175

This pod can have up to 1 total plates.  
\*All telecom connectors sold separately.



## power & data options.

### Keno power unit

Style Number

List Price



PD-KENO

\$195

Select power block to link workstations

## Specifications

- > Size 5.5" L x 2.125" W x 2.5" H
- > 2 TR AC Outlets
- > 1 4.2A USB module w/ 2 charging ports
- > 10' Power cord

Available: EdgeWorks, NSS Open, Rail, Rail Open Office, ThinkingQuietly

### Telecom Plates

With 120" hardwire power cord.

Two Pack Power Block System: 2PPBS	\$390
Four Pack Power Block System: 4PPBS	\$750
Six Pack Power Block System: 6PPBS	\$1100



White



Black

## power & data options.

Seclusion corded power unit non-linking

Style Number	List Price
--------------	------------



P2SECL	\$245
--------	-------

Choose from plate mount or clamp mount  
(seen in photo)

## Specifications

- > Size: 3.5"L x 2.2"D x 2.5"H
- > (2) Power Receptacles
- > Worksurface Clamp Mount or Plate Under Surface Mount
- > Clamp Accessory accommodates table thickness up to 2"
- > 72" Cord
- > Standard Silver Finish, Black Finish available upon request
- > UL/UCL Listed

Available: All DARRAN collections



Clamp Mount

## power & data options.

Soba wire manager

Style Number	List Price
STARTER UNITS	
SCDW	\$200
White wire manager	
SCDB	\$200
Black wire manager	

## Specifications

- › Dimensions: 9ft x 9in x 3.15in
- › Zips up, bundles and routes loose, messy cables into a single tube
- › Routes and guides cables behind desks, TVs, and anywhere cables tend to get messy
- › Accommodates large or small cables, up to three cables at once
- › Support channels, used to route cables, include powerful adhesive backing which allows easy attachment to surfaces.

Available: All DARRAN collections



## power & data options.

Tully power unit

Style Number	List Price
 PD-TULLY	\$320
Select power block to link workstations	

### Specifications

- › 5.5" W x 3.2" H x 1.81" D
- › Finish: Smooth molded plastic integrated within a single piece cover
- › Mounts to the edge of your work surface, with no table cut outs or installation required.
- › (2) Power receptacles, (2) USB 2.1 Amp ports
- › 72" Cord (10' cord available, contact customer service).
- › Standard in White. Available in gray, black, neon red, harvest pumpkin, light green, daisy blue.
- › UL310, Class 2, FCC Part 15A approved
- › Clamp accessory accomodates table thickness from .75"-1.5"

Available: EdgeWorks, NSS Open, Rail, Rail Open Office, ThinkingQuietly.

#### Power Block

With 120" hardwire power cord.

Two Pack Power Block System: 2PPBS	\$390
Four Pack Power Block System: 4PPBS	\$750
Six Pack Power Block System: 6PPBS	\$1100

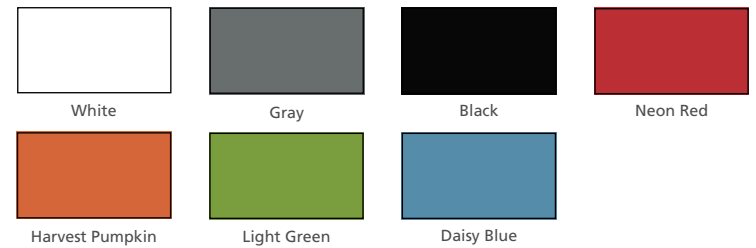

## power & data options.

VILLA Power unit - non-linking

Style Number	List Price
 VIL-C PLUG	\$515
Non-Linking	

## Specifications

- › Size: Top Grommet 5.68" L X 3.39"W; Under Top 12"L x 3.13"W x 3.08"D
- › (2) Power receptacles; (2) USB charging ports and (1) Knockouts for RJ45 Data Ports
- › Surface Mount
- › 72" Cord (Longer cord available, contact Customer Service)
- › Standard Silver Finish, Black Finish available upon request
- › UL or ETL Certified

Available: All DARRAN collections, excludes Grove

RJ45 Knockout	
RJ45 (1)	\$35



# Reception park price list

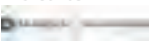

## Reception park table of contents

Statement of Line	
Features & Advantages .....	1
Finishes   Specifications .....	3
Edges   Pulls .....	4
Grommets   Grommet Reference .....	5
Ganging   Height Reference .....	6
Modesty Reference   Grain Direction .....	7
Drawer Dimensions   Filing Reference .....	8
Desk Shells .....	9
Corner Shells .....	10
Reception Workstation Returns .....	11
Bridges .....	13
Counters .....	14
Options .....	19
Power & Data .....	25



# Reception park statement of line

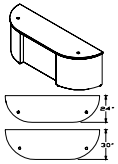

PAGE 9  
Desk Shell

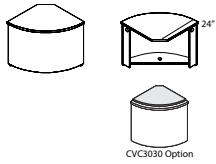

PAGE 10  
Corner Shells

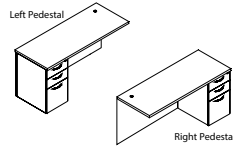

PAGE 11  
Reception Workstation Returns 24" D

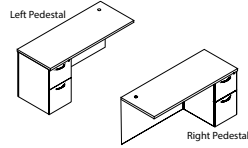

PAGE 12  
Reception Workstation Returns 24" D

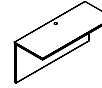

PAGE 13  
Reception "U" Workstation Bridges

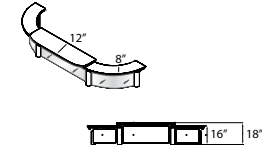

PAGE 14  
Counters

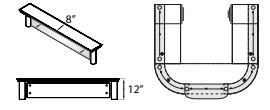

PAGE 15  
Counters

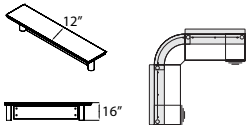

PAGE 16  
Counters



PAGE 17  
Counters

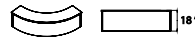

PAGE 18  
Counters

## Reception park features & advantages

### Veneer and HPL tops

Veneer tops and high-pressure laminate tops feature a 45-pound density substrate with balanced 3-ply construction. Tops are 1-5/16" thick. DARRAN only uses HPVA A Grade Flat Cut Cherry, Maple, and Walnut Veneers and A Grade Quartered Oak and Ash Veneers. Cherry and Walnut veneers are book-matched. Oak, Maple, and Ash Veneers are slip-matched. Veneer tops feature a 3mm external solid hardwood band, HPL tops features a 2mm flat PVC band or a 1mm laminate self-edge. Some collections feature double cut reconstituted walnut and oak veneers.

### Chassis & pedestal

All pedestals and chassis are constructed with 3/4" thick balanced 3-ply panels. Panels are securely fastened together using rails that are bored and doweled, glued, metal reinforcement brackets and wood cleat construction. Thick end panels are pre-bored to accept a tee nut for the adjustable glide and are reinforced with pvc banding to prevent glide tear out. Glue blocks are used where 3/4" thick panels are joined, bored for tee nut to accept adjustable glide.

### Overhead cabinet construction

#### Freestanding & wall mount

Freestanding Overhead storage cabinets are constructed of 1" and 3/4" thick balanced 3-ply panels. Panels are attached with cam fasteners in conjunction with dowels securely adhered with PVAc (white polyvinyl acetate) glue. All surface mount cabinets connect to work surface with anti-slip tape. Wall mount cabinets are mounted to the wall with steel "z" bracket attachment method using 5mm euro screws to attach to the back of the cabinet. All units ship with a steel "z" bracket. This bracket is mounted to the wall by field installers. Installers are responsible for selecting and supplying appropriate fasteners for wall conditions.

### Bookcase Construction

All chassis (sides, back, top and bottom panels) are constructed with 3/4" thick balanced 3-ply panels. Panels are attached with cam fasteners in conjunction with dowels securely adhered with PVAc (white polyvinyl acetate) glue. Shelves on all units are 3/4" thick balance 3 ply panels. Optional heavy duty shelves are 1" thick lumber core balanced 5 ply construction.

### Tackboards

Wall mount tackboards are constructed of .75" thick fiberboard. The fabric is precisely aligned and fitted to the tackboard with a sock on cover.

Overhead storage tackboards are constructed of .5" thick fiberboard. The fabric is precisely aligned and fitted to the tackboard and adhered to the rigid hardboard with staples.

### Adjustable glides

Glides provide 1" of vertical leveling adjustment. Glide bottom is durable metal.

### Drawers

All drawers are constructed of four sides and a bottom, which are attached to a drawer front with screws for easy removal. Drawer fronts feature vertically matched veneer within each pedestal. Pencil trays are standard in all box drawers. Jamestown, Prado, Rift, and Spaces feature maple veneer 1/2" thick material for drawer sides, fronts and backs with a UV finish for maximum durability. Drawer bottoms are 7/32" thick 3-ply maple veneer. Drawer boxes are assemble at each corner with dowel joinery for maximum drawer strength. Capitol Park, Central Park, NSsq, Reception Park, and Richmond Park feature drawers that are 1/2" thick wood grained wrapped 5 sided miter-folded construction with 1/8" thick hardboard bottoms.

### Drawer fronts

Drawer fronts are vertically matched in balanced sets. Doors feature vertical veneer bookmatched horizontally in sets of 2 / 4 and 6 doors. All drawers and doors have traditional scallop profile edge shape. All tower fronts matched in vertical sets.

### Optional wood drawers

Optional hardwood veneer plywood drawers feature banded top and bottom edges for smoothness. Drawers are dowel joint construction with a UV cured finish over maple veneers, plus a lifetime free replacement guarantee.

Optional Wood Drawer (Any Size) – Option Code P33...\$40 List Price Per Drawer

### Suspensions

All casegoods utilize cold rolled steel zinc plated high-grade drawer suspensions. All suspensions are warranted for the lifetime of the product. Box and File drawers are full extension, featuring steel ball bearings for a smoother quieter range of motion with soft close operation and are rated 100lbs. Lateral file drawers are a progressive action full extension suspension with the soft close operation and is rated at 150lbs. Lateral files include anti tip mechanism that will allow only one drawer at a time to be opened.

### Hinges

Units with doors include 95 degree swing hinges.

### Filing

Capitol Park, Central Park, NSsq, Reception Park, and Richmond Park feature a highly durable black plastic extrusion that is securely fastened into a route on top of the drawer to support hanging files. An adjustable crossbar is provided for all file drawers that enables legal/letter filing front to back or side-to-side based on the drawer size.

## Reception park features & advantages

Jamestown, Prado, and Rift feature metal file frames around the perimeter of the drawers with cross bars secured to the drawer sides to support hanging files. A metal adjustable cross bar is standard with all file drawers to support letter/legal filing front to back or side to side. File drawers have one adjustable cross bar and lateral files have two adjustable cross bars. See filing reference for details.

### Locks

Silver, black or bronze face locks are standard on all desks, credenzas, returns, and modular pedestals and match the color of the pull selection. Locks are optional on door storage, overhead storage, towers with doors and all door units. Each drawer pedestal is independently locked. Lock plugs are factory or field installed.

#### KEYING

Keying is available either factory or field installed. Factory installed keying is random.

### Wire management

Wire management capabilities include standard and optional worksurface grommets. Specify W-1 under surface wire channels for organization and management of all communication wires and cords. Horizontal J-Channel wire management (Sku: W-1) is sold separately to conceal wire under worksurfaces.

### Grommets

Metal grommets are provided to match the drawer pull selection. Grommet is available in black, silver, white or antique brass. Must specify standard or non-standard location. Black plastic grommets are available as an option for vertical applications.

### Powerports

A large selection of powerports are available and handle power, data, docking stations and communication. See options section for selection.

### LED tasklights

LED task lighting provides high efficiency, low energy lighting with a long life. Recessed light is encased in silver aluminum channel with milk lense and rounded end caps. Lights are factory installed.

Product specifications listed below:

- Diffuser creates a softer light and eliminates hot spots
- Touch dimmer switch
- Can be "daisy chained" up to 90W
- 4.6 watts per foot
- 120 LEDs per meter
- Certification: UL Listed
- 50,000 hour life span.

Size	Voltage	Wattage	Color Temp.
24" light	12Vdc	9.2	4000K
48" light	12Vdc	18.4	4000K
60" light	12Vdc	23	4000K
72" light	12Vdc	27.6	4000K

## Reception park finishes | specifications

STANDARD VENEER	PREMIUM VENEER	HIGH PRESSURE LAMINATE	THERMALLY FUSED LAMINATE
WAC Amber Cherry .....	N/A .....	GAC Amber Cherry .....	N/A
WRC Caramel Cherry .....	N/A .....	N/A .....	N/A
WIC Crimson Cherry .....	N/A .....	GIC Crimson Cherry .....	N/A
WHC Honey Cherry .....	N/A .....	GHC Honey Cherry .....	N/A
WOC KoKo Cherry .....	N/A .....	GOC KoKo Cherry .....	N/A
WAM Alabaster Maple .....	N/A .....	GAM Alabaster Maple .....	N/A
WCM Clear Maple .....	N/A .....	GCM Clear Maple .....	N/A
WWM Wheat Maple .....	N/A .....	GWM Wheat Maple .....	N/A
WEW Executive Walnut .....	N/A .....	GEW Executive Walnut .....	N/A
WGW Gunstock Walnut .....	N/A .....	N/A .....	N/A
WBW Henna Walnut .....	N/A .....	N/A .....	N/A
WNW Natural Walnut .....	N/A .....	GNW Natural Walnut .....	N/A

HPL TOPS ON TFL PRODUCTS Add 10% - Available with flat edge only

Send 3x3 or larger finish chip for color match. Custom finish upcharge is 3% or \$250 Net (whichever is greater).

### Finish

ENVI-CT Green Certified European Technology Coatings

Finish.

## Reception park edges | pulls

### Standard profile

Reception Park Edge  
 Hardwood Rim Band Species Same As Surface Veneer

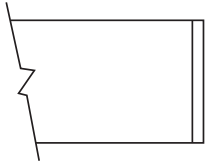

#### Flat

3mm solid  
 hardwood band

### Countertops

Knife Edge - Standard Edge No additional upcharge  
 Flat Edge - Optional Edge - No additional upcharge

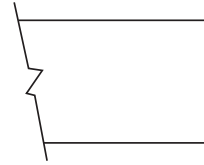

#### Flat

"W" or Solid Surface

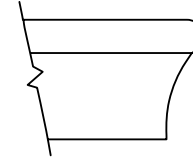

#### Knife

"W" "G"

Transaction counter only

Choice of veneer, laminate or solid surface  
 countertops.

### Pulls

Factory Installed

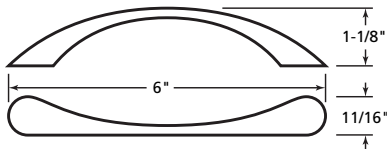

PL-105 Matte Black  
 PL-106 Matte Nickel

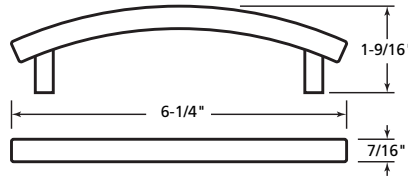

PL-112 Matte Black  
 PL-113 Matte Nickel

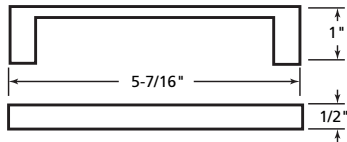

PL-115 Matte Black  
 PL-116 Matte Nickel

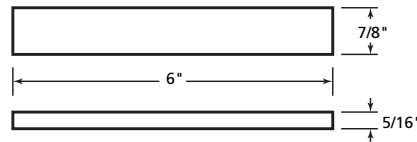

PL-210 Anodized Aluminum

## Reception park grommets | grommet reference

TM30  
Black  
1-5/8" Dia.

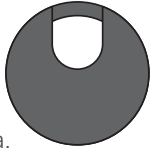

TM31  
Silver  
1-5/8" Dia.

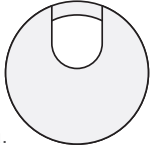

### Optional grommets

Factory Installed

Grommets (Standard Location)

Specify Color and Left/Right/Center - \$50 ea.

- Black: TM30-R (Right), TM30-L (Left), TM30-C (Center)

- Silver: TM31-R (Right), TM31-L (Left), TM31-C (Center)

- Antique Brass: TM33-R (Right), TM33-L (Left), TM33-C (Center)

TM50  
Black  
1-5/8" Dia.



### Grommets (vertical surface)

Standard Location - \$50 ea.

- Black Plastic Vertical Surface: TM50-C (Bottom Center)

Non-Standard Location - \$95 ea.

- Black Plastic Vertical Surface: TM50-NS

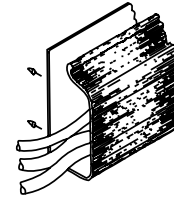

W1

### Horizontal J-channel

Horizontal J-Channel wire management (Sku: W-1) is sold separately to conceal wire under worksurfaces.

## Standard grommet location reference



Bridge  
Center Grommet

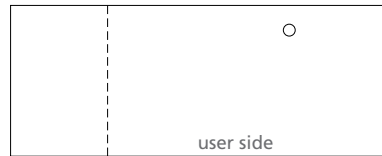

Return (Left Pedestal Shown)  
Right Pedestal - Left Grommet  
Left Pedestal - Right Grommet

Reception park height reference

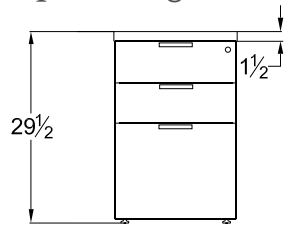

Pedestal Front Profile  
Box/Box/File

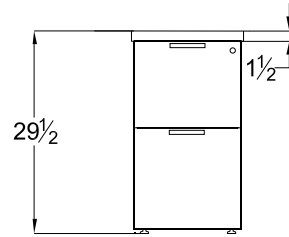

Pedestal Front Profile  
File/File

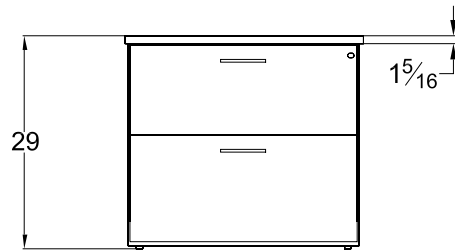

Pedestal Front Profile  
Lateral File

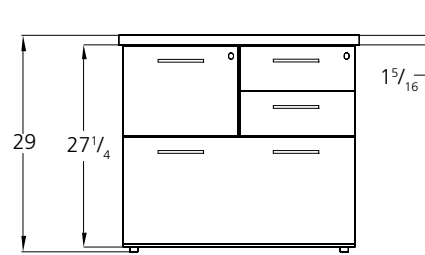

Pedestal Front Profile  
Multi-File

Reception park modesty reference | grain direction

Counter Support Post

3" Diameter, 16 gauge steel post. Bolted through lower worksurface. Tops provide rigid counter mounting. Powder coat finish in matte nickel.

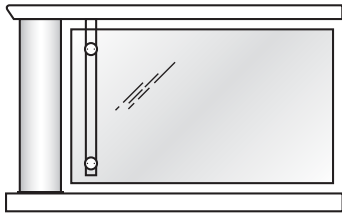

Privacy Screen Detail

Frosted Acrylic panels are suspended between countertops and worksurfaces with matte nickel rods and fasteners. Panels float between support post and surfaces. Panels are curved to match curved surfaces. Edges and corners are rounded.

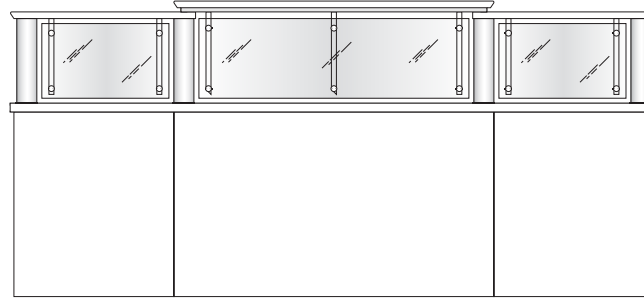

Privacy Screen Detail

Acrylic Screen is fastened to matte nickel rod and sleeve collar with matte nickel screw caps.

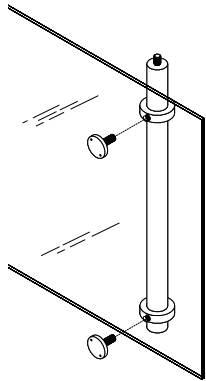

Approach View

1" space provides a floating appearance

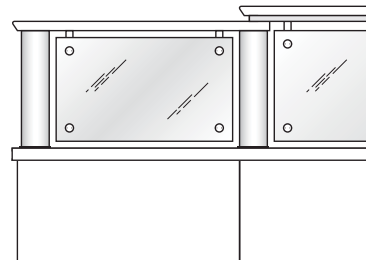

User View

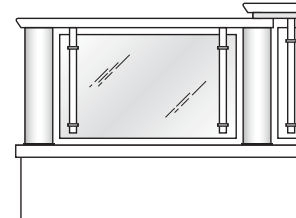

Grain direction

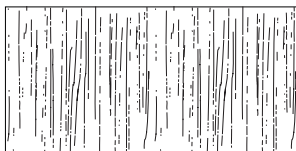

Bridge

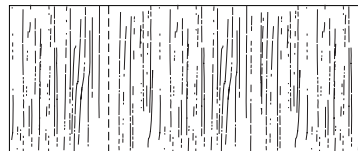

Return



Credenza

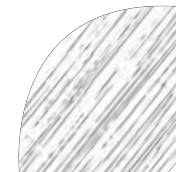

Corner



# Reception park drawer dimensions | filing reference

## Interior Drawer Dimensions

UNIT DEPTH	DRAWER TYPE	OVERALL DIMENSIONS			INTERIOR DRAWER DIMENSIONS		
		W	D	H	W	D	H
15-5/8" Letter	24" Box	13-1/8	16-1/16	4	12-1/8	15-1/16	3-7/16
	24" File	13-1/8	16-1/16	9-13/16	12-1/8	15-1/16	9-5/16
29" Lateral	24" File	26-1/2	16-1/16	9-13/16	25-1/2	15-1/16	9-5/16
35" Lateral	24" File	32-1/2	16-1/16	9-13/16	31-1/2	15-1/16	9-5/16

## Filing reference

### Filing for 24" depth units

13 1/8" Wide File Drawer - 16 1/16" Deep

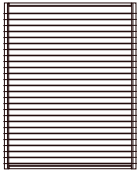

Letter Front to Back

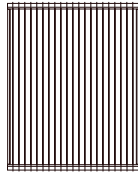

Legal Side to Side with File Rail

### 29" Lateral file drawer

26-1/2" Wide File Drawer - 16-1/16" Deep

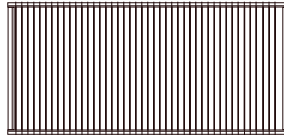

Legal Side to Side

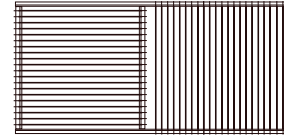

Legal Side to Side  
Letter Front to Back  
with File Rail

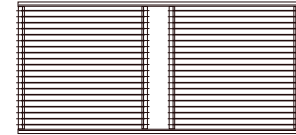

Letter Front to Back  
with File Rail

### 35" LATERAL FILE DRAWER

32-1/2" Wide File Drawer - 16-1/16" Deep

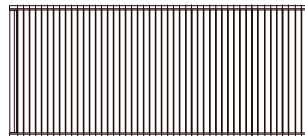

Legal Side to Side

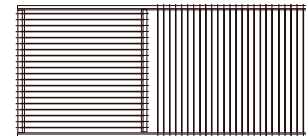

Legal Side to Side  
Letter Front to Back  
with File Rail

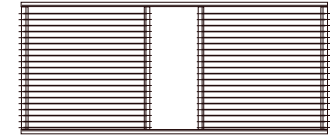



Letter Front to Back  
with File Rail

# Reception park.

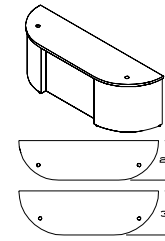
Desk Shell  
Curved Reception Desk



1 Select a model w" x d" x h"	weight	Standard Veneer Top	Premium Veneer Top	High Pressure Laminate Top	Thermally Fused Laminate Top
		Standard Veneer Chassis	Premium Veneer Chassis	Veneer Chassis	Thermally Fused Laminate Chassis
<b>30" Depth</b>			"P" Option N/A	CRP9630DS024G 5425	"M" Option N/A
96 x 30 x 29	250	CRP9630DS024W 5425	"P" Option N/A	CRP9030DS024G 4888	"M" Option N/A
90 x 30 x 29	240	CRP9030DS024W 4888	"P" Option N/A	CRP8430DS024G 4523	"M" Option N/A
84 x 30 x 29	200	CRP8430DS024W 4523	"P" Option N/A	CRP7830DS024G 4266	"M" Option N/A
78 x 30 x 29	190	CRP7830DS024W 4266	"P" Option N/A	CRP7230DS024G 3988	"M" Option N/A
72 x 30 x 29	175	CRP7230DS024W 3988	"P" Option N/A		
<b>24" Depth</b>			"P" Option N/A	CRP9624DS024G 4973	"M" Option N/A
96 x 24 x 29	210	CRP9624DS024W 4973	"P" Option N/A	CRP9024DS024G 4438	"M" Option N/A
90 x 24 x 29	200	CRP9024DS024W 4438	"P" Option N/A	CRP8424DS024G 4015	"M" Option N/A
84 x 24 x 29	170	CRP8424DS024W 4015	"P" Option N/A	CRP7824DS024G 3817	"M" Option N/A
78 x 24 x 29	160	CRP7824DS024W 3817	"P" Option N/A	CRP7224DS024G 3538	"M" Option N/A
72 x 24 x 29	150	CRP7224DS024W 3538	"P" Option N/A		
2 Select a finish <i>View finish details</i>		WAC WGW WRC WBW WIC WSW WHC WNW WOC WEC WAM WCM WWW WEW		GAC GNW GIC GHC GOC GEC GAM GCM GWM GEW	
3 Select an edge <i>View edge details</i>		Flat 	Edge N/A	Flat 	Edge N/A
4 Select hardware <i>View hardware details</i>		Hardware N/A			

*View statement of line*

## Product features.

- 2 Standard grommet - matches pull finish or specify black TM30 or silver TM31
- Storage shelf
- Wire management channels

### NOTES

- "U" Reception Stations require minimum 84" to ensure adequate kneespace area.

## Options.

### ACCESSORIES

- K18: CPU Retractable Cradle - \$205
- K28: Articulating Keyboard w/ Mouse - \$390
- K31: Center Drawer - \$205



### GROMMETS (NON-STANDARD LOCATION)

- Provide drawing w/ Grommet Location and Specify Color - \$95 ea.
- Black: TM30-NS
  - Silver: TM31-NS

# Reception park.

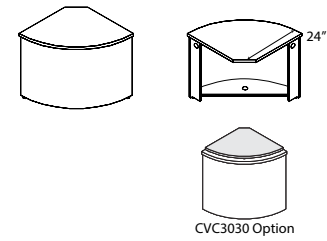
Corner Shells  
Curved "V" Corner



1 Select a model w" x d" x h"	weight	Standard Veneer Top Standard Veneer Chassis		Premium Veneer Top Premium Veneer Chassis		High Pressure Laminate Top Veneer Chassis		Thermally Fused Laminate Top Thermally Fused Laminate Chassis	
		30 x 30 x 29	95	CRP3030CU237W	2051	"P" Option N/A		CRP3030CU237G	2051
2 Select a finish <i>View finish details</i>		WAC	WGW			GAC	GNW		
		WRC	WBW			GIC			
		WIC	WSW			GHC			
		WHC	WNW			GOC			
		WOC				GEC			
		WEC				GAM			
		WAM				GCM			
		WCM				GWM			
		WWW				GEW			
		WEW							
3 Select an edge <i>View edge details</i>				Edge N/A			Flat	Edge N/A	
4 Select hardware <i>View hardware details</i>		Hardware N/A							

[View statement of line](#)

## Product features.

- 1 TM50 Standard grommet in footrest
- Grommet standard in storage shelf for wire access to the floor
- Storage shelf
- Wire management grommets & channels

### NOTES

- For 24"D Return Hookup

## Options.

### GROMMETS (STANDARD LOCATION)

Specify Color and Left/Right/Center - \$50 ea.

- Black: TM30-R (Right), TM30-L (Left), TM30-C (Center)
- Silver: TM31-R (Right), TM31-L (Left), TM31-C (Center)

### GROMMETS (NON-STANDARD LOCATION)

Provide drawing w/ Grommet Location and Specify Color - \$95 ea.

- Black: TM30-NS
- Silver: TM31-NS

### SOLID SURFACE TOP

- Solid Surface: Black pear G10, sea oat quartz G38, white quartz G4
- SS3030: Curved "V" corner accent top - \$1530
- CV3030: "W" veneer "G" HPL curved "V" corner accent top - \$550

# Reception park.

Reception Workstation Returns 24" D  
Return - Box/Box/File

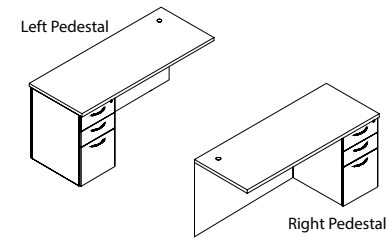

## 1 Select a model w" x d" x h"

weight	Standard Veneer Top		Premium Veneer Top		High Pressure Laminate Top		Thermally Fused Laminate Top	
	Standard Veneer Chassis		Premium Veneer Chassis		Veneer Chassis		Thermally Fused Laminate Chassis	
<b>Left Pedestal</b>								
60 x 24 x 29	175	CRP6024RE207W	2566	"P" Option N/A	CRP6024RE207G	2566	"M" Option N/A	
54 x 24 x 29	165	CRP5424RE207W	2489	"P" Option N/A	CRP5424RE207G	2489	"M" Option N/A	
48 x 24 x 29	155	CRP4824RE207W	2404	"P" Option N/A	CRP4824RE207G	2404	"M" Option N/A	
42 x 24 x 29	145	CRP4224RE207W	2359	"P" Option N/A	CRP4224RE207G	2359	"M" Option N/A	
36 x 24 x 29	135	CRP3624RE207W	2325	"P" Option N/A	CRP3624RE207G	2325	"M" Option N/A	
<b>Right Pedestal</b>								
60 x 24 x 29	175	CRP6024RE209W	2566	"P" Option N/A	CRP6024RE209G	2566	"M" Option N/A	
54 x 24 x 29	165	CRP5424RE209W	2489	"P" Option N/A	CRP5424RE209G	2489	"M" Option N/A	
48 x 24 x 29	155	CRP4824RE209W	2404	"P" Option N/A	CRP4824RE209G	2404	"M" Option N/A	
42 x 24 x 29	145	CRP4224RE209W	2359	"P" Option N/A	CRP4224RE209G	2359	"M" Option N/A	
36 x 24 x 29	135	CRP3624RE209W	2325	"P" Option N/A	CRP3624RE209G	2325	"M" Option N/A	

[View statement of line](#)

## 2 Select a finish [View finish details](#)

- WAC    WGW
- WRC    WBW
- WIC    WSW
- WHC    WNW
- WOC
- WEC
- WAM
- WCM
- WWW
- WEW

- GAC    GNW
- GIC
- GHC
- GOC
- GEC
- GAM
- GCM
- GWM
- GEW

## 3 Select a edge [View edge details](#)



Flat

Edge  
N/A



Flat

Edge  
N/A

## 4 Select hardware [View hardware details](#)



PL-105 Matte Black  
PL-106 Matte Nickel



PL-112 Matte Black  
PL-113 Matte Nickel

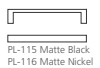

PL-115 Matte Black  
PL-116 Matte Nickel



PL-210 Anodized  
Aluminum

## Product features.

- 1 Standard grommet - matches pull finish or specify black TM30 or silver TM31
- Full extension drawers - locking
- Full fixed modesty
- Soft close suspension drawer(s)
- Wire management channel

### NOTES

- Hinged modesty n/a on reception

## Options.

### ACCESSORIES

- K28: Articulating Keyboard w/ Mouse - \$390
- K18: CPU Retractable Cradle - \$205

### DRAWERS

- P33: Wood Drawer Upgrade - \$45 per drawer
- P40W: extra Box/Box/File or File/File to Kneespace - \$910

### GROMMETS (NON-STANDARD LOCATION)





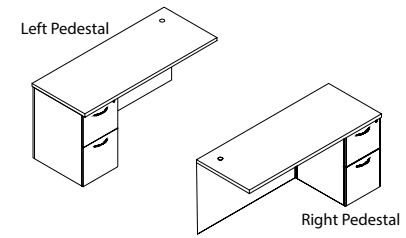

- Provide drawing w/ Grommet Location and Specify Color - \$95 ea.
- Black: TM30-NS
- Silver: TM31-NS

# Reception park.

Reception Workstation Returns 24" D  
Return



[View statement of line](#)

1 Select a model w" x d" x h"	weight	Standard Veneer Top Standard Veneer Chassis		Premium Veneer Top Premium Veneer Chassis		High Pressure Laminate Top Veneer Chassis		Thermally Fused Laminate Top Thermally Fused Laminate Chassis	
		<b>Left Pedestal</b>							
60 x 24 x 29	175	CRP6024RE195W	2566	"P" Option N/A		CRP6024RE195G	2566	"M" Option N/A	
54 x 24 x 29	165	CRP5424RE195W	2489	"P" Option N/A		CRP5424RE195G	2489	"M" Option N/A	
48 x 24 x 29	155	CRP4824RE195W	2404	"P" Option N/A		CRP4824RE195G	2404	"M" Option N/A	
42 x 24 x 29	145	CRP4224RE195W	2359	"P" Option N/A		CRP4224RE195G	2359	"M" Option N/A	
36 x 24 x 29	135	CRP3624RE195W	2325	"P" Option N/A		CRP3624RE195G	2325	"M" Option N/A	
<b>Right Pedestal</b>									
60 x 24 x 29	175	CRP6024RE196W	2566	"P" Option N/A		CRP6024RE196G	2566	"M" Option N/A	
54 x 24 x 29	165	CRP5424RE196W	2489	"P" Option N/A		CRP5424RE196G	2489	"M" Option N/A	
48 x 24 x 29	155	CRP4824RE196W	2404	"P" Option N/A		CRP4824RE196G	2404	"M" Option N/A	
42 x 24 x 29	145	CRP4224RE196W	2359	"P" Option N/A		CRP4224RE196G	2359	"M" Option N/A	
36 x 24 x 29	135	CRP3624RE196W	2325	"P" Option N/A		CRP3624RE196G	2325	"M" Option N/A	
2 Select a finish <a href="#">View finish details</a>		WAC	WGW			GAC	GNW		
		WRC	WBW			GIC			
		WIC	WSW			GHC			
		WHC	WNW			GOC			
		WOC				GEC			
		WEC				GAM			
		WAM				GCM			
		WCM				GWM			
		WWW				GEW			
		WEW							
3 Select a edge <a href="#">View edge details</a>									
		Flat		Edge N/A		Flat		Edge N/A	
4 Select hardware <a href="#">View hardware details</a>									
		PL-105 Matte Black PL-106 Matte Nickel				PL-112 Matte Black PL-113 Matte Nickel			
									
		PL-115 Matte Black PL-116 Matte Nickel				PL-210 Anodized Aluminum			

## Product features.

- 1 Standard grommet - matches pull finish or specify black TM30 or silver TM31
- Full extension drawers - locking
- Full fixed modesty
- Soft close suspension drawer(s)
- Wire management channel

### NOTES

- Hinged modesty n/a on reception

## Options.

### ACCESSORIES

- K28: Articulating Keyboard w/ Mouse - \$390
- K18: CPU Retractable Cradle - \$205

### DRAWERS

- P33: Wood Drawer Upgrade - \$45 per drawer
- P40W: extra Box/Box/File or File/File to Kneespace - \$910

### GROMMETS (NON-STANDARD LOCATION)



- Provide drawing w/ Grommet Location and Specify Color - \$95 ea.
- Black: TM30-NS
- Silver: TM31-NS

# Reception park.

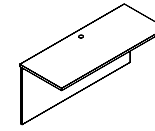
Reception "U" Workstation Bridges  
Bridge



[View statement of line](#)

1 Select a model w" x d" x h"	weight	Standard Veneer Top Standard Veneer Chassis		Premium Veneer Top Premium Veneer Chassis		High Pressure Laminate Top Veneer Chassis		Thermally Fused Laminate Top Thermally Fused Laminate Chassis	
		54 x 24 x 29	100	CRP5424BR150W	887	"P" Option N/A		CRP5424BR150G	887
48 x 24 x 29	90	CRP4824BR150W	815	"P" Option N/A		CRP4824BR150G	815	"M" Option N/A	
42 x 24 x 29	85	CRP4224BR150W	787	"P" Option N/A		CRP4224BR150G	787	"M" Option N/A	
2 Select a finish <a href="#">View finish details</a>		WAC	WGW			GAC	GNW		
		WRC	WBW			GIC			
		WIC	WSW			GHC			
		WHC	WNW			GOC			
		WOC				GEC			
		WEC				GAM			
		WAM				GCM			
		WCM				GWM			
		WWW				GEW			
		WEW							
3 Select an edge <a href="#">View edge details</a>				Edge N/A				Edge N/A	
		Flat				Flat			
4 Select hardware <a href="#">View hardware details</a>		Hardware N/A							

## Product features.

- Full fixed modesty
- 1 Standard grommet - matches pull finish or specify black TM30 or silver TM31

## Options.

### ACCESSORIES

- K28: Articulating Keyboard w/ Mouse - \$390
- K18: CPU Retractable Cradle - \$205

### GROMMETS (NON-STANDARD LOCATION)

- Provide drawing w/ Grommet Location and Specify Color - \$95 ea.
- Black: TM30-NS
  - Silver: TM31-NS

### MODESTY

- M34T: "W" "G" Style Drop Door Tech Modesty - \$130
- M51: Open Back Modesty with Wire Mgmt Rail - Deduct \$100

# Reception park.

Counters

Curved Desk 12" / 18" Counter

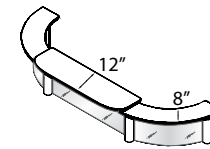

## 1 Select a model w" x d" x h"

	weight	Standard Veneer Top		Premium Veneer Top		High Pressure Laminate Top		Thermally Fused Laminate Top	
		Standard Veneer Chassis		Premium Veneer Chassis		Veneer Chassis		Thermally Fused Laminate Chassis	
<b>For Desk Sizes 24" D :</b>									
96 x 24 x 18	65	CRP9624TC224W	4122	"P" Option N/A		CRP9624TC224G	4122	"M" Option N/A	
90 x 24 x 18	60	CRP9024TC224W	3888	"P" Option N/A		CRP9024TC224G	3888	"M" Option N/A	
84 x 24 x 18	60	CRP8424TC224W	3642	"P" Option N/A		CRP8424TC224G	3642	"M" Option N/A	
78 x 24 x 18	55	CRP7824TC224W	3498	"P" Option N/A		CRP7824TC224G	3498	"M" Option N/A	
72 x 24 x 18	55	CRP7224TC224W	3421	"P" Option N/A		CRP7224TC224G	3421	"M" Option N/A	
<b>For Desk Sizes 30" D :</b>									
96 x 30 x 18	70	CRP9630TC224W	4187	"P" Option N/A		CRP9630TC224G	4187	"M" Option N/A	
90 x 30 x 18	65	CRP9030TC224W	3953	"P" Option N/A		CRP9030TC224G	3953	"M" Option N/A	
84 x 30 x 18	65	CRP8430TC224W	3708	"P" Option N/A		CRP8430TC224G	3708	"M" Option N/A	
78 x 30 x 18	60	CRP7830TC224W	3561	"P" Option N/A		CRP7830TC224G	3561	"M" Option N/A	
72 x 30 x 18	60	CRP7230TC224W	3486	"P" Option N/A		CRP7230TC224G	3486	"M" Option N/A	

[View statement of line](#)

## 2 Select a finish [View finish details](#)

- WAC    WGW
- WRC    WBW
- WIC    WSW
- WHC    WNW
- WOC
- WEC
- WAM
- WCM
- WWW
- WEW

- GAC    GNW
- GIC
- GHC
- GOC
- GEC
- GAM
- GCM
- GWM
- GEW

## 3 Select an edge [View edge details](#)

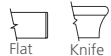

## 4 Select hardware [View hardware details](#)

Hardware  
N/A

## Product features.

- 3" Silver counter posts standard
- Countertop 1-5/16" veneer (Knife edge profile)
- Frosted acrylic privacy screen w/ metal rods & caps

### NOTES

- 4" Overhang To Front
- (4) posts
- Decorative Acrylic Privacy Screen - Contact Customer Service For Quote.
- "U" & "V" Counter Assemblies Cannot Be Mixed.
- Veneer Countertops Can Be Specified In Different Veneer & Finish From Chassis

## Options.

### SOLID SURFACE TOP - FOR DESK SIZES 24" D (FLAT EDGE ONLY)

- Solid Surface: Black Pearl G10, Sea Oat Quartz G38, White Quartz G4
- SS9624: For desk size 96 x 24 - \$2,315
- SS9024: for desk size 90 x 24 - \$2,030
- SS8424: For desk size 84 x 24 - \$1,950
- SS7824: For desk size 78 x 24 - \$1,950
- SS7224: For desk size 72 x 24 - \$1,825

### SOLID SURFACE TOP - FOR DESK SIZES 30" D (FLAT EDGE ONLY)

- Solid Surface: Black Pearl G10, Sea Oat Quartz G38, White Quartz G4
- SS9630: For desk size 96 x 30 - \$2,555
- SS9030: For desk size 90 x 30 - \$2,275
- SS8430: For desk size 84 x 30 - \$2,190
- SS7830: For desk size 78 x 30 - \$2,105
- SS7230: For desk size 72 x 30 - \$2,190

# Reception park.



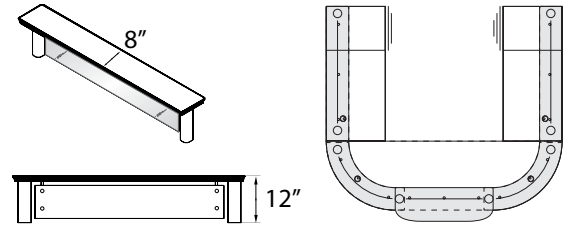

Counters

"L" And "U" Return 8" Counter



DARRAN

[View statement of line](#)

1 Select a model w" x d" x h"	weight	Standard Veneer Top		Premium Veneer Top		High Pressure Laminate Top		Thermally Fused Laminate Top	
		Standard Veneer Chassis		Premium Veneer Chassis		Veneer Chassis		Thermally Fused Laminate Chassis	
<b>Left Return</b>									
72 x 8 x 12	40	CRP7208TC464W	2754	"P" Option N/A		CRP7208TC464G	2754	"M" Option N/A	
66 x 8 x 12	35	CRP6608TC464W	2608	"P" Option N/A		CRP6608TC464G	2608	"M" Option N/A	
60 x 8 x 12	35	CRP6008TC464W	2315	"P" Option N/A		CRP6008TC464G	2315	"M" Option N/A	
54 x 8 x 12	30	CRP5408TC464W	2101	"P" Option N/A		CRP5408TC464G	2101	"M" Option N/A	
48 x 8 x 12	30	CRP4808TC464W	1871	"P" Option N/A		CRP4808TC464G	1871	"M" Option N/A	
42 x 8 x 12	25	CRP4208TC464W	1725	"P" Option N/A		CRP4208TC464G	1725	"M" Option N/A	
36 x 8 x 12	25	CRP3608TC464W	1567	"P" Option N/A		CRP3608TC464G	1567	"M" Option N/A	
<b>Right Return</b>									
72 x 8 x 12	40	CRP7208TC465W	2754	"P" Option N/A		CRP7208TC465G	2754	"M" Option N/A	
66 x 8 x 12	35	CRP6608TC465W	2608	"P" Option N/A		CRP6608TC465G	2608	"M" Option N/A	
60 x 8 x 12	35	CRP6008TC465W	2315	"P" Option N/A		CRP6008TC465G	2315	"M" Option N/A	
54 x 8 x 12	30	CRP5408TC465W	2101	"P" Option N/A		CRP5408TC465G	2101	"M" Option N/A	
48 x 8 x 12	30	CRP4808TC465W	1871	"P" Option N/A		CRP4808TC465G	1871	"M" Option N/A	
42 x 8 x 12	25	CRP4208TC465W	1725	"P" Option N/A		CRP4208TC465G	1725	"M" Option N/A	
36 x 8 x 12	25	CRP3608TC465W	1567	"P" Option N/A		CRP3608TC465G	1567	"M" Option N/A	
<b>2 Select a finish</b> <a href="#">View finish details</a>		WAC	WGW			GAC	GNW		
		WRC	WBW			GIC			
		WIC	WSW			GHC			
		WHC	WNW			GOC			
		WOC				GEC			
		WEC				GAM			
		WAM				GCM			
		WCM				GWM			
		WWW				GEW			
		WEW							
<b>3 Select a edge</b> <a href="#">View edge details</a>									
		Flat	Knife			Flat	Knife		
<b>4 Select hardware</b> <a href="#">View hardware details</a>		Hardware	N/A						

## Product features.

- 3" Silver counter posts standard
- Countertop 1-5/16" veneer (Knife edge profile)
- Frosted acrylic privacy screen w/ metal rods & caps

### NOTES

- 8" Counter Is Flush To Outside Edge of Return
- (3) posts for 72"-60" W counters, (2) posts for 54"-36" W counters
- Decorative Acrylic Privacy Screen - Contact Customer Service For Quote.
- "L" Return counter can only be used with TC224 SKUs
- Veneer Countertops Can Be Specified In Different Veneer & Finish From Chassis

## Options.

### SOLID SURFACE TOP (FLAT EDGE ONLY)

- Solid Surface: Black Pearl G10, Sea Oat Quartz G38, White Quartz G4
- SS7208: For return size 72 x 08 - \$1,015
- SS6608: For return size 66 x 08 - \$1,015
- SS6008: For return size 60 x 08 - \$875
- SS5408: For return size 54 x 08 - \$730
- SS4808: For return size 48 x 08 - \$730
- SS4208: For return size 42 x 08 - \$650
- SS3608: For return size 36 x 08 - \$510





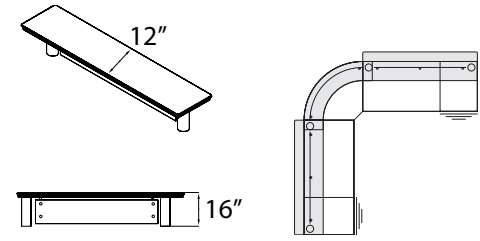

# Reception park.

Counters  
"V" Return 12" Counter



[View statement of line](#)

1 Select a model w" x d" x h"	weight	Standard Veneer Top Standard Veneer Chassis		Premium Veneer Top Premium Veneer Chassis		High Pressure Laminate Top Veneer Chassis		Thermally Fused Laminate Top Thermally Fused Laminate Chassis	
		<b>Left Return</b>							
72 x 12 x 16	50	CRP7212TC467W	2901	"P" Option N/A		CRP7212TC467G	2901	"M" Option N/A	
66 x 12 x 16	45	CRP6612TC467W	2754	"P" Option N/A		CRP6612TC467G	2754	"M" Option N/A	
60 x 12 x 16	45	CRP6012TC467W	2461	"P" Option N/A		CRP6012TC467G	2461	"M" Option N/A	
54 x 12 x 16	40	CRP5412TC467W	2244	"P" Option N/A		CRP5412TC467G	2244	"M" Option N/A	
48 x 12 x 16	30	CRP4812TC467W	2017	"P" Option N/A		CRP4812TC467G	2017	"M" Option N/A	
42 x 12 x 16	30	CRP4212TC467W	1871	"P" Option N/A		CRP4212TC467G	1871	"M" Option N/A	
36 x 12 x 16	25	CRP3612TC467W	1725	"P" Option N/A		CRP3612TC467G	1725	"M" Option N/A	
<b>Right Return</b>									
72 x 12 x 16	50	CRP7212TC468W	2901	"P" Option N/A		CRP7212TC468G	2901	"M" Option N/A	
66 x 12 x 16	45	CRP6612TC468W	2754	"P" Option N/A		CRP6612TC468G	2754	"M" Option N/A	
60 x 12 x 16	45	CRP6012TC468W	2461	"P" Option N/A		CRP6012TC468G	2461	"M" Option N/A	
54 x 12 x 16	40	CRP5412TC468W	2244	"P" Option N/A		CRP5412TC468G	2244	"M" Option N/A	
48 x 12 x 16	30	CRP4812TC468W	2017	"P" Option N/A		CRP4812TC468G	2017	"M" Option N/A	
42 x 12 x 16	30	CRP4212TC468W	1871	"P" Option N/A		CRP4212TC468G	1871	"M" Option N/A	
36 x 12 x 16	25	CRP3612TC468W	1725	"P" Option N/A		CRP3612TC468G	1725	"M" Option N/A	
2 Select a finish <a href="#">View finish details</a>		WAC	WGW			GAC	GNW		
		WRC	WBW			GIC			
		WIC	WSW			GHC			
		WHC	WNW			GOC			
		WOC				GEC			
		WEC				GAM			
		WAM				GCM			
		WCM				GWM			
		WWW				GEW			
		WEW							
3 Select an edge <a href="#">View edge details</a>									
		Flat	Knife			Flat	Knife		
4 Select hardware <a href="#">View hardware details</a>		Hardware	N/A						

## Product features.

- 3" Silver counter posts standard
- Countertop 1-5/16" veneer (Knife edge profile)
- Frosted acrylic privacy screen w/ metal rods & caps

### NOTES

- (2 or 3) posts
- Decorative Acrylic Privacy Screen - Contact Customer Service For Quote.
- "U" & "V" Counter Assemblies Cannot Be Mixed.
- Veneer Countertops Can Be Specified In Different Veneer & Finish From Chassis

## Options.

### SOLID SURFACE TOP

- Solid Surface: Black Pearl G10, Sea Oat Quartz G38, White Quartz G4
- SS7212: For return size 72 x 12 - \$1,015
- SS6612: For return size 66 x 12 - \$1,015
- SS6012: For return size 60 x 12 - \$875
- SS5412: For return size 54 x 12 - \$730
- SS4812: For return size 48 x 12 - \$730
- SS4212: For return size 42 x 12 - \$650
- SS3612: For return size 36 x 12 - \$510

# Reception park.

Counters  
"V" Bridge Corner Counter



1 Select a model w" x d" x h"	weight	Veneer Veneer Top	Veneer Chassis	High Pressure Laminate Top Veneer Chassis	Thermally Fused Laminate Top
30 x 30 x 18	15	CRP3030TC471W 936	"P" Option N/A	CRP3030TC471G 936	"M" Option N/A
2 Select a finish <i>View finish details</i>		WAC WGW WRC WBW WIC WSW WHC WNW WOC WEC WAM WCM WWW WEW		GAC GNW GIC GHC GOC GEC GAM GCM GWM GEW	
3 Select an edge <i>View edge details</i>		Flat  Knife		Flat  Knife	
4 Select hardware <i>View hardware details</i>		Hardware N/A		Hardware N/A	

[View statement of line](#)

## Product features.

- Countertop 1-5/16" veneer (Knife edge profile)
- Frosted acrylic privacy screen w/ metal rods & caps

### NOTES

- 8" Wide Counter
- Decorative Acrylic Privacy Screen - Contact Customer Service For Quote.
- "U" & "V" Counter Assemblies Cannot Be Mixed.
- "V" Bridge corner counter can only be used with TC467 and TC468 SKUs
- Veneer Countertops Can Be Specified In Different Veneer & Finish From Chassis

## Options.

### SOLID SURFACE TOP (FLAT EDGE ONLY)

- Solid Surface: Black Pearl G10, Sea Oat Quartz G38, White Quartz G4
- SS3030: For bridge size 30 x 30 - \$780

# Reception park.

Counters

18" "V" Corner Counter Shell

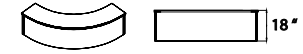

1 Select a model w" x d" x h"	weight	Veneer		Veneer Chassis	High Pressure Laminate Top Veneer Chassis	Thermally Fused Laminate Top
		Veneer Top				
30 x 30 x 18	60	CRP3030TC472W	1182	"P" Option N/A	CRP3030TC472G 1182	"M" Option N/A
2 Select a finish <i>View finish details</i>		WAC	WGW		GAC	GNW
		WRC	WBW		GIC	
		WIC	WSW		GHC	
		WHC	WNW		GOC	
		WOC			GEC	
		WEC			GAM	
		WAM			GCM	
		WCM			GWM	
		WWW			GEW	
		WEW				
3 Select a edge <i>View edge details</i>						
		Flat	Knife		Flat	Knife
4 Select hardware <i>View hardware details</i>		Hardware			Hardware	
		N/A			N/A	

[View statement of line](#)

## Product features.

- 3/4" Curved Wood Back Panel
- Countertop 1-5/16" veneer (Knife edge profile)

### NOTES

- 3/4" Thick Counter Shell Back Is Suitable For Signage Application
- "U" & "V" Counter Assemblies Cannot Be Mixed.
- Veneer Countertops Can Be Specified In Different Veneer & Finish From Chassis

## Options.

### SOLID SURFACE TOP (FLAT EDGE ONLY)

- Solid Surface: Black Pearl G10, Sea Oat Quartz G38, White Quartz G4
- SS3030: For corner size 30 x 30 - \$780

Reception park options.



COMPUTER SUPPORT  
*single monitor arm*

Style Number	List Price
MA1	280

Specifications

- Available in black or silver
- Desk clamp and mounting included
- Easy assembly and flexibility
- Elastic painting process for a durable and beautiful finish
- Gas spring tension adjustment for counter-balance height adjustment for monitors 1-8 KG
- Gas spring tested to 50,000 repetitions
- Hidden cable management

COMPUTER SUPPORT  
*double monitor arm*

Style Number	List Price
MA2	450

Specifications

- Available in black or silver
- Desk clamp and mounting included
- Easy assembly and flexibility
- Elastic painting process for a durable and beautiful finish
- Gas spring tension adjustment for counter-balance height adjustment for monitors 1-8 KG
- Gas spring tested to 50,000 repetitions
- Hidden cable management

COMPUTER SUPPORT  
*triple monitor arm*

Style Number	List Price
MA3	530

Specifications

- Available in black or silver
- Desk clamp and mounting included
- Easy assembly and flexibility
- Elastic painting process for a durable and beautiful finish
- Gas spring tension adjustment for counter-balance height adjustment for monitors 1-8 KG
- Gas spring tested to 50,000 repetitions
- Hidden cable management

COMPUTER SUPPORT  
*quadruple monitor arm*

Style Number	List Price
MA4	705

Specifications

- Available in black
- Desk clamp and mounting included
- Easy assembly and flexibility
- Elastic painting process for a durable and beautiful finish
- Gas spring tension adjustment for counter-balance height adjustment for monitors 1-8 KG
- Gas spring tested to 50,000 repetitions
- Hidden cable management

## Reception park options.

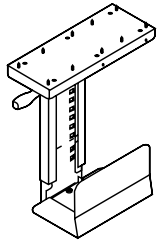

COMPUTER SUPPORT  
*cpu retractable cradle*

Style Number	List Price
K18	205

### Specifications

- Black Metal CPU Carriage
- Full 360° swivel capability allows easy access to rear of CPU for cables / wires
- Track allows 8- 1/2" extension
- Width Adjustment 5-1/2" to 9-1/4"
- Height adjustment 14- 5/8" to 20- 1/2"
- Black epoxy finish

- Notes
- Factory Installed

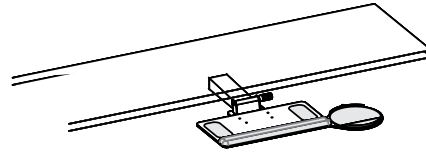

COMPUTER SUPPORT  
*articulating keyboard tray*

Style Number	List Price
Factory Installed	
K28	390
Field Installed	
K28F	415

### Specifications

- Adjusts effortlessly - A simple one-handed motion allows the keyboard to be repositioned instantly, without the use of locks or levers
- Encourages low-risk postures - Maximizes adjustability within a safe operating range.
- Will last a lifetime - Exceeds all applicable BIFMA Standards and comes with a lifetime guarantee.

- Notes
- Available on: Freestanding Desk
  - Factory Installed (standard)
  - FIELD INSTALL - \$395

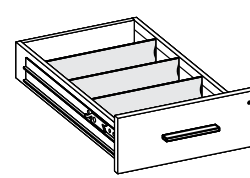

DRAWER OPTIONS  
*box drawer accessories*

Style Number	List Price
Wood Drawer Dividers w/ Clips	
K-DIV	SET OF 3 - 30
Single Tray - Utility Tray	
K-Sut	35 ea.

### Specifications

- K-DIV Extra Wood Drawer Dividers with Clips, Top Box drawers standard with 1 divider
- K-SUT Single Tray - Utility Tray, Specify Legal or Letter drawer width

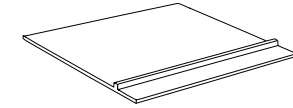

DRAWER OPTIONS - BOTTOM COVER  
*felt bottom center drawer insert liner*

Style Number	List Price
K3	100

### Specifications

- Inserts into center drawer and features divider for open pen and pencil storage. Removable for easy cleaning.
- Adds a luxurious touch to center drawers.
- Color: Dark Brown Coal

## Reception park options.

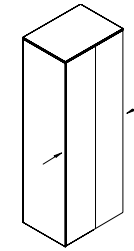
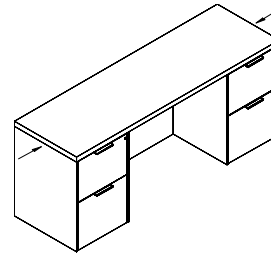
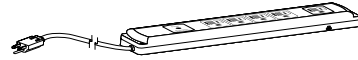
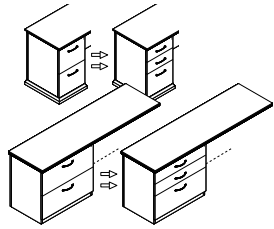

### PEDESTAL MODIFICATIONS *modify drawer configurations*

Style Number	List Price
File/File to Box/Box/File P6	55 Per ped
Box/Box/File to File/File P6	55 Per ped
Lateral File to 2 Box Drawers P8	100 Per ped

### Specifications

- Modify File/File To Box/Box/File - Any Unit

### POWER / DATA *power supply cordset*

Style Number	List Price
PD717	95

### Specifications

- SIZE: 10.75 "L x 2.0 "W x 1.06 "H
- (5) Outlets w/ 10' cord
- Surge suppression (720 Joules)
- 15 Amp breaker
- Available on: Vertical Panels, Cabinet Interiors, and under tops

### PRODUCT MODIFICATIONS *modify width - open kneespace*

Style Number	List Price
MOD-1	125

### Specifications

- Modify width down on any unit with an open kneespace: desk, workstation credenza, bridge, return

### PRODUCT MODIFICATIONS *modify width - open/closed storage*

Style Number	List Price
MOD-2	250

### Specifications

- Modify width down on any unit with open or closed storage section: overheads, wall hung units, storage credenzas, towers

## Reception park options.

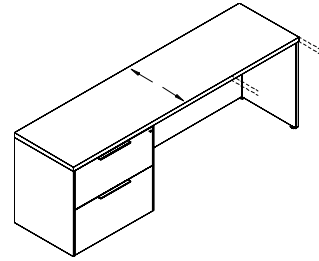
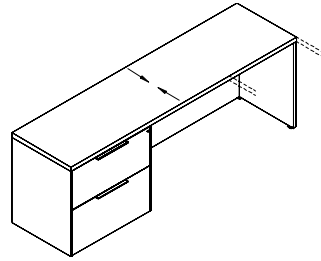

### PRODUCT MODIFICATIONS

*modify width - outside of mod-1, mod-2*

Style Number	List Price
MOD-3	Contact for pricing

### Specifications

- Width modification outside of MOD-1 & MOD-2

### PRODUCT MODIFICATIONS

*modify depth - decrease depth*

Style Number	List Price
MOD-5	125

### Specifications

- Modify depth down (minimum depth for a unit with drawers is 21"D)

Notes  
- Ex. 24" to 21", 30" to 24", and 36" to 30"

### PRODUCT MODIFICATIONS

*modify depth - increase depth*

Style Number	List Price
MOD-6	Add 10%

### Specifications

- Increase depth by no more than 6"

Notes  
- Ex. 24" to 30", 30" to 36", and 36" to 42"  
- Add 10% to the unit you want to increase the depth of by no more than 6"

### PRODUCT MODIFICATIONS

*modify height*

Style Number	List Price
MOD-7	Contact for pricing

### Specifications

- Modify height of a unit

## Reception park options.

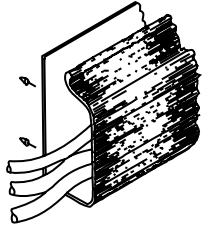

WIRE MANAGEMENT  
*horizontal j-channel wire management raceway*

Style Number	List Price
W1	80 Per 4' section

### Specifications

- 4' section for field installation.
- The "J" shape black thermoplastic wire raceway may be added to specified worksurface tops to provide concealed channeling of wires to and from worksurface grommets. For use in open kneespace areas, raceway is attachable to top of back panel with pan head screws. Interior dimensions are 1" x 1- 1/2" providing ample storage for multiple wires and excess cable. Front of raceway flexes out for easy cord insertion.

Notes

- Units w/ Wire Channel Standard.
- Field Installation

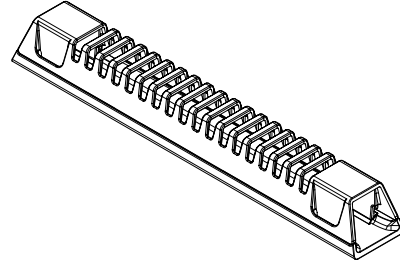

WIRE MANAGEMENT  
*horizontal wire management raceway*

Style Number	List Price
W21	35

### Specifications

- 10"W x 1.5"D x 1.25"H
- Grey Wire Manager (10.5")
- Power and data cables can be discretely housed and managed with the W21 Gray Wire Manager. This can be mounted in any location to metal frame or underside of conference tables and runs cables through a 1" channel from power module to hollow steel legs. This keeps cables organized under the table top. Release clips make it simple to snap on and off the Wire Manager for easy organization and access after attached to the table

Notes

- Field installed

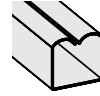

WIRE MANAGEMENT  
*horizontal u-channel wire management raceway*

Style Number	List Price
W2A	80 Per 4' section

### Specifications

- 4' section for field installation.

Notes

- Units w/ Wire Channel Standard.
- Field Installation



WIRE MANAGEMENT  
*coil wire manager*

Style Number	List Price
W18	160

### Specifications

- Weighted Base, Table attachment plate
- 39- 1/2" Length
- Black

Notes

- Location



## Reception park options.

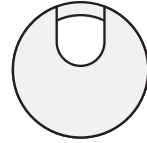
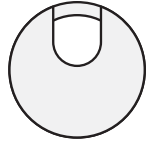

### WIRE MANAGEMENT

*standard location grommets - factory installed*

Style Number	List Price
Standard Location Grommet	
Black	
TM30	50
Silver	
TM31	50
Antique Brass	
TM33	50

### Specifications

- 1 -5/8" Metal Grommet

#### Notes

- \*Units w/ Grommets Standard Are Noted Under Standard Features. Grommets Match Pull Finish - Standard (Unless Specified Otherwise)

### WIRE MANAGEMENT

*non-standard location grommets - factory installed*

Style Number	List Price
Non-Standard Location Grommet	
Black	
TM30 -NS	95
Silver	
TM31 -NS	95
Antique Brass	
TM33 -NS	95

### Specifications

- 1 -5/8" Metal Grommet

#### Notes

- \*Units w/ Grommets Standard Are Noted Under Standard Features. Grommets Match Pull Finish - Standard (Unless Specified Otherwise)

### WIRE MANAGEMENT

*black plastic vertical surface grommets - factory installed*

Style Number	List Price
Standard Location Grommet	
TM50-C	50
Non-Standard Location Grommet	
TM50-NS	95

### Specifications

- 2 " Black Plastic Grommet

#### Notes

- Standard Location is Bottom Center

## power & data options.

Aircharge wireless charging grommet

Style Number	List Price
 ACWG WIRELESS GROMMET	\$195

## Specifications

- › When used with GROVE Tables an additional \$350 LIST will apply for the special cutout required.
- › AirCharge offers a convenient way to charge any Qi compatible smartphone or device without the need to carry charging cables or find an available power outlet.
- › The Aircharge is powered by the latest Qi compliant IC offering reliable and efficient wireless charging in a convenient 3" grommet hub. Simply place your phone on the Aircharge and an LED will confirm pairing and begin wireless charging.
- › Recess: Efficient space conservation and quick access
- › Input: DC 5V (with included AC power adapter), DC 9V, 1.67A (with optional QC 2.0 power adapter)
- › Output: 5 watts Max. with DC 5V, 2A power adapter, 10 watts Max. with QC 2.0 power adapter
- › Qi V1.2 compliant IC
- › Charging distance: 6mm Max.

Available: All DARRAN collections



## power & data options.

Cove power unit - non-linking

Style Number

List Price



PD-COVE PLUG

\$550

Non-linking version

## Specifications

- › Size 5.75" L x 2.5" W
- › (2) 15 Amp Receptacles and (2) USB charging ports
- › Surface Mount
- › 108" Cord
- › Standard Silver Finish, Available in White or Black Finish upon request
- › ETL Listed

Available: All DARRAN collections



## power & data options.

Cove corded series

Style Number	List Price
 PD-COVE-PKO	\$800

## Specifications

- › Size 9.5" L x 2.5" W x 3.18" D
- › When used with GROVE Tables an additional \$350 LIST will apply for the special cutout required.
- › (2) Power Receptacles, (2) 2.1 Amp USB charging ports and (1) Telecom Plate Knockout
- › Surface Mount
- › 108" Cord
- › Standard Silver Finish, Available in White or Black Finish upon request
- › ETL Listed

Available: All DARRAN collections

### Telecom Plates

RJ45 (1)	\$35
RJ45 (2)	\$70
RJ45 (3)	\$105
USB (1)	\$70
USB (2)	\$140
RJ11/RJ45	\$70
RJ45/USB	\$105
RJ45/HDMI	\$190
HDMI/DVI	\$325
HDMI/USB	\$205
HDMI/VGA	\$240
VGA/MINI-STEREO	\$155
VGA/USB	\$175

This pod can have up to 1 total plates.  
 \*All telecom connectors sold separately.



## power & data options.

Soba wire manager

Style Number	List Price
STARTER UNITS	
SCDW	\$200
White wire manager	
SCDB	\$200
Black wire manager	

## Specifications

- › Dimensions: 9ft x 9in x 3.15in
- › Zips up, bundles and routes loose, messy cables into a single tube
- › Routes and guides cables behind desks, TVs, and anywhere cables tend to get messy
- › Accommodates large or small cables, up to three cables at once
- › Support channels, used to route cables, include powerful adhesive backing which allows easy attachment to surfaces.

Available: All DARRAN collections



## power & data options.

VILLA Power unit - non-linking

Style Number	List Price
 VIL-C PLUG	\$515
Non-Linking	

## Specifications

- › Size: Top Grommet 5.68" L X 3.39" W; Under Top 12" L x 3.13" W x 3.08" D
- › (2) Power receptacles; (2) USB charging ports and (1) Knockouts for RJ45 Data Ports
- › Surface Mount
- › 72" Cord (Longer cord available, contact Customer Service)
- › Standard Silver Finish, Black Finish available upon request
- › UL or ETL Certified

Available: All DARRAN collections, excludes Grove

RJ45 Knockout	
RJ45 (1)	\$35

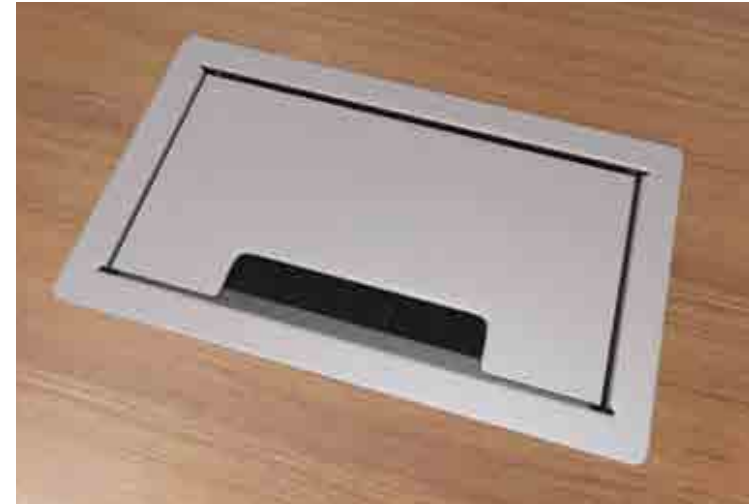

# Richmond park price list



# Richmond park price list revisions

Date Page

Modification

Description





## Richmond park table of contents

Statement of Line	
Features & Advantages .....	1
Finishes   Specifications .....	3
Edges   Pulls   Knobs.....	4
Grommets   Grommet Reference.....	5
Ganging   Height Reference .....	6
Modesty Reference   Grain Direction .....	7
Drawer Dimensions   Filing Reference.....	8
Double Pedestal Desk.....	9
Single Pedestal Desk .....	12
Workstation Desk .....	14
Returns.....	15
Bridges .....	17
Freestanding Credenzas .....	18
Workstation Credenzas.....	23
Single Height Freestanding Overheads .....	25
Overhead Accessories .....	26
Single Height Wall Hung Overheads.....	30
Wall Hung Accessories .....	31
Overhead Bookcases .....	36
Vertical Half Towers.....	38
Vertical Full Towers.....	40
Bookcases.....	42
Options.....	43
Power & Data .....	57

# Richmond park statement of line

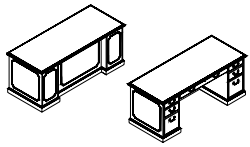

PAGE 9  
Double Pedestal Desks

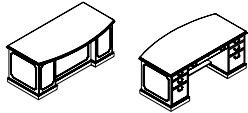

PAGE 10  
Double Pedestal Desks

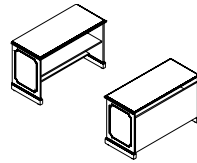

PAGE 11  
Desks

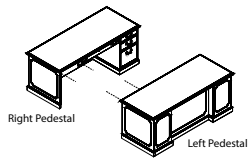

PAGE 12  
Workstation Desks

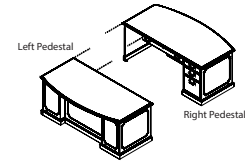

PAGE 13  
Workstation Desks

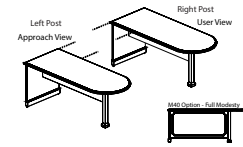

PAGE 14  
Workstation Desks

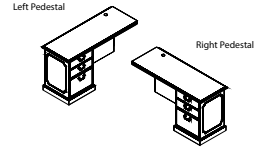

PAGE 15  
Workstation Returns

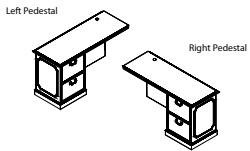

PAGE 16  
Workstation Returns

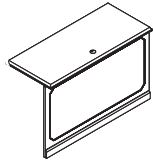

PAGE 17  
Workstation Units

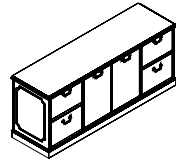

PAGE 18  
Credenzas / Files

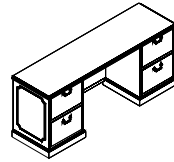

PAGE 19  
Credenzas / Files

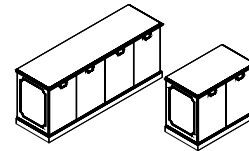

PAGE 20  
Credenzas / Files



PAGE 21  
Lateral File Credenzas



PAGE 22  
Credenzas / Files

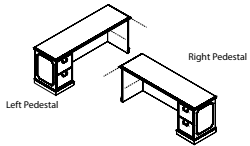

PAGE 23  
Workstation Credenza

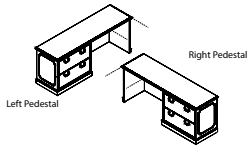

PAGE 24  
Workstation Credenza

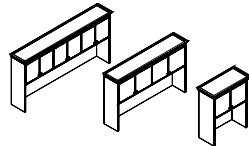

PAGE 25  
Overhead Consoles

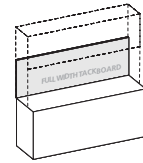

PAGE 26  
Overhead Tackboards

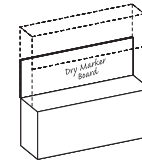

PAGE 27  
Overhead Dry Marker Boards

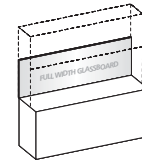

PAGE 28  
Overhead Glassboards

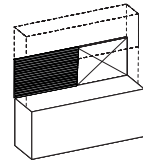

PAGE 29  
Overhead Slat Wall

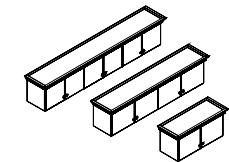

PAGE 30  
Wall Hung Overheads

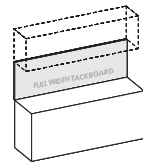

PAGE 31  
Wall Hung Tackboards

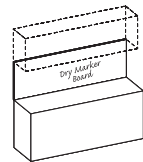

PAGE 32  
Wall Hung Dry Marker Boards

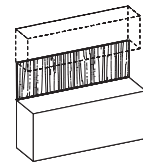

PAGE 33  
Wall Hung Veneer Panels

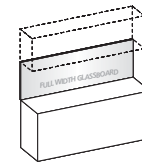

PAGE 34  
Wall Hung Glassboards

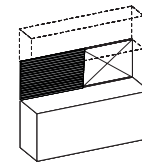

PAGE 35  
Wall Hung Slat Wall



PAGE 36  
Assembled Overhead Bookcase / Hutch

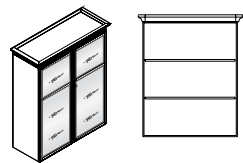

PAGE 37  
Assembled Overhead Bookcase / Hutch

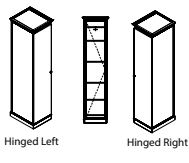

PAGE 38  
Vertical Half Towers

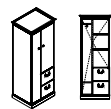

PAGE 39  
Vertical Half Towers

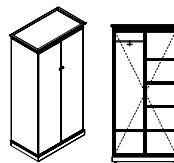

PAGE 40  
Vertical Full Towers

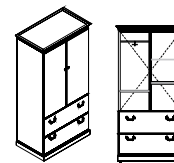

PAGE 41  
Vertical Full Towers

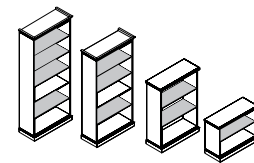

PAGE 42  
Assembled Bookcases



## Richmond park features & advantages

### Veneer

DARRAN only uses HPVA AA Grade Flat Cut Cherry and Walnut Veneers. All veneers are selected and matched for balance and consistency.

### Veneer tops

Richmond park veneer tops feature a 45-pound density substrate with balanced 3-ply construction. Tops are 1-5/16" thick on MDF core comprised of 100% recycled and recovered wood fibers. All veneer tops are slipmatched and feature a 3mm external solid hardwood band or profile edge.

### Laminate tops

Richmond park high-pressure laminate tops feature a 45-pound density substrate with balanced 3-ply construction. Tops are 1-5/16" thick on MDF core comprised of 100% recycled and recovered wood fibers. All high pressure laminate tops are available with a profile edge, laminate self-edge or 2mm PVC edge band. Laminates in wood grain patterns feature a fine grain texture that features the polish and luxe of a real wood veneer with a subtle narrow grain structure.

### Cleaning wood & laminate

In addition to regular dusting, give your furniture an occasional cleaning in accordance with our cleaning instructions. DARRAN wood and laminate products can be cleaned with a soft cloth and a mild soap and water mixture. Use approximately 32 oz of water mixed with one tablespoon of dish soap, always wiping with the grain. Dry with a soft cloth, going with the grain, to avoid spotting or streaking.

Wood products should be waxed periodically using a non-wax liquid; please do not use any waxy polish or cleaner. Interior of drawers may also be cleaned with mild soap and water mixture, or any household cleaner that is not petroleum or thinner-based.

### Chassis & pedestal

Chassis components are 3/4" thick core of particle board or MDF rated EPP/SCS/CARB-II material with 3-ply balanced construction. Pedestal and Cabinets feature dowel construction reinforced with steel bracket plates, wood cleats, screws and glue. All units are standard with 1" adjustable glides that allow for leveling of units that are secured in solid wood glide blocks to prevent tearout.

### Overhead cabinet construction Freestanding & wall mount

Freestanding Overhead storage cabinets are constructed of 1" and 3/4" thick core of particle board or MDF rated EPP/SCS/CARB-II material with 3-ply balanced construction. Panels are attached with cam fasteners in conjunction with dowels securely adhered with glue. All surface mount cabinets connect to work surface with anti-slip tape. Wall mount cabinets are mounted to the wall with steel "z" bracket attach-

ment method using 5mm euro screws to attach to the back of the cabinet. All units ship with a steel "z" bracket. This bracket is mounted to the wall by field installers. Installers are responsible for selecting and supplying appropriate fasteners for wall conditions.

### Bookcase Construction

All chassis (sides, back, top and bottom panels) are constructed with 3/4" thick core of particle board or MDF rated EPP/SCS/CARB-II material with 3-ply balanced construction. Panels are attached with cam-lock fasteners in conjunction with dowels securely adhered with glue. Shelves on all units are 3/4" thick balance 3 ply panels. Optional heavy duty shelves are 1" thick lumber core balanced 5 ply construction.

### Tackboards

Wall mount tackboards are constructed of .75" thick fiberboard. The fabric is precisely aligned and fitted to the tackboard with a sock on cover. Overhead storage tackboards are constructed of .75" thick fiberboard. The fabric is precisely aligned and fitted to the tackboard and adhered to the rigid hardboard with staples. Wall mount cabinets are mounted to the wall with steel "z" bracket attachment method using 5mm euro screws to attach to the back of the cabinet. All units ship with a steel "z" bracket. This bracket is mounted to the wall by field installers. Installers are responsible for selecting and supplying appropriate fasteners for wall conditions.

### Adjustable glides

Glides provide 1" of vertical leveling adjustment. Glide bottom is durable metal. Glides are secured in solid wood blocks that are screwed and glued for durability.

### Drawers

All drawers are constructed with mitre joint/dowel construction in a natural maple finish with four sides and a bottom, which are attached to a drawer front with screws for easy removal. Drawer fronts are vertically matched in balanced sets. Pencil trays are standard in all box drawers. Drawers are constructed of 1/2" thick wood grained wrapped 5 sided miter-folded construction with 1/4" thick hardboard bottoms reinforced for heavy weight capacity. Drawers have been tested and pass BIFMA 50,000 cycle test. All drawers are guaranteed lifetime with free replacement warranty.

### Drawer fronts

Drawer fronts are vertically matched in balanced sets. Doors feature vertical veneer bookmatched horizontally in sets of 2 / 4 and 6 doors. All tower fronts matched in vertical sets.

### Optional wood drawers

Optional hardwood veneer plywood drawers feature banded top and bottom edges for smoothness. Drawers are dowel joint construction with a UV cured finish over

## Richmond park features & advantages

maple veneers, plus a lifetime free replacement guarantee.  
Optional Wood Drawer (Any Size) – Option Code P33...\$45 List Price Per Drawer

### Suspensions

All casegoods utilize cold rolled steel zinc plated high-grade drawer suspensions. Box and File drawers are full extension, featuring steel ball bearings for a smoother quieter range of motion with soft close operation and are rated 100lbs. Lateral file drawers are a progressive action full extension suspension with the soft close operation and is rated at 150lbs. Lateral files include anti tip mechanism that will allow only one drawer at a time to be opened. All suspensions are soft close and are warranted for the lifetime of the product.

### Hinges

Units with doors include 95 degree swing hinges.

### Filing

Capitol park features a highly durable black plastic extrusion that is securely fastened into a route on top of the drawer to support hanging files. An adjustable crossbar is provided for all file drawers that enables legal/letter filing front to back or side-to-side based on the drawer size.

### Locks

Locks are Standard on all drawers below the worksurface. Random lock cores are installed at the factory. Some units may be shipped with the same key number. Locks are Silver, Black or Bronze and match pull finish unless otherwise specified.

DARRAN will also send lock cores separately to the dealer at your request. These units will be send with an empty lock core and the Dealer will receive a shipment of the requested lock core/keys.

### Keying

Keying is available either factory or field installed. Factory installed keying is random.

### Wire management

Wire management capabilities include standard and optional worksurface grommets. Specify W-1 under surface wire channels for organization and management of all communication wires and cords. Horizontal J-Channel wire management (Sku: W-1) is sold separately to conceal wire under worksurfaces.

### Grommets

Metal grommets are provided to match the drawer pull selection. Grommet is available in black, silver, white or antique brass. Must specify standard or non-

standard location. Black plastic grommets are available as an option for vertical applications.

### Powerports

A large selection of power pods are available and handle power, data, docking stations and communication. See options section for selection.

### LED tasklights

LED task lighting provides high efficiency, low energy lighting with a long life. Recessed light is encased in silver aluminum channel with milk lense and rounded end caps. Lights are factory installed. Product specifications listed below:

- Diffuser creates a softer light and eliminates hot spots
- Touch dimmer switch
- Can be "daisy chained" up to 90W
- 4.6 watts per foot
- 120 LEDs per meter
- Certification: UL Listed
- 50,000 hour life span.

Color Temp is 4000K

## Richmond park finishes | specifications

STANDARD VENEER	PREMIUM VENEER	HIGH PRESSURE LAMINATE	THERMALLY FUSED LAMINATE
WAC Amber Cherry .....	N/A .....	GAC Amber Cherry .....	N/A
WRC Caramel Cherry .....	N/A .....	N/A .....	N/A
WIC Crimson Cherry .....	N/A .....	GIC Crimson Cherry .....	N/A
WHC Honey Cherry .....	N/A .....	GHC Honey Cherry .....	N/A
WOC Koko Cherry .....	N/A .....	GOC Koko Cherry .....	N/A
WEW Executive Walnut .....	N/A .....	GEW Executive Walnut .....	N/A
WGW Gunstock Walnut .....	N/A .....	N/A .....	N/A
WBW Henna Walnut .....	N/A .....	N/A .....	N/A
WSW Smokey Walnut .....	N/A .....	N/A .....	N/A
WNW Natural Walnut .....	N/A .....	GNW Natural Walnut .....	N/A

HPL TOPS ON TFL PRODUCTS Add 10% - Available with flat edge only

Send 3x3 or larger finish chip for color match. Custom finish upcharge is 3% or \$250 Net (whichever is greater).

### Finish

ENVI-CT Green Certified European Technology Coatings Finish.

Richmond park edges | pulls | knobs

**Standard profile**

Richmond Park Edge  
Hardwood Rim Band Species Same As  
Surface Veneer

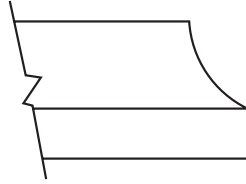

**Optional profile**

Classic Edge - No additional  
upcharge  
Hardwood Rim Band Species Same  
As Surface Veneer

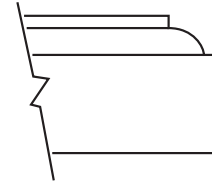

3mm solid  
hardwood band

**Hookup edge profile**

Coped Edge

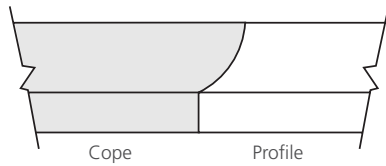

**Cornice top profile**

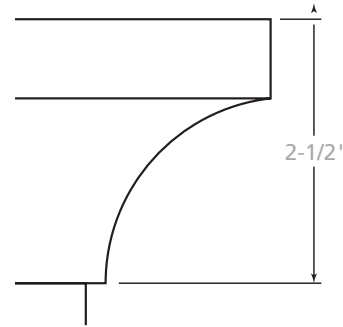

**Base profile**

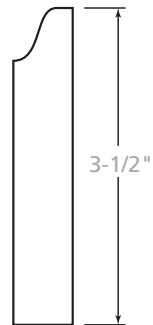

**Drawer/door  
edge profile**

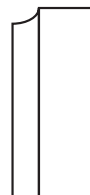

**Pulls/knobs**

Factory Installed



PL-5 Antique Brass  
PL-50 Brushed Pewter



PL-4 Antique Brass



DK-114  
Brushed Pewter

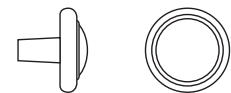

DK-4  
Antique Brass

## Richmond park grommets | grommet reference

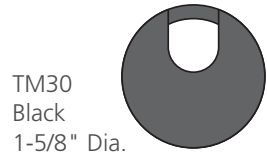

TM30  
Black  
1-5/8" Dia.

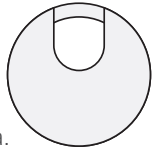

TM31  
Silver  
1-5/8" Dia.

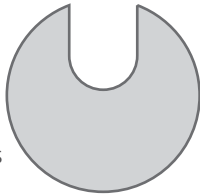

TM33  
Antique Brass  
2-1/2" Dia.

### Optional grommets

Factory Installed

Grommets (Standard Location)

Specify Color and Left/Right/Center - \$50 ea.

- Black: TM30-R (Right), TM30-L (Left), TM30-C (Center)

- Silver: TM31-R (Right), TM31-L (Left), TM31-C (Center)

- Antique Brass: TM33-R (Right), TM33-L (Left), TM33-C (Center)

Grommets (Non-Standard Location)

Provide drawing w/ Grommet Location and Specify Color - \$95 ea.

- Black: TM30-NS

- Silver: TM31-NS

- Antique Brass: TM33-NS

TM50  
Black  
1-5/8" Dia.



### Grommets (vertical surface)

Standard Location - \$50 ea.

- Black Plastic Vertical Surface: TM50-C (Bottom Center)

Non-Standard Location - \$95 ea.

- Black Plastic Vertical Surface: TM50-NS

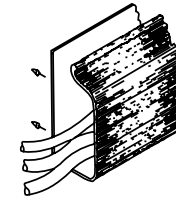

W1

### Horizontal J-channel

Horizontal J-Channel wire management (Sku: W-1) is sold separately to conceal wire under worksurfaces.

## Standard grommet location reference



Desk  
Specify Right or Left Grommet

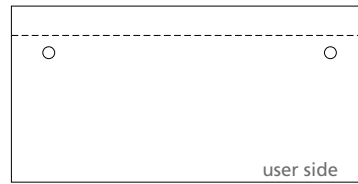

6" Overhang Desk  
Specify Right or Left Grommet

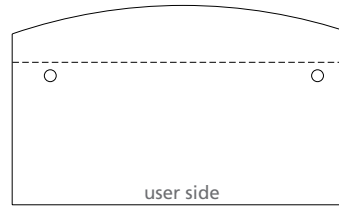

6"/12" Bow Front Desk  
Specify Right or Left Grommet



Bullet Conference Desk (Right Post)  
Center Grommet

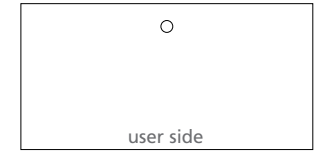

Bridge  
Center Grommet

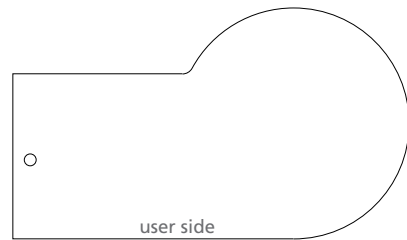

P Conference Desk (Right Post)  
Center Grommet

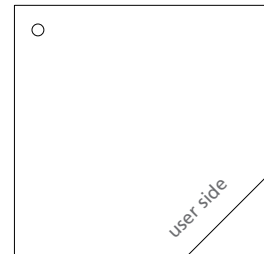

Corner  
Center Grommet

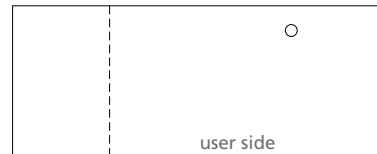

Return (Left Pedestal Shown)  
Right Pedestal - Left Grommet  
Left Pedestal - Right Grommet



Workstation Credenza  
Center Kneespace Grommet

## Richmond park ganging | height reference

### Ganging – Flush Cut Modification

30”H Casegood Worksurface & Base Ganging Modifications

To gang two casegood units, each unit end to be ganged must be flush cut modified for gapless surfaces and cabinet chassis.

Order Option:

- FC-B: Flush Unit Both Sides(Facing) for Ganging - \$100
- FC-L: Flush Unit Left (Facing) for Ganging - \$100
- FC-R: Flush Unit Right (Facing) for Ganging - \$100

Flush cut modification per unit includes all modifications to gang to one end or both ends when units are ganged. Modification includes tops, base and molding. Modification reduces width size approximately 1” per end.

Overhead consoles and towers are offered freestanding and ganging – inclusive of flush cut modifications.

Example:

RPC3121100W Two Drawer Lateral File (Left) Flush Cut Right – FC-R...\$100

RPC7221054 Kneespace Credenza (Right) Flush Cut Left – FC-L...\$100



## Height reference

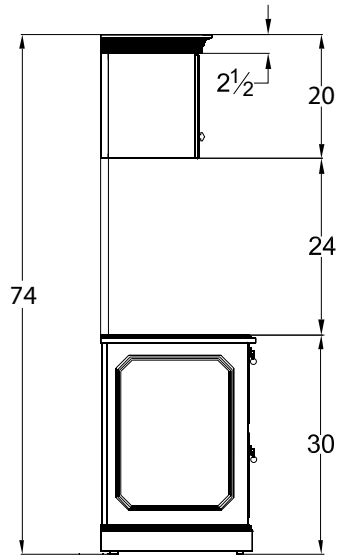

Typical Single Height Side Profile Wall Hung Overhead

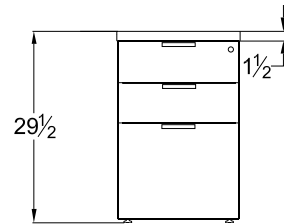

Pedestal Front Profile Box/Box/File

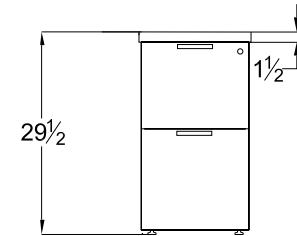

Pedestal Front Profile File/File

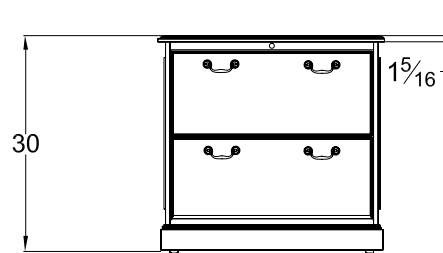

Pedestal Front Profile Lateral File

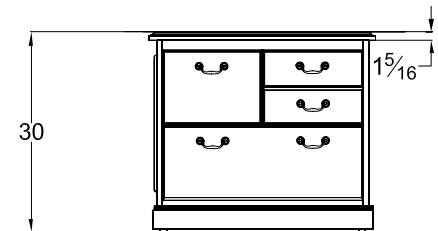

Pedestal Front Profile Multi-File



## Richmond park drawer modesty | grain direction

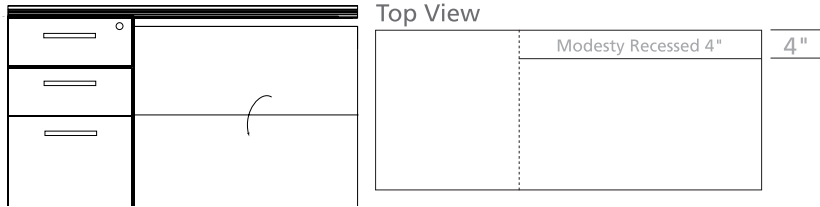

**M34**  
Drop Door Tech Modesty

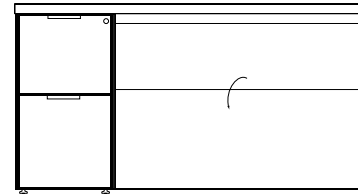

**M51**  
Open Back Modesty with 4" Wire Management Rail

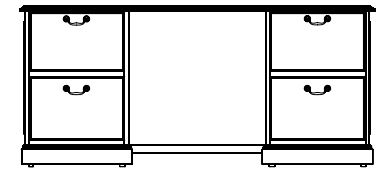

**M37**  
Fixed Full Modesty

## Grain direction

Veneer chassis parts are vertical grain. Doors feature vertical veneer bookmatched horizontally in sets of 2,4, and 6 doors. Tower fronts are matched in vertical sets.

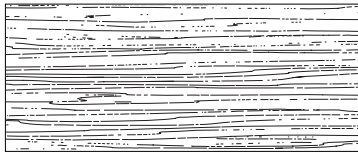

Desk

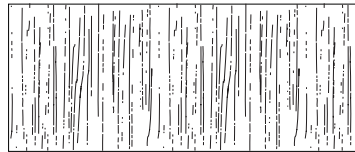

Runoff Desk  
Grain Direction on TFL  
Units Above 66" runs end to end

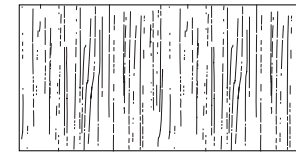

Bridge  
Grain Direction on TFL  
Units Above 66" runs end to end

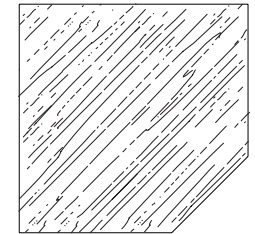

Corner

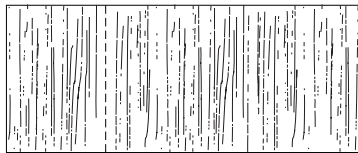

Return  
Grain Direction on TFL Units Above  
66" runs end to end



Credenza

# Richmond park Drawer dimensions | filing reference

## Interior drawer dimensions

UNIT DEPTH	DRAWER TYPE	OVERALL DIMENSIONS			INTERIOR DRAWER DIMENSIONS			NOTES
		W	D	H	W	D	H	
15-5/8" Letter	36" Box	13-1/8	19-11/16	4	12-1/8	18-11/16	3-7/16	Units less than 72"
	36" File	13-1/8	19-11/16	9-13/16	12-1/8	18-11/16	9-5/16	Units less than 72"
	30" Box	13-1/8	19-11/16	4	12-1/8	18-11/16	3-7/16	Units less than 72"
	30" File	13-1/8	19-11/16	9-13/16	12-1/8	18-11/16	9-5/16	Units less than 72"
	24" Box	13-1/8	16-1/16	4	12-1/8	15-1/16	3-7/16	Units less than 72"
	24" File	13-1/8	16-1/16	9-13/16	12-1/8	15-1/16	9-5/16	Units less than 72"
29" Lateral	24" Box	26-1/2	16-1/16	4	25-1/2	15-1/16	3-7/16	Workstation Credenzas less than 82"
	24" File	26-1/2	16-1/16	9-13/16	25-1/2	15-1/16	9-5/16	Workstation Credenzas less than 82"
35" Lateral	24" Box	32-1/2	16-1/16	4	31-1/2	15-1/16	3-7/16	Workstation Credenzas over 83"
	24" File	32-1/2	16-1/16	9-13/16	31-1/2	15-1/16	9-5/16	Workstation Credenzas over 83"
41" Lateral	24" File	38-1/2	16-1/16	9-13/16	37-1/2	15-1/16	9-5/16	Wood Drawer Only

## Filing reference

### Filing for 24" depth units

13 1/8" Wide File Drawer - 16 1/16" Deep

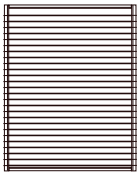

Letter Front to Back

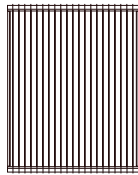

Legal Side to Side with File Rail

### 29" Lateral file drawer

26-1/2" Wide File Drawer - 16-1/16" Deep

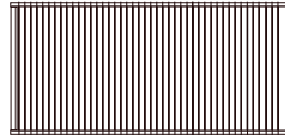

Legal Side to Side

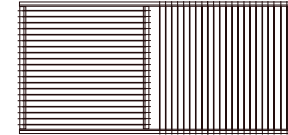

Legal Side to Side  
Letter Front to Back with File Rail

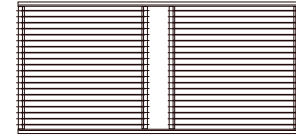

Letter Front to Back with File Rail

### Filing for 30" & 36" depth units

13 1/8" Wide File Drawer - 19 11/16" Deep

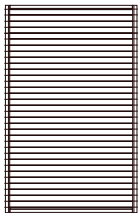

Letter Front to Back



Legal Side to Side with File Rail

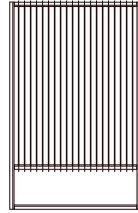

Letter Side to Side with File Rail

### 35" Lateral File Drawer

32-1/2" Wide File Drawer - 16-1/16" Deep

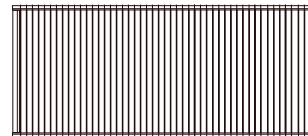

Legal Side to Side

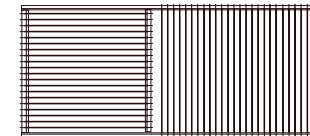

Legal Side to Side  
Letter Front to Back with File Rail

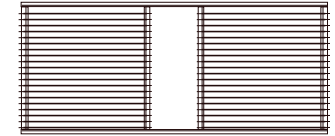

Letter Front to Back with File Rail

# Richmond park.

Double Pedestal Desks  
Executive Chassis Breakfront

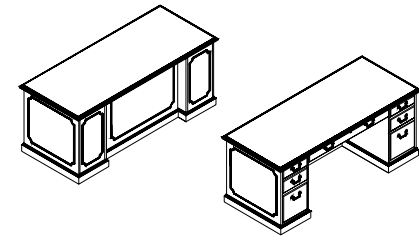

## 1 Select a model

w" x d" x h"

weight	Standard Veneer Top Standard Veneer Chassis		Premium Veneer Top Premium Veneer Chassis		High Pressure Laminate Top Veneer Chassis		Thermally Fused Laminate Top Thermally Fused Laminate Chassis	
	84 x 36 x 30	350	RPC8436DD000W 4528	"P" Option N/A	RPC8436DD000G 4528	"M" Option N/A		"M" Option N/A
72 x 36 x 30	335	RPC7236DD000W 4079	"P" Option N/A	RPC7236DD000G 4079	"M" Option N/A		"M" Option N/A	
72 x 30 x 30	320	RPC7230DD000W 4000	"P" Option N/A	RPC7230DD000G 4000	"M" Option N/A		"M" Option N/A	
66 x 36 x 30	315	RPC6636DD000W 4000	"P" Option N/A	RPC6636DD000G 4000	"M" Option N/A		"M" Option N/A	
66 x 30 x 30	275	RPC6630DD000W 3902	"P" Option N/A	RPC6630DD000G 3902	"M" Option N/A		"M" Option N/A	
60 x 30 x 30	230	RPC6030DD000W 3616	"P" Option N/A	RPC6030DD000G 3616	"M" Option N/A		"M" Option N/A	

[View statement of line](#)

## 2 Select a finish

[View finish details](#)

- WAC
- WRC
- WIC
- WHC
- WOC
- WEW
- WGW
- WBW
- WSW
- WNW

- GAC
- GIC
- GHC
- GOC
- GEW
- GNW

## 3 Select a edge

[View edge details](#)



## 4 Select hardware

[View hardware details](#)



## Product features.

- Box/Box/File
- Full extension drawers - locking
- Drawer fronts w/ profile edges
- Full modesty w/ base
- Laminate pull out writing shelf
- Soft close suspension drawer(s)

## Options.

### ACCESSORIES

- K28: Articulating Keyboard w/ Mouse pad (removes center drawer) - \$390

### DRAWER

- P6: Modify Box/Box/File to File/File - \$55 per pedestal
- P33: Wood Drawer Upgrade - \$45 per drawer

### GROMMETS (STANDARD LOCATION)

- Specify Color and Location Right/Left - \$50 ea.
- Black: TM30-R (Right), TM30-L (Left)
- Silver: TM31-R (Right), TM31-L (Left)
- Antique Brass: TM33-R (Right), TM33-L (Left)

### GROMMETS (NON-STANDARD LOCATION)

- Provide drawing w/ Grommet Location and Specify Color - \$95 ea.
- Black: TM30-NS
- Silver: TM31-NS
- Antique Brass: TM33-NS

### MOLDING

- DSM1: Delete molding - Deduct \$95

# Richmond park.

Double Pedestal Desks

Bowfront / Breakfront Executive Chassis

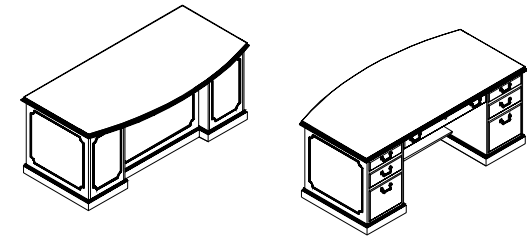

DARRAN

## 1 Select a model w" x d" x h"

weight	Standard Veneer Top Standard Veneer Chassis		Premium Veneer Top Premium Veneer Chassis		High Pressure Laminate Top Veneer Chassis		Thermally Fused Laminate Top Thermally Fused Laminate Chassis	
	84 x 36/42 x 30	370	RPC8442DD006W 4970	"P" Option N/A	RPC8442DD006G 4970	"M" Option N/A		
72 x 36/42 x 30	350	RPC7242DD006W 4522	"P" Option N/A	RPC7242DD006G 4522	"M" Option N/A			
72 x 30/36 x 30	340	RPC7236DD006W 4350	"P" Option N/A	RPC7236DD006G 4350	"M" Option N/A			
66 x 30/36 x 30	325	RPC6636DD006W 4272	"P" Option N/A	RPC6636DD006G 4272	"M" Option N/A			

[View statement of line](#)

## 2 Select a finish [View finish details](#)

WAC  
WRC  
WIC  
WHC  
WOC  
WEW  
WGW  
WBW  
WSW  
WNW

GAC  
GIC  
GHC  
GOC  
GEW  
GNW

## 3 Select a edge [View edge details](#)



## 4 Select hardware [View hardware details](#)



## Product features.

- Box/Box/File
- Decorative molding
- Drawer fronts w/ profile edges
- Full extension drawers - locking
- Full fixed modesty w/ base
- Laminate pull out writing shelf
- Soft close suspension drawer(s)

### NOTES

- 6" overhang on approach

## Options.

### ACCESSORIES

- K28: Articulating Keyboard w/ Mouse pad (removes center drawer) - \$390

### DRAWER

- P6: Modify Box/Box/File to File/File - \$55 per pedestal
- P33: Wood Drawer Upgrade - \$45 per drawer

### GROMMETS (STANDARD LOCATION)

- Specify Color and Location Right/Left - \$50 ea.
- Black: TM30-R (Right), TM30-L (Left)
  - Silver: TM31-R (Right), TM31-L (Left)
  - Antique Brass: TM33-R (Right), TM33-L (Left)

### GROMMETS (NON-STANDARD LOCATION)

- Provide drawing w/ Grommet Location and Specify Color - \$95 ea.
- Black: TM30-NS
  - Silver: TM31-NS
  - Antique Brass: TM33-NS

### MOLDING





- DSM1: Delete molding - Deduct \$95

# Richmond park.

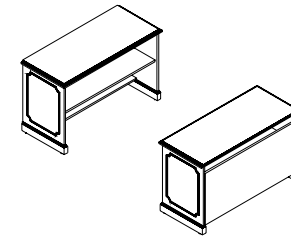
Desks

Crt Desk / Printer



1 Select a model w" x d" x h"	weight	Standard Veneer Top Standard Veneer Chassis		Premium Veneer Top Premium Veneer Chassis		High Pressure Laminate Top Veneer Chassis		Thermally Fused Laminate Top Thermally Fused Laminate Chassis	
		48 x 24 x 30	130	RPC4824AU225W	2076	"P" Option N/A		RPC4824AU225G	2076
42 x 24 x 30	120	RPC4224AU225W	2004	"P" Option N/A		RPC4224AU225G	2004	"M" Option N/A	
36 x 24 x 30	110	RPC3624AU225W	1955	"P" Option N/A		RPC3624AU225G	1955	"M" Option N/A	
2 Select a finish <a href="#">View finish details</a>		WAC WRC WIC WHC WOC WEW WGW WBW WSW WNW				GAC GIC GHC GOC GEW GNW			
3 Select a edge <a href="#">View edge details</a>		 Richmond  Classic				 Richmond  Classic			
4 Select hardware <a href="#">View hardware details</a>		Hardware N/A				Hardware N/A			

[View statement of line](#)

## Product features.

- 6" Storage foot shelf
- Adjustable shelf
- End panel molding
- Wire/Paper access back

## Options.

### GROMMETS (STANDARD LOCATION)

- Specify Color - \$50 ea.
- Black: TM30-C (Center)
  - Silver: TM31-C (Center)
  - Antique Brass: TM33-C (Center)

### GROMMETS (NON-STANDARD LOCATION)

- Provide drawing w/ Grommet Location and Specify Color - \$95 ea.
- Black: TM30-NS
  - Silver: TM31-NS
  - Antique Brass: TM33-NS

### GROMMETS (VERTICAL SURFACE)

- Standard Location - \$50 ea.
- Black Plastic Vertical Surface: TM50-C (Bottom Center)
- Non-Standard Location - \$95 ea.
- Black Plastic Vertical Surface: TM50-NS

### MOLDING

- DSM2: Delete molding - Deduct \$50

# Richmond park.

Workstation Desks



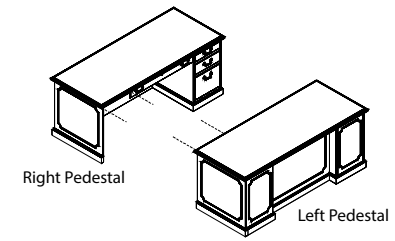





Executive Breakfront Chassis Single Pedestal Desk



Right Pedestal

Left Pedestal

[View statement of line](#)

1 Select a model w" x d" x h"	weight	Standard Veneer Top	Premium Veneer Top	High Pressure Laminate Top	Thermally Fused Laminate Top
		Standard Veneer Chassis	Premium Veneer Chassis	Veneer Chassis	Thermally Fused Laminate Chassis
<b>Left Pedestal</b>					
72 x 36 x 30	290	RPC7236DS009W 3516	"P" Option N/A	RPC7236DS009G 3516	"M" Option N/A
72 x 30 x 30	255	RPC7230DS009W 3480	"P" Option N/A	RPC7230DS009G 3480	"M" Option N/A
66 x 36 x 30	275	RPC6636DS009W 3430	"P" Option N/A	RPC6636DS009G 3430	"M" Option N/A
66 x 30 x 30	250	RPC6630DS009W 3338	"P" Option N/A	RPC6630DS009G 3338	"M" Option N/A
<b>Right Pedestal</b>					
72 x 36 x 30	290	RPC7236DS010W 3516	"P" Option N/A	RPC7236DS010G 3516	"M" Option N/A
72 x 30 x 30	255	RPC7230DS010W 3480	"P" Option N/A	RPC7230DS010G 3480	"M" Option N/A
66 x 36 x 30	275	RPC6636DS010W 3430	"P" Option N/A	RPC6636DS010G 3430	"M" Option N/A
66 x 30 x 30	250	RPC6630DS010W 3338	"P" Option N/A	RPC6630DS010G 3338	"M" Option N/A
<b>2 Select a finish</b> <a href="#">View finish details</a>		WAC WRC WIC WHC WOC WEW WGW WBW WSW WNW		GAC GIC GHC GOC GEW GNW	
<b>3 Select a edge</b> <a href="#">View edge details</a>		 Richmond  Classic		 Richmond  Classic	
<b>4 Select hardware</b> <a href="#">View hardware details</a>		 PL-4 Antique Brass  PL-50 Brushed Pewter		 PL-4 Antique Brass  PL-50 Brushed Pewter	

## Product features.

- Box/Box/File
- Drawer fronts w/ profile edges
- Full extension drawers - Full extension drawers - locking
- Full fixed modesty w/ base
- Hookup hardware
- Laminate pull out writing shelf
- Soft close suspension drawer(s)

## Options.

### DRAWER

- P33: Wood Drawer Upgrade - \$45 per drawer

### GROMMETS (STANDARD LOCATION)

Specify Color and Location Right/Left - \$50 ea.

- Black: TM30-R (Right), TM30-L (Left)
- Silver: TM31-R (Right), TM31-L (Left)
- Antique Brass: TM33-R (Right), TM33-L (Left)

### GROMMETS (NON-STANDARD LOCATION)

Provide drawing w/ Grommet Location and Specify Color - \$95 ea.

- Black: TM30-NS
- Silver: TM31-NS
- Antique Brass: TM33-NS

### MOLDING

- DSM1: Delete molding - Deduct \$95

# Richmond park.

Workstation Desks

Bowfront / Breakfront Executive Chassis Single Pedestal Desk

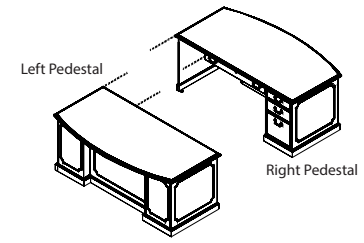

## 1 Select a model w" x d" x h"

weight	Standard Veneer Top		Premium Veneer Top		High Pressure Laminate Top		Thermally Fused Laminate Top	
	Standard Veneer Chassis		Premium Veneer Chassis		Veneer Chassis		Thermally Fused Laminate Chassis	
<b>Left Pedestal</b>								
84 x 36/42 x 30	350	RPC8442DS017W	4143	"P" Option N/A	RPC8442DS017G	4143	"M" Option N/A	
72 x 36/42 x 30	315	RPC7242DS017W	3894	"P" Option N/A	RPC7242DS017G	3894	"M" Option N/A	
72 x 30/36 x 30	295	RPC7236DS017W	3844	"P" Option N/A	RPC7236DS017G	3844	"M" Option N/A	
66 x 36/42 x 30	285	RPC6642DS017W	3808	"P" Option N/A	RPC6642DS017G	3808	"M" Option N/A	
66 x 30/36 x 30	275	RPC6636DS017W	3702	"P" Option N/A	RPC6636DS017G	3702	"M" Option N/A	
<b>Right Pedestal</b>								
84 x 36/42 x 30	350	RPC8442DS018W	4143	"P" Option N/A	RPC8442DS018G	4143	"M" Option N/A	
72 x 36/42 x 30	315	RPC7242DS018W	3894	"P" Option N/A	RPC7242DS018G	3894	"M" Option N/A	
72 x 30/36 x 30	295	RPC7236DS018W	3844	"P" Option N/A	RPC7236DS018G	3844	"M" Option N/A	
66 x 36/42 x 30	285	RPC6642DS018W	3808	"P" Option N/A	RPC6642DS018G	3808	"M" Option N/A	
66 x 30/36 x 30	275	RPC6636DS018W	3702	"P" Option N/A	RPC6636DS018G	3702	"M" Option N/A	

[View statement of line](#)

## 2 Select a finish [View finish details](#)

- WAC
- WRC
- WIC
- WHC
- WOC
- WEW
- WGW
- WBW
- WSW
- WNW

- GAC
- GIC
- GHC
- GOC
- GEW
- GNW

## 3 Select a edge [View edge details](#)



## 4 Select hardware [View hardware details](#)



## Product features.

- 6" Overhang on approach
- Box/Box/File
- Drawer fronts w/ profile edges
- Full extension drawers - Full extension drawers - locking
- Full fixed modesty w/ base
- Hookup hardware
- Laminate pull out writing shelf
- Soft close suspension drawer(s)

## Options.

### DRAWER

- K28: Articulating Keyboard w/ Mouse pad - \$390
- P6: Modify Box/Box/File to File/File - \$55 per pedestal
- P33: Wood Drawer Upgrade - \$45 per drawer

### GROMMETS (STANDARD LOCATION)

- Specify Color and Location Right/Left - \$50 ea.
- Black: TM30-R (Right), TM30-L (Left)
  - Silver: TM31-R (Right), TM31-L (Left)
  - Antique Brass: TM33-R (Right), TM33-L (Left)

### GROMMETS (NON-STANDARD LOCATION)

- Provide drawing w/ Grommet Location and Specify Color - \$95 ea.
- Black: TM30-NS
  - Silver: TM31-NS
  - Antique Brass: TM33-NS

### MOLDING

- DSM1: Delete molding - Deduct \$95

# Richmond park.

Workstation Desks  
Bullet Conference Desk

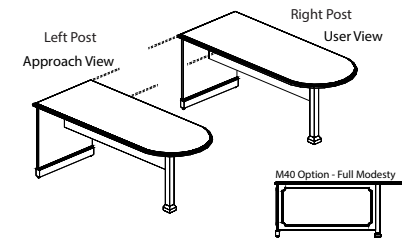

View statement of line

1 Select a model w" x d" x h"	weight	Standard Veneer Top	Premium Veneer Top	High Pressure Laminate Top	Thermally Fused Laminate Top
		Standard Veneer Chassis	Premium Veneer Chassis	Veneer Chassis	Thermally Fused Laminate Chassis
<b>Left Post</b>			"P" Option N/A		"M" Option N/A
72 x 36 x 30	160	RPC7236DC716W 2767	"P" Option N/A	RPC7236DC716G 2767	"M" Option N/A
72 x 30 x 30	150	RPC7230DC716W 2681	"P" Option N/A	RPC7230DC716G 2681	"M" Option N/A
66 x 30 x 30	140	RPC6630DC716W 2582	"P" Option N/A	RPC6630DC716G 2582	"M" Option N/A
60 x 30 x 30	125	RPC6030DC716W 2504	"P" Option N/A	RPC6030DC716G 2504	"M" Option N/A
<b>Right Post</b>			"P" Option N/A		"M" Option N/A
72 x 36 x 30	160	RPC7236DC715W 2767	"P" Option N/A	RPC7236DC715G 2767	"M" Option N/A
72 x 30 x 30	150	RPC7230DC715W 2681	"P" Option N/A	RPC7230DC715G 2681	"M" Option N/A
66 x 30 x 30	140	RPC6630DC715W 2582	"P" Option N/A	RPC6630DC715G 2582	"M" Option N/A
60 x 30 x 30	125	RPC6030DC715W 2504	"P" Option N/A	RPC6030DC715G 2504	"M" Option N/A
<b>2 Select a finish</b> <i>View finish details</i>		WAC WRC WIC WHC WOC WEW WGW WBW WSW WNW		GAC GIC GHC GOC GEW GNW	
<b>3 Select a edge</b> <i>View edge details</i>		Richmond  Classic		Richmond  Classic	
<b>4 Select hardware</b> <i>View hardware details</i>		Hardware N/A		Hardware N/A	

## Product features.

- 12" Modesty panel standard
- End panel w/ solid hardwood base
- Solid hardwood square post

### NOTES

- "P" Tops and Bullets are not intended to be freestanding

## Options.

### ACCESSORIES

- K28: Articulating Keyboard w/ Mouse pad - \$390
- K30: Traditional Center Drawer - \$205

### GROMMETS (STANDARD LOCATION)

- Specify Color - \$50 ea.
- Black: TM30-C (Center)
  - Silver: TM31-C (Center)
  - Antique Brass: TM33-C (Center)

### GROMMETS (NON-STANDARD LOCATION)

- Provide drawing w/ Grommet Location and Specify Color - \$95 ea.
- Black: TM30-NS
  - Silver: TM31-NS
  - Antique Brass: TM33-NS

### MODESTY

- M40: Fixed Full Modesty - \$205



# Richmond park.

Workstation Returns  
Box / Box / File

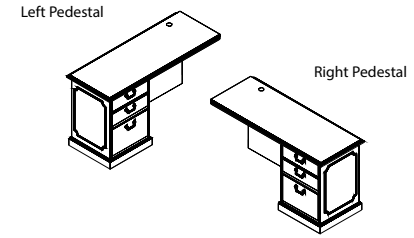

## 1 Select a model w" x d" x h"

weight	Standard Veneer Top Standard Veneer Chassis		Premium Veneer Top Premium Veneer Chassis		High Pressure Laminate Top Veneer Chassis		Thermally Fused Laminate Top Thermally Fused Laminate Chassis	
<b>Left Pedestal</b>								
60 x 24 x 30	165	RPC6024RE207W 2660	"P" Option N/A		RPC6024RE207G 2660		"M" Option N/A	
54 x 24 x 30	155	RPC5424RE207W 2553	"P" Option N/A		RPC5424RE207G 2553		"M" Option N/A	
48 x 24 x 30	145	RPC4824RE207W 2452	"P" Option N/A		RPC4824RE207G 2452		"M" Option N/A	
42 x 24 x 30	135	RPC4224RE207W 2397	"P" Option N/A		RPC4224RE207G 2397		"M" Option N/A	
<b>Right Pedestal</b>								
60 x 24 x 30	165	RPC6024RE209W 2660	"P" Option N/A		RPC6024RE209G 2660		"M" Option N/A	
54 x 24 x 30	155	RPC5424RE209W 2553	"P" Option N/A		RPC5424RE209G 2553		"M" Option N/A	
48 x 24 x 30	145	RPC4824RE209W 2452	"P" Option N/A		RPC4824RE209G 2452		"M" Option N/A	
42 x 24 x 30	135	RPC4224RE209W 2397	"P" Option N/A		RPC4224RE209G 2397		"M" Option N/A	

[View statement of line](#)

## 2 Select a finish [View finish details](#)

WAC  
WRC  
WIC  
WHC  
WOC  
WEW  
WGW  
WBW  
WSW  
WNW

GAC  
GIC  
GHC  
GOC  
GEW  
GNW

## 3 Select a edge [View edge details](#)



Richmond Classic



Richmond Classic

## 4 Select hardware [View hardware details](#)



PL-4 Antique Brass

PL-5 Antique Brass  
PL-50 Brushed Pewter



PL-4 Antique Brass

PL-5 Antique Brass  
PL-50 Brushed Pewter

## Product features.

- 1 Standard grommet - matches pull finish or specify black TM30, silver TM31 or antique brass TM33
- Drawer fronts w/ profile edges
- Full extension drawers - locking
- Full fixed modesty
- Soft close suspension drawer(s)

## Options.

### ACCESSORIES

- K28: Articulating Keyboard w/ Mouse pad - \$390

### DRAWER

- P33: Wood Drawer Upgrade - \$45 per drawer
- P40B: extra Box/Box/File or File/File to Kneespace - \$1,025

### FLUSH CUT

- FC-L: Flush Unit Left (Facing) for Ganging - \$100
- FC-R: Flush Unit Right(Facing) for Ganging - \$100

### GROMMETS (NON-STANDARD LOCATION)

- Provide drawing w/ Grommet Location and Specify Color - \$95 ea.
- Black: TM30-NS
- Silver: TM31-NS
- Antique Brass: TM33-NS

### MODESTY

- M34T: "W" "G" Style Drop Door Tech Modesty - \$130
- M51: Open Back Modesty with Wire Mgmt Rail - Deduct \$95 Molding
- DSM2: Delete molding - Deduct \$50

# Richmond park.

Workstation Returns  
File / File

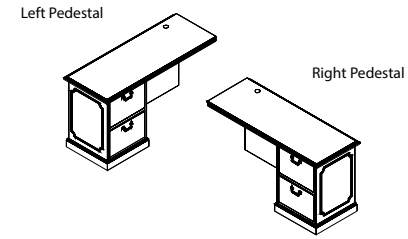

## 1 Select a model w" x d" x h"

weight	Standard Veneer Top		Premium Veneer Top		High Pressure Laminate Top		Thermally Fused Laminate Top	
	Standard Veneer Chassis		Premium Veneer Chassis		Veneer Chassis		Thermally Fused Laminate Chassis	
<b>Left Pedestal</b>								
60 x 24 x 30	165	RPC6024RE195W	2660	"P" Option N/A	RPC6024RE195G	2660	"M" Option N/A	
54 x 24 x 30	155	RPC5424RE195W	2553	"P" Option N/A	RPC5424RE195G	2553	"M" Option N/A	
48 x 24 x 30	145	RPC4824RE195W	2452	"P" Option N/A	RPC4824RE195G	2452	"M" Option N/A	
42 x 24 x 30	135	RPC4224RE195W	2397	"P" Option N/A	RPC4224RE195G	2397	"M" Option N/A	
<b>Right Pedestal</b>								
60 x 24 x 30	165	RPC6024RE196W	2660	"P" Option N/A	RPC6024RE196G	2660	"M" Option N/A	
54 x 24 x 30	155	RPC5424RE196W	2553	"P" Option N/A	RPC5424RE196G	2553	"M" Option N/A	
48 x 24 x 30	145	RPC4824RE196W	2452	"P" Option N/A	RPC4824RE196G	2452	"M" Option N/A	
42 x 24 x 30	135	RPC4224RE196W	2397	"P" Option N/A	RPC4224RE196G	2397	"M" Option N/A	

[View statement of line](#)

## 2 Select a finish [View finish details](#)

WAC  
WRC  
WIC  
WHC  
WOC  
WEW  
WGW  
WBW  
WSW  
WNW

GAC  
GIC  
GHC  
GOC  
GEW  
GNW

## 3 Select a edge [View edge details](#)



Richmond Classic



Richmond Classic

## 4 Select hardware [View hardware details](#)



PL-4 Antique Brass

PL-5 Antique Brass  
PL-50 Brushed Pewter



PL-4 Antique Brass

PL-5 Antique Brass  
PL-50 Brushed Pewter

## Product features.

- 1 Standard grommet - matches pull finish or specify black TM30, silver TM31 or antique brass TM33
- Drawer fronts w/ profile edges
- Full extension drawers - locking
- Full fixed modesty
- Soft close suspension drawer(s)

## Options.

### ACCESSORIES

- K28: Articulating Keyboard w/ Mouse pad - \$390

### DRAWER

- P33: Wood Drawer Upgrade - \$45 per drawer
- P40B: extra Box/Box/File or File/File to Kneespace - \$1,025

### FLUSH CUT

- FC-L: Flush Unit Left (Facing) for Ganging - \$100
- FC-R: Flush Unit Right(Facing) for Ganging - \$100

### GROMMETS (NON-STANDARD LOCATION)

- Provide drawing w/ Grommet Location and Specify Color - \$95 ea.
- Black: TM30-NS
- Silver: TM31-NS
- Antique Brass: TM33-NS

### MODESTY





- M34T: "W" "G" Style Drop Door Tech Modesty - \$130
- M51: Open Back Modesty with Wire Mgmt Rail - Deduct \$95 Molding
- DSM2: Delete molding - Deduct \$50

# Richmond park.

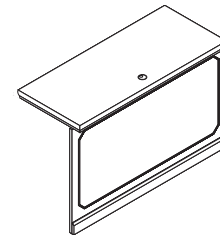
Workstation Units

Bridge W/ Fixed Full Modesty



1 Select a model w" x d" x h"	weight	Standard Veneer Top Standard Veneer Chassis		Premium Veneer Top Premium Veneer Chassis		High Pressure Laminate Top Veneer Chassis		Thermally Fused Laminate Top Thermally Fused Laminate Chassis	
		<b>24" Deep Bridge</b> 54 x 24 x 30 48 x 24 x 30 42 x 24 x 30	95 90 85	RPC5424BR150W RPC4824BR150W RPC4224BR150W	1249 1163 1135	"P" Option N/A "P" Option N/A "P" Option N/A	RPC5424BR150G RPC4824BR150G RPC4224BR150G	1249 1163 1135	"M" Option N/A "M" Option N/A "M" Option N/A
<b>2 Select a finish</b> <a href="#">View finish details</a>		WAC WRC WIC WHC WOC WEW WGW WBW WSW WNW			GAC GIC GHC GOC GEW GNW				
<b>3 Select a edge</b> <a href="#">View edge details</a>		 Richmond  Classic			 Richmond  Classic				
<b>4 Select hardware</b> <a href="#">View hardware details</a>		Hardware N/A			Hardware N/A				

[View statement of line](#)

## Product features.

- Full modesty panel with base
- Top cope shaped for flush surface
- Top grommet

## Options.

### ACCESSORIES

- K28: Articulating Keyboard w/ Mouse pad - \$390

### MOLDING

- DSM1: Delete molding - Deduct \$95

### GROMMETS (NON-STANDARD LOCATION)

Provide drawing w/ Grommet Location and Specify Color - \$95 ea.

- Black: TM30-NS
- Silver: TM31-NS
- Antique Brass: TM33-NS

# Richmond park.

Credenzas / Files  
Storage Credenza

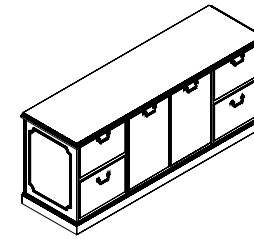

## 1 Select a model

w" x d" x h"

weight	Standard Veneer Top Standard Veneer Chassis		Premium Veneer Top Premium Veneer Chassis		High Pressure Laminate Top Veneer Chassis		Thermally Fused Laminate Top Thermally Fused Laminate Chassis	
	<b>File/ File</b>							
72 x 24 x 30	280	RPC7224CA050W 3480	"P" Option N/A		RPC7224CA050G 3480	"M" Option N/A		
66 x 24 x 30	265	RPC6624CA050W 3338	"P" Option N/A		RPC6624CA050G 3338	"M" Option N/A		
<b>Lateral File</b>								
95 x 24 x 30	350	RPC9524CA651W 6211	"P" Option N/A		RPC9524CA651G 6211	"M" Option N/A		
89 x 24 x 30	325	RPC8924CA651W 5911	"P" Option N/A		RPC8924CA651G 5911	"M" Option N/A		

[View statement of line](#)

## 2 Select a finish

[View finish details](#)

WAC  
WRC  
WIC  
WHC  
WOC  
WEW  
WGW  
WBW  
WSW  
WNW

GAC  
GIC  
GHC  
GOC  
GEW  
GNW

## 3 Select a edge

[View edge details](#)



## 4 Select hardware

[View hardware details](#)



## Product features.

- Black adjustable shelf behind door set
- Drawer fronts w/ profile edges
- File/File
- Full continuous base under cabinets
- Soft close suspension drawer(s)

### NOTES

- Unit not designed for open plan use, standard with unfinished back.
- Select OPB Option for Open Plan application.

## Options.

### DOOR

- D2: Door Lock - \$100 per door set
- D6A: "W" "G" Styles - Delete Doors and replace black laminate shelf with finished shelf - n/c
- D9SC: Soft Close Door Hinges - \$20 per door

### DRAWER

- P6: Modify File/File to Box/Box/File - \$55 per pedestal
- P33: Wood Drawer Upgrade - \$45 per drawer

### FLUSH CUT

- FC-B: Flush Unit Both Sides(Facing) for Ganging - \$100
- FC-L: Flush Unit Left (Facing) for Ganging - \$100
- FC-R: Flush Unit Right(Facing) for Ganging - \$100

### GROMMETS (STANDARD LOCATION)

- Specify Color and Location (Right/Left/Center) - \$50 ea.
- Black: TM30-R (Right), TM30-L (Left), TM30-C (Center)
  - Silver: TM31-R (Right), TM31-L (Left), TM31-C (Center)
  - Antique Brass: TM33-R (Right), TM33-L (Left), TM33-C (Center)

### GROMMETS (NON-STANDARD LOCATION)

- Provide drawing w/ Grommet Location and Specify Color - \$95 ea.
- Black: TM30-NS
  - Silver: TM31-NS
  - Antique Brass: TM33-NS
- Molding
- DSM2: Delete molding - Deduct \$50
- Open Plan – Finished Back
- OPB: "W" "G" Style - Modify Unit for Open Plan Application - \$295 Shelves
  - S25: Replace Black Laminate Shelf with Finished Shelf - \$80 per shelf

# Richmond park.

Credenzas / Files

Kneespace Credenza

## 1 Select a model w" x d" x h"

	weight	Standard Veneer Top Standard Veneer Chassis	Premium Veneer Top Premium Veneer Chassis	High Pressure Laminate Top Veneer Chassis	Thermally Fused Laminate Top Thermally Fused Laminate Chassis
72 x 24 x 30	250	RPC7224CA054W 3067	"P" Option N/A	RPC7224CA054G 3067	"M" Option N/A
66 x 24 x 30	235	RPC6624CA054W 2882	"P" Option N/A	RPC6624CA054G 2882	"M" Option N/A
60 x 24 x 30	225	RPC6024CA054W 2681	"P" Option N/A	RPC6024CA054G 2681	"M" Option N/A

## 2 Select a finish

[View finish details](#)

WAC  
WRC  
WIC  
WHC  
WOC  
WEW  
WGW  
WBW  
WSW  
WNW

## 3 Select a edge

[View edge details](#)



Richmond Classic

## 4 Select hardware

[View hardware details](#)



PL-4 Antique Brass

PL-5 Antique Brass  
PL-50 Brushed Pewter

GAC  
GIC  
GHC  
GOC  
GEW  
GNW



Richmond Classic



PL-4 Antique Brass

PL-5 Antique Brass  
PL-50 Brushed Pewter

[View statement of line](#)

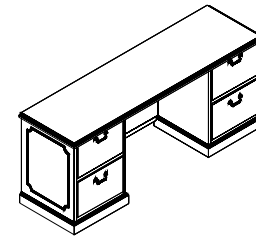

## Product features.

- Drawer fronts w/ profile edges
- File/File
- Full fixed modesty
- Soft close suspension drawer(s)

### NOTES

- Unit not designed for open plan use, standard with unfinished back.
- Select OPB Option for Open Plan application.

## Options.

### ACCESSORIES

- K28: Articulating Keyboard w/ Mouse pad - \$390

### DRAWER

- P6: Modify File/File to Box/Box/File - \$55 per pedestal
- P33: Wood Drawer Upgrade - \$45 per drawer

### FLUSH CUT

- FC-B: Flush Unit Both Sides(Facing) for Ganging - \$100
- FC-L: Flush Unit Left (Facing) for Ganging - \$100
- FC-R: Flush Unit Right(Facing) for Ganging - \$100

### GROMMETS (STANDARD LOCATION)

- Specify Color - \$50 ea.
- Black: TM30-C (Center)
  - Silver: TM31-C (Center)
  - Antique Brass: TM33-C (Center)

### GROMMETS (NON-STANDARD LOCATION)

Provide drawing w/ Grommet Location and Specify Color - \$95 ea.

- Black: TM30-NS
- Silver: TM31-NS
- Antique Brass: TM33-NS

### Modesty

- M34T: "W" "G" Style Drop Door Tech Modesty - \$130
- M51: Open Back Modesty with Wire Mgmt Rail - Deduct \$95

### Molding

- DSM2: Delete molding - Deduct \$50

### Open Plan – Finished Back

- OPB: "W" "G" Style - Modify Unit for Open Plan Application - \$295

# Richmond park.

Credenzas / Files  
Storage Credenza

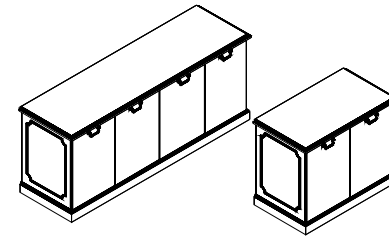

## 1 Select a model

w" x d" x h"

weight	Standard Veneer Top Standard Veneer Chassis		Premium Veneer Top Premium Veneer Chassis		High Pressure Laminate Top Veneer Chassis		Thermally Fused Laminate Top Thermally Fused Laminate Chassis	
	72 x 24 x 30	260	RPC7224CA125W 3409	"P" Option N/A	RPC7224CA125G 3409	"M" Option N/A	RPC7224CA125G 3409	"M" Option N/A
60 x 24 x 30	230	RPC6024CA125W 3252	"P" Option N/A	RPC6024CA125G 3252	"M" Option N/A	RPC6024CA125G 3252	"M" Option N/A	
37 x 24 x 30	160	RPC3724CA125W 1946	"P" Option N/A	RPC3724CA125G 1946	"M" Option N/A	RPC3724CA125G 1946	"M" Option N/A	
31 x 24 x 30	150	RPC3124CA125W 1883	"P" Option N/A	RPC3124CA125G 1883	"M" Option N/A	RPC3124CA125G 1883	"M" Option N/A	

[View statement of line](#)

## 2 Select a finish

[View finish details](#)

WAC  
WRC  
WIC  
WHC  
WOC  
WEW  
WGW  
WBW  
WSW  
WNW

GAC  
GIC  
GHC  
GOC  
GEW  
GNW

## 3 Select a edge

[View edge details](#)



## 4 Select hardware

[View hardware details](#)



## Product features.

- Black adjustable shelf behind door set
- Door fronts w/ profile edges
- Full continuous base under cabinets

### NOTES

- Unit not designed for open plan use, standard with unfinished back.
- Select OPB Option for Open Plan application.

## Options.

### DOOR

- D2: Door Lock - \$100 per door set
- D6A: "W" "G" Styles - Delete Doors and replace black laminate shelf with finished shelf - n/c
- D9SC: Soft Close Door Hinges - \$20 per door

### FLUSH CUT

- FC-B: Flush Unit Both Sides(Facing) for Ganging - \$100
- FC-L: Flush Unit Left (Facing) for Ganging - \$100
- FC-R: Flush Unit Right(Facing) for Ganging - \$100

### GROMMETS (STANDARD LOCATION)

- Specify Color and Location (Right/Left/Center) - \$50 ea.
- Black: TM30-R (Right), TM30-L (Left), TM30-C (Center)
  - Silver: TM31-R (Right), TM31-L (Left), TM31-C (Center)
  - Antique Brass: TM33-R (Right), TM33-L (Left), TM33-C (Center)

### GROMMETS (NON-STANDARD LOCATION)

- Provide drawing w/ Grommet Location and Specify Color - \$95 ea.
- Black: TM30-NS
  - Silver: TM31-NS
  - Antique Brass: TM33-NS

### MOLDING

- DSM2: Delete molding - Deduct \$50
- Open Plan – Finished Back
- OPB: "W" "G" Style - Modify Unit for Open Plan Application - \$295 Shelves
- S25: Replace Black Laminate Shelf with Finished Shelf - \$80 per shelf

# Richmond park.





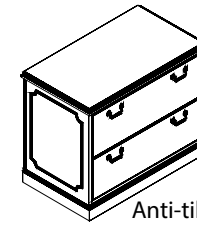



Lateral File Credenzas

Horizontal Lateral File - 214



Anti-tilt Safety Drawer Lock

[View statement of line](#)

1 Select a model w" x d" x h"	weight	Standard Veneer Top	Premium Veneer Top	High Pressure Laminate Top	Thermally Fused Laminate Top
		Standard Veneer Chassis	Premium Veneer Chassis	Veneer Chassis	Thermally Fused Laminate Chassis
<b>4 Drawer</b>					
72 x 24 x 30	300	RPC7224CA104W 3765	"P" Option N/A	RPC7224CA104G 3765	"M" Option N/A
60 x 24 x 30	275	RPC6024CA104W 3524	"P" Option N/A	RPC6024CA104G 3524	"M" Option N/A
<b>2 Drawer</b>					
43 x 24 x 30	175	RPC4324CA104W 2285	"P" Option N/A	RPC4324CA104G 2285	"M" Option N/A
37 x 24 x 30	165	RPC3724CA104W 2054	"P" Option N/A	RPC3724CA104G 2054	"M" Option N/A
31 x 24 x 30	155	RPC3124CA104W 1984	"P" Option N/A	RPC3124CA104G 1984	"M" Option N/A
<b>2 Select a finish</b> <a href="#">View finish details</a>		WAC WRC WIC WHC WOC WEW WGW WBW WSW WNW		GAC GIC GHC GOC GEW GNW	
<b>3 Select an edge</b> <a href="#">View edge details</a>		 Richmond  Classic		 Richmond  Classic	
<b>4 Select hardware</b> <a href="#">View hardware details</a>		 PL-4 Antique Brass  PL-5 Antique Brass PL-50 Brushed Pewter		 PL-4 Antique Brass  PL-5 Antique Brass PL-50 Brushed Pewter	

## Product features.

- Anti-tilt safety drawer lock
- Drawer fronts w/ profile edges
- Full extension drawers - locking
- Legal/Double letter filing
- Soft close suspension drawer(s)

### NOTES

- Unit not designed for open plan use, standard with unfinished back.
- Select OPB Option for Open Plan application.

## Options.

### DRAWER

- P33: Wood Drawer Upgrade - \$45 per drawer

### FLUSH CUT

- FC-B: Flush Unit Both Sides(Facing) for Ganging - \$100
- FC-L: Flush Unit Left (Facing) for Ganging - \$100
- FC-R: Flush Unit Right(Facing) for Ganging - \$100

### GROMMETS (STANDARD LOCATION)

- Specify Color and Location (Right/Left/Center) - \$50 ea.
- Black: TM30-R (Right), TM30-L (Left), TM30-C (Center)
- Silver: TM31-R (Right), TM31-L (Left), TM31-C (Center)
- Antique Brass: TM33-R (Right), TM33-L (Left), TM33-C (Center)

### GROMMETS (NON-STANDARD LOCATION)

- Provide drawing w/ Grommet Location and Specify Color - \$95 ea.
- Black: TM30-NS
- Silver: TM31-NS
- Antique Brass: TM33-NS

### MOLDING







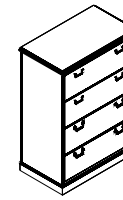

- DSM2: Delete molding - Deduct \$50
- Open Plan – Finished Back
- OPB: "W" "G" Style - Modify Unit for Open Plan Application - \$295

# Richmond park.

Credenzas / Files  
Vertical Lateral File



Anti-tilt Safety Drawer Lock

1 Select a model w" x d" x h"	weight	Standard Veneer Top	Premium Veneer Top	High Pressure Laminate Top	Thermally Fused Laminate Top
		Standard Veneer Chassis	Premium Veneer Chassis	Veneer Chassis	Thermally Fused Laminate Chassis
43 x 24 x 52	300	RPC4324FI111W 4517	"P" Option N/A	RPC4324FI111G 4517	"M" Option N/A
37 x 24 x 52	275	RPC3724FI111W 3850	"P" Option N/A	RPC3724FI111G 3850	"M" Option N/A
31 x 24 x 52	245	RPC3124FI111W 3759	"P" Option N/A	RPC3124FI111G 3759	"M" Option N/A
2 Select a finish <a href="#">View finish details</a>		WAC WRC WIC WHC WOC WEW WGW WBW WSW WNW		GAC GIC GHC GOC GEW GNW	
3 Select a edge <a href="#">View edge details</a>		 Richmond  Classic		 Richmond  Classic	
4 Select hardware <a href="#">View hardware details</a>		 PL-4 Antique Brass  PL-5 Antique Brass PL-50 Brushed Pewter		 PL-4 Antique Brass  PL-5 Antique Brass PL-50 Brushed Pewter	

[View statement of line](#)

## Product features.

- Anti-tilt safety drawer lock
- Full extension drawers - Full extension drawers - locking
- Legal/Double letter filing
- Soft close suspension drawer(s)

### NOTES

- Unit not designed for open plan use, standard with unfinished back.  
Select OPB Option for Open Plan application.

## Options.

### DRAWER

- P33: Wood Drawer Upgrade - \$45 per drawer

### FLUSH CUT

- FC-B: Flush Unit Both Sides(Facing) for Ganging - \$100
- FC-L: Flush Unit Left (Facing) for Ganging - \$100
- FC-R: Flush Unit Right(Facing) for Ganging - \$100

### OPEN PLAN – FINISHED BACK

- OPB: "W" "G" Style - Modify Unit for Open Plan Application - \$295



# Richmond park.

Workstation Credenza  
File / File

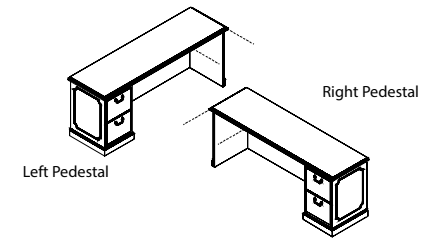

## 1 Select a model

w" x d" x h"

weight	Standard Veneer Top Standard Veneer Chassis	Premium Veneer Top Premium Veneer Chassis	High Pressure Laminate Top Veneer Chassis	Thermally Fused Laminate Top Thermally Fused Laminate Chassis
<b>Left Pedestal</b>				
89 x 24 x 30	200 RPC8924CA086W 3039	"P" Option N/A	RPC8924CA086G 3039	"M" Option N/A
72 x 24 x 30	180 RPC7224CA086W 2737	"P" Option N/A	RPC7224CA086G 2737	"M" Option N/A
66 x 24 x 30	170 RPC6624CA086W 2654	"P" Option N/A	RPC6624CA086G 2654	"M" Option N/A
<b>Right Pedestal</b>				
89 x 24 x 30	200 RPC8924CA087W 3039	"P" Option N/A	RPC8924CA087G 3039	"M" Option N/A
72 x 24 x 30	180 RPC7224CA087W 2737	"P" Option N/A	RPC7224CA087G 2737	"M" Option N/A
66 x 24 x 30	170 RPC6624CA087W 2654	"P" Option N/A	RPC6624CA087G 2654	"M" Option N/A

[View statement of line](#)

## 2 Select a finish

[View finish details](#)

- WAC
- WRC
- WIC
- WHC
- WOC
- WEW
- WGW
- WBW
- WSW
- WNW

- GAC
- GIC
- GHC
- GOC
- GEW
- GNW

## 3 Select a edge

[View edge details](#)



## 4 Select hardware

[View hardware details](#)



## Product features.

- Drawer fronts w/ profile edges
- File/File
- Full fixed modesty
- Full extension drawers - locking
- Soft close suspension drawer(s)

### NOTES

- Unit not designed for open plan use, standard with unfinished back.
- Select OPB Option for Open Plan application.

## Options.

### ACCESSORIES

- K28: Articulating Keyboard w/ Mouse pad - \$390

### DRAWER

- P6: Modify File/File to Box/Box/File - \$55 per pedestal
- P33: Wood Drawer Upgrade - \$45 per drawer
- P40B: extra Box/Box/File or File/File to Kneespace - \$1,025

### FLUSH CUT

- FC-B: Flush Unit Both Sides(Facing) for Ganging - \$100
- FC-L: Flush Unit Left (Facing) for Ganging - \$100
- FC-R: Flush Unit Right(Facing) for Ganging - \$100

### GROMMETS (STANDARD LOCATION)

- Specify Color - \$50 ea.
- Black: TM30-C (Center)
- Silver: TM31-C (Center)
- Antique Brass: TM33-C (Center)

### GROMMETS (NON-STANDARD LOCATION)

- Provide drawing w/ Grommet Location and Specify Color - \$95 ea.
- Black: TM30-NS
- Silver: TM31-NS
- Antique Brass: TM33-NS

### Modesty

- M34T: "W" "G" Style Drop Door Tech Modesty - \$130
- M51: Open Back Modesty with Wire Mgmt Rail - Deduct \$95

### Molding

- DSM2: Delete molding - Deduct \$50

### Open Plan – Finished Back

- OPB: "W" "G" Style - Modify Unit for Open Plan Application - \$295

# Richmond park.

Workstation Credenza  
Lateral File

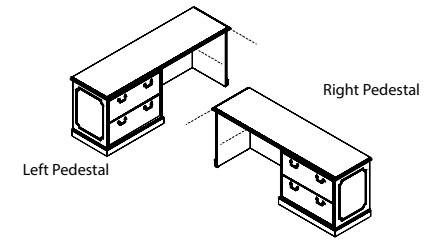

## 1 Select a model

w" x d" x h"

weight	Standard Veneer Top		Premium Veneer Top		High Pressure Laminate Top		Thermally Fused Laminate Top	
	Standard Veneer Chassis		Premium Veneer Chassis		Veneer Chassis		Thermally Fused Laminate Chassis	
<b>Left Pedestal</b>								
95 x 24 x 30	250	RPC9524CA066W	3457	"P" Option N/A	RPC9524CA066G	3457	"M" Option N/A	
89 x 24 x 30	240	RPC8924CA066W	3160	"P" Option N/A	RPC8924CA066G	3160	"M" Option N/A	
72 x 24 x 30	220	RPC7224CA066W	2859	"P" Option N/A	RPC7224CA066G	2859	"M" Option N/A	
66 x 24 x 30	210	RPC6624CA066W	2773	"P" Option N/A	RPC6624CA066G	2773	"M" Option N/A	
<b>Right Pedestal</b>								
95 x 24 x 30	250	RPC9524CA067W	3457	"P" Option N/A	RPC9524CA067G	3457	"M" Option N/A	
89 x 24 x 30	240	RPC8924CA067W	3160	"P" Option N/A	RPC8924CA067G	3160	"M" Option N/A	
72 x 24 x 30	220	RPC7224CA067W	2859	"P" Option N/A	RPC7224CA067G	2859	"M" Option N/A	
66 x 24 x 30	210	RPC6624CA067W	2773	"P" Option N/A	RPC6624CA067G	2773	"M" Option N/A	

[View statement of line](#)

## 2 Select a finish

[View finish details](#)

WAC  
WRC  
WIC  
WHC  
WOC  
WEW  
WGW  
WBW  
WSW  
WNW

GAC  
GIC  
GHC  
GOC  
GEW  
GNW

## 3 Select a edge

[View edge details](#)



## 4 Select hardware

[View hardware details](#)



## Product features.

- Drawer fronts w/ profile edges
- Full fixed modesty
- Full extension drawers - locking
- Soft close suspension drawer(s)

### NOTES

- Keyboard not available on 66" and 72"
- Unit not designed for open plan use, standard with unfinished back. Select OPB Option for Open Plan application.

## Options.

### ACCESSORIES

- K28: Articulating Keyboard w/ Mouse pad - \$390

### DRAWER

- P33: Wood Drawer Upgrade - \$45 per drawer
- P40B: extra Box/Box/File or File/File to Kneespace - \$1,025

### FLUSH CUT

- FC-B: Flush Unit Both Sides(Facing) for Ganging - \$100
- FC-L: Flush Unit Left (Facing) for Ganging - \$100
- FC-R: Flush Unit Right(Facing) for Ganging - \$100

### GROMMETS (STANDARD LOCATION)

- Specify Color - \$50 ea.
- Black: TM30-C (Center)
  - Silver: TM31-C (Center)
  - Antique Brass: TM33-C (Center)

### GROMMETS (NON-STANDARD LOCATION)

- Provide drawing w/ Grommet Location and Specify Color - \$95 ea.
- Black: TM30-NS
  - Silver: TM31-NS
  - Antique Brass: TM33-NS
- Modesty
- M34T: "W" "G" Style Drop Door Tech Modesty - \$130
  - M51: Open Back Modesty with Wire Mgmt Rail - Deduct \$95
- Molding
- DSM2: Delete molding - Deduct \$50
- Open Plan – Finished Back
- OPB: "W" "G" Style - Modify Unit for Open Plan Application - \$295

# Richmond park.

Overhead Consoles  
Freestanding - Panel Door

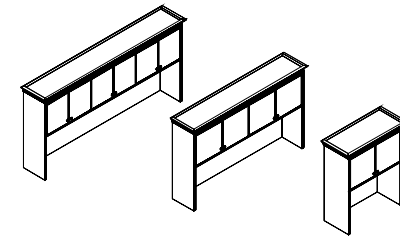

## 1 Select a model w" x d" x h"

weight	Standard Veneer Top		Premium Veneer Top		High Pressure Laminate Top		Thermally Fused Laminate Top	
	Standard Veneer Chassis		Premium Veneer Chassis		Veneer Chassis		Thermally Fused Laminate Chassis	
<b>6 Door / 3 Section</b>								
95 x 15 x 44	315	RPC9544OH325W 4195	"P" Option N/A		"G" Option N/A		"M" Option N/A	
89 x 15 x 44	285	RPC8944OH325W 3766	"P" Option N/A		"G" Option N/A		"M" Option N/A	
<b>4 Door / 2 Section</b>								
85 x 15 x 44	275	RPC8544OH325W 3622	"P" Option N/A		"G" Option N/A		"M" Option N/A	
78 x 15 x 44	255	RPC7844OH325W 3479	"P" Option N/A		"G" Option N/A		"M" Option N/A	
72 x 15 x 44	240	RPC7244OH325W 3193	"P" Option N/A		"G" Option N/A		"M" Option N/A	
66 x 15 x 44	225	RPC6644OH325W 2823	"P" Option N/A		"G" Option N/A		"M" Option N/A	
60 x 15 x 44	210	RPC6044OH325W 3036	"P" Option N/A		"G" Option N/A		"M" Option N/A	
<b>2 Door / 1 Section</b>								
37 x 15 x 44	120	RPC3744OH325W 2047	"P" Option N/A		"G" Option N/A		"M" Option N/A	
31 x 15 x 44	105	RPC3144OH325W 2021	"P" Option N/A		"G" Option N/A		"M" Option N/A	

[View statement of line](#)

## 2 Select a finish [View finish details](#)

- WAC
- WRC
- WIC
- WHC
- WOC
- WEW
- WGW
- WBW
- WSW
- WNW

## 3 Select a edge [View edge details](#)

- Edge
- N/A

## 4 Select hardware [View hardware details](#)



## Product features.

- 2.5" Cornice top
- Door fronts w/ profile edges
- Interior cabinet depth 12.5"
- Scalloped edge doors
- Top profile shaped 3 sides
- Veneer back

### NOTES

- Unit has black back panel and is not designed for Open Plan use.
- Select OPB Option for Open Plan application

## Options.

### DOOR

- D2: Door Lock - \$100 per door
- D6: Delete Doors - n/c
- D9SC: Soft Close Door Hinges - \$20 per door

### FLUSH CUT

- FC-B: Flush Unit Both Sides(Facing) for Ganging - \$100
- FC-L: Flush Unit Left (Facing) for Ganging - \$100
- FC-R: Flush Unit Right(Facing) for Ganging - \$100

### GROMMETS (VERTICAL SURFACE)

- Standard Location - \$50 ea.
- Black Plastic Vertical Surface: TM50-C (Bottom Center)
- Non-Standard Location - \$95 ea.
- Black Plastic Vertical Surface: TM50-NS

### OPEN PLAN – FINISHED BACK

- OPB: "W" "G" Style - Modify Unit for Open Plan Application - \$395

### TASK LIGHTING (RECESSED)

- Overhead tasklight cord is located on the right facing side. If the opposite location is required please contact customer service.
- LT-LED24R: 24" LED Task light - \$190
- LT-LED48R: 48" LED Task light - \$245
- LT-LED60R: 60" LED Task light - \$310
- LT-LED72R: 72" LED Task light - \$335

# Richmond park tackboards.

Overhead tackboard  
Full width tackboards

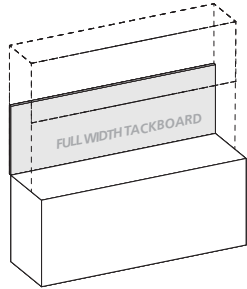

Product Width	Panel Dimension	SKU	COM	1	2	3	4	5	6	7	8	9	10	11/L1	12	13/L2
95	91 x .75 x 21	FTOC9121	379	480	531	582	633	684	735	786	837	888	939	990	1041	1143
89	85 x .75 x 21	FTOC8521	358	449	497	545	593	641	689	737	785	833	881	929	977	1073
85	81 x .75 x 21	FTOC8121	336	428	474	520	566	612	658	704	750	796	842	888	934	1026
78	74 x .75 x 21	FTOC7421	309	392	435	478	521	564	607	650	693	736	779	822	865	951
72	68 x .75 x 21	FTOC6821	282	361	401	441	481	521	561	601	641	681	721	761	801	881
66	62 x .75 x 21	FTOC6221	256	330	366	402	438	474	510	546	582	618	654	690	726	798
60	56 x .75 x 21	FTOC5621	234	299	331	363	395	427	459	491	523	555	587	619	651	715
49	45 x .75 x 21	FTOC4521	187	242	269	296	323	350	377	404	431	458	485	512	539	593
37	33 x .75 x 21	FTOC3321	141	180	200	220	240	260	280	300	320	340	360	380	400	440
31	27 x .75 x 21	FTOC2721	112	149	166	183	200	217	234	251	268	285	302	319	336	370

**Standard Features**

- Constructed of .5" thick fiberboard
- Fabric is precisely aligned and fitted to the tackboard
- Adhered to the rigid hardboard with staples
- Hung with Z-Strip mounting system

**Notes**

- Fabric Tack Panels are raised 3" from bottom edge when TM50 grommet is ordered

Overhead tackboard  
Half width tackboards

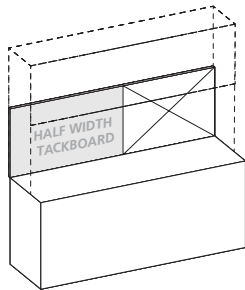

95 Half Width	45.5 x .75 x 21	FTOC4521	189	240	266	292	318	344	370	396	422	448	474	500	526	578
89 Half Width	42.5 x .75 x 21	FTOC4221	179	225	249	273	297	321	345	369	393	417	441	465	489	537
85 Half Width	40.5 x .75 x 21	FTOC4021	168	214	237	260	283	306	329	352	375	398	421	444	467	513
78 Half Width	37 x .75 x 21	FTOC3721	155	196	217	238	259	280	301	322	343	364	385	406	427	469
72 Half Width	34 x .75 x 21	FTOC3421	141	180	200	220	240	260	280	300	320	340	360	380	400	440
66 Half Width	31 x .75 x 21	FTOC3121	128	165	183	201	219	237	255	273	291	309	327	345	363	399

**Standard Features**

- Constructed of .5" thick fiberboard
- Fabric is precisely aligned and fitted to the tackboard
- Adhered to the rigid hardboard with staples
- Hung with Z-Strip mounting system

**Notes**

- Half width tackboards can be specified and combined with a Veneer Panel, Marker Board, Slat Wall or Glass Board. See "Half Width" items under product width.
- Specify right or left facing tackboard
- Fabric Tack Panels are raised 3" from bottom edge when TM50 grommet is ordered.

## Richmond park tackboards.

Overhead dry marker board  
Full width dry marker board

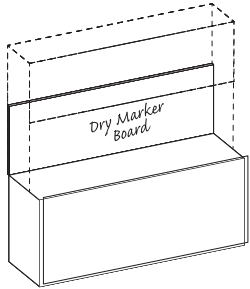

Product Width	Panel Dimension	SKU	List
95	91 x .5 x 21	DMOC9121	1136
89	85 x .5 x 21	DMOC8521	1061
85	81 x .5 x 21	DMOC8121	1011
78	74 x .5 x 21	DMOC7421	924
72	68 x .5 x 21	DMOC6821	849
66	62 x .5 x 21	DMOC6221	774
60	56 x .5 x 21	DMOC5621	699
49	45 x .5 x 21	DMOC4521	587
37	33 x .5 x 21	DMOC3321	437
31	27 x .5 x 21	DMOC2721	337

### Standard Features

- Dry marker panel has edge trim molding
- Standard magnetic surface
- Hung with Z-Strip mounting system

Overhead dry marker board  
Half width dry marker board

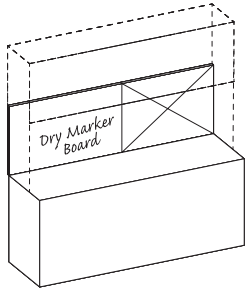

Product Width	Panel Dimension	SKU	List
95 Half Width	45.5 x .5 x 21	DMOC4521	555
89 Half Width	42.5 x .5 x 21	DMOC4221	518
85 Half Width	40.5 x .5 x 21	DMOC4021	493
78 Half Width	37 x .5 x 21	DMOC3721	449
72 Half Width	34 x .5 x 21	DMOC3421	437
66 Half Width	31 x .5 x 21	DMOC3121	374

### Standard Features

- Dry marker panel has edge trim molding
- Standard magnetic surface
- Hung with Z-Strip mounting system

### Notes

- Half width dry marker boards can be specified and combined with a Tackboard, Veneer Panel, Slat Wall or Glass Board. See "Half Width" items under product width.
- Specify right or left facing dry marker board

## Richmond park tackboards.

### Overhead glassboard Full width glassboards

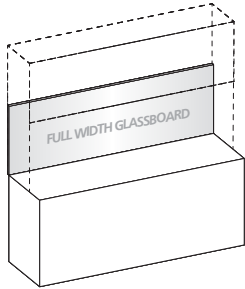

Product Width	Panel Dimension	SKU	List
95	91 x .5 x 21	GBOC9121	2382
89	85 x .5 x 21	GBOC8521	2236
85	81 x .5 x 21	GBOC8121	2138
78	74 x .5 x 21	GBOC7421	1969
72	68 x .5 x 21	GBOC6821	1822
66	62 x .5 x 21	GBOC6221	1676
60	56 x .5 x 21	GBOC5621	1531
49	45 x .5 x 21	GBOC4521	1264
37	33 x .5 x 21	GBOC3321	972
31	27 x .5 x 21	GBOC2721	826

**Standard Features**  
- 4 mm tempered glass

**Notes**  
- Earth magnets are required to hold items securely in place  
- Hung with Z-Strip mounting system  
- Use glass cleaner or alcohol to clean  
- Standard dry erase markers may be used

### Overhead glassboard Half width glassboards

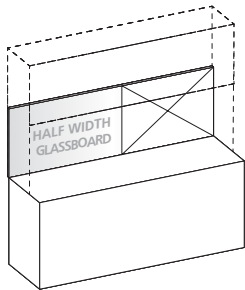

Product Width	Panel Dimension	SKU	List
95 Half Width	45.5 x .5 x 21	GBOC4521	1251
89 Half Width	42.5 x .5 x 21	GBOC4221	1178
85 Half Width	40.5 x .5 x 21	GBOC4021	1129
78 Half Width	37 x .5 x 21	GBOC3721	985
72 Half Width	34 x .5 x 21	GBOC3421	972
66 Half Width	31 x .5 x 21	GBOC3121	899

**Standard Features**  
- 4 mm tempered glass  
- Hung with Z-Strip mounting system

**Notes**  
- Half width glassboards can be specified and combined with a Tackboard, Veneer panel, Marker Board or Slat Wall. See "Half Width" items under product width.  
- Must specify Right or left facing glassboard  
- Use glass cleaner or alcohol to clean  
- Standard dry erase markers may be used  
- Earth magnets are required to hold items securely in place

## Richmond park tackboards.

Overhead slat wall  
Half width slat wall

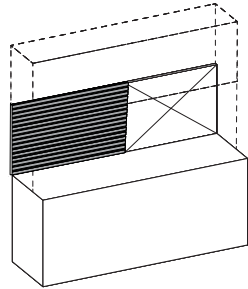

Product Width	Panel Dimension	SKU	List
95 Half Width	45.5 x .5 x 21	SWOC4521	463
89 Half Width	42.5 x .5 x 21	SWOC4221	432
85 Half Width	40.5 x .5 x 21	SWOC4021	411
78 Half Width	37 x .5 x 21	SWOC3721	374
72 Half Width	34 x .5 x 21	SWOC3421	343
66 Half Width	31 x .5 x 21	SWOC3121	312

### Standard Features

- Available in silver or black
- Hung with Z-Strip mounting system

### Notes

- Half width slat walls can be specified and combined with a Tackboard, Veneer panel, Marker Board or Glassboard. See "Half Width" items under product width.
- Specify right or left facing slat wall
- For use on 42"/43" height consoles
- Specify right or left facing slat wall

# Richmond park.

Wall Hung Overheads  
Panel Doors - 6/4/2 Door

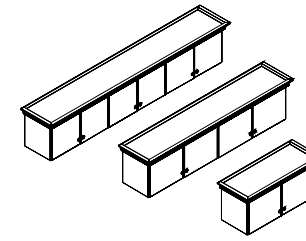

## 1 Select a model

w" x d" x h"

weight	Standard Veneer Top		Premium Veneer Top	High Pressure Laminate Top	Thermally Fused Laminate Top
	Standard Veneer Chassis		Premium Veneer Chassis	Veneer Chassis	Thermally Fused Laminate Chassis
<b>6 Door / 3 Section</b>					
95 x 15 x 20	200	RPC9520WH330W 4124	"P" Option N/A	"G" Option N/A	"M" Option N/A
89 x 15 x 20	185	RPC8920WH330W 3980	"P" Option N/A	"G" Option N/A	"M" Option N/A
<b>4 Door / 2 Section</b>					
85 x 15 x 20	175	RPC8520WH330W 3517	"P" Option N/A	"G" Option N/A	"M" Option N/A
78 x 15 x 20	165	RPC7820WH330W 3371	"P" Option N/A	"G" Option N/A	"M" Option N/A
72 x 15 x 20	155	RPC7220WH330W 3229	"P" Option N/A	"G" Option N/A	"M" Option N/A
66 x 15 x 20	140	RPC6620WH330W 3025	"P" Option N/A	"G" Option N/A	"M" Option N/A
60 x 15 x 20	130	RPC6020WH330W 2759	"P" Option N/A	"G" Option N/A	"M" Option N/A
49 x 15 x 20	115	RPC4920WH330W 2445	"P" Option N/A	"G" Option N/A	"M" Option N/A
<b>2 Door</b>					
37 x 15 x 20	75	RPC3720WH330W 1887	"P" Option N/A	"G" Option N/A	"M" Option N/A
31 x 15 x 20	65	RPC3120WH330W 1852	"P" Option N/A	"G" Option N/A	"M" Option N/A

[View statement of line](#)

## Product features.

- 2.5" Cornice top
- Door fronts w/ profile edges
- Interior cabinet depth 12"
- Mounting wall rail included
- Scalloped edge doors
- Top profile shaped 3 sides
- Veneer interior

### NOTES

- Proper installation is critical to ensure safety from possible falling cabinets. The factory assumes no liability for damage or injury from the following: installation into non-load bearing or unlevel walls. Improper fasteners used in installation. Overloading of cabinets resulting in failures of wall and surrounding structures, fasteners, or cabinet construction. Misuse of cabinets for intended purposes.

## Options.

### DOOR

- D2: Door Lock - \$100 per door
- D6: Delete Doors - n/c
- D9SC: Soft Close Door Hinges - \$20 per door

### FLUSH CUT

- FC-B: Flush Unit Both Sides(Facing) for Ganging - \$100
- FC-L: Flush Unit Left (Facing) for Ganging - \$100
- FC-R: Flush Unit Right(Facing) for Ganging - \$100

### TASK LIGHTING (RECESSED)

Overhead tasklight cord is located on the right facing side. If the opposite location is required please contact customer service.

- LT-LED24R: 24" LED Task light - \$190
- LT-LED48R: 48" LED Task light - \$245
- LT-LED60R: 60" LED Task light - \$310
- LT-LED72R: 72" LED Task light - \$335
- LC24: Linking Task light cable - \$25

## 2 Select a finish

[View finish details](#)

- WAC
- WRC
- WIC
- WHC
- WOC
- WEW
- WGW
- WBW
- WSW
- WNW

## 3 Select a edge

[View edge details](#)

- Edge
- N/A

## 4 Select hardware

[View hardware details](#)





## Richmond park tackboards.

### Wall hung tackboards Full width tackboards

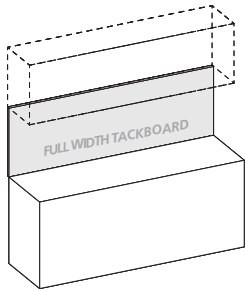

Product Width	Panel Dimension	SKU	COM	1	2	3	4	5	6	7	8	9	10	11/L1	12	13/L2
95	93 x .75 x 24	FTWH9324	465	576	627	678	729	780	831	882	933	984	1035	1086	1137	1239
89	87 x .75 x 24	FTWH8724	448	539	587	635	683	731	779	827	875	923	971	1019	1067	1163
85	83 x .75 x 24	FTWH8324	422	514	560	606	652	698	744	790	836	882	928	974	1020	1112
78	76 x .75 x 24	FTWH7624	388	471	514	557	600	643	686	729	772	815	858	901	944	1030
72	70 x .75 x 24	FTWH7024	355	434	474	514	554	594	634	674	714	754	794	834	874	954
66	64 x .75 x 24	FTWH6424	322	396	432	468	504	540	576	612	648	684	720	756	792	864
60	58 x .75 x 24	FTWH5824	294	359	391	423	455	487	519	551	583	615	647	679	711	775
49	47 x .75 x 24	FTWH4724	236	291	318	345	372	399	426	453	480	507	534	561	588	642
37	35 x .75 x 24	FTWH3524	176	217	237	257	277	297	317	337	357	377	397	417	437	477
31	29 x .75 x 24	FTWH2924	142	179	196	213	230	247	264	281	298	315	332	349	366	400

#### Standard Features

- Constructed of .5" thick fiberboard
- Fabric is precisely aligned and fitted to the tackboard
- Adhered to the rigid hardboard with staples

- Hung with Z-Strip mounting system

### Wall hung tackboards Half width tackboards

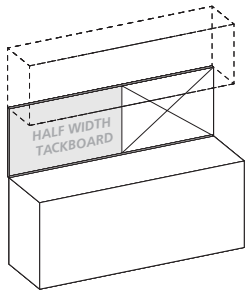

Product Width	Panel Dimension	SKU	COM	1	2	3	4	5	6	7	8	9	10	11/L1	12	13/L2
95 Half Width	46.5 x .75 x 24	FTWH4624	233	288	313	338	363	388	413	438	463	488	513	538	563	613
89 Half Width	43.5 x .75 x 24	FTWH4324	225	270	294	318	342	366	390	414	438	462	486	510	534	582
85 Half Width	41.5 x .75 x 24	FTWH4124	211	257	280	303	326	349	372	395	418	441	464	487	510	556
78 Half Width	38 x .75 x 24	FTWH3824	194	235	256	277	298	319	340	361	382	403	424	445	466	508
72 Half Width	35 x .75 x 24	FTWH3524	178	217	237	257	277	297	317	337	357	377	397	417	437	477
66 Half Width	32 x .75 x 24	FTWH3224	161	198	216	234	252	270	288	306	324	342	360	378	396	432

#### Standard Features

- Constructed of .5" thick fiberboard
- Fabric is precisely aligned and fitted to the tackboard
- Adhered to the rigid hardboard with staples
- Hung with Z-Strip mounting system

#### Notes

- Half width tackboards can be specified and combined with a Veneer Panel, Marker Board, Slat Wall or Glass Board. See "Half Width" items under product width.
- Specify right or left facing tackboard

## Richmond park tackboards.

Wall hung dry marker board  
Full width dry marker board

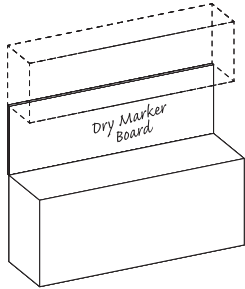

Product Width	Panel Dimension	SKU	List
95	93 x .75 x 24	DMWH9324	1161
89	87 x .75 x 24	DMWH8724	1086
85	83 x .75 x 24	DMWH8324	1023
78	76 x .5 x 24	DMWH7624	948
72	70 x .75 x 24	DMWH7024	874
66	64 x .75 x 24	DMWH6424	799
60	58 x .75 x 24	DMWH5824	724
49	47 x .75 x 24	DMWH4724	587
37	35 x .75 x 24	DMWH3524	437
31	29 x .75 x 24	DMWH2924	362

### Standard Features

- Dry marker panel has edge trim molding
- Standard magnetic surface
- Hung with Z-Strip mounting system

Wall hung dry marker board  
Half width dry marker board

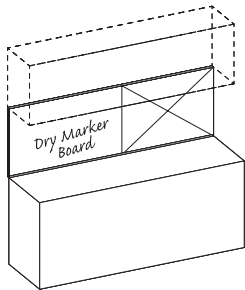

Product Width	Panel Dimension	SKU	List
95 Half Width	46.5 x .75 x 24	DMWH4624	580
89 Half Width	43.5 x .75 x 24	DMWH4324	543
85 Half Width	41.5 x .75 x 24	DMWH4124	518
78 Half Width	38 x .75 x 24	DMWH3824	474
72 Half Width	35 x .75 x 24	DMWH3524	437
66 Half Width	32 x .75 x 24	DMWH3224	399

### Standard Features

- Dry marker panel has edge trim molding
- Standard magnetic surface
- Hung with Z-Strip mounting system

### Notes

- Half width dry marker boards can be specified and combined with a Tackboard, Veneer Panel, Slat Wall or Glass Board. See "Half Width" items under product width.
- Specify right or left facing dry marker board

## Richmond park tackboards.

Wall hung veneer panel  
Full width veneer panel

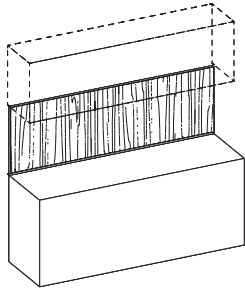

Product Width	Panel Dimension	SKU	List
95	93 x .75 x 24	VPWH9324	967
89	87 x .75 x 24	VPWH8724	905
85	83 x .75 x 24	VPWH8324	853
78	76 x .75 x 24	VPWH7624	790
72	70 x .75 x 24	VPWH7024	728
66	64 x .75 x 24	VPWH6424	666
60	58 x .75 x 24	VPWH5824	603
49	47 x .75 x 24	VPWH4724	489
37	35 x .75 x 24	VPWH3524	364
31	29 x .75 x 24	VPWH2924	302

### Standard Features

- Veneer edges

### Notes

- Vertical wire channels on back for task light cords
- Steel mounting wall channel is recessed for flush mounting
- Hung with Z-Strip mounting system
- Can be used with or without overhead cabinet
- Required for other accessory panels

Wall hung veneer panel  
Half width veneer panel

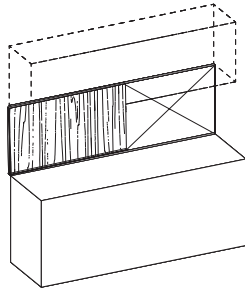

Product Width	Panel Dimension	SKU	List
95 Half Width	46.5 x .75 x 24	VPWH4624	484
89 Half Width	43.5 x .75 x 24	VPWH4324	452
85 Half Width	41.5 x .75 x 24	VPWH4124	432
78 Half Width	38 x .75 x 24	VPWH3824	395
72 Half Width	35 x .75 x 24	VPWH3524	364
66 Half Width	32 x .75 x 24	VPWH3224	333

### Standard Features

- Veneer edges
- Vertical wire channels on back for task light cords
- Steel mounting wall channel is recessed for flush mounting
- Hung with Z-Strip mounting system

### Notes

- Half width veneer panels can be specified and combined with a Tackboard, Marker Board, Slat Wall or Glass Board. See "Half Width" items under product width.
- Specify right or left facing veneer panel
- Can be used with or without overhead cabinet
- Required for other accessory panels

## Richmond park tackboards.

Wall hung glassboard  
Full width glassboards

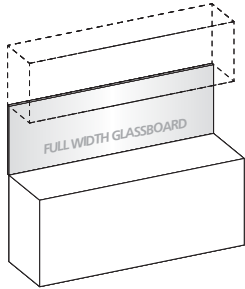

Product Width	Panel Dimension	SKU	List
95	93 x .75 x 24	GBWH9324	2753
89	87 x .75 x 24	GBWH8724	2586
85	83 x .75 x 24	GBWH8324	2475
78	76 x .75 x 24	GBWH7624	2281
72	70 x .75 x 24	GBWH7024	2114
66	64 x .75 x 24	GBWH6424	1948
60	58 x .75 x 24	GBWH5824	1780
49	47 x .75 x 24	GBWH4724	1476
37	35 x .75 x 24	GBWH3524	1142
31	29 x .75 x 24	GBWH2924	976

Standard Features  
- 4 mm tempered glass

Notes  
- Use glass cleaner or alcohol to clean  
- Standard dry erase markers may be used  
- Earth magnets are required to hold items securely in place  
- Hung with Z-Strip mounting system

Wall hung glassboard  
Half width glassboards

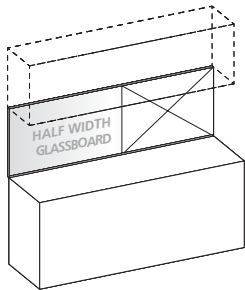

Product Width	Panel Dimension	SKU	List
95 Half Width	46.5 x .75 x 24	GBWH4624	1461
89 Half Width	43.5 x .75 x 24	GBWH4324	1378
85 Half Width	41.5 x .75 x 24	GBWH4124	1323
78 Half Width	38 x .75 x 24	GBWH3824	1232
72 Half Width	35 x .75 x 24	GBWH3524	1142
66 Half Width	32 x .75 x 24	GBWH3224	1059

Standard Features  
- 4 mm tempered glass  
- Hung with Z-Strip mounting system

Notes  
- Half width glassboards can be specified and combined with a Tackboard, Veneer panel, Marker Board or Slat Wall. See "Half Width" items under product width.  
- Specify right or left facing glassboard  
- Use glass cleaner or alcohol to clean  
- Standard dry erase markers may be used  
- Earth magnets are required to hold items securely in place

# Richmond park tackboards.

Wall hung slat wall  
*Half width slat wall*

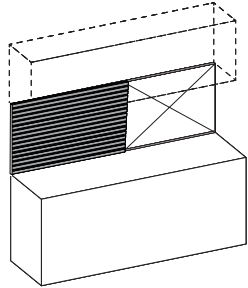

Product Width	Panel Dimension	SKU	List
95 Half Width	46.5 x .75 x 24	SWWH4624	484
89 Half Width	43.5 x .75 x 24	SWWH4324	452
85 Half Width	41.5 x .75 x 24	SWWH4124	432
78 Half Width	38 x .75 x 24	SWWH3824	395
72 Half Width	35 x .75 x 24	SWWH3524	364
66 Half Width	32 x .75 x 24	SWWH3224	333

### Standard Features

- Available in silver or black
- Hung with Z-Strip mounting system

### Notes

- Half width slat walls can be specified and combined with a Tackboard, Veneer panel, Marker Board or Glassboard. See "Half Width" items under product width.
- Specify right or left facing slat wall
- For use on 42"/43" height consoles

# Richmond park.

Assembled Overhead Bookcase / Hutch

Panel Door

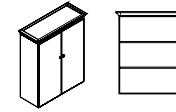

1 Select a model		Standard Veneer Top Standard Veneer Chassis		Premium Veneer Top Premium Veneer Chassis	High Pressure Laminate Top Veneer Chassis	Thermally Fused Laminate Top Thermally Fused Laminate Chassis
w" x d" x h"	weight					
37 x 15 x 44.5	140	RPC3744OH383W	2299	"P" Option N/A	"G" Option N/A	"M" Option N/A
31 x 15 x 44.5	130	RPC3144OH383W	2196	"P" Option N/A	"G" Option N/A	"M" Option N/A



  

2 Select a finish	
<a href="#">View finish details</a>	WAC WRC WIC WHC WOC WEW WGW WBW WSW WNW

3 Select a edge	
<a href="#">View edge details</a>	Edge N/A

4 Select hardware	
<a href="#">View hardware details</a>	 DK-114 Brushed Pewter  DK-4 Antique Brass

[View statement of line](#)

## Product features.

- 2 Adjustable shelves
- 2.5" Cornice top
- Doors w/ profile edges
- Interior shelf depth 12"
- Top profile shaped 3 sides

### NOTES

- Unit has black back panel and is not designed for Open Plan use.
- Select OPB Option for Open Plan application

## Options.

### DOOR

- D2: Door Lock - \$100 per door
- D6: Delete Doors - n/c
- D9SC: Soft Close Door Hinges - \$20 per door

### FLUSH CUT

- FC-B: Flush Unit Both Sides(Facing) for Ganging - \$100
- FC-L: Flush Unit Left (Facing) for Ganging - \$100
- FC-R: Flush Unit Right(Facing) for Ganging - \$100

### OPEN PLAN – FINISHED BACK

- OPB: "W" "G" Style - Modify Unit for Open Plan Application - \$395

### SHELF

- GS14F: Replace Standard Shelves with Glass Shelves - \$90 per shelf
- S714F: Heavy Duty Lumber 1" Shelves - \$80 per shelf

# Richmond park.

Assembled Overhead Bookcase / Hutch  
Wood Frame Door W/ beveled glass Insert

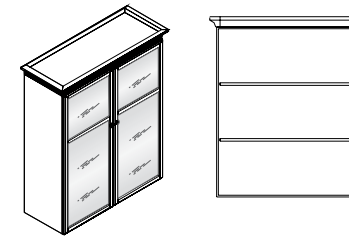

[View statement of line](#)

1 Select a model w" x d" x h"	weight	Standard Veneer Top	Premium Veneer Top	High Pressure Laminate Top	Thermally Fused Laminate Top
		Standard Veneer Chassis	Premium Veneer Chassis	Veneer Chassis	Thermally Fused Laminate Chassis
37 x 15 x 44.5	140	RPC3744OH381W 2736	"P" Option N/A	"G" Option N/A	"M" Option N/A
31 x 15 x 44.5	130	RPC3144OH381W 2633	"P" Option N/A	"G" Option N/A	"M" Option N/A



  

2 Select a finish <a href="#">View finish details</a>	
WAC	
WRC	
WIC	
WHC	
WOC	
WEW	
WGW	
WBW	
WSW	
WNW	

3 Select a edge <a href="#">View edge details</a>	
Edge	
N/A	

4 Select hardware <a href="#">View hardware details</a>		
	DK-114 Brushed Pewter	
		DK-4 Antique Brass

## Product features.

- 2 Adjustable shelves
- 2.5" Cornice top
- Doors w/ profile edges
- Interior shelf depth 12"
- Top profile shaped 3 sides
- Wood frame doors w/ beveled glass inserts

### NOTES

- Unit has black back panel and is not designed for Open Plan use.
- Select OPB Option for Open Plan application

## Options.

### DOOR

- D2-G: Door Lock for Glass doors - \$205 per door
- D9SC: Soft Close Door Hinges - \$20 per door

### FLUSH CUT

- FC-B: Flush Unit Both Sides(Facing) for Ganging - \$100
- FC-L: Flush Unit Left (Facing) for Ganging - \$100
- FC-R: Flush Unit Right(Facing) for Ganging - \$100

### INTERIOR CABINET LIGHTING

- LEDPK starter kit includes Infeed, 1 Puck Interior Light and the ability to daisy chain up to 6 total Puck Lights
- LEDPK: LED Puck Starter Kit - \$310
- PK: 1 LED Interior Light - \$130

### OPEN PLAN – FINISHED BACK

- OPB: "W" "G" Style - Modify Unit for Open Plan Application - \$395

### SHELF

- GS14F: Replace Standard Shelves with Glass Shelves - \$90 per shelf
- S714F: Heavy Duty Lumber 1" Shelves - \$80 per shelf

# Richmond park.

Vertical Half Towers  
Wardrobe / Storage

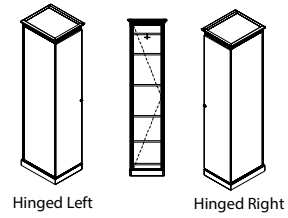



1 Select a model w" x d" x h"		weight	Standard Veneer Top Standard Veneer Chassis	Premium Veneer Top Premium Veneer Chassis	High Pressure Laminate Top Veneer Chassis	Thermally Fused Laminate Top Thermally Fused Laminate Chassis
<b>Hinged Left</b> 17.75 x 24 x 77		160	RPC1777TW283W 3111	"P" Option N/A	"G" Option N/A	"M" Option N/A
<b>Hinged Right</b> 17.75 x 24 x 77		160	RPC1777TW284W 3111	"P" Option N/A	"G" Option N/A	"M" Option N/A

2 Select a finish <i>View finish details</i>	WAC	WRC	WIC	WHC	WOC	WEW	WGW	WBW	WSW	WNW
3 Select a edge <i>View edge details</i>	Edge	N/A								

4 Select hardware <i>View hardware details</i>	 DK-114 Brushed Pewter	 DK-4 Antique Brass

*View statement of line*

## Product features.

- 2.5" Cornice top
- 3 Adjustable shelves / 1 Fixed
- 3.5" Traditional base
- Door fronts w/ profile edges
- Top profile shaped 3 sides
- Wardrobe w/ coat rod & hook

**NOTES**

- Adjustable shelves shaded
- Unit has black back panel and is not designed for Open Plan use.  
Select OPB Option for Open Plan application

## Options.

**DOOR**

- D2: Door Lock - \$100 per door
- D9SC: Soft Close Door Hinges - \$20 per door

**FLUSH CUT**

- FC-B: Flush Unit Both Sides(Facing) for Ganging - \$100
- FC-L: Flush Unit Left (Facing) for Ganging - \$100
- FC-R: Flush Unit Right(Facing) for Ganging - \$100

**OPEN PLAN – FINISHED BACK**

- OPB: "W" "G" Style - Modify Unit for Open Plan Application - \$395





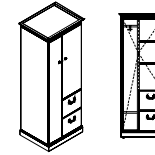

# Richmond park.

Vertical Half Towers

Storage / File/File With Mini-Wardrobe



1 Select a model w" x d" x h"		weight	Standard Veneer Top Standard Veneer Chassis	Premium Veneer Top Premium Veneer Chassis	High Pressure Laminate Top Veneer Chassis	Thermally Fused Laminate Top Thermally Fused Laminate Chassis
<b>Left Wardrobe</b> 28 x 24 x 77		220	RPC2877TW293W 4830	"P" Option N/A	"G" Option N/A	"M" Option N/A
<b>Right Wardrobe</b> 28 x 24 x 77		220	RPC2877TW294W 4830	"P" Option N/A	"G" Option N/A	"M" Option N/A
2 Select a finish <a href="#">View finish details</a>			WAC WRC WIC WHC WOC WEW WGW WBW WSW WNW			
3 Select a edge <a href="#">View edge details</a>			Edge N/A			
4 Select hardware <a href="#">View hardware details</a>			 PL-4 Antique Brass  PL-5 Antique Brass  PL-50 Brushed Pewter  DK-114 Brushed Pewter  DK-4 Antique Brass			

[View statement of line](#)

## Product features.

- 2 Adjustable shelves
- 2.5" Cornice top
- 3.5" Traditional base
- Door/Drawer fronts w/ profile edges
- File drawer - Full extension drawers - locking
- Soft close suspension drawer(s)
- Top profile shaped 3 sides

### NOTES

- Adjustable shelves shaded
- Unit has black back panel and is not designed for Open Plan use.  
Select OPB Option for Open Plan application

## Options.

### DOOR

- D2: Door Lock - \$100 per door
- D9SC: Soft Close Door Hinges - \$20 per door

### DRAWER

- P6: Modify File/File to Box/Box/File - \$55 per pedestal
- P33: Wood Drawer Upgrade - \$45 per drawer

### FLUSH CUT

- FC-B: Flush Unit Both Sides(Facing) for Ganging - \$100
- FC-L: Flush Unit Left (Facing) for Ganging - \$100
- FC-R: Flush Unit Right(Facing) for Ganging - \$100

### OPEN PLAN – FINISHED BACK

- OPB: "W" "G" Style - Modify Unit for Open Plan Application - \$395

# Richmond park.

Vertical Full Towers  
Freestanding Wardrobe / Storage

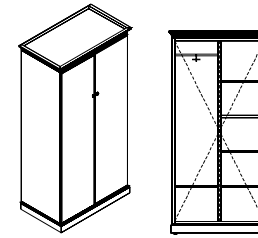

1 Select a model w" x d" x h"	weight	Standard Veneer Top Standard Veneer Chassis		Premium Veneer Top Premium Veneer Chassis		High Pressure Laminate Top Veneer Chassis		Thermally Fused Laminate Top Thermally Fused Laminate Chassis	
		38.5 x 24 x 77	260	RPC3877TW275W	4618	"P" Option N/A	"G" Option N/A	"M" Option N/A	"M" Option N/A
32.5 x 24 x 77	210	RPC3277TW275W	4331	"P" Option N/A	"G" Option N/A				



  

2 Select a finish <i>View finish details</i>	WAC	
		WRC
	WIC	
	WHC	
	WOC	
	WEW	
	WGW	
	WBW	
	WSW	
	WNW	

3 Select a edge <i>View edge details</i>	Edge	
		N/A

4 Select hardware <i>View hardware details</i>	 DK-114 Brushed Pewter		 DK-4 Antique Brass	

*View statement of line*

## Product features.

- 2.5" Cornice top
- 3 Adjustable shelves
- 3.5" Traditional base
- Doors w/ profile edges
- Top profile shaped 3 sides
- Wardrobe w/ coat rod & hook

### NOTES

- Adjustable shelves shaded
- Pulls are located 26" from the top of the door and 1-5/8" from the edge.
- Unit has black back panel and is not designed for Open Plan use. Select OPB Option for Open Plan application

## Options.

### DELETE CENTER PARTITION

- MOD31OP: Delete Center Partition / Add (3) Full Width Adj. Shelves & (1) Fixed - \$295

### DOOR

- D2: Door Lock - \$100 per door
- D9SC: Soft Close Door Hinges - \$20 per door

### FLUSH CUT

- FC-B: Flush Unit Both Sides(Facing) for Ganging - \$100
- FC-L: Flush Unit Left (Facing) for Ganging - \$100
- FC-R: Flush Unit Right(Facing) for Ganging - \$100

### OPEN PLAN – FINISHED BACK

- OPB: "W" "G" Style - Modify Unit for Open Plan Application - \$395

# Richmond park.

Vertical Full Towers

Freestanding Lateral File / Storage

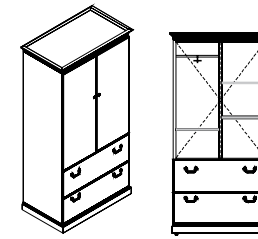

[View statement of line](#)

1 Select a model w" x d" x h"	weight	Standard Veneer Top	Premium Veneer Top	High Pressure Laminate Top	Thermally Fused Laminate Top
		Standard Veneer Chassis	Premium Veneer Chassis	Veneer Chassis	Thermally Fused Laminate Chassis
38.5 x 24 x 77	280	RPC3877TW281W	"P" Option N/A	"G" Option N/A	"M" Option N/A
32.5 x 24 x 77	220	RPC3277TW281W	"P" Option N/A	"G" Option N/A	"M" Option N/A

2 Select a finish <a href="#">View finish details</a>	WAC	WRC	WIC	WHC	WOC	WEW	WGW	WBW	WSW	WNW

3 Select a edge <a href="#">View edge details</a>	Edge
	N/A

4 Select hardware <a href="#">View hardware details</a>	PL-4 Antique Brass	PL-5 Antique Brass PL-50 Brushed Pewter
	DK-114 Brushed Pewter	DK-4 Antique Brass

## Product features.

- 2.5" Cornice top
- 3 Adjustable shelves
- 3.5" Traditional base
- Door/Drawer fronts w/ profile edges
- Legal/Double letter filing
- Soft close suspension drawer(s)
- Top profile shaped 3 sides
- Wardrobe w/ coat rod & hook

### NOTES

- Adjustable shelves shaded
- Unit has black back panel and is not designed for Open Plan use.  
Select OPB Option for Open Plan application

## Options.

### DELETE CENTER PARTITION

- MOD300P: Delete Center Partition / Add 3 Full Width Adj. Shelves & 1 Fixed - \$295

### DOOR

- D2: Door Lock - \$100 per door
- D9SC: Soft Close Door Hinges - \$20 per door

### DRAWER

- P33: Wood Drawer Upgrade - \$45 per drawer

### FLUSH CUT

- FC-B: Flush Unit Both Sides(Facing) for Ganging - \$100
- FC-L: Flush Unit Left (Facing) for Ganging - \$100
- FC-R: Flush Unit Right(Facing) for Ganging - \$100





### OPEN PLAN – FINISHED BACK

- OPB: "W" "G" Style - Modify Unit for Open Plan Application - \$395

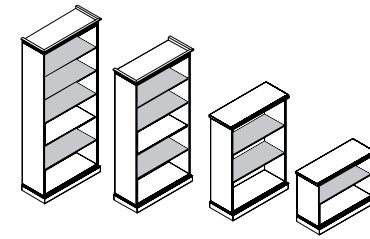
# Richmond park.

Assembled Bookcases  
Open Bookcase



1 Select a model w" x d" x h"	weight	Standard Veneer Top	Premium Veneer Top	High Pressure Laminate Top	Thermally Fused Laminate Top
		Standard Veneer Chassis	Premium Veneer Chassis	Veneer Chassis	Thermally Fused Laminate Chassis
<b>Cornice Top and Base</b>					
37 x 16 x 86	205	RPC3786BK250W 2982	"P" Option N/A	"G" Option N/A	"M" Option N/A
37 x 16 x 74	185	RPC3774BK250W 2689	"P" Option N/A	"G" Option N/A	"M" Option N/A
31 x 16 x 86	200	RPC3186BK250W 2767	"P" Option N/A	"G" Option N/A	"M" Option N/A
31 x 16 x 74	180	RPC3174BK250W 2475	"P" Option N/A	"G" Option N/A	"M" Option N/A
<b>Veneer Top and Base</b>					
37 x 15 x 53	205	RPC3753BK250W 2496	"P" Option N/A	RPC3753BK250G 2496	"M" Option N/A
37 x 15 x 31.75	185	RPC3731BK250W 2254	"P" Option N/A	RPC3731BK250G 2254	"M" Option N/A
31 x 15 x 53	200	RPC3153BK250W 2291	"P" Option N/A	RPC3153BK250G 2291	"M" Option N/A
31 x 15 x 31.75	180	RPC3131BK250W 2140	"P" Option N/A	RPC3131BK250G 2140	"M" Option N/A
<b>2 Select a finish</b> <i>View finish details</i>		WAC WRC WIC WHC WOC WEW WGW WBW WSW WNW		GAC GIC GHC GOC GEW GNW	
<b>3 Select a edge</b> <i>View edge details</i>		  Richmond Classic		  Richmond Classic	
<b>4 Select hardware</b> <i>View hardware details</i>		Hardware N/A		Hardware N/A	

[View statement of line](#)

## Product features.

- .75" Thick veneer back w/ dowel joint
- 2.5" Cornice top
- Adjustable glides
- Interior shelf depth 12"
- Veneer Top for 53" and 30" height
- Top profile shaped 3 sides
- "W" styles - 30", 53" H units finished top, 74", 86" H units black painted top

### NOTES

- Adjustable shelves are shaded
- Base Height 3.5"
- Glides adjust 1"
- Unit has black back panel and is not designed for Open Plan use. Select OPB Option for Open Plan application
- 31.75" H Open Bookcases are NOT meant to gang with desks, returns and credenzas. Unit is higher than regular worksurfaces to allow double binder storage. If matching height is desired, choose RPC-3724CA125W or RPC3124CA125W with D6A option

## Options.

### FLUSH CUT

- FC-B: Flush Unit Both Sides(Facing) for Ganging - \$100
- FC-R: Flush Unit Right(Facing) for Ganging - \$100
- FC-L: Flush Unit Left (Facing) for Ganging - \$100

### INTERIOR CABINET LIGHTING

- LEDPK starter kit includes Infeed, 1 Puck Interior Light and the ability to daisy chain up to 6 total Puck Lights
- LEDPK: LED Puck Starter Kit - \$310
- PK: 1 LED Interior Light - \$130

### OPEN PLAN – FINISHED BACK

- OPB: "W" "G" Style - Modify Unit for Open Plan Application - \$395

### SHELF

- GS14F: Replace Standard Shelves with Glass Shelves - \$90 per shelf
- S714F: Heavy Duty Lumber 1" Shelves - \$80 per shelf

## Richmond park options.

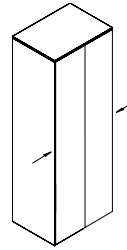
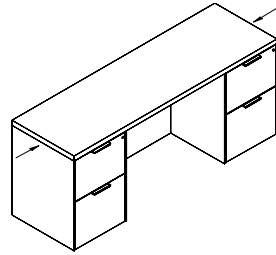
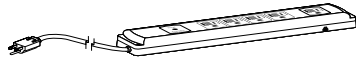

### POWER / DATA *power supply cordset*

Style Number	List Price
PD717	95

### Specifications

- SIZE: 10.75"L x 2.0"W x 1.06"H
- (5) Outlets w/ 10' cord
- Surge suppression (720 Joules)
- 15 Amp breaker
- Available on: Vertical Panels, Cabinet Interiors, and under tops

### PRODUCT MODIFICATIONS *modify width - open kneespace*

Style Number	List Price
MOD-1	125

### Specifications

- Modify width down on any unit with an open kneespace: desk, workstation credenza, bridge, return

### PRODUCT MODIFICATIONS *modify width - open/closed storage*

Style Number	List Price
MOD-2	250

### Specifications

- Modify width down on any unit with open or closed storage section: overheads, wall hung units, storage credenzas, towers

### PRODUCT MODIFICATIONS *modify width - outside of mod-1, mod-2*

Style Number	List Price
MOD-3	Contact for pricing

### Specifications

- Width modification outside of MOD-1 & MOD-2

Richmond park options.

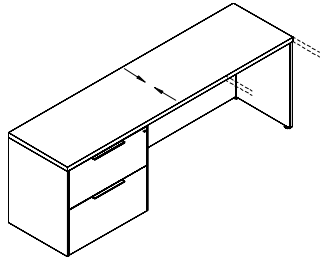

PRODUCT MODIFICATIONS  
*modify depth - decrease depth*

Style Number	List Price
MOD-5	125

Specifications

- Modify depth down (minimum depth for a unit with drawers is 21" D)

Notes  
 - Ex. 24" to 21", 30" to 24", and 36" to 30"

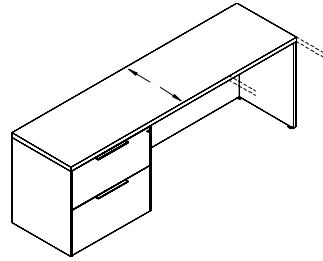

PRODUCT MODIFICATIONS  
*modify depth - increase depth*

Style Number	List Price
MOD-6	Add 10%

Specifications

- Increase depth by no more than 6"

Notes  
 - Ex. 24" to 30", 30" to 36", and 36" to 42"  
 - Add 10% to the unit you want to increase the depth of by no more than 6"

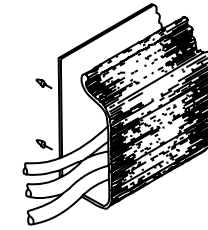

PRODUCT MODIFICATIONS  
*modify height*

Style Number	List Price
MOD-7	Contact for pricing

Specifications

- Modify height of a unit

WIRE MANAGEMENT  
*horizontal j-channel wire management raceway*

Style Number	List Price
W1	75 Per 4' section

Specifications

- 4' section for field installation.  
 - The "J" shape black thermoplastic wire raceway may be added to specified worksurface tops to provide concealed channeling of wires to and from worksurface grommets. For use in open kneespace areas, raceway is attachable to top of back panel with pan head screws. Interior dimensions are 1" x 1- 1/2" providing ample storage for multiple wires and excess cable. Front of raceway flexes out for easy cord insertion.

Notes  
 - Units w/ Wire Channel Standard.  
 - Field Installation

Richmond park options.

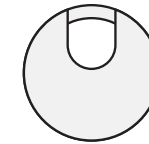
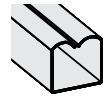
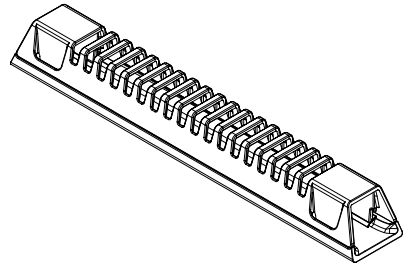

WIRE MANAGEMENT  
*horizontal wire management raceway*

Style Number	List Price
W21	30

Specifications

- 10"W x 1.5"D x 1.25"H
- Grey Wire Manager (10.5")
- Power and data cables can be discretely housed and managed with the W21 Gray Wire Manager. This can be mounted in any location to metal frame or underside of conference tables and runs cables through a 1" channel from power module to hollow steel legs. This keeps cables organized under the table top. Release clips make it simple to snap on and off the Wire Manager for easy organization and access after attached to the table

Notes  
- Field installed

WIRE MANAGEMENT  
*horizontal u-channel wire management raceway*

Style Number	List Price
W2A	75 Per 4' section

Specifications

- 4' section for field installation.
- Notes
- Units w/ Wire Channel Standard.
  - Field Installation

WIRE MANAGEMENT  
*coil wire manager*

Style Number	List Price
W18	150

Specifications

- Weighted Base, Table attachment plate
- 39- 1/2" Length
- Black

Notes  
- Location

WIRE MANAGEMENT  
*standard location grommets - factory installed*

Style Number	List Price
Standard Location Grommet	
Black	
TM30	45
Silver	
TM31	45
Antique Brass	
TM33	45

Specifications

- 1 -5/8" Metal Grommet

Notes  
- \*Units w/ Grommets Standard Are Noted Under Standard Features. Grommets Match Pull Finish - Standard (Unless Specified Otherwise)

Richmond park options.

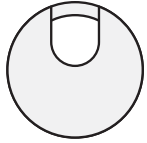

WIRE MANAGEMENT

*non-standard location grommets - factory installed*

Style Number	List Price
Non-Standard Location Grommet	
Black	
TM30 -NS	90
Silver	
TM31 -NS	90
Antique Brass	
TM33 -NS	90

Specifications

- 1 -5/8" Metal Grommet

Notes

- \*Units w/ Grommets Standard Are Noted Under Standard Features. Grommets Match Pull Finish - Standard (Unless Specified Otherwise)

WIRE MANAGEMENT

*black plastic vertical surface grommets - factory installed*

Style Number	List Price
Standard Location Grommet	
TM50-C	45
Non-Standard Location Grommet	
TM50-NS	90

Specifications

- 2 " Black Plastic Grommet

Notes

- Standard Location is Bottom Center

COMPUTER SUPPORT

*single monitor arm*

Style Number	List Price
MA1	265

Specifications

- Available in black or silver
- Desk clamp and mounting included
- Easy assembly and flexibility
- Elastic painting process for a durable and beautiful finish
- Gas spring tension adjustment for counter-balance height adjustment for monitors 1-8 KG
- Gas spring tested to 50,000 repetitions
- Hidden cable management

COMPUTER SUPPORT

*double monitor arm*

Style Number	List Price
MA2	430

Specifications

- Available in black or silver
- Desk clamp and mounting included
- Easy assembly and flexibility
- Elastic painting process for a durable and beautiful finish
- Gas spring tension adjustment for counter-balance height adjustment for monitors 1-8 KG
- Gas spring tested to 50,000 repetitions
- Hidden cable management



Richmond park options.



COMPUTER SUPPORT  
*triple monitor arm*

Style Number	List Price
MA3	505

Specifications

- Available in black or silver
- Desk clamp and mounting included
- Easy assembly and flexibility
- Elastic painting process for a durable and beautiful finish
- Gas spring tension adjustment for counter-balance height adjustment for monitors 1-8 KG
- Gas spring tested to 50,000 repetitions
- Hidden cable management



COMPUTER SUPPORT  
*quadruple monitor arm*

Style Number	List Price
MA4	675

Specifications

- Available in black
- Desk clamp and mounting included
- Easy assembly and flexibility
- Elastic painting process for a durable and beautiful finish
- Gas spring tension adjustment for counter-balance height adjustment for monitors 1-8 KG
- Gas spring tested to 50,000 repetitions
- Hidden cable management

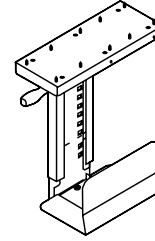

COMPUTER SUPPORT  
*cpu retractable cradle*

Style Number	List Price
K18	195

Specifications

- Black Metal CPU Carriage
- Full 360° swivel capability allows easy access to rear of CPU for cables / wires
- Track allows 8- 1/2" extension
- Width Adjustment 5-1/2" to 9-1/4"
- Height adjustment 14- 5/8" to 20- 1/2"
- Black epoxy finish

- Notes
- Factory Installed

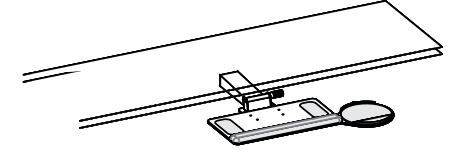

COMPUTER SUPPORT  
*articulating keyboard tray*

Style Number	List Price
Factory Installed	
K28	375
Field Installed	
K28F	395

Specifications

- Adjusts effortlessly - A simple one-handed motion allows the keyboard to be repositioned instantly, without the use of locks or levers
- Encourages low-risk postures - Maximizes adjustability within a safe operating range.
- Will last a lifetime - Exceeds all applicable BIFMA Standards and comes with a lifetime guarantee.

- Notes
- Available on: Freestanding Desk
  - Factory Installed (standard)
  - FIELD INSTALL - \$395

Richmond park options.

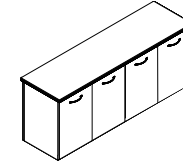
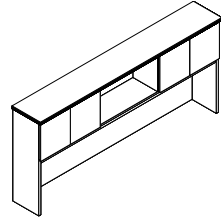

DOOR MODIFICATIONS  
*soft close door hinge*

Style Number	List Price
D9SC	15 Per door

Specifications

- Snap onto standard door hinge
- Requires (2) per door
- Max door height 43"
- Factory installed where specified
- Individually shipped for field installation

- Notes
- Specify Each Item To Have Slow Close Feature

DOOR MODIFICATIONS  
*delete doors*

Style Number	List Price
D6	N/C

Specifications

- Standard Door overheads and cabinets can have door deleted for open access. Modification of hinge rails and structural components are made face ready.

DOOR MODIFICATIONS  
*replace glass panel insert with veneer panel insert*

Style Number	List Price
D35	30 per door

Specifications

- Replace glass panel insert with veneer panel insert

- Notes
- Not Available on "M" skus
  - Glass door has beveled glass
  - Wood door w/ veneer insert - only available on "W" style

DOOR MODIFICATIONS  
*delete doors/replace black laminate shelf w/ finished shelf*

Style Number	List Price
D6A	N/C

Specifications

- Delete doors and replace black laminate shelf with finished shelf

- Notes
- Available on: All Storage "W"/"G" Style Credenzas.

Richmond park options.

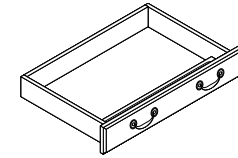
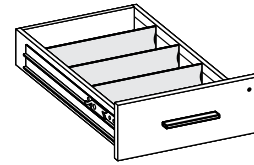
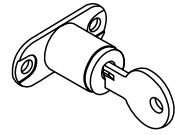
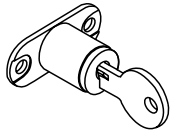

DOOR MODIFICATIONS  
*panel door lock*

Style Number	List Price
D2	95 Per door set

Specifications

- Door Locks - 1 Door w/ Lock, Other Door w/ Catch Latch
- Contact Customer Service regarding limited lock locations and keying.

Notes  
- Available on: Panel Doors, Wood Frame Doors, and Silverluma doors

DOOR MODIFICATIONS  
*glass door lock*

Style Number	List Price
D2-G	195 Per door set

Specifications

- Door Locks - 1 Door w/ Lock, Other Door w/ Catch Latch
- Contact Customer Service regarding limited lock locations and keying.

Notes  
- Available on: Glass Doors

DRAWER OPTIONS  
*box drawer accessories*

Style Number	List Price
Wood Drawer Dividers w/ Clips K-DIV	SET OF 3 - 30
Single Tray - Utility Tray K-Sut	30 each

Specifications

- K-DIV Extra Wood Drawer Dividers with Clips, Top Box drawers standard with 1 divider
- K-SUT Single Tray - Utility Tray, Specify Legal or Letter drawer width

DRAWER OPTIONS  
*finished traditional center drawer*

Style Number	List Price
K30	195
Add Skirt Option K30-SK	295

Specifications

- Veneer drawer front finished to match unit veneer. Edges are scalloped to match standard drawers.
- Standard with matching wood grain pencil tray
- Pulls selected to match unit installed

Richmond park options.

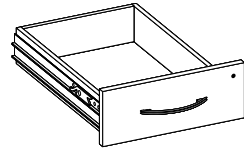
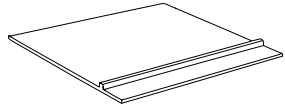

**DRAWER OPTIONS - BOTTOM COVER**  
*felt bottom center drawer insert liner*

Style Number	List Price
K3	95

**Specifications**

- Inserts into center drawer and features divider for open pen and pencil storage. Removable for easy cleaning.
- Adds a luxurious touch to center drawers.
- Color: Dark Brown Coal

**DRAWER OPTIONS - UPGRADE**  
*wood drawer upgrade*

Style Number	List Price
P33	40 Per Drawer

**Specifications**

- Dowel joint construction
- Hardwood veneer multi-ply drawer
- UV finish
- 1/4" Wood veneer bottoms
- File drawer bottoms are five block reinforced for heavy weight capacity
- Lifetime guaranteed

**GLASSBOARD ACCESSORIES**  
*glassboard accessory kit*

Style Number	List Price
GBKIT	275

**Specifications**

- 8 Earth magnets, 1 magnetic marker cup holder and 1 magnetic dry eraser

**RECESSED LIGHTING**  
*lt-led task light*

Style Number	List Price
24" Task light LT-LED24R	180
48" Task light LT-LED48R	235
60" Task light LT-LED60R	295
72" Task light LT-LED72R	320

**Specifications**

- 6.5' Power cord. Switch with touch dimmer
- 36 LEDs per foot
- 4.6 Watts per foot
- 91 Lumens per watt
- Please note when ganging.
- Overhead tasklight cord is located on the right facing side. If the opposite location is required please contact customer service.

## Richmond park options.

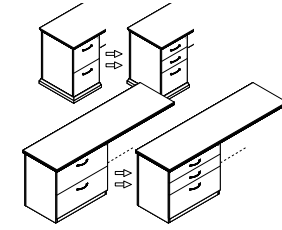
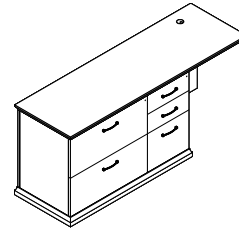
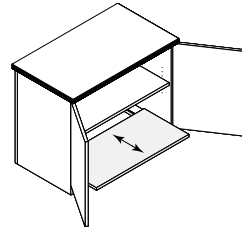
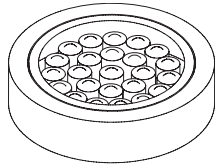

### LIGHTING

#### *led interior cabinet puck light*

Style Number	List Price
Starter Kit LEDPK	295
1 LED Interior Puck Light PK	125

### Specifications

- Starter kit includes Infeed, 1 Puck Interior Light and the ability to daisy chain up to 6 total Puck Lights
- (1) LED Puck Light with 30W power drive and switch
- Recessed fixture
- 12V linking cord 98"L
- Silver finish
- 50,000 hour life
- 2 watt per light

#### Notes

- Available on: Overhead/Tower Units with glass doors or no doors
- Power drive included, Light only

### PEDESTAL MODIFICATIONS

#### *black laminate printer pullout bottom shelf*

Style Number	List Price
PPOS	214

### Specifications

- Black Laminate pullout shelf on suspension
- Black grommet
- Adjustable Shelf

### PEDESTAL MODIFICATIONS

#### *add veneer kneespace cabinets - base*

Style Number	List Price
Add Box/Box/File or File/File P40B	985
Add Lateral File 29" W P41B	1205
Add Multi-File - 31"W P42B	1205
Add Storage With Doors 29"W P43B	1095
Add CPU /Printer Cabinet - Open P44B	1095

### Specifications

- Multi-file specify Box/Box Left or Right

#### Notes

- Add additional Standard Cabinets To Kneespace Area.

### PEDESTAL MODIFICATIONS

#### *modify drawer configurations*

Style Number	List Price
File/File to Box/Box/File P6	50 Per ped
Box/Box/File to File/File P6	50 Per ped
Lateral File to 2 Box Drawers P8	95 Per ped

### Specifications

- Modify File/File To Box/Box/File - Any Unit

## Richmond park options.

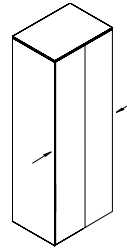
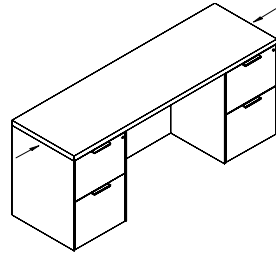
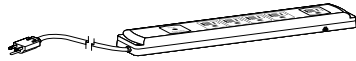

### POWER / DATA *power supply cordset*

Style Number	List Price
PD717	95

### Specifications

- SIZE: 10.75"L x 2.0"W x 1.06"H
- (5) Outlets w/ 10' cord
- Surge suppression (720 Joules)
- 15 Amp breaker
- Available on: Vertical Panels, Cabinet Interiors, and under tops

### PRODUCT MODIFICATIONS *modify width - open kneespace*

Style Number	List Price
MOD-1	125

### Specifications

- Modify width down on any unit with an open kneespace: desk, workstation credenza, bridge, return

### PRODUCT MODIFICATIONS *modify width - open/closed storage*

Style Number	List Price
MOD-2	250

### Specifications

- Modify width down on any unit with open or closed storage section: overheads, wall hung units, storage credenzas, towers

### PRODUCT MODIFICATIONS *modify width - outside of mod-1, mod-2*

Style Number	List Price
MOD-3	Contact for pricing

### Specifications

- Width modification outside of MOD-1 & MOD-2

## Richmond park options.

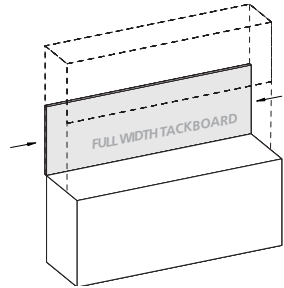

**PRODUCT MODIFICATIONS**  
*modify width - tackboard, slat wall, veneer panel, or a glassboard*

Style Number	List Price
MOD-4	50

### Specifications

- Modify width down on tackboard, slat wall, veneer panel, or a overhead glassboard

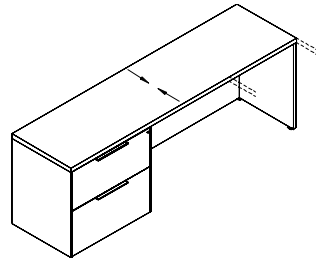

**PRODUCT MODIFICATIONS**  
*modify depth - decrease depth*

Style Number	List Price
MOD-5	125

### Specifications

- Modify depth down (minimum depth for a unit with drawers is 21"D)

Notes  
 - Ex. 24" to 21", 30" to 24", and 36" to 30"

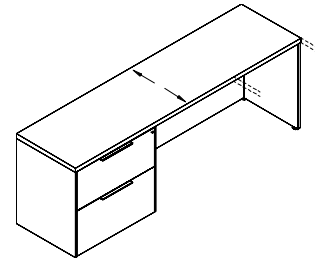

**PRODUCT MODIFICATIONS**  
*modify depth - increase depth*

Style Number	List Price
MOD-6	Add 10%

### Specifications

- Increase depth by no more than 6"

Notes  
 - Ex. 24" to 30", 30" to 36", and 36" to 42"  
 - Add 10% to the unit you want to increase the depth of by no more than 6"

**PRODUCT MODIFICATIONS**  
*modify height*

Style Number	List Price
MOD-7	Contact for pricing

### Specifications

- Modify height of a unit

Richmond park options.

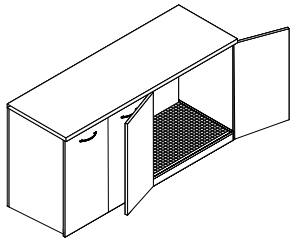

REFRIGERATOR MODIFICATION  
*refrigerator cabinet modification*

Style Number	List Price
REF01	195

Specifications

- Open back cutout for venting
- Moisture sponge mat
- Contaminate ledge
- Contact customer service for maximum refrigerator size (Changes based on unit).
- Available on: 36" and 42" Storage Credenzas

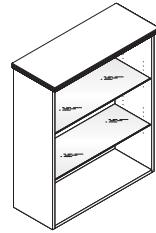

SHELF MODIFICATIONS  
*glass shelves - tempered full width  
26" - 35"*

Style Number	List Price
26"W - 35"W x 14"D Shelf GS14F	85

Specifications

- Glass Shelves Replace Wood Shelf In Open Or Glass Door Cabinet. Also Order Interior Cabinet Lighting.

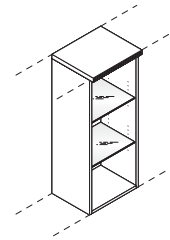

SHELF MODIFICATIONS  
*tempered glass shelves for half  
cabinet 17- 1/2" widths*

Style Number	List Price
14-1/2"W - 17- 1/2"W x 14"D Shelf GS14H	65 ea

Specifications

- Glass Shelves Replace Wood Shelf In Open Or Glass Door Cabinet. Also Order Interior Cabinet Lighting.

Notes

- Replace only adjustable shelves between cabinet light and fixed lower wood shelf.

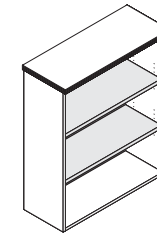

SHELF MODIFICATIONS  
*heavy duty solid wood bookcase  
replacement shelves*

Style Number	List Price
1" Wood Shelf 14" Deep S714F	75 ea
1" Wood Shelf 24" Deep S714FX	150 each

Specifications

- 1" Solid Lumber Core Shelves Replace Standard 3/4" Plywood Adjustable And Fixed Shelves



Richmond park options.

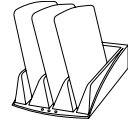

SLAT WALL ACCESSORIES  
*slat wall accessory tray*

Style Number	List Price
SWA9	45

**Specifications**  
- Specify Black Or Matte Silver

SLAT WALL ACCESSORIES  
*slat wall folder tray*

Style Number	List Price
SWA7	45

**Specifications**  
- Specify Black Or Matte Silver

SLAT WALL ACCESSORIES  
*slat wall paper tray*

Style Number	List Price
SWA2	35

**Specifications**  
- Specify Black Or Matte Silver

SLAT WALL ACCESSORIES  
*slat wall pencil holder*

Style Number	List Price
SWA4	25

**Specifications**  
- Specify Black Or Matte Silver

## Richmond park options.

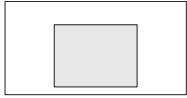

RECTANGLE INLAY

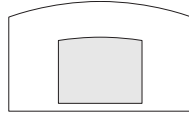

BOWFRONT INLAY

### SPECIALTY VENEER ACCENTS

*rectangle inlay - recesses dura-leather writing surface*

Style Number	List Price
RL-29A	895

### SPECIALTY VENEER ACCENTS

*bowfront inlay - recesses dura-leather writing surface*

Style Number	List Price
RL-31A	995

## Specifications

- Recessed inlay desk pads are covered with Alomost Leather from Paul Brayton Designs.
- DARRAN will gladly custom quote other inlay materials ie: solid surfaces, biocomposites, metallic laminates, or genuine leather to match seating

## Specifications

- Recessed inlay desk pads are covered with Alomost Leather from Paul Brayton Designs.
- DARRAN will gladly custom quote other inlay materials ie: solid surfaces, biocomposites, metallic laminates, or genuine leather to match seating

## power & data options.

Aircharge wireless charging grommet

Style Number	List Price
 ACWG WIRELESS GROMMET	\$195

## Specifications

- › When used with GROVE Tables an additional \$350 LIST will apply for the special cutout required.
- › AirCharge offers a convenient way to charge any Qi compatible smartphone or device without the need to carry charging cables or find an available power outlet.
- › The Aircharge is powered by the latest Qi compliant IC offering reliable and efficient wireless charging in a convenient 3" grommet hub. Simply place your phone on the Aircharge and an LED will confirm pairing and begin wireless charging.
- › Recess: Efficient space conservation and quick access
- › Input: DC 5V (with included AC power adapter), DC 9V, 1.67A (with optional QC 2.0 power adapter)
- › Output: 5 watts Max. with DC 5V, 2A power adapter, 10 watts Max. with QC 2.0 power adapter
- › Qi V1.2 compliant IC
- › Charging distance: 6mm Max.

Available: All DARRAN collections



## power & data options.

Cove power unit - non-linking

Style Number

List Price



PD-COVE PLUG

\$550

Non-linking version

## Specifications

- › Size 5.75"L x 2.5"W
- › (2) 15 Amp Receptacles and (2) USB charging ports
- › Surface Mount
- › 108" Cord
- › Standard Silver Finish, Available in White or Black Finish upon request
- › ETL Listed

Available: All DARRAN collections



## power & data options.

Cove corded series

Style Number

List Price



PD-COVE-PKO

\$800

## Specifications

- › Size 9.5" L x 2.5" W x 3.18" D
- › When used with GROVE Tables an additional \$350 LIST will apply for the special cutout required.
- › (2) Power Receptacles, (2) 2.1 Amp USB charging ports and (1) Telecom Plate Knockout
- › Surface Mount
- › 108" Cord
- › Standard Silver Finish, Available in White or Black Finish upon request
- › ETL Listed

Available: All DARRAN collections

### Telecom Plates

RJ45 (1)	\$35
RJ45 (2)	\$70
RJ45 (3)	\$105
USB (1)	\$70
USB (2)	\$140
RJ11/RJ45	\$70
RJ45/USB	\$105
RJ45/HDMI	\$190
HDMI/DVI	\$325
HDMI/USB	\$205
HDMI/VGA	\$240
VGA/MINI-STEREO	\$155
VGA/USB	\$175

This pod can have up to 1 total plates.

\*All telecom connectors sold separately.



## power & data options.

### Soba wire manager

Style Number	List Price
STARTER UNITS	
SCDW	\$200
White wire manager	
SCDB	\$200
Black wire manager	

## Specifications

- › Dimensions: 9ft x 9in x 3.15in
- › Zips up, bundles and routes loose, messy cables into a single tube
- › Routes and guides cables behind desks, TVs, and anywhere cables tend to get messy
- › Accommodates large or small cables, up to three cables at once
- › Support channels, used to route cables, include powerful adhesive backing which allows easy attachment to surfaces.

Available: All DARRAN collections



## power & data options.

VILLA Power unit - non-linking

Style Number	List Price
 VIL-C PLUG	\$515
Non-Linking	

### Specifications

- › Size: Top Grommet 5.68" L X 3.39"W; Under Top 12"L x 3.13"W x 3.08"D
- › (2) Power receptacles; (2) USB charging ports and (1) Knockouts for RJ45 Data Ports
- › Surface Mount
- › 72" Cord (Longer cord available, contact Customer Service)
- › Standard Silver Finish, Black Finish available upon request
- › UL or ETL Certified

Available: All DARRAN collections, excludes Grove

RJ45 Knockout	
RJ45 (1)	\$35

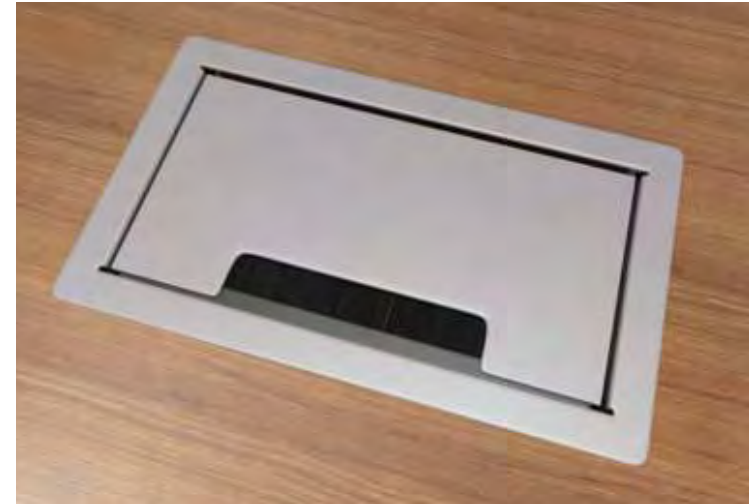

# Richmond park.

Wall Hung Overheads

Panel Doors - 6/4/2 Door

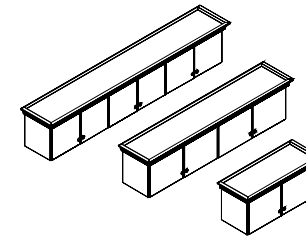

## 1 Select a model w" x d" x h"

	weight	Standard Veneer Top Standard Veneer Chassis	Premium Veneer Top Premium Veneer Chassis	High Pressure Laminate Top Veneer Chassis	Thermally Fused Laminate Top Thermally Fused Laminate Chassis
<b>6 Door / 3 Section</b>					
95 x 15 x 20	200	RPC9520WH330W 4124	"P" Option N/A	"G" Option N/A	"M" Option N/A
89 x 15 x 20	185	RPC8920WH330W 3980	"P" Option N/A	"G" Option N/A	"M" Option N/A
<b>4 Door / 2 Section</b>					
85 x 15 x 20	175	RPC8520WH330W 3517	"P" Option N/A	"G" Option N/A	"M" Option N/A
78 x 15 x 20	165	RPC7820WH330W 3371	"P" Option N/A	"G" Option N/A	"M" Option N/A
72 x 15 x 20	155	RPC7220WH330W 3229	"P" Option N/A	"G" Option N/A	"M" Option N/A
66 x 15 x 20	140	RPC6620WH330W 3025	"P" Option N/A	"G" Option N/A	"M" Option N/A
60 x 15 x 20	130	RPC6020WH330W 2759	"P" Option N/A	"G" Option N/A	"M" Option N/A
49 x 15 x 20	115	RPC4920WH330W 2445	"P" Option N/A	"G" Option N/A	"M" Option N/A
<b>2 Door</b>					
37 x 15 x 20	75	RPC3720WH330W 1887	"P" Option N/A	"G" Option N/A	"M" Option N/A
31 x 15 x 20	65	RPC3120WH330W 1852	"P" Option N/A	"G" Option N/A	"M" Option N/A

## 2 Select a finish [View finish details](#)

- WAC
- WRC
- WIC
- WHC
- WOC
- WEW
- WGW
- WBW
- WNW

## 3 Select a edge [View edge details](#)

- Edge
- N/A

## 4 Select hardware [View hardware details](#)



[View statement of line](#)

## Product features.

- 2.5" Cornice top
- Door fronts w/ profile edges
- Interior cabinet depth 12"
- Mounting wall rail included
- Scalloped edge doors
- Top profile shaped 3 sides
- Veneer interior

### NOTES

- Proper installation is critical to ensure safety from possible falling cabinets. The factory assumes no liability for damage or injury from The following: installation into non-load bearing or unlevel walls. Improper fasteners used in installation. Overloading of cabinets resulting in failures of wall and surrounding structures, fasteners, or cabinet construction. Misuse of cabinets for intended purposes.

## Options.

### DOOR

- D2: Door Lock - \$100 per door
- D6: Delete Doors - n/c
- D95C: Soft Close Door Hinges - \$20 per door

### FLUSH CUT

- FC-B: Flush Unit Both Sides(Facing) for Ganging - \$100
- FC-L: Flush Unit Left (Facing) for Ganging - \$100
- FC-R: Flush Unit Right(Facing) for Ganging - \$100

### TASK LIGHTING (RECESSED)

- Overhead tasklight cord is located on the right facing side. If the opposite location is required please contact customer service.
- LT-LED24R: 24" LED Task light - \$190
  - LT-LED48R: 48" LED Task light - \$245
  - LT-LED60R: 60" LED Task light - \$310
  - LT-LED72R: 72" LED Task light - \$335
  - LC24: Linking Task light cable - \$25



# Rift price list

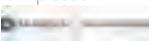

# Rift price list revisions

Date Page

Modification

Description



## Rift Table of contents

Statement of Line	
Features & Advantages .....	1
Finishes   Specifications .....	3
Edges   Pulls   Knobs.....	4
Grommets   Grommet Reference.....	5
Height Reference .....	6
Modesty Reference   Grain Direction .....	7
Drawer Dimensions   FILING Reference .....	8
Double Pedestal Desk.....	9
Table Desk .....	12
Single Pedestal Desk .....	16
Conference Desk .....	18
Runoff Desk.....	20
Returns.....	22
Bridges .....	26
Freestanding Credenzas .....	27
Workstation Credenzas .....	28
Bench Cabinets.....	38
Pedestals.....	40
Single Height Freestanding Overheads .....	42
Double Height Freestanding Overheads.....	44
Overhead Accessories .....	45
Single Height Wall Hung Overheads.....	49
Double Height Wall Hung Overheads .....	51
Wall Hung Accessories .....	53
Wall Hung Shelves .....	58
Overhead Full Towers.....	60
Vertical Half Towers.....	61
Vertical Full Towers.....	62
Bookcases.....	65
Options.....	66
Power & Data .....	81

# Rift statement of line

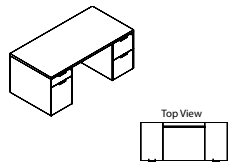

PAGE 9  
Double Pedestal Desks

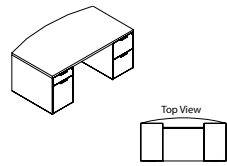

PAGE 10  
Double Pedestal Desks

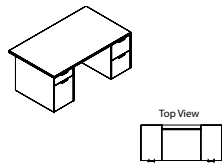

PAGE 11  
Double Pedestal Desks

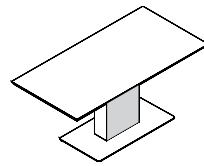

PAGE 12  
Conference Table Desk

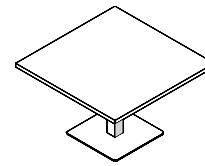

PAGE 13  
Conference Table

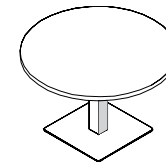

PAGE 14  
Conference Table

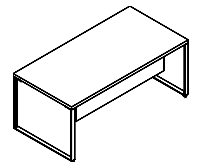

PAGE 15  
Table Desks

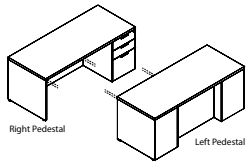

PAGE 16  
Workstation Desks

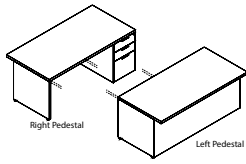

PAGE 17  
Workstation Desks

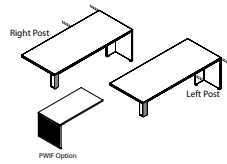

PAGE 18  
Workstation Conference Desks

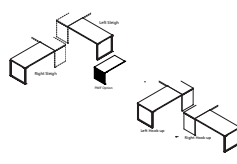

PAGE 19  
Workstation/Bench Runoff Conference Desks

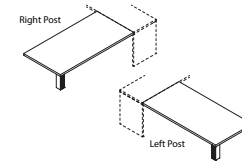

PAGE 20  
Workstation Runoff Conference

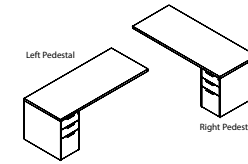

PAGE 21  
Workstation/Bench Runoff Conference Desks

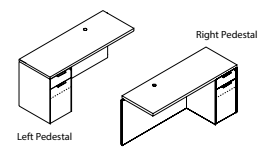

PAGE 22  
"L" Workstation Returns

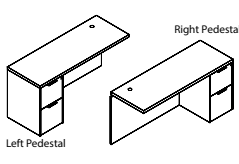

PAGE 23  
"L" Workstation Returns

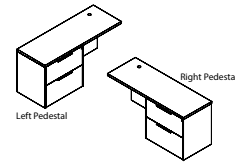

PAGE 24  
"L" Workstation Returns

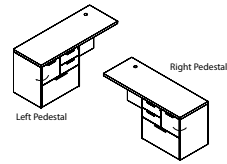

PAGE 25  
"L" Workstation Returns

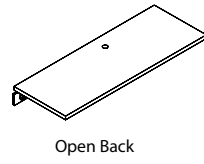

PAGE 26  
Bridges

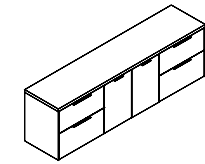

PAGE 27  
Credenzas

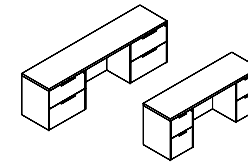

PAGE 28  
Credenzas

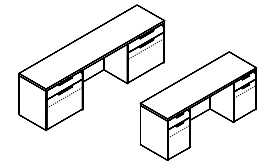

PAGE 29  
Credenzas

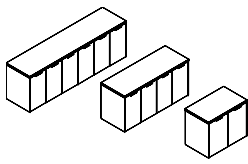

PAGE 30  
Credenzas

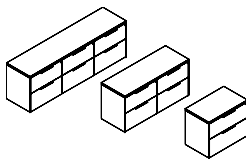

PAGE 31  
Credenzas

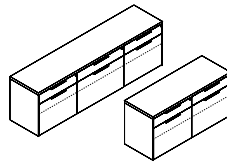

PAGE 32  
Credenzas

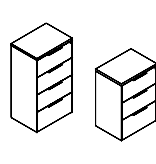

PAGE 33  
Lateral Files

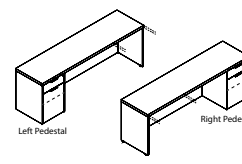

PAGE 34  
Workstation Credenzas

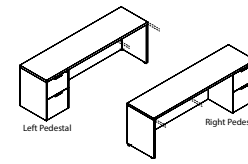

PAGE 35  
Workstation Credenzas

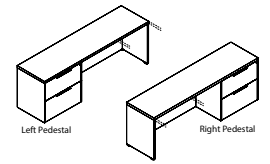

PAGE 36  
Workstation Credenzas

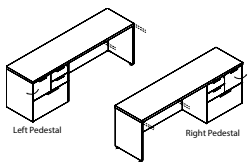

PAGE 37  
Workstation Credenzas

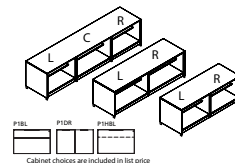

PAGE 38  
Open Plan Bench Credenzas

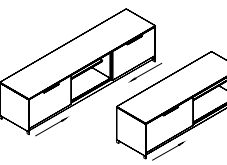

PAGE 39  
Open Plan Bench Credenzas

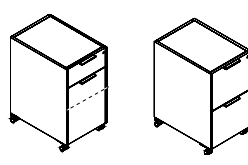

PAGE 40  
Mobile Pedestals

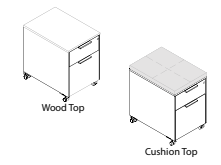

PAGE 41  
Mobile Pedestals

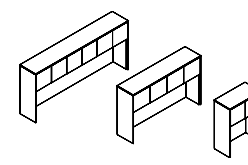

PAGE 42  
Overhead Consoles Single Height

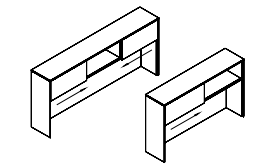

PAGE 43  
Overhead Consoles Single Height



statement of line.

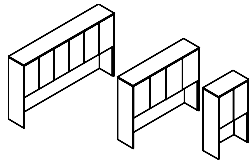

PAGE 44  
Overhead Consoles Double Height  
Hinged Wood Doors

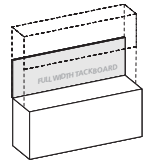

PAGE 45  
Overhead Tackboards

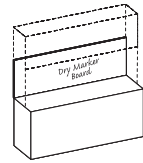

PAGE 46  
Overhead Dry Marker Boards

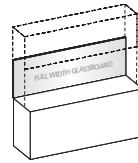

PAGE 47  
Overhead Glassboards

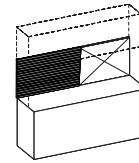

PAGE 48  
Overhead Slat Wall

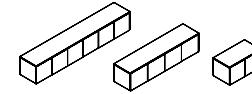

PAGE 49  
Wall Hung Storage Single Height  
Hinged Wood Doors

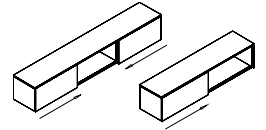

PAGE 50  
Wall Hung Storage Single Height  
Sliding Wood Doors

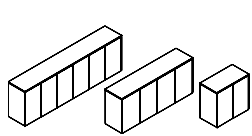

PAGE 51  
Wall Hung Storage Double Height  
Hinged Wood Doors

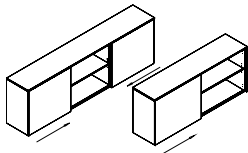

PAGE 52  
Wall Hung Storage Double Height  
Sliding Wood Doors

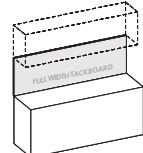

PAGE 53  
Wall Hung Tackboards

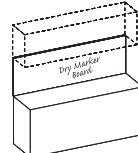

PAGE 54  
Wall Hung Dry Marker Boards

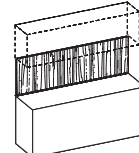

PAGE 55  
Wall Hung Veneer Panels

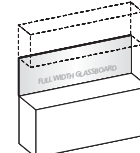

PAGE 56  
Wall Hung Glassboards

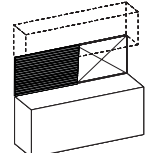

PAGE 57  
Wall Hung Slat Wall

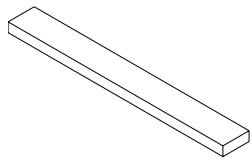

PAGE 58  
Floating Wall Mounted Shelf  
Single Shelf

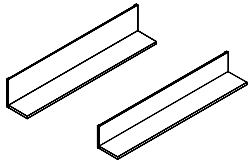

PAGE 59  
Wall Hung Open Shelf  
Single Height - 19"/15"H

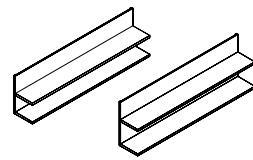

PAGE 60  
Wall Hung Open Shelf  
Double Height - 32"/28"H

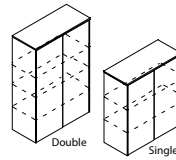

PAGE 61  
Overhead Full Towers  
Storage With Hinged Wood Door

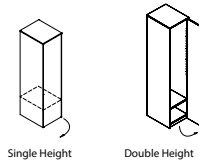

PAGE 62  
Vertical Half Towers  
Wardrobe With Door

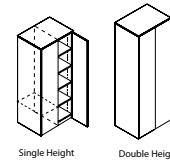

PAGE 63  
Vertical Full Towers  
Wardrobe Storage With Double Door

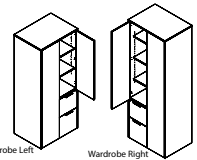

PAGE 64  
Vertical Full Towers  
File-File/Storage/Full Wardrobe

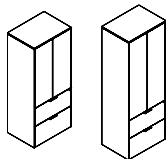

PAGE 65  
Vertical Full Towers  
2 Lateral File/Storage Double Door

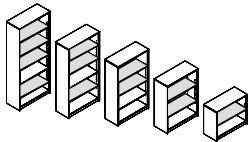

PAGE 66  
Open Bookcases  
15" Deep



## Rift Features & advantages

### Veneer tops

Veneer tops and high-pressure laminate tops feature a 45-pound density substrate with balanced 3-ply construction. Primary surface tops are 1-5/16" thick, bench credenzas, towers and overhead tops are 3/4" thick. Rift collection features double cut reconstituted walnut and oak veneer. Veneer tops feature a 3mm external solid hardwood band, HPL tops features a 2mm flat PVC band or a 1mm laminate self-edge. Some collections feature double cut reconstituted walnut and oak veneers.

### Cleaning wood & laminate

In addition to regular dusting, give your furniture an occasional cleaning in accordance with our cleaning instructions. DARRAN wood and laminate products can be cleaned with a soft cloth and a mild soap and water mixture. Use approximately 32 oz of water mixed with one tablespoon of dish soap, always wiping with the grain. Dry with a soft cloth, going with the grain, to avoid spotting or streaking.

Wood products should be waxed periodically using a non-wax liquid; please do not use any waxy polish or cleaner. Interior of drawers may also be cleaned with mild soap and water mixture, or any household cleaner that is not petroleum or thinner-based.

### Chassis & pedestal

All pedestals and chassis are constructed with 3/4" thick balanced 3-ply panels. Panels are securely fastened together using rails that are bored and doweled, glued, metal reinforcement brackets and wood cleat construction. Thick end panels are pre-bored to accept a tee nut for the adjustable glide and are reinforced with pvc banding to prevent glide tear out. Glue blocks are used where 3/4" thick panels are joined, bored for tee nut to accept adjustable glide.

### Overhead cabinet construction

#### Freestanding & wall mount

Freestanding Overhead storage cabinets are constructed of 1" and 3/4" thick core of particle board or MDF rated EPP/SCS/CARB-II material with 3-ply balanced construction. Panels are attached with cam fasteners in conjunction with dowels securely adhered with glue. All surface mount cabinets connect to work surface with anti-slip tape. Wall mount cabinets are mounted to the wall with steel "z" bracket attachment method using 5mm euro screws to attach to the back of the cabinet. All units ship with a steel "z" bracket. This bracket is mounted to the wall by field installers. Installers are responsible for selecting and supplying appropriate fasteners for wall conditions.

### Bookcase Construction

All chassis (sides, back, top and bottom panels) are constructed with 3/4" thick core of particle board or MDF rated EPP/SCS/CARB-II material with 3-ply balanced construction. Panels are attached with cam-lock fasteners in conjunction with dowels securely adhered with glue. Shelves on all units are 3/4" thick balance 3 ply panels. Optional heavy duty shelves are 1" thick lumber core balanced 5 ply construction.

### Tackboards

Wall mount tackboards are constructed of .75" thick fiberboard. The fabric is precisely aligned and fitted to the tackboard with a sock on cover. Overhead storage tackboards are constructed of .75" thick fiberboard. The fabric is precisely aligned and fitted to the tackboard and adhered to the rigid hardboard with staples. Wall mount cabinets are mounted to the wall with steel "z" bracket attachment method using 5mm euro screws to attach to the back of the cabinet. All units ship with a steel "z" bracket. This bracket is mounted to the wall by field installers. Installers are responsible for selecting and supplying appropriate fasteners for wall conditions.

### Adjustable glides

Glides provide 1" of vertical leveling adjustment. Glide bottom is durable metal. Glides are secured in solid wood blocks that are screwed and glued for durability.

### Drawers

All drawers are constructed of four sides and a bottom, which are attached to a drawer front with screws for easy removal. Drawer fronts are vertically matched in balanced sets. Pencil trays are standard in all box drawers. Drawers are constructed of maple veneer 1/2" thick material for drawer sides, fronts and backs with a UV finish for maximum durability. Drawer bottoms are 3/16" thick 3-ply maple veneer. Drawer boxes are assembled at each corner with dowel joinery for maximum drawer strength. Lifetime free replacement warranty.

### Drawer fronts

Drawer fronts are vertically matched in balanced sets. Doors feature vertical veneer bookmatched horizontally in sets of 2 / 4 and 6 doors. All drawers and doors have traditional scallop profile edge shape. All tower fronts matched in vertical sets.

### Standard wood drawers

Optional hardwood veneer plywood drawers feature banded top and bottom edges for smoothness. Drawers are dowel joint construction with a UV cured finish over maple veneers, plus a lifetime free replacement guarantee.

### Suspensions

All caseloads utilize cold rolled steel zinc plated high-grade drawer suspensions. Box and File drawers are full extension, featuring steel ball bearings for a smoother

## Rift features & advantages

quieter range of motion with soft close operation and are rated 100lbs. Lateral file drawers are a progressive action full extension suspension with the soft close operation and is rated at 150lbs. Lateral files include anti tip mechanism that will allow only one drawer at a time to be opened. All suspensions are soft close and are warranted for the lifetime of the product.

### Hinges

Units with doors include 95 degree swing hinges.

### Filing

Rift features metal file frames around the perimeter of the drawers with cross bars secured to the drawer sides to support hanging files. A metal adjustable cross bar is standard with all file drawers to support letter/legal filing front to back or side to side. File drawers have one adjustable cross bar and lateral files have two adjustable cross bars. See filing reference for details.

### Locks

Locks are Standard on all drawers below the worksurface. Random lock cores are installed at the factory. Some units may be shipped with the same key number. Locks are Silver, Black or Bronze and match pull finish unless otherwise specified.

DARRAN will also send lock cores separately to the dealer at your request. These units will be send with an empty lock core and the Dealer will receive a shipment of the requested lock core/keys.

### Keying

Keying is available either factory or field installed. Factory installed keying is random.

### Wire management

Wire management capabilities include standard and optional worksurface grommets. Specify W-1 under surface wire channels for organization and management of all communication wires and cords. Horizontal J-Channel wire management (Sku: W-1) is sold separately to conceal wire under worksurfaces.

### Grommets

Metal grommets are provided to match the drawer pull selection. Grommet is available in black, silver or white. Must specify standard or non-standard location. Black plastic grommets are available as an option for vertical applications.

### Powerports

A large selection of power pods are available and handle power, data, docking stations and communication. See options section for selection.

### LED tasklights

LED task lighting provides high efficiency, low energy lighting with a long life. Recessed light is encased in silver aluminum channel with milk lense and rounded end caps. Lights are factory installed. Product specifications listed below:

- Diffuser creates a softer light and eliminates hot spots
- Touch dimmer switch
- Can be "daisy chained" up to 90W
- 4.6 watts per foot
- 120 LEDs per meter
- Certification: UL Listed
- 50,000 hour life span.

Color Temp is 4000K

## Rift finishes | specifications

STANDARD VENEER	PREMIUM VENEER	HIGH PRESSURE LAMINATE	THERMALLY FUSED LAMINATE
N/A.....	TBCO Baby's Cheek .....	N/A.....	N/A
N/A.....	TBSW Brown Sugar .....	N/A.....	N/A
N/A.....	TOBW Organic Brown.....	N/A.....	N/A
N/A.....	TSTV Studio Teak Walnut .....	N/A.....	N/A
N/A.....	TSMV Seattle Mist.....	N/A.....	N/A
N/A.....	TSLV Skyline Walnut.....	N/A.....	N/A
N/A.....	WWP Designer White Paint.....	N/A.....	N/A

HPL TOPS ON TFL PRODUCTS Add 10% - Available with flat edge only  
 Send 3x3 or larger finish chip for color match. Custom finish upcharge is 3% or \$250 Net (whichever is greater).

### Finish

ENVI-CT Green Certified European Technology Coatings  
 Finish.



Rift edges | pulls | knobs

Standard profile

Flat Edge

Hardwood Rim Band Species Same As Surface Veneer

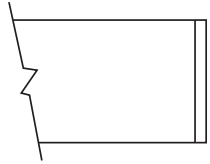

3mm solid  
hardwood band

Rift profile

Rift Profile - Only Available on Table Desk where option is shown

Hardwood Rim Band Species Same As Surface Veneer

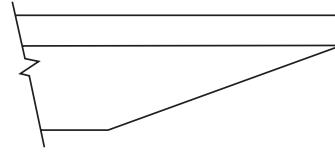

Bases

Column Bases

Available as sit/stand lift version on specific units

6" steel end panels

Removeable wood panel inserts both sides

Steel platform base with floor compression stabilizer

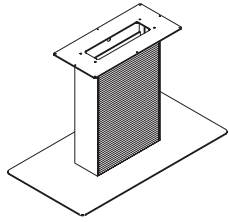

Post Leg

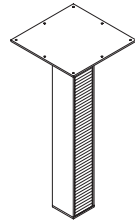

Steel H column  
4" x 4"

Wood panel  
insert two sides

Floor levelers

Cabinet Leg

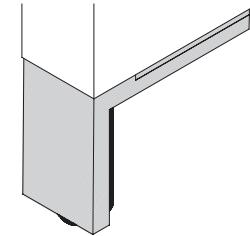

3"H x 1-1/2"W

Cast metal leg

Legs available  
on credenzas,  
benches and towers

Pulls/knobs

Factory Installed

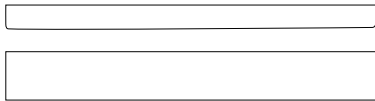

PL-300 Matte Chrome  
PL-301 Matte Chrome  
PL-302 White  
PL-303 White

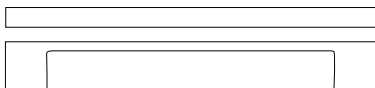
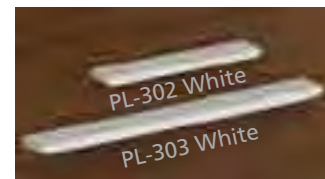
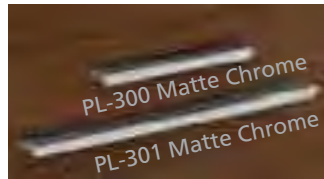

PL-304 Matte Chrome  
PL-305 Matte Chrome  
PL-306 White  
PL-307 White

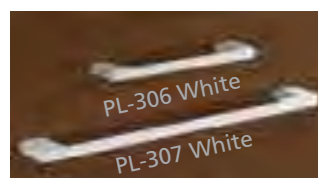

Rift grommets | grommet reference

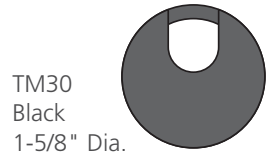

TM30  
Black  
1-5/8" Dia.

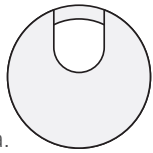

TM31  
Silver  
1-5/8" Dia.

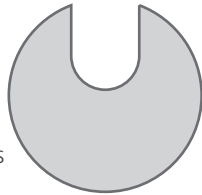

TM33  
Antique Brass  
2-1/2" Dia.

Optional grommets

Factory Installed

Grommets (Standard Location)

Specify Color and Left/Right/Center - \$50 ea.

- Black: TM30-R (Right), TM30-L (Left), TM30-C (Center)

- Silver: TM31-R (Right), TM31-L (Left), TM31-C (Center)

- Antique Brass: TM33-R (Right), TM33-L (Left), TM33-C (Center)

Grommets (Non-Standard Location)

Provide drawing w/ Grommet Location and Specify Color - \$95 ea.

- Black: TM30-NS

- Silver: TM31-NS

- Antique Brass: TM33-NS

TM50  
Black  
1-5/8" Dia.

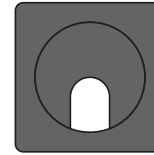

Grommets (vertical surface)

Standard Location - \$50 ea.

- Black Plastic Vertical Surface: TM50-C (Bottom Center)

Non-Standard Location - \$95 ea.

- Black Plastic Vertical Surface: TM50-NS

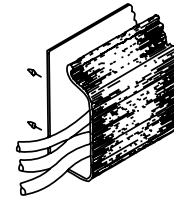

W1

Horizontal J-channel

Horizontal J-Channel wire management (Sku: W-1) is sold separately to conceal wire under worksurfaces.

Standard grommet location reference



Desk  
Specify Right or Left Grommet

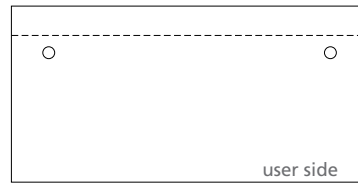

6" Overhang Desk  
Specify Right or Left Grommet

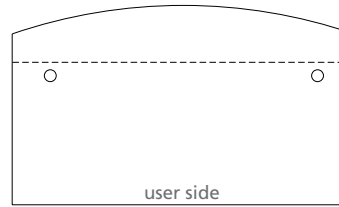

6"/12" Bow Front Desk  
Specify Right or Left Grommet



Bullet Conference Desk (Right Post)  
Center Grommet

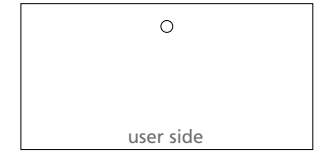

Bridge  
Center Grommet

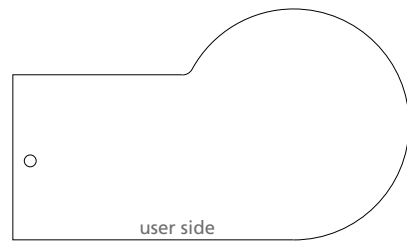

P Conference Desk (Right Post)  
Center Grommet

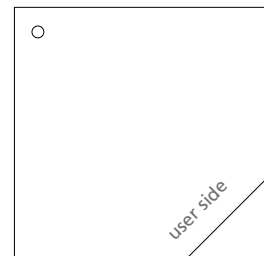

Corner  
Center Grommet



Return (Left Pedestal Shown)  
Right Pedestal - Left Grommet  
Left Pedestal - Right Grommet



Workstation Credenza  
Center Kneespace Grommet

Rift height reference

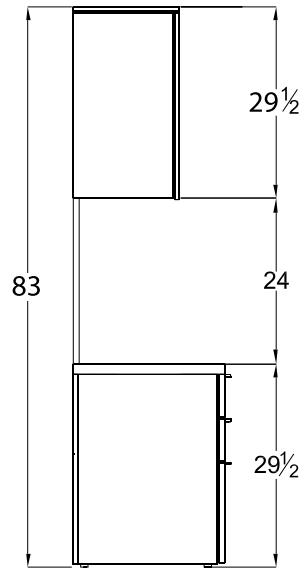

Typical Double Height Side Profile Wall Hung Overhead

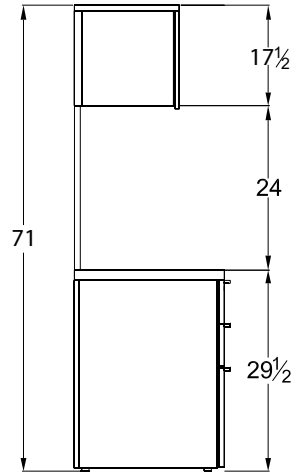

Typical Single Height Side Profile Wall Hung Overhead

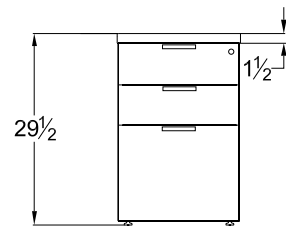

Pedestal Front Profile Box/Box/File

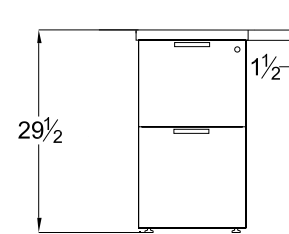

Pedestal Front Profile File/File

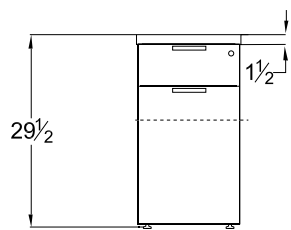

Pedestal Front Profile File/File

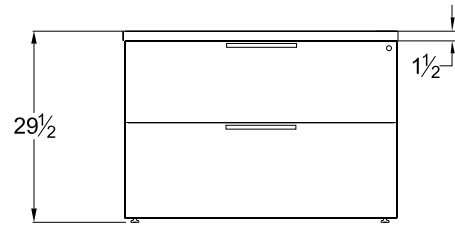

Pedestal Front Profile Lateral File

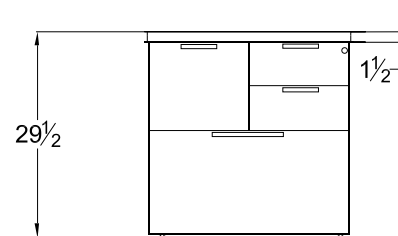

Pedestal Front Profile Multi-File

## Rift modesty reference | grain direction

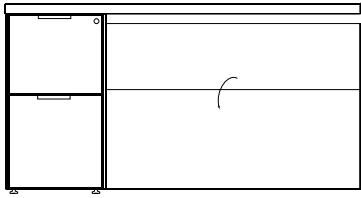

**M34**  
Drop Door Tech Modesty

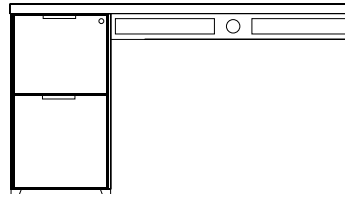
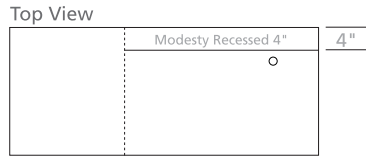

**M51**  
Open Back Modesty with 4" Wire Management Rail

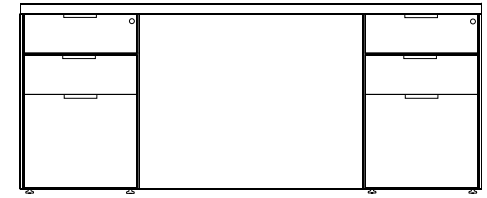

**M37**  
Fixed Full Modesty

## Grain direction

Veneer chassis and doors parts are horizontal grain. Doors feature horizontal veneer in sets of 2,4, and 6 doors. Tower fronts are matched in horizontal sets.

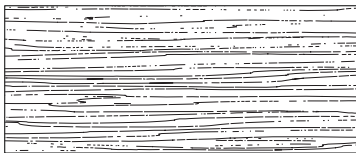

Desk

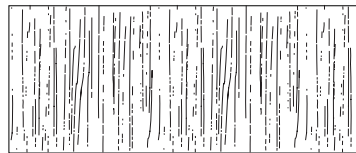

Runoff Desk

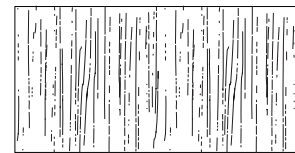

Bridge



Credenza

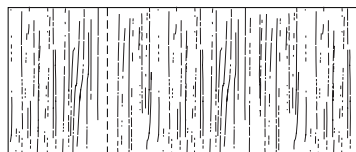

Return

## Rift drawer dimensions | filing reference

### Interior drawer dimensions

UNIT DEPTH	DRAWER	OVERALL DIM			INTERIOR DIM			NOTES
		W	D	H	W	D	H	
10" W	30" Box	7-1/2	19-11/16	4	6-1/2	18-11/16	3-7/16	60" x 30" Workstation Desk
	30" File	7-1/2	19-11/16	9-13/16	6-1/2	18-11/16	9-5/16	60" x 30" Workstation Desk
15-5/8" Letter	30" Box	13-1/8	19-11/16	4	12-1/8	18-11/16	3-7/16	Units less than 72"
	30" File	13-1/8	19-11/16	9-13/16	12-1/8	18-11/16	9-5/16	Units less than 72"
	22" Box	13-1/8	16-1/16	4	12-1/8	15-1/16	3-7/16	Units less than 72"
	22" File	13-1/8	16-1/16	9-13/16	12-1/8	15-1/16	9-5/16	Units less than 72"
18-9/16" Legal	36" Box	16-1/6	19-11/16	4	12-1/8	18-11/16	3-7/16	Units 72" & above
	36" File	16-1/6	19-11/16	9-13/16	12-1/8	18-11/16	9-5/16	Units 72" & above
	30" Box	16-1/6	19-11/16	4	12-1/8	18-11/16	3-7/16	Units 72" & above
	30" File	16-1/6	19-11/16	9-13/16	12-1/8	18-11/16	9-5/16	Units 72" & above
	22" Box	16-1/6	16-1/16	4	12-1/8	15-1/16	3-7/16	Units less than 72"
	22" File	16-1/6	16-1/16	9-13/16	12-1/8	15-1/16	9-5/16	Units less than 72"
30" Lateral	22" Box	27-1/2	16-1/16	4	25-1/2	15-1/16	9-5/16	Workstation Credenzas less than 82"
	22" File	26-1/2	16-1/16	9-13/16	25-1/2	15-1/16	9-5/16	Workstation Credenzas less than 82"
36" Lateral	22" Box	33-1/2	16-1/16	4	32-1/2	15-1/16	3-7/16	Workstation Credenzas over 83"
	22" File	33-1/2	16-1/16	9-13/16	32-1/2	15-1/16	9-5/16	Workstation Credenzas over 83"
42" Lateral	22" Box	39-1/2	16-1/16	9-13/16	38-1/2	15-1/16	9-5/16	

### Filing for 24" depth units

13" Wide File Drawer - 16" Deep

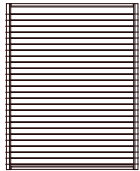

Letter Front to Back

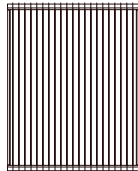

Legal Side to Side  
with File Rail

### 29" Lateral file drawer

26-1/2" Wide File Drawer - 16-1/16" Deep

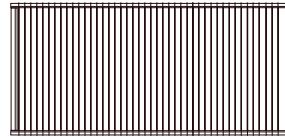

Legal Side to Side

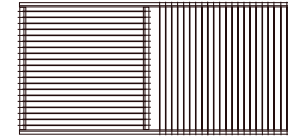

Legal Side to Side  
Letter Front to Back  
with File Rail



Letter Front to Back  
with File Rail

### FILING FOR 30" & 36" DEPTH UNITS

13" Wide File Drawer - 20" Deep

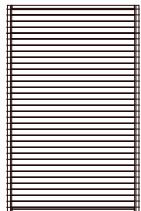

Letter Front to Back

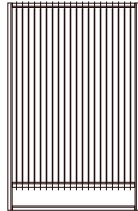

Legal Side to Side  
with File Rail

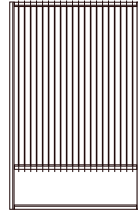

Letter Side to Side  
with File Rail

### 35" LATERAL FILE DRAWER

32-1/2" Wide File Drawer - 16-1/16" Deep

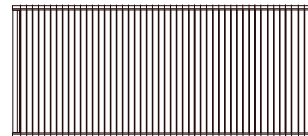

Legal Side to Side

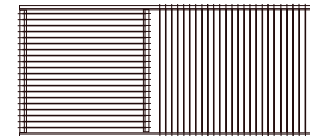

Legal Side to Side  
Letter Front to Back  
with File Rail

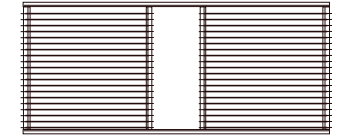

Letter Front to Back  
with File Rail

Rift.

Double Pedestal Desks  
Breakfront Chassis

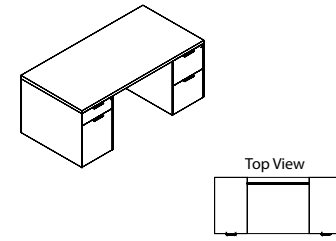

[View statement of line](#)

1 Select a model w" x d" x h"	weight	Standard Veneer Top Standard Veneer Chassis	Premium Veneer Top Premium Veneer Chassis	High Pressure Laminate Top Veneer Chassis	Thermally Fused Laminate Top Thermally Fused Laminate Chassis
<p><b>Legal Width Double Letter Filing</b></p> <p>84 x 36 x 29.5    360 "W" Option N/A</p> <p>72 x 36 x 29.5    325 "W" Option N/A</p> <p><b>Letter Width Legal / Letter Filing</b></p> <p>66 x 30 x 29.5    295 "W" Option N/A</p> <p>60 x 30 x 29.5    275 "W" Option N/A</p>					
			<p>RFT8436DD000P    4939</p> <p>RFT7236DD000P    4606</p>	<p>"G" Option N/A</p> <p>"G" Option N/A</p>	<p>"M" Option N/A</p> <p>"M" Option N/A</p>
			<p>RFT6630DD000P    4326</p> <p>RFT6030DD000P    4170</p>	<p>"G" Option N/A</p> <p>"G" Option N/A</p>	<p>"M" Option N/A</p> <p>"M" Option N/A</p>
2 Select a finish <a href="#">View finish details</a>			<p>TBCO</p> <p>TBSW</p> <p>TSTV</p> <p>TSMV</p> <p>TSLV</p> <p>TOBW</p>		
3 Select a edge <a href="#">View edge details</a>			<p>Edge</p> <p>N/A</p>		
4 Select hardware <a href="#">View hardware details</a>			<p>PL-300 Matte Chrome</p> <p>PL-301 Matte Chrome</p> <p>PL-304 Matte Chrome</p> <p>PL-305 Matte Chrome</p>	<p>PL-302 White</p> <p>PL-303 White</p> <p>PL-306 White</p> <p>PL-307 White</p>	

Product features.

- 1-5/16" Thick work surface
- Box/Hidden Box/File pedestal and File/File pedestal
- Locking drawers
- Fronts and approach panels are recessed leaving 3/8" "thin" profile
- Soft close suspension drawer(s)
- Solid lumber core banded end panels

NOTES

- 6" Recessed Modesty

Options.

ACCESSORIES

- K1R: Center Drawer - \$290
- K28: Articulating Keyboard w/ Mouse - \$390

FLUSH FRONT CHASSIS

- MODCX: Breakfront chassis converted to flush front chassis - n/c

GROMMET (STANDARD LOCATION)

Specify Color and Location Right/Left - \$50 ea.

- Black: TM30-R (Right), TM30-L (Left)
- Silver: TM31-R (Right), TM31-L (Left)
- White: TM34-R (Right), TM34-L (Left)

GROMMETS (NON-STANDARD LOCATION)

Provide drawing w/ Grommet Location and Specify Color - \$95 ea.

- TM30-NS: Black Specify Location
- TM31-NS: Silver Specify Location
- TM34-NS: White Specify Location

# Rift.

## Double Pedestal Desks Bowfront Top Breakfront Chassis

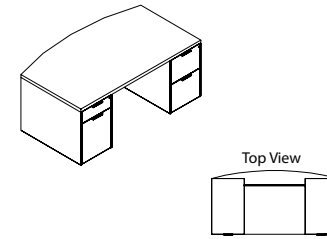

[View statement of line](#)

1 Select a model w" x d" x h"	weight	Standard Veneer Top	Premium Veneer Top	High Pressure Laminate Top	Thermally Fused Laminate Top
		Standard Veneer Chassis	Premium Veneer Chassis	Veneer Chassis	Thermally Fused Laminate Chassis
<b>Legal Width Double Letter Filing</b>					
84 x 30/36 x 29.5	360	"W" Option N/A	RFT8436DD006P 5324	"G" Option N/A	"M" Option N/A
72 x 30/36 x 29.5	330	"W" Option N/A	RFT7236DD006P 5222	"G" Option N/A	"M" Option N/A
66 x 30/36 x 29.5	325	"W" Option N/A	RFT6636DD006P 4982	"G" Option N/A	"M" Option N/A
60 x 30/36 x 29.5	275	"W" Option N/A	RFT6036DD006P 4853	"G" Option N/A	"M" Option N/A
		TBCO			
		TBSW			
		TSTV			
		TSMV			
		TSLV			
		TOBW			
3 Select a edge <a href="#">View edge details</a>		Edge			
		N/A			
4 Select hardware <a href="#">View hardware details</a>					

## Product features.

- 1-5/16" Thick work surface
- Box/Hidden Box/File pedestal and File/File pedestal
- Locking drawers
- Fronts and approach panels are recessed leaving 3/8" "thin" profile
- Soft close suspension drawer(s)
- Solid lumber core banded end panels

### NOTES

- 12" Recessed Modesty

## Options.

### ACCESSORIES

- K1R: Center Drawer - \$290
- K28: Articulating Keyboard w/ Mouse - \$390

### GROMMET (STANDARD LOCATION)

Specify Color and Location Right/Left - \$50 ea.

- Black: TM30-R (Right), TM30-L (Left)
- Silver: TM31-R (Right), TM31-L (Left)
- White: TM34-R (Right), TM34-L (Left)

### GROMMETS (NON-STANDARD LOCATION)

Provide drawing w/ Grommet Location and Specify Color - \$95 ea.

- TM30-NS: Black Specify Location
- TM31-NS: Silver Specify Location
- TM34-NS: White Specify Location

Rift.

Double Pedestal Desks  
Overhang/Flush Chassis

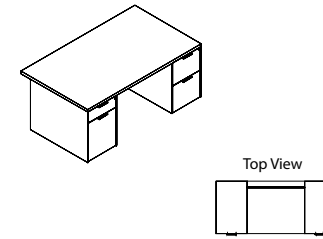

[View statement of line](#)

1 Select a model w" x d" x h"	weight	Standard Veneer Top	Premium Veneer Top	High Pressure Laminate Top	Thermally Fused Laminate Top
		Standard Veneer Chassis	Premium Veneer Chassis	Veneer Chassis	Thermally Fused Laminate Chassis
<b>Legal Width Double Letter Filing</b>					
84 x 36 x 29.5	310	"W" Option N/A	RFT8436DD032P 4741	"G" Option N/A	"M" Option N/A
72 x 36 x 29.5	275	"W" Option N/A	RFT7236DD032P 4530	"G" Option N/A	"M" Option N/A
66 x 36 x 29.5	255	"W" Option N/A	RFT6636DD032P 4286	"G" Option N/A	"M" Option N/A
60 x 36 x 29.5	235	"W" Option N/A	RFT6036DD032P 4155	"G" Option N/A	"M" Option N/A
2 Select a finish <a href="#">View finish details</a>		TBCO TBSW TSTV TSMV TSLV TOBW			
3 Select a edge <a href="#">View edge details</a>		Edge N/A			
4 Select hardware <a href="#">View hardware details</a>					

Product features.

- 1-5/16" Thick work surface
- Box/Hidden Box/File pedestals
- Locking drawers
- Fronts and approach panels are recessed leaving 3/8" "thin" profile
- Soft close suspension drawer(s)
- Solid lumber core banded end panels

NOTES

- 6" Overhang

Options.

ACCESSORIES

- K1R: Center Drawer - \$290
- K28: Articulating Keyboard w/ Mouse - \$390

FLUSH FRONT CHASSIS

- MODCX: Breakfront chassis converted to flush front chassis - n/c

GROMMET (STANDARD LOCATION)

Specify Color and Location Right/Left - \$50 ea.

- Black: TM30-R (Right), TM30-L (Left)
- Silver: TM31-R (Right), TM31-L (Left)
- White: TM34-R (Right), TM34-L (Left)

GROMMETS (NON-STANDARD LOCATION)

Provide drawing w/ Grommet Location and Specify Color - \$95 ea.

- TM30-NS: Black Specify Location
- TM31-NS: Silver Specify Location
- TM34-NS: White Specify Location



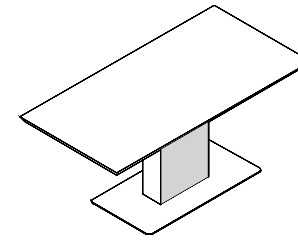

# Rift.

Conference Table Desk  
Rectangle Table Desk With Column Base



[View statement of line](#)

1 Select a model w" x d" x h"	weight	Standard Veneer Top	Premium Veneer Top	High Pressure Laminate Top	Thermally Fused Laminate Top
		Standard Veneer Chassis	Premium Veneer Chassis	Veneer Chassis	Thermally Fused Laminate Chassis
72 x 36 x 29.5	210	"W" Option N/A	RFT7236DT090P 4600	"G" Option N/A	"M" Option N/A
66 x 36 x 29.5	200	"W" Option N/A	RFT6636DT090P 4384	"G" Option N/A	"M" Option N/A
54 x 30 x 29.5	190	"W" Option N/A	RFT5430DT090P 4149	"G" Option N/A	"M" Option N/A
2 Select a finish <a href="#">View finish details</a>		TBCO TBSW TSTV TSMV TSLV TOBW			
3 Select a edge <a href="#">View edge details</a>		 Flat  Rift			
4 Select hardware <a href="#">View hardware details</a>		Hardware N/A			

## Product features.

- 1-5/16" Thick work surface
- Beveled Rift edge standard, Flat edge is optional
- Steel column with accent wood panel insert offset for increased kneespace area
- Steel platform with self-leveling cushion bottom

### NOTES

- Optional height adjustment. See options.
- Power cord is 10'

## Options.

### HEIGHT ADJUSTABLE LIFT

- LFT00: Electric Operate Sit/Stand Lift Height Adjustable Lift (Adjusts from 29"-49") - \$2105

### GROMMET (STANDARD LOCATION)

Specify Color and Location Right/Left - \$50 ea.

- Black: TM30-R (Right), TM30-L (Left)
- Silver: TM31-R (Right), TM31-L (Left)
- White: TM34-R (Right), TM34-L (Left)

### GROMMETS (NON-STANDARD LOCATION)

Provide drawing w/ Grommet Location and Specify Color - \$95 ea.

- TM30-NS: Black Specify Location
- TM31-NS: Silver Specify Location
- TM34-NS: White Specify Location

# Rift.

## Conference Table Square Conference Table With Column

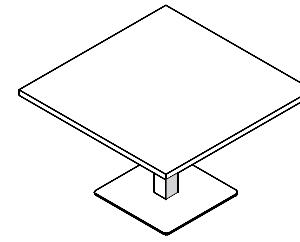

1 Select a model w" x d" x h"	weight	Standard Veneer Top	Premium Veneer Top	High Pressure Laminate Top	Thermally Fused Laminate Top
		Standard Veneer Chassis	Premium Veneer Chassis	Veneer Chassis	Thermally Fused Laminate Chassis
48 x 48 x 29.5	160	"W" Option N/A	RFT4848DT088P 2924	"G" Option N/A	"M" Option N/A
42 x 42 x 29.5	150	"W" Option N/A	RFT4242DT088P 2814	"G" Option N/A	"M" Option N/A
36 x 36 x 29.5	140	"W" Option N/A	RFT3636DT088P 2725	"G" Option N/A	"M" Option N/A
30 x 30 x 29.5	135	"W" Option N/A	RFT3030DT088P 2608	"G" Option N/A	"M" Option N/A
2 Select a finish <a href="#">View finish details</a>			TBCO TBSW TSTV TSMV TSLV TOBW		
3 Select a edge <a href="#">View edge details</a>			 Flat		
4 Select hardware <a href="#">View hardware details</a>			Hardware N/A		

[View statement of line](#)

### Product features.

- 1-5/16" Thick work surface
- 4" x 4" Steel column with accent wood panel insert centered under top
- Flat edge standard
- Steel platform with self-leveling cushion bottom

# Rift.

## Conference Table Round Conference Table With Column

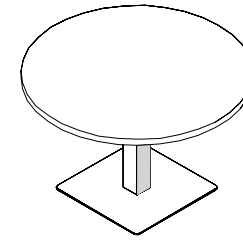

1 Select a model w" x d" x h"	weight	Standard Veneer Top	Premium Veneer Top	High Pressure Laminate Top	Thermally Fused Laminate Top
		Standard Veneer Chassis	Premium Veneer Chassis	Veneer Chassis	Thermally Fused Laminate Chassis
48 DIA x 29.5	160	"W" Option N/A	RFT4848DT089P 2924	"G" Option N/A	"M" Option N/A
42 DIA x 29.5	150	"W" Option N/A	RFT4242DT089P 2814	"G" Option N/A	"M" Option N/A
36 DIA x 29.5	140	"W" Option N/A	RFT3636DT089P 2725	"G" Option N/A	"M" Option N/A
30 DIA x 29.5	135	"W" Option N/A	RFT3030DT089P 2608	"G" Option N/A	"M" Option N/A
			TBCO TBSW TSTV TSMV TSLV TOBW		
3 Select a edge <a href="#">View edge details</a>			 Flat		
4 Select hardware <a href="#">View hardware details</a>			Hardware N/A		

[View statement of line](#)

### Product features.

- 1-5/16" Thick work surface
- 4" x 4" Steel column with accent wood panel insert centered under top
- Flat edge standard
- Steel platform with self-leveling cushion bottom

Rift.

Table Desks  
Metal Sleigh

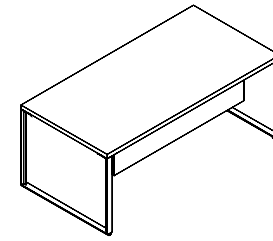

1 Select a model w" x d" x h"	weight	Standard Veneer Top	Premium Veneer Top	High Pressure Laminate Top	Thermally Fused Laminate Top
		Standard Veneer Chassis	Premium Veneer Chassis	Veneer Chassis	Thermally Fused Laminate Chassis
72 x 36 x 29.5	145	"W" Option N/A	RFT7236DT092P 4416	"G" Option N/A	"M" Option N/A
66 x 30 x 29.5	135	"W" Option N/A	RFT6630DT092P 4228	"G" Option N/A	"M" Option N/A
60 x 30 x 29.5	125	"W" Option N/A	RFT6030DT092P 4188	"G" Option N/A	"M" Option N/A
2 Select a finish <a href="#">View finish details</a>		TBCO TBSW TSTV TSMV TSLV TOBW			
3 Select an edge <a href="#">View edge details</a>		 Flat			
4 Select hardware <a href="#">View hardware details</a>		Hardware N/A			

[View statement of line](#)

Product features.

- 1-5/16" Thick work surface
- Floating 1/2 height modesty panel. Recessed 6"
- Steel sleigh bases

NOTES

- Wood insert end panels available for additional privacy

Options.

ACCESSORIES

- K1R: Center Drawer - \$290
- K28: Articulating Keyboard w/ Mouse - \$390

GROMMET (STANDARD LOCATION)

Specify Color and Location Right/Left - \$50 ea.

- Black: TM30-R (Right), TM30-L (Left)
- Silver: TM31-R (Right), TM31-L (Left)
- White: TM34-R (Right), TM34-L (Left)

GROMMETS (NON-STANDARD LOCATION)

Provide drawing w/ Grommet Location and Specify Color - \$95 ea.

- TM30-NS: Black Specify Location
- TM31-NS: Silver Specify Location
- TM34-NS: White Specify Location

MODESTY

- DM: Delete Modesty - n/c

PREMIUM FINISH OPTION

- MFW: White metal finish - \$160 per base

WOOD INSERT PANEL

- PWIF: Wood Finish Panel - \$340 each
- PWIW: White Paint Panel - \$415 each

Rift.

Workstation Desks  
Rectangle Top Breakfront Chassis

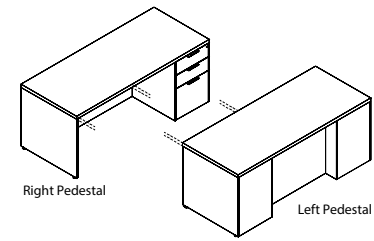

1 Select a model  
w" x d" x h"

weight	Standard Veneer Top Standard Veneer Chassis	Premium Veneer Top Premium Veneer Chassis	High Pressure Laminate Top Veneer Chassis	Thermally Fused Laminate Top Thermally Fused Laminate Chassis
<b>Left Pedestal</b>				
84 x 36 x 29.5	320 "W" Option N/A	RFT8436DS009P 4526	"G" Option N/A	"M" Option N/A
72 x 36 x 29.5	290 "W" Option N/A	RFT7236DS009P 4141	"G" Option N/A	"M" Option N/A
72 x 30 x 29.5	265 "W" Option N/A	RFT7230DS009P 3996	"G" Option N/A	"M" Option N/A
66 x 30 x 29.5	240 "W" Option N/A	RFT6630DS009P 3849	"G" Option N/A	"M" Option N/A
<b>Right Pedestal</b>				
84 x 36 x 29.5	320 "W" Option N/A	RFT8436DS010P 4526	"G" Option N/A	"M" Option N/A
72 x 36 x 29.5	290 "W" Option N/A	RFT7236DS010P 4141	"G" Option N/A	"M" Option N/A
72 x 30 x 29.5	265 "W" Option N/A	RFT7230DS010P 3996	"G" Option N/A	"M" Option N/A
66 x 30 x 29.5	240 "W" Option N/A	RFT6630DS010P 3849	"G" Option N/A	"M" Option N/A
		TBCO TBSW TSTV TSMV TSLV TOBW		
		Edge N/A		

[View statement of line](#)

2 Select a finish  
[View finish details](#)

3 Select a edge  
[View edge details](#)

4 Select hardware  
[View hardware details](#)

Product features.

- 1-5/16" Thick work surface
- Box/box/file drawers standard
- Fronts and approach panels are recessed leaving 3/8" "thin" profile
- Soft close suspension drawer(s)
- Solid lumber core banded end panels

NOTES

- 6" recessed modesty
- Metal legs not available on Workstation Desks

Options.

ACCESSORIES

- K1R: Center Drawer - \$290
- K28: Articulating Keyboard w/ Mouse - \$390

DRAWER

- P6: Modify Box/Box/File to File/File - \$55 per pedestal
- WPD3061: Designer White - \$80 per pedestal

FLUSH FRONT CHASSIS

- MODCX: Breakfront chassis converted to flush front chassis - n/c

GROMMET (STANDARD LOCATION)

Specify Color and Location Right/Left - \$50 ea.

- Black: TM30-R (Right), TM30-L (Left)
- Silver: TM31-R (Right), TM31-L (Left)
- White: TM34-R (Right), TM34-L (Left)

GROMMETS (NON-STANDARD LOCATION)

Provide drawing w/ Grommet Location and Specify Color - \$95 ea.

- TM30-NS: Black Specify Location
- TM31-NS: Silver Specify Location
- TM34-NS: White Specify Location

# Rift.

Workstation Desks  
Rectangle Overhang Top Flush Chassis

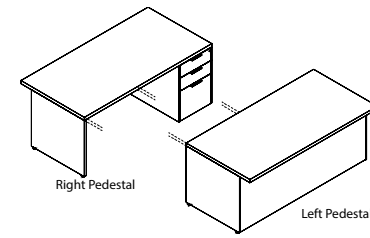

[View statement of line](#)

1 Select a model w" x d" x h"	weight	Standard Veneer Top	Premium Veneer Top	High Pressure Laminate Top	Thermally Fused Laminate Top
		Standard Veneer Chassis	Premium Veneer Chassis	Veneer Chassis	Thermally Fused Laminate Chassis
<b>Left Pedestal</b>					
84 x 36 x 29.5	340	"W" Option N/A	RFT8436DS640P 4216	"G" Option N/A	"M" Option N/A
72 x 36 x 29.5	310	"W" Option N/A	RFT7236DS640P 4080	"G" Option N/A	"M" Option N/A
66 x 36 x 29.5	270	"W" Option N/A	RFT6636DS640P 3831	"G" Option N/A	"M" Option N/A
<b>Right Pedestal</b>					
84 x 36 x 29.5	340	"W" Option N/A	RFT8436DS639P 4216	"G" Option N/A	"M" Option N/A
72 x 36 x 29.5	310	"W" Option N/A	RFT7236DS639P 4080	"G" Option N/A	"M" Option N/A
66 x 36 x 29.5	270	"W" Option N/A	RFT6636DS639P 3831	"G" Option N/A	"M" Option N/A
		TBCO TBSW TSTV TSMV TSLV TOBW			
3 Select a edge <a href="#">View edge details</a>		Edge N/A			
4 Select hardware <a href="#">View hardware details</a>					

## Product features.

- 1-5/16" Thick work surface
- Box/box/file drawers standard
- Flush front modesty
- Fronts and approach panels are recessed leaving 3/8" "thin" profile
- Soft close suspension drawer(s)
- Solid lumber core banded end panels

### NOTES

- 6" overhang
- Metal legs not available on Workstation Desks

## Options.

### ACCESSORIES

- K1R: Center Drawer - \$290
- K28: Articulating Keyboard w/ Mouse - \$390

### DRAWER

- P6: Modify Box/Box/File to File/File - \$55 per pedestal
- WPD3061: Designer White - \$80 per pedestal

### GROMMET (STANDARD LOCATION)

- Specify Color and Location Right/Left - \$50 ea.
- Black: TM30-R (Right), TM30-L (Left)
  - Silver: TM31-R (Right), TM31-L (Left)
  - White: TM34-R (Right), TM34-L (Left)

### GROMMETS (NON-STANDARD LOCATION)

- Provide drawing w/ Grommet Location and Specify Color - \$95 ea.
- TM30-NS: Black Specify Location
  - TM31-NS: Silver Specify Location
  - TM34-NS: White Specify Location

Rift.

Workstation Conference Desks  
Rectangle

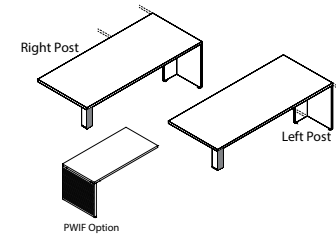

[View statement of line](#)

1 Select a model w" x d" x h"	weight	Standard Veneer Top	Premium Veneer Top	High Pressure Laminate Top	Thermally Fused Laminate Top
		Standard Veneer Chassis	Premium Veneer Chassis	Veneer Chassis	Thermally Fused Laminate Chassis
<b>Left Post</b>					
84 x 36 x 29.5	175	"W" Option N/A	RFT8436DC767P 3640	"G" Option N/A	"M" Option N/A
72 x 36 x 29.5	160	"W" Option N/A	RFT7236DC767P 3363	"G" Option N/A	"M" Option N/A
72 x 30 x 29.5	150	"W" Option N/A	RFT7230DC767P 3270	"G" Option N/A	"M" Option N/A
66 x 30 x 29.5	125	"W" Option N/A	RFT6630DC767P 3176	"G" Option N/A	"M" Option N/A
60 x 30 x 29.5	110	"W" Option N/A	RFT6030DC767P 3131	"G" Option N/A	"M" Option N/A
<b>Right Post</b>					
84 x 36 x 29.5	175	"W" Option N/A	RFT8436DC766P 3640	"G" Option N/A	"M" Option N/A
72 x 36 x 29.5	160	"W" Option N/A	RFT7236DC766P 3363	"G" Option N/A	"M" Option N/A
72 x 30 x 29.5	150	"W" Option N/A	RFT7230DC766P 3270	"G" Option N/A	"M" Option N/A
66 x 30 x 29.5	125	"W" Option N/A	RFT6630DC766P 3176	"G" Option N/A	"M" Option N/A
60 x 30 x 29.5	110	"W" Option N/A	RFT6030DC766P 3131	"G" Option N/A	"M" Option N/A
<b>2 Select a finish</b> <a href="#">View finish details</a>			TBCO TBSW TSTV TSMV TSLV TOBW		
<b>3 Select a edge</b> <a href="#">View edge details</a>			Edge N/A		
<b>4 Select hardware</b> <a href="#">View hardware details</a>			Hardware N/A		

Product features.

- 1-5/16" Thick work surface
- 4" Silver square steel H post with finished wood insert detail

Options.

**ACCESSORIES**

- K1R: Center Drawer - \$290
- K2R: Center Drawer w/ Skirt - \$390
- K28: Articulating Keyboard w/ Mouse - \$390

**GROMMET (STANDARD LOCATION)**

Specify Color - \$50 ea.

- Black: TM30-C (Center)
- Silver: TM31-C (Center)
- White: TM34-C (Center)

**GROMMETS (NON-STANDARD LOCATION)**

Provide drawing w/ Grommet Location and Specify Color - \$95 ea.

- TM30-NS: Black Specify Location
- TM31-NS: Silver Specify Location
- TM34-NS: White Specify Location

**LEG OPTIONS**

- RSB23R: Metal Sleigh Base - \$205
- PWIF: Wood Finish Panel Insert for Sleigh Base - \$340

**MODESTY**

- HM1: Veneer half modesty - \$205

**PREMIUM FINISH OPTION**

- MFW: White metal finish - \$160 per base

Rift.

Workstation/Bench Runoff Conference Desks  
Rectangle Metal Sleigh Support

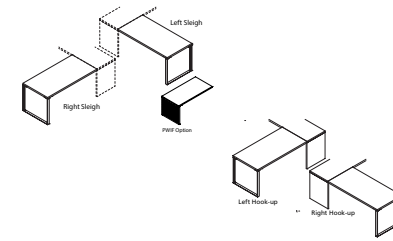

[View statement of line](#)

1 Select a model w" x d" x h"	weight	Standard Veneer Top	Premium Veneer Top	High Pressure Laminate Top	Thermally Fused Laminate Top
		Standard Veneer Chassis	Premium Veneer Chassis	Veneer Chassis	Thermally Fused Laminate Chassis
<b>Left Sleigh</b>					
84 x 36 x 29.5	205	"W" Option N/A	RFT8436DR779P 4302	"G" Option N/A	"M" Option N/A
84 x 30 x 29.5	195	"W" Option N/A	RFT8430DR779P 4127	"G" Option N/A	"M" Option N/A
78 x 36 x 29.5	185	"W" Option N/A	RFT7836DR779P 4122	"G" Option N/A	"M" Option N/A
78 x 30 x 29.5	175	"W" Option N/A	RFT7830DR779P 3948	"G" Option N/A	"M" Option N/A
72 x 30 x 29.5	165	"W" Option N/A	RFT7230DR779P 3489	"G" Option N/A	"M" Option N/A
66 x 30 x 29.5	155	"W" Option N/A	RFT6630DR779P 3420	"G" Option N/A	"M" Option N/A
60 x 30 x 29.5	145	"W" Option N/A	RFT6030DR779P 3348	"G" Option N/A	"M" Option N/A
<b>Right Sleigh</b>					
84 x 36 x 29.5	205	"W" Option N/A	RFT8436DR778P 4302	"G" Option N/A	"M" Option N/A
84 x 30 x 29.5	195	"W" Option N/A	RFT8430DR778P 4127	"G" Option N/A	"M" Option N/A
78 x 36 x 29.5	185	"W" Option N/A	RFT7836DR778P 4122	"G" Option N/A	"M" Option N/A
78 x 30 x 29.5	175	"W" Option N/A	RFT7830DR778P 3948	"G" Option N/A	"M" Option N/A
72 x 30 x 29.5	165	"W" Option N/A	RFT7230DR778P 3489	"G" Option N/A	"M" Option N/A
66 x 30 x 29.5	155	"W" Option N/A	RFT6630DR778P 3420	"G" Option N/A	"M" Option N/A
60 x 30 x 29.5	145	"W" Option N/A	RFT6030DR778P 3348	"G" Option N/A	"M" Option N/A
<b>2 Select a finish</b> <a href="#">View finish details</a>			TBCO TBSW TSTV TSMV TSLV TOBW		
<b>3 Select a edge</b> <a href="#">View edge details</a>			Edge N/A		
<b>4 Select hardware</b> <a href="#">View hardware details</a>			Hardware N/A		

Product features.

- 1-5/16" Thick work surface
- Silver steel sleigh leg standard

NOTES

- Must order Bench Hook-up Support when runoff extends over bench credenza (CA062 or CA063)
- Must be hooked to freestanding unit

Options.

ACCESSORIES

- K1R: Center Drawer - \$290
- K2R: Center Drawer w/ Skirt - \$390
- K28: Articulating Keyboard w/ Mouse - \$390

BENCH HOOK-UP SUPPORT

- BRS30: Runoff desk support for 30" deep top - \$390
- BRS36: Runoff Desk Support for 36" deep top - \$390

GROMMET (STANDARD LOCATION)

- Specify Color - \$50 ea.
- Black: TM30-C (Center)
- Silver: TM31-C (Center)
- White: TM34-C (Center)

GROMMETS (NON-STANDARD LOCATION)

- Provide drawing w/ Grommet Location and Specify Color - \$95 ea.
- TM30-NS: Black Specify Location
- TM31-NS: Silver Specify Location
- TM34-NS: White Specify Location

MODESTY

- HM1: Veneer half modesty - \$205

PREMIUM FINISH OPTION

- MFW: White metal finish - \$160 per base

SLEIGH BASE PANEL INSERT

- PWF: Wood Finish Panel - \$325
- PWIW: White Paint Panel - \$395



Rift.

Workstation Runoff Conference  
Rectangle Post Support

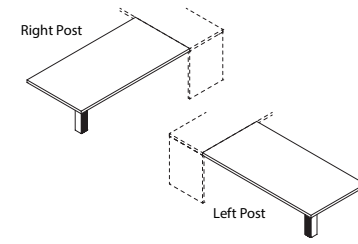

[View statement of line](#)

1 Select a model w" x d" x h"	weight	Standard Veneer Top	Premium Veneer Top	High Pressure Laminate Top	Thermally Fused Laminate Top
		Standard Veneer Chassis	Premium Veneer Chassis	Veneer Chassis	Thermally Fused Laminate Chassis
<b>Left Post</b>					
84 x 36 x 29.5	205	"W" Option N/A	RFT8436DR771P 3641	"G" Option N/A	"M" Option N/A
84 x 30 x 29.5	195	"W" Option N/A	RFT8430DR771P 3467	"G" Option N/A	"M" Option N/A
78 x 36 x 29.5	185	"W" Option N/A	RFT7836DR771P 3460	"G" Option N/A	"M" Option N/A
78 x 30 x 29.5	175	"W" Option N/A	RFT7830DR771P 3285	"G" Option N/A	"M" Option N/A
72 x 30 x 29.5	165	"W" Option N/A	RFT7230DR771P 3217	"G" Option N/A	"M" Option N/A
66 x 30 x 29.5	155	"W" Option N/A	RFT6630DR771P 3147	"G" Option N/A	"M" Option N/A
60 x 30 x 29.5	145	"W" Option N/A	RFT6030DR771P 3077	"G" Option N/A	"M" Option N/A
<b>Right Post</b>					
84 x 36 x 29.5	205	"W" Option N/A	RFT8436DR770P 3641	"G" Option N/A	"M" Option N/A
84 x 30 x 29.5	195	"W" Option N/A	RFT8430DR770P 3467	"G" Option N/A	"M" Option N/A
78 x 36 x 29.5	185	"W" Option N/A	RFT7836DR770P 3460	"G" Option N/A	"M" Option N/A
78 x 30 x 29.5	175	"W" Option N/A	RFT7830DR770P 3285	"G" Option N/A	"M" Option N/A
72 x 30 x 29.5	165	"W" Option N/A	RFT7230DR770P 3217	"G" Option N/A	"M" Option N/A
66 x 30 x 29.5	155	"W" Option N/A	RFT6630DR770P 3147	"G" Option N/A	"M" Option N/A
60 x 30 x 29.5	145	"W" Option N/A	RFT6030DR770P 3077	"G" Option N/A	"M" Option N/A
2 Select a finish <a href="#">View finish details</a>			TBCO TBSW TSTV TSMV TSLV TOBW		
3 Select a edge <a href="#">View edge details</a>			Edge N/A		
4 Select hardware <a href="#">View hardware details</a>			Hardware N/A		

Product features.

- 1-5/16" Thick work surface
- 4" Silver square steel H post with finished wood insert

NOTES

- Must order Bench Hook-up Support when runoff extends over bench credenza (CA062 or CA063)
- Must be hooked to freestanding unit

Options.

ACCESSORIES

- K2R: Center Drawer w/ Skirt - \$390
- K28: Articulating Keyboard w/ Mouse - \$390

BENCH HOOK- UP SUPPORT

- BRS30: Runoff desk support for 30" deep top - \$390
- BRS36: Runoff Desk Support for 36" deep top - \$390

GROMMET (STANDARD LOCATION)

- Specify Color - \$50 ea.
- Black: TM30-C (Center)
  - Silver: TM31-C (Center)
  - White: TM34-C (Center)

GROMMETS (NON-STANDARD LOCATION)

- Provide drawing w/ Grommet Location and Specify Color - \$95 ea.
- TM30-NS: Black Specify Location
  - TM31-NS: Silver Specify Location
  - TM34-NS: White Specify Location

LEG OPTIONS

- RSB23R: Metal Sleigh Base - \$205
- PWIF: Wood Finish Panel Insert for Sleigh Base - \$340
- PWIW: White Paint Panel Insert for Sleigh Base- \$415

MODESTY

- HM1: Veneer half modesty - \$205

PREMIUM FINISH OPTION

- MFW: White metal finish - \$160 per base

# Rift.

Workstation/Bench Runoff Conference Desks  
Rectangle Box/Box/File

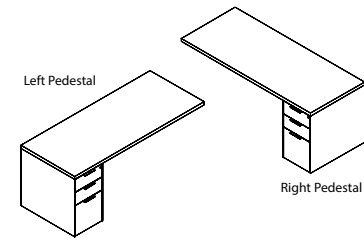

[View statement of line](#)

1 Select a model w" x d" x h"	weight	Standard Veneer Top	Premium Veneer Top	High Pressure Laminate Top	Thermally Fused Laminate Top
		Standard Veneer Chassis	Premium Veneer Chassis	Veneer Chassis	Thermally Fused Laminate Chassis
<b>Left Pedestal</b>					
84 x 30 x 29.5	220	"W" Option N/A	RFT8430DR791P 4067	"G" Option N/A	"M" Option N/A
78 x 30 x 29.5	190	"W" Option N/A	RFT7830DR791P 3948	"G" Option N/A	"M" Option N/A
72 x 30 x 29.5	160	"W" Option N/A	RFT7230DR791P 3489	"G" Option N/A	"M" Option N/A
66 x 30 x 29.5	150	"W" Option N/A	RFT6630DR791P 3420	"G" Option N/A	"M" Option N/A
<b>Right Pedestal</b>					
84 x 30 x 29.5	220	"W" Option N/A	RFT8430DR790P 4067	"G" Option N/A	"M" Option N/A
78 x 30 x 29.5	190	"W" Option N/A	RFT7830DR790P 3948	"G" Option N/A	"M" Option N/A
72 x 30 x 29.5	160	"W" Option N/A	RFT7230DR790P 3489	"G" Option N/A	"M" Option N/A
66 x 30 x 29.5	150	"W" Option N/A	RFT6630DR790P 3420	"G" Option N/A	"M" Option N/A
			TBCO TBSW TSTV TSMV TSLV TOBW		
			Edge N/A		

2 Select a finish  
[View finish details](#)

3 Select an edge  
[View edge details](#)

4 Select hardware  
[View hardware details](#)

## Product features.

- 1-5/16" Thick work surface
- Box/box/file drawers
- File drawer accommodates legal or letter
- Locking drawers
- Soft close suspension drawer(s)

### NOTES

- Must order Bench Hook-up Support when runoff extends over bench credenza (CA062 or CA063)
- Must be hooked to freestanding unit

## Options.

### ACCESSORIES

- K1R: Center Drawer - \$290
- K2R: Center Drawer w/ Skirt - \$390
- K28: Articulating Keyboard w/ Mouse - \$390

### BENCH HOOK- UP SUPPORT

- BRS30: Runoff desk support for 30" deep top - \$390

### DRAWER

- P6: Modify Box/Box/File to File/File - \$55 per pedestal
- WPD3061: Designer White - \$80 per pedestal

### GROMMET (STANDARD LOCATION)

Specify Color and Location Right/Left - \$50 ea.

- Black: TM30-R (Right), TM30-L (Left)
- Silver: TM31-R (Right), TM31-L (Left)
- White: TM34-R (Right), TM34-L (Left)

### GROMMETS (NON-STANDARD LOCATION)

Provide drawing w/ Grommet Location and Specify Color - \$95 ea.

- TM30-NS: Black Specify Location
- TM31-NS: Silver Specify Location
- TM34-NS: White Specify Location

### MODESTY

- HM1: Veneer half modesty - \$205

Rift.

"L" Workstation Returns  
Box/Hidden Box/File

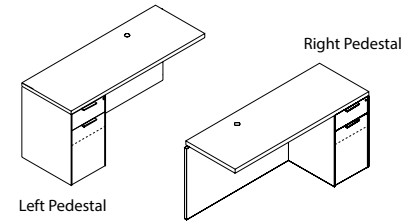

1 Select a model  
w" x d" x h"

weight

Standard Veneer Top Standard Veneer Chassis	Premium Veneer Top Premium Veneer Chassis	High Pressure Laminate Top Veneer Chassis	Thermally Fused Laminate Top Thermally Fused Laminate Chassis
60 x 22 x 29.5 190 "W" Option N/A	RFT6022RE211P 2967	"G" Option N/A	"M" Option N/A
54 x 22 x 29.5 180 "W" Option N/A	RFT5422RE211P 2891	"G" Option N/A	"M" Option N/A
48 x 22 x 29.5 170 "W" Option N/A	RFT4822RE211P 2815	"G" Option N/A	"M" Option N/A
42 x 22 x 29.5 160 "W" Option N/A	RFT4222RE211P 2739	"G" Option N/A	"M" Option N/A
<b>Right Pedestal</b>			
60 x 22 x 29.5 190 "W" Option N/A	RFT6022RE212P 2967	"G" Option N/A	"M" Option N/A
54 x 22 x 29.5 180 "W" Option N/A	RFT5422RE212P 2891	"G" Option N/A	"M" Option N/A
48 x 22 x 29.5 170 "W" Option N/A	RFT4822RE212P 2815	"G" Option N/A	"M" Option N/A
42 x 22 x 29.5 160 "W" Option N/A	RFT4222RE212P 2739	"G" Option N/A	"M" Option N/A
	TBCO TBSW TSTV TSMV TSLV TOBW		
	Edge N/A		

[View statement of line](#)

Product features.

- 1 Standard grommet - matches pull finish or specify black TM30, silver TM31 or white TM34
- Fixed Full Modesty
- Flush back hook-up detailing
- Locking drawers
- Recessed pedestal fronts
- Soft close suspension drawer(s)

NOTES

- Left pedestal gets right grommet
- Right pedestal gets left grommet
- Top grain runs same as desk

Options.

ACCESSORIES

- K1R: Center Drawer - \$290
- K28: Articulating Keyboard w/ Mouse - \$390

DRAWER

- WPD3061: Designer White - \$80 per pedestal

GROMMETS (NON-STANDARD LOCATION)

Provide drawing w/ Grommet Location and Specify Color - \$95 ea.

- TM30-NS: Black Specify Location
- TM31-NS: Silver Specify Location
- TM34-NS: White Specify Location

MODESTY

- M34T: "W" "G" Style Drop Door Tech Modesty - \$130
- M51: Open Back Modesty with Wire Mgmt Rail - Deduct \$100

2 Select a finish  
[View finish details](#)

3 Select a edge  
[View edge details](#)

4 Select hardware  
[View hardware details](#)

# Rift.

"L" Workstation Returns  
File/File

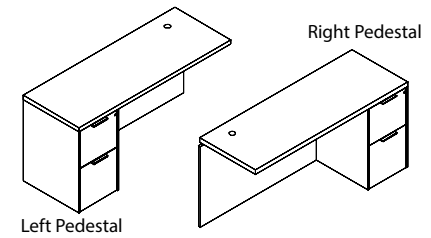

## 1 Select a model w" x d" x h"

weight	Standard Veneer Top Standard Veneer Chassis	Premium Veneer Top Premium Veneer Chassis	High Pressure Laminate Top Veneer Chassis	Thermally Fused Laminate Top Thermally Fused Laminate Chassis
<b>Left Pedestal</b>				
60 x 22 x 29.5	190 "W" Option N/A	RFT6022RE195P 2967	"G" Option N/A	"M" Option N/A
54 x 22 x 29.5	180 "W" Option N/A	RFT5422RE195P 2891	"G" Option N/A	"M" Option N/A
48 x 22 x 29.5	170 "W" Option N/A	RFT4822RE195P 2815	"G" Option N/A	"M" Option N/A
42 x 22 x 29.5	160 "W" Option N/A	RFT4222RE195P 2739	"G" Option N/A	"M" Option N/A
<b>Right Pedestal</b>				
60 x 22 x 29.5	190 "W" Option N/A	RFT6022RE196P 2967	"G" Option N/A	"M" Option N/A
54 x 22 x 29.5	180 "W" Option N/A	RFT5422RE196P 2891	"G" Option N/A	"M" Option N/A
48 x 22 x 29.5	170 "W" Option N/A	RFT4822RE196P 2815	"G" Option N/A	"M" Option N/A
42 x 22 x 29.5	160 "W" Option N/A	RFT4222RE196P 2739	"G" Option N/A	"M" Option N/A

[View statement of line](#)

## 2 Select a finish [View finish details](#)

TBCO  
TBSW  
TSTV  
TSMV  
TSLV  
TOBW

## 3 Select a edge [View edge details](#)

Edge  
N/A

## 4 Select hardware [View hardware details](#)

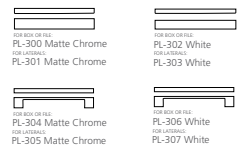

## Product features.

- 1 Standard grommet - matches pull finish or specify black TM30, silver TM31 or white TM34
- Fixed Full Modesty
- Flush back hook-up detailing
- Locking drawers
- Recessed pedestal fronts
- Soft close suspension drawer(s)

### NOTES

- Left pedestal gets right grommet
- Right pedestal gets left grommet
- Top grain runs same as desk

## Options.

### ACCESSORIES

- K1R: Center Drawer - \$290
- K28: Articulating Keyboard w/ Mouse - \$390

### DRAWER

- WPD3061: Designer White - \$80 per pedestal

### GROMMETS (NON-STANDARD LOCATION)

Provide drawing w/ Grommet Location and Specify Color - \$95 ea.

- TM30-NS: Black Specify Location
- TM31-NS: Silver Specify Location
- TM34-NS: White Specify Location

### MODESTY

- M34T: "W" "G" Style Drop Door Tech Modesty - \$130
- M51: Open Back Modesty with Wire Mgmt Rail - Deduct \$100

# Rift.

"L" Workstation Returns  
Lateral File

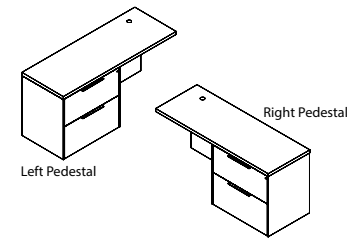

## 1 Select a model w" x d" x h"

weight

Standard Veneer Top Standard Veneer Chassis	Premium Veneer Top Premium Veneer Chassis	High Pressure Laminate Top Veneer Chassis	Thermally Fused Laminate Top Thermally Fused Laminate Chassis
<b>Left Pedestal</b>			
60 x 22 x 29.5	205 "W" Option N/A	RFT6022RE187P	3561 "G" Option N/A
54 x 22 x 29.5	190 "W" Option N/A	RFT5422RE187P	3409 "G" Option N/A
48 x 22 x 29.5	180 "W" Option N/A	RFT4822RE187P	3256 "G" Option N/A
<b>Right Pedestal</b>			
60 x 22 x 29.5	205 "W" Option N/A	RFT6022RE188P	3561 "G" Option N/A
54 x 22 x 29.5	190 "W" Option N/A	RFT5422RE188P	3409 "G" Option N/A
48 x 22 x 29.5	180 "W" Option N/A	RFT4822RE188P	3256 "G" Option N/A

[View statement of line](#)

## 2 Select a finish [View finish details](#)

TBCO  
TBSW  
TSTV  
TSMV  
TSLV  
TOBW

## 3 Select a edge [View edge details](#)

Edge  
N/A

## 4 Select hardware [View hardware details](#)

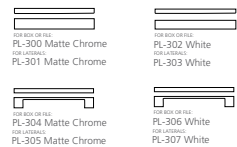

## Product features.

- 1 Standard grommet - matches pull finish or specify black TM30, silver TM31 or white TM34
- Fixed Full Modesty
- Flush back hook-up detailing
- Lateral file drawers feature Legal/Letter filing
- Locking drawers
- Recessed pedestal fronts
- Soft close suspension drawer(s)

### NOTES

- Left pedestal gets right grommet
- Right pedestal gets left grommet

## Options.

### ACCESSORIES

- K1R: Center Drawer - \$290
- K28: Articulating Keyboard w/ Mouse - \$390

### DRAWER

- WPD3061: Designer White - \$160 per pedestal

### GROMMETS (NON-STANDARD LOCATION)

Provide drawing w/ Grommet Location and Specify Color - \$95 ea.

- TM30-NS: Black Specify Location
- TM31-NS: Silver Specify Location
- TM34-NS: White Specify Location

### MODESTY

- M34T: "W" "G" Style Drop Door Tech Modesty - \$130
- M51: Open Back Modesty with Wire Mgmt Rail - Deduct \$100

Rift.

"L" Workstation Returns  
Box Box/Storage/Lateral File

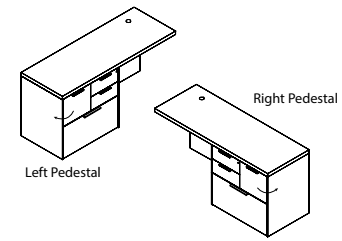

1 Select a model w" x d" x h"	weight	Standard Veneer Top	Premium Veneer Top	High Pressure Laminate Top	Thermally Fused Laminate Top
		Standard Veneer Chassis	Premium Veneer Chassis	Veneer Chassis	Thermally Fused Laminate Chassis
<b>Left Pedestal</b>					
60 x 22 x 29.5	205	"W" Option N/A	RFT6022RE218P 3813	"G" Option N/A	"M" Option N/A
54 x 22 x 29.5	190	"W" Option N/A	RFT5422RE218P 3661	"G" Option N/A	"M" Option N/A
48 x 22 x 29.5	180	"W" Option N/A	RFT4822RE218P 3509	"G" Option N/A	"M" Option N/A
<b>Right Pedestal</b>					
60 x 22 x 29.5	205	"W" Option N/A	RFT6022RE219P 3813	"G" Option N/A	"M" Option N/A
54 x 22 x 29.5	190	"W" Option N/A	RFT5422RE219P 3661	"G" Option N/A	"M" Option N/A
48 x 22 x 29.5	180	"W" Option N/A	RFT4822RE219P 3509	"G" Option N/A	"M" Option N/A
			TBCO TBSW TSTV TSMV TSLV TOBW		
			Edge N/A		

[View statement of line](#)

Product features.

- 1 Standard grommet - matches pull finish or specify black TM30, silver TM31 or white TM34
- Door beside box drawers for small personal storage
- Fixed Full Modesty
- Flush back hook-up detailing
- Locking drawers
- Recessed pedestal fronts
- Soft close suspension drawer(s)
- Top grain runs same as desk

NOTES

- Left pedestal gets right grommet
- Right pedestal gets left grommet

Options.

ACCESSORIES

- K1R: Center Drawer - \$290
- K28: Articulating Keyboard w/ Mouse - \$390

DOOR

- D2: Wood Door Lock - \$100 per door

DRAWER

- WPD3061: Designer White - \$160 per pedestal

GROMMETS (NON-STANDARD LOCATION)

- Provide drawing w/ Grommet Location and Specify Color - \$95 ea.
- TM30-NS: Black Specify Location
  - TM31-NS: Silver Specify Location
  - TM34-NS: White Specify Location

MODESTY

- M34T: "W" "G" Style Drop Door Tech Modesty - \$130
- M51: Open Back Modesty with Wire Mgmt Rail - Deduct \$95

# Rift.

Bridges  
Open Back

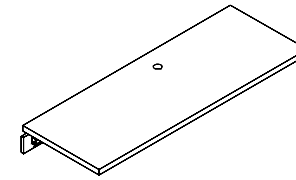

Open Back

1 Select a model w" x d" x h"	weight	Standard Veneer Top	Premium Veneer Top	High Pressure Laminate Top	Thermally Fused Laminate Top
		Standard Veneer Chassis	Premium Veneer Chassis	Veneer Chassis	Thermally Fused Laminate Chassis
60 x 22 x 29.5	70	"W" Option N/A	RFT6022BR151P 1422	"G" Option N/A	"M" Option N/A
54 x 22 x 29.5	65	"W" Option N/A	RFT5422BR151P 1324	"G" Option N/A	"M" Option N/A
48 x 22 x 29.5	60	"W" Option N/A	RFT4822BR151P 1225	"G" Option N/A	"M" Option N/A
42 x 22 x 29.5	55	"W" Option N/A	RFT4222BR151P 1150	"G" Option N/A	"M" Option N/A
2 Select a finish <i>View finish details</i>			TBCO TBSW TSTV TSMV TSLV TOBW		
3 Select a edge <i>View edge details</i>			Edge N/A		
4 Select hardware <i>View hardware details</i>			Hardware N/A		

[View statement of line](#)

## Product features.

- 1-5/16" Thick work surface
- 1 Standard grommet - matches pull finish or specify black TM30, silver TM31 or white TM34
- Flush back hook-up
- Top grain runs same as desk

## Options.

### ACCESSORIES

- K28: Articulating Keyboard w/ Mouse - \$390

### GROMMETS (NON-STANDARD LOCATION)

- Provide drawing w/ Grommet Location and Specify Color - \$95 ea.
- TM30-NS: Black Specify Location
  - TM31-NS: Silver Specify Location
  - TM34-NS: White Specify Location

### MODESTY

- M37 : "W" "G" Style Fixed Full Modesty - \$130
- M34T-O: "W" "G" Style Drop Door Tech Modesty - \$310

Rift.

Credenzas  
File/Storage

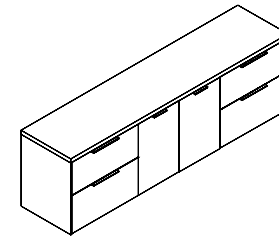

1 Select a model w" x d" x h"	weight	Standard Veneer Top Standard Veneer Chassis	Premium Veneer Top Premium Veneer Chassis	High Pressure Laminate Top Veneer Chassis	Thermally Fused Laminate Top Thermally Fused Laminate Chassis
<b>Lateral File</b> 96 x 22 x 29.5 90 x 22 x 29.5	325 "W" Option N/A 315 "W" Option N/A		RFT9622CA651P 8008 RFT9022CA651P 7554	"G" Option N/A "G" Option N/A	"M" Option N/A "M" Option N/A
<b>2 Select a finish</b> <a href="#">View finish details</a>			TBCO TBSW TSTV TSMV TSLV TOBW		
<b>3 Select a edge</b> <a href="#">View edge details</a>			Edge N/A		
<b>4 Select hardware</b> <a href="#">View hardware details</a>			 <small>PL-300 Matte Chrome</small> <small>PL-301 Matte Chrome</small> <small>PL-302 White</small> <small>PL-303 White</small>  <small>PL-304 Matte Chrome</small> <small>PL-305 Matte Chrome</small> <small>PL-306 White</small> <small>PL-307 White</small>		

[View statement of line](#)

Product features.

- 1-5/16" Thick work surface
- Center storage has 1 adjustable wood shelf
- Lateral Files feature Legal/Letter filing
- Locking drawers
- Recessed front detailing
- Soft close suspension drawer(s)
- Solid lumber core banded end panels

NOTES

- Unit not designed for open plan use, standard with unfinished back. Select OPB Option for Open Plan application.

Options.

ACCESSORIES

- MTL30-S: Silver metal legs - \$315 unit
- MTL30-W: White metal legs - \$420 unit

DOOR

- D2: Wood Door Lock - \$100 per door set
- D6: Delete Doors - n/c
- D9SC: Soft Close Door Hinges - \$20 per door

DRAWER / DOOR

- WPD3061: Designer White - \$160 per lateral pedestal
- WPD3061: Designer White - \$80 per credenza door

GROMMET (STANDARD LOCATION)

- Specify Color and Location (Right/Left/Center) - \$50 ea.
- Black: TM30-R (Right), TM30-L (Left), TM30-C (Center)
  - Silver: TM31-R (Right), TM31-L (Left), TM31-C (Center)
  - White: TM34-R (Right), TM34-L (Left), TM34-C (Center)

OPEN PLAN – FINISHED BACK

- OPB: "W" "G" Style - Modify Unit for Open Plan Application - \$195



# Rift.

Credenzas  
Kneespace File/File And Lateral File

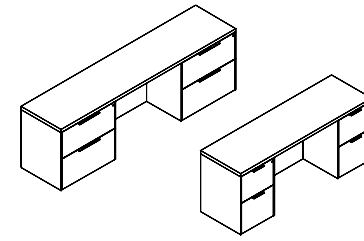

## 1 Select a model w" x d" x h"

weight	Standard Veneer Top Standard Veneer Chassis	Premium Veneer Top Premium Veneer Chassis	High Pressure Laminate Top Veneer Chassis	Thermally Fused Laminate Top Thermally Fused Laminate Chassis
<b>Lateral File</b>				
96 x 22 x 29.5	300 "W" Option N/A	RFT9622CA052P 6306	"G" Option N/A	"M" Option N/A
90 x 22 x 29.5	290 "W" Option N/A	RFT9022CA052P 6154	"G" Option N/A	"M" Option N/A
<b>File/File</b>				
84 x 22 x 29.5	255 "W" Option N/A	RFT8422CA054P 5106	"G" Option N/A	"M" Option N/A
72 x 22 x 29.5	220 "W" Option N/A	RFT7222CA054P 4895	"G" Option N/A	"M" Option N/A
60 x 22 x 29.5	200 "W" Option N/A	RFT6022CA054P 4733	"G" Option N/A	"M" Option N/A

[View statement of line](#)

## 2 Select a finish [View finish details](#)

TBCO  
TBSW  
TSTV  
TSMV  
TSLV  
TOBW

## 3 Select a edge [View edge details](#)

Edge  
N/A

## 4 Select hardware [View hardware details](#)

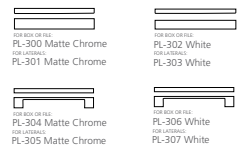

## Product features.

- 1-5/16" Thick work surface
- Fixed Full Modesty
- Full extension locking drawers
- Legal/Letter filing
- Recessed front detailing
- Soft close suspension drawer(s)
- Solid lumber core banded end panels

### NOTES

- Unit not designed for open plan use, standard with unfinished back.
- Select OPB Option for Open Plan application.

## Options.

### ACCESSORIES

- K1R: Center Drawer - \$290
- K28: Articulating Keyboard w/ Mouse - \$390
- MTL40-S: Silver metal legs - \$420 unit
- MTL40-W: White metal legs - \$625 unit

### DRAWER

- WPD3061: Designer White - \$160 per lateral pedestal
- WPD3061: Designer White - \$80 per F/F pedestal

### GROMMET (STANDARD LOCATION)

Specify Color - \$50 ea.

- Black: TM30-C (Center)
- Silver: TM31-C (Center)
- White: TM34-C (Center)

### GROMMETS (NON-STANDARD LOCATION)

Provide drawing w/ Grommet Location and Specify Color - \$95 ea.

- TM30-NS: Black Specify Location
- TM31-NS: Silver Specify Location
- TM34-NS: White Specify Location

### MODESTY

- M34T: "W" "G" Style Drop Door Tech Modesty - \$130
- M51: Open Back Modesty with Wire Mgmt Rail - Deduct \$95

### OPEN PLAN – FINISHED BACK

- OPB: "W" "G" Style - Modify Unit for Open Plan Application - \$195

# Rift.

Credenzas  
Kneespace Box/Hidden Box/File

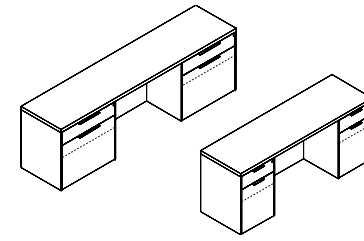

[View statement of line](#)

1 Select a model w" x d" x h"	weight	Standard Veneer Top	Premium Veneer Top	High Pressure Laminate Top	Thermally Fused Laminate Top
		Standard Veneer Chassis	Premium Veneer Chassis	Veneer Chassis	Thermally Fused Laminate Chassis
<b>4 Box Drawers 2 Lateral Files</b>					
96 x 22 x 29.5	300	"W" Option N/A	RFT9622CA684P 6426	"G" Option N/A	"M" Option N/A
90 x 22 x 29.5	290	"W" Option N/A	RFT9022CA684P 6273	"G" Option N/A	"M" Option N/A
<b>4 Box Drawers 2 Files</b>					
84 x 22 x 29.5	255	"W" Option N/A	RFT8422CA685P 5226	"G" Option N/A	"M" Option N/A
72 x 22 x 29.5	220	"W" Option N/A	RFT7222CA685P 5016	"G" Option N/A	"M" Option N/A
60 x 22 x 29.5	200	"W" Option N/A	RFT6022CA685P 4853	"G" Option N/A	"M" Option N/A
<b>2 Select a finish</b> <a href="#">View finish details</a>			TBCO TBSW TSTV TSMV TSLV TOBW		
<b>3 Select a edge</b> <a href="#">View edge details</a>			Edge N/A		
<b>4 Select hardware</b> <a href="#">View hardware details</a>					

## Product features.

- 1-5/16" Thick work surface
- Fixed Full Modesty
- Full extension locking drawers
- Legal/Letter filing
- Recessed front detailing
- Soft close suspension drawer(s)
- Solid lumber core banded end panels

### NOTES

- Unit not designed for open plan use, standard with unfinished back.
- Select OPB Option for Open Plan application.

## Options.

### ACCESSORIES

- K1R: Center Drawer - \$290
- K28: Articulating Keyboard w/ Mouse - \$390
- MTL40-S: Silver metal legs - \$420 unit
- MTL40-W: White metal legs - \$625 unit

### DRAWER

- WPD3061: Designer White - \$160 per lateral pedestal
- WPD3061: Designer White - \$80 per B/B/F pedestal

### GROMMET (STANDARD LOCATION)

Specify Color - \$50 ea.

- Black: TM30-C (Center)
- Silver: TM31-C (Center)
- White: TM34-C (Center)

### GROMMETS (NON-STANDARD LOCATION)

Provide drawing w/ Grommet Location and Specify Color - \$95 ea.

- TM30-NS: Black Specify Location
- TM31-NS: Silver Specify Location
- TM34-NS: White Specify Location

### MODESTY

- M34T: "W" "G" Style Drop Door Tech Modesty - \$130
- M51: Open Back Modesty with Wire Mgmt Rail - Deduct \$95

### OPEN PLAN – FINISHED BACK

- OPB: "W" "G" Style - Modify Unit for Open Plan Application - \$195

# Rift.

Credenzas  
Storage With Hinged Doors

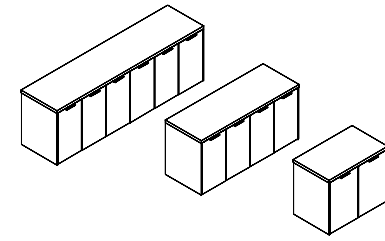

1 Select a model  
w" x d" x h"

weight

Standard Veneer Top Standard Veneer Chassis	Premium Veneer Top Premium Veneer Chassis	High Pressure Laminate Top Veneer Chassis	Thermally Fused Laminate Top Thermally Fused Laminate Chassis
<b>6 Door</b> 96 x 22 x 29.5 90 x 22 x 29.5	285 "W" Option N/A 270 "W" Option N/A	RFT9622CA125P 6138 RFT9022CA125P 5965	"G" Option N/A "G" Option N/A
<b>4 Door</b> 72 x 22 x 29.5 60 x 22 x 29.5	225 "W" Option N/A 195 "W" Option N/A	RFT7222CA125P 4818 RFT6022CA125P 4544	"G" Option N/A "G" Option N/A
<b>2 Door</b> 36 x 22 x 29.5 30 x 22 x 29.5	130 "W" Option N/A 115 "W" Option N/A	RFT3622CA125P 2523 RFT3022CA125P 2321	"G" Option N/A "G" Option N/A
	TBCO TBSW TSTV TSMV TSLV TOBW		
	Edge N/A		
	<p>PL-300 Matte Chrome PL-301 Matte Chrome PL-304 Matte Chrome PL-305 Matte Chrome</p>	<p>PL-302 White PL-303 White PL-306 White PL-307 White</p>	

[View statement of line](#)

2 Select a finish  
[View finish details](#)

3 Select a edge  
[View edge details](#)

4 Select hardware  
[View hardware details](#)

## Product features.

- 1-5/16" Thick work surface
- Adjustable finished shelf behind each door section
- Recessed front detailing
- Solid lumber core banded end panels

### NOTES

- Unit not designed for open plan use, standard with unfinished back.  
Select OPB Option for Open Plan application.

## Options.

### ACCESSORIES

- MTL30-S: Silver metal legs - \$315 unit
- MTL30-W: White metal legs - \$420 unit

### DOOR

- D2: Wood Door Lock - \$100 per door set
- D6: Delete Doors - n/c
- WPD3061: Designer White - \$80 per door

### GROMMET (STANDARD LOCATION)

- Specify Color and Location (Right/Left/Center) - \$50 ea.
- Black: TM30-R (Right), TM30-L (Left), TM30-C (Center)
  - Silver: TM31-R (Right), TM31-L (Left), TM31-C (Center)
  - White: TM34-R (Right), TM34-L (Left), TM34-C (Center)

### OPEN PLAN – FINISHED BACK

- OPB: "W" "G" Style - Modify Unit for Open Plan Application - \$195

Rift.

Credenzas  
Lateral File

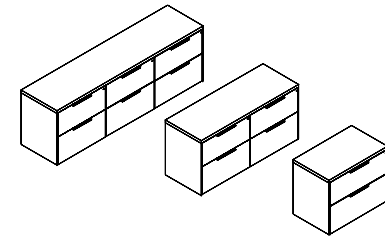

[View statement of line](#)

1 Select a model w" x d" x h"	weight	Standard Veneer Top Standard Veneer Chassis	Premium Veneer Top Premium Veneer Chassis	High Pressure Laminate Top Veneer Chassis	Thermally Fused Laminate Top Thermally Fused Laminate Chassis
<b>6 Drawer</b>					
96 x 22 x 29.5	420	"W" Option N/A	RFT9622CA104P 8145	"G" Option N/A	"M" Option N/A
90 x 22 x 29.5	410	"W" Option N/A	RFT9022CA104P 7941	"G" Option N/A	"M" Option N/A
<b>4 Drawer</b>					
72 x 22 x 29.5	310	"W" Option N/A	RFT7222CA104P 5441	"G" Option N/A	"M" Option N/A
60 x 22 x 29.5	280	"W" Option N/A	RFT6022CA104P 5204	"G" Option N/A	"M" Option N/A
<b>2 Drawer</b>					
42 x 22 x 29.5	180	"W" Option N/A	RFT4222CA104P 2727	"G" Option N/A	"M" Option N/A
36 x 22 x 29.5	160	"W" Option N/A	RFT3622CA104P 2459	"G" Option N/A	"M" Option N/A
30 x 22 x 29.5	145	"W" Option N/A	RFT3022CA104P 2357	"G" Option N/A	"M" Option N/A
<b>2 Select a finish</b> <a href="#">View finish details</a>			TBCO TBSW TSTV TSMV TSLV TOBW		
<b>3 Select a edge</b> <a href="#">View edge details</a>			Edge N/A		
<b>4 Select hardware</b> <a href="#">View hardware details</a>			<p>PL-300 Matte Chrome PL-301 Matte Chrome PL-302 White PL-303 White PL-304 Matte Chrome PL-305 Matte Chrome PL-306 White PL-307 White</p>		

Product features.

- 1-5/16" Thick work surface
- Lateral has legal/ double letter filing
- Locking drawers
- Recessed front detailing
- Soft close suspension drawer(s)
- Solid lumber core banded end panels

NOTES

- Unit not designed for open plan use, standard with unfinished back.  
Select OPB Option for Open Plan application.

Options.

ACCESSORIES

- MTL30-S: Silver metal legs - \$315 unit
- MTL30-W: White metal legs - \$420 unit

DRAWER

- WPD3061: Designer White - \$160 per pedestal

GROMMET (STANDARD LOCATION)

- Specify Color and Location (Right/Left/Center) - \$50 ea.
- Black: TM30-R (Right), TM30-L (Left), TM30-C (Center)
  - Silver: TM31-R (Right), TM31-L (Left), TM31-C (Center)
  - White: TM34-R (Right), TM34-L (Left), TM34-C (Center)

OPEN PLAN – FINISHED BACK

- OPB: "W" "G" Style - Modify Unit for Open Plan Application - \$195

Rift.

Credenzas  
Box/Hidden Box/Lateral File

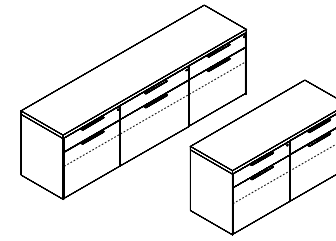

[View statement of line](#)

1 Select a model w" x d" x h"	weight	Standard Veneer Top Standard Veneer Chassis	Premium Veneer Top Premium Veneer Chassis	High Pressure Laminate Top Veneer Chassis	Thermally Fused Laminate Top Thermally Fused Laminate Chassis
<b>6 Box Drawers 3 Lateral Files</b>					
96 x 22 x 29.5	420	"W" Option N/A	RFT9622CA671P 8145	"G" Option N/A	"M" Option N/A
90 x 22 x 29.5	400	"W" Option N/A	RFT9022CA671P 7941	"G" Option N/A	"M" Option N/A
<b>4 Box Drawers 2 Files</b>					
72 x 22 x 29.5	310	"W" Option N/A	RFT7222CA671P 5441	"G" Option N/A	"M" Option N/A
60 x 22 x 29.5	280	"W" Option N/A	RFT6022CA671P 5204	"G" Option N/A	"M" Option N/A
2 Select a finish <a href="#">View finish details</a>		TBCO TBSW TSTV TSMV TSLV TOBW			
3 Select a edge <a href="#">View edge details</a>		Edge N/A			
4 Select hardware <a href="#">View hardware details</a>					

Product features.

- 1-5/16" Thick work surface
- Lateral has legal/ double letter filing
- Recessed front detailing
- Soft close suspension drawer(s)
- Solid lumber core banded end panels
- Unit features 2 large box drawers and lateral file underneath

NOTES

- Unit not designed for open plan use, standard with unfinished back.  
Select OPB Option for Open Plan application.

Options.

ACCESSORIES

- MTL30-S: Silver metal legs - \$315 unit
- MTL30-W: White metal legs - \$420 unit

DRAWER

- WPD3061: Designer White - \$160 per pedestal

GROMMET (STANDARD LOCATION)

- Specify Color and Location (Right/Left/Center) - \$50 ea.
- Black: TM30-R (Right), TM30-L (Left), TM30-C (Center)
  - Silver: TM31-R (Right), TM31-L (Left), TM31-C (Center)
  - White: TM34-R (Right), TM34-L (Left), TM34-C (Center)

OPEN PLAN – FINISHED BACK

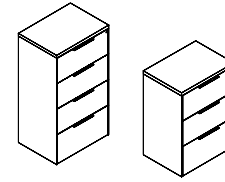

- OPB: "W" "G" Style - Modify Unit for Open Plan Application - \$195



# Rift.

Lateral Files  
Vertical Lateral File

[View statement of line](#)

1 Select a model w" x d" x h"	weight	Standard Veneer Top	Premium Veneer Top	High Pressure Laminate Top	Thermally Fused Laminate Top
		Standard Veneer Chassis	Premium Veneer Chassis	Veneer Chassis	Thermally Fused Laminate Chassis
<b>4 Drawer</b>					
30 x 22 x 54	250	"W" Option N/A	RFT3022FI111P 4278	"G" Option N/A	"M" Option N/A
36 x 22 x 54	275	"W" Option N/A	RFT3622FI111P 4429	"G" Option N/A	"M" Option N/A
<b>3 Drawer</b>					
30 x 22 x 42	215	"W" Option N/A	RFT3022FI112P 3774	"G" Option N/A	"M" Option N/A
36 x 22 x 42	235	"W" Option N/A	RFT3622FI112P 3926	"G" Option N/A	"M" Option N/A
			TBCO TBSW TSTV TSMV TSLV TOBW		
			Edge N/A		
					
					

## Product features.

- 1-5/16" Thick work surface
- Lateral has legal/ double letter filing
- Locking drawers
- Recessed front detailing
- Soft close suspension drawer(s)
- Solid lumber core banded end panels

### NOTES

- Unit not designed for open plan use, standard with unfinished back.  
Select OPB Option for Open Plan application.

## Options.

### ACCESSORIES

- MTL30-S: Silver metal legs - \$315 unit
- MTL30-W: White metal legs - \$420 unit

### DRAWER

- WPD3061: Designer White - \$160 per pedestal

### OPEN PLAN – FINISHED BACK

- OPB: "W" "G" Style - Modify Unit for Open Plan Application - \$195

Rift.

Workstation Credenzas  
Box/Hidden Box/File

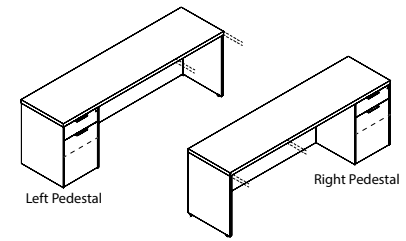

1 Select a model  
w" x d" x h"

weight

Standard Veneer Top Standard Veneer Chassis	Premium Veneer Top Premium Veneer Chassis	High Pressure Laminate Top Veneer Chassis	Thermally Fused Laminate Top Thermally Fused Laminate Chassis
<b>Left Pedestal</b> 96 x 22 x 29.5 90 x 22 x 29.5 84 x 22 x 29.5 72 x 22 x 29.5 66 x 22 x 29.5	210 "W" Option N/A 200 "W" Option N/A 190 "W" Option N/A 180 "W" Option N/A 170 "W" Option N/A	RFT9622CA795P 4983 RFT9022CA795P 4669 RFT8422CA795P 4209 RFT7222CA795P 3595 RFT6622CA795P 3376	"G" Option N/A "G" Option N/A "G" Option N/A "G" Option N/A "G" Option N/A
<b>Right Pedestal</b> 96 x 22 x 29.5 90 x 22 x 29.5 84 x 22 x 29.5 72 x 22 x 29.5 66 x 22 x 29.5	210 "W" Option N/A 200 "W" Option N/A 190 "W" Option N/A 180 "W" Option N/A 170 "W" Option N/A	RFT9622CA796P 4983 RFT9022CA796P 4669 RFT8422CA796P 4209 RFT7222CA796P 3595 RFT6622CA796P 3376	"M" Option N/A "M" Option N/A "M" Option N/A "M" Option N/A "M" Option N/A
	TBCO TBSW TSTV TSMV TSLV TOBW		
	Edge N/A		
		<p>PL-300 Matte Chrome PL-301 Matte Chrome PL-302 White PL-303 White PL-304 Matte Chrome PL-305 Matte Chrome PL-306 White PL-307 White</p>	

View statement of line

2 Select a finish  
View finish details

3 Select a edge  
View edge details

4 Select hardware  
View hardware details

Product features.

- 1-5/16" Thick work surface
- Fixed Full Modesty
- Locking drawers
- Recessed front detailing
- Soft close suspension drawer(s)
- Solid lumber core banded end panels

NOTES

- Unit not designed for open plan use, standard with unfinished back.  
Select OPB Option for Open Plan application.

Options.

ACCESSORIES

- K28: Articulating Keyboard w/ Mouse - \$390

DRAWER

- WPD3061: Designer White - \$80 per pedestal

GROMMET (STANDARD LOCATION)

- Specify Color - \$50 ea.
- Black: TM30-C (Center)
  - Silver: TM31-C (Center)
  - White: TM34-C (Center)

GROMMETS (NON-STANDARD LOCATION)

- Provide drawing w/ Grommet Location and Specify Color - \$95 ea.
- TM30-NS: Black Specify Location
  - TM31-NS: Silver Specify Location
  - TM34-NS: White Specify Location

MODESTY

- M34T: "W" "G" Style Drop Door Tech Modesty - \$130
- M51: Open Back Modesty with Wire Mgmt Rail - Deduct \$95

OPEN PLAN – FINISHED BACK

- OPB: "W" "G" Style - Modify Unit for Open Plan Application - \$195

# Rift.

Workstation Credenzas  
File/File

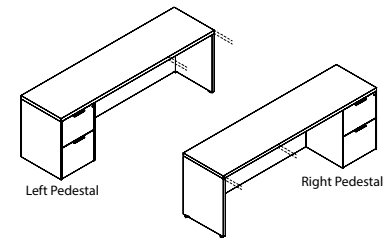

1 Select a model  
w" x d" x h"

weight

Standard Veneer Top Standard Veneer Chassis	Premium Veneer Top Premium Veneer Chassis	High Pressure Laminate Top Veneer Chassis	Thermally Fused Laminate Top Thermally Fused Laminate Chassis
96 x 22 x 29.5 210 "W" Option N/A	RFT9622CA086P 4911	"G" Option N/A	"M" Option N/A
90 x 22 x 29.5 200 "W" Option N/A	RFT9022CA086P 4596	"G" Option N/A	"M" Option N/A
84 x 22 x 29.5 190 "W" Option N/A	RFT8422CA086P 4281	"G" Option N/A	"M" Option N/A
72 x 22 x 29.5 180 "W" Option N/A	RFT7222CA086P 3522	"G" Option N/A	"M" Option N/A
66 x 22 x 29.5 170 "W" Option N/A	RFT6622CA086P 3302	"G" Option N/A	"M" Option N/A
<b>Right Pedestal</b>			
96 x 22 x 29.5 210 "W" Option N/A	RFT9622CA087P 4911	"G" Option N/A	"M" Option N/A
90 x 22 x 29.5 200 "W" Option N/A	RFT9022CA087P 4596	"G" Option N/A	"M" Option N/A
84 x 22 x 29.5 190 "W" Option N/A	RFT8422CA087P 4281	"G" Option N/A	"M" Option N/A
72 x 22 x 29.5 180 "W" Option N/A	RFT7222CA087P 3522	"G" Option N/A	"M" Option N/A
66 x 22 x 29.5 170 "W" Option N/A	RFT6622CA087P 3302	"G" Option N/A	"M" Option N/A
	TBCO TBSW TSTV TSMV TSLV TOBW		
	Edge N/A		
	<p>PL-300 Matte Chrome PL-301 Matte Chrome</p> <p>PL-304 Matte Chrome PL-305 Matte Chrome</p>	<p>PL-302 White PL-303 White</p> <p>PL-306 White PL-307 White</p>	

[View statement of line](#)

2 Select a finish  
[View finish details](#)

3 Select a edge  
[View edge details](#)

4 Select hardware  
[View hardware details](#)

## Product features.

- 1-5/16" Thick work surface
- File/File
- Fixed Full Modesty
- Locking drawers
- Recessed front detailing
- Soft close suspension drawer(s)
- Solid lumber core banded end panels

### NOTES

- Unit not designed for open plan use, standard with unfinished back.
- Select OPB Option for Open Plan application.

## Options.

### ACCESSORIES

- K28: Articulating Keyboard w/ Mouse - \$390

### DRAWER

- WPD3061: Designer White - \$80 per pedestal

### GROMMET (STANDARD LOCATION)

Specify Color - \$50 ea.

- Black: TM30-C (Center)
- Silver: TM31-C (Center)
- White: TM34-C (Center)

### GROMMETS (NON-STANDARD LOCATION)

Provide drawing w/ Grommet Location and Specify Color - \$95 ea.

- TM30-NS: Black Specify Location
- TM31-NS: Silver Specify Location
- TM34-NS: White Specify Location

### MODESTY

- M34T: "W" "G" Style Drop Door Tech Modesty - \$130
- M51: Open Back Modesty with Wire Mgmt Rail - Deduct \$95

### OPEN PLAN – FINISHED BACK

- OPB: "W" "G" Style - Modify Unit for Open Plan Application - \$195



Rift.

Workstation Credenzas  
Lateral File

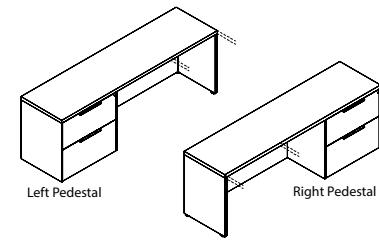

1 Select a model  
w" x d" x h"

weight

Standard Veneer Top Standard Veneer Chassis	Premium Veneer Top Premium Veneer Chassis	High Pressure Laminate Top Veneer Chassis	Thermally Fused Laminate Top Thermally Fused Laminate Chassis
<b>Left Pedestal</b> 96 x 22 x 29.5 90 x 22 x 29.5 84 x 22 x 29.5 72 x 22 x 29.5 66 x 22 x 29.5	245 "W" Option N/A 240 "W" Option N/A 235 "W" Option N/A 230 "W" Option N/A 225 "W" Option N/A	RFT9622CA066P 5059 RFT9022CA066P 4850 RFT8422CA066P 4692 RFT7222CA066P 3933 RFT6622CA066P 3781	"G" Option N/A "G" Option N/A "G" Option N/A "G" Option N/A "G" Option N/A
<b>Right Pedestal</b> 96 x 22 x 29.5 90 x 22 x 29.5 84 x 22 x 29.5 72 x 22 x 29.5 66 x 22 x 29.5	245 "W" Option N/A 240 "W" Option N/A 235 "W" Option N/A 230 "W" Option N/A 225 "W" Option N/A	RFT9622CA067P 5059 RFT9022CA067P 4850 RFT8422CA067P 4692 RFT7222CA067P 3933 RFT6622CA067P 3781	"M" Option N/A "M" Option N/A "M" Option N/A "M" Option N/A "M" Option N/A
	TBCO TBSW TSTV TSMV TSLV TOBW		
	Edge N/A		
	<p>PL-300 Matte Chrome PL-301 Matte Chrome</p> <p>PL-304 Matte Chrome PL-305 Matte Chrome</p>	<p>PL-302 White PL-303 White</p> <p>PL-306 White PL-307 White</p>	

[View statement of line](#)

2 Select a finish  
[View finish details](#)

3 Select a edge  
[View edge details](#)

4 Select hardware  
[View hardware details](#)

Product features.

- 1-5/16" Thick work surface
- Fixed Full Modesty
- Lateral file drawers feature Legal/Letter filing
- Locking drawers
- Recessed front detailing
- Soft close suspension drawer(s)
- Solid lumber core banded end panels

NOTES

- Unit not designed for open plan use, standard with unfinished back. Select OPB Option for Open Plan application.

Options.

ACCESSORIES

- K28: Articulating Keyboard w/ Mouse - \$390

DRAWER

- WPD3061: Designer White - \$150 per pedestal

GROMMET (STANDARD LOCATION)

Specify Color - \$50 ea.

- Black: TM30-C (Center)
- Silver: TM31-C (Center)
- White: TM34-C (Center)

GROMMETS (NON-STANDARD LOCATION)

Provide drawing w/ Grommet Location and Specify Color - \$95 ea.

- TM30-NS: Black Specify Location
- TM31-NS: Silver Specify Location
- TM34-NS: White Specify Location

MODESTY

- M34T: "W" "G" Style Drop Door Tech Modesty - \$130
- M51: Open Back Modesty with Wire Mgmt Rail - Deduct \$95

OPEN PLAN – FINISHED BACK

- OPB: "W" "G" Style - Modify Unit for Open Plan Application - \$195

Rift.

Workstation Credenzas  
Box/Box/Storage/Lateral File

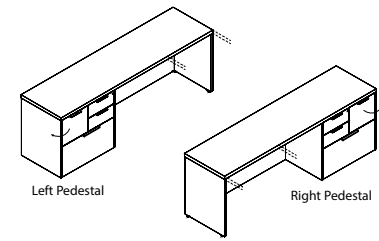

1 Select a model  
w" x d" x h"

weight

Standard Veneer Top Standard Veneer Chassis	Premium Veneer Top Premium Veneer Chassis	High Pressure Laminate Top Veneer Chassis	Thermally Fused Laminate Top Thermally Fused Laminate Chassis
<p><b>Left Pedestal</b></p> <p>96 x 22 x 29.5 245 "W" Option N/A</p> <p>90 x 22 x 29.5 240 "W" Option N/A</p> <p>84 x 22 x 29.5 235 "W" Option N/A</p> <p>72 x 22 x 29.5 230 "W" Option N/A</p> <p>66 x 22 x 29.5 225 "W" Option N/A</p> <p><b>Right Pedestal</b></p> <p>96 x 22 x 29.5 245 "W" Option N/A</p> <p>90 x 22 x 29.5 240 "W" Option N/A</p> <p>84 x 22 x 29.5 235 "W" Option N/A</p> <p>72 x 22 x 29.5 230 "W" Option N/A</p> <p>66 x 22 x 29.5 225 "W" Option N/A</p>	<p>RFT9622CA659P 5402</p> <p>RFT9022CA659P 5250</p> <p>RFT8422CA659P 5094</p> <p>RFT7222CA659P 4421</p> <p>RFT6622CA659P 4245</p> <p>TBCO</p> <p>TBSW</p> <p>TSTV</p> <p>TSMV</p> <p>TSLV</p> <p>TOBW</p> <p>Edge N/A</p> <p> </p>	<p>"G" Option N/A</p> <p>"G" Option N/A</p> <p>"G" Option N/A</p> <p>"G" Option N/A</p> <p>"G" Option N/A</p> <p>"G" Option N/A</p> <p>"G" Option N/A</p> <p>"G" Option N/A</p> <p>"G" Option N/A</p> <p>"G" Option N/A</p>	<p>"M" Option N/A</p> <p>"M" Option N/A</p> <p>"M" Option N/A</p> <p>"M" Option N/A</p> <p>"M" Option N/A</p> <p>"M" Option N/A</p> <p>"M" Option N/A</p> <p>"M" Option N/A</p> <p>"M" Option N/A</p> <p>"M" Option N/A</p>

[View statement of line](#)

2 Select a finish  
[View finish details](#)

3 Select a edge  
[View edge details](#)

4 Select hardware  
[View hardware details](#)

Product features.

- 1-5/16" Thick work surface
- Door beside box drawers for small personal storage
- Fixed Full Modesty
- Recessed front detailing
- Soft close suspension drawer(s)
- Solid lumber core banded end panels

NOTES

- Unit not designed for open plan use, standard with unfinished back.
- Select OPB Option for Open Plan application.

Options.

ACCESSORIES

- K28: Articulating Keyboard w/ Mouse - \$390

DOOR

- D2: Door Lock for Personal Storage Door- \$100 per door

DRAWER

- WPD3061: Designer White - \$150 per pedestal

GROMMET (STANDARD LOCATION)

Specify Color - \$50 ea.

- Black: TM30-C (Center)
- Silver: TM31-C (Center)
- White: TM34-C (Center)

GROMMETS (NON-STANDARD LOCATION)

Provide drawing w/ Grommet Location and Specify Color - \$95 ea.

- TM30-NS: Black Specify Location
- TM31-NS: Silver Specify Location
- TM34-NS: White Specify Location

MODESTY

- M34T: "W" "G" Style Drop Door Tech Modesty - \$130
- M51: Open Back Modesty with Wire Mgmt Rail - Deduct \$95

OPEN PLAN – FINISHED BACK

- OPB: "W" "G" Style - Modify Unit for Open Plan Application - \$195

Rift.

Open Plan Bench Credenzas  
Full Cabinet Bench

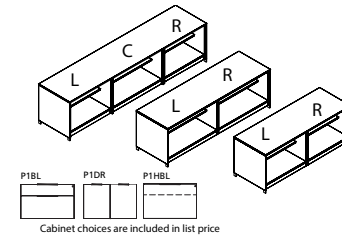

[View statement of line](#)

1 Select a model w" x d" x h"	weight	Standard Veneer Top	Premium Veneer Top	High Pressure Laminate Top	Thermally Fused Laminate Top
		Standard Veneer Chassis	Premium Veneer Chassis	Veneer Chassis	Thermally Fused Laminate Chassis
<b>(2) 30"W Cabinet (1) 36"W Cabinet</b> 96 x 22 x 22.5 "W" Option N/A			RFT9622CA062P 6238	"G" Option N/A	"M" Option N/A
<b>(3) 30"W Cabinet</b> 90 x 22 x 22.5 "W" Option N/A			RFT9022CA062P 6117	"G" Option N/A	"M" Option N/A
<b>(2) 36"W Cabinet</b> 72 x 22 x 22.5 "W" Option N/A			RFT7222CA062P 5952	"G" Option N/A	"M" Option N/A
<b>(1) 30"W Cabinet (1) 36"W Cabinet</b> 66 x 22 x 22.5 "W" Option N/A			RFT6622CA062P 4933	"G" Option N/A	"M" Option N/A
<b>(2) 30"W Cabinet</b> 60 x 22 x 22.5 "W" Option N/A			RFT6022CA062P 4829	"G" Option N/A	"M" Option N/A
		TBCO TBSW TSTV TSMV TSLV TOBW			
		Edge N/A			

Product features.

**NOTES**

- Please indicate cabinet sizes (30" - 36") as well as each cabinet's location, from left to right
- Select cabinets and fixed locations
- Silver metal legs

Options.

**ACCESSORIES**

- MTL30-W: White metal legs - \$105 unit

**CUSHION**

- BC22: Bench Cushion
- Specify location, number of cushions and fabric grade.
- Cushions sold individually w/a max width 35" (to match storage section depth). 29" W requires .75 yd, 35" W requires 1 yd.

**DRAWER**

- WPD3061: Designer White - \$80 per door
- WPD3061: Designer White - \$160 per pedestal

**STORAGE**

Specify pull with storage option/ Specify location of each cabinet

- P1BL: Box/Lateral File - n/c
- P1DR: Two Door Storage - n/c
- P1HBL: Hidden Box Lateral - n/c

**BC22 BENCH CUSHION FABRIC GRADES.**

COM	COL	1	2	3
282	N/A	319	337	355
4	5	6	7	8
373	391	409	427	445
9	10	11/ L1	12	13/ L2
463	481	499	517	553

# Rift.

Open Plan Bench Credenzas  
Full Storage With Sliding Door

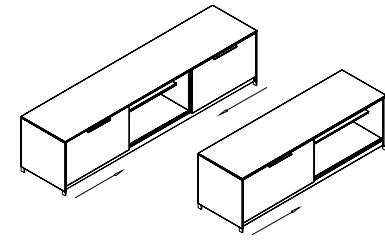

[View statement of line](#)

1 Select a model w" x d" x h"	weight	Standard Veneer Top Standard Veneer Chassis	Premium Veneer Top Premium Veneer Chassis	High Pressure Laminate Top Veneer Chassis	Thermally Fused Laminate Top Thermally Fused Laminate Chassis
<b>Double Door</b>					
96 x 22 x 22.5	305	"W" Option N/A	RFT9622CA661P 5763	"G" Option N/A	"M" Option N/A
90 x 22 x 22.5	295	"W" Option N/A	RFT9022CA661P 5663	"G" Option N/A	"M" Option N/A
<b>Single Door</b>					
72 x 22 x 22.5	205	"W" Option N/A	RFT7222CA661P 4703	"G" Option N/A	"M" Option N/A
60 x 22 x 22.5	175	"W" Option N/A	RFT6022CA661P 4628	"G" Option N/A	"M" Option N/A
<b>2 Select a finish</b> <a href="#">View finish details</a>			TBCO TBSW TSTV TSMV TSLV TOBW		
<b>3 Select a edge</b> <a href="#">View edge details</a>			Edge N/A		
<b>4 Select hardware</b> <a href="#">View hardware details</a>					

## Product features.

- Adjustable finished shelf behind each door section
- Benches designed for open plan use

### NOTES

- Silver metal legs

## Options.

### ACCESSORIES

- MTL30-W: White metal legs - \$105 unit

### CUSHION

- BC22: Bench Cushion
- Specify location, number of cushions and fabric grade.
- Cushions sold individually w/a max width 35" (to match storage section depth). 29" W requires .75 yd, 35" W requires 1 yd.

### DOOR

- WPD3061: Designer White - \$80 per door

### BC22 BENCH CUSHION FABRIC GRADES.

COM	COL	1	2	3
282	301	319	337	355
4	5	6	7	8
373	391	409	427	445
9	10	11/ L1	12	13/ L2
463	481	499	517	553

# Rift.

Mobile Pedestals  
Undersurface Mobile Pedestals

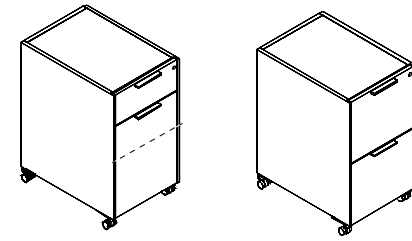

1 Select a model w" x d" x h"	weight	Standard Veneer Top Standard Veneer Chassis	Premium Veneer Top Premium Veneer Chassis	High Pressure Laminate Top Veneer Chassis	Thermally Fused Laminate Top Thermally Fused Laminate Chassis
<b>Box/ Hidden Box/ File Undersurface</b> 16 x 18 x 27.5	75	"W" Option N/A	RFT1618PD424P 1728	"G" Option N/A	"M" Option N/A
<b>File/File Undersurface</b> 16 x 18 x 27.5	75	"W" Option N/A	RFT1618PD425P 1728	"G" Option N/A	"M" Option N/A
		TBCO TBSW TSTV TSMV TSLV TOBW			
3 Select a edge <i>View edge details</i>		Edge N/A			
4 Select hardware <i>View hardware details</i>					

[View statement of line](#)

## Product features.

- Box drawers include divider
- Die cast designer casters
- Finished all sides
- Locking drawers
- Pedestals anti-tilt weighted
- Recessed front detailing
- Soft close suspension drawer(s)

## Options.

### DRAWER

- WPD3061: Designer White - \$80 per pedestal

# Rift.

Mobile Pedestals  
Box/File

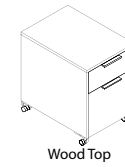

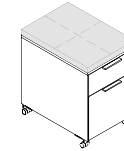

Wood Top

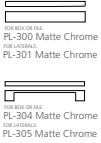

Cushion Top

[View statement of line](#)

1 Select a model w" x d" x h"	weight	Standard Veneer Top Standard Veneer Chassis	Premium Veneer Top Premium Veneer Chassis	High Pressure Laminate Top Veneer Chassis	Thermally Fused Laminate Top Thermally Fused Laminate Chassis
16 x 18 x 22	65	"W" Option N/A	RFT1618PD423P 1320	"G" Option N/A	"M" Option N/A
2 Select a finish <a href="#">View finish details</a>			TBCO TBSW TSTV TSMV TSLV TOBW		
3 Select a edge <a href="#">View edge details</a>			Edge N/A		
4 Select hardware <a href="#">View hardware details</a>					

## Product features.

- Box drawers include divider
- Die cast designer casters
- Finished all sides
- Locking drawers
- Pedestals anti-tilt weighted
- Recessed front detailing
- Soft close suspension drawer(s)

## Options.

### CUSHION

- BC16: Bench cushion
- Specify fabric grade (1 yd. required)

### DRAWER

- WPD3061: Designer White - \$80 per pedestal

### BC16 CUSHION FABRIC GRADES.

COM	COL	1	2	3
224	N/A	261	279	297
4	5	6	7	8
315	333	351	369	387
9	10	11/ L1	12	13/ L2
405	423	441	459	495

Rift.

Overhead Consoles Single Height  
Hinged Wood Doors

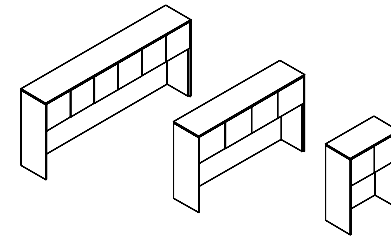

[View statement of line](#)

1 Select a model w" x d" x h"	weight	Standard Veneer Top	Premium Veneer Top	High Pressure Laminate Top	Thermally Fused Laminate Top
		Standard Veneer Chassis	Premium Veneer Chassis	Veneer Chassis	Thermally Fused Laminate Chassis
<b>6 Door / 3 Section</b>					
96 x 15 x 41	315	"W" Option N/A	RFT9641OH325P 4292	"G" Option N/A	"M" Option N/A
90 x 15 x 41	285	"W" Option N/A	RFT9041OH325P 4146	"G" Option N/A	"M" Option N/A
84 x 15 x 41	275	"W" Option N/A	RFT8441OH325P 3930	"G" Option N/A	"M" Option N/A
<b>4 Door / 2 Section</b>					
72 x 15 x 41	240	"W" Option N/A	RFT7241OH325P 3689	"G" Option N/A	"M" Option N/A
66 x 15 x 41	225	"W" Option N/A	RFT6641OH325P 3568	"G" Option N/A	"M" Option N/A
60 x 15 x 41	210	"W" Option N/A	RFT6041OH325P 3449	"G" Option N/A	"M" Option N/A
<b>2 Door / 1 Section</b>					
36 x 15 x 41	120	"W" Option N/A	RFT3641OH325P 2377	"G" Option N/A	"M" Option N/A
30 x 15 x 41	105	"W" Option N/A	RFT3041OH325P 2287	"G" Option N/A	"M" Option N/A
<b>2 Select a finish</b> <a href="#">View finish details</a>			TBCO TBSW TSTV TSMV TSLV TOBW		
<b>3 Select a edge</b> <a href="#">View edge details</a>			Edge N/A		
<b>4 Select hardware</b> <a href="#">View hardware details</a>			Hardware N/A		

Product features.

- 3/4" Thick back panel
- Finished top
- Interior cabinet depth 12.5"
- Touch latch

NOTES

- Unit has black back panel and is not designed for Open Plan use. Select OPB Option for Open Plan application

Options.

DOOR

- D2: Wood Door Lock - \$100 per door set
- D2-G: Door Lock for Glass Doors - \$205 per door set (only when RF375AW is ordered)
- D6: Delete Doors - n/c
- WPD3061: Designer White - \$35 per door

GROMMETS (VERTICAL SURFACE)

- Standard Location - \$50 ea.
- Black Plastic Vertical Surface: TM50-C (Bottom Center)
- Non-Standard Location - \$95 ea.
- Black Plastic Vertical Surface: TM50-NS

OPEN PLAN – FINISHED BACK

- OPB: "W" "G" Style - Modify Unit for Open Plan Application - \$295

TASK LIGHT

- LED24: 24" Slim Line Aluminum LED Task light - \$330
- LED48: 48" Slim Line Aluminum LED Task light - \$465
- LED60: 60" Slim Line Aluminum LED Task light - \$580
- DPC: Link multiple Task lights up to 30W of power wattage. Deletes 1 power drive - Deduct \$85 per Task light

# Rift.

## Overhead Consoles Single Height Sliding Wood Doors

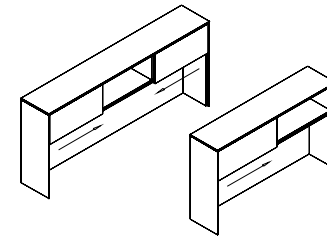

[View statement of line](#)

1 Select a model w" x d" x h"	weight	Standard Veneer Top	Premium Veneer Top	High Pressure Laminate Top	Thermally Fused Laminate Top
		Standard Veneer Chassis	Premium Veneer Chassis	Veneer Chassis	Thermally Fused Laminate Chassis
<b>2 Door / 3 Section</b>					
96 x 15 x 41	315	"W" Option N/A	RFT9641OH869P 4532	"G" Option N/A	"M" Option N/A
90 x 15 x 41	285	"W" Option N/A	RFT9041OH869P 4388	"G" Option N/A	"M" Option N/A
84 x 15 x 41	275	"W" Option N/A	RFT8441OH869P 4170	"G" Option N/A	"M" Option N/A
<b>1 Door / 2 Section</b>					
72 x 15 x 41	240	"W" Option N/A	RFT7241OH869P 3870	"G" Option N/A	"M" Option N/A
66 x 15 x 41	225	"W" Option N/A	RFT6641OH869P 3750	"G" Option N/A	"M" Option N/A
60 x 15 x 41	210	"W" Option N/A	RFT6041OH869P 3630	"G" Option N/A	"M" Option N/A
<b>2 Select a finish</b> <a href="#">View finish details</a>			TBCO TBSW TSTV TSMV TSLV TOBW		
<b>3 Select a edge</b> <a href="#">View edge details</a>			Edge N/A		
<b>4 Select hardware</b> <a href="#">View hardware details</a>			Hardware N/A		

## Product features.

- 3/4" Thick back panel
- Finished top
- Interior cabinet depth 12.5"

### NOTES

- Unit has black back panel and is not designed for Open Plan use. Select OPB Option for Open Plan application

## Options.

### DOOR

- RF550AW: Aluminum/White Glass - \$575 per door
- WPD3061: Designer White - \$35 per door

### INTERIOR CABINET LIGHTING

- LEDPK starter kit includes Infeed, 1 Puck Interior Light and the ability to daisy chain up to 6 total Puck Lights
- LEDPK: LED Puck Starter Kit - \$310
- PK: 1 LED Interior Light - \$130

### OPEN PLAN – FINISHED BACK

- OPB: "W" "G" Style - Modify Unit for Open Plan Application - \$295

### TASK LIGHT

- LED24: 24" Slim Line Aluminum LED Task light - \$330
- LED48: 48" Slim Line Aluminum LED Task light - \$465
- LED60: 60" Slim Line Aluminum LED Task light - \$580
- DPC: Link multiple Task lights up to 30W of power wattage. Deletes 1 power drive - Deduct \$85 per Task light



Rift.

Overhead Consoles Double Height  
Hinged Wood Doors

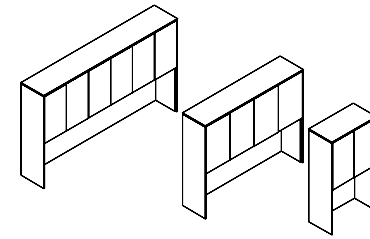

[View statement of line](#)

1 Select a model w" x d" x h"	weight	Standard Veneer Top	Premium Veneer Top	High Pressure Laminate Top	Thermally Fused Laminate Top
		Standard Veneer Chassis	Premium Veneer Chassis	Veneer Chassis	Thermally Fused Laminate Chassis
<b>6 Door / 3 Section</b>					
96 x 15 x 54	320	"W" Option N/A	RFT9654OH325P 4893	"G" Option N/A	"M" Option N/A
90 x 15 x 54	300	"W" Option N/A	RFT9054OH325P 4628	"G" Option N/A	"M" Option N/A
84 x 15 x 54	280	"W" Option N/A	RFT8454OH325P 4507	"G" Option N/A	"M" Option N/A
<b>4 Door / 2 Section</b>					
72 x 15 x 54	240	"W" Option N/A	RFT7254OH325P 4170	"G" Option N/A	"M" Option N/A
66 x 15 x 54	220	"W" Option N/A	RFT6654OH325P 4050	"G" Option N/A	"M" Option N/A
60 x 15 x 54	200	"W" Option N/A	RFT6054OH325P 3930	"G" Option N/A	"M" Option N/A
<b>2 Door / 1 Section</b>					
36 x 15 x 54	120	"W" Option N/A	RFT3654OH325P 2619	"G" Option N/A	"M" Option N/A
30 x 15 x 54	100	"W" Option N/A	RFT3054OH325P 2528	"G" Option N/A	"M" Option N/A
<b>2 Select a finish</b> <a href="#">View finish details</a>			TBCO TBSW TSTV TSMV TSLV TOBW		
<b>3 Select a edge</b> <a href="#">View edge details</a>			Edge N/A		
<b>4 Select hardware</b> <a href="#">View hardware details</a>			Hardware N/A		

Product features.

- 3/4" Thick back panel
- Adjustable finished shelf behind each door section
- Black painted top
- Interior shelf depth 12.5"
- Touch latch

NOTES

- Unit has black back panel and is not designed for Open Plan use. Select OPB Option for Open Plan application

Options.

DOOR

- D2: Wood Door Lock - \$100 per door set
- D2-G: Door Lock for Glass Doors - \$205 per door set (only when RF475AW is ordered)
- D6: Delete Doors - n/c
- RF475AW: Aluminum/White Glass - \$495 per door
- WPD3061: Designer White - \$55 per door

INTERIOR CABINET LIGHTING

- LEDPK starter kit includes Infeed, 1 Puck Interior Light and the ability to daisy chain up to 6 total Puck Lights
- LEDPK: LED Puck Starter Kit - \$310
- PK: 1 LED Interior Light - \$130

TASK LIGHT

- LED24: 24" Slim Line Aluminum LED Task light - \$330
- LED48: 48" Slim Line Aluminum LED Task light - \$465
- LED60: 60" Slim Line Aluminum LED Task light - \$580
- DPC: Link multiple Task lights up to 30W of power wattage. Deletes 1 power drive - Deduct \$85 per Task light

OPEN PLAN – FINISHED BACK

- OPB: "W" "G" Style - Modify Unit for Open Plan Application - \$295

SHELF

- GS14F: Replace Standard Shelves with Glass Shelves - \$90 per shelf
- S714F: Replace Standard Shelf with Heavy Duty Lumber 1" Shelf - \$80 per shelf

## Rift tackboards.

Overhead tackboard  
Full width tackboards

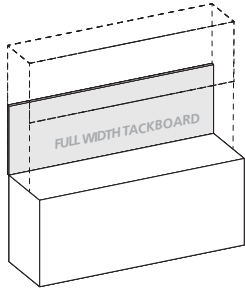

Product Width	Panel Dimension	SKU	COM	1	2	3	4	5	6	7	8	9	10	11/L1	12	13/L2
96	94 x .75 x 26	FTOC9426	389	495	548	601	654	707	760	813	866	919	972	1025	1078	1184
90	88 x .75 x 26	FTOC8826	368	464	513	562	611	660	709	758	807	856	905	954	1003	1101
84	82 x .75 x 26	FTOC8226	336	428	474	520	566	612	658	704	750	796	842	888	934	1026
72	70 x .75 x 26	FTOC7026	292	371	412	453	494	535	576	617	658	699	740	781	822	904
66	64 x .75 x 26	FTOC6426	264	340	377	414	451	488	525	562	599	636	673	710	747	821
60	58 x .75 x 26	FTOC5826	242	309	342	375	408	441	474	507	540	573	606	639	672	738
36	34 x .75 x 26	FTOC3426	148	186	207	228	249	270	291	312	333	354	375	396	417	459
30	28 x .75 x 26	FTOC2826	115	154	172	190	208	226	244	262	280	298	316	334	352	388

### Standard Features

- Constructed of .5" thick fiberboard
- Fabric is precisely aligned and fitted to the tackboard
- Adhered to the rigid hardboard with staples
- Hung with Z-Strip mounting system

### Notes

- Fabric Tack Panels are raised 3" from bottom edge when TM50 grommet is ordered.

Overhead tackboard  
Half width tackboards

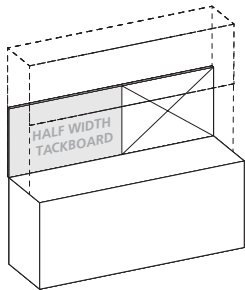

Product Width	Panel Dimension	SKU	COM	1	2	3	4	5	6	7	8	9	10	11/L1	12	13/L2
96 Half Width	47 x .75 x 26	FTOC4726	194	247	273	299	325	351	377	403	429	455	481	507	533	585
90 Half Width	44 x .75 x 26	FTOC4426	184	232	257	282	307	332	357	382	407	432	457	482	507	557
84 Half Width	41 x .75 x 26	FTOC4126	168	214	237	260	283	306	329	352	375	398	421	444	467	513
72 Half Width	35 x .75 x 26	FTOC3526	147	186	206	226	246	266	286	306	326	346	366	386	406	446
66 Half Width	32 x .75 x 26	FTOC3226	132	170	188	206	224	242	260	278	296	314	332	350	368	404
60 Half Width	29 x .75 x 26	FTOC2926	122	155	171	187	203	219	235	251	267	283	299	315	331	363

### Standard Features

- Constructed of .5" thick fiberboard
- Fabric is precisely aligned and fitted to the tackboard
- Adhered to the rigid hardboard with staples
- Hung with Z-Strip mounting system

### Notes

- Half width tackboards can be specified and combined with a Veneer Panel, Marker Board, Slat Wall or Glass Board. See "Half Width" items under product width.
- Specify right or left facing tackboard
- Fabric Tack Panels are raised 3" from bottom edge when TM50 grommet is ordered.

## Rift tackboards.

Overhead dry marker board  
Full width dry marker board

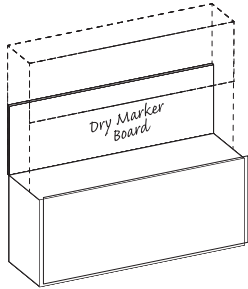

Product Width	Panel Dimension	SKU	List
96	94 x .5 x 26	DMOC9426	1173
90	88 x .5 x 26	DMOC8826	1098
84	82 x .5 x 26	DMOC8226	1023
72	70 x .5 x 26	DMOC7026	874
66	64 x .5 x 26	DMOC6426	799
60	58 x .5 x 26	DMOC5826	724
36	34 x .5 x 26	DMOC3426	399
30	28 x .5 x 26	DMOC2826	349

### Standard Features

- Dry marker panel has edge trim molding
- Standard magnetic surface
- Hung with Z-Strip mounting system

Overhead dry marker board  
Half width dry marker board

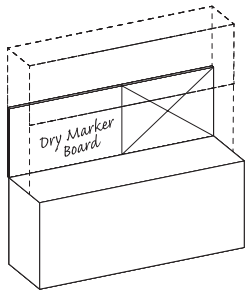

Product Width	Panel Dimension	SKU	List
96 Half Width	47 x .5 x 26	DMOC4726	574
90 Half Width	44 x .5 x 26	DMOC4426	537
84 Half Width	41 x .5 x 26	DMOC4126	499
72 Half Width	35 x .5 x 26	DMOC3526	424
66 Half Width	32 x .5 x 26	DMOC3226	387
60 Half Width	29 x .5 x 26	DMOC2926	349

### Standard Features

- Dry marker panel has edge trim molding
- Standard magnetic surface
- Hung with Z-Strip mounting system

### Notes

- Half width dry marker boards can be specified and combined with a Tackboard, Veneer Panel, Slat Wall or Glass Board. See "Half Width" items under product width.
- Specify right or left facing dry marker board

## Rift tackboards.

### Overhead glassboard Full width glassboards

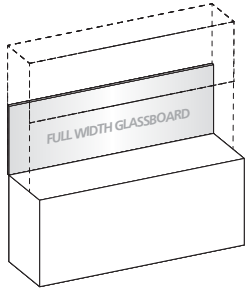

Product Width	Panel Dimension	SKU	List
96	94 x .5 x 26	GBOC9426	2651
90	88 x .5 x 26	GBOC8826	2494
84	82 x .5 x 26	GBOC8226	2337
72	70 x .5 x 26	GBOC7026	2021
66	64 x .5 x 26	GBOC6426	1864
60	58 x .5 x 26	GBOC5826	1732
36	34 x .5 x 26	GBOC3426	1080
30	28 x .5 x 26	GBOC2826	924

Standard Features  
- 4 mm tempered glass

Notes  
- Use glass cleaner or alcohol to clean  
- Standard dry erase markers may be used  
- Earth magnets are required to hold items securely in place  
- Hung with Z-Strip mounting system

### Overhead glassboard Half width glassboards

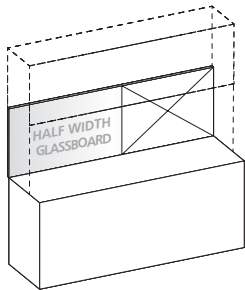

Product Width	Panel Dimension	SKU	List
96 Half Width	47 x .5 x 26	GBOC4726	1325
90 Half Width	45 x .5 x 26	GBOC4526	1247
84 Half Width	41 x .5 x 26	GBOC4126	1169
72 Half Width	35 x .5 x 26	GBOC3526	1011
66 Half Width	32 x .5 x 26	GBOC3226	932
60 Half Width	29 x .5 x 26	GBOC2926	866

Standard Features  
- 4 mm tempered glass  
- Hung with Z-Strip mounting system

Notes  
- Half width glassboards can be specified and combined with a Tackboard, Veneer panel, Marker Board or Slat Wall. See "Half Width" items under product width.  
- Must specify Right or left facing glassboard  
- Use glass cleaner or alcohol to clean  
- Standard dry erase markers may be used  
- Earth magnets are required to hold items securely in place

## Rift tackboards.

Overhead slat wall  
*Half width slat wall*

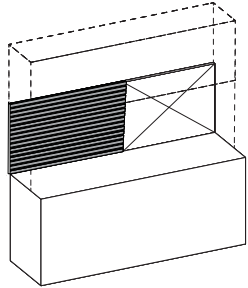

Product Width	Panel Dimension	SKU	List
96 Half Width	47 x .5 x 26	SWOC4726	463
90 Half Width	44 x .5 x 26	SWOC4426	432
84 Half Width	41 x .5 x 26	SWOC4126	411
72 Half Width	35 x .5 x 26	SWOC3526	374
66 Half Width	32 x .5 x 26	SWOC3226	343
60 Half Width	29 x .5 x 26	SWOC2926	300

### Standard Features

- Available in silver or black
- For use on 42"/43" height consoles
- Hung with Z-Strip mounting system

### Notes

- Half width slat walls can be specified and combined with a Tackboard, Veneer panel, Marker Board or Glassboard. See "Half Width" items under product width.
- Specify right or left facing slat wall
- For use on 42"/43" height consoles

# Rift.

## Wall Hung Storage Single Height Hinged Wood Doors

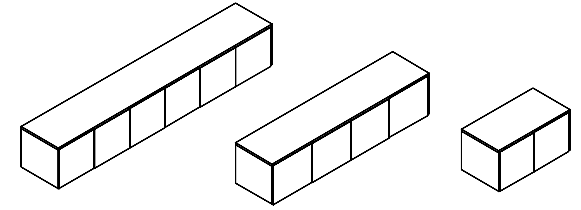

### 1 Select a model w" x d" x h"

weight	Standard Veneer Top	Premium Veneer Top	High Pressure Laminate Top	Thermally Fused Laminate Top
	Standard Veneer Chassis	Premium Veneer Chassis	Veneer Chassis	Thermally Fused Laminate Chassis
<b>6 Door / 3 Section</b>				
96 x 15 x 15	240 "W" Option N/A	RFT9615WH330P 4252	"G" Option N/A	"M" Option N/A
90 x 15 x 15	225 "W" Option N/A	RFT9015WH330P 4107	"G" Option N/A	"M" Option N/A
84 x 15 x 15	210 "W" Option N/A	RFT8415WH330P 3890	"G" Option N/A	"M" Option N/A
<b>4 Door / 2 Section</b>				
72 x 15 x 15	180 "W" Option N/A	RFT7215WH330P 3649	"G" Option N/A	"M" Option N/A
66 x 15 x 15	160 "W" Option N/A	RFT6615WH330P 3529	"G" Option N/A	"M" Option N/A
60 x 15 x 15	135 "W" Option N/A	RFT6015WH330P 3408	"G" Option N/A	"M" Option N/A
<b>2 Door / 1 Section</b>				
36 x 15 x 15	75 "W" Option N/A	RFT3615WH330P 2436	"G" Option N/A	"M" Option N/A
30 x 15 x 15	65 "W" Option N/A	RFT3015WH330P 2367	"G" Option N/A	"M" Option N/A
<b>2 Select a finish</b> <i>View finish details</i>				
		TBCO TBSW TSTV TSMV TSLV TOBW		
<b>3 Select a edge</b> <i>View edge details</i>				
		Edge N/A		
<b>4 Select hardware</b> <i>View hardware details</i>				
		Hardware N/A		

[View statement of line](#)

## Product features.

- Finished top
- Interior cabinet depth 12"
- Touch latch

### NOTES

- The DARRAN wall mounted cabinet must be hung on a weight-bearing wall. The suitability of the wall supporting the all mounted cabinet, and the installation and maintenance of the wall-mounted cabinet, is the sole responsibility of the customer. Failure to correctly install and/or exceed the loaded weight capacity of this product may cause it to fall, resulting in damage to the product, adjacent property and/or bodily injury.

## Options.

### DOOR

- D2: Wood Door Lock - \$100 per door set
- D2-G: Door Lock for Glass Doors - \$205 per door set (only when RF375AW is ordered)
- D6: Delete Doors - n/c
- RF375AW: Aluminum/White Glass - \$390 per door
- WPD3061: Designer White - \$35 per door

### TASK LIGHT

- LED24: 24" Slim Line Aluminum LED Task light - \$330
- LED48: 48" Slim Line Aluminum LED Task light - \$465
- LED60: 60" Slim Line Aluminum LED Task light - \$580
- DPC: Link multiple Task lights up to 30W of power wattage. Deletes 1 power drive - Deduct \$85 per Task light
- LC24: Linking Task light cable - \$25

Rift.

Wall Hung Storage Single Height  
Sliding Wood Doors

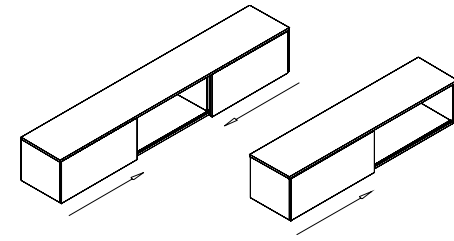

[View statement of line](#)

1 Select a model w" x d" x h"	weight	Standard Veneer Top	Premium Veneer Top	High Pressure Laminate Top	Thermally Fused Laminate Top
		Standard Veneer Chassis	Premium Veneer Chassis	Veneer Chassis	Thermally Fused Laminate Chassis
<b>3 Section</b>					
96 x 15 x 15	240	"W" Option N/A	RFT9615WH872P 4492	"G" Option N/A	"M" Option N/A
90 x 15 x 15	225	"W" Option N/A	RFT9015WH872P 4347	"G" Option N/A	"M" Option N/A
84 x 15 x 15	210	"W" Option N/A	RFT8415WH872P 4131	"G" Option N/A	"M" Option N/A
<b>2 Section</b>					
72 x 15 x 15	180	"W" Option N/A	RFT7215WH872P 3829	"G" Option N/A	"M" Option N/A
66 x 15 x 15	100	"W" Option N/A	RFT6615WH872P 3710	"G" Option N/A	"M" Option N/A
60 x 15 x 15	135	"W" Option N/A	RFT6015WH872P 3589	"G" Option N/A	"M" Option N/A
<b>2 Select a finish</b> <a href="#">View finish details</a>			TBCO TBSW TSTV TSMV TSLV TOBW		
<b>3 Select a edge</b> <a href="#">View edge details</a>			Edge N/A		
<b>4 Select hardware</b> <a href="#">View hardware details</a>			Hardware N/A		

Product features.

- Finished top
- Interior cabinet depth 12"

NOTES

- The DARRAN wall mounted cabinet must be hung on a weight-bearing wall. The suitability of the wall supporting the all mounted cabinet, and the installation and maintenance of the wall-mounted cabinet, is the sole responsibility of the customer. Failure to correctly install and/or exceed the loaded weight capacity of this product may cause it to fall, resulting in damage to the product, adjacent property and/or bodily injury.

Options.

DOOR

- RF550AW: Aluminum/White Glass - \$575 per door
- WPD3061: Designer White - \$35 per door

INTERIOR CABINET LIGHTING

LEDPK starter kit includes Infeed, 1 Puck Interior Light and the ability to daisy chain up to 6 total Puck Lights

- LEDPK: LED Puck Starter Kit - \$310
- PK: 1 LED Interior Light - \$130

TASK LIGHT

- LED24: 24" Slim Line Aluminum LED Task light - \$330
- LED48: 48" Slim Line Aluminum LED Task light - \$465
- LED60: 60" Slim Line Aluminum LED Task light - \$580
- DPC: Link multiple Task lights up to 30W of power wattage. Deletes 1 power drive - Deduct \$85 per Task light
- LC24: Linking Task light cable - \$25

# Rift.

Wall Hung Storage Double Height  
Hinged Wood Doors

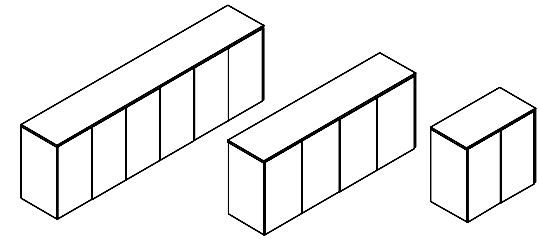

[View statement of line](#)

1 Select a model w" x d" x h"	weight	Standard Veneer Top	Premium Veneer Top	High Pressure Laminate Top	Thermally Fused Laminate Top
		Standard Veneer Chassis	Premium Veneer Chassis	Veneer Chassis	Thermally Fused Laminate Chassis
<b>6 Door / 3 Section</b>					
96 x 15 x 28.3	295	"W" Option N/A	RFT9628WH330P 4853	"G" Option N/A	"M" Option N/A
90 x 15 x 28.3	275	"W" Option N/A	RFT9028WH330P 4588	"G" Option N/A	"M" Option N/A
84 x 15 x 28.3	260	"W" Option N/A	RFT8428WH330P 4468	"G" Option N/A	"M" Option N/A
<b>4 Door / 2 Section</b>					
72 x 15 x 28.3	220	"W" Option N/A	RFT7228WH330P 4131	"G" Option N/A	"M" Option N/A
66 x 15 x 28.3	200	"W" Option N/A	RFT6628WH330P 4010	"G" Option N/A	"M" Option N/A
60 x 15 x 28.3	180	"W" Option N/A	RFT6028WH330P 3890	"G" Option N/A	"M" Option N/A
<b>2 Door / 1 Section</b>					
36 x 15 x 28.3	110	"W" Option N/A	RFT3628WH330P 2699	"G" Option N/A	"M" Option N/A
30 x 15 x 28.3	95	"W" Option N/A	RFT3028WH330P 2607	"G" Option N/A	"M" Option N/A
			TBCO TBSW TSTV TSMV TSLV TOBW		
			Edge N/A		
			Hardware N/A		

2 Select a finish  
[View finish details](#)

3 Select an edge  
[View edge details](#)

4 Select hardware  
[View hardware details](#)

## Product features.

- Adjustable veneer shelf per door section
- Black painted top
- Interior cabinet depth 12"
- Touch latch

### NOTES

- The DARRAN wall mounted cabinet must be hung on a weight-bearing wall. The suitability of the wall supporting the all mounted cabinet, and the installation and maintenance of the wall-mounted cabinet, is the sole responsibility of the customer. Failure to correctly install and/or exceed the loaded weight capacity of this product may cause it to fall, resulting in damage to the product, adjacent property and/or bodily injury.

## Options.

### DOOR

- D2: Wood Door Lock - \$100 per door set
- D2-G: Door Lock for Glass Doors - \$205 per door set (only when RF475AW is ordered)
- D6: Delete Doors - n/c
- RF475AW: Aluminum/White Glass - \$495 per door
- WPD3061: Designer White - \$55 per door

### INTERIOR CABINET LIGHTING

- LEDPK starter kit includes Infeed, 1 Puck Interior Light and the ability to daisy chain up to 6 total Puck Lights
- LEDPK: LED Puck Starter Kit - \$310
- PK: 1 LED Interior Light - \$130

### SHELF

- G514F: Replace Standard Shelves with Glass Shelves - \$90 per shelf
- S714F: Heavy Duty Lumber 1" Shelves - \$80 per shelf

### TASK LIGHT

- LED24: 24" Slim Line Aluminum LED Task light - \$330
- LED48: 48" Slim Line Aluminum LED Task light - \$465
- LED60: 60" Slim Line Aluminum LED Task light - \$580
- DPC: Link multiple Task lights up to 30W of power wattage. Deletes 1 power drive - Deduct \$85 per Task light
- LC24: Linking Task light cable - \$25



# Rift.

## Wall Hung Storage Double Height Sliding Wood Doors

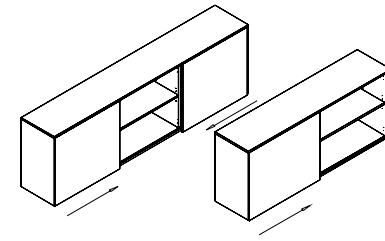

[View statement of line](#)

1 Select a model w" x d" x h"	weight	Standard Veneer Top	Premium Veneer Top	High Pressure Laminate Top	Thermally Fused Laminate Top
		Standard Veneer Chassis	Premium Veneer Chassis	Veneer Chassis	Thermally Fused Laminate Chassis
<b>3 Section</b>					
96 x 15 x 28.3	290	"W" Option N/A	RFT9628WH872P 5094	"G" Option N/A	"M" Option N/A
90 x 15 x 28.3	270	"W" Option N/A	RFT9028WH872P 4829	"G" Option N/A	"M" Option N/A
84 x 15 x 28.3	255	"W" Option N/A	RFT8428WH872P 4709	"G" Option N/A	"M" Option N/A
<b>2 Section</b>					
72 x 15 x 28.3	215	"W" Option N/A	RFT7228WH872P 4311	"G" Option N/A	"M" Option N/A
66 x 15 x 28.3	195	"W" Option N/A	RFT6628WH872P 4191	"G" Option N/A	"M" Option N/A
60 x 15 x 28.3	175	"W" Option N/A	RFT6028WH872P 4071	"G" Option N/A	"M" Option N/A
<b>2 Select a finish</b> <a href="#">View finish details</a>			TBCO TBSW TSTV TSMV TSLV TOBW		
<b>3 Select a edge</b> <a href="#">View edge details</a>			Edge N/A		
<b>4 Select hardware</b> <a href="#">View hardware details</a>			Hardware N/A		

## Product features.

- Adjustable shelf per door section
- Black painted top
- Interior cabinet depth 12"

### NOTES

- The DARRAN wall mounted cabinet must be hung on a weight-bearing wall. The suitability of the wall supporting the all mounted cabinet, and the installation and maintenance of the wall-mounted cabinet, is the sole responsibility of the customer. Failure to correctly install and/or exceed the loaded weight capacity of this product may cause it to fall, resulting in damage to the product, adjacent property and/or bodily injury.

## Options.

### DOOR

- RF850AW: Aluminum/White Glass - \$885 per door
- WPD3061: Designer White - \$55 per door

### INTERIOR CABINET LIGHTING

LEDPK starter kit includes Infeed, 1 Puck Interior Light and the ability to daisy chain up to 6 total Puck Lights

- LEDPK: LED Puck Starter Kit - \$310
- PK: 1 LED Interior Light - \$130

### SHELF

- GS14F: Replace Standard Shelves with Glass Shelves - \$90 per shelf
- S714F: Heavy Duty Lumber 1" Shelves - \$80 per shelf

### TASK LIGHT

- LED24: 24" Slim Line Aluminum LED Task light - \$330
- LED48: 48" Slim Line Aluminum LED Task light - \$465
- LED60: 60" Slim Line Aluminum LED Task light - \$580
- DPC: Link multiple Task lights up to 30W of power wattage. Deletes 1 power drive - Deduct \$85 per Task light
- LC24: Linking Task light cable - \$25

# Rift tackboards.

## Wall hung tackboards Full width tackboards

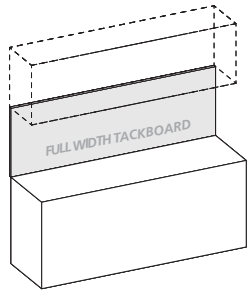

Product Width	Panel Dimension	SKU	COM	1	2	3	4	5	6	7	8	9	10	11/L1	12	13/L2
96	96 x .75 x 26	FTWH9626	484	599	654	709	764	820	875	930	985	1040	1095	1150	1205	1316
90	90 x .75 x 26	FTWH9026	457	562	614	665	717	768	820	870	922	973	1025	1076	1128	1231
84	84 x .75 x 26	FTWH8426	422	518	566	614	661	709	757	805	853	901	948	996	1044	1140
72	72 x .75 x 26	FTWH7226	366	449	493	536	579	622	666	708	752	795	838	881	925	1011
66	66 x .75 x 26	FTWH6626	339	412	451	491	530	570	609	649	688	728	768	807	847	926
60	60 x .75 x 26	FTWH6026	297	374	410	445	480	516	551	587	622	657	693	728	763	834
36	36 x .75 x 26	FTWH3626	181	225	245	266	287	308	329	349	370	391	412	433	453	495
30	30 x .75 x 26	FTWH3026	149	187	205	223	240	258	276	293	311	329	346	364	382	417

### Standard Features

- Constructed of .5" thick fiberboard
- Fabric is precisely aligned and fitted to the tackboard
- Adhered to the rigid hardboard with staples
- Hung with Z-Strip mounting system

## Wall hung tackboards Half width tackboards

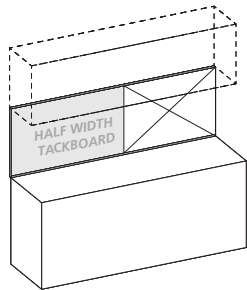

Product Width	Panel Dimension	SKU	COM	1	2	3	4	5	6	7	8	9	10	11/L1	12	13/L2
96 Half Width	48 x .75 x 26	FTWH4826	242	309	336	363	390	417	444	471	498	525	552	579	606	660
90 Half Width	45 x .75 x 26	FTWH4526	229	290	316	342	368	394	420	446	472	498	524	550	576	628
84 Half Width	42 x .75 x 26	FTWH4226	211	267	291	315	339	363	387	411	435	459	483	507	531	579
72 Half Width	36 x .75 x 26	FTWH3626	183	232	254	276	298	320	342	364	386	408	430	452	474	518
66 Half Width	33 x .75 x 26	FTWH3326	170	213	232	251	270	289	308	327	346	365	384	403	422	460
60 Half Width	30 x .75 x 26	FTWH3026	149	193	211	229	247	265	283	301	319	337	355	373	391	427

### Standard Features

- Constructed of .5" thick fiberboard
- Fabric is precisely aligned and fitted to the tackboard
- Adhered to the rigid hardboard with staples
- Hung with Z-Strip mounting system

### Notes

- Half width tackboards can be specified and combined with a Veneer Panel, Marker Board, Slat Wall or Glass Board. See "Half Width" items under product width.
- Specify right or left facing tackboard

## Rift tackboards.

Wall hung dry marker board  
Full width dry marker board

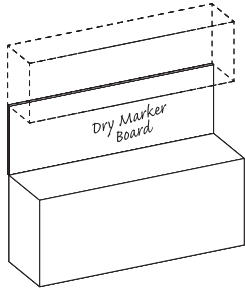

Product Width	Panel Dimension	SKU	List
96	96 x .75 x 26	DMWH9626	1198
90	90 x .75 x 26	DMWH9026	1123
84	84 x .75 x 26	DMWH8426	1048
72	72 x .75 x 26	DMWH7226	899
66	66 x .75 x 26	DMWH6626	824
60	60 x .75 x 26	DMWH6026	749
36	36 x .75 x 26	DMWH3626	449
30	30 x .75 x 26	DMWH3026	374

### Standard Features

- Dry marker panel has edge trim molding
- Standard magnetic surface
- Hung with Z-Strip mounting system

Wall hung dry marker board  
Half width dry marker board

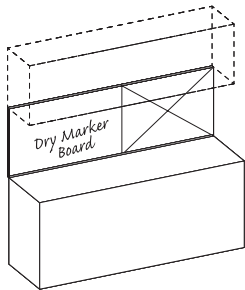

Product Width	Panel Dimension	SKU	List
96 Half Width	48 x .75 x 26	DMWH4826	599
90 Half Width	45 x .75 x 26	DMWH4526	562
84 Half Width	42 x .75 x 26	DMWH4226	524
72 Half Width	36 x .75 x 26	DMWH3626	449
66 Half Width	33 x .75 x 26	DMWH3326	412
60 Half Width	30 x .75 x 26	DMWH3026	374

### Standard Features

- Dry marker panel has edge trim molding
- Standard magnetic surface
- Hung with Z-Strip mounting system

### Notes

- Half width dry marker boards can be specified and combined with a Tackboard, Veneer Panel, Slat Wall or Glass Board. See "Half Width" items under product width.
- Specify right or left facing dry marker board

## Rift tackboards.

Wall hung veneer panel  
Full width veneer panel

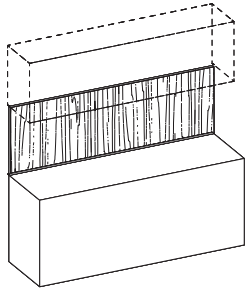

Product Width	Panel Dimension	SKU	List
96	96 x .75 x 26	VPWH9626	998
90	90 x .75 x 26	VPWH9026	936
84	84 x .75 x 26	VPWH8426	874
72	72 x .75 x 26	VPWH7226	749
66	66 x .75 x 26	VPWH6626	686
60	60 x .75 x 26	VPWH6026	624
36	36 x .75 x 26	VPWH3626	374
30	30 x .75 x 26	VPWH3026	312

### Standard Features

- Veneer edges

### Notes

- Vertical wire channels on back for task light cords
- Steel mounting wall channel is recessed for flush mounting
- Hung with Z-Strip mounting system
- Can be used with or without overhead cabinet
- Required for other accessory panels

Wall hung veneer panel  
Half width veneer panels

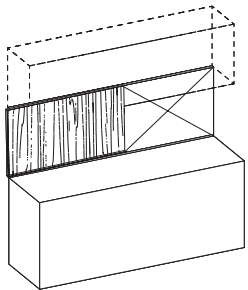

Product Width	Panel Dimension	SKU	List
96 Half Width	48 x .75 x 26	VPWH4826	499
90 Half Width	45 x .75 x 26	VPWH4526	468
84 Half Width	42 x .75 x 26	VPWH4226	437
72 Half Width	36 x .75 x 26	VPWH3626	374
66 Half Width	33 x .75 x 26	VPWH3326	343
60 Half Width	30 x .75 x 26	VPWH3026	312

### Standard Features

- Veneer edges
- Vertical wire channels on back for task light cords
- Steel mounting wall channel is recessed for flush mounting
- Hung with Z-Strip mounting system

### Notes

- Half width veneer panels can be specified and combined with a Tackboard, Marker Board, Slat Wall or Glass Board. See "Half Width" items under product width.
- Specify right or left facing veneer panel
- Can be used with or without overhead cabinet
- Required for other accessory panels

## Rift tackboards.

Wall hung glassboard  
Full width glassboards

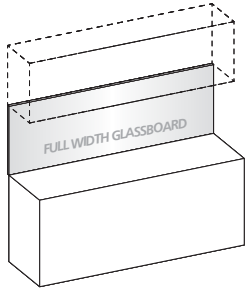

Product Width	Panel Dimension	SKU	List
96	96 x .75 x 26	GBWH9626	3063
90	90 x .75 x 26	GBWH9026	2883
84	84 x .75 x 26	GBWH8426	2706
72	72 x .75 x 26	GBWH7226	2348
66	66 x .75 x 26	GBWH6626	2168
60	60 x .75 x 26	GBWH6026	2012
36	36 x .75 x 26	GBWH3626	1268
30	30 x .75 x 26	GBWH3026	1090

Standard Features  
- 4 mm tempered glass

Notes  
- Use glass cleaner or alcohol to clean  
- Standard dry erase markers may be used  
- Earth magnets are required to hold items securely in place  
- Hung with Z-Strip mounting system

Wall hung glassboard  
Half width glassboards

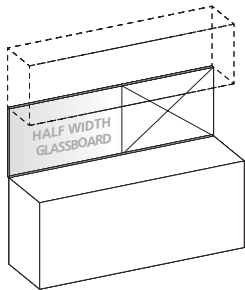

Product Width	Panel Dimension	SKU	List
96 Half Width	48 x .75 x 26	GBWH4826	1532
90 Half Width	45 x .75 x 26	GBWH4526	1442
84 Half Width	42 x .75 x 26	GBWH4226	1353
72 Half Width	36 x .75 x 26	GBWH3626	1175
66 Half Width	33 x .75 x 26	GBWH3326	1085
60 Half Width	30 x .75 x 26	GBWH3026	1007

Standard Features  
- 4 mm tempered glass  
- Hung with Z-Strip mounting system

Notes  
- Half width glassboards can be specified and combined with a Tackboard, Veneer panel, Marker Board or Slat Wall. See "Half Width" items under product width.  
- Specify right or left facing glassboard  
- Use glass cleaner or alcohol to clean  
- Standard dry erase markers may be used  
- Earth magnets are required to hold items securely in place

## Rift tackboards.

Wall hung slat wall  
Half width slat board

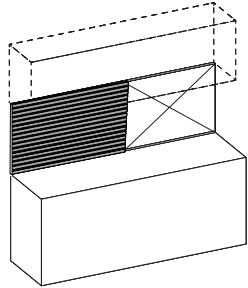

Product Width	Panel Dimension	SKU	List
96 Half Width	48 x .75 x 26	SWWH4826	499
90 Half Width	45 x .75 x 26	SWWH4526	468
84 Half Width	42 x .75 x 26	SWWH4226	437
72 Half Width	36 x .75 x 26	SWWH3626	374
66 Half Width	33 x .75 x 26	SWWH3326	343
60 Half Width	30 x .75 x 26	SWWH3026	312

### Standard Features

- Available in silver or black
- Hung with Z-Strip mounting system

### Notes

- Half width slat walls can be specified and combined with a Tackboard, Veneer panel, Marker Board or Glassboard. See "Half Width" items under product width.
- Specify right or left facing slat wall
- For use on 42"/43" height consoles

Rift.

Floating Wall Mounted Shelf  
Single Shelf

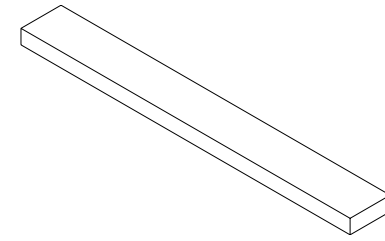

[View statement of line](#)

1 Select a model w" x d" x h"	weight	Standard Veneer Top	Premium Veneer Top	High Pressure Laminate Top	Thermally Fused Laminate Top
		Standard Veneer Chassis	Premium Veneer Chassis	Veneer Chassis	Thermally Fused Laminate Chassis
96 x 3 x 8	22	"W" Option N/A	RFT9608WH338P 790	"G" Option N/A	"M" Option N/A
90 x 3 x 8	21	"W" Option N/A	RFT9008WH338P 748	"G" Option N/A	"M" Option N/A
84 x 3 x 8	19	"W" Option N/A	RFT8408WH338P 708	"G" Option N/A	"M" Option N/A
72 x 3 x 8	16	"W" Option N/A	RFT7208WH338P 636	"G" Option N/A	"M" Option N/A
66 x 3 x 8	15	"W" Option N/A	RFT6608WH338P 596	"G" Option N/A	"M" Option N/A
60 x 3 x 8	14	"W" Option N/A	RFT6008WH338P 557	"G" Option N/A	"M" Option N/A
36 x 3 x 8	8	"W" Option N/A	RFT3608WH338P 398	"G" Option N/A	"M" Option N/A
30 x 3 x 8	7	"W" Option N/A	RFT3008WH338P 359	"G" Option N/A	"M" Option N/A
			TBCO TBSW TSTV TSMV TSLV TOBW		
			Edge N/A		
			Hardware N/A		

2 Select a finish  
[View finish details](#)

3 Select an edge  
[View edge details](#)

4 Select hardware  
[View hardware details](#)

Product features.

- Wall brackets included
- Wall brackets provide horizontal and vertical adjustments

NOTES

- Proper installation is critical to ensure safety from possible falling wall mounted shelves. The factory assumes no liability for damage or injury from the following: installation into non-load bearing or unlevel walls. Improper fasteners used in installation. Overloading of the wall mounted shelves resulting in failures of wall and surrounding structures, fasteners, or wall mounted shelf construction. Misuse of the wall mounted shelves for intended purposes.
- 96" shelf will support 28lbs of additional weight, 90" shelf will support 29lbs, 84" shelf will support 31lbs, 72" shelf will support 24lbs, 66" shelf will support 25lbs, 60" shelf will support 16lbs, 36" shelf will support 12lbs, 30" shelf will support 13lbs.

Rift.

Wall Hung Open Shelf  
Single Height - 19"/15"H

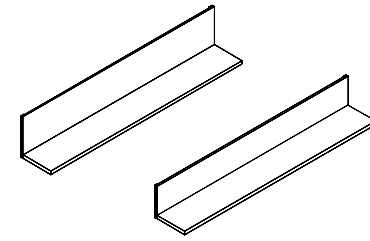

[View statement of line](#)

1 Select a model w" x d" x h"	weight	Standard Veneer Top	Premium Veneer Top	High Pressure Laminate Top	Thermally Fused Laminate Top
		Standard Veneer Chassis	Premium Veneer Chassis	Veneer Chassis	Thermally Fused Laminate Chassis
<b>19" Height</b>					
96 x 15 x 18.8	105	"W" Option N/A	RFT9619WH336P 3324	"G" Option N/A	"M" Option N/A
90 x 15 x 18.8	100	"W" Option N/A	RFT9019WH336P 3204	"G" Option N/A	"M" Option N/A
72 x 15 x 18.8	80	"W" Option N/A	RFT7219WH336P 2602	"G" Option N/A	"M" Option N/A
66 x 15 x 18.8	75	"W" Option N/A	RFT6619WH336P 2368	"G" Option N/A	"M" Option N/A
60 x 15 x 18.8	65	"W" Option N/A	RFT6019WH336P 2421	"G" Option N/A	"M" Option N/A
36 x 15 x 18.8	40	"W" Option N/A	RFT3619WH336P 1519	"G" Option N/A	"M" Option N/A
30 x 15 x 18.8	35	"W" Option N/A	RFT3019WH336P 1428	"G" Option N/A	"M" Option N/A
<b>15" Height</b>					
96 x 15 x 15.3	100	"W" Option N/A	RFT9615WH336P 3005	"G" Option N/A	"M" Option N/A
90 x 15 x 15.3	95	"W" Option N/A	RFT9015WH336P 2884	"G" Option N/A	"M" Option N/A
72 x 15 x 15.3	75	"W" Option N/A	RFT7215WH336P 2283	"G" Option N/A	"M" Option N/A
66 x 15 x 15.3	70	"W" Option N/A	RFT6615WH336P 2190	"G" Option N/A	"M" Option N/A
60 x 15 x 15.3	60	"W" Option N/A	RFT6015WH336P 2104	"G" Option N/A	"M" Option N/A
36 x 15 x 15.3	35	"W" Option N/A	RFT3615WH336P 1199	"G" Option N/A	"M" Option N/A
30 x 15 x 15.3	30	"W" Option N/A	RFT3015WH336P 1108	"G" Option N/A	"M" Option N/A
2 Select a finish <a href="#">View finish details</a>			TBCO TBSW TSTV TSMV TSLV TOBW		
3 Select a edge <a href="#">View edge details</a>			Edge N/A		
4 Select hardware <a href="#">View hardware details</a>			Hardware N/A		

Product features.

**NOTES**

- Max weight capacity 36 lbs per 1 FT width
- The DARRAN wall mounted cabinet must be hung on a weight-bearing wall. The suitability of the wall supporting the all mounted cabinet, and the installation and maintenance of the wall-mounted cabinet, is the sole responsibility of the customer. Failure to correctly install and/or exceed the loaded weight capacity of this product may cause it to fall, resulting in damage to the product, adjacent property and/or bodily injury.

Options.

**TASK LIGHT**

- LED24: 24" Slim Line Aluminum LED Task light - \$330
- LED48: 48" Slim Line Aluminum LED Task light - \$465
- LED60: 60" Slim Line Aluminum LED Task light - \$580
- DPC: Link multiple Task lights up to 30W of power wattage. Deletes 1 power drive - Deduct \$85 per Task light
- LC24: Linking Task light cable - \$25



Rift.

Wall Hung Open Shelf  
Double Height - 32"/128"H

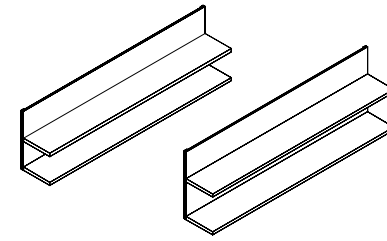

[View statement of line](#)

1 Select a model w" x d" x h"	weight	Standard Veneer Top	Premium Veneer Top	High Pressure Laminate Top	Thermally Fused Laminate Top
		Standard Veneer Chassis	Premium Veneer Chassis	Veneer Chassis	Thermally Fused Laminate Chassis
<b>32" Height</b>					
96 x 15 x 31.8	165	"W" Option N/A	RFT9632WH336P 3927	"G" Option N/A	"M" Option N/A
90 x 15 x 31.8	155	"W" Option N/A	RFT9032WH336P 3805	"G" Option N/A	"M" Option N/A
72 x 15 x 31.8	125	"W" Option N/A	RFT7232WH336P 3204	"G" Option N/A	"M" Option N/A
66 x 15 x 31.8	115	"W" Option N/A	RFT6632WH336P 2970	"G" Option N/A	"M" Option N/A
60 x 15 x 31.8	105	"W" Option N/A	RFT6032WH336P 3022	"G" Option N/A	"M" Option N/A
36 x 15 x 31.8	65	"W" Option N/A	RFT3632WH336P 1760	"G" Option N/A	"M" Option N/A
30 x 15 x 31.8	55	"W" Option N/A	RFT3032WH336P 1668	"G" Option N/A	"M" Option N/A
<b>28" Height</b>					
96 x 15 x 28.3	160	"W" Option N/A	RFT9628WH336P 3927	"G" Option N/A	"M" Option N/A
90 x 15 x 28.3	150	"W" Option N/A	RFT9028WH336P 3805	"G" Option N/A	"M" Option N/A
72 x 15 x 28.3	120	"W" Option N/A	RFT7228WH336P 3204	"G" Option N/A	"M" Option N/A
66 x 15 x 28.3	110	"W" Option N/A	RFT6628WH336P 3114	"G" Option N/A	"M" Option N/A
60 x 15 x 28.3	100	"W" Option N/A	RFT6028WH336P 3022	"G" Option N/A	"M" Option N/A
36 x 15 x 28.3	60	"W" Option N/A	RFT3628WH336P 1760	"G" Option N/A	"M" Option N/A
30 x 15 x 28.3	50	"W" Option N/A	RFT3028WH336P 1668	"G" Option N/A	"M" Option N/A
<b>2 Select a finish</b> <a href="#">View finish details</a>			TBCO TBSW TSTV TSMV TSLV TOBW		
<b>3 Select a edge</b> <a href="#">View edge details</a>			Edge N/A		
<b>4 Select hardware</b> <a href="#">View hardware details</a>			Hardware N/A		

Product features.

- Double height with fixed shelf

NOTES

- Max weight capacity 36 lbs per 1 FT width  
- The DARRAN wall mounted cabinet must be hung on a weight-bearing wall. The suitability of the wall supporting the all mounted cabinet, and the installation and maintenance of the wall-mounted cabinet, is the sole responsibility of the customer. Failure to correctly install and/or exceed the loaded weight capacity of this product may cause it to fall, resulting in damage to the product, adjacent property and/or bodily injury.

Options.

TASK LIGHT

- LED24: 24" Slim Line Aluminum LED Task light - \$330
- LED48: 48" Slim Line Aluminum LED Task light - \$465
- LED60: 60" Slim Line Aluminum LED Task light - \$580
- DPC: Link multiple Task lights up to 30W of power wattage. Deletes 1 power drive - Deduct \$85 per Task light
- LC24: Linking Task light cable - \$25

# Rift.

Overhead Full Towers  
Storage With Hinged Wood Door

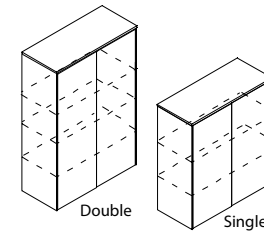

1 Select a model w" x d" x h"	weight	Standard Veneer Top	Premium Veneer Top	High Pressure Laminate Top	Thermally Fused Laminate Top
		Standard Veneer Chassis	Premium Veneer Chassis	Veneer Chassis	Thermally Fused Laminate Chassis
<b>Double Height</b>					
36 x 15 x 54	130	"W" Option N/A	RFT3654OH383P 2889	"G" Option N/A	"M" Option N/A
30 x 15 x 54	120	"W" Option N/A	RFT3054OH383P 2770	"G" Option N/A	"M" Option N/A
<b>Single Height</b>					
36 x 15 x 41	120	"W" Option N/A	RFT3641OH383P 2649	"G" Option N/A	"M" Option N/A
30 x 15 x 41	110	"W" Option N/A	RFT3041OH383P 2529	"G" Option N/A	"M" Option N/A
			TBCO TBSW TSTV TSMV TSLV TOBW		
			Edge N/A		
			Hardware N/A		

[View statement of line](#)

## Product features.

- 3/4" Thick back panel
- Adjustable veneer shelves: 41" (2) and 54" (3)
- Interior shelf depth 14"
- Recessed front detailing
- Touch latch
- "W" styles 41" H units finished top, 54" H units black painted top

### NOTES

- Unit has black back panel and is not designed for Open Plan use. Select OPB Option for Open Plan application

## Options.

### DOOR

- D6: Delete Doors - n/c
- RF750AW: Accent Frame w/ White Glass - \$780 per door
- WPD3061: Designer White - \$130 per 41" door
- WPD3061: Designer White - \$160 per 54" door

### INTERIOR CABINET LIGHTING

- LEDPK starter kit includes Infeed, 1 Puck Interior Light and the ability to daisy chain up to 6 total Puck Lights
- LEDPK: LED Puck Starter Kit - \$310
- PK: 1 LED Interior Light - \$130

### OPEN PLAN – FINISHED BACK

- OPB: "W" "G" Style - Modify Unit for Open Plan Application - \$295

### SHELF

- GS14F: Replace Standard Shelves with Glass Shelves - \$90 per shelf
- S714F: Heavy Duty Lumber 1" Shelves - \$80 per shelf

# Rift.

## Vertical Half Towers Wardrobe With Door

1 Select a model w" x d" x h"	weight	Standard Veneer Top Standard Veneer Chassis
<b>Hinged Left - Single Height</b> 18 x 22 x 71	200	"W" Option N/A
<b>Hinged Left - Double Height</b> 18 x 22 x 83	215	"W" Option N/A
<b>Hinged Right - Single Height</b> 18 x 22 x 71	200	"W" Option N/A
<b>Hinged Right - Double Height</b> 18 x 22 x 83	215	"W" Option N/A

2 Select a finish <i>View finish details</i>
TBCO
TBSW
TSTV
TSMV
TSLV
TOBW

3 Select a edge <i>View edge details</i>
Edge N/A

4 Select hardware <i>View hardware details</i>
Hardware N/A

Premium Veneer Top Premium Veneer Chassis	High Pressure Laminate Top Veneer Chassis	Thermally Fused Laminate Top Thermally Fused Laminate Chassis
RFT1871TW877P 2481	"G" Option N/A	"M" Option N/A
RFT1883TW877P 2963	"G" Option N/A	"M" Option N/A
RFT1871TW878P 2481	"G" Option N/A	"M" Option N/A
RFT1883TW878P 2963	"G" Option N/A	"M" Option N/A

*View statement of line*

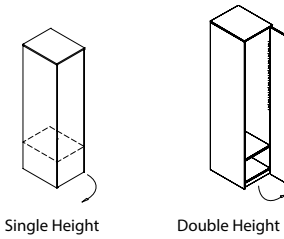

Single Height

Double Height

## Product features.

- 3/4" Thick back panel
- 71" H - Top is finished, 83" H - Top is painted black
- Adjustable shelves (3)/fixed shelf (1) 71"
- Adjustable shelves (4)/fixed shelf (1) 83"
- Coat rod and hook
- Recessed door detailing
- Touch latch

### NOTES

- Unit has black back panel and is not designed for Open Plan use. Select OPB Option for Open Plan application

## Options.

### ACCESSORIES

- MTL30-S: Silver metal legs - \$315 unit
- MTL30-W: White metal legs - \$420 unit

### DOOR

- D2: Door Lock - \$100 per door
- D2-G: Door Lock for Glass doors - \$205 per door
- D6: Delete Doors - n/c
- RF115AW: Full Height Aluminum/White Glass Doors - \$1200 per door
- WPD3061: Designer White - \$190 per 71" door
- WPD3061: Designer White - \$220 per 83" door

### OPEN PLAN – FINISHED BACK

- OPB: "W" "G" Style - Modify Unit for Open Plan Application - \$295

### SHELF

- GS14H: Replace Standard Shelves with Glass Shelves - \$70 per shelf

# Rift.

## Vertical Full Towers Wardrobe Storage With Double Door

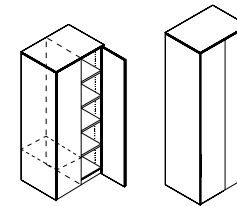

Single Height

Double Height

[View statement of line](#)

1 Select a model w" x d" x h"	weight	Standard Veneer Top	Premium Veneer Top	High Pressure Laminate Top	Thermally Fused Laminate Top
		Standard Veneer Chassis	Premium Veneer Chassis	Veneer Chassis	Thermally Fused Laminate Chassis
<b>Double Height</b> 36 x 22 x 83 30 x 22 x 83	340 305	"W" Option N/A "W" Option N/A	RFT3683TW275P RFT3083TW275P	5310 5191	"G" Option N/A "G" Option N/A
<b>Single Height</b> 36 x 22 x 71 30 x 22 x 71	325 290	"W" Option N/A "W" Option N/A	RFT3671TW275P RFT3071TW275P	4949 4829	"G" Option N/A "G" Option N/A
			TBCO TBSW TSTV TSMV TSLV TOBW		"M" Option N/A "M" Option N/A
			Edge N/A		"M" Option N/A "M" Option N/A
			Hardware N/A		

2 Select a finish  
[View finish details](#)

3 Select a edge  
[View edge details](#)

4 Select hardware  
[View hardware details](#)

## Product features.

- 83" Double Height - 1 fixed / 4 adj.
- 71" Single Height 1 fixed, 3 adj.
- Center partition
- Recessed door detailing
- Single height adjustable shelves (3)/fixed shelf (1)
- Touch latch
- Wardrobe w/ coat rod & hook (on Left)
- "W" styles - 71" H units finished top, 83" H units black painted top

### NOTES

- Unit has black back panel and is not designed for Open Plan use. Select OPB Option for Open Plan application

## Options.

### ACCESSORIES

- MTL30-S: Silver metal legs - \$315 unit
- MTL30-W: White metal legs - \$420 unit

### DOOR

- D2: Door Lock - \$100 per door
- D6: Delete Doors. Must specify door (R or L) - n/c
- RF115AW: Full Height Aluminum/White Glass Doors - \$1200 per door
- WPD3061: Designer White - \$190 per 71" door
- WPD3061: Designer White - \$220 per 83" door

### OPEN PLAN – FINISHED BACK







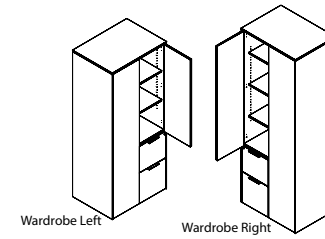

- OPB: "W" "G" Style - Modify Unit for Open Plan Application - \$295

Rift.

Vertical Full Towers  
File-File/Storage/Full Wardrobe



[View statement of line](#)

1 Select a model w" x d" x h"	weight	Standard Veneer Top	Premium Veneer Top	High Pressure Laminate Top	Thermally Fused Laminate Top
		Standard Veneer Chassis	Premium Veneer Chassis	Veneer Chassis	Thermally Fused Laminate Chassis
<b>Wardrobe Left - Single Height</b>					
36 x 22 x 71	305	"W" Option N/A	RFT3671TW273P	4937	"G" Option N/A
30 x 22 x 71	305	"W" Option N/A	RFT3071TW273P	4816	"G" Option N/A
<b>Wardrobe Left - Double Height</b>					
36 x 22 x 83	340	"W" Option N/A	RFT3683TW273P	5298	"G" Option N/A
30 x 22 x 83	340	"W" Option N/A	RFT3083TW273P	5177	"G" Option N/A
<b>Wardrobe Right - Single Height</b>					
36 x 22 x 71	305	"W" Option N/A	RFT3671TW274P	4937	"G" Option N/A
30 x 22 x 71	305	"W" Option N/A	RFT3071TW274P	4816	"G" Option N/A
<b>Wardrobe Right - Double Height</b>					
36 x 22 x 83	340	"W" Option N/A	RFT3683TW274P	5298	"G" Option N/A
30 x 22 x 83	340	"W" Option N/A	RFT3083TW274P	5177	"G" Option N/A
2 Select a finish <a href="#">View finish details</a>		TBCO			
		TBSW			
		TSTV			
		TSMV			
		TSLV			
		TOBW			
3 Select a edge <a href="#">View edge details</a>		Edge			
		N/A			
4 Select hardware <a href="#">View hardware details</a>		 PL-300 Matte Chrome	 PL-302 White		
		 PL-301 Matte Chrome	 PL-303 White		
		 PL-304 Matte Chrome	 PL-306 White		
		 PL-305 Matte Chrome	 PL-307 White		

Product features.

- Center partition
- Double Height adjustable shelves (3)
- Recessed door detailing
- Single height adjustable shelves (2)
- Soft close suspension drawer(s)
- Touch latch
- Wardrobe w/ coat rod & hook
- "W" styles - 71" H units finished top, 83" H units black painted top

NOTES

- Unit has black back panel and is not designed for Open Plan use. Select OPB Option for Open Plan application

Options.

ACCESSORIES

- MTL30-S: Silver metal legs - \$315 unit
- MTL30-W: White metal legs - \$420 unit

DOOR

- D2: Door Lock - \$100 per door
- D2-G: Door Lock for Glass Doors - \$205 per door set
- D6: Delete Doors - n/c
- RF115AW: Full Height Aluminum/White Glass Doors - \$1200 per door
- RF750AW: Accent Frame w/ White Glass Half Height - \$780 per door
- WPD3061: Designer White - \$190 per 71" door
- WPD3061: Designer White - \$220 per 83" door

DRAWER

- P6: Modify File/File to Box/Box/File - \$55 per pedestal

OPEN PLAN – FINISHED BACK

- OPB: "W" "G" Style - Modify Unit for Open Plan Application - \$295

# Rift.

Vertical Full Towers  
2 Lateral File/Storage Double Door

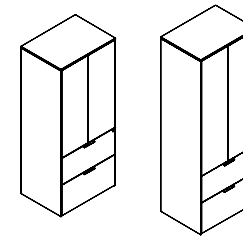

[View statement of line](#)

1 Select a model w" x d" x h"	weight	Standard Veneer Top	Premium Veneer Top	High Pressure Laminate Top	Thermally Fused Laminate Top
		Standard Veneer Chassis	Premium Veneer Chassis	Veneer Chassis	Thermally Fused Laminate Chassis
<b>Double Height</b> 36 x 22 x 83	350	"W" Option N/A	RFT3683TW281P 5371	"G" Option N/A	"M" Option N/A
30 x 22 x 83	315	"W" Option N/A	RFT3083TW281P 5249	"G" Option N/A	"M" Option N/A
<b>Single Height</b> 36 x 22 x 71	325	"W" Option N/A	RFT3671TW281P 5009	"G" Option N/A	"M" Option N/A
30 x 22 x 71	290	"W" Option N/A	RFT3071TW281P 4889	"G" Option N/A	"M" Option N/A
		TBCO TBSW TSTV TSMV TSLV TOBW			
2 Select a finish <a href="#">View finish details</a>					
3 Select a edge <a href="#">View edge details</a>		Edge N/A			
4 Select hardware <a href="#">View hardware details</a>					

## Product features.

- Anti-tilt safety drawer lock
- Double Height adjustable shelves (3)
- Locking drawers
- Single height adjustable shelves (2)
- Soft close suspension drawer(s)
- Touch latch
- Wardrobe and shelves divided by center partition
- "W" styles - 71" H units finished top, 83" H units black painted top

### NOTES

- Unit has black back panel and is not designed for Open Plan use. Select OPB Option for Open Plan application

## Options.

### ACCESSORIES

- MTL30-S: Silver metal legs - \$315 unit
- MTL30-W: White metal legs - \$420 unit

### DOOR

- D2: Door Lock for Glass Doors - \$100 per door set
- D2-G: Door Lock for Glass doors (only when RF750AW is ordered)- \$205 per door set
- D6: Delete Doors - n/c
- RF750AW: Aluminum/White Glass - \$780 per door
- WPD3061: Designer White - \$190 per 71" door
- WPD3061: Designer White - \$220 per 83" door

### OPEN PLAN – FINISHED BACK

- OPB: "W" "G" Style - Modify Unit for Open Plan Application - \$295

### PARTITION

- MOD30: Delete center partition & Add 2 full width shelves - \$295

# Rift.

Open Bookcases  
15" Deep

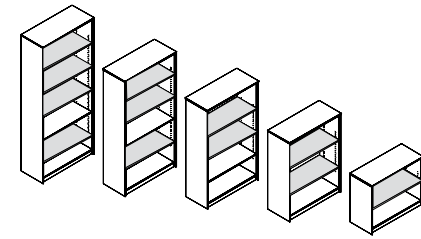

1 Select a model w" x d" x h"	weight	Standard Veneer Top	Premium Veneer Top	High Pressure Laminate Top	Thermally Fused Laminate Top
		Standard Veneer Chassis	Premium Veneer Chassis	Veneer Chassis	Thermally Fused Laminate Chassis
<b>83" Height</b> 36 x 15 x 83 30 x 15 x 83	180 160	"W" Option N/A "W" Option N/A	RFT3683BK250P RFT3083BK250P	3971 3786	"G" Option N/A "G" Option N/A
<b>71" Height</b> 36 x 15 x 71 30 x 15 x 71	160 140	"W" Option N/A "W" Option N/A	RFT3671BK250P RFT3071BK250P	3721 3385	"G" Option N/A "G" Option N/A
<b>60" Height</b> 36 x 15 x 60 30 x 15 x 60	145 125	"W" Option N/A "W" Option N/A	RFT3660BK250P RFT3060BK250P	3462 3101	"G" Option N/A "G" Option N/A
<b>48" Height</b> 36 x 15 x 48 30 x 15 x 48	125 105	"W" Option N/A "W" Option N/A	RFT3648BK250P RFT3048BK250P	3208 2723	"G" Option N/A "G" Option N/A
<b>29" Height</b> 36 x 15 x 29 30 x 15 x 29	115 90	"W" Option N/A "W" Option N/A	RFT3629BK250P RFT3029BK250P	2146 1685	"G" Option N/A "G" Option N/A
2 Select a finish <a href="#">View finish details</a>			TBCO TBSW TSTV TSMV TSLV TOBW		
	3 Select a edge <a href="#">View edge details</a>		Edge N/A		
		4 Select hardware <a href="#">View hardware details</a>		Hardware N/A	

[View statement of line](#)

## Product features.

- 3/4" Thick doweled back
- Adjustable shelves (shaded)
- Interior shelf depth 14"
- "W" styles 29", 48", 60", and 71" H units finished top, 83" H units black painted top

### NOTES

- Unit has black back panel and is not designed for Open Plan use. Select OPB Option for Open Plan application

## Options.

### ACCESSORIES

- MTL30-S: Silver metal legs - \$315 unit
- MTL30-W: White metal legs - \$420 unit

### INTERIOR CABINET LIGHTING

- LEDPK starter kit includes Infeed, 1 Puck Interior Light and the ability to daisy chain up to 6 total Puck Lights
- LEDPK: LED Puck Starter Kit - \$310
- PK: 1 LED Interior Light - \$130

### OPEN PLAN – FINISHED BACK

- OPB: "W" "G" Style - Modify Unit for Open Plan Application - \$295

### SHELF

- GS14F: Replace Standard Shelves with Glass Shelves - \$90 per shelf
- S714F: Heavy Duty Lumber 1" Shelves - \$80 per shelf

Rift.

Floating Wall Mounted Shelf  
Single Shelf

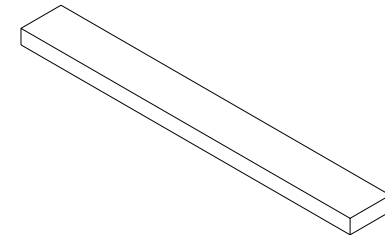

[View statement of line](#)

1 Select a model w" x d" x h"	weight	Standard Veneer Top	Premium Veneer Top	High Pressure Laminate Top	Thermally Fused Laminate Top
		Standard Veneer Chassis	Premium Veneer Chassis	Veneer Chassis	Thermally Fused Laminate Chassis
96 x 3 x 8	22	"W" Option N/A	RFT9608WH338P 790	"G" Option N/A	"M" Option N/A
90 x 3 x 8	21	"W" Option N/A	RFT9008WH338P 748	"G" Option N/A	"M" Option N/A
84 x 3 x 8	19	"W" Option N/A	RFT8408WH338P 708	"G" Option N/A	"M" Option N/A
72 x 3 x 8	16	"W" Option N/A	RFT7208WH338P 636	"G" Option N/A	"M" Option N/A
66 x 3 x 8	15	"W" Option N/A	RFT6608WH338P 596	"G" Option N/A	"M" Option N/A
60 x 3 x 8	14	"W" Option N/A	RFT6008WH338P 557	"G" Option N/A	"M" Option N/A
36 x 3 x 8	8	"W" Option N/A	RFT3608WH338P 398	"G" Option N/A	"M" Option N/A
30 x 3 x 8	7	"W" Option N/A	RFT3008WH338P 359	"G" Option N/A	"M" Option N/A
		2 Select a finish <a href="#">View finish details</a> TBCO TBSW TSTV TSMV TSLV TOBW			
		3 Select a edge <a href="#">View edge details</a> Edge N/A			
		4 Select hardware <a href="#">View hardware details</a> Hardware N/A			

Product features.

- Wall brackets included
- Wall brackets provide horizontal and vertical adjustments

NOTES

- Proper installation is critical to ensure safety from possible falling wall mounted shelves. The factory assumes no liability for damage or injury from The following: installation into non-load bearing or unlevel walls. Improper fasteners used in installation. Overloading of the wall mounted shelves resulting in failures of wall and surrounding structures, fasteners, or wall mounted shelf construction. Misuse of the wall mounted shelves for intended purposes.
- 96" shelf will support 28lbs of additional weight, 90" shelf will support 29lbs, 84" shelf will support 31lbs, 72" shelf will support 24lbs, 66" shelf will support 25lbs, 60" shelf will support 16lbs, 36" shelf will support 12lbs, 30" shelf will support 13lbs.



Rift.

Wall Hung Open Shelf  
Single Height - 19"/15"H

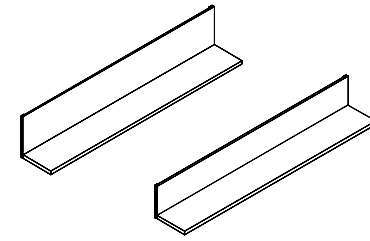

[View statement of line](#)

1 Select a model w" x d" x h"	weight	Standard Veneer Top	Premium Veneer Top	High Pressure Laminate Top	Thermally Fused Laminate Top
		Standard Veneer Chassis	Premium Veneer Chassis	Veneer Chassis	Thermally Fused Laminate Chassis
<b>19" Height</b>					
96 x 15 x 18.8	105	"W" Option N/A	RFT9619WH336P 3324	"G" Option N/A	"M" Option N/A
90 x 15 x 18.8	100	"W" Option N/A	RFT9019WH336P 3204	"G" Option N/A	"M" Option N/A
72 x 15 x 18.8	80	"W" Option N/A	RFT7219WH336P 2602	"G" Option N/A	"M" Option N/A
66 x 15 x 18.8	75	"W" Option N/A	RFT6619WH336P 2368	"G" Option N/A	"M" Option N/A
60 x 15 x 18.8	65	"W" Option N/A	RFT6019WH336P 2421	"G" Option N/A	"M" Option N/A
36 x 15 x 18.8	40	"W" Option N/A	RFT3619WH336P 1519	"G" Option N/A	"M" Option N/A
30 x 15 x 18.8	35	"W" Option N/A	RFT3019WH336P 1428	"G" Option N/A	"M" Option N/A
<b>15" Height</b>					
96 x 15 x 15.3	100	"W" Option N/A	RFT9615WH336P 3005	"G" Option N/A	"M" Option N/A
90 x 15 x 15.3	95	"W" Option N/A	RFT9015WH336P 2884	"G" Option N/A	"M" Option N/A
72 x 15 x 15.3	75	"W" Option N/A	RFT7215WH336P 2283	"G" Option N/A	"M" Option N/A
66 x 15 x 15.3	70	"W" Option N/A	RFT6615WH336P 2190	"G" Option N/A	"M" Option N/A
60 x 15 x 15.3	60	"W" Option N/A	RFT6015WH336P 2104	"G" Option N/A	"M" Option N/A
36 x 15 x 15.3	35	"W" Option N/A	RFT3615WH336P 1199	"G" Option N/A	"M" Option N/A
30 x 15 x 15.3	30	"W" Option N/A	RFT3015WH336P 1108	"G" Option N/A	"M" Option N/A
2 Select a finish <a href="#">View finish details</a>			TBCO TBSW TSTV TSMV TSLV TOBW		
3 Select a edge <a href="#">View edge details</a>			Edge N/A		
4 Select hardware <a href="#">View hardware details</a>			Hardware N/A		

Product features.

**NOTES**

- Max weight capacity 36 lbs per 1 FT width
- The DARRAN wall mounted cabinet must be hung on a weight-bearing wall. The suitability of the wall supporting the all mounted cabinet, and the installation and maintenance of the wall-mounted cabinet, is the sole responsibility of the customer. Failure to correctly install and/or exceed the loaded weight capacity of this product may cause it to fall, resulting in damage to the product, adjacent property and/or bodily injury.

Options.

**TASK LIGHT**

- LED24: 24" Slim Line Aluminum LED Task light - \$330
- LED48: 48" Slim Line Aluminum LED Task light - \$465
- LED60: 60" Slim Line Aluminum LED Task light - \$580
- DPC: Link multiple Task lights up to 30W of power wattage. Deletes 1 power drive - Deduct \$85 per Task light
- LC24: Linking Task light cable - \$25

Rift.

Wall Hung Open Shelf  
Double Height - 32"/128"H

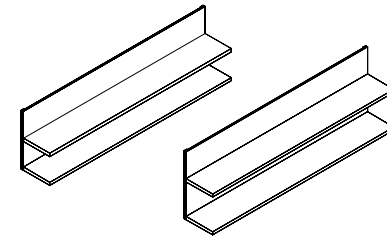

[View statement of line](#)

1 Select a model w" x d" x h"	weight	Standard Veneer Top	Premium Veneer Top	High Pressure Laminate Top	Thermally Fused Laminate Top
		Standard Veneer Chassis	Premium Veneer Chassis	Veneer Chassis	Thermally Fused Laminate Chassis
<b>32" Height</b>					
96 x 15 x 31.8	165	"W" Option N/A	RFT9632WH336P 3927	"G" Option N/A	"M" Option N/A
90 x 15 x 31.8	155	"W" Option N/A	RFT9032WH336P 3805	"G" Option N/A	"M" Option N/A
72 x 15 x 31.8	125	"W" Option N/A	RFT7232WH336P 3204	"G" Option N/A	"M" Option N/A
66 x 15 x 31.8	115	"W" Option N/A	RFT6632WH336P 2970	"G" Option N/A	"M" Option N/A
60 x 15 x 31.8	105	"W" Option N/A	RFT6032WH336P 3022	"G" Option N/A	"M" Option N/A
36 x 15 x 31.8	65	"W" Option N/A	RFT3632WH336P 1760	"G" Option N/A	"M" Option N/A
30 x 15 x 31.8	55	"W" Option N/A	RFT3032WH336P 1668	"G" Option N/A	"M" Option N/A
<b>28" Height</b>					
96 x 15 x 28.3	160	"W" Option N/A	RFT9628WH336P 3927	"G" Option N/A	"M" Option N/A
90 x 15 x 28.3	150	"W" Option N/A	RFT9028WH336P 3805	"G" Option N/A	"M" Option N/A
72 x 15 x 28.3	120	"W" Option N/A	RFT7228WH336P 3204	"G" Option N/A	"M" Option N/A
66 x 15 x 28.3	110	"W" Option N/A	RFT6628WH336P 3114	"G" Option N/A	"M" Option N/A
60 x 15 x 28.3	100	"W" Option N/A	RFT6028WH336P 3022	"G" Option N/A	"M" Option N/A
36 x 15 x 28.3	60	"W" Option N/A	RFT3628WH336P 1760	"G" Option N/A	"M" Option N/A
30 x 15 x 28.3	50	"W" Option N/A	RFT3028WH336P 1668	"G" Option N/A	"M" Option N/A
<b>2 Select a finish</b> <a href="#">View finish details</a>			TBCO TBSW TSTV TSMV TSLV TOBW		
<b>3 Select a edge</b> <a href="#">View edge details</a>			Edge N/A		
<b>4 Select hardware</b> <a href="#">View hardware details</a>			Hardware N/A		

Product features.

- Double height with fixed shelf

NOTES

- Max weight capacity 36 lbs per 1 FT width
- The DARRAN wall mounted cabinet must be hung on a weight-bearing wall. The suitability of the wall supporting the all mounted cabinet, and the installation and maintenance of the wall-mounted cabinet, is the sole responsibility of the customer. Failure to correctly install and/or exceed the loaded weight capacity of this product may cause it to fall, resulting in damage to the product, adjacent property and/or bodily injury.

Options.

TASK LIGHT

- LED24: 24" Slim Line Aluminum LED Task light - \$330
- LED48: 48" Slim Line Aluminum LED Task light - \$465
- LED60: 60" Slim Line Aluminum LED Task light - \$580
- DPC: Link multiple Task lights up to 30W of power wattage. Deletes 1 power drive - Deduct \$85 per Task light
- LC24: Linking Task light cable - \$25

# Rift.

Overhead Full Towers  
Storage With Hinged Wood Door

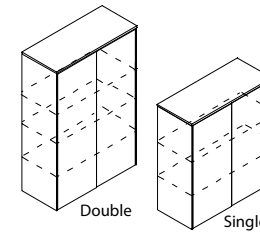

[View statement of line](#)

1 Select a model w" x d" x h"	weight	Standard Veneer Top	Premium Veneer Top	High Pressure Laminate Top	Thermally Fused Laminate Top
		Standard Veneer Chassis	Premium Veneer Chassis	Veneer Chassis	Thermally Fused Laminate Chassis
<b>Double Height</b> 36 x 15 x 54 30 x 15 x 54	130 120	"W" Option N/A "W" Option N/A	RFT3654OH383P 2889 RFT3054OH383P 2770	"G" Option N/A "G" Option N/A	"M" Option N/A "M" Option N/A
<b>Single Height</b> 36 x 15 x 41 30 x 15 x 41	120 110	"W" Option N/A "W" Option N/A	RFT3641OH383P 2649 RFT3041OH383P 2529	"G" Option N/A "G" Option N/A	"M" Option N/A "M" Option N/A
<b>2 Select a finish</b> <a href="#">View finish details</a>			TBCO TBSW TSTV TSMV TSLV TOBW		
<b>3 Select a edge</b> <a href="#">View edge details</a>			Edge N/A		
<b>4 Select hardware</b> <a href="#">View hardware details</a>			Hardware N/A		

## Product features.

- 3/4" Thick back panel
- Adjustable veneer shelves: 41" (2) and 54" (3)
- Interior shelf depth 14"
- Recessed front detailing
- Touch latch
- "W" styles 41" H units finished top, 54" H units black painted top

### NOTES

- Unit has black back panel and is not designed for Open Plan use. Select OPB Option for Open Plan application

## Options.

### DOOR

- D6: Delete Doors - n/c
- RF750AW: Accent Frame w/ White Glass - \$780 per door
- WPD3061: Designer White - \$130 per 41" door
- WPD3061: Designer White - \$160 per 54" door

### INTERIOR CABINET LIGHTING

- LEDPK starter kit includes Infeed, 1 Puck Interior Light and the ability to daisy chain up to 6 total Puck Lights
- LEDPK: LED Puck Starter Kit - \$310
- PK: 1 LED Interior Light - \$130

### OPEN PLAN – FINISHED BACK

- OPB: "W" "G" Style - Modify Unit for Open Plan Application - \$295

### SHELF

- GS14F: Replace Standard Shelves with Glass Shelves - \$90 per shelf
- S714F: Heavy Duty Lumber 1" Shelves - \$80 per shelf

# Rift.

## Vertical Half Towers Wardrobe With Door

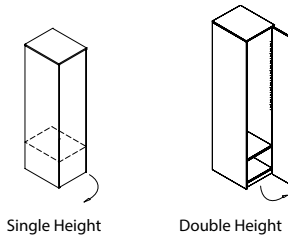

Single Height

Double Height

[View statement of line](#)

1 Select a model w" x d" x h" weight	Standard Veneer Top	Premium Veneer Top	High Pressure Laminate Top	Thermally Fused Laminate Top
	Standard Veneer Chassis	Premium Veneer Chassis	Veneer Chassis	Thermally Fused Laminate Chassis
<b>Hinged Left - Single Height</b> 18 x 22 x 71 200	"W" Option N/A	RFT1871TW877P 2481	"G" Option N/A	"M" Option N/A
<b>Hinged Left - Double Height</b> 18 x 22 x 83 215	"W" Option N/A	RFT1883TW877P 2963	"G" Option N/A	"M" Option N/A
<b>Hinged Right - Single Height</b> 18 x 22 x 71 200	"W" Option N/A	RFT1871TW878P 2481	"G" Option N/A	"M" Option N/A
<b>Hinged Right - Double Height</b> 18 x 22 x 83 215	"W" Option N/A	RFT1883TW878P 2963	"G" Option N/A	"M" Option N/A
2 Select a finish <a href="#">View finish details</a>		TBCO		
		TBSW		
		TSTV		
		TSMV		
		TSLV		
	TOBW			
3 Select a edge <a href="#">View edge details</a>		Edge		
		N/A		
4 Select hardware <a href="#">View hardware details</a>		Hardware		
		N/A		

## Product features.

- 3/4" Thick back panel
- 71" H - Top is finished, 83" H - Top is painted black
- Adjustable shelves (3)/fixed shelf (1) 71"
- Adjustable shelves (4)/fixed shelf (1) 83"
- Coat rod and hook
- Recessed door detailing
- Touch latch

### NOTES

- Unit has black back panel and is not designed for Open Plan use. Select OPB Option for Open Plan application

## Options.

### ACCESSORIES

- MTL30-S: Silver metal legs - \$315 unit
- MTL30-W: White metal legs - \$420 unit

### DOOR

- D2: Door Lock - \$100 per door
- D2-G: Door Lock for Glass doors - \$205 per door
- D6: Delete Doors - n/c
- RF115AW: Full Height Aluminum/White Glass Doors - \$1200 per door
- WPD3061: Designer White - \$190 per 71" door
- WPD3061: Designer White - \$220 per 83" door

### OPEN PLAN – FINISHED BACK

- OPB: "W" "G" Style - Modify Unit for Open Plan Application - \$295

### SHELF

- GS14H: Replace Standard Shelves with Glass Shelves - \$70 per shelf

Rift.

Vertical Full Towers  
Wardrobe Storage With Double Door

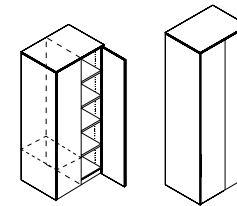

Single Height Double Height

[View statement of line](#)

1 Select a model w" x d" x h"	weight	Standard Veneer Top Standard Veneer Chassis	Premium Veneer Top Premium Veneer Chassis	High Pressure Laminate Top Veneer Chassis	Thermally Fused Laminate Top Thermally Fused Laminate Chassis
<b>Double Height</b> 36 x 22 x 83 30 x 22 x 83	340 305	"W" Option N/A "W" Option N/A	RFT3683TW275P 5310 RFT3083TW275P 5191	"G" Option N/A "G" Option N/A	"M" Option N/A "M" Option N/A
<b>Single Height</b> 36 x 22 x 71 30 x 22 x 71	325 290	"W" Option N/A "W" Option N/A	RFT3671TW275P 4949 RFT3071TW275P 4829	"G" Option N/A "G" Option N/A	"M" Option N/A "M" Option N/A
<b>2 Select a finish</b> <a href="#">View finish details</a>			TBCO TBSW TSTV TSMV TSLV TOBW		
<b>3 Select a edge</b> <a href="#">View edge details</a>			Edge N/A		
<b>4 Select hardware</b> <a href="#">View hardware details</a>			Hardware N/A		

Product features.

- 83" Double Height - 1 fixed / 4 adj.
- 71" Single Height 1 fixed, 3 adj.
- Center partition
- Recessed door detailing
- Single height adjustable shelves (3)/fixed shelf (1)
- Touch latch
- Wardrobe w/ coat rod & hook (on Left)
- "W" styles - 71" H units finished top, 83" H units black painted top

NOTES

- Unit has black back panel and is not designed for Open Plan use. Select OPB Option for Open Plan application

Options.

ACCESSORIES

- MTL30-S: Silver metal legs - \$315 unit
- MTL30-W: White metal legs - \$420 unit

DOOR

- D2: Door Lock - \$100 per door
- D6: Delete Doors. Must specify door (R or L) - n/c
- RF115AW: Full Height Aluminum/White Glass Doors - \$1200 per door
- WPD3061: Designer White - \$190 per 71" door
- WPD3061: Designer White - \$220 per 83" door

OPEN PLAN – FINISHED BACK

- OPB: "W" "G" Style - Modify Unit for Open Plan Application - \$295

Rift.

Vertical Full Towers  
File-File/Storage/Full Wardrobe

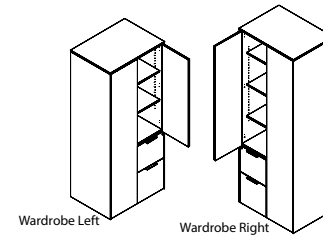

[View statement of line](#)

1 Select a model w" x d" x h"	weight	Standard Veneer Top	Premium Veneer Top	High Pressure Laminate Top	Thermally Fused Laminate Top
		Standard Veneer Chassis	Premium Veneer Chassis	Veneer Chassis	Thermally Fused Laminate Chassis
<b>Wardrobe Left - Single Height</b>					
36 x 22 x 71	305	"W" Option N/A	RFT3671TW273P 4937	"G" Option N/A	"M" Option N/A
30 x 22 x 71	305	"W" Option N/A	RFT3071TW273P 4816	"G" Option N/A	"M" Option N/A
<b>Wardrobe Left - Double Height</b>					
36 x 22 x 83	340	"W" Option N/A	RFT3683TW273P 5298	"G" Option N/A	"M" Option N/A
30 x 22 x 83	340	"W" Option N/A	RFT3083TW273P 5177	"G" Option N/A	"M" Option N/A
<b>Wardrobe Right - Single Height</b>					
36 x 22 x 71	305	"W" Option N/A	RFT3671TW274P 4937	"G" Option N/A	"M" Option N/A
30 x 22 x 71	305	"W" Option N/A	RFT3071TW274P 4816	"G" Option N/A	"M" Option N/A
<b>Wardrobe Right - Double Height</b>					
36 x 22 x 83	340	"W" Option N/A	RFT3683TW274P 5298	"G" Option N/A	"M" Option N/A
30 x 22 x 83	340	"W" Option N/A	RFT3083TW274P 5177	"G" Option N/A	"M" Option N/A
2 Select a finish <a href="#">View finish details</a>		TBCO TBSW TSTV TSMV TSLV TOBW			
3 Select a edge <a href="#">View edge details</a>		Edge N/A			
4 Select hardware <a href="#">View hardware details</a>					

Product features.

- Center partition
- Double Height adjustable shelves (3)
- Recessed door detailing
- Single height adjustable shelves (2)
- Soft close suspension drawer(s)
- Touch latch
- Wardrobe w/ coat rod & hook
- "W" styles - 71" H units finished top, 83" H units black painted top

NOTES

- Unit has black back panel and is not designed for Open Plan use. Select OPB Option for Open Plan application

Options.

ACCESSORIES

- MTL30-S: Silver metal legs - \$315 unit
- MTL30-W: White metal legs - \$420 unit

DOOR

- D2: Door Lock - \$100 per door
- D2-G: Door Lock for Glass Doors - \$205 per door set
- D6: Delete Doors - n/c
- RF115AW: Full Height Aluminum/White Glass Doors - \$1200 per door
- RF750AW: Accent Frame w/ White Glass Half Height - \$780 per door
- WPD3061: Designer White - \$190 per 71" door
- WPD3061: Designer White - \$220 per 83" door

DRAWER

- P6: Modify File/File to Box/Box/File - \$55 per pedestal

OPEN PLAN – FINISHED BACK



- OPB: "W" "G" Style - Modify Unit for Open Plan Application - \$295

# Rift.

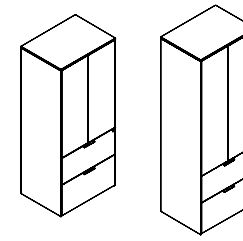
Vertical Full Towers  
2 Lateral File/Storage Double Door



[View statement of line](#)

1 Select a model w" x d" x h"	weight	Standard Veneer Top	Premium Veneer Top	High Pressure Laminate Top	Thermally Fused Laminate Top
		Standard Veneer Chassis	Premium Veneer Chassis	Veneer Chassis	Thermally Fused Laminate Chassis
<b>Double Height</b> 36 x 22 x 83 30 x 22 x 83	350 315	"W" Option N/A "W" Option N/A	RFT3683TW281P 5371 RFT3083TW281P 5249	"G" Option N/A "G" Option N/A	"M" Option N/A "M" Option N/A
<b>Single Height</b> 36 x 22 x 71 30 x 22 x 71	325 290	"W" Option N/A "W" Option N/A	RFT3671TW281P 5009 RFT3071TW281P 4889	"G" Option N/A "G" Option N/A	"M" Option N/A "M" Option N/A
2 Select a finish <a href="#">View finish details</a>			TBCO TBSW TSTV TSMV TSLV TOBW		
3 Select a edge <a href="#">View edge details</a>			Edge N/A		
4 Select hardware <a href="#">View hardware details</a>			 		

## Product features.

- Anti-tilt safety drawer lock
- Double Height adjustable shelves (3)
- Locking drawers
- Single height adjustable shelves (2)
- Soft close suspension drawer(s)
- Touch latch
- Wardrobe and shelves divided by center partition
- "W" styles - 71" H units finished top, 83" H units black painted top

### NOTES

- Unit has black back panel and is not designed for Open Plan use. Select OPB Option for Open Plan application

## Options.

### ACCESSORIES

- MTL30-S: Silver metal legs - \$315 unit
- MTL30-W: White metal legs - \$420 unit

### DOOR

- D2: Door Lock for Glass Doors - \$100 per door set
- D2-G: Door Lock for Glass doors (only when RF750AW is ordered)- \$205 per door set
- D6: Delete Doors - n/c
- RF750AW: Aluminum/White Glass - \$780 per door
- WPD3061: Designer White - \$190 per 71" door
- WPD3061: Designer White - \$220 per 83" door

### OPEN PLAN – FINISHED BACK

- OPB: "W" "G" Style - Modify Unit for Open Plan Application - \$295

### PARTITION

- MOD30: Delete center partition & Add 2 full width shelves - \$295

# Rift.

Open Bookcases  
15" Deep

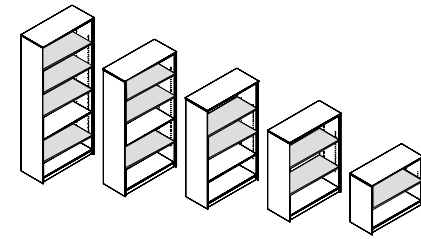

1 Select a model w" x d" x h"	weight	Standard Veneer Top	Premium Veneer Top	High Pressure Laminate Top	Thermally Fused Laminate Top
		Standard Veneer Chassis	Premium Veneer Chassis	Veneer Chassis	Thermally Fused Laminate Chassis
<b>83" Height</b> 36 x 15 x 83 30 x 15 x 83	180 160	"W" Option N/A "W" Option N/A	RFT3683BK250P 3971 RFT3083BK250P 3786	"G" Option N/A "G" Option N/A	"M" Option N/A "M" Option N/A
<b>71" Height</b> 36 x 15 x 71 30 x 15 x 71	160 140	"W" Option N/A "W" Option N/A	RFT3671BK250P 3721 RFT3071BK250P 3385	"G" Option N/A "G" Option N/A	"M" Option N/A "M" Option N/A
<b>60" Height</b> 36 x 15 x 60 30 x 15 x 60	145 125	"W" Option N/A "W" Option N/A	RFT3660BK250P 3462 RFT3060BK250P 3101	"G" Option N/A "G" Option N/A	"M" Option N/A "M" Option N/A
<b>48" Height</b> 36 x 15 x 48 30 x 15 x 48	125 105	"W" Option N/A "W" Option N/A	RFT3648BK250P 3208 RFT3048BK250P 2723	"G" Option N/A "G" Option N/A	"M" Option N/A "M" Option N/A
<b>29" Height</b> 36 x 15 x 29 30 x 15 x 29	115 90	"W" Option N/A "W" Option N/A	RFT3629BK250P 2146 RFT3029BK250P 1685	"G" Option N/A "G" Option N/A	"M" Option N/A "M" Option N/A
<b>2 Select a finish</b> <i>View finish details</i>			TBCO TBSW TSTV TSMV TSLV TOBW		
<b>3 Select a edge</b> <i>View edge details</i>			Edge N/A		
<b>4 Select hardware</b> <i>View hardware details</i>			Hardware N/A		

[View statement of line](#)

## Product features.

- 3/4" Thick doweled back
- Adjustable shelves (shaded)
- Interior shelf depth 14"
- "W" styles 29", 48", 60", and 71" H units finished top, 83" H units black painted top

### NOTES

- Unit has black back panel and is not designed for Open Plan use. Select OPB Option for Open Plan application

## Options.

### ACCESSORIES

- MTL30-S: Silver metal legs - \$315 unit
- MTL30-W: White metal legs - \$420 unit

### INTERIOR CABINET LIGHTING

- LEDPK starter kit includes Infeed, 1 Puck Interior Light and the ability to daisy chain up to 6 total Puck Lights
- LEDPK: LED Puck Starter Kit - \$310
- PK: 1 LED Interior Light - \$130

### OPEN PLAN – FINISHED BACK

- OPB: "W" "G" Style - Modify Unit for Open Plan Application - \$295

### SHELF

- GS14F: Replace Standard Shelves with Glass Shelves - \$90 per shelf
- S714F: Heavy Duty Lumber 1" Shelves - \$80 per shelf



## Rift options.

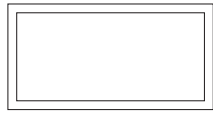

RECTANGLE INLAY

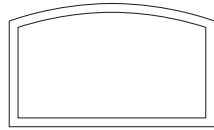

CURVED INLAY

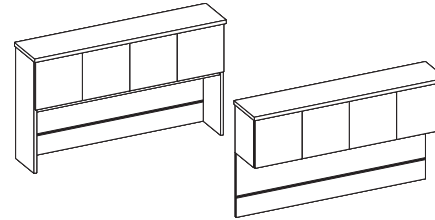

**SPECIALTY VENEER ACCENTS**  
*rectangle inlay - ebony hardwood inlay detail*

Style Number	List Price
T10SA	895

### Specifications

- 3/16" x 3/16" thick hardwood ebony inlay is handfitted and glued into routed top and sanded flush with surface
- Inlay is finished over with all finish steps

Notes  
 - Ebony inlay not recommended in: Koko Cherry

**SPECIALTY VENEER ACCENTS**  
*bowfront inlay - ebony hardwood inlay detail*

Style Number	List Price
T11SA	995

### Specifications

- 3/16" x 3/16" thick hardwood ebony inlay is handfitted and glued into routed top and sanded flush with surface
- Inlay is finished over with all finish steps

Notes  
 - Ebony inlay not recommended in: Koko Cherry

**TOOL CHANNEL ACCESSORIES**  
*recessed aluminum tool channel*

Style Number	List Price
ATB02	5 per 1"W

### Specifications

- Anodized aluminum finish
- Fully recessed
- Finish matches anodized aluminum accessories
- Can be specified with fabric tack surface mounted above channel

Notes  
 - If using tool channel with wallhung overhead, a veneer panel must be specified.

**TOOL CHANNEL ACCESSORIES**  
*file holder*

Style Number	List Price
ATB37	105

### Specifications

- For Console/Wall Hung Back Panels With Optional Tool Bar
- 18 Gauge Steel - Stamp Formed
- Silver Powdercoat Finish

Rift options.



TOOL CHANNEL ACCESSORIES  
*iphone holder*

Style Number	List Price
ATB31	120

**Specifications**

- For Console/Wall Hung Back Panels With Optional Tool Bar
- 18 Gauge Steel - Stamp Formed
- Silver Powdercoat Finish
- 5" x 3 -3/4"W
- Non-slip Neoprene pad



TOOL CHANNEL ACCESSORIES  
*large shelf*

Style Number	List Price
ATB35	125

**Specifications**

- 12"W x 10"D



TOOL CHANNEL ACCESSORIES  
*pencil pen holder*

Style Number	List Price
ATB38	115

**Specifications**

- For Console/Wall Hung Back Panels With Optional Tool Bar
- 18 Gauge Steel - Stamp Formed
- Silver Powdercoat Finish
- 5"H x 4"W x 4"D



TOOL CHANNEL ACCESSORIES  
*small shelf*

Style Number	List Price
ATB36	110

**Specifications**

- 12"W x 6 -3/4"D

## Rift options.

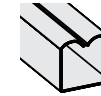
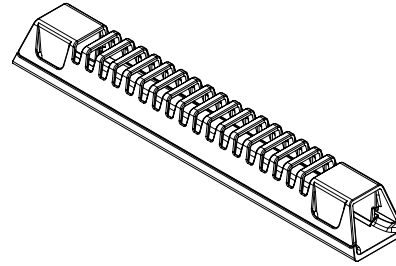
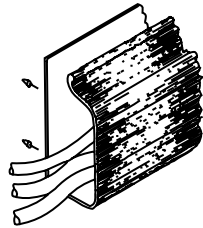

### TOOL CHANNEL ACCESSORIES *tablet holder*

Style Number	List Price
ATB30	135

### WIRE MANAGEMENT *horizontal j-channel wire management raceway*

Style Number	List Price
W1	75 Per 4' section

### WIRE MANAGEMENT *horizontal wire management raceway*

Style Number	List Price
W21	30

### WIRE MANAGEMENT *horizontal u-channel wire management raceway*

Style Number	List Price
W2A	75 Per 4' section

## Specifications

- For Console/Wall Hung Back Panels With Optional Tool Bar
- 18 Gauge Steel - Stamp Formed
- Silver Powdercoat Finish
- 10" x 8"W
- Non-slip Neoprene pad

## Specifications

- 4' section for field installation.
- The "J" shape black thermoplastic wire raceway may be added to specified worksurface tops to provide concealed channeling of wires to and from worksurface grommets. For use in open kneespace areas, raceway is attachable to top of back panel with pan head screws. Interior dimensions are 1" x 1- 1/2" providing ample storage for multiple wires and excess cable. Front of raceway flexes out for easy cord insertion.

#### Notes

- Units w/ Wire Channel Standard.
- Field Installation

## Specifications

- 10"W x 1.5"D x 1.25"H
- Grey Wire Manager (10.5")
- Power and data cables can be discretely housed and managed with the W21 Gray Wire Manager. This can be mounted in any location to metal frame or underside of conference tables and runs cables through a 1" channel from power module to hollow steel legs. This keeps cables organized under the table top. Release clips make it simple to snap on and off the Wire Manager for easy organization and access after attached to the table

#### Notes

- Field installed

## Specifications

- 4' section for field installation.

#### Notes

- Units w/ Wire Channel Standard.
- Field Installation

Rift options.

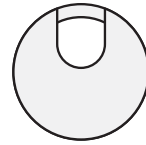
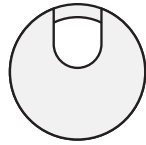

WIRE MANAGEMENT  
*coil wire manager*

Style Number	List Price
W18	150

Specifications

- Weighted Base, Table attachment plate
- 39- 1/2" Length
- Black

- Notes
- Location

WIRE MANAGEMENT  
*standard location grommets - factory installed*

Style Number	List Price
Standard Location Grommet	
Black	
TM30	45
Silver	
TM31	45
Antique Brass	
TM33	45
White	
TM34	45

Specifications

- 1 -5/8" Metal Grommet

- Notes
- \*Units w/ Grommets Standard Are Noted Under Standard Features. Grommets Match Pull Finish - Standard (Unless Specified Otherwise)

WIRE MANAGEMENT  
*non-standard location grommets - factory installed*

Style Number	List Price
Non-Standard Location Grommet	
Black	
TM30 -NS	90
Silver	
TM31 -NS	90
Antique Brass	
TM33 -NS	90
White	
TM34 -NS	90

Specifications

- 1 -5/8" Metal Grommet

- Notes
- \*Units w/ Grommets Standard Are Noted Under Standard Features. Grommets Match Pull Finish - Standard (Unless Specified Otherwise)

WIRE MANAGEMENT  
*black plastic vertical surface grommets - factory installed*

Style Number	List Price
Standard Location Grommet	
TM50-C	45
Non-Standard Location Grommet	
TM50-NS	90

Specifications

- 2 " Black Plastic Grommet

- Notes
- Standard Location is Bottom Center

Rift options.



COMPUTER SUPPORT  
*single monitor arm*

Style Number	List Price
MA1	265

Specifications

- Available in black or silver
- Desk clamp and mounting included
- Easy assembly and flexibility
- Elastic painting process for a durable and beautiful finish
- Gas spring tension adjustment for counter-balance height adjustment for monitors 1-8 KG
- Gas spring tested to 50,000 repetitions
- Hidden cable management



COMPUTER SUPPORT  
*double monitor arm*

Style Number	List Price
MA2	430

Specifications

- Available in black or silver
- Desk clamp and mounting included
- Easy assembly and flexibility
- Elastic painting process for a durable and beautiful finish
- Gas spring tension adjustment for counter-balance height adjustment for monitors 1-8 KG
- Gas spring tested to 50,000 repetitions
- Hidden cable management



COMPUTER SUPPORT  
*triple monitor arm*

Style Number	List Price
MA3	505

Specifications

- Available in black or silver
- Desk clamp and mounting included
- Easy assembly and flexibility
- Elastic painting process for a durable and beautiful finish
- Gas spring tension adjustment for counter-balance height adjustment for monitors 1-8 KG
- Gas spring tested to 50,000 repetitions
- Hidden cable management



COMPUTER SUPPORT  
*quadruple monitor arm*

Style Number	List Price
MA4	675

Specifications

- Available in black
- Desk clamp and mounting included
- Easy assembly and flexibility
- Elastic painting process for a durable and beautiful finish
- Gas spring tension adjustment for counter-balance height adjustment for monitors 1-8 KG
- Gas spring tested to 50,000 repetitions
- Hidden cable management

## Rift options.

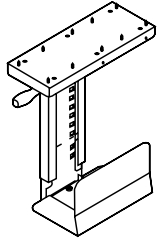

COMPUTER SUPPORT  
*cpu retractable cradle*

Style Number	List Price
K18	195

### Specifications

- Black Metal CPU Carriage
- Full 360° swivel capability allows easy access to rear of CPU for cables / wires
- Track allows 8- 1/2" extension
- Width Adjustment 5-1/2" to 9-1/4"
- Height adjustment 14- 5/8" to 20- 1/2"
- Black epoxy finish

- Notes
- Factory Installed

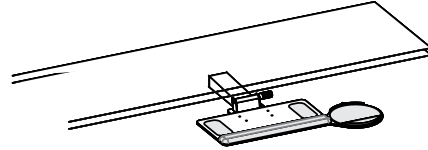

COMPUTER SUPPORT  
*articulating keyboard tray*

Style Number	List Price
Factory Installed K28	375
Field Installed K28F	395

### Specifications

- Adjusts effortlessly - A simple one-handed motion allows the keyboard to be repositioned instantly, without the use of locks or levers
- Encourages low-risk postures - Maximizes adjustability within a safe operating range.
- Will last a lifetime - Exceeds all applicable BIFMA Standards and comes with a lifetime guarantee.

- Notes
- Available on: Freestanding Desk
  - Factory Installed (standard)
  - FIELD INSTALL - \$395



DOOR MODIFICATIONS  
*soft close door hinge*

Style Number	List Price
D9SC	15 Per door

### Specifications

- Snap onto standard door hinge
- Requires (2) per door
- Max door height 43"
- Factory installed where specified
- Individually shipped for field installation

- Notes
- Specify Each Item To Have Slow Close Feature

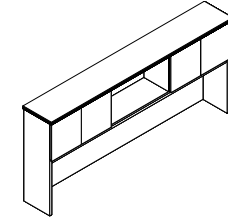

DOOR MODIFICATIONS  
*delete doors*

Style Number	List Price
D6	N/C

### Specifications

- Standard Door overheads and cabinets can have door deleted for open access. Modification of hinge rails and structural components are made face ready.

Rift options.

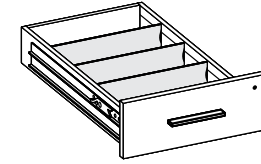
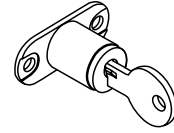
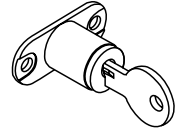
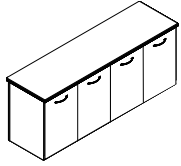

**DOOR MODIFICATIONS**  
*delete doors/replace black laminate shelf w/ finished shelf*

Style Number	List Price
D6A	N/C

**Specifications**

- Delete doors and replace black laminate shelf with finished shelf
- Available on: All Storage "W"/"G" Style Credenzas.

**DOOR MODIFICATIONS**  
*panel door lock*

Style Number	List Price
D2	95 Per door set

**Specifications**

- Door Locks - 1 Door w/ Lock, Other Door w/ Catch Latch
- Contact Customer Service regarding limited lock locations and keying.

Notes  
 - Available on: Panel Doors, Wood Frame Doors, and Silverluma doors

**DOOR MODIFICATIONS**  
*glass door lock*

Style Number	List Price
D2-G	195 Per door set

**Specifications**

- Door Locks - 1 Door w/ Lock, Other Door w/ Catch Latch
- Contact Customer Service regarding limited lock locations and keying.

Notes  
 - Available on: Glass Doors

**DRAWER OPTIONS**  
*box drawer accessories*

Style Number	List Price
Wood Drawer Dividers w/ Clips K-DIV	SET OF 3 - 30
Single Tray - Utility Tray K-Sut	30 each

**Specifications**

- K-DIV Extra Wood Drawer Dividers with Clips, Top Box drawers standard with 1 divider
- K-SUT Single Tray - Utility Tray, Specify Legal or Letter drawer width

## Rift options.

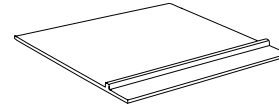
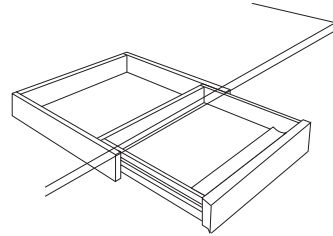
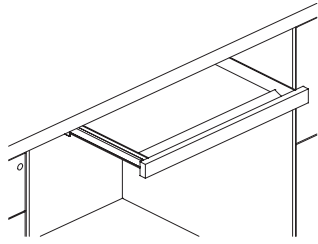

### DRAWER OPTIONS *center drawer*

Style Number	List Price
Factory Installed K1R	275
Field Installed K1RF	275

### Specifications

- Center Drawer - Factory Installed, Center Drawer - Field Installed

### DRAWER OPTIONS *center drawer with skirt*

Style Number	List Price
Factory Installed K2R	375
Field Installed K2RF	375
Add Skirt Option K2R-SK	475

### Specifications

- Center Drawer - Factory Installed, Center Drawer - Field Installed

### DRAWER OPTIONS - BOTTOM COVER *felt bottom center drawer insert liner*

Style Number	List Price
K3	95

### Specifications

- Inserts into center drawer and features divider for open pen and pencil storage. Removable for easy cleaning.
- Adds a luxurious touch to center drawers.
- Color: Dark Brown Coal

### GLASSBOARD ACCESSORIES *glassboard accessory kit*

Style Number	List Price
GBKIT	275

### Specifications

- 8 Earth magnets, 1 magnetic marker cup holder and 1 magnetic dry eraser



## Rift options.

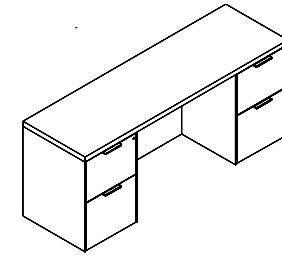
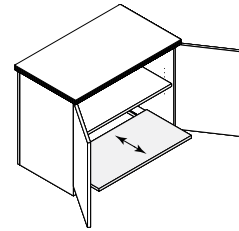
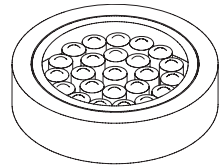
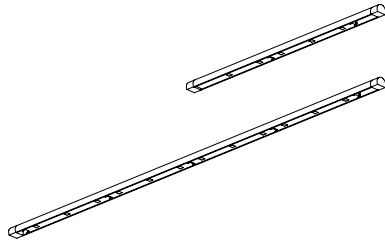

### LIGHTING

*slim line aluminum led task light*

Style Number	List Price
24" Task light LED24	315
48" Task light LED48	445
60" Task light LED60	555
Linking Package DPC	Deduct 85 per task light

### Specifications

- Anodized aluminum finish
- Tilting beam allows adjustability
- Switch with dimming control
- 50,000 hour life
- 12V power drive standard with each task light 30 watt max

#### Notes

- Link multiple tasklights up to 30W of power wattage.
- Deletes 1 power drive

### LIGHTING

*led interior cabinet puck light*

Style Number	List Price
Starter Kit LEDPK	295
1 LED Interior Puck Light PK	125

### Specifications

- Starter kit includes Infeed, 1 Puck Interior Light and the ability to daisy chain up to 6 total Puck Lights
- (1) LED Puck Light with 30W power drive and switch
- Recessed fixture
- 12V linking cord 98"L
- Silver finish
- 50,000 hour life
- 2 watt per light

#### Notes

- Available on: Overhead/Tower Units with glass doors or no doors
- Power drive included, Light only

### PEDESTAL MODIFICATIONS

*black laminate printer pullout bottom shelf*

Style Number	List Price
PPOS	214

### Specifications

- Black Laminate pullout shelf on suspension
- Black grommet
- Adjustable Shelf

### PEDESTAL MODIFICATIONS

*add tech veneer kneespace cabinets - no base*

Style Number	List Price
Add Box/Box/File or File/File P40T	1100
Add Lateral File 29" W P41T	1210
Add Multi-File - 31"W P42T	1320
Add Storage With Doors 29"W P43T	1210
Add CPU /Printer Cabinet - Open P44T	1210

### Specifications

- Multi-file specify Box/Box Left or Right

#### Notes

- Add additional Standard Cabinets To Kneespace Area.

## Rift options.

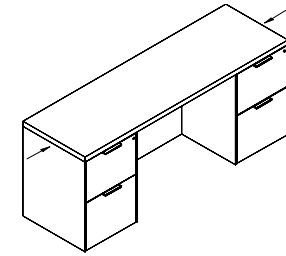
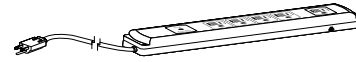
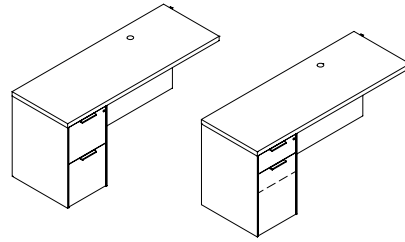
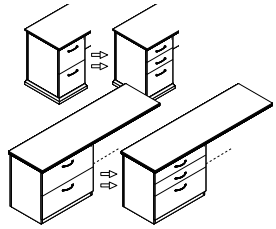

### PEDESTAL MODIFICATIONS *modify drawer configurations*

Style Number	List Price
File/File to Box/Box/File P6	50 Per ped
Box/Box/File to File/File P6	50 Per ped
Lateral File to 2 Box Drawers P8	95 Per ped

### Specifications

- Modify File/File To Box/Box/File - Any Unit

### PEDESTAL MODIFICATIONS *modify drawer configurations*

Style Number	List Price
File/File to Box/Box/File P6H	95 Per ped
Lateral File to 2 Box Drawers P8	95 Per ped

### Specifications

- Modify File/File To Box/Hidden Box/File - Any Unit

### POWER / DATA *power supply cordset*

Style Number	List Price
PD717	95

### Specifications

- SIZE: 10.75"L x 2.0"W x 1.06"H
- (5) Outlets w/ 10' cord
- Surge suppression (720 Joules)
- 15 Amp breaker
- Available on: Vertical Panels, Cabinet Interiors, and under tops

### PRODUCT MODIFICATIONS *modify width - open kneespace*

Style Number	List Price
MOD-1	125

### Specifications

- Modify width down on any unit with an open kneespace: desk, workstation credenza, bridge, return

## Rift options.

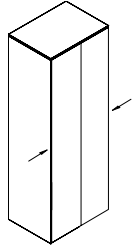

PRODUCT MODIFICATIONS  
*modify width - open/closed storage*

Style Number	List Price
MOD-2	250

### Specifications

- Modify width down on any unit with open or closed storage section: overheads, wall hung units, storage credenzas, towers

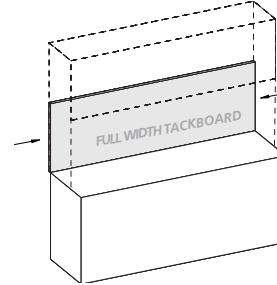

PRODUCT MODIFICATIONS  
*modify width - tackboard, slat wall, veneer panel, or a glassboard*

Style Number	List Price
MOD-4	50

### Specifications

- Modify width down on tackboard, slat wall, veneer panel, or a overhead glassboard

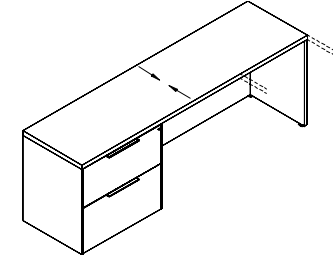

PRODUCT MODIFICATIONS  
*modify depth - decrease depth*

Style Number	List Price
MOD-5	125

### Specifications

- Modify depth down (minimum depth for a unit with drawers is 21" D)

Notes  
 - Ex. 24" to 21", 30" to 24", and 36" to 30"

## Rift options.

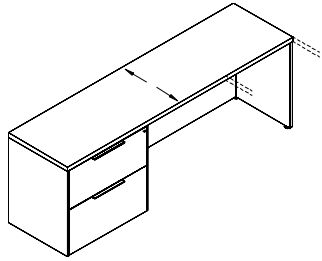

### PRODUCT MODIFICATIONS *modify depth - increase depth*

Style Number	List Price
MOD-6	Add 10%

### Specifications

- Increase depth by no more than 6"

#### Notes

- Ex. 24" to 30", 30" to 36", and 36" to 42"
- Add 10% to the unit you want to increase the depth of by no more than 6"

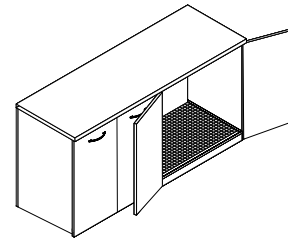

### PRODUCT MODIFICATIONS *modify height*

Style Number	List Price
MOD-7	Contact for pricing

### Specifications

- Modify height of a unit

### REFRIGERATOR MODIFICATION *refrigerator cabinet modification*

Style Number	List Price
REF01	195

### Specifications

- Open back cutout for venting
- Moisture sponge mat
- Contaminate ledge
- Contact customer service for maximum refrigerator size (Changes based on unit).
- Available on: 36" and 42" Storage Credenzas

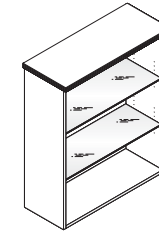

### SHELF MODIFICATIONS *glass shelves - tempered full width 26" - 35"*

Style Number	List Price
26"W - 35"W x 14"D Shelf GS14F	85

### Specifications

- Glass Shelves Replace Wood Shelf In Open Or Glass Door Cabinet. Also Order Interior Cabinet Lighting.

Rift options.

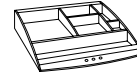
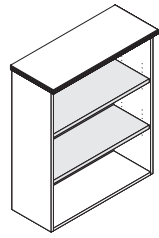
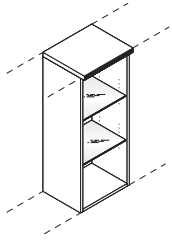

SHELF MODIFICATIONS  
tempered glass shelves for half cabinet 17- 1/2" widths

Style Number	List Price
14-1/2"W - 17- 1/2"W x 14"D Shelf GS14H	65 ea

Specifications

- Glass Shelves Replace Wood Shelf In Open Or Glass Door Cabinet. Also Order Interior Cabinet Lighting.

Notes

- Replace only adjustable shelves between cabinet light and fixed lower wood shelf.

SHELF MODIFICATIONS  
heavy duty solid wood bookcase replacement shelves

Style Number	List Price
1" Wood Shelf 14" Deep S714F	75 ea
1" Wood Shelf 24" Deep S714FX	150 each

Specifications

- 1" Solid Lumber Core Shelves Replace Standard 3/4" Plywood Adjustable And Fixed Shelves

SLAT WALL ACCESSORIES  
slat wall accessory tray

Style Number	List Price
SWA9	45

Specifications

- Specify Black Or Matte Silver

## power & data options.

Aircharge wireless charging grommet

Style Number	List Price
 ACWG WIRELESS GROMMET	\$195

## Specifications

- › When used with GROVE Tables an additional \$350 LIST will apply for the special cutout required.
- › AirCharge offers a convenient way to charge any Qi compatible smartphone or device without the need to carry charging cables or find an available power outlet.
- › The Aircharge is powered by the latest Qi compliant IC offering reliable and efficient wireless charging in a convenient 3" grommet hub. Simply place your phone on the Aircharge and an LED will confirm pairing and begin wireless charging.
- › Recess: Efficient space conservation and quick access
- › Input: DC 5V (with included AC power adapter), DC 9V, 1.67A (with optional QC 2.0 power adapter)
- › Output: 5 watts Max. with DC 5V, 2A power adapter, 10 watts Max. with QC 2.0 power adapter
- › Qi V1.2 compliant IC
- › Charging distance: 6mm Max.

Available: All DARRAN collections



## power & data options.

Cove power unit - non-linking

Style Number	List Price
 PD-COVE PLUG	\$550
Non-linking version	

### Specifications

- › Size 5.75" L x 2.5" W
- › (2) 15 Amp Receptacles and (2) USB charging ports
- › Surface Mount
- › 108" Cord
- › Standard Silver Finish, Available in White or Black Finish upon request
- › ETL Listed

Available: All DARRAN collections



## power & data options.

Cove corded series

### Style Number



PD-COVE-PKO

### List Price

\$800

## Specifications

- › Size 9.5" L x 2.5" W x 3.18" D
- › When used with GROVE Tables an additional \$350 LIST will apply for the special cutout required.
- › (2) Power Receptacles, (2) 2.1 Amp USB charging ports and (1) Telecom Plate Knockout
- › Surface Mount
- › 108" Cord
- › Standard Silver Finish, Available in White or Black Finish upon request
- › ETL Listed

Available: All DARRAN collections

### Telecom Plates

RJ45 (1)	\$35
RJ45 (2)	\$70
RJ45 (3)	\$105
USB (1)	\$70
USB (2)	\$140
RJ11/RJ45	\$70
RJ45/USB	\$105
RJ45/HDMI	\$190
HDMI/DVI	\$325
HDMI/USB	\$205
HDMI/VGA	\$240
VGA/MINI-STEREO	\$155
VGA/USB	\$175

This pod can have up to 1 total plates.

\*All telecom connectors sold separately.





## power & data options.

### Soba wire manager

Style Number	List Price
STARTER UNITS	
SCDW	\$200
White wire manager	
SCDB	\$200
Black wire manager	

## Specifications

- › Dimensions: 9ft x 9in x 3.15in
- › Zips up, bundles and routes loose, messy cables into a single tube
- › Routes and guides cables behind desks, TVs, and anywhere cables tend to get messy
- › Accommodates large or small cables, up to three cables at once
- › Support channels, used to route cables, include powerful adhesive backing which allows easy attachment to surfaces.

Available: All DARRAN collections



## power & data options.

VILLA Power unit - non-linking

Style Number	List Price
 VIL-C PLUG	\$515
Non-Linking	

### Specifications

- › Size: Top Grommet 5.68" L X 3.39"W; Under Top 12"L x 3.13"W x 3.08"D
- › (2) Power receptacles; (2) USB charging ports and (1) Knockouts for RJ45 Data Ports
- › Surface Mount
- › 72" Cord (Longer cord available, contact Customer Service)
- › Standard Silver Finish, Black Finish available upon request
- › UL or ETL Certified

Available: All DARRAN collections, excludes Grove

RJ45 Knockout	
RJ45 (1)	\$35

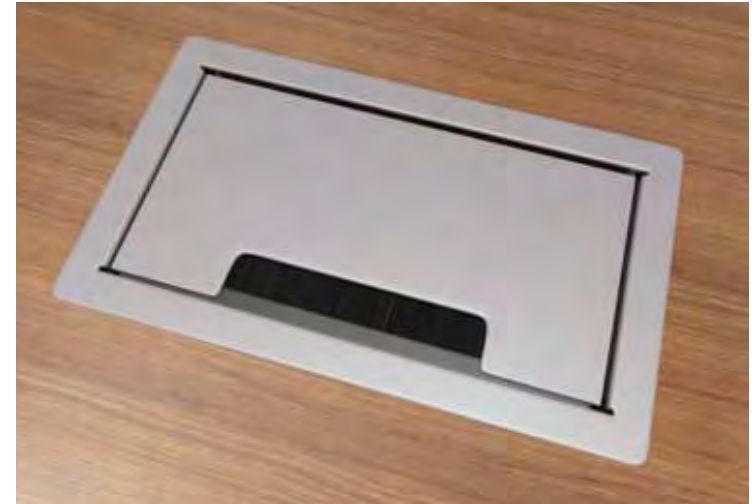

# Roki price list



## Roki Table of contents

Statement of Line	
Fabric seat & leather program.....	1
Finishes.....	4
Metal finishes I Specifications.....	5
Cocktail Tables.....	6
Conference Tables.....	8
Pedestals.....	16
Guest Chair .....	18
Stools .....	20

# Roki statement of line

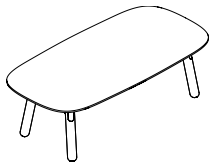

PAGE 6  
Cocktail Table

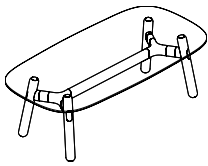

PAGE 7  
Cocktail Table

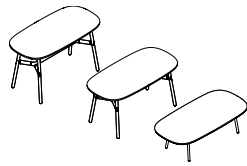

PAGE 8  
Conference Table

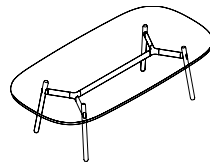

PAGE 9  
Conference Table

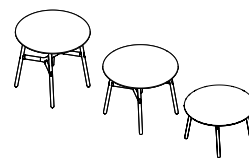

PAGE 10  
Conference Table

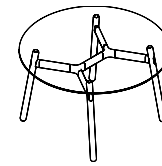

PAGE 11  
Conference Table

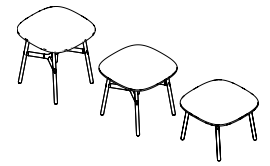

PAGE 12  
Conference Table

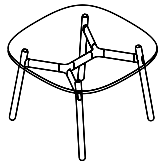

PAGE 13  
Conference Table

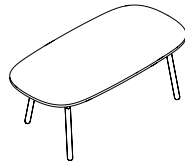

PAGE 14  
Desk

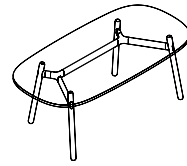

PAGE 15  
Desk

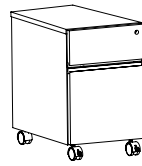

PAGE 16  
Pedestals

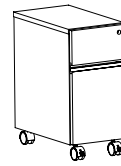

PAGE 17  
Pedestals

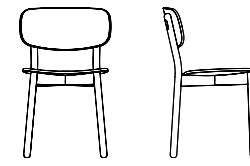

PAGE 18  
Chair

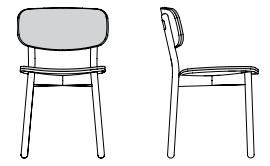

PAGE 19  
Chair

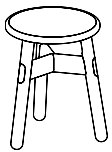

PAGE 20  
Stool

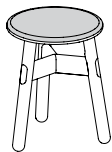

PAGE 21  
Stool



PAGE 22  
Stool



PAGE 23  
Stool

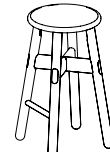

PAGE 24  
Counter Stool

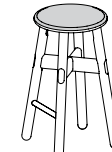

PAGE 25  
Counter Stool

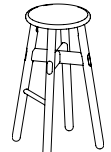

PAGE 26  
Barstool

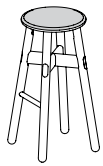

PAGE 27  
Barstool

## Roki seating fabric & leather program

### Seating & fabric leather program

DARRAN has partnered with some of the most prestigious fabric suppliers of the office furniture industry to bring you quality fabrics that are engaging designs, environmentally friendly and durable for years to come. The majority of fabrics we have graded-in are in heavy supply making it most likely available on our Quickship however, we cannot guarantee stock. If you do not see the fabric you wish to include in a project, please contact our Factory to see if this pattern can be graded in at 800.334.7891.

### Fabrics & Leathers

Please visit our Seating Fabrics page at [darran.com/textilesleather](http://darran.com/textilesleather)

Camira  
[www.camirafabrics.com](http://www.camirafabrics.com)  
 800.334.789

Wollsdorf  
[www.wollsdorf.com](http://www.wollsdorf.com)  
 336.884.5005

CFStinson  
[www.cfstinson.com](http://www.cfstinson.com)  
 800.841.6279

Green Hides  
[www.greenhides.com](http://www.greenhides.com)  
 336.315.9720

DesignTex  
[www.designtex.com](http://www.designtex.com)  
 800.797.4949

Maharam  
[www.maharam.com](http://www.maharam.com)  
 800.645.3943

Momentum Textiles  
[www.momentumtextiles.com](http://www.momentumtextiles.com)  
 800.366.6839

Ultrafabrics  
[www.ultrafabricsinc.com](http://www.ultrafabricsinc.com)  
 800.334.7891

Application instructions must be specified on the purchase order or COM / COL submission form. In the absence of application instructions, DARRAN will apply materials accordingly.

### CAL117

All DARRAN seating products conform to California Technical Bulletin 117 as a minimum standard.

### CAL133

To meet the California Technical Bulletin 133 flammability regulation, a combination of proper materials must be used to pass, as it tests the fire resistance of a finished product. Flame resistant fabric, a fire blocker material and special foam must be used to pass CAL133 fire codes.

Testing is available for all seating products with the following fees and considerations:

- If laboratory certification is not required, any style can be manufactured to comply with California Technical Bulletin 133 for \$75 list per yard required. (Customer's Own Materials must factor in additional yardage requirements based on repeat.)
- The purchase order must clearly indicate the requirement of California Technical Bulletin 133
- If laboratory California Technical Bulletin 133 certification is required, the cost of testing a chair is \$820 NET, plus the cost of the chair and covering material.
- An additional lead time of 4 to 6 weeks is required for testing for CAL133.
- Once testing is completed, we will provide a certification letter specific to the sample tested for CAL133.
- DARRAN's manufacturing procedures for California TB 133 compliance are based on the testing of representative style with specific fabrics. Please contact Customer Service for an updated list of tested models.
- A copy of test certification is available upon request.

## Roki seating fabric & leather program

### Combination fabrics

DARRAN is pleased to offer customers the design freedom of combination fabrics. When using fabric, vinyl or leather combinations, pricing will be as follows:

- When combining two materials of the same grade, pricing will be specified grade + 5%.
- If combining two materials of different grades or leather/ fabric combination, use the highest grade/price + 5%.
- If using COM or COL, pricing will be COM or COL + 5%. If both COM + COL are used in combination, use COL + 5%

### COM/COL ordering instructions

Please complete the COM Submission Form prior to ordering the fabric from the supplier. All COM fabrics must be approved prior to order submission. Please refer to our website or contact DARRAN Seating Customer Service for an updated list of preapproved COM fabrics. Application instructions must be specified on the purchase order or COM/COL submission form. In the absence of application instructions, DARRAN will apply materials in the best manner and cannot be held responsible for tailoring or application objections after upholstering. COM orders will be scheduled for production after receipt of the material. Packages must be clearly marked and the fabric must be first quality, continuous yardage.

### COM/COL yardage requirements

The yardage requirements stated in this price list for each style are calculated using 54" wide, non-directional fabrics. For fabrics with a different width or for patterns with repeats, please refer to the below chart to calculate the additional percent of fabric required:

Fabric Width	Plain Fabric	2" - 14" Repeat	15" - 19" Repeat	20" - 27" Repeat	28" - 36" Repeat
54"	0	15%	20%	25%	30%
53"	6%	19%	24%	28%	36%
52"	13%	23%	28%	33%	38%
51"	19%	26%	31%	36%	41%
50"	25%	30%	35%	40%	45%
49"	30%	35%	40%	45%	50%
48"	35%	40%	45%	50%	55%
47"	45%	50%	55%	58%	65%

## Roki seating fabric & leather program

NOTE: Prior To Completion Of This Form, Please Refer To Our Graded In Materials Program For Preapproved Fabrics/Leathers.

### COM/COL Approval

DARRAN Furniture Industries  
 2402 Shore Street, High Point, NC 27263  
 ATTN: Seating Division / COM/COL Approval  
 TAG: DARRAN Purchase Order Number

### Shipping approved COM/COL materials

DARRAN Furniture Industries  
 2402 Shore Street, High Point, NC 27263  
 ATTN: Seating Division / COM/COL Approval  
 TAG: DARRAN Purchase Order Number

Please complete this form, attach a 6"x 6" sample and mail to the COM/COL APPROVAL address shown above.  
 This form can also be downloaded from our website at [www.darran.com/leathers](http://www.darran.com/leathers) OR [www.darran.com/fabrics](http://www.darran.com/fabrics)

Purchase Order # \_\_\_\_\_  
 Dealer's Name \_\_\_\_\_  
 Contact \_\_\_\_\_  
 Address \_\_\_\_\_  
 Telephone \_\_\_\_\_  
 Email \_\_\_\_\_  
 Chair Style \_\_\_\_\_  
 Manufacturer \_\_\_\_\_  
 Pattern Name \_\_\_\_\_  
 Pattern Color \_\_\_\_\_  
 Content \_\_\_\_\_  
 Repeat \_\_\_\_\_

Please specify any special requirements and check the application above.

\_\_\_\_\_  
 \_\_\_\_\_  
 \_\_\_\_\_

ATTACH 6" X 6" FABRIC/LEATHER SAMPLE HERE

**NOTE**

Actual Fabric/Leather samples needed instead of digital images. If digital images are sent in lieu of samples, DARRAN will only verify the pattern and will not take responsibility for color variances that cannot be verified due to printing restrictions

In the absence of application instructions, DARRAN will apply the material in the best manner and cannot be held responsible for tailoring or application objections after upholstering.

Unless otherwise instructed on the purchase order, excess COM materials will be recycled at the discretion of DARRAN after six months of the original product ship date.

The COM approval solely pertains to the application of the fabric onto the specified DARRAN seating product. DARRAN's approval or acceptance does not constitute any responsibility or warranty to the overall appearance, durability, flammability, defects, dye lot variations or colorfastness of the COM. It is the customer's responsibility to ensure the COM meets CAL 117 compliance and are first quality continuous goods.

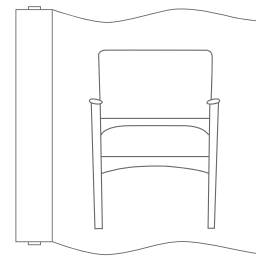

**RAILROAD**

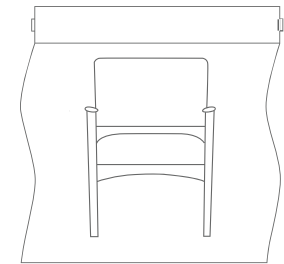

**SETUP**



## Roki finishes | specifications

STANDARD VENEER	PREMIUM VENEER	HIGH PRESSURE LAMINATE	THERMALLY FUSED LAMINATE
WLA Lofty Ash.....	N/A.....	N/A.....	N/A
WEC Ebony on Ash.....	N/A.....	GEC Ebony.....	MEC Ebony
WAM Alabaster Maple on Ash.....	N/A.....	GAM Alabaster Maple.....	N/A
WOW Clear Walnut on Walnut.....	N/A.....	N/A.....	N/A
WEW Executive Walnut.....	N/A.....	GEW Executive Walnut.....	N/A
WGW Gunstock Walnut.....	N/A.....	N/A.....	MGW Gunstock Walnut
WBW Henna Walnut.....	N/A.....	N/A.....	N/A
WSW Smokey Walnut.....	N/A.....	N/A.....	N/A
WNW Natural Walnut.....	N/A.....	GNW Natural Walnut.....	N/A
WWP Designer White Paint on Ash.....	N/A.....	N/A.....	N/A
WSO Salted Oak on Ash.....	N/A.....	N/A.....	N/A
N/A.....	N/A.....	GWL Designer White.....	MWL Designer White

\*All veneer finishes are standard in a matte 5% sheen. HPL TOPS ON TFL PRODUCTS Add 10% - Available with flat edge only  
Send 3x3 or larger finish chip for color match. Custom finish upcharge is 3% or \$250 Net (whichever is greater).

### Finish

ENVI-CT Green Certified European Technology Coatings Finish.

## Veneer and HPL tops

Veneer tops and high-pressure laminate tops feature a 45-pound density substrate with balanced 3-ply construction. Tops are 1-1/2" thick. DARRAN only uses HPVA A Grade Flat Cut Cherry, Maple, and Walnut Veneers and A Grade Quartered Oak and Ash Veneers. Cherry and Walnut veneers are book-matched. Oak, Maple, and Ash Veneers are slip-matched. Veneer tops feature a 3mm external solid hardwood band, HPL tops features a 2mm flat PVC band or a 1mm laminate self-edge.

## Table construction

Table bases are constructed from 1" thick solid Oak or Walnut. Parts are securely fastened together using rails that are bored and joined with wood fasteners. Legs are pre-board to accept a tee nut for the adjustable glide.

## Adjustable glides

Glides provide 1" of vertical leveling adjustment. Glide bottom is smooth nylon material.

## Roki metal finishes | specifications

### Bright ideas

Metal accents are standard in white. Optional colors enhance the modern look and can match interior or corporate colors.

Premium Metal Finish: Priced per unit on product page.



MFW  
White  
(Standard)



MFMB  
Matte Black  
(Premium)



MFGG  
Graphite Gray  
(Premium)



MFS  
Silver  
(Premium)



MFG  
Gray  
(Premium)



MFSA  
Surfin Aquavert  
(Premium)



MFOS  
Oyster  
(Premium)



MFPS  
Pistachio  
(Premium)



MFNA  
Navy  
(Premium)



MFSS  
Salmon Sienna  
(Premium)



MFOL  
Olive  
(Premium)



MFGB  
Grey Beige  
(Premium)

### Premium plus metal

Premium Plus Metal Finish: Priced per unit on product page.



MFC  
Copper  
(Premium Plus)

# Roki.

Cocktail Table  
Cocktail Table - Wood Top

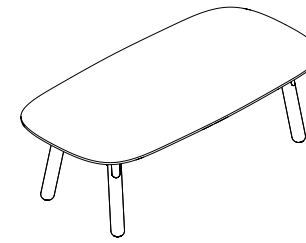

[View statement of line](#)

1 Select a model w" x d" x h"	weight	Standard Veneer Top Solid Wood Base		Premium Veneer Top Solid Wood Base		High Pressure Laminate Top Solid Wood Base		Thermally Fused Laminate Top Solid Wood Base	
		48 x 24 x 18	60	ROK4824RE111W	2447	"P" Option N/A	ROK4824RE111G	2267	ROK4824RE111M
2 Select a finish <a href="#">View finish details</a>		Top finishes		Wood legs		Top finishes		Wood legs	
Metal finish MFW White (Standard). Optional metal finishes are available, see options.		WLA	WLA	WLA	WLA	MEC	WLA	MEC	WLA
		WEC	WEC	WEC	WEC	MGW	WEC	MGW	WEC
		WAM	WAM	WAM	WAM	MWL	WAM	MWL	WAM
		WOW	WOW + 15%	WOW	WOW + 15%		WOW + 15%		WOW + 15%
		WEW	WEW + 15%	WEW	WEW + 15%		WEW + 15%		WEW + 15%
		WGW	WGW + 15%	WGW	WGW + 15%		WGW + 15%		WGW + 15%
		WBW	WBW + 15%	WBW	WBW + 15%		WBW + 15%		WBW + 15%
		WSW	WSW + 15%	WSW	WSW + 15%		WSW + 15%		WSW + 15%
		WNW	WNW + 15%	WNW	WNW + 15%		WNW + 15%		WNW + 15%
		WWP	WWP	WWP	WWP		WWP		WWP
3 Select a edge <a href="#">View edge details</a>		Flat		Flat		Flat		Flat	
4 Select hardware <a href="#">View hardware details</a>		Hardware N/A		Hardware N/A		Hardware N/A		Hardware N/A	

## Product features.

- 1" Thick top
- ENVI-CT Finish on wood tops
- Metal in standard MFW White
- Solid Ash (standard), optional Solid Walnut legs
- Radius corners
- 1" Adjustable glides
- Ships assembled

### NOTES

- All veneer finishes are 5% matte sheen

## Options.

### PREMIUM METAL FINISHES

- Specify Rail and End Cap Metal Finish Color. MFMB: Matte Black, MFS: Silver, MFSS: Salmon Sienna, MFSA: Surfin Aquavert, MFPS: Pistachio, MFOS: Oyster, MFNA: Navy, MFOL: Olive, MFGB: Grey Beige MFGG: Graphite Gray, MFG: Gray - \$400
- MFC: Copper metal finish upcharge - \$625

# Roki.

Cocktail Table  
Cocktail Table - Glass Top

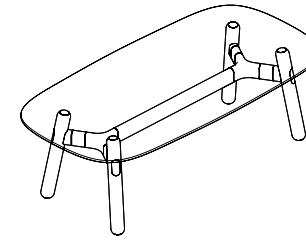

1 Select a model		weight	View statement of line	
w" x d" x h"	Glass Top Solid Wood Base			
48 x 24 x 18	ROK4824RE111S 2064			

2 Select a finish		Wood legs
<i>View finish details</i>	WLA	
	WEC	
	WAM	
Metal finish	WOW + 15%	
MFW White (Standard).	WEW + 15%	
Optional metal finishes	WGW + 15%	
are available, see	WBW + 15%	
options.	WSW + 15%	
	WNW + 15%	
	WWP	

3 Select a edge		Flat
<i>View edge details</i>		

4 Select hardware		Hardware
<i>View hardware details</i>	N/A	

## Product features.

- 1/2" Thick clear glass top with flat polished edges
- Metal in standard MFW White
- Solid Ash (standard), optional Solid Walnut legs
- Radius corners
- 1" Adjustable glides
- Ships KD

### NOTES

- All veneer finishes are 5% matte sheen

## Options.

### PREMIUM METAL FINISHES

- Specify Rail and End Cap Metal Finish Color. MFMB: Matte Black, MFS: Silver, MFSS: Salmon Sienna, MFSA: Surfin Aquavert, MFPS: Pistachio, MFOS: Oyster, MFNA: Navy, MFOL: Olive, MFGB: Grey Beige MFGG: Graphite Gray, MFG: Gray - \$400
- MFC: Copper metal finish upcharge - \$625

# Roki.

Conference Table  
Rectangle - Wood Top

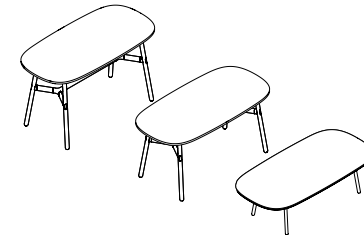

1 Select a model w" x d" x h"	weight	Standard Veneer Top Solid Wood Base		Premium Veneer Top Solid Wood Base		High Pressure Laminate Top Solid Wood Base		Thermally Fused Laminate Top Solid Wood Base			
		<b>Conference Height</b> 72 x 36 x 29 84 x 42 x 29 96 x 48 x 29 <b>Counter Height</b> 72 x 36 x 36 <b>Bar Height</b> 72 x 36 x 42		135 ROK7236RE121W 3364 160 ROK8442RE121W 3791 195 ROK9648RE121W 4165	"P" Option N/A "P" Option N/A "P" Option N/A	ROK7236RE121G 3364 ROK8442RE121G 3791 ROK9648RE121G 4165	ROK7236RE121M 2839 ROK8442RE121M 3110 ROK9648RE121M 3349	ROK7236RE131G 3624 ROK7236RE141G 3796	ROK7236RE131M 3052 ROK7236RE141M 3177		
2 Select a finish <i>View finish details</i>		Top finishes	Wood legs			Top finishes	Wood legs			Top finishes	Wood legs
		WLA WEC WAM WOW WEW WGW WBW WSW WNW WWP	WLA WEC WAM WOW + 15% WEW + 15% WGW + 15% WBW + 15% WSW + 15% WNW + 15% WWP			GEC GAM GEW GNW GWL	WLA WEC WAM WOW + 15% WEW + 15% WNW + 15% WWP			MEC MGW MWL	WLA WEC WAM WOW + 15% WGW + 15% WWP
3 Select an edge <i>View edge details</i>		Flat				Flat				Flat	
4 Select hardware <i>View hardware details</i>		Hardware				Hardware				Hardware	
		N/A				N/A				N/A	

[View statement of line](#)

## Product features.

- 1" Thick top
- ENVI-CT Finish on wood tops
- Metal in standard MFW White
- Solid Ash (standard), optional Solid Walnut legs
- Radius corners
- 1" Adjustable glides
- Ships KD

### NOTES

- All veneer finishes are 5% matte sheen

## Options.

### PREMIUM METAL FINISHES

- Specify Rail and End Cap Metal Finish Color. MFMB: Matte Black, MFS: Silver, MFSS: Salmon Sienna, MFSA: Surfin Aquavert, MFPS: Pistachio, MFOS: Oyster, MFNA: Navy, MFOL: Olive, MFGB: Grey Beige MFGG: Graphite Gray, MFG: Gray - \$400
- MFC: Copper metal finish upcharge - \$625

# Roki.

Conference Table  
Rectangle - Glass Top

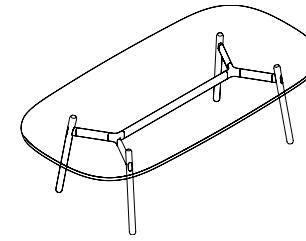

1 Select a model		weight	Glass Top	View statement of line	
w" x d" x h"			Solid Wood Base		
72 x 36 x 29		135	ROK7236RE121S 3323		
84 x 42 x 29		160	ROK8442RE121S 3598		

2 Select a finish		Wood legs
<i>View finish details</i>		WLA
		WEC
		WAM
<b>Metal finish</b>		WOW + 15%
MFW White (Standard).		WEW + 15%
Optional metal finishes		WGW + 15%
are available, see		WBW + 15%
options.		WSW + 15%
		WNW + 15%
		WWP

3 Select a edge		Flat
<i>View edge details</i>		

4 Select hardware		Hardware
<i>View hardware details</i>		N/A

## Product features.

- 1/2" Thick clear glass top with flat polished edges
- Metal in standard MFW White
- Solid Ash (standard), optional Solid Walnut legs
- Radius corners
- 1" Adjustable glides
- Ships KD

### NOTES

- All veneer finishes are 5% matte sheen

## Options.



### PREMIUM METAL FINISHES

- Specify Rail and End Cap Metal Finish Color. MFMB: Matte Black, MFS: Silver, MFSS: Salmon Sienna, MFSA: Surfin Aquavert, MFPS: Pistachio, MFOS: Oyster, MFNA: Navy, MFOL: Olive, MFGB: Grey Beige MFGG: Graphite Gray, MFG: Gray - \$400
- MFC: Copper metal finish upcharge - \$625

# Roki.

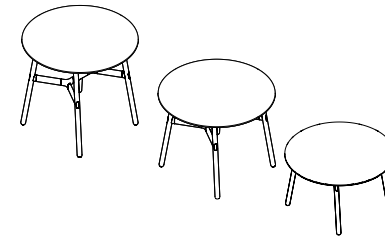
Conference Table  
Round - Wood Top



1 Select a model w" x d" x h"	weight	Standard Veneer Top Solid Wood Base		Premium Veneer Top Solid Wood Base		High Pressure Laminate Top Solid Wood Base		Thermally Fused Laminate Top Solid Wood Base	
		<b>Conference Height</b> 48 DIA x 29 54 DIA x 29 <b>Counter Height</b> 48 DIA x 36 54 DIA x 36 <b>Bar Height</b> 48 DIA x 42 54 DIA x 42		105 ROK4848RD121W 2985 105 ROK5454RD121W 3245 110 ROK4848RD131W 3125 110 ROK5454RD131W 3385 115 ROK4848RD141W 3177 115 ROK5454RD141W 3437	"P" Option N/A "P" Option N/A "P" Option N/A "P" Option N/A "P" Option N/A "P" Option N/A	ROK4848RD121G 2985 ROK5454RD121G 3245 ROK4848RD131G 3125 ROK5454RD131G 3385 ROK4848RD141G 3177 ROK5454RD141G 3437	ROK4848RD121M 2517 ROK5454RD121M 2673 ROK4848RD131M 2657 ROK5454RD131M 2813 ROK4848RD141M 2709 ROK5454RD141M 2865		
2 Select a finish <i>View finish details</i>		Top finishes WLA WEC WAM Metal finish MFW White (Standard). Optional metal finishes are available, see options. WOV WEW WGW WBW WSW WNW WWP	Wood legs WLA WEC WAM WOW + 15% WEW + 15% WGW + 15% WBW + 15% WSW + 15% WNW + 15% WWP		Top finishes GEC GAM GEW GNW GWL	Wood legs WLA WEC WAM WOW + 15% WEW + 15% WNW + 15% WWP		Top finishes MEC MGW MWL	Wood legs WLA WEC WAM WOW + 15% WGW + 15% WWP
3 Select an edge <i>View edge details</i>		 Flat			 Flat			 Flat	
4 Select hardware <i>View hardware details</i>		Hardware N/A			Hardware N/A			Hardware N/A	

[View statement of line](#)

## Product features.

- 1" Thick top
- ENVI-CT Finish on wood tops
- Metal in standard MFW White
- Solid Ash (standard), optional Solid Walnut legs
- 1" Adjustable glides
- Ships KD

### NOTES

- All veneer finishes are 5% matte sheen

## Options.

### PREMIUM METAL FINISHES

- Specify Rail and End Cap Metal Finish Color. MFMB: Matte Black, MFS: Silver, MFSS: Salmon Sienna, MFSA: Surfin Aquavert, MFPS: Pistachio, MFOS: Oyster, MFNA: Navy, MFOL: Olive, MFGB: Grey Beige MFGG: Graphite Gray, MFG: Gray - \$400
- MFC: Copper metal finish upcharge - \$625

# Roki.

Conference Table  
Round - Glass Top

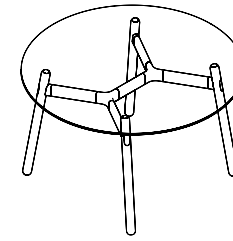

1 Select a model		View statement of line	
w" x d" x h"	weight		
48 DIA x 29	105	Glass Top	
54 DIA x 29	105	Solid Wood Base	
2 Select a finish			
<i>View finish details</i>			
Metal finish		Wood legs	
MFW White (Standard).		WLA	
Optional metal finishes are available, see options.		WEC	
		WAM	
		WOW + 15%	
		WEW + 15%	
		WGW + 15%	
		WBW + 15%	
		WSW + 15%	
		WNW + 15%	
		WWP	
3 Select a edge			
<i>View edge details</i>			
			
		Flat	
4 Select hardware			
<i>View hardware details</i>			
		Hardware	
		N/A	

## Product features.

- 1/2" Thick clear glass top with flat polished edges
- Metal in standard MFW White
- Solid Ash (standard), optional Solid Walnut legs
- 1" Adjustable glides
- Ships KD

### NOTES

- All veneer finishes are 5% matte sheen

## Options.

### PREMIUM METAL FINISHES



- Specify Rail and End Cap Metal Finish Color. MFMB: Matte Black, MFS: Silver, MFSS: Salmon Sienna, MFSA: Surfin Aquavert, MFPS: Pistachio, MFOS: Oyster, MFNA: Navy, MFOL: Olive, MFGB: Grey Beige MFGG: Graphite Gray, MFG: Gray - \$400
- MFC: Copper metal finish upcharge - \$625

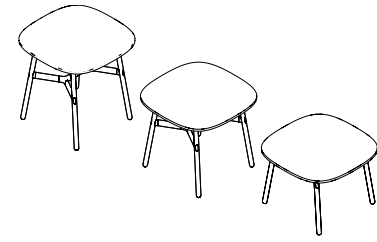

# Roki.

Conference Table  
Square - Wood Top



1 Select a model w" x d" x h"	weight	Standard Veneer Top Solid Wood Base		Premium Veneer Top Solid Wood Base		High Pressure Laminate Top Solid Wood Base		Thermally Fused Laminate Top Solid Wood Base	
		<b>Conference Height</b> 48 x 48 x 29 54 x 54 x 29 <b>Counter Height</b> 48 x 48 x 36 54 x 54 x 36 <b>Bar Height</b> 48 x 48 x 42 54 x 54 x 42		105 ROK4848SQ121W 2985 105 ROK5454SQ121W 3245 110 ROK4848SQ131W 3125 110 ROK5454SQ131W 3385 115 ROK4848SQ141W 3177 115 ROK5454SQ141W 3437	"P" Option N/A "P" Option N/A "P" Option N/A "P" Option N/A "P" Option N/A "P" Option N/A	ROK4848SQ121G 2985 ROK5454SQ121G 3245 ROK4848SQ131G 3125 ROK5454SQ131G 3385 ROK4848SQ141G 3177 ROK5454SQ141G 3437	ROK4848SQ121M 2517 ROK5454SQ121M 2673 ROK4848SQ131M 2657 ROK5454SQ131M 2813 ROK4848SQ141M 2709 ROK5454SQ141M 2865		
2 Select a finish <i>View finish details</i>		Top finishes WLA WEC WAM Metal finish WOW MFW White (Standard). WEW Optional metal finishes are available, see options. WGW WBW WSW WNW WWP	Wood legs WLA WEC WAM WOW + 15% WEW + 15% WGW + 15% WBW + 15% WSW + 15% WNW + 15% WWP			Top finishes GEC GAM GEW GNW GWL	Wood legs WLA WEC WAM WOW + 15% WEW + 15% WNW + 15% WWP		
3 Select an edge <i>View edge details</i>		 Flat				 Flat		 Flat	
4 Select hardware <i>View hardware details</i>		Hardware N/A				Hardware N/A		Hardware N/A	

[View statement of line](#)

## Product features.

- 1" Thick top
- ENVI-CT Finish on wood tops
- Metal in standard MFW White
- Solid Ash (standard), optional Solid Walnut legs
- Radius corners
- 1" Adjustable glides
- Ships KD

### NOTES

- All veneer finishes are 5% matte sheen

## Options.

### PREMIUM METAL FINISHES

- Specify Rail and End Cap Metal Finish Color. MFMB: Matte Black, MFS: Silver, MFSS: Salmon Sienna, MFSA: Surfin Aquavert, MFPS: Pistachio, MFOS: Oyster, MFNA: Navy, MFOL: Olive, MFGB: Grey Beige MFGG: Graphite Gray, MFG: Gray - \$400
- MFC: Copper metal finish upcharge - \$625

# Roki.

Conference Table  
Square - Glass Top

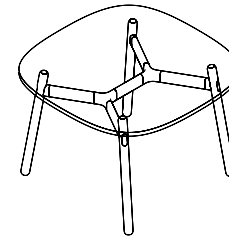

1 Select a model		weight	Glass Top	View statement of line	
w" x d" x h"			Solid Wood Base		
48 x 48 x 29		105	ROK4848SQ121S2928		
54 x 54 x 29		105	ROK5454SQ121S3188		

2 Select a finish		Wood legs
View finish details		WLA
		WEC
		WAM
Metal finish		WOW + 15%
MFW White (Standard).		WEW + 15%
Optional metal finishes		WGW + 15%
are available, see		WBW + 15%
options.		WSW + 15%
		WNW + 15%
		WWP

3 Select a edge		Flat
View edge details		

4 Select hardware		Hardware
View hardware details		N/A

## Product features.

- 1/2" Thick clear glass top with flat polished edges
- Metal in standard MFW White
- Solid Ash (standard), optional Solid Walnut legs
- Radius corners
- 1" Adjustable glides
- Ships KD

### NOTES

- All veneer finishes are 5% matte sheen

## Options.



### PREMIUM METAL FINISHES

- Specify Rail and End Cap Metal Finish Color. MFMB: Matte Black, MFS: Silver, MFSS: Salmon Sienna, MFSA: Surfin Aquavert, MFPS: Pistachio, MFOS: Oyster, MFNA: Navy, MFOL: Olive, MFGB: Grey Beige MFGG: Graphite Gray, MFG: Gray - \$400
- MFC: Copper metal finish upcharge - \$625

# Roki.

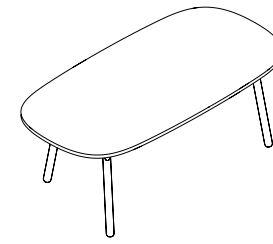
Desk  
Table Desk- Wood Top



1 Select a model		Standard Veneer Top Solid Wood Base		Premium Veneer Top Solid Wood Base		High Pressure Laminate Top Solid Wood Base		Thermally Fused Laminate Top Solid Wood Base	
w" x d" x h"	weight								
72 x 36 x 29	135	ROK7236DS048W	3375	"P" Option N/A		ROK7236DS048G	3375	ROK7236DS048M	2850
2 Select a finish		Top finishes		Wood legs		Top finishes		Wood legs	
<i>View finish details</i>		WLA		WLA		GEC		WLA	
Metal finish		WEC		WEC		GAM		WEC	
MFW White (Standard).		WAM		WAM		GEW		WAM	
Optional metal finishes		WOW		WOW + 15%		GNW		WOW + 15%	
are available, see		WEW		WEW + 15%		GWL		WEW + 15%	
options.		WGW		WGW + 15%				WNW + 15%	
		WBW		WBW + 15%				WWP	
		WSW		WSW + 15%					
		WNW		WNW + 15%					
		WWP		WWP					
3 Select a edge									
<i>View edge details</i>		Flat				Flat		Flat	
4 Select hardware		Hardware				Hardware		Hardware	
<i>View hardware details</i>		N/A				N/A		N/A	

[View statement of line](#)

## Product features.

- 1" Thick top
- ENVI-CT Finish on wood tops
- Metal in standard MFW White
- Solid Ash (standard), optional Solid Walnut legs
- Radius corners
- 1" Adjustable glides
- Ships KD

### NOTES

- All veneer finishes are 5% matte sheen

## Options.

### PREMIUM METAL FINISHES

- Specify Rail and End Cap Metal Finish Color. MFMB: Matte Black, MFS: Silver, MFSS: Salmon Sienna, MFSA: Surfin Aquavert, MFPS: Pistachio, MFOS: Oyster, MFNA: Navy, MFOL: Olive, MFGB: Grey Beige MFGG: Graphite Gray, MFG: Gray - \$400
- MFC: Copper metal finish upcharge - \$625

# Roki.

Desk  
Table Desk - Glass Top

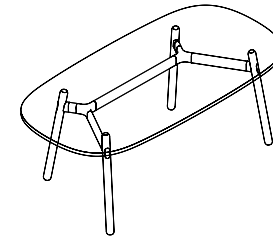

1 Select a model		weight	View statement of line	
w" x d" x h"	Glass Top Solid Wood Base			
72 x 36 x 29	135 ROK7236DS048S3333			

2 Select a finish		Wood legs
<i>View finish details</i>	WLA	
	WEC	
	WAM	
Metal finish	WOW + 15%	
MFW White (Standard).	WEW + 15%	
Optional metal finishes	WGW + 15%	
are available, see	WBW + 15%	
options.	WSW + 15%	
	WNW + 15%	
	WWP	

3 Select a edge		Flat
<i>View edge details</i>		

4 Select hardware		Hardware
<i>View hardware details</i>	N/A	

## Product features.

- 1/2" Thick clear glass top with flat polished edges
- Metal in standard MFW White
- Solid Ash (standard), optional Solid Walnut legs
- Radius corners
- 1" Adjustable glides
- Ships KD

### NOTES

- All veneer finishes are 5% matte sheen

## Options.

### PREMIUM METAL FINISHES

- Specify Rail and End Cap Metal Finish Color. MFMB: Matte Black, MFS: Silver, MFSS: Salmon Sienna, MFSA: Surfin Aquavert, MFPS: Pistachio, MFOS: Oyster, MFNA: Navy, MFOL: Olive, MFGB: Grey Beige MFGG: Graphite Gray, MFG: Gray - \$400
- MFC: Copper metal finish upcharge - \$625

# Roki.

## Pedestals

### Open Plan Mobile Desk Pedestal With Casters

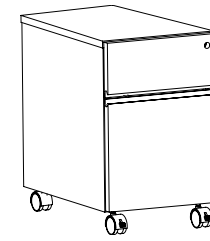

1 Select a model w" x d" x h"	weight	Standard Veneer Top	Premium Veneer Top	High Pressure Laminate Top	Thermally fused laminate top
16 x 18 x 22	55	ROK1618PD423W 1144	"P" Option N/A	"G" Option N/A	ROK1618PD423M 967

2 Select a finish <i>View finish details</i>	WLA WEC WAM WOW WEW WGW WBW WSW WNW WWP
3 Select a edge <i>View edge details</i>	Edge N/A

4 Select hardware <i>View hardware details</i>	
	

[View statement of line](#)

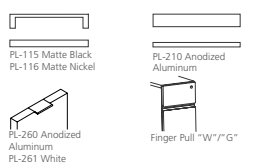
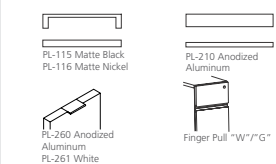
## Product features.

- Anti-tilt safety feature
- Finished all sides and top - open plan
- Full extension drawers - locking
- 3" Hollow wheel caster

### NOTES

- All veneer finishes are 5% matte sheen

## Options.

### CUSHION

- BC16: Bench Cushion
- Specify fabric grade (.5 yd. required)

## BC16 Cushion fabric grades.

COM	COL	1	2	3
224	243	261	279	297
4	5	6	7	8
315	333	351	369	387
9	10	11/L1	12	13/L2
405	423	441	459	495

# Roki.

Pedestals  
Open Plan Mini Mobile Desk Pedestal With Casters

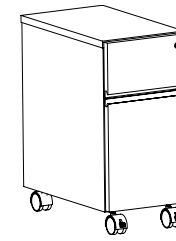

[View statement of line](#)

1 Select a model w" x d" x h"	weight	Standard Veneer Top	Premium Veneer Top	High Pressure Laminate Top	Thermally fused laminate top
10 x 18 x 22	40	ROK1018PD423W 1087	"P" Option N/A	"G" Option N/A	ROK1018PD423M 931

2 Select a finish <a href="#">View finish details</a>	3 Select a edge <a href="#">View edge details</a>	4 Select hardware <a href="#">View hardware details</a>
WLA WEC WAM WOW WEW WGW WBW WSW WNW WWP	Edge N/A	
MEC MGW MWL	Edge N/A	

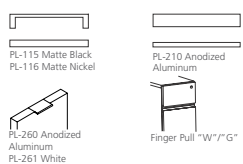
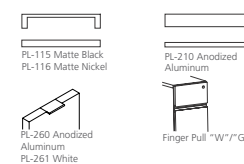
## Product features.

- Anti-tilt safety feature
- Finished all sides and top - open plan
- Full extension drawers - locking
- 3" Hollow wheel caster

### NOTES

- All veneer finishes are 5% matte sheen

## Options.

### CUSHION

- BC16: Bench Cushion
- Specify fabric grade (.5 yd. required)

### MATTE FINISH

- LST: Modify standard 40 finish sheen to 5 matte sheen - n/c

## BC10 Cushion fabric grades.

COM	COL	1	2	3
203	222	240	258	276
4	5	6	7	8
294	312	330	348	366
9	10	11/L1	12	13/L2
384	402	420	438	474

# Roki.

Chair  
Guest Chair

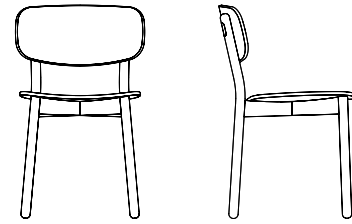

[View statement of line](#)

## Product features.

- 1" Adjustable felt glides for hard surface flooring
- White metal leg caps standard
- Solid Ash (standard), optional Solid Walnut
- Molded Plywood seat and back in Ash Veneer (standard, optional Walnut)
- Ships assembled

### NOTES

- All veneer finishes are 5% matte sheen

## Options.

### PREMIUM METAL FINISHES

- Specify Leg Cap Metal Finish Color. MFMB: Matte Black, MFS: Silver, MFSS: Salmon Sienna, MFSA: Surfin Aquavert, MFPS: Pistachio, MFOS: Oyster, MFNA: Navy, MFOL: Olive, MFGB: Grey Beige MFGG: Graphite Gray, MFG: Gray - \$55
- MFC: Copper metal finish upcharge - \$260

### GLIDE OPTIONS

- PGC: Adjustable plastic glides for carpeted floors - n/c

1 model	COM	COL	1	2	3	4	5	6	7	8	9	10	11/L1	12	13/L2
ROK1931OPC09	1643	N/A													
W x D x H 18 x 19 x 31 Arm Height: N/A Seat Height: 17.5" Inside Seat Depth: 15.5" Inside Seat Width: 17"			Upholstery Requirements Fabric yds: Leather Sq. Ft.: Carton Weight: 25												

## 2 Select a finish

[View finish details](#)

- WLA Lofty Ash on Ash
- WEC Ebony on Ash
- WAM Alabaster Maple on Ash
- WOW Clear Walnut on Walnut
- WEW Executive Walnut on Walnut
- WGW Gunstock Walnut on Walnut
- WBW Henna Walnut on Walnut
- WSW Smokey Walnut on Walnut
- WNW Natural Walnut on Walnut
- WSO Salted Oak on Ash
- WWP Designer White Paint

**Metal finish**  
MFW White (Standard). Optional metal finishes are available, see options.

## 3 Combination Fabrics

[View finish details](#)

Combination  
Fabric Option  
Not Available

# Roki.

Chair  
Upholstered Guest Chair

1 model	COM	COL	1	2	3	4	5	6	7	8	9	10	11/L1	12	13/L2
ROK1931HUB09	1751	1751	1788	1806	1824	1842	1860	1878	1896	1914	1932	1950	1968	1986	2022
W x D x H 18 x 20 x 31			Upholstery Requirements												
Arm Height: N/A			Fabric yds: 1 yd Leather Sq. Ft.: 18 sqft												
Seat Height: 17.75"			Carton Weight: 25												
Inside Seat Depth: 15.5"															
Inside Seat Width: 17"															

## 2 Select a finish

[View finish details](#)

- WLA Lofty Ash
- WEC Ebony
- WAM Alabaster Maple
- WOW Clear Walnut on Walnut
- WEW Executive Walnut on Walnut
- WGW Gunstock Walnut on Walnut
- WBW Henna Walnut on Walnut
- WSW Smokey Walnut on Walnut
- WNW Natural Walnut on Walnut
- WSO Salted Oak on Ash
- WWP Designer White Paint on Ash

**Metal finish**  
MFW White (Standard). Optional metal finishes are available, see options.

## 3 Combination Fabrics

[View finish details](#)

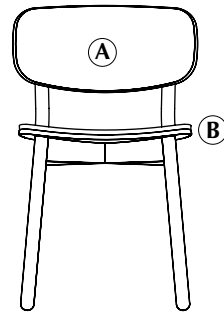

Front View

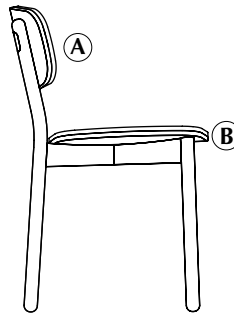

Side View

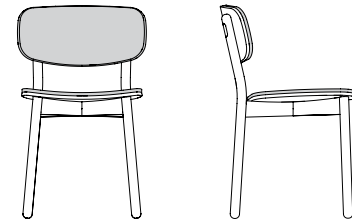

[View statement of line](#)

## Product features.

- 1" Adjustable felt glides for hard surface flooring
- White metal leg caps standard
- Solid Ash (standard), optional Solid Walnut
- Molded Plywood seat and back in Ash Veneer (standard, optional Walnut)
- 5/8" thick upholstered seat and backrest cushions
- Ships assembled

### NOTES

- All veneer finishes are 5% matte sheen

## Options.

### PREMIUM METAL FINISHES

- Specify Leg Cap Metal Finish Color. MFMB: Matte Black, MFS: Silver, MFSS: Salmon Sienna, MFSA: Surfin Aquavert, MFPS: Pistachio, MFOS: Oyster, MFNA: Navy, MFOL: Olive, MFGB: Grey Beige MFGG: Graphite Gray, MFG: Gray - \$55
- MFC: Copper metal finish upcharge - \$260

### GLIDE OPTIONS

- PGC: Adjustable plastic glides for carpeted floors - n/c



# Roki.

Stool  
Three Legged Guest Height Stool

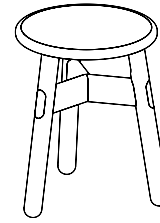

1 model	COM	COL	1	2	3	4	5	6	7	8	9	10	11/L1	12	13/L2
ROK1518SHS10	1125	N/A													
W x D x H 15 x 15 x 18															
Arm Height: N/A															
Seat Height: 18"															
Inside Seat Depth: 14"															
Inside Seat Width: 14"															

Upholstery Requirements  
Fabric yds: Leather Sq. Ft.:  
Carton Weight:

## 2 Select a finish

[View finish details](#)

- WLA Lofty Ash
- WEC Ebony
- WAM Alabaster Maple
- WOW Clear Walnut on Walnut
- WEW Executive Walnut on Walnut
- WGW Gunstock Walnut on Walnut
- WBW Henna Walnut on Walnut
- WSW Smokey Walnut on Walnut
- WNW Natural Walnut on Walnut
- WSO Salted Oak on Ash
- WWP Designer White Paint on Ash

**Metal finish**  
MFW White (Standard). Optional metal finishes are available, see options.

## 3 Combination Fabrics

[View finish details](#)

**Combination  
Fabric Option  
Not Available**

[View statement of line](#)

## Product features.

- 1" Contoured Ash (standard) or Walnut seat
- Solid Ash (standard), optional Solid Walnut
- 1" Adjustable felt glides for hard surface flooring
- Metal in standard MFW White
- Ships assembled

### NOTES

- All veneer finishes are 5% matte sheen

## Options.

### PREMIUM METAL FINISHES

- Specify Leg Cap Metal Finish Color. MFMB: Matte Black, MFS: Silver, MFSS: Salmon Sienna, MFSA: Surfin Aquavert, MFPS: Pistachio, MFOS: Oyster, MFNA: Navy, MFOL: Olive, MFGB: Grey Beige MFGG: Graphite Gray, MFG: Gray - \$55

### GLIDE OPTIONS

- PGC: Adjustable plastic glides for carpeted floors - n/c

# Roki.

Stool  
*Three Legged Upholstered Guest Height Stool*

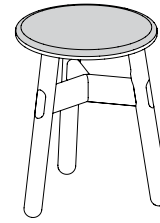

[View statement of line](#)

## Product features.

- 5/8" thick upholstered seat cushion
- 1" Adjustable felt glides for hard surface flooring
- Metal in standard MFW White
- Solid Ash (standard), optional Solid Walnut
- Ships assembled

### NOTES

- All veneer finishes are 5% matte sheen

## Options.

### PREMIUM METAL FINISHES

- Specify Leg Cap Metal Finish Color. MFMB: Matte Black, MFS: Silver, MFSS: Salmon Sienna, MFSA: Surfin Aquavert, MFPS: Pistachio, MFOS: Oyster, MFNA: Navy, MFOL: Olive, MFGB: Grey Beige MFGG: Graphite Gray, MFG: Gray - \$55

### GLIDE OPTIONS

- PGC: Adjustable plastic glides for carpeted floors - n/c

1 model	COM	COL	1	2	3	4	5	6	7	8	9	10	11/L1	12	13/L2
ROK1518SHS11	1355	1355	1374	1384	1394	1404	1414	1424	1434	1444	1454	1464	1474	1484	1504
W x D x H 15 x 15 x 17			Upholstery Requirements												
Arm Height: N/A			Fabric yds: 0.5 yds Leather Sq. Ft.: 9 sqft												
Seat Height: 18"			Carton Weight:												
Inside Seat Depth: 14"															
Inside Seat Width: 14"															

## 2 Select a finish

[View finish details](#)

- WLA Lofty Ash
- WEC Ebony
- WAM Alabaster Maple
- WOW Clear Walnut on Walnut
- WEW Executive Walnut on Walnut
- WGW Gunstock Walnut on Walnut
- WBW Henna Walnut on Walnut
- WSW Smokey Walnut on Walnut
- WNW Natural Walnut on Walnut
- WSO Salted Oak on Ash
- WWP Designer White Paint on Ash

**Metal finish**  
 MFW White (Standard). Optional metal finishes are available, see options.

## 3 Combination Fabrics

[View finish details](#)

Combination  
 Fabric Option  
 Not Available

# Roki.

Stool  
Four Legged Guest Height Stool

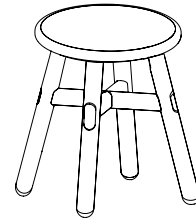

[View statement of line](#)

## Product features.

- 1" Contoured Ash (standard) or Walnut seat
- Solid Ash (standard), optional Solid Walnut
- 1" Adjustable felt glides for hard surface flooring
- Metal in standard MFW White
- Ships assembled

### NOTES

- All veneer finishes are 5% matte sheen

## Options.

### PREMIUM METAL FINISHES

- Specify Leg Cap Metal Finish Color. MFMB: Matte Black, MFS: Silver, MFSS: Salmon Sienna, MFSA: Surfin Aquavert, MFPS: Pistachio, MFOS: Oyster, MFNA: Navy, MFOL: Olive, MFGB: Grey Beige MFGG: Graphite Gray, MFG: Gray - \$55
- MFC: Copper metal finish upcharge - \$260

### GLIDE OPTIONS

- PGC: Adjustable plastic glides for carpeted floors - n/c

1 model	COM	COL	1	2	3	4	5	6	7	8	9	10	11/L1	12	13/L2
ROK1518SHS20	1245	N/A													
W x D x H 15 x 15 x 18															
Arm Height: N/A															
Seat Height: 18"															
Inside Seat Depth: 14"															
Inside Seat Width: 14"															

Upholstery Requirements  
Fabric yds: Leather Sq. Ft.:  
Carton Weight: 25

## 2 Select a finish

[View finish details](#)

- WLA Lofty Ash
- WEC Ebony
- WAM Alabaster Maple
- WOW Clear Walnut on Walnut
- WEW Executive Walnut on Walnut
- WGW Gunstock Walnut on Walnut
- WBW Henna Walnut on Walnut
- WSW Smokey Walnut on Walnut
- WNW Natural Walnut on Walnut
- WSO Salted Oak on Ash
- WWP Designer White Paint on Ash

**Metal finish**  
MFW White (Standard). Optional metal finishes are available, see options.

## 3 Combination Fabrics

[View finish details](#)

Combination  
Fabric Option  
Not Available

# Roki.

Stool  
Four Legged Upholstered Guest Height Stool

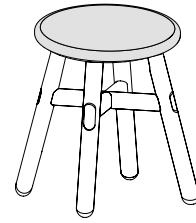

[View statement of line](#)

## Product features.

- 5/8" thick upholstered seat cushion
- 1" Adjustable felt glides for hard surface flooring
- Metal in standard MFW White
- Solid Ash (standard), optional Solid Walnut
- Ships assembled

### NOTES

- All veneer finishes are 5% matte sheen

## Options.

### PREMIUM METAL FINISHES

- Specify Leg Cap Metal Finish Color. MFMB: Matte Black, MFS: Silver, MFSS: Salmon Sienna, MFSA: Surfin Aquavert, MFPS: Pistachio, MFOS: Oyster, MFNA: Navy, MFOL: Olive, MFGB: Grey Beige MFGG: Graphite Gray, MFG: Gray - \$55
- MFC: Copper metal finish upcharge - \$260

### GLIDE OPTIONS

- PGC: Adjustable plastic glides for carpeted floors - n/c

1 model	COM	COL	1	2	3	4	5	6	7	8	9	10	11/L1	12	13/L2
ROK1518SHS21	1475	1475	1494	1504	1514	1524	1534	1544	1554	1564	1574	1584	1594	1604	1624
W x D x H 15 x 15 x 18			Upholstery Requirements												
Arm Height: N/A			Fabric yds: 0.5 yds Leather Sq. Ft.: 9 sqft												
Seat Height: 18"			Carton Weight: 25												
Inside Seat Depth: 14"															
Inside Seat Width: 14"															

## 2 Select a finish

[View finish details](#)

- WLA Lofty Ash
- WEC Ebony
- WAM Alabaster Maple
- WOW Clear Walnut on Walnut
- WEW Executive Walnut on Walnut
- WGW Gunstock Walnut on Walnut
- WBW Henna Walnut on Walnut
- WSW Smokey Walnut on Walnut
- WNW Natural Walnut on Walnut
- WSO Salted Oak on Ash
- WWP Designer White Paint on Ash

### Metal finish

MFW White (Standard). Optional metal finishes are available, see options.

## 3 Combination Fabrics

[View finish details](#)

Combination  
Fabric Option  
Not Available

# Roki.

Stool  
Counter Height Stool

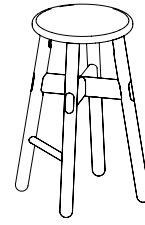

[View statement of line](#)

## Product features.

- 1" Contoured Ash (standard) or Walnut seat
- Solid Ash (standard), optional Solid Walnut
- 1" Adjustable felt glides for hard surface flooring
- Metal in standard MFW White
- Ships assembled

### NOTES

- All veneer finishes are 5% matte sheen

## Options.

### PREMIUM METAL FINISHES

- Specify Leg Cap Metal Finish Color. MFMB: Matte Black, MFS: Silver, MFSS: Salmon Sienna, MFSA: Surfin Aquavert, MFPS: Pistachio, MFOS: Oyster, MFNA: Navy, MFOL: Olive, MFGB: Grey Beige MFGG: Graphite Gray, MFG: Gray - \$55
- MFC: Copper metal finish upcharge - \$260

### GLIDE OPTIONS

- PGC: Adjustable plastic glides for carpeted floors - n/c

1 model	COM	COL	1	2	3	4	5	6	7	8	9	10	11/L1	12	13/L2
ROK1926CTR10	1360	N/A													
W x D x H 14 x 14 x 25 Arm Height: N/A Seat Height: 25.5" Inside Seat Depth: 14" Inside Seat Width: 14"			Upholstery Requirements Fabric yds: N/A Leather Sq. Ft.: N/A Carton Weight: 30												

## 2 Select a finish

[View finish details](#)

- WLA Lofty Ash
- WEC Ebony
- WAM Alabaster Maple
- WOW Clear Walnut on Walnut
- WEW Executive Walnut on Walnut
- WGW Gunstock Walnut on Walnut
- WBW Henna Walnut on Walnut
- WSW Smokey Walnut on Walnut
- WNW Natural Walnut on Walnut
- WSO Salted Oak on Ash
- WWP Designer White Paint on Ash

**Metal finish**  
MFW White (Standard). Optional metal finishes are available, see options.

## 3 Combination Fabrics

[View finish details](#)

Combination  
Fabric Option  
Not Available

# Roki.

Stool  
*Upholstered Counter Height Stool*

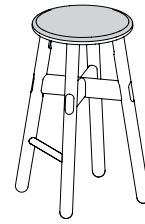

[View statement of line](#)

## Product features.

- 5/8" thick upholstered seat cushion
- 1" Adjustable felt glides for hard surface flooring
- Metal in standard MFW White
- Solid Ash (standard), optional Solid Walnut
- Ships assembled

### NOTES

- All veneer finishes are 5% matte sheen

## Options.

### PREMIUM METAL FINISHES

- Specify Leg Cap Metal Finish Color. MFMB: Matte Black, MFS: Silver, MFSS: Salmon Sienna, MFSA: Surfin Aquavert, MFPS: Pistachio, MFOS: Oyster, MFNA: Navy, MFOL: Olive, MFGB: Grey Beige MFGG: Graphite Gray, MFG: Gray - \$55
- MFC: Copper metal finish upcharge - \$260

### GLIDE OPTIONS

- PGC: Adjustable plastic glides for carpeted floors - n/c

1 model	COM	COL	1	2	3	4	5	6	7	8	9	10	11/L1	12	13/L2
ROK1926CTR11	1590	1590	1609	1619	1629	1639	1649	1659	1669	1679	1689	1699	1709	1719	1739
W x D x H 14 x 14 x 25			Upholstery Requirements												
Arm Height: N/A			Fabric yds: 0.5 yds Leather Sq. Ft.: 9 sqft												
Seat Height: 25.5"			Carton Weight: 30												
Inside Seat Depth: 14"															
Inside Seat Width: 14"															

## 2 Select a finish

[View finish details](#)

- WLA Lofty Ash
- WEC Ebony
- WAM Alabaster Maple
- WOW Clear Walnut on Walnut
- WEW Executive Walnut on Walnut
- WGW Gunstock Walnut on Walnut
- WBW Henna Walnut on Walnut
- WSW Smokey Walnut on Walnut
- WNW Natural Walnut on Walnut
- WSO Salted Oak on Ash
- WWP Designer White Paint on Ash

**Metal finish**  
 MFW White (Standard). Optional metal finishes are available, see options.

## 3 Combination Fabrics

[View finish details](#)

**Combination  
 Fabric Option  
 Not Available**

# Roki.

Stool  
Barstool

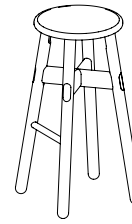

[View statement of line](#)

## Product features.

- 1" Contoured Ash (standard) or Walnut seat
- Solid Ash (standard), optional Solid Walnut
- 1" Adjustable felt glides for hard surface flooring
- Metal in standard MFW White
- Ships assembled

### NOTES

- All veneer finishes are 5% matte sheen

## Options.

### PREMIUM METAL FINISHES

- Specify Leg Cap Metal Finish Color. MFMB: Matte Black, MFS: Silver, MFSS: Salmon Sienna, MFSA: Surfin Aquavert, MFPS: Pistachio, MFOS: Oyster, MFNA: Navy, MFOL: Olive, MFGB: Grey Beige MFGG: Graphite Gray, MFG: Gray - \$55
- MFC: Copper metal finish upcharge - \$260

### GLIDE OPTIONS

- PGC: Adjustable plastic glides for carpeted floors - n/c

1 model	COM	COL	1	2	3	4	5	6	7	8	9	10	11/L1	12	13/L2
ROK2030BAR10	1415	N/A													
W x D x H 15 x 15 x 30 Arm Height: N/A Seat Height: 29.5" Inside Seat Depth: 14" Inside Seat Width: 14"			Upholstery Requirements Fabric yds: N/A Leather Sq. Ft.: N/A Carton Weight: 35												

## 2 Select a finish

[View finish details](#)

- WLA Lofty Ash
- WEC Ebony
- WAM Alabaster Maple
- WOW Clear Walnut on Walnut
- WEW Executive Walnut on Walnut
- WGW Gunstock Walnut on Walnut
- WBW Henna Walnut on Walnut
- WSW Smokey Walnut on Walnut
- WNW Natural Walnut on Walnut
- WSO Salted Oak on Ash
- WWP Designer White Paint on Ash

**Metal finish**  
MFW White (Standard). Optional metal finishes are available, see options.

## 3 Combination Fabrics

[View finish details](#)

Combination  
Fabric Option  
Not Available

# Roki.

Stool  
Upholstered Barstool

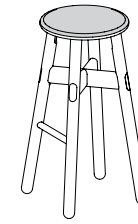

[View statement of line](#)

## Product features.

- 5/8" thick upholstered seat cushion
- 1" Adjustable felt glides for hard surface flooring
- Metal in standard MFW White
- Solid Ash (standard), optional Solid Walnut
- Ships assembled

### NOTES

- All veneer finishes are 5% matte sheen

## Options.

### PREMIUM METAL FINISHES

- Specify Leg Cap Metal Finish Color. MFMB: Matte Black, MFS: Silver, MFSS: Salmon Sienna, MFSA: Surfin Aquavert, MFPS: Pistachio, MFOS: Oyster, MFNA: Navy, MFOL: Olive, MFGB: Grey Beige MFGG: Graphite Gray, MFG: Gray - \$55
- MFC: Copper metal finish upcharge - \$260

### GLIDE OPTIONS

- PGC: Adjustable plastic glides for carpeted floors - n/c

1 model	COM	COL	1	2	3	4	5	6	7	8	9	10	11/L1	12	13/L2
ROK2030BAR11	1645	1645	1664	1674	1684	1694	1704	1714	1724	1734	1744	1754	1764	1774	1794
W x D x H 15 x 15 x 30 Arm Height: N/A Seat Height: 29.5" Inside Seat Depth: 14" Inside Seat Width: 14"			Upholstery Requirements Fabric yds: 0.5 yds Leather Sq. Ft.: 9 sqft Carton Weight: 35												

## 2 Select a finish

[View finish details](#)

- WLA Lofty Ash
- WEC Ebony
- WAM Alabaster Maple
- WOW Clear Walnut on Walnut
- WEW Executive Walnut on Walnut
- WGW Gunstock Walnut on Walnut
- WBW Henna Walnut on Walnut
- WSW Smokey Walnut on Walnut
- WNW Natural Walnut on Walnut
- WSO Salted Oak on Ash
- WWP Designer White Paint on Ash

**Metal finish**  
MFW White (Standard). Optional metal finishes are available, see options.

## 3 Combination Fabrics

[View finish details](#)

Combination  
Fabric Option  
Not Available



# Thinking quietly price list



## Thinking quietly table of contents

Statement of Line	
Features & Advantages .....	1
Finishes   Specifications .....	3
Specifications.....	4
Workbay Dimensions Specifications .....	7
Edges   Pulls   Wire management.....	16
Workstation Infill Block System .....	17
Grommet   Grommet Reference .....	19
Grain Direction .....	20
Drawer Dimensions   Fiing Reference.....	21
Workstations with Umbrellas.....	22
Workstations .....	25
Full Pedestal Credenza .....	28
Pedestals.....	29
Screens .....	31
Breif Screen .....	36
Desk Pad.....	37
Terrarium .....	38
Workbay Typicals .....	39
Workbay Modulares .....	44
Cone .....	47
Round Conference Tables.....	49
Square Conference Tables .....	50
Conference Tables.....	51
Conference Credenza .....	56
Options.....	57
Power & Data .....	63

statement of line.



PAGE 22  
Workstation With Umbrella

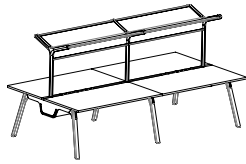

PAGE 23  
Workstation With Umbrella



PAGE 24  
Workstation With Umbrella



PAGE 25  
Workstation



PAGE 26  
Workstation



PAGE 27  
Workstation

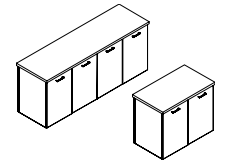

PAGE 28  
Full Pedestal Credenzas

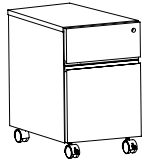

PAGE 29  
Pedestals

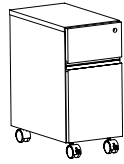

PAGE 30  
Pedestals

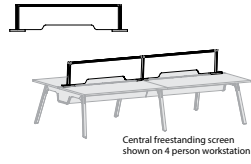

PAGE 31  
Screens

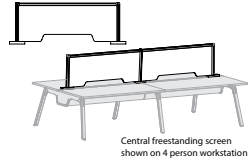

PAGE 32  
Acrylic Screens

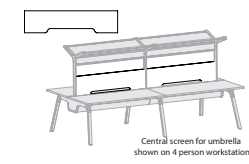

PAGE 33  
Screens

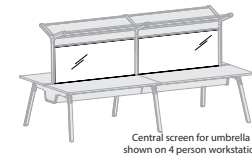

PAGE 34  
Acrylic Screens

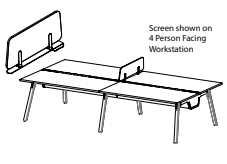

PAGE 35  
Interpersonal Screen

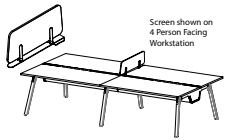

PAGE 36  
Interpersonal Screen

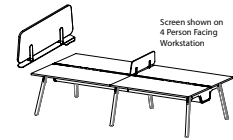

PAGE 37  
Interpersonal Screen

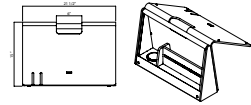

PAGE 38  
Brief Screen

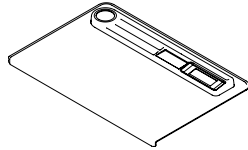

PAGE 39  
Desk Pad

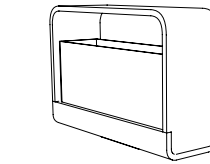

PAGE 40  
Terrarium

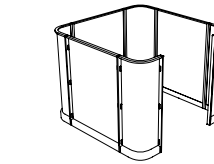

PAGE 41  
Workbay Typical

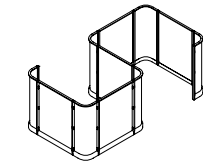

PAGE 42  
Workbay Typical

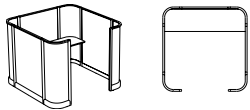

PAGE 43  
Workbay Typical

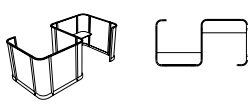

PAGE 44  
Workbay Typical

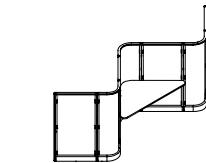

PAGE 45  
Workbay Typical



PAGE 46  
Workbay Modular

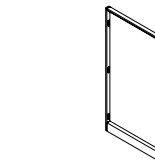

PAGE 47  
Workbay Modular

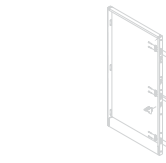

PAGE 48  
Workbay Modular

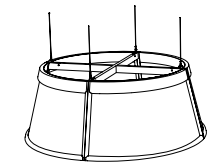

PAGE 49  
Meeting Space

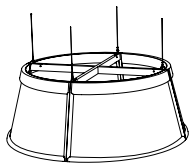

PAGE 50  
Meeting Space



PAGE 51  
Conference Tables

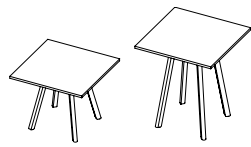

PAGE 52  
Conference Tables

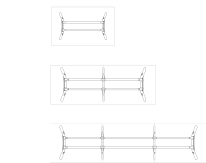

PAGE 53  
Conference Tables

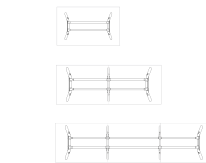

PAGE 54  
Conference Tables

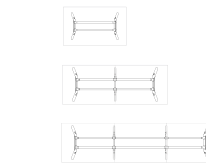

PAGE 55  
Conference Tables

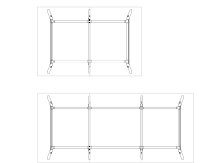

PAGE 56  
Conference Tables

statement of line.



PAGE 57  
Conference Tables

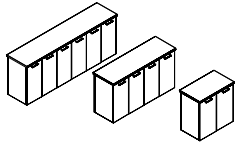

PAGE 58  
Full Pedestal Credenzas

## Thinking quietly features & advantages

### Veneer

DARRAN only uses HPVA AA Grade Flat Cut Cherry and Maple, and AA Grade Quartered Oak Veneers. All veneers are selected and matched for balance and consistency.

### Veneer tops

Thinking quietly veneer tops feature a 45-pound density substrate with balanced 3-ply construction. Tops are 1" thick on MDF core comprised of 100% recycled and recovered wood fibers. All veneer tops are slipmatched and feature a 3mm external solid hardwood band or profile edge.

Laminate tops

### Laminate tops

Thinking quietly high-pressure laminate tops feature a 45-pound density substrate with balanced 3-ply construction. Tops are 1" thick on MDF core comprised of 100% recycled and recovered wood fibers. All high pressure laminate tops are available with a profile edge, laminate self-edge or 2mm PVC edge band. Laminates in wood grain patterns feature a fine grain texture that features the polish and luxe of a real wood veneer with a subtle narrow grain structure.

### TFL tops

Thermally Fused Laminate tops feature a 45-pound density substrate with balanced 3-ply construction. Tops are 1" thick on MDF core that is comprised of 100% recycled and recovered wood fibers. All Thermally Fused Laminate tops are available with a 2mm flat PVC band. Laminates in wood grain patterns feature Timberline Texture providing the grain pattern of wood.

## Cleaning wood & laminate

In addition to regular dusting, give your furniture an occasional cleaning in accordance with our cleaning instructions. DARRAN wood and laminate products can be cleaned with a soft cloth and a mild soap and water mixture. Use approximately 32 oz of water mixed with one tablespoon of dish soap, always wiping with the grain. Dry with a soft cloth, going with the grain, to avoid spotting or streaking.

Wood products should be waxed periodically using a non-wax liquid; please do not use any waxy polish or cleaner. Interior of drawers may also be cleaned with mild soap and water mixture, or any household cleaner that is not petroleum or thinner-based.

## Chassis & pedestal

Chassis components are  $\frac{3}{4}$ " thick core of particle board or MDF rated EPP/SCS/CARB-

II material with 3-ply balanced construction. Pedestal and Cabinets feature dowel construction reinforced with steel bracket plates, wood cleats, screws and glue. All units are standard with 1" adjustable glides that allow for leveling of units that are secured in solid wood glide blocks to prevent tearout.

## Adjustable glides

Glides provide 1" of vertical leveling adjustment. Glide bottom is durable metal. Glides are secured in solid wood blocks that are screwed and glued for durability.

## Drawers

All drawers are constructed with mitre joint/dowel construction in a natural maple finish with four sides and a bottom, which are attached to a drawer front with screws for easy removal. Drawer fronts are vertically matched in balanced sets. Pencil trays are standard in all box drawers. Drawers are constructed of 1/2" thick wood grained wrapped 5 sided miter-folded construction with 1/4" thick hardboard bottoms reinforced for heavy weight capacity. Drawers have been tested and pass BIFMA 50,000 cycle test. All drawers are guaranteed lifetime with free replacement warranty.

## Drawer fronts

Drawer fronts are vertically matched in balanced sets.

## Optional wood drawers

Optional hardwood veneer plywood drawers feature banded top and bottom edges for smoothness. Drawers are dowel joint construction with a UV cured finish over maple veneers, plus a lifetime free replacement guarantee. Optional Wood Drawer (Any Size) – Option Code

## Suspensions

All casegoods utilize cold rolled steel zinc plated high-grade drawer suspensions. All suspensions are warranted for the lifetime of the product. Box and File drawers are full extension, featuring steel ball bearings for a smoother quieter range of motion and are rated 100lbs. Lateral file drawers are a progressive action full extension suspension and is rated at 150lbs. Veneer and High Pressure laminate casegoods feature soft close suspension. Thermally Fused Laminate casegoods feature standard suspensions. Lateral files include anti tip mechanism that allow only one drawer to be opened at a time.

## Filing

Thinking quietly features a highly durable black plastic extrusion that is securely fastened into a route on top of the drawer to support hanging files. An adjustable crossbar is provided for all file drawers that enables legal/letter filing front to back or side-to-side based on the drawer size.

## Thinking quietly features & advantages

### Locks

Locks are Standard on all drawers below the worksurface. Random lock cores are installed at the factory. Some units may be shipped with the same key number. Locks are Silver, Black or Bronze and match pull finish unless otherwise specified.

DARRAN will also send lock cores separately to the dealer at your request. These units will be send with an empty lock core and the Dealer will receive a shipment of the requested lock core/keys.

### Keying

Keying is available either factory or field installed. Factory installed keying is random.

### Grommets

Metal grommets are provided to match the drawer pull selection. Grommet is available in black, silver or white. Must specify standard or non-standard location. Black plastic grommets are available as an option for vertical applications.

### Wire management

Wire management capabilities include standard and optional worksurface grommets. Specify W21 under surface wire channels for organization and management of all communication wires and cords. Sold separately to conceal wire under worksurfaces.

### Infill blocks

Wire management for worksurface clamp mount power is concealed by central infill blocks that drop wires to a cable management tray.

### Cable trays

The cable tray is constructed of acoustical material concealing power and data, while reducing floor level noise.

### Powerports

A large selection of power pods are available and handle power, data, docking stations and communication. See options section for selection.

### LED tasklights

LED task lighting provides high efficiency, low energy lighting with a long life. Recessed light is encased in silver aluminum channel with milk lense and rounded end caps. Lights are factory installed. Product specifications listed below:

- Diffuser creates a softer light and eliminates hot spots
- Touch dimmer switch
- Can be "daisy chained" up to 90W
- 4.6 watts per foot
- 120 LEDs per meter
- Certification: UL Listed
- 50,000 hour life span.

Color Temp is 4000K

## Thinking quietly finishes | specifications

STANDARD VENEER	PREMIUM VENEER	HIGH PRESSURE LAMINATE	THERMALLY FUSED LAMINATE
WEC Ebony on Cherry .....	N/A .....	GEC Ebony .....	MEC Ebony
WAM Alabaster Maple.....	N/A.....	GAM Alabaster Maple .....	N/A
WSO Salted Oak .....	N/A.....	N/A.....	N/A
WWP Designer White Paint.....	N/A.....	GWL Designer White .....	MWL Designer White

\*WSO Salted Oak and WEC Ebony Features matte 5% sheen. All other finishes are 40% sheen

HPL TOPS ON TFL PRODUCTS Add 10% - Available with flat edge only

Send 3x3 or larger finish chip for color match. Custom finish upcharge is 3% or \$250 Net (whichever is greater).

### Finish

ENVI-CT Green Certified European Technology Coatings  
Finish.

## Thinking quietly specifications



## Thinking quietly design

Designed by Thinking Works Design Studio

In a lively setting, Thinking quietly's range of acoustic furniture turns the volume down on peripheral sound. Acoustic engineers assisted in the design process of this collection that focuses on reducing external noise. Sound comfort with a 21st Century design fits perfectly in the modern office!

Acoustic Engineers used acoustic modeling software to determine that a Thinking quietly 4-Pack with the acoustic umbrella, screens, and desk pads has up to a 44% improvement over a standard open plan station with screens.



## Scope

2, 4, and 6 pack workstations with 54", 60", 66", and 72" tops. Conference room settings offering 29" heights with wood or laminate. Available in round, square, and rectangle shapes. Thinking quietly workstations are available with or without the umbrella. Optional front screens are available with or without umbrella. Deletion of the signature acoustic panels will reduce the effectiveness of the noise reduction.



## Thinking quietly specifications



## Thinking quietly cone design

Designed by Thinking Works Design Studio

- Only available as fixed height
- Recommended position is 5' above floor
- Solid wood frame available in Salted Oak or Ebony finish
- Metal hardware offered in Gray or Graphite Gray powdercoat
- Acoustic panels are available in Heather or Charcoal gray

## Thinking quietly specifications



## Thinking quietly workbay design

Designed by Thinking Works Design Studio

- Solid wood frame available in Salted Oak or Ebony finish
- Metal hardware offered in Gray or Graphite Gray powdercoat
- Acoustic panels are available in Heather or Charcoal gray

Thinking quietly workbay dimension specifications (c-shape)

THQ6767CS920

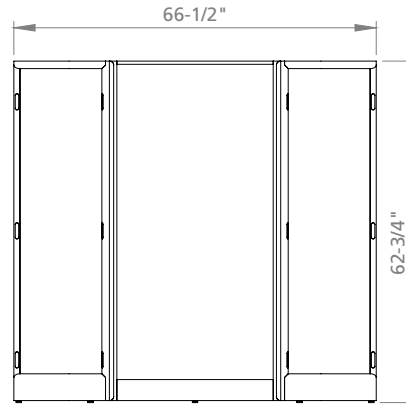
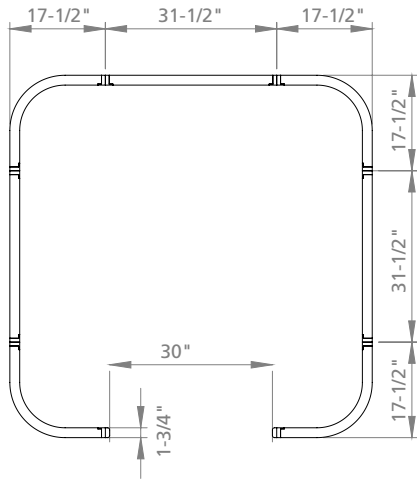

THQ8267CS920

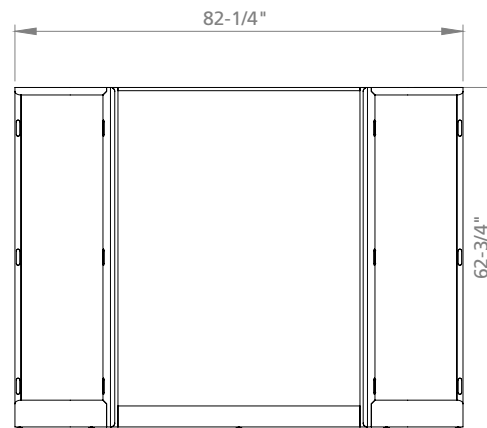
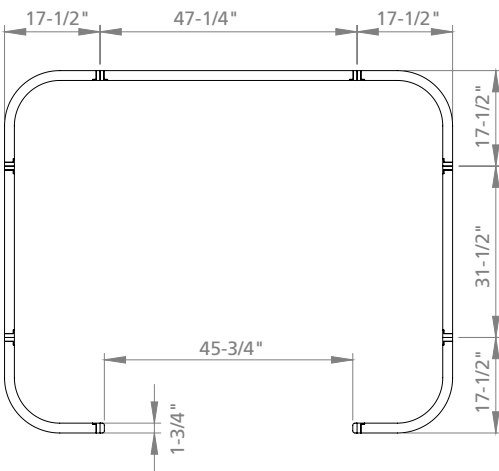

# Thinking quietly workbay dimension specifications (c-shape)

THQ8282CS920

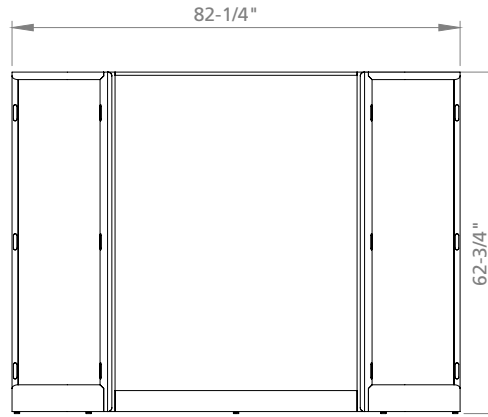
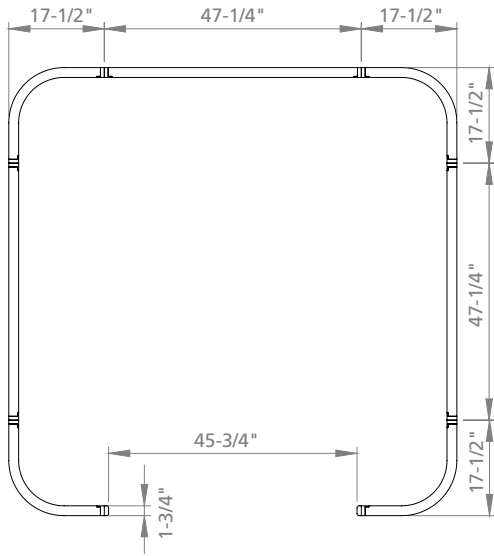

1-3/4"

Thinking quietly workbay dimension specifications (c-shape)

THQ9882CS920

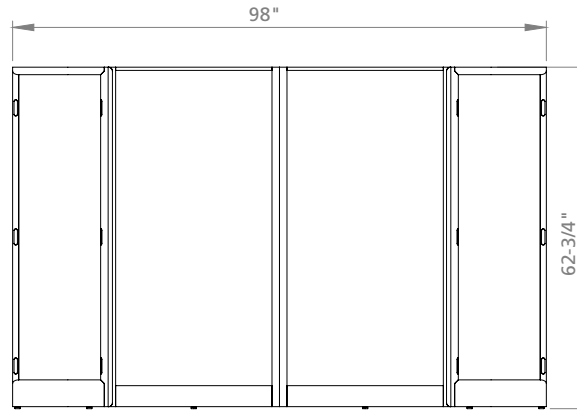
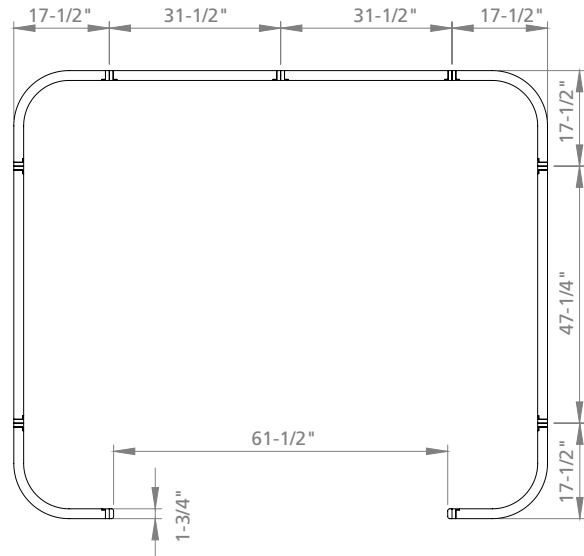

THQ9898CS920

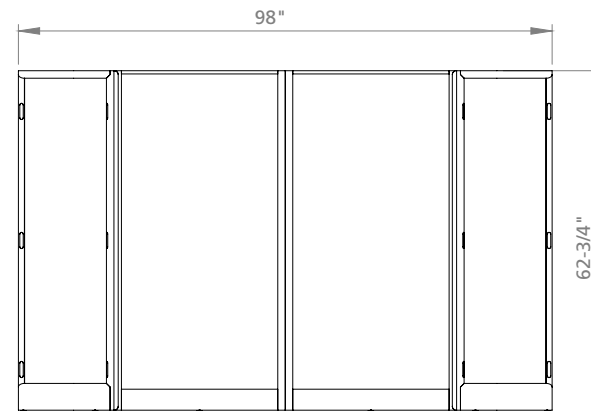
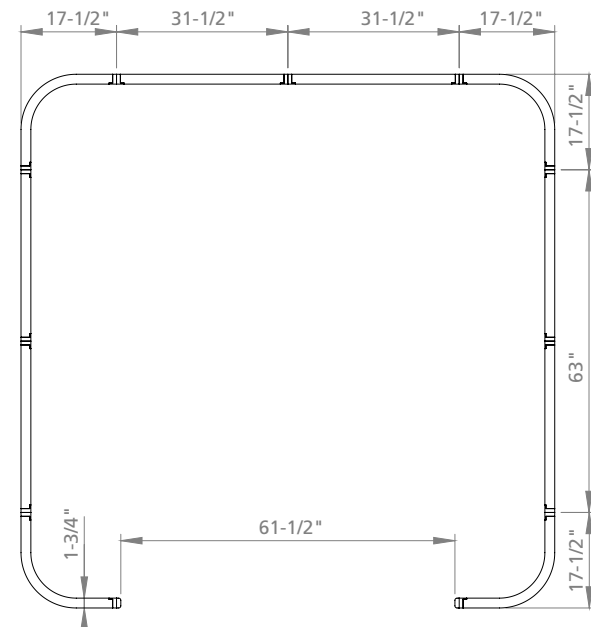

Thinking quietly workbay dimension specifications (s-shape)

THQ13267SS920

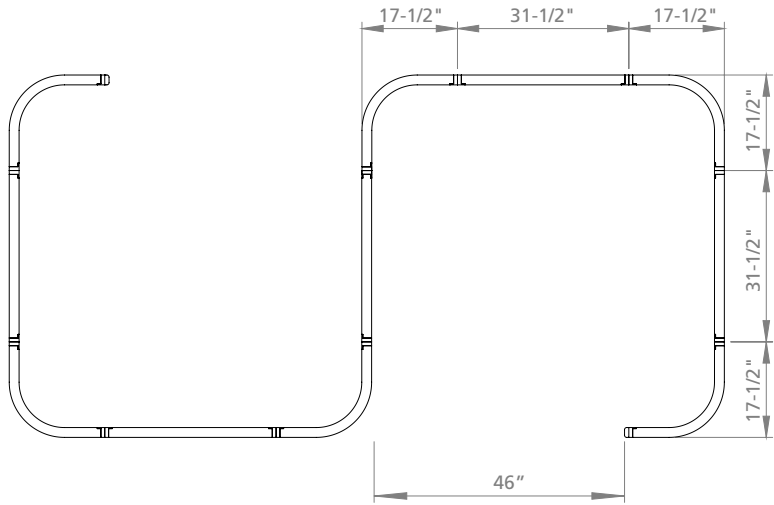

THQ16367SS920

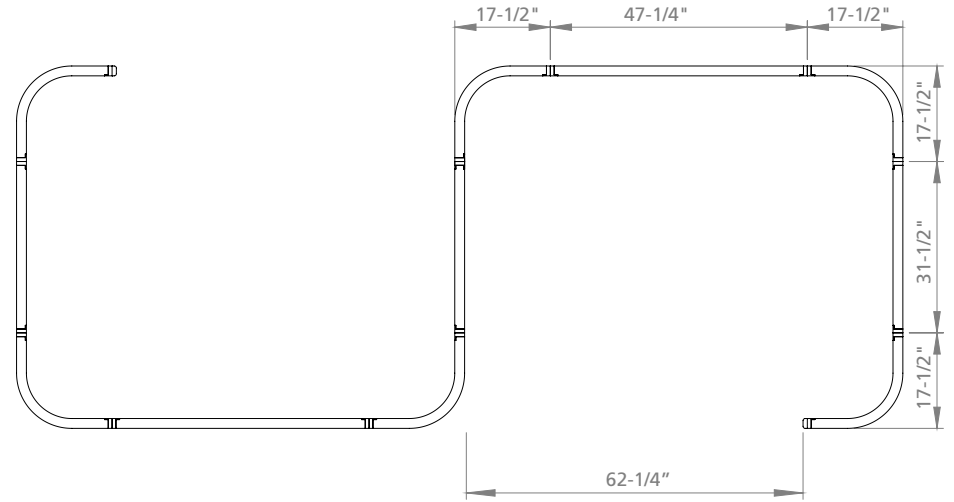

THQ16382SS920

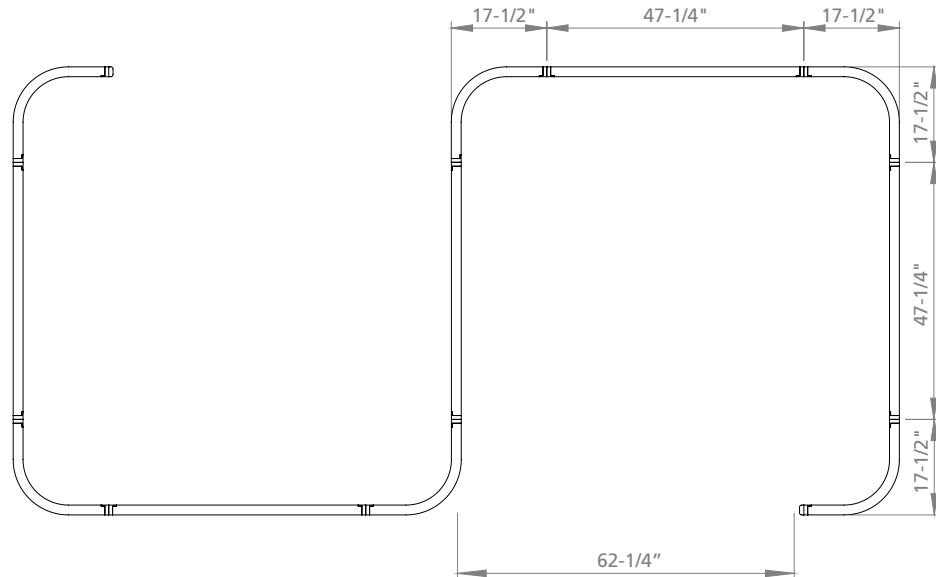

Thinking quietly workbay dimension specifications (s-shape)

THQ19482SS920

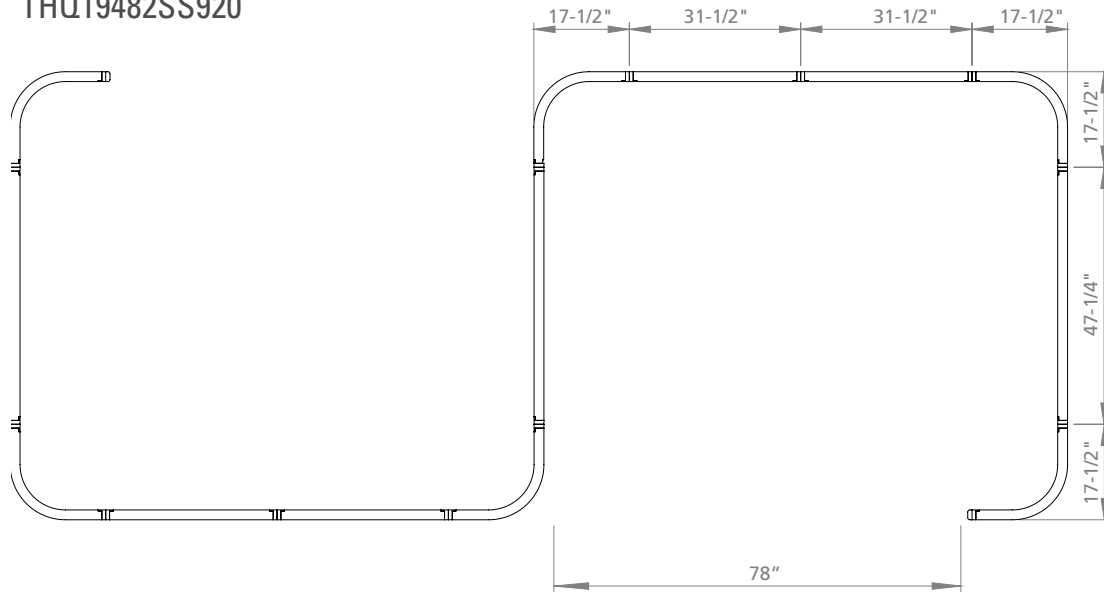

THQ19498SS920

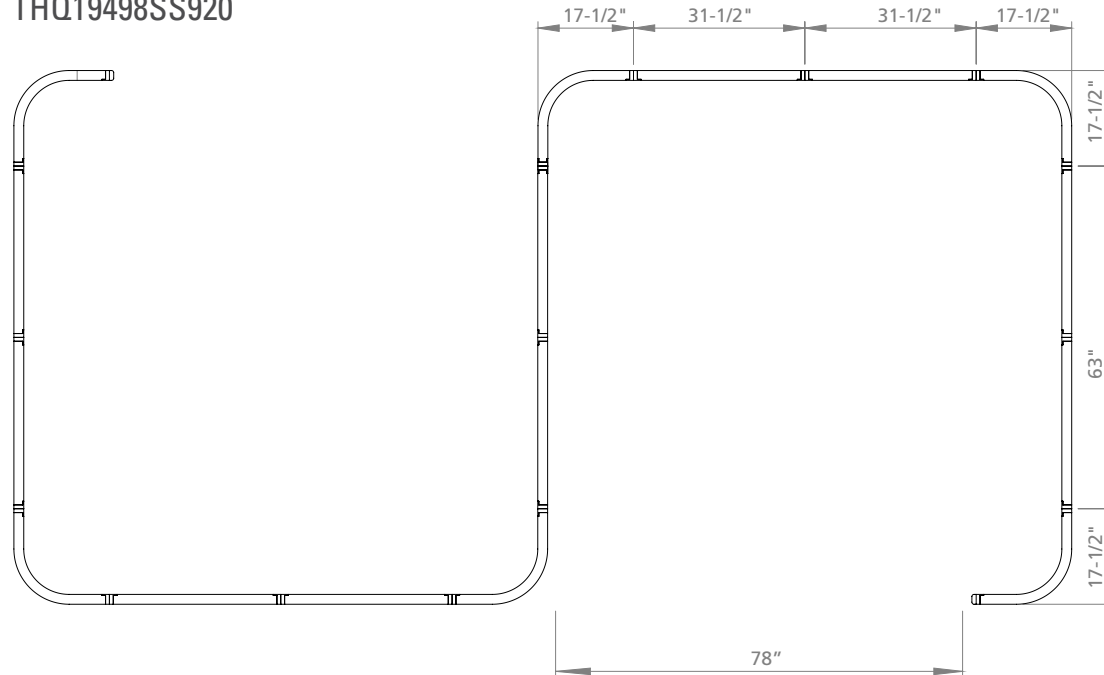

# Thinking quietly workbay dimension specifications (zig-zag)

THQ7036ZS920

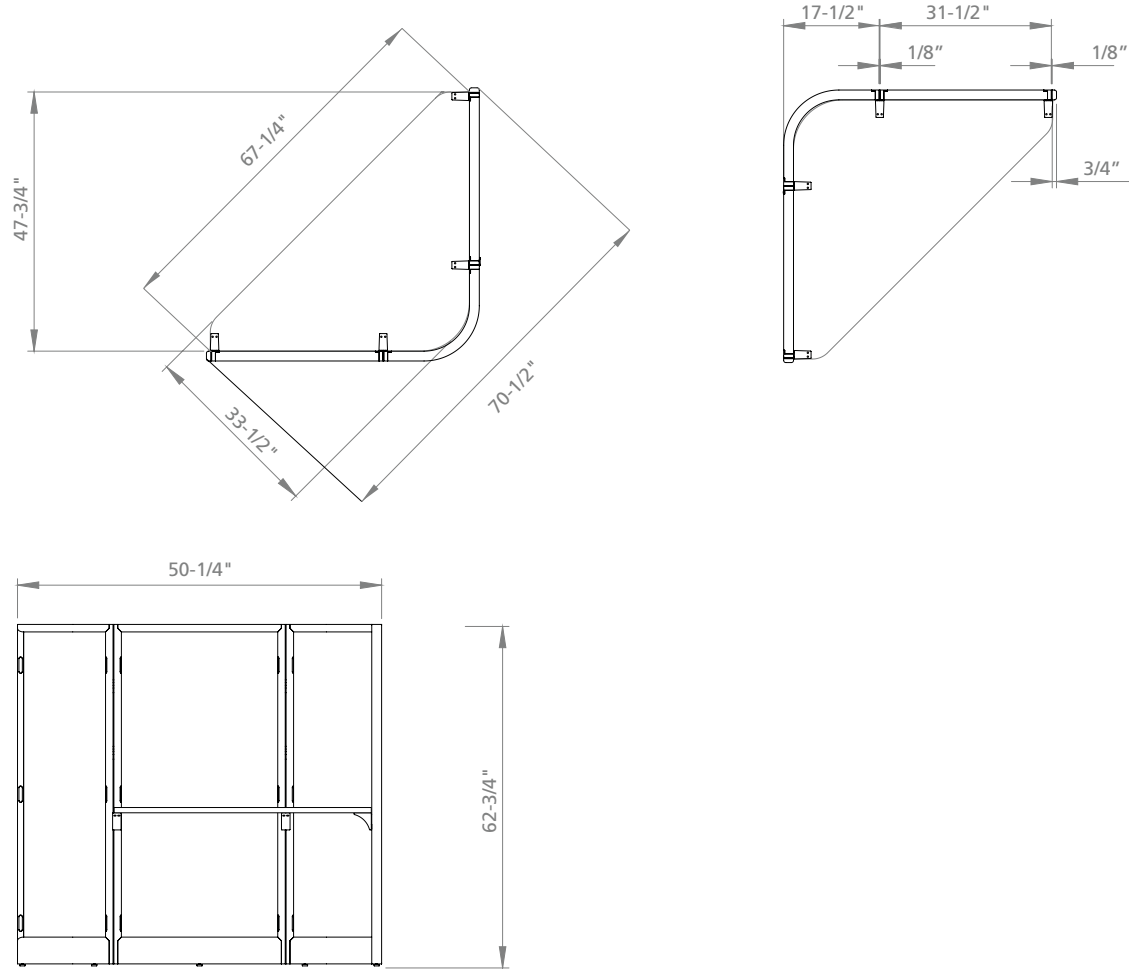



Thinking quietly workbay dimension specifications (zig-zag)  
 THQ11941ZS920

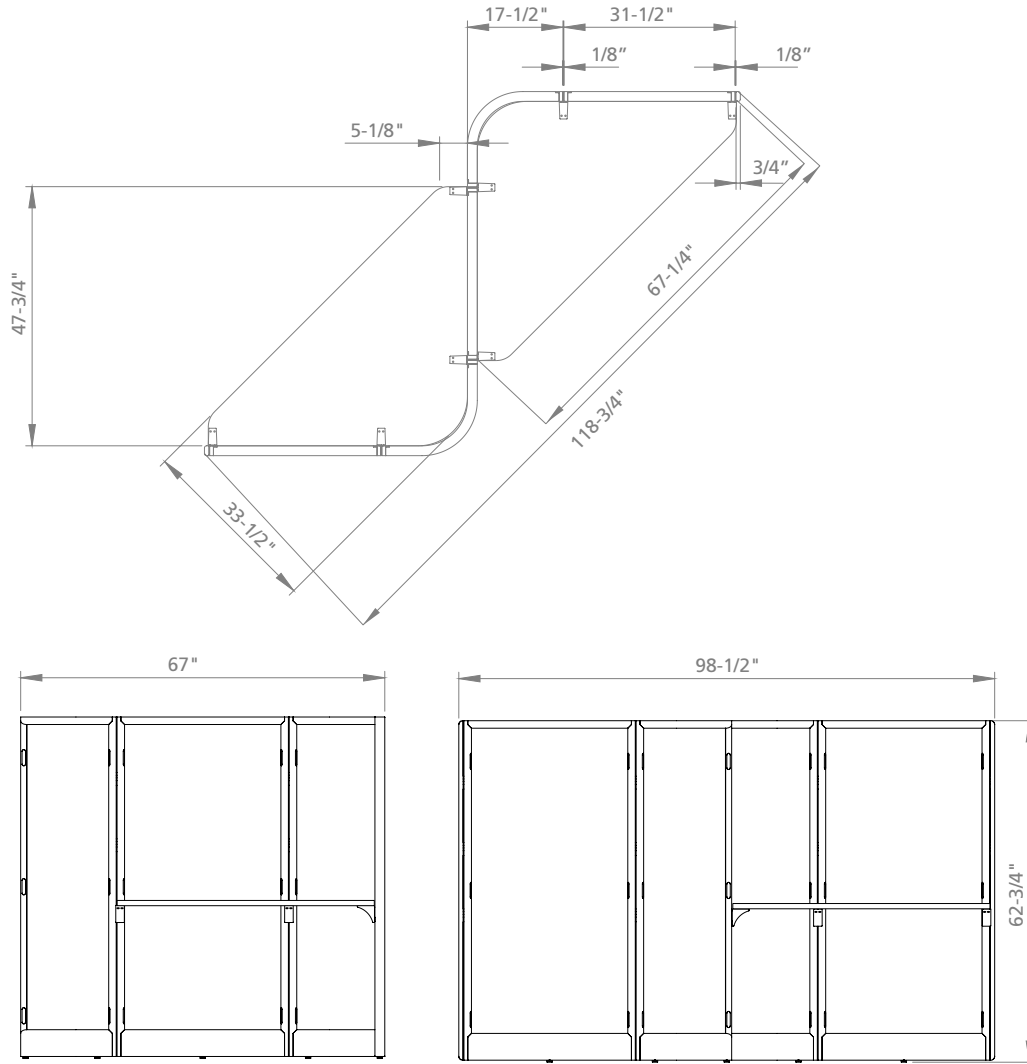

Thinking quietly workbay dimension specifications (zig-zag)  
 THQ16241ZS920

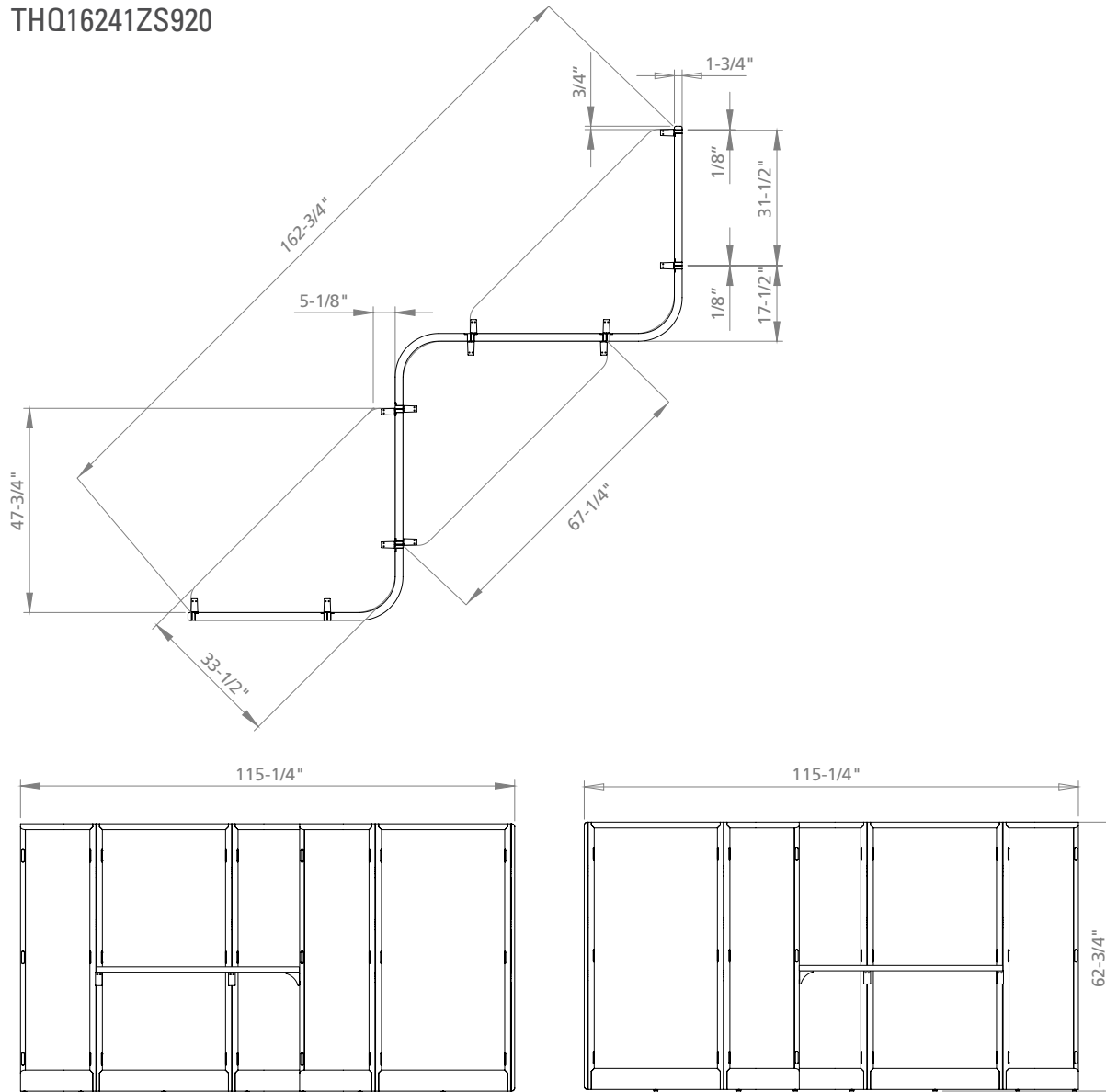

# Thinking quietly workbay dimension specifications (zig-zag)

THQ21041ZS920

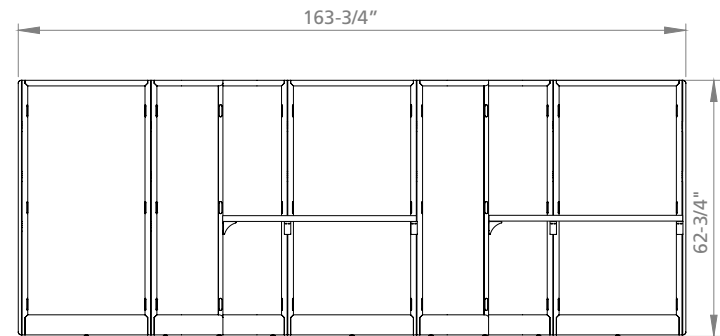
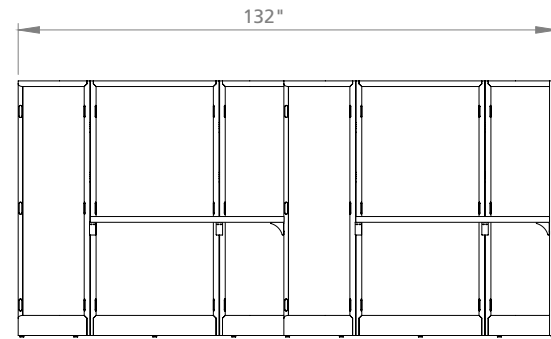
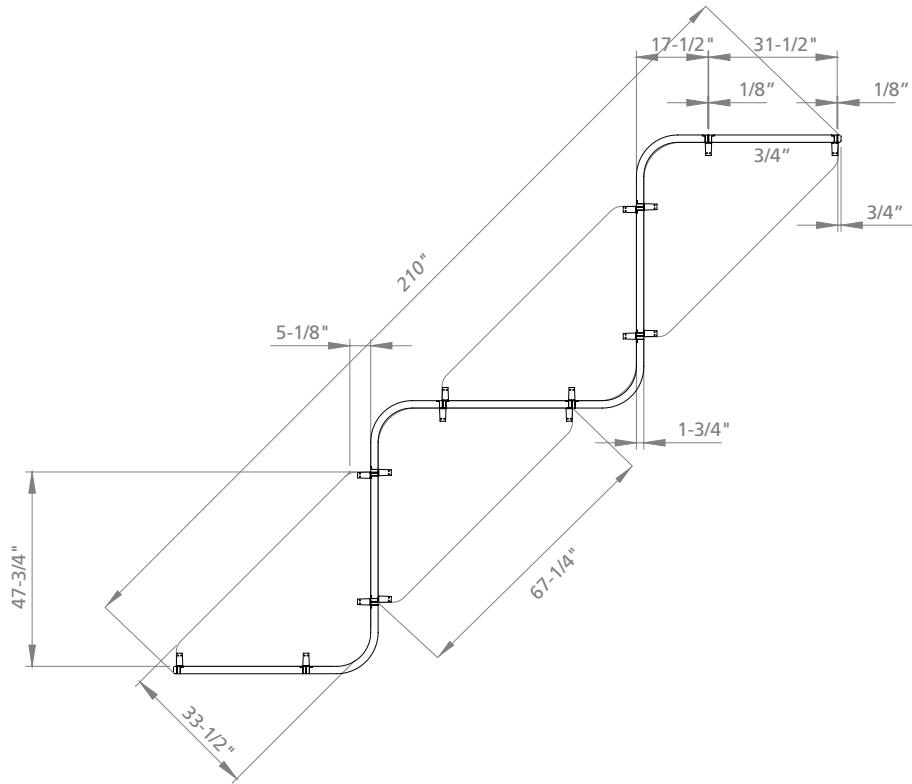

Edges | pulls

**STANDARD PROFILE**

**"W" & "G" STANDARD PROFILE**

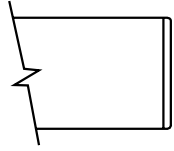

"W" "P" 3mm Hardwood Band  
"G" HPL Self Laminate Band

**Flat-1**  
"W" "G"

\*Flat-1 not available in GWL finish

**"W" "G" & "M" STANDARD PROFILE**

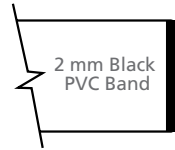

**Flat-2**  
"W" "G"

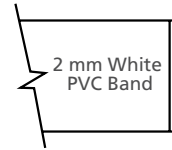

**Flat-3**  
"W" "G"

**PULLS**

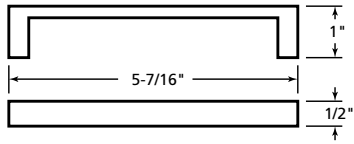

PL-115 Matte Black  
PL-116 Matte Nickel

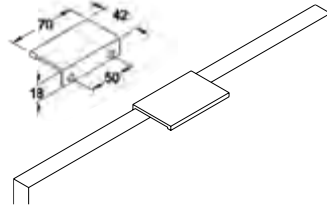

PL-260 Anodized Aluminum  
PL-261 White  
(Drawers Only)  
Optional \$15 list per pull

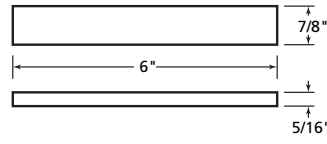

PL-210 Anodized Aluminum

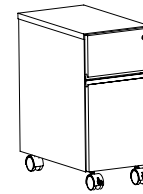

Finger Pull  
"W" "G"  
Styles Only

# Thinking quietly Workstation infill block system

## 54" WORKSURFACE INFILL PLACEMENT GUIDE

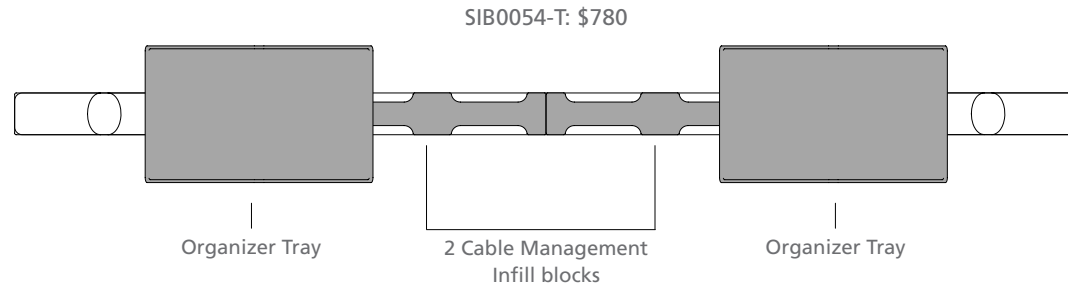
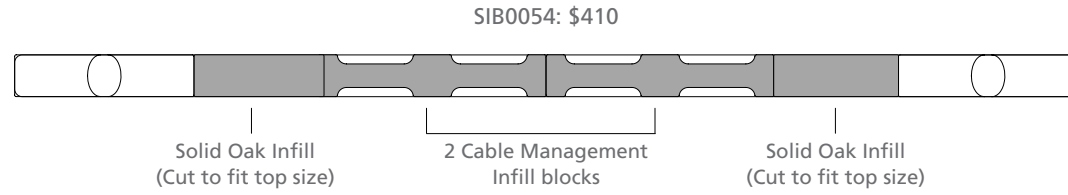

Tully Clamp Mount Power fits in the cable management infill block.  
Please reference our Thinking quietly Power Guide:  
[http://www.darran.com/assets/pricelists/power\\_Thinking quietly.pdf](http://www.darran.com/assets/pricelists/power_Thinking%20quietly.pdf)

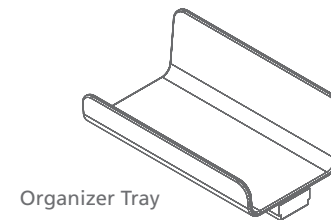

Thinking quietly Workstation infill block system  
**60", 66" & 72" WORKSURFACE INFILL PLACEMENT GUIDE**

SIB6072: \$505

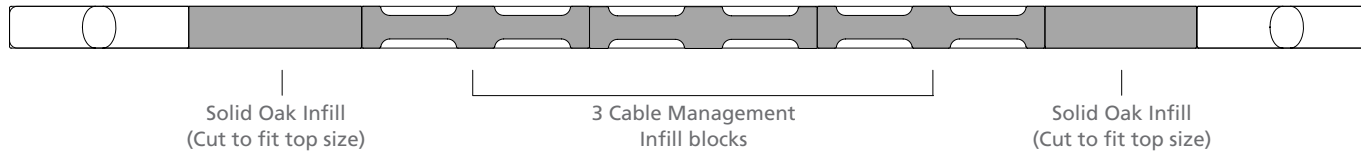

SIB6072-T: \$890

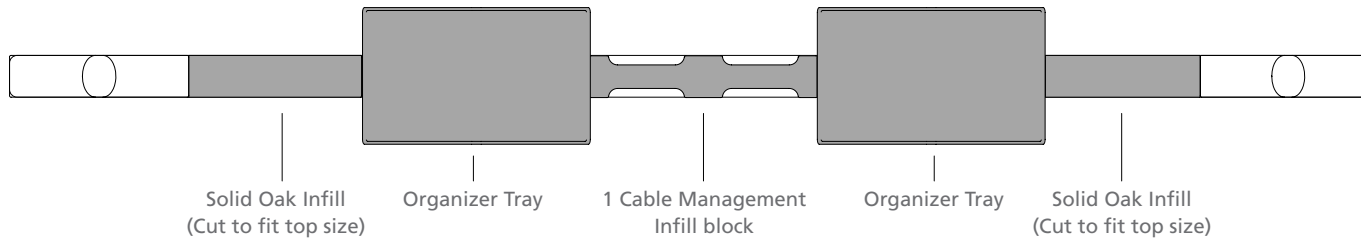

Tully Clamp Mount Power fits in the cable management infill block.  
 Please reference our Thinking quietly Power Guide:  
[http://www.darran.com/assets/pricelists/power\\_Thinking quietly.pdf](http://www.darran.com/assets/pricelists/power_Thinking quietly.pdf)

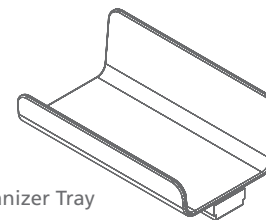

Organizer Tray

## Thinking quietly Grommets | grommet reference

TM30  
Black  
1-5/8" Dia.

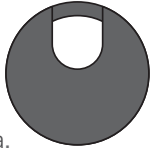

TM31  
Silver  
1-5/8" Dia.

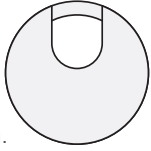

TM34  
White  
1-5/8" Dia.

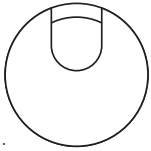

### Optional Grommets

Factory Installed

Grommets (Standard Location)

Specify Color and Left/Right/Center - \$50 ea.

- Black: TM30-R (Right), TM30-L (Left), TM30-C (Center)

- Silver: TM31-R (Right), TM31-L (Left), TM31-C (Center)

- White: TM34-R (Right), TM34-L (Left), TM34-C (Center)

Grommets (Non-Standard Location)

Provide drawing w/ Grommet Location and Specify Color - \$95 ea.

- Black: TM30-NS

- Silver: TM31-NS

- White: TM33-NS

TM50  
Black  
1-5/8" Dia.



### Grommets (Vertical Surface)

Standard Location - \$50 ea.

- Black Plastic Vertical Surface: TM50-C (Bottom Center)

Non-Standard Location - \$95 ea.

- Black Plastic Vertical Surface: TM50-NS

### CONFERENCE WIRE MANAGEMENT

Power and data cables can be discretely housed and managed. 10"W x 1.5"D x 1.25"H

W21: Grey Wire Manager (10.5") - \$35

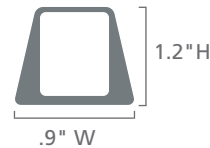
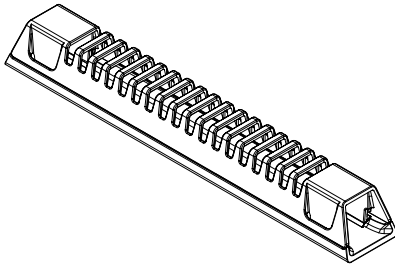

### VERTEBRAE WIRE MANAGEMENT

W22 - Vertebrae (Clear) - \$135

W23 - Vertebrae (Gray) - \$140

\*Field Installed



### Standard Grommet Location Reference



Desk

Specify Right or Left Grommet

## Thinking quietly Grain direction

Veneer chassis parts are vertical grain. The backs of Thermally Fused Laminate overheads, wall hungs, wall hung shelves and flush chassis desks are horizontal grain. Bridges, returns, and credenza kneespace Thermally Fused Laminate backs over 60" are horizontal grain. Doors feature vertical veneer bookmatched horizontally in sets of 2, 4, and 6 doors. Tower fronts are matched in vertical sets.

### GRAIN DIRECTION

#### "W" CONFERENCE

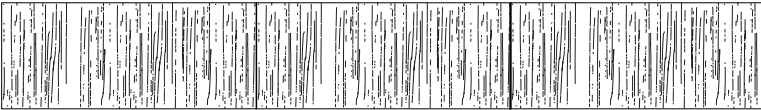
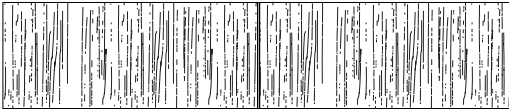

#### "G" & "M" CONFERENCE



### WORKSURFACES



Desk



# Thinking quietly Drawer dimensions | filing reference

## Interior drawer dimensions

UNIT DEPTH	DRAWER TYPE	OVERALL DIMENSIONS			INTERIOR DRAWER DIMENSIONS			NOTES
		W	D	H	W	D	H	
15-5/8" Letter	18" Box	13-1/8	16-1/16	4	12-1/8	15-1/16	3-7/16	Units less than 72"
	18" File	13-1/8	16-1/16	9-13/16	12-1/8	15-1/16	9-5/16	
	10" Box	7-1/2	16-1/16	4	6-1/2	15-1/16	3-7/16	
	10" File	7-1/2	16-1/16	9-13/16	6-1/2	15-1/16	9-5/16	

## FILING REFERENCE

### FILING FOR 18" DEPTH UNITS

13 1/8" Wide File Drawer - 16 1/16" Deep

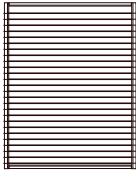

Letter Front to Back

### FILING FOR 10" DEPTH UNITS

7-1/2" Wide File Drawer - 16 1/16" Deep



Letter Side to Side

# Thinking quietly.

Workstation With Umbrella  
2 Person Facing - Umbrella

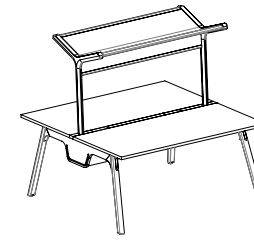

[View statement of line](#)

1 Select a model w" x d" x h"	weight	Standard Veneer Top Salted Oak Frame		Premium Veneer Top Salted Oak Frame		High Pressure Laminate Top Salted Oak Frame		Thermally Fused Laminate Top Salted Oak Frame	
		<b>Worksurface Dimensions</b>							
72 x 29 x 29	338	THQ7260WP901W	8951	"P" Option N/A		THQ7260WP901G	8578	THQ7260WP901M	8130
66 x 29 x 29	307	THQ6660WP901W	8716	"P" Option N/A		THQ6660WP901G	8354	THQ6660WP901M	7906
60 x 29 x 29	266	THQ6060WP901W	8479	"P" Option N/A		THQ6060WP901G	8130	THQ6060WP901M	7562
54 x 29 x 29	235	THQ5460WP901W	8201	"P" Option N/A		THQ5460WP901G	7862	THQ5460WP901M	7295

2 Select a finish <a href="#">View finish details</a>	Top finish		Frame finish		Top finish	Frame finish		Top finish	Frame finish	
	<a href="#">View finish details</a>	WEC	WAM	WSO		WEC +10%	GEC		GAM	WSO
Metal finish MFG Gray (standard). Premium metal finishes available, see options.	WWP	WSO			GWL			MWL		

3 Select a edge <a href="#">View edge details</a>	Flat-1 Flat-2 Flat-3 (Black) (White)			Flat-1 Flat-2 Flat-3 (Black) (White)			Flat-2 Flat-3 (Black) (White)			

4 Select acoustic color <a href="#">View hardware details</a>	SHG	SCG	SHG	SCG	SHG	SCG

## Product features.

- 2" Central trough for adding infill blocks and power
- Includes: 2 worksurfaces, 1 central cable tray, and umbrella
- 1" Thick top
- ENVI-CT Finish on wood tops
- Base and umbrella: Solid Salted Oak with Lofty Ash Inserts
- Umbrella is acoustically beneficial with it's felt material composition.
- Acoustic cable tray absorbs floor level noise

### NOTES

- 72 x 30 worksurface - 72"W x 60"D
- 66 x 30 worksurface - 66"W x 60"D
- 60 x 30 worksurface - 60"W x 60"D
- 54 x 30 worksurface - 54"W x 60"D

## Options.

### WORKSTATION INFILL

- 1SIB0054: 54" Worksurface Infill Blocks; (2) cable management infills (2) solid infills - \$410
- 1SIB0054-T: 54" Worksurface Infill Blocks; (2) cable management infills (2) organizer trays - \$780
- 1SIB6072: 60", 66" & 72" Worksurface Infill Blocks; (3) cable management infills (2) solid infills - \$505
- 1SIB6072-T: 60", 66" & 72" Worksurface Infill Blocks; (1) cable management infill (2) organizer trays (2) Solid Infills - \$890

### TASK LIGHT KIT - 2 PERSON WORKSTATION

- TQ-LED72: LED Lighting for 72" Umbrella - \$530
- TQ-LED66: LED Lighting for 66" Umbrella - \$510
- TQ-LED60: LED Lighting for 60" Umbrella - \$490
- TQ-LED54: LED Lighting for 54" Umbrella - \$470

### POWER BLOCK KIT FOR CABLE TRAY - 2 PERSON WORKSTATION

- 2PPBS: Two Pack Power Block System with either Hardwired or Power Cord - \$390
- Specify hardwired (120" cord) or plugged (72" cord)
- Includes (1) Power Block and Infeed
- Power block has 8 duplex outlets

### WORKSURFACE CLAMP MOUNT POWER

- PD-KENO: Keno power pod with clamp - \$195 ea.
- PD-TULLY: Tully power pod with clamp - \$320 ea.

### WIRE MANAGER

- W22: Vertebrae (Clear) - \$135
- W23: Vertebrae (Gray) - \$140

### PREMIUM FINISH

- WEC: Ebony finish on solid wood frame - 10% upcharge

### PREMIUM METAL FINISH

- MFGG: Graphite Gray - \$825

# Thinking quietly.

Workstation With Umbrella  
4 Person Facing - Umbrella

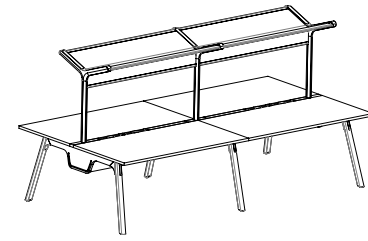

[View statement of line](#)

1 Select a model w" x d" x h"	weight	Standard Veneer Top Salted Oak Frame		Premium Veneer Top Salted Oak Frame		High Pressure Laminate Top Salted Oak Frame		Thermally Fused Laminate Top Salted Oak Frame	
		<b>Worksurface Dimensions</b>							
72 x 29 x 29	591	THQ14460WP901W	15156	"P" Option N/A	THQ14460WP901G	14409	THQ14460WP901M	13514	
66 x 29 x 29	544	THQ13260WP901W	14855	"P" Option N/A	THQ13260WP901G	14130	THQ13260WP901M	13235	
60 x 29 x 29	477	THQ12060WP901W	14551	"P" Option N/A	THQ12060WP901G	13852	THQ12060WP901M	12716	
54 x 29 x 29	430	THQ10860WP901W	14164	"P" Option N/A	THQ10860WP901G	13487	THQ10860WP901M	12351	
2 Select a finish <a href="#">View finish details</a>  Metal finish MFG Gray (standard). Premium metal finishes available, see options.	Top finish	Frame finish		Top finish	Frame finish	Top finish	Frame finish	Top finish	Frame finish
	WEC WAM WWP WSO	WSO WEC +10%		GEC GAM GWL	WSO WEC +10%	MEC MWL	WSO WEC +10%		
3 Select a edge <a href="#">View edge details</a>	Flat-1	Flat-2 (Black)	Flat-3 (White)	Flat-1	Flat-2 (Black)	Flat-3 (White)	Flat-2 (Black)	Flat-3 (White)	
4 Select acoustic color <a href="#">View hardware details</a>	SHG	SCG		SHG	SCG	SHG	SCG	SHG	SCG

## Product features.

- 2" Central trough for adding infill blocks and power
- Includes: 4 worksurfaces, 2 central cable trays, and umbrella
- 1" Thick top
- ENVI-CT Finish on wood tops
- Base and umbrella: Solid Salted Oak with Lofty Ash Inserts
- Umbrella is acoustically beneficial with it's felt material composition.
- Acoustic cable tray absorbs floor level noise

### NOTES

- 72 x 30 worksurface - 144"W x 60"D
- 66 x 30 worksurface - 132"W x 60"D
- 60 x 30 worksurface - 120"W x 60"D
- 54 x 30 worksurface - 108"W x 60"D

## Options.

### WORKSTATION INFILL

- 2SIB0054: 54" Worksurface Infill Blocks; (4) cable management infills (4) solid infills - \$815
- 2SIB0054-T: 54" Worksurface Infill Blocks; (4) cable management infills (4) organizer trays - \$1560
- 2SIB6072: 60", 66" & 72" Worksurface Infill Blocks; (6) cable management infills (4) solid infills - \$1010
- 2SIB6072-T: 60", 66" & 72" Worksurface Infill Blocks; (2) cable management infill (4) organizer trays (4) Solid Infills - \$1780

### TASK LIGHT KIT - 4 PERSON WORKSTATION

- TQ-LED72: LED Lighting for 72" Umbrella - \$1000
- TQ-LED66: LED Lighting for 66" Umbrella - \$955
- TQ-LED60: LED Lighting for 60" Umbrella - \$905
- TQ-LED54: LED Lighting for 54" Umbrella - \$860

### POWER BLOCK KIT FOR CABLE TRAY - 4 PERSON WORKSTATION

- 4PPBS: Four Pack Power Block System with either Hardwired or Power Cord - \$750
- Specify hardwired (120" cord) or plugged (72" cord)
- Includes (2) Power Blocks, (1) Jumper and Infeed
- Each power block has 8 duplex outlets

### WORKSURFACE CLAMP MOUNT POWER

- PD-KENO: Keno power pod with clamp - \$195 ea.
- PD-TULLY: Tully power pod with clamp - \$320 ea.

### WIRE MANAGER

- W22: Vertebrae (Clear) - \$135
- W23: Vertebrae (Gray) - \$140

### PREMIUM FINISH

- WEC: Ebony finish on solid wood frame - 10% upcharge

### PREMIUM METAL FINISH

- MFGG: Graphite Gray - \$1290

# Thinking quietly.

Workstation With Umbrella  
6 Person Facing - Umbrella

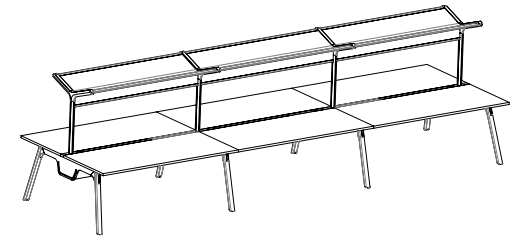

## 1 Select a model

weight

Standard Veneer Top Salted Oak Frame	Premium Veneer Top Salted Oak Frame	High Pressure Laminate Top Salted Oak Frame	Thermally Fused Laminate Top Salted Oak Frame
---	--	--	--

### Worksurface Dimensions

w" x d" x h"	weight	Standard Veneer Top Salted Oak Frame	Premium Veneer Top Salted Oak Frame
72 x 29 x 29	844	THQ21660WP901W 21508	"P" Option N/A
66 x 29 x 29	781	THQ19860WP901W 21093	"P" Option N/A
60 x 29 x 29	688	THQ18060WP901W 20672	"P" Option N/A
54 x 29 x 29	625	THQ16260WP901W 20126	"P" Option N/A

[View statement of line](#)

## 2 Select a finish

Top finish	Frame finish
WEC	WSO
WAM	WEC +10%
WWP	
WSO	

**Metal finish**  
MFG Gray (standard).  
Premium metal finishes available, see options.

Top finish	Frame finish
GEC	WSO
GAM	WEC +10%
GWL	

Top finish	Frame finish
MEC	WSO
MWL	WEC +10%

## 3 Select a edge

[View edge details](#)

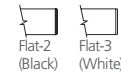

## 4 Select acoustic color

[View hardware details](#)

SHG
SCG

SHG
SCG

SHG
SCG

## Product features.

- 2" Central trough for adding infill blocks and power
- Includes: 6 worksurfaces, 3 central cable trays, and umbrella
- 1" Thick top
- ENVI-CT Finish on wood tops
- Base and umbrella: Solid Salted Oak with Lofty Ash Inserts
- Umbrella is acoustically beneficial with it's felt material composition.
- Acoustic cable tray absorbs floor level noise

### NOTES

- 72 x 30 worksurface - 216"W x 60"D
- 66 x 30 worksurface - 198"W x 60"D
- 60 x 30 worksurface - 180"W x 60"D
- 54 x 30 worksurface - 162"W x 60"D

## Options.

### WORKSTATION INFILL

- 3SIB0054: 54" Worksurface Infill Blocks; (6) cable management infills (6) solid infills - \$1220
- 3SIB0054-T: 54" Worksurface Infill Blocks; (6) cable management infills (6) organizer trays - \$2340
- 3SIB6072: 60", 66" & 72" Worksurface Infill Blocks; (9) cable management infills (6) solid infills - \$1515
- 3SIB6072-T: 60", 66" & 72" Worksurface Infill Blocks; (3) cable management infill (6) organizer trays (6) Solid Infills - \$2670

### TASK LIGHT KIT - 6 PERSON WORKSTATION

- TQ-LED72: LED Lighting for 72" Umbrella - \$1470
- TQ-LED66: LED Lighting for 66" Umbrella - \$1395
- TQ-LED60: LED Lighting for 60" Umbrella - \$1325
- TQ-LED54: LED Lighting for 54" Umbrella - \$1250

### POWER BLOCK KIT FOR CABLE TRAY - 6 PERSON WORKSTATION

- 6PPBS: Six Pack Power Block System with either Hardwired or Power Cord - \$1,100
- Specify hardwired (120" cord) or plugged (72" cord)
- Includes (3) Power Blocks, (2) Jumpers and Infeed
- Each power block has 8 duplex outlets
- Plug Infeed can be daisy chained up to 16 duplex outlets on one 20 amp circuit

### WORKSURFACE CLAMP MOUNT POWER

- PD-KENO: Keno power pod with clamp - \$195 ea.
- PD-TULLY: Tully power pod with clamp - \$320 ea.

### WIRE MANAGER

- W22: Vertebrae (Clear) - \$135
- W23: Vertebrae (Gray) - \$140

### PREMIUM FINISH

- WEC: Ebony finish on solid wood frame - 10% upcharge

### PREMIUM METAL FINISH







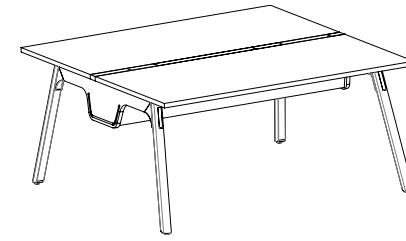

- MFGG: Graphite Gray - \$1730

# Thinking quietly.

Workstation  
2 Person Facing - No Umbrella



[View statement of line](#)

1 Select a model w" x d" x h"	weight	Standard Veneer Top Salted Oak Frame		Premium Veneer Top Salted Oak Frame		High Pressure Laminate Top Salted Oak Frame		Thermally Fused Laminate Top Salted Oak Frame		
		<b>Worksurface Dimensions</b> 72 x 29 x 29    275    THQ7260WP900W    4998    "P" Option N/A    THQ7260WP900G    4625    THQ7260WP900M    4177 66 x 29 x 29    250    THQ6660WP900W    4829    "P" Option N/A    THQ6660WP900G    4467    THQ6660WP900M    4019 60 x 29 x 29    215    THQ6060WP900W    4657    "P" Option N/A    THQ6060WP900G    4308    THQ6060WP900M    3740 54 x 29 x 29    190    THQ5460WP900W    4445    "P" Option N/A    THQ5460WP900G    4106    THQ5460WP900M    3538								
2 Select a finish <a href="#">View finish details</a>  Metal finish MFG Gray (standard). Premium metal finishes available, see options.		Top finish WEC WAM WWP WSO	Frame finish WSO WEC +10%	Top finish    Frame finish GEC            WSO GAM            WEC +10% GWL		Top finish MEC MWL	Frame finish WSO WEC +10%			
3 Select a edge <a href="#">View edge details</a>		 Flat-1  Flat-2 (Black)  Flat-3 (White)		 Flat-1  Flat-2 (Black)  Flat-3 (White)		 Flat-2 (Black)  Flat-3 (White)				
4 Select acoustic color <a href="#">View hardware details</a>		SHG SCG		SHG SCG		SHG SCG				

## Product features.

- 2" Central trough for adding infill blocks and power
- Includes: 2 worksurfaces, 1 central cable tray
- 1" Thick top
- ENVI-CT Finish on wood tops
- Base is Solid Salted Oak with Lofty Ash inserts
- Surfaces 66" and over have horizontal support rods
- Acoustic cable tray absorbs floor level noise

### NOTES

- 72 x 30 worksurface - 72"W x 60"D
- 66 x 30 worksurface - 66"W x 60"D
- 60 x 30 worksurface - 60"W x 60"D
- 54 x 30 worksurface - 54"W x 60"D

## Options.

### WORKSTATION INFILL

- 1SIB0054: 54" Worksurface Infill Blocks; (2) cable management infills (2) solid infills - \$410
- 1SIB0054-T: 54" Worksurface Infill Blocks; (2) cable management infills (2) organizer trays - \$780
- 1SIB6072: 60", 66" & 72" Worksurface Infill Blocks; (3) cable management infills (2) solid infills - \$505
- 1SIB6072-T: 60", 66" & 72" Worksurface Infill Blocks; (1) cable management infill (2) organizer trays (2) Solid Infills - \$890

### POWER BLOCK KIT FOR CABLE TRAY - 2 PERSON WORKSTATION

- 2PPBS: Two Pack Power Block System with either Hardwired or Power Cord - \$390
- Specify hardwired (120" cord) or plugged (72" cord)
- Includes (1) Power Block and Infeed
- Power block has 8 duplex outlets

### WORKSURFACE CLAMP MOUNT POWER

- PD-KENO: Keno power pod with clamp - \$195 ea.
- PD-TULLY: Tully power pod with clamp - \$320 ea.

### WIRE MANAGER

- W22: Vertebrae (Clear) - \$135
- W23: Vertebrae (Gray) - \$140

### PREMIUM FINISH

- WEC: Ebony finish on solid wood frame - 10% upcharge

### PREMIUM METAL FINISH

- MFGG: Graphite Gray - \$645

# Thinking quietly.

Workstation  
4 Person Facing - No Umbrella

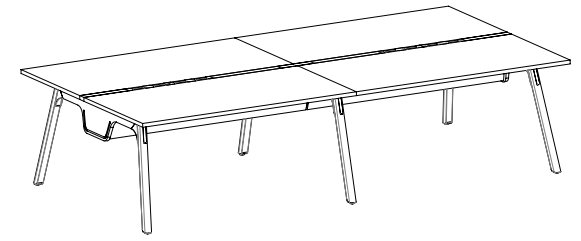

DARRAN™

1 Select a model w" x d" x h"	weight	Standard Veneer Top Salted Oak Frame		Premium Veneer Top Salted Oak Frame		High Pressure Laminate Top Salted Oak Frame		Thermally Fused Laminate Top Salted Oak Frame		
<b>Worksurface Dimensions</b>										
72 x 29 x 29	500	THQ14460WP900W	7971	"P" Option N/A		THQ14460WP900G	7224	THQ14460WP900M	6328	
66 x 29 x 29	460	THQ13260WP900W	7769	"P" Option N/A		THQ13260WP900G	7044	THQ13260WP900M	6148	
60 x 29 x 29	400	THQ12060WP900W	7562	"P" Option N/A		THQ12060WP900G	6863	THQ12060WP900M	5727	
54 x 29 x 29	360	THQ10860WP900W	7273	"P" Option N/A		THQ10860WP900G	6596	THQ10860WP900M	5460	
2 Select a finish <i>View finish details</i>	Top finish	Frame finish		Top finish	Frame finish	Top finish	Frame finish	Top finish	Frame finish	
	WEC WAM WWP WSO	WSO WEC +10%		GEC GAM GWL	WSO WEC +10%	MEC MWL	WSO WEC +10%			
Metal finish MFG Gray (standard). Premium metal finishes available, see options.										
3 Select a edge <i>View edge details</i>	Flat-1		Flat-2 (Black)		Flat-3 (White)		Flat-2 (Black)		Flat-3 (White)	
4 Select acoustic color <i>View hardware details</i>	SHG		SCG		SHG		SCG		SHG	

[View statement of line](#)

## Product features.

- 2" Central trough for adding infill blocks and power
- Includes: 4 worksurfaces, 2 central cable trays
- 1" Thick top
- ENVI-CT Finish on wood tops
- Base is Solid Salted Oak with Lofty Ash inserts
- Acoustic cable tray absorbs floor level noise

### NOTES

- 72 x 30 worksurface - 144"W x 60"D
- 66 x 30 worksurface - 132"W x 60"D
- 60 x 30 worksurface - 120"W x 60"D
- 54 x 30 worksurface - 108"W x 60"D

## Options.

### WORKSTATION INFILL

- 2SIB0054: 54" Worksurface Infill Blocks; (4) cable management infills (4) solid infills - \$815
- 2SIB0054-T: 54" Worksurface Infill Blocks; (4) cable management infills (4) organizer trays - \$1560
- 2SIB6072: 60", 66" & 72" Worksurface Infill Blocks; (6) cable management infills (4) solid infills - \$1010
- 2SIB6072-T: 60", 66" & 72" Worksurface Infill Blocks; (2) cable management infill (4) organizer trays (4) Solid Infills - \$1780

### POWER BLOCK KIT FOR CABLE TRAY - 4 PERSON WORKSTATION

- 4PPBS: Four Pack Power Block System with either Hardwired or Power Cord - \$750
- Specify hardwired (120" cord) or plugged (72" cord)
- Includes (2) Power Blocks, (1) Jumper and Infeed
- Each power block has 8 duplex outlets

### WORKSURFACE CLAMP MOUNT POWER

- PD-KENO: Keno power pod with clamp - \$195 ea.
- PD-TULLY: Tully power pod with clamp - \$320 ea.

### WIRE MANAGER

- W22: Vertebrae (Clear) - \$135
- W23: Vertebrae (Gray) - \$140

### PREMIUM FINISH

- WEC: Ebony finish on solid wood frame - 10% upcharge

### PREMIUM METAL FINISH

- MFGG: Graphite Gray - \$930

# Thinking quietly.

Workstation  
6 Person Facing - No Umbrella

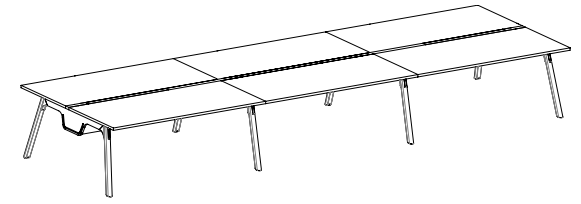

[View statement of line](#)

1 Select a model w" x d" x h"	weight	Standard Veneer Top Salted Oak Frame		Premium Veneer Top Salted Oak Frame		High Pressure Laminate Top Salted Oak Frame		Thermally Fused Laminate Top Salted Oak Frame	
		<b>Worksurface Dimensions</b>							
72 x 29 x 29	725	THQ21660WP900W	10911	"P" Option N/A		THQ21660WP900G	9790	THQ21660WP900M	8681
66 x 29 x 29	670	THQ19860WP900W	10632	"P" Option N/A		THQ19860WP900G	9544	THQ19860WP900M	8290
60 x 29 x 29	585	THQ18060WP900W	10347	"P" Option N/A		THQ18060WP900G	9299	THQ18060WP900M	7595
54 x 29 x 29	530	THQ16260WP900W	9937	"P" Option N/A		THQ16260WP900G	8922	THQ16260WP900M	7219
2 Select a finish <a href="#">View finish details</a>  Metal finish MFG Gray (standard). Premium metal finishes available, see options.	Top finish	Frame finish		Top finish	Frame finish	Top finish	Frame finish	Top finish	Frame finish
	WEC WAM WWP WSO	WSO WEC +10%		GEC GAM GWL	WSO WEC +10%	MEC MWL	WSO WEC +10%		
3 Select a edge <a href="#">View edge details</a>	Flat-1	Flat-2 (Black)	Flat-3 (White)	Flat-1	Flat-2 (Black)	Flat-3 (White)	Flat-2 (Black)	Flat-3 (White)	
4 Select acoustic color <a href="#">View hardware details</a>	SHG	SCG		SHG	SCG	SHG	SCG	SHG	SCG

## Product features.

- 2" Central trough for adding infill blocks and power
- Includes: 6 worksurfaces, 3 central cable trays
- 1" Thick top
- ENVI-CT Finish on wood tops
- Base is Solid Salted Oak with Lofty Ash inserts
- Acoustic cable tray absorbs floor level noise

### NOTES

- 72 x 30 worksurface - 216"W x 60"D
- 66 x 30 worksurface - 198"W x 60"D
- 60 x 30 worksurface - 180"W x 60"D
- 54 x 30 worksurface - 162"W x 60"D

## Options.

### WORKSTATION INFILL

- 3SIB0054: 54" Worksurface Infill Blocks; (6) cable management infills (6) solid infills - \$1220
- 3SIB0054-T: 54" Worksurface Infill Blocks; (6) cable management infills (6) organizer trays - \$2340
- 3SIB6072: 60", 66" & 72" Worksurface Infill Blocks; (9) cable management infills (6) solid infills - \$1515
- 3SIB6072-T: 60", 66" & 72" Worksurface Infill Blocks; (3) cable management infill (6) organizer trays (6) Solid Infills - \$2670

### POWER BLOCK KIT FOR CABLE TRAY - 6 PERSON WORKSTATION

- 6PPBS: Six Pack Power Block System with either Hardwired or Power Cord - \$1,100
- Specify hardwired (120" cord) or plugged (72" cord)
- Includes (3) Power Blocks, (2) Jumpers and Infeed
- Each power block has 8 duplex outlets
- Plug Infeed can be daisy chained up to 16 duplex outlets on one 20 amp circuit

### WORKSURFACE CLAMP MOUNT POWER

- PD-KENO: Keno power pod with clamp - \$195 ea.
- PD-TULLY: Tully power pod with clamp - \$320 ea.

### WIRE MANAGER

- W22: Vertebrae (Clear) - \$135
- W23: Vertebrae (Gray) - \$140

### PREMIUM FINISH

- WEC: Ebony finish on solid wood frame - 10% upcharge

### PREMIUM METAL FINISH

- MFGG: Graphite Gray - \$1290

# Thinking quietly.



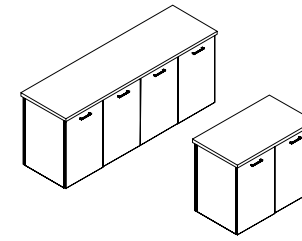













Full Pedestal Credenzas  
Storage Credenza



[View statement of line](#)

1 Select a model w" x d" x h"	weight	Standard Veneer Top Standard Veneer Chassis		Premium Veneer Top Premium Veneer Chassis		High Pressure Laminate Top High Pressure Laminate Chassis		Thermally Fused Laminate Top Thermally Fused Laminate Chassis	
		70 x 24 x 29	225	THQ7024CA125W	3702	"P" Option N/A	THQ7024CA125G	3205	THQ7024CA125M
58 x 24 x 29	195	THQ5824CA125W	3324	"P" Option N/A	THQ5824CA125G	2878	THQ5824CA125M	1851	
35 x 24 x 29	130	THQ3524CA125W	2060	"P" Option N/A	THQ3524CA125G	1784	THQ3524CA125M	1191	
29 x 24 x 29	115	THQ2924CA125W	1918	"P" Option N/A	THQ2924CA125G	1660	THQ2924CA125M	1109	

2 Select a finish <a href="#">View finish details</a>	3 Select a edge <a href="#">View edge details</a>	4 Select hardware <a href="#">View hardware details</a>
WEC WAM WWP WSO	 Flat-1  Flat-2 (Black)  Flat-3 (White)	 PL-115 Matte Black PL-116 Matte Nickel  PL-210 Anodized Aluminum  PL-260 Anodized Aluminum PL-261 White
GEC GAM GWL	 Flat-1  Flat-2 (Black)  Flat-3 (White)	 PL-115 Matte Black PL-116 Matte Nickel  PL-210 Anodized Aluminum  PL-260 Anodized Aluminum PL-261 White
MEC MWL	 Flat-2 (Black)  Flat-3 (White)	 PL-115 Matte Black PL-116 Matte Nickel  PL-210 Anodized Aluminum  PL-260 Anodized Aluminum PL-261 White

## Product features.

- Black adjustable shelf behind door set

### NOTES

- "M" Styles have matching "M" Finish Shelf
- All units are standard w/ flush ends
- Unit not designed for open plan use, standard with unfinished back. Select OPB Option for Open Plan application.

## Options.

### DOOR

- D2: Wood Door Lock - \$100 per door set
- D6: Delete doors - n/c
- D6A: "W"/"G" Styles - Delete Doors and replace black laminate shelf with finished shelf - n/c
- D9SC: Soft Close Door Hinges - \$20 per door
- WPD3061: Designer White - \$80 per door

### GROMMETS (STANDARD LOCATION)

Specify Color and Left/Right/Center - \$50 ea.

- Black: TM30-R (Right), TM30-L (Left), TM30-C (Center)
- Silver: TM31-R (Right), TM31-L (Left), TM31-C (Center)
- White: TM34-R (Right), TM34-L (Left), TM34-C (Center)

### GROMMETS (NON-STANDARD LOCATION)

Provide drawing w/ Grommet Location and Specify Color - \$95 ea.

- Black: TM30-NS
- Silver: TM31-NS
- White: TM34-NS

### GROMMETS (VERTICAL SURFACE)

Standard Location - \$50 ea.

- Black Plastic Vertical Surface: TM50-C (Bottom Center)

Non-Standard Location - \$95 ea.

- Black Plastic Vertical Surface: TM50-NS

### OPEN PLAN – FINISHED BACK

- OPB: "W" "G" Style - Modify Unit for Open Plan Application - \$195
- OPB: "M" Style - Modify Unit for Open Plan Application - \$95

### SHELF

- S25: Replace Black Laminate Shelf with Finished Shelf - \$80 per shelf ("W" styles only)



# Thinking quietly.

Pedestals

Open Plan Mobile Desk Pedestal With Casters

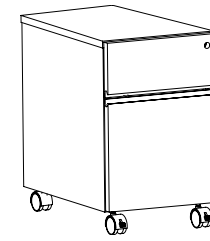

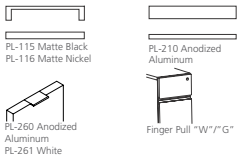
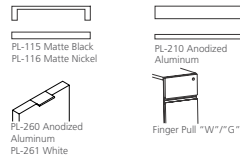
1 Select a model w" x d" x h"	weight	Standard Veneer Top Standard Veneer Chassis		Premium Veneer Top Premium Veneer Chassis		High Pressure Laminate Top High Pressure Laminate Chassis		Thermally Fused Laminate Top Thermally Fused Laminate Chassis	
		Box/File Pedestal 16 x 18 x 22	55	THQ1618PD423W	1322	"P" Option N/A	"G" Option N/A		
2 Select a finish <i>View finish details</i>		WEC WAM WWP WSO						MEC MWL	
3 Select a edge <i>View edge details</i>		Edge N/A						Edge N/A	
4 Select hardware <i>View hardware details</i>									

*View statement of line*

## Product features.

- Anti-tilt safety feature
- Finished all sides and top - open plan
- Full extension drawers - locking
- 3" White hollow wheel caster

## Options.

### CUSHION

- BC16: Bench Cushion
- Specify fabric grade (1 yd. required)

### DRAWER

- P33: Wood Drawer Upgrade - \$45 per drawer

## BC16 Cushion fabric grades.

COM	COL	1	2	3
224	N/A	261	279	297
4	5	6	7	8
315	333	351	369	387
9	10	11/ L1	12	13/ L2
405	423	441	459	495

# Thinking quietly.

Pedestals

Open Plan Mini Mobile Desk Pedestal With Casters

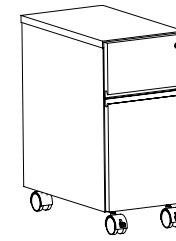

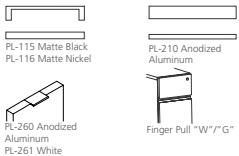
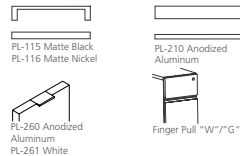
1 Select a model w" x d" x h"	weight	Standard Veneer Top Standard Veneer Chassis		Premium Veneer Top Premium Veneer Chassis		High Pressure Laminate Top High Pressure Laminate Chassis		Thermally Fused Laminate Top Thermally Fused Laminate Chassis	
		Box/File Mini Pedestal 10 x 18 x 22	40	THQ1018PD423W	1256	"P" Option N/A	"G" Option N/A		
2 Select a finish <i>View finish details</i>		WEC WAM WWP WSO						MEC MWL	
3 Select a edge <i>View edge details</i>		Edge N/A						Edge N/A	
4 Select hardware <i>View hardware details</i>									

*View statement of line*

## Product features.

- Anti-tilt safety feature
- Finished all sides and top - open plan
- Full extension drawers - locking
- 3" White hollow wheel caster

## Options.

- CUSHION**
- BC10: Bench Cushion
  - Specify fabric grade (.5 yd. required)

- DRAWER**
- P33: Wood Drawer Upgrade - \$45 per drawer

## BC10 Cushion fabric grades.

COM	COL	1	2	3
203	N/A	240	258	276
4	5	6	7	8
294	312	330	348	366
9	10	11/ L1	12	13/ L2
384	402	420	438	474

# Thinking quietly.

Screens

Central Freestanding Screen With Wood Posts

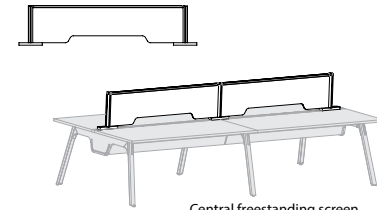

Central freestanding screen shown on 4 person workstation

[View statement of line](#)

1 Select a model w" x d" x h"	weight	Salted Oak Frame Heather Gray		
<b>6 Person Workstation/3 Central Screens</b>				
216 x .5 x 15	80	THQ21615PS601	2610	
198 x .5 x 15	70	THQ19815PS601	2545	
180 x .5 x 15	60	THQ18015PS601	2479	
162 x .5 x 15	50	THQ16215PS601	2414	
<b>4 Person Workstation/2 Central Screens</b>				
144 x .5 x 15	65	THQ14415PS601	1868	
132 x .5 x 15	55	THQ13215PS601	1813	
120 x .5 x 15	45	THQ12015PS601	1759	
108 x .5 x 15	35	THQ10815PS601	1704	
<b>2 Person Workstation/1 Central Screen</b>				
72 x .5 x 15	50	THQ7215PS601	1152	
66 x .5 x 15	40	THQ6615PS601	1125	
60 x .5 x 15	30	THQ6015PS601	1097	
54 x .5 x 15	20	THQ5415PS601	1070	

2 Select a finish	Frame finish
<a href="#">View finish details</a>	WSO
	WEC +10%
<b>Metal finish</b>	
MFG Gray (standard). Premium metal finishes available, see options.	

3 Select a edge	Edge
<a href="#">View edge details</a>	N/A

4 Select acoustic color	
<a href="#">View hardware details</a>	SHG
	SCG

## Product features.

- Available for 2/4/6 Person workstations without Umbrella
- Made from sound absorbing acoustic material
- Wood posts finished in Salted Oak

## Options.

### PREMIUM FINISH

- WEC: Ebony finish on solid wood frame - 10% upcharge

### PREMIUM METAL FINISH

- 6 Person Workstation
- MFGG: Graphite Gray - \$300
- 4 Person Workstation
- MFGG: Graphite Gray - \$240
- 2 Person Workstation
- MFGG: Graphite Gray - \$185

# Thinking quietly.

Acrylic Screens

Central Freestanding Screen With Wood Posts

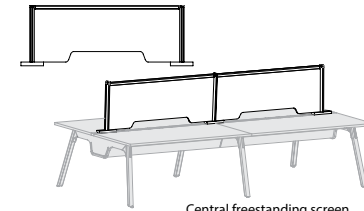

Central freestanding screen shown on 4 person workstation

[View statement of line](#)

1 Select a model w" x d" x h"	weight	Salted Oak Frame		Salted Oak Frame		Salted Oak Frame	
		Frosted Acrylic Screen		White Acrylic Screen		Black Acrylic Screen	
<b>6 Person Workstation/3 Central Screens</b>							
216 x .5 x 24	80	THQ21624PS597AF	3135	THQ21624PS597AW	2555	THQ21624PS597AB	2555
198 x .5 x 24	70	THQ19824PS597AF	3025	THQ19824PS597AW	2495	THQ19824PS597AB	2495
180 x .5 x 24	60	THQ18024PS597AF	2915	THQ18024PS597AW	2435	THQ18024PS597AB	2435
162 x .5 x 24	50	THQ16224PS597AF	2805	THQ16224PS597AW	2375	THQ16224PS597AB	2375
<b>4 Person Workstation/2 Central Screens</b>							
144 x .5 x 24	65	THQ14424PS597AF	2215	THQ14424PS597AW	1835	THQ14424PS597AB	1835
132 x .5 x 24	55	THQ13224PS597AF	2145	THQ13224PS597AW	1795	THQ13224PS597AB	1795
120 x .5 x 24	45	THQ12024PS597AF	2075	THQ12024PS597AW	1755	THQ12024PS597AB	1755
108 x .5 x 24	35	THQ10824PS597AF	2005	THQ10824PS597AW	1715	THQ10824PS597AB	1715
<b>2 Person Workstation/1 Central Screen</b>							
72 x .5 x 24	50	THQ7224PS597AF	1315	THQ7224PS597AW	1115	THQ7224PS597AB	1115
66 x .5 x 24	40	THQ6624PS597AF	1275	THQ6624PS597AW	1095	THQ6624PS597AB	1095
60 x .5 x 24	30	THQ6024PS597AF	1235	THQ6024PS597AW	1065	THQ6024PS597AB	1065
54 x .5 x 24	20	THQ5424PS597AF	1195	THQ5424PS597AW	1045	THQ5424PS597AB	1045
2 Select a finish		Frame finish		Frame finish		Frame finish	
WSO		WSO		WSO		WSO	
<a href="#">View finish details</a>		WEC +10%		WEC +10%		WEC +10%	
Metal finish							
MFG Gray (standard).							
Premium metal finishes available, see options.							
3 Select a edge		Edge		Edge		Edge	
<a href="#">View edge details</a>		N/A		N/A		N/A	
4 Select acoustic color		Acoustic		Acoustic		Acoustic	
<a href="#">View hardware details</a>		N/A		N/A		N/A	

## Product features.

- Available for 2/4/6 Person workstations without Umbrella
- Available with frosted or white acrylic
- Wood posts finished in Salted Oak

## Options.

### PREMIUM FINISH

- WEC: Ebony finish on solid wood frame - 10% upcharge

### PREMIUM METAL FINISH

- 6 Person Workstation
- MFGG: Graphite Gray - \$300
- 4 Person Workstation
- MFGG: Graphite Gray - \$240
- 2 Person Workstation
- MFGG: Graphite Gray - \$185

# Thinking quietly.

Screens

Central Screen For Umbrella

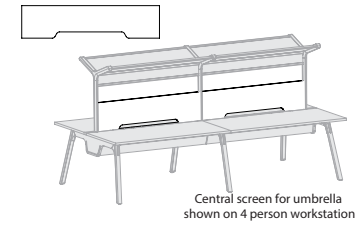

[View statement of line](#)

1 Select a model		weight	Heather Gray		
w" x d" x h"					
<b>Above Desk Umbrella Screen</b>					
<b>72" Worksurface</b>					
66 x .5 x 12	6	CS7212	470		
<b>66" Worksurface</b>					
60 x .5 x 12	6	CS6612	448		
<b>60" Worksurface</b>					
54 x .5 x 12	5	CS6012	426		
<b>54" Worksurface</b>					
48 x .5 x 12	5	CS5412	405		
2 Select a finish		MFG			
<a href="#">View finish details</a>					
Metal finish					
MFG Gray (standard).					
Premium metal finishes available, see options.					
3 Select a edge		Edge			
<a href="#">View edge details</a>		N/A			
4 Select acoustic color		SHG			
<a href="#">View hardware details</a>		SCG			

## Product features.

- Available for 2/4/6 Person workstations with Umbrella
- Made from sound absorbing acoustic material

### NOTES

- Screen is for use with umbrella workstations only

### PREMIUM METAL FINISH

- MFGG: Graphite Gray - \$185

Thinking quietly.  
Acrylic Screens  
Central Screen For Umbrella

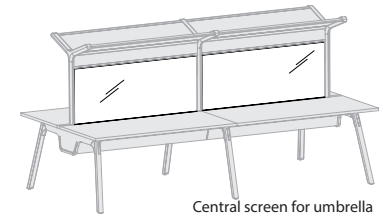

Central screen for umbrella shown on 4 person workstation

[View statement of line](#)

1 Select a model w" x d" x h"	weight	Salted Oak Frame Frosted Acrylic Screen		Salted Oak Frame White Acrylic Screen		Salted Oak Frame Black Acrylic Screen	
		<b>Above Desk Umbrella Screen</b> <b>72" Worksurface</b> 72 x .5 x 21    18    AS7221AF    655    AS7221AW    405    AS7221AB    405 66 x .5 x 21    16    AS6621AF    620    AS6621AW    425    AS6621AB    425 60 x .5 x 21    14    AS6021AF    585    AS6021AW    445    AS6021AB    445 54 x .5 x 21    12    AS5421AF    550    AS5421AW    465    AS5421AB    465					
2 Select a finish <a href="#">View finish details</a>		Frame finish WSO WEC +10%		Frame finish WSO WEC +10%		Frame finish WSO WEC +10%	
Metal finish MFG Gray (standard). Premium metal finishes available, see options.							
3 Select a edge <a href="#">View edge details</a>		Edge N/A		Edge N/A		Edge N/A	
4 Select acoustic color <a href="#">View hardware details</a>		Acoustic N/A		Acoustic N/A		Acoustic N/A	

Product features.

- Available for 2/4/6 Person workstations with Umbrella
- Available with frosted or white acrylic

NOTES

- Screen is for use with umbrella workstations only
- Screens priced per screen

Options.

**PREMIUM METAL FINISH**

MFGG: Graphite Gray. Priced per screen - \$50

# Thinking quietly.

Interpersonal Screen  
Fabric Interpersonal Screen

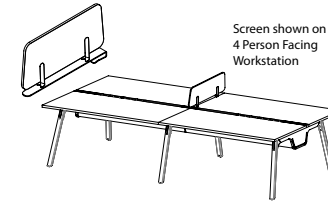

[View statement of line](#)

1	Select a model	Fabric Screen	weight	Graphite gray metal	THQ2413PS603	317
	w" x d" x h"					
	24 x .5 x 12.75		5			

2	Select a finish	MFG
	<a href="#">View finish details</a>	
	Metal finish MFG Gray (standard). Premium metal finishes available, see options.	

3	Select a edge	Edge N/A
	<a href="#">View edge details</a>	

4	Select hardware	Hardware N/A
	<a href="#">View hardware details</a>	

## Product features.

- Fabric panels are double sided with angled sides
- Panels are mounted on die cast space blocks between workstations
- Specify only one between two facing units
- Mounting brackets are gray metal finish (optional graphite gray)

### NOTES

- Central Screens are not available in leather or vinyl

## Options.

### PREMIUM METAL FINISHES

- Specify Screen Brackets Metal Finish Color: \$55
- MFGG: Graphite Gray

## Screen fabric grades.

<b>COM</b> 313	<b>COL</b> N/A	<b>1</b> 353	<b>2</b> 373	<b>3</b> 393
<b>4</b> 413	<b>5</b> 433	<b>6</b> 453	<b>7</b> 473	<b>8</b> 493
<b>9</b> 513	<b>10</b> 533	<b>11/ L1</b> 553	<b>12</b> 573	<b>13/ L2</b> 613

# Thinking quietly.

Interpersonal Screen  
Acrylic Interpersonal Screen

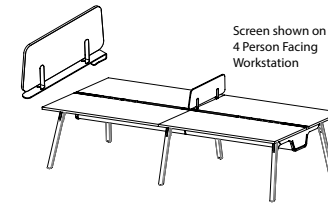

1 Select a model	weight	Acrylic Screen		
w" x d" x h"		Graphite gray metal		
24 x .5 x 12.75	5	THQ2413PS601	311	

[View statement of line](#)

2 Select a finish	MFG
<a href="#">View finish details</a>  Metal finish MFG Gray (standard). Premium metal finishes available, see options.	

3 Select a edge	Edge
<a href="#">View edge details</a>	N/A

4 Select hardware	Hardware
<a href="#">View hardware details</a>	N/A

## Product features.

- Acrylic panels are double sided with angled sides
- Acrylic panels are opaque white
- Mounting brackets are gray metal finish (optional graphite gray)

## Options.

### PREMIUM METAL FINISHES

- Specify Screen Brackets Metal Finish Color: \$55
- MFGG: Graphite Gray



# Thinking quietly.

Interpersonal Screen  
Acoustic Material Interpersonal Screen

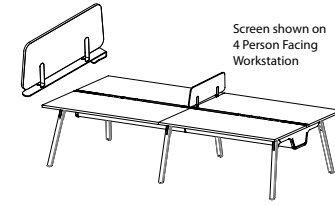

1	Select a model	weight	Acoustic Screen	
	w" x d" x h"		Graphite gray metal	
	24 x .5 x 12.75	5	THQ2413PS602	361

[View statement of line](#)

2	Select a finish	MFG
	<a href="#">View finish details</a>	
	Metal finish	
	MFG Gray (standard).	
	Premium metal finishes available, see options.	

3	Select a edge	Edge
	<a href="#">View edge details</a>	N/A

4	Select acoustic color	SHG
	<a href="#">View hardware details</a>	SCG

## Product features.

- Acoustic panels are double sided with angled sides
- Panels are mounted on die cast space blocks between workstations
- Specify only one between two inline units
- Acoustic material panels are light gray
- Mounting brackets are gray metal finish (optional graphite gray)

## Options.

### PREMIUM METAL FINISHES

- Specify Screen Brackets Metal Finish Color: \$55
- MFGG: Graphite Gray

# Thinking quietly.

Brief Screen  
Brief Screen

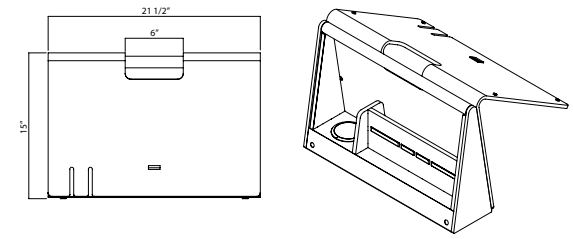

[View statement of line](#)

1	Select a model	Weight	Salted Oak Frame	
	w" x d" x h"		Heather Gray	
	21.5 x 6 x 15	10	BS2215N	1026

2	Select a finish	Frame finish
	<a href="#">View finish details</a>	WSO WEC +10%

3	Select a edge	Edge
	<a href="#">View edge details</a>	N/A

4	Select acoustic color	SHG SCG
	<a href="#">View hardware details</a>	

## Product features.

- Solid Salted Oak Handle
- Grey metal finish frame faced with acoustical cover
- Area for organizing office supplies
- Leather pull tab w/ magnetic closure

### NOTES

- Interpersonal privacy that functions as desk top organization
- Pencil holder standard

## Options.

### POWER

AirCharge offers a convenient way to charge any Qi compatible smartphone or device without the need to carry charging cables or find an available power outlet.

- ACWG: AirCharge Wireless Grommet - \$195

### PREMIUM FINISH

- WEC: Ebony finish on solid wood frame - 10% upcharge

Thinking quietly.  
Desk Pad  
Desk Pad

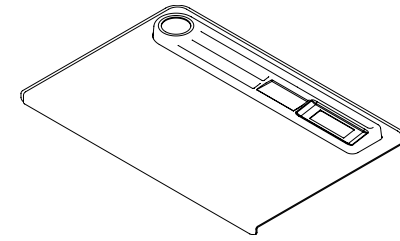

1 Select a model		weight			<a href="#">View statement of line</a>	
w" x d" x h"			Desk Pad Heather Gray			
36 x 23.75		5	DP36	703		
2 Select a finish			Finish N/A			
3 Select a edge			Edge N/A			
4 Select acoustic color			SHG			

Product features.

- Light gray sound absorbing material
- Pen cup and tray in black
- Organizer tray and device storage in molded acoustical material

Options.

**POWER BLOCK FOR DESK PAD**

AirCharge offers a convenient way to charge any Qi compatible smartphone or device without the need to carry charging cables or find an available power outlet. Devices not equipped with the Qi technology, can be adapted to accept a charge with the AirCharge Wireless Receiver.

- ACWG: AirCharge Wireless Grommet (Black Aluminum) \$575
- ACWR: AirCharge Wireless Charging Receiver with Lightning Cable \$170

# Thinking quietly.

Terrarium  
Terrarium

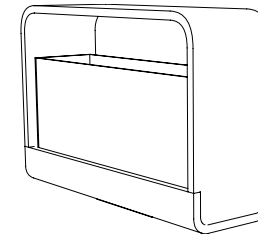

1 Select a model		weight	Salted Oak Frame		<a href="#">View statement of line</a>		
w" x d" x h"							
18 x 12 x 6		5	THQ1812TR811W	410			

2 Select a finish		Frame finish	
	<a href="#">View finish details</a>	WSO	WEC +10%

3 Select a edge		Edge	
	<a href="#">View edge details</a>	N/A	

4 Select hardware		Hardware	
	<a href="#">View hardware details</a>	N/A	

## Product features.

- Plywood wrap frame with flower basin insert
- Insert is clear acrylic material
- Flower basin insert is 16" x 8" x 4.5"

### NOTES

- Terrarium is not water tight
- Mounts into infill block rail

## Options.

### PREMIUM FINISH

- WEC: Ebony finish on solid wood frame - 10% upcharge

# Thinking quietly.

Workbay Typicals  
C-Shape Workbay

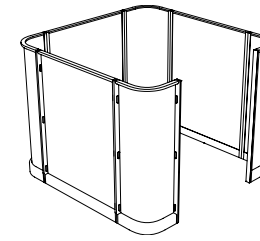

1 Select a model		Heather Gray	
w" x d" x h"	weight	Salted Oak Frame	
66.5 x 66.5 x 63	150	THQ6767CS920W	16751
82.25 x 66.5 x 63	160	THQ8267CS920W	17057
82.25 x 82.25 x 63	170	THQ8282CS920W	17669
98 x 82.5 x 63	190	THQ9882CS920W	19416
98 x 98 x 63	210	THQ9898CS920W	22910

[View statement of line](#)

2 Select a finish		Frame finish
<a href="#">View finish details</a>		WSO
		WEC +10%
Metal finish		
MFG Gray (standard),		
MFGG Graphite Gray (optional)		

3 Select a edge		Edge
<a href="#">View edge details</a>		N/A

4 Select acoustic color		SHG
<a href="#">View hardware details</a>		SCG

## Product features.

- Solid wood frame in Salted Oak finish
- Hardware included
- Shipped KD
- Workbay provides sound absorption with its acoustic material composition

### NOTES

- Workbay openings are based on total workbay width: 63" W unit (opening 30"), 78.75" W unit (opening 45.75"), 94.5" W unit (opening 61.5")

## Options.

### PREMIUM FINISH

- WEC: Ebony finish on solid wood frame - 10% upcharge

### PREMIUM METAL FINISH

- MFGG: Graphite Gray - \$400

Thinking quietly.  
Workbay Typical  
S-Shape Workbay

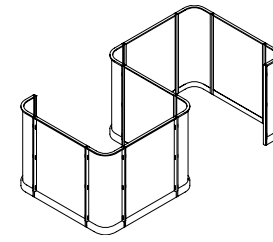

1 Select a model	weight	Heather Gray	Salted Oak Frame
w" x d" x h"			
131.25 x 66.5 x 63	230	THQ13267SS920W	26023
163 x 66.5 x 63	250	THQ16367SS920W	26634
163 x 82.25 x 63	280	THQ16382SS920W	27552
194.5 x 82.25 x 63	300	THQ19482SS920W	31046
194.5 x 98 x 63	330	THQ19498SS920W	36288

[View statement of line](#)

2 Select a finish	Frame finish
WSO <a href="#">View finish details</a>	WSO
Metal finish MFG Gray (standard), MFGG Graphite Gray (optional)	WEC +10%

3 Select a edge	Edge
<a href="#">View edge details</a>	N/A

4 Select acoustic color	
<a href="#">View hardware details</a>	SHG
	SCG

Product features.

- Solid wood frame in Salted Oak finish
- Hardware included
- Shipped KD
- Workbay provides sound absorption with its acoustic material composition

NOTES

- Workbay openings are based on total workbay width: 63" W unit (opening 30"), 78.75" W unit (opening 45.75"), 94.5" W unit (opening 61.5")

Options.

**PREMIUM FINISH**

- WEC: Ebony finish on solid wood frame - 10% upcharge

**PREMIUM METAL FINISH**

- MFGG: Graphite Gray - \$800

# Thinking quietly.

Workbay Typicals  
C-Shape Workbay with Worksurface

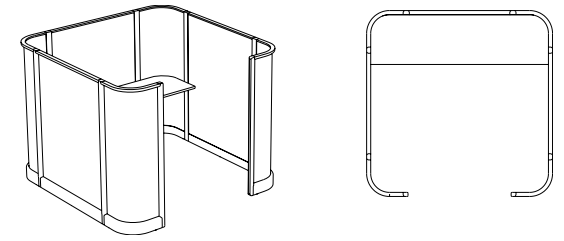

DARRAN

1 Select a model w" x d" x h"	weight	Standard Veneer Top Salted Oak Frame/Heather Gray		Premium Veneer Top Salted Oak Frame/Heather Gray		High Pressure Laminate Top Salted Oak Frame/Heather Gray		Thermally Fused Laminate Top Salted Oak Frame/Heather Gray	
		66.5 x 66.5 x 63	150	THQ6767CS910W	18951	"P" Option N/A	THQ6767CS910G	18640	THQ6767CS910M
82.25 x 66.5 x 63	150	THQ8267CS910W	19457	"P" Option N/A	THQ8267CS910G	19124	THQ8267CS910M	18793	
82.25 x 82.25 x 63	170	THQ8282CS910W	20069	"P" Option N/A	THQ8282CS910G	19735	THQ8282CS910M	19404	
98 x 82.5 x 63	190	THQ9882CS910W	22031	"P" Option N/A	THQ9882CS910G	21673	THQ9882CS910M	21277	
98 x 98 x 63	210	THQ9898CS910W	25526	"P" Option N/A	THQ9898CS910G	25167	THQ9898CS910M	24772	

2 Select a finish View finish details Metal finish MFG Gray (standard), MFGG Graphite Gray (optional)	Top finish		Frame finish		Top finish	Frame finish	
	WEC	WAM	WWP	WEC		+10%	GEC
			WSO	WEC +10%	MEC	MWL	
							WSO
							WEC +10%

3 Select an edge View edge details	Flat-1 (Black)			Flat-2 (Black)			Flat-3 (White)		

4 Select acoustic color View hardware details	SHG		SHG	
	SCG		SCG	

[View statement of line](#)

## Product features.

- Solid wood frame in Salted Oak finish
- Hardware included
- Shipped KD
- Workbay provides sound absorption with its acoustic material composition
- 1" thick worksurface tops

### NOTES

- Workbay openings are based on total workbay width: 63" W unit (opening 30"), 78.75" W unit (opening 45.75"), 94.5" W unit (opening 61.5")

## Options.

### GROMMETS (STANDARD LOCATION)

- Center - \$50 ea.
- Black: TM30-R (Right), TM30-L (Left)
- Silver: TM31-R (Right), TM31-L (Left)
- White: TM34-C (Center)

### PREMIUM FINISH

- WEC: Ebony finish on solid wood frame - 10% upcharge

### PREMIUM METAL FINISH

- MFGG: Graphite Gray - \$400

### POWER

- PD-KENO: Keno powered with clamp - \$195 ea.
- PD-TULLY: Tully power pod with clamp - \$320 ea.
- SCD: Soba wire management - \$200

# Thinking quietly.

Workbay Typicals  
S-Shape Workbay with Worksurface

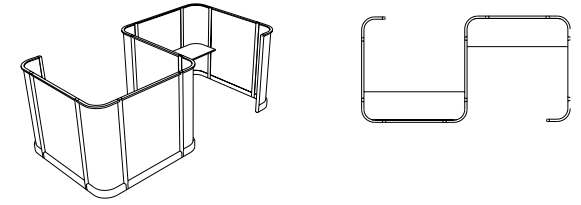

1 Select a model w" x d" x h"	weight	Standard Veneer Top Salted Oak Frame/Heather Gray		Premium Veneer Top Salted Oak Frame/Heather Gray		High Pressure Laminate Top Salted Oak Frame/Heather Gray		Thermally Fused Laminate Top Salted Oak Frame/Heather Gray	
		131.25 x 66.5 x 63	230	THQ13267SS910W	28430	"P" Option N/A	THQ13267SS910G	27912	THQ13267SS910M
163 x 66.5 x 63	230	THQ16367SS910W	29042	"P" Option N/A	THQ16367SS910G	28523	THQ16367SS910M	28253	
163 x 82.25 x 63	280	THQ16382SS910W	30160	"P" Option N/A	THQ16382SS910G	29618	THQ16382SS910M	29287	
194.5 x 82.25 x 63	300	THQ19482SS910W	33654	"P" Option N/A	THQ19482SS910G	33113	THQ19482SS910M	32782	
194.5 x 98 x 63	330	THQ19498SS910W	39111	"P" Option N/A	THQ19498SS910G	38544	THQ19498SS910M	38149	

2 Select a finish View finish details Metal finish MFG Gray (standard), MFGG Graphite Gray (optional)	Top finish		Frame finish		Top finish	Frame finish	Top finish	Frame finish
	WEC WAM WWP	WEC	WSO	WEC +10%				

3 Select an edge View edge details	Flat-1 Flat-2 (Black) Flat-3 (White)			Flat-1 Flat-2 (Black) Flat-3 (White)			Flat-2 (Black) Flat-3 (White)	
	SHG SCG	SHG SCG	SHG SCG	SHG SCG	SHG SCG	SHG SCG	SHG SCG	SHG SCG

4 Select acoustic color View hardware details	SHG SCG		SHG SCG		SHG SCG	
	SHG SCG	SHG SCG	SHG SCG	SHG SCG	SHG SCG	SHG SCG

[View statement of line](#)

## Product features.

- Solid wood frame in Salted Oak finish
- Hardware included
- Shipped KD
- Workbay provides sound absorption with its acoustic material composition
- 1" thick worksurface tops

### NOTES

- Workbay openings are based on total workbay width: 63" W unit (opening 30"), 78.75" W unit (opening 45.75"), 94.5" W unit (opening 61.5")

## Options.

### GROMMETS (STANDARD LOCATION)

- Center - \$50 ea.
- Black: TM30-R (Right), TM30-L (Left)
- Silver: TM31-R (Right), TM31-L (Left)
- White: TM34-C (Center)

### PREMIUM FINISH

- WEC: Ebony finish on solid wood frame - 10% upcharge

### PREMIUM METAL FINISH

- MFGG: Graphite Gray - \$800

### POWER

- PD-KENO: Keno powered with clamp - \$195 ea.
- PD-TULLY: Tully power pod with clamp - \$320 ea.
- SCD: Soba wire management - \$200



# Thinking quietly.

Workbay Typicals  
Zig-Zag Workbay

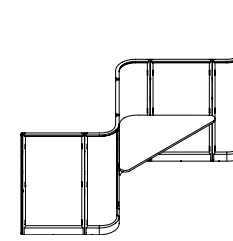

[View statement of line](#)

1 Select a model w" x d" x h"	weight	Standard Veneer Top		Premium Veneer Top		High Pressure Laminate Top		Thermally Fused Laminate Top	
		Salted Oak Frame/Heather Gray		Salted Oak Frame/Heather Gray		Salted Oak Frame/Heather Gray		Salted Oak Frame/Heather Gray	
<b>1 Person Workbay</b> 36 x 70.5 x 63	150	THQ7036ZS920W	8469	"P" Option N/A		THQ7036ZS920G	8326	THQ7036ZS920M	8103
<b>2 Person Workbay</b> 41 x 119 x 63	270	THQ11941ZS920W	14317	"P" Option N/A		THQ11941ZS920G	14033	THQ11941ZS920M	13584
<b>3 Person Workbay</b> 41 x 162 x 63	390	THQ16241ZS920W	20164	"P" Option N/A		THQ16241ZS920G	19738	THQ16241ZS920M	19066
<b>4 Person Workbay</b> 41 x 210 x 63	510	THQ21041ZS920W	26011	"P" Option N/A		THQ21041ZS920G	25444	THQ21041ZS920M	24548
2 Select a finish <a href="#">View finish details</a>  Metal finish MFG Gray (standard), MFGG Graphite Gray (optional)	Top finish	Frame finish		Top finish	Frame finish	Top finish	Frame finish	Top finish	Frame finish
	WEC WAM WWP	WSO WEC +10%		GEC GAM GWL	WSO WEC +10%	MEC MWL	WSO WEC +10%		
3 Select a edge <a href="#">View edge details</a>	Flat-1	Flat-2 (Black)	Flat-3 (White)	Flat-1	Flat-2 (Black)	Flat-3 (White)	Flat-2 (Black)	Flat-3 (White)	
4 Select acoustic color <a href="#">View hardware details</a>	SHG	SCG		SHG	SCG	SHG	SCG	SHG	SCG

## Product features.

- Solid wood frame in Salted Oak finish
- Hardware included
- Shipped KD
- Workbay provides sound absorption with its acoustic material composition

## Options.

### GROMMETS (STANDARD LOCATION)

- Center - \$50 ea.
- Black: TM30-R (Right), TM30-L (Left)
- Silver: TM31-R (Right), TM31-L (Left)
- White: TM34-C (Center)

### PREMIUM FINISH

- WEC: Ebony finish on solid wood frame - 10% upcharge

### PREMIUM METAL FINISH

- MFGG: Graphite Gray - \$1020

### POWER

- PD-KENO: Keno powered with clamp - \$195 ea.
- PD-TULLY: Tully power pod with clamp - \$320 ea.
- SCD: Soba wire management - \$200

# Thinking quietly.

Workbay Modular

Wall Corner Outside And Inside Skirting

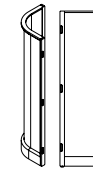

Outside Skirting  
OC918

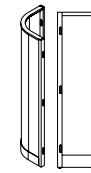

Inside Skirting  
IC918

[View statement of line](#)

1 Select a model	weight	Heather Gray		
w" x d" x h"		Salted Oak Frame		
<b>Outside Skirting</b>				
17.75 x 17.75 x 63	20	THQ1863OC918W	2582	
<b>Inside Skirting</b>				
17.75 x 17.75 x 63	20	THQ1863IC918W	2582	

2 Select a finish	Frame finish
<a href="#">View finish details</a>	WSO
	WEC +10%
<b>Metal finish</b>	
MFG Gray (standard), MFGG Graphite Gray (optional)	

3 Select a edge	Edge
<a href="#">View edge details</a>	N/A

4 Select acoustic color	
<a href="#">View hardware details</a>	SHG
	SCG

## Product features.

- Solid wood frame in Salted Oak finish
- Hardware included
- Panel provides sound absorption with its acoustic material composition

## Options.

### PREMIUM FINISH

- WEC: Ebony finish on solid wood frame - 10% upcharge

### PREMIUM METAL FINISH

- MFGG: Graphite Gray - \$75

Thinking quietly.  
 Workbay Modular  
 Straight Workbay Wall



**1** Select a model

w" x d" x h"	weight	Heather Gray	Salted Oak Frame
31.5 x 1.75 x 63	20	THQ3263SW919W	2053
47.25 x 1.75 x 63	30	THQ4863SW919W	2359

[View statement of line](#)

**2** Select a finish

Frame finish
WSO
WEC +10%

[View finish details](#)

Metal finish  
 MFG Gray (standard),  
 MFGG Graphite Gray (optional)

**3** Select a edge

Edge
N/A

[View edge details](#)

**4** Select acoustic color

SHG
SCG

[View hardware details](#)

**Product features.**

- Solid wood frame in Salted Oak finish
- Hardware included
- Panel provides sound absorption with its acoustic material composition

**Options.**

- PREMIUM FINISH**
- WEC: Ebony finish on solid wood frame - 10% upcharge
- PREMIUM METAL FINISH**
- MFGG: Graphite Gray - \$75

Thinking quietly.  
Workbay Modular  
End Cap



1 Select a model	weight	Heather Gray	
w" x d" x h"		Salted Oak Frame	
1.75 x .75 x 62.5	5	ECAP01	131

[View statement of line](#)

2 Select a finish	Frame finish
<a href="#">View finish details</a>	WSO
	WEC +10%

3 Select a edge	Edge
<a href="#">View edge details</a>	N/A

4 Select hardware	Hardware
<a href="#">View hardware details</a>	N/A

Product features.

- Solid Salted Oak

Options.

**PREMIUM FINISH**

- WEC: Ebony finish on solid wood frame - 10% upcharge

Thinking quietly.  
Meeting Space  
Stationary Cone

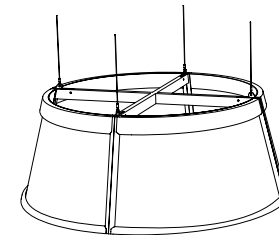

[View statement of line](#)

1 Select a model	weight	Heather Gray	Salted Oak Frame
w" x d" x h" DIA 82.5 x 32	100	THQ7932CO730W	15496

2 Select a finish	Frame finish
<a href="#">View finish details</a>	WSO
Metal finish MFG Gray (standard), MFGG Graphite Gray (optional)	WEC +10%

3 Select a edge	Edge
<a href="#">View edge details</a>	N/A

4 Select acoustic color	SHG	SCG
<a href="#">View hardware details</a>		

Product features.

- Cone is acoustically beneficial with its material composition.
- Solid wood frame in Salted Oak finish
- Hardware included
- Shipped KD in subassemblies

Options.

**PREMIUM FINISH**

- WEC: Ebony finish on solid wood frame - 10% upcharge

**PREMIUM METAL FINISH**

- MFGG: Graphite Gray - \$125

Thinking quietly.  
Meeting Space  
Adjustable Cone

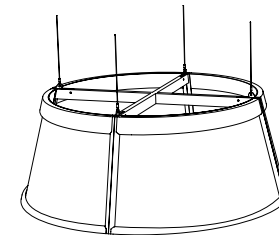

[View statement of line](#)

1 Select a model w" x d" x h" DIA 82.5 x 32	weight 100	Heather Gray	
		Salted Oak Frame	
		THQ7932CO731W	15933

2 Select a finish <a href="#">View finish details</a>  Metal finish MFG Gray (standard). Premium metal finishes available, see options.	Frame finish
	WSO WEC +10%

3 Select a edge <a href="#">View edge details</a>	Edge
	N/A

4 Select acoustic color <a href="#">View hardware details</a>	SHG
	SCG

**Product features.**

- Cone is acoustically beneficial with its material composition.
- Solid wood frame in Salted Oak finish
- Hardware included
- Shipped KD in subassemblies
- 4 handles included

**NOTES**

- Must be installed by a structural engineer
- Recommended installation height 5' above ground

**Options.**

**PREMIUM FINISH**

- WEC: Ebony finish on solid wood frame - 10% upcharge

**PREMIUM METAL FINISH**









- MFGG: Graphite Gray - \$125

# Thinking quietly.

Conference Tables  
Round Top With Frame



[View statement of line](#)

1 Select a model w" x d" x h"	weight	Standard Veneer Top Salted Oak Frame		Premium Veneer Top Salted Oak Frame		High Pressure Laminate Top Salted Oak Frame		Thermally Fused Laminate Top Salted Oak Frame	
		<b>Sitting Height</b> 60 DIA x 29 54 DIA x 29 48 DIA x 29 42 DIA x 29 36 DIA x 29 <b>Standing Height</b> 48 DIA x 42 42 DIA x 42 36 DIA x 42	150 140 130 120 110 145 135 125	THQ6060RD121W THQ5454RD121W THQ4848RD121W THQ4242RD121W THQ3636RD121W THQ4848RD141W THQ4242RD141W THQ3636RD141W	4184 3947 2671 2638 2607 2874 2841 2811	"P" Option N/A "P" Option N/A "P" Option N/A "P" Option N/A "P" Option N/A "P" Option N/A "P" Option N/A "P" Option N/A	THQ6060RD121G THQ5454RD121G THQ4848RD121G THQ4242RD121G THQ3636RD121G THQ4848RD141G THQ4242RD141G THQ3636RD141G	3857 3696 2416 2392 2368 2620 2596 2572	THQ6060RD121M THQ5454RD121M THQ4848RD121M THQ4242RD121M THQ3636RD121M THQ4848RD141M THQ4242RD141M THQ3636RD141M
2 Select a finish <a href="#">View finish details</a>		Top finish WEC WAM WWP WSO	Frame finish WSO WEC +10%		Top finish GEC GAM GWL	Frame finish WSO WEC +10%	Top finish MEC MWL	Frame finish WSO WEC +10%	
3 Select a edge <a href="#">View edge details</a>		 Flat-1  Flat-2 (Black)  Flat-3 (White)		 Flat-1  Flat-2 (Black)  Flat-3 (White)	 Flat-2 (Black)  Flat-3 (White)				
4 Select hardware <a href="#">View hardware details</a>		Hardware N/A		Hardware N/A	Hardware N/A		Hardware N/A		

## Product features.

- 1" Thick top
- ENVI-CT Finish on wood tops
- Base is Solid Salted Oak with Lofty Ash inserts
- Top attaches to metal frame rail

## Options.

### PREMIUM FINISH







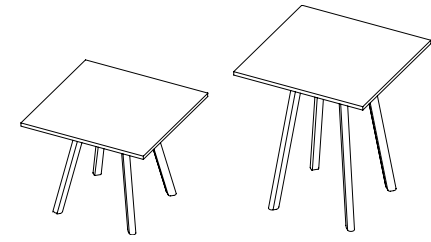

- WEC: Ebony finish on solid wood frame - 10% upcharge

# Thinking quietly.

Conference Tables  
Square Top With Frame



[View statement of line](#)

1 Select a model w" x d" x h"	weight	Standard Veneer Top Salted Oak Frame		Premium Veneer Top Salted Oak Frame		High Pressure Laminate Top Salted Oak Frame		Thermally Fused Laminate Top Salted Oak Frame	
		<b>Sitting Height</b>				"P" Option N/A			
60 x 60 x 29	155	THQ6060SQ121W	4184	"P" Option N/A	THQ6060SQ121G	3857	THQ6060SQ121M	3397	
54 x 54 x 29	145	THQ5454SQ121W	3947	"P" Option N/A	THQ5454SQ121G	3696	THQ5454SQ121M	3331	
48 x 48 x 29	135	THQ4848SQ121W	2671	"P" Option N/A	THQ4848SQ121G	2422	THQ4848SQ121M	2022	
42 x 42 x 29	125	THQ4242SQ121W	2638	"P" Option N/A	THQ4242SQ121G	2392	THQ4242SQ121M	1985	
36 x 36 x 29	115	THQ3636SQ121W	2607	"P" Option N/A	THQ3636SQ121G	2368	THQ3636SQ121M	1938	
<b>Standing Height</b>				"P" Option N/A					
48 x 48 x 42	150	THQ4848SQ141W	2874	"P" Option N/A	THQ4848SQ141G	2625	THQ4848SQ141M	2225	
42 x 42 x 42	140	THQ4242SQ141W	2841	"P" Option N/A	THQ4242SQ141G	2596	THQ4242SQ141M	2189	
36 x 36 x 42	130	THQ3636SQ141W	2811	"P" Option N/A	THQ3636SQ141G	2572	THQ3636SQ141M	2141	
2 Select a finish <a href="#">View finish details</a>		Top finish	Frame finish		Top finish	Frame finish	Top finish	Frame finish	
		WEC	WSO		GEC	WSO	MEC	WSO	
		WAM	WEC +10%		GAM	WEC +10%	MWL	WEC +10%	
		WWP			GWL				
		WSO							
3 Select a edge <a href="#">View edge details</a>									
		Flat-1	Flat-2 (Black)	Flat-3 (White)	Flat-1	Flat-2 (Black)	Flat-3 (White)	Flat-2 (Black)	Flat-3 (White)
4 Select hardware <a href="#">View hardware details</a>		Hardware			Hardware		Hardware		
		N/A			N/A		N/A		

## Product features.

- 1" Thick top
- ENVI-CT Finish on wood tops
- Base is Solid Salted Oak with Lofty Ash inserts
- Top attaches to metal frame rail

## Options.

### PREMIUM FINISH

- WEC: Ebony finish on solid wood frame - 10% upcharge



# Thinking quietly.

Conference Tables  
Rectangle - 36" Depth

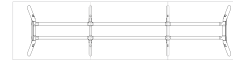

1 Select a model w" x d" x h"	weight	Standard Veneer Top Salted Oak Frame		Premium Veneer Top Salted Oak Frame		High Pressure Laminate Top Salted Oak Frame		Thermally Fused Laminate Top Salted Oak Frame	
		<b>3 Piece Top</b>							
240 x 36 x 29	315	THQ24036RE123W	9486	"P" Option N/A		THQ24036RE123G	8617	THQ24036RE123M	7552
216 x 36 x 29	290	THQ21636RE123W	9164	"P" Option N/A		THQ21636RE123G	8361	THQ21636RE123M	7457
198 x 36 x 29	265	THQ19836RE123W	8148	"P" Option N/A		THQ19836RE123G	7535	THQ19836RE123M	6715
<b>2 Piece Top</b>									
168 x 36 x 29	240	THQ16836RE122W	6581	"P" Option N/A		THQ16836RE122G	6022	THQ16836RE122M	5340
144 x 36 x 29	215	THQ14436RE122W	6317	"P" Option N/A		THQ14436RE122G	5806	THQ14436RE122M	5269
120 x 36 x 29	190	THQ12036RE122W	6054	"P" Option N/A		THQ12036RE122G	5591	THQ12036RE122M	5197
<b>1 Piece Top</b>									
96 x 36 x 29	165	THQ9636RE121W	4096	"P" Option N/A		THQ9636RE121G	3792	THQ9636RE121M	3366
84 x 36 x 29	155	THQ8436RE121W	3983	"P" Option N/A		THQ8436RE121G	3696	THQ8436RE121M	3331
72 x 36 x 29	145	THQ7236RE121W	3869	"P" Option N/A		THQ7236RE121G	3606	THQ7236RE121M	3295
<b>2 Select a finish</b> <a href="#">View finish details</a>		Top finish	Frame finish			Top finish	Frame finish	Top finish	Frame finish
Metal finish MFG Gray (standard). Premium metal finishes available, see options.		WEC	WSO			GEC	WSO	MEC	WSO
		WAM	WEC +10%			GAM	WEC +10%	MWL	WEC +10%
		WWP				GWL			
		WSO							
<b>3 Select a edge</b> <a href="#">View edge details</a>		Flat-1 Flat-2 (Black) Flat-3 (White)		Flat-1 Flat-2 (Black) Flat-3 (White)		Flat-2 (Black) Flat-3 (White)			
<b>4 Select hardware</b> <a href="#">View hardware details</a>		Hardware N/A		Hardware N/A		Hardware N/A		Hardware N/A	

[View statement of line](#)

## Product features.

- 1" Thick top
- ENVI-CT Finish on wood tops
- Base is Solid Salted Oak with Lofty Ash inserts
- Grey metal finish frame standard
- Top attaches to metal frame rail

### NOTES

- 72"-96" Width Tops have 4 Legs
- 120"-168" Wood Tops have 6 Legs
- 198"-240" Wood Tops have 8 Legs

## Options.

### POWER

- Two pods mounted under the hinged seamless grommet. Each pod has 4 power and 2 data ports. Telecom connectors sold separately.
- PSG82-C: Plug with 124" cord (8 power, 2 telecom plates) - \$1875 each
  - W21: Grey Wire Manager (10.5") - \$35 ea.

### PREMIUM FINISH

- WEC: Ebony finish on solid wood frame - 10% upcharge

### PREMIUM METAL FINISH

- One Piece Top
- MFGG: Graphite Gray - \$575
- Two Piece Top
- MFGG: Graphite Gray - \$850
- Three Piece Top
- MFGG: Graphite Gray - \$1200

# Thinking quietly.

Conference Tables  
Rectangle - 42" Depth



[View statement of line](#)

1 Select a model w" x d" x h"	weight	Standard Veneer Top Salted Oak Frame		Premium Veneer Top Salted Oak Frame		High Pressure Laminate Top Salted Oak Frame		Thermally Fused Laminate Top Salted Oak Frame	
		<b>3 Piece Top</b> 240 x 42 x 29 216 x 42 x 29 198 x 42 x 29 <b>2 Piece Top</b> 168 x 42 x 29 144 x 42 x 29 120 x 42 x 29 <b>1 Piece Top</b> 96 x 42 x 29 84 x 42 x 29 72 x 42 x 29							
		THQ24042RE123W	10070	"P" Option N/A		THQ24042RE123G	9090	THQ24042RE123M	7672
		THQ21642RE123W	9705	"P" Option N/A		THQ21642RE123G	8796	THQ21642RE123M	7565
		THQ19842RE123W	8538	"P" Option N/A		THQ19842RE123G	7852	THQ19842RE123M	6811
		THQ16842RE122W	6964	"P" Option N/A		THQ16842RE122G	6327	THQ16842RE122M	5424
		THQ14442RE122W	6700	"P" Option N/A		THQ14442RE122G	6117	THQ14442RE122M	5340
		THQ12042RE122W	6432	"P" Option N/A		THQ12042RE122G	5897	THQ12042RE122M	5256
		THQ9642RE121W	4309	"P" Option N/A		THQ9642RE121G	3959	THQ9642RE121M	3457
		THQ8442RE121W	4184	"P" Option N/A		THQ8442RE121G	3857	THQ8442RE121M	3397
		THQ7242RE121W	4058	"P" Option N/A		THQ7242RE121G	3755	THQ7242RE121M	3331

2 Select a finish <a href="#">View finish details</a>	Top finish		Frame finish		Top finish	Frame finish		Top finish	Frame finish	
	Metal finish MFG Gray (standard), MFGG Graphite Gray (optional)	WEC	WSO	WAM		WEC +10%	GEC		WSO	GAM
	WWP				GWL				MWL	WEC +10%
	WSO									

3 Select a edge <a href="#">View edge details</a>	Standard Veneer Top			Premium Veneer Top			High Pressure Laminate Top			Thermally Fused Laminate Top		
		Flat-1	Flat-2 (Black)	Flat-3 (White)	Flat-1	Flat-2 (Black)	Flat-3 (White)	Flat-1	Flat-2 (Black)	Flat-3 (White)	Flat-2 (Black)	Flat-3 (White)

4 Select hardware <a href="#">View hardware details</a>	Standard Veneer Top		Premium Veneer Top		High Pressure Laminate Top		Thermally Fused Laminate Top	
		Hardware N/A				Hardware N/A		

## Product features.

- 1" Thick top
- ENVI-CT Finish on wood tops
- Base is Solid Salted Oak with Lofty Ash inserts
- Grey metal finish frame standard
- Top attaches to metal frame rail

### NOTES

- 72"-96" Width Tops have 4 Legs
- 120"-168" Wood Tops have 6 Legs
- 198"-240" Wood Tops have 8 Legs

## Options.

### POWER

- Two pods mounted under the hinged seamless grommet. Each pod has 4 power and 2 data ports. Telecom connectors sold separately.
- PSG82-C: Plug with 124" cord (8 power, 2 telecom plates) - \$1875 each
  - W21: Grey Wire Manager (10.5") - \$35 ea.

### PREMIUM FINISH

- WEC: Ebony finish on solid wood frame - 10% upcharge

### PREMIUM METAL FINISH

- One Piece Top
- MFGG: Graphite Gray - \$575
- Two Piece Top
- MFGG: Graphite Gray - \$850
- Three Piece Top
- MFGG: Graphite Gray - \$1200

# Thinking quietly.

Conference Tables  
Rectangle - 48" Depth



[View statement of line](#)

1 Select a model w" x d" x h"	weight	Standard Veneer Top Salted Oak Frame		Premium Veneer Top Salted Oak Frame		High Pressure Laminate Top Salted Oak Frame		Thermally Fused Laminate Top Salted Oak Frame	
		<b>3 Piece Top</b> 240 x 48 x 29 216 x 48 x 29 198 x 48 x 29 <b>2 Piece Top</b> 168 x 48 x 29 144 x 48 x 29 120 x 48 x 29 <b>1 Piece Top</b> 96 x 48 x 29 84 x 48 x 29 72 x 48 x 29							
		THQ24048RE123W	10773	"P" Option N/A	THQ24048RE123G	9657	THQ24048RE123M	7792	
		THQ21648RE123W	10358	"P" Option N/A	THQ21648RE123G	9323	THQ21648RE123W	7672	
		THQ19848RE123W	9027	"P" Option N/A	THQ19848RE123G	8246	THQ19848RE123M	6841	
		THQ16848RE122W	7422	"P" Option N/A	THQ16848RE122G	6698	THQ16848RE122M	5442	
		THQ14448RE122W	7121	"P" Option N/A	THQ14448RE122G	6458	THQ14448RE122M	5347	
		THQ12048RE122W	6814	"P" Option N/A	THQ12048RE122G	6208	THQ12048RE122M	5316	
		THQ9648RE121W	4560	"P" Option N/A	THQ9648RE121G	4162	THQ9648RE121M	3505	
		THQ8448RE121W	4416	"P" Option N/A	THQ8448RE121G	4049	THQ8448RE121M	3438	
		THQ7248RE121W	4271	"P" Option N/A	THQ7248RE121G	3935	THQ7248RE121M	3366	
2 Select a finish <a href="#">View finish details</a>		Top finish	Frame finish		Top finish	Frame finish	Top finish	Frame finish	
		WEC	WSO		GEC	WSO	MEC	WSO	
		WAM	WEC +10%		GAM	WEC +10%	MWL	WEC +10%	
		WWP			GWL				
		WSO							
Metal finish MFG Gray (standard), MFGG Graphite Gray (optional)									
3 Select a edge <a href="#">View edge details</a>		Flat-1	Flat-2 (Black)	Flat-3 (White)	Flat-1	Flat-2 (Black)	Flat-3 (White)	Flat-2 (Black)	Flat-3 (White)
4 Select hardware <a href="#">View hardware details</a>		Hardware N/A			Hardware N/A		Hardware N/A		

## Product features.

- 1" Thick top
- ENVI-CT Finish on wood tops
- Base is Solid Salted Oak with Lofty Ash inserts
- Grey metal finish frame standard

### NOTES

- 72"-96" Width Tops have 4 Legs
- 120"-168" Wood Tops have 6 Legs
- 198"-240" Wood Tops have 8 Legs

## Options.

### POWER

- Two pods mounted under the hinged seamless grommet. Each pod has 4 power and 2 data ports. Telecom connectors sold separately.
- PSG82-C: Plug with 124" cord (8 power, 2 telecom plates) - \$1875 each
  - W21: Grey Wire Manager (10.5") - \$35 ea.

### PREMIUM FINISH

- WEC: Ebony finish on solid wood frame - 10% upcharge

### PREMIUM METAL FINISH







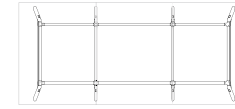

- One Piece Top
- MFGG: Graphite Gray - \$575
- Two Piece Top
- MFGG: Graphite Gray - \$850
- Three Piece Top
- MFGG: Graphite Gray - \$1200

# Thinking quietly.

Conference Tables  
Rectangle - 54" Depth



[View statement of line](#)

1 Select a model w" x d" x h"	weight	Standard Veneer Top Salted Oak Frame		Premium Veneer Top Salted Oak Frame		High Pressure Laminate Top Salted Oak Frame		Thermally Fused Laminate Top Salted Oak Frame	
		<b>3 Piece Top</b> 240 x 54 x 29 216 x 54 x 29 198 x 54 x 29 <b>2 Piece Top</b> 168 x 54 x 29 144 x 54 x 29 120 x 54 x 29	410 380 350 325 290 255	THQ24054RE123W THQ21654RE123W THQ19854RE123W THQ16854RE122W THQ14454RE122W THQ12054RE122W	11678 11208 9694 8034 7694 7342	"P" Option N/A "P" Option N/A "P" Option N/A "P" Option N/A "P" Option N/A "P" Option N/A	THQ24054RE123G THQ21654RE123G THQ19854RE123G THQ16854RE122G THQ14454RE122G THQ12054RE122G	10411 10035 8809 7212 6937 6656	THQ24054RE123M THQ21654RE123M THQ19854RE123M THQ16854RE122M THQ14454RE122M THQ12054RE122M
<b>2 Select a finish</b> <a href="#">View finish details</a>  Metal finish MFG Gray (standard), MFGG Graphite Gray (optional)	Top finish WEC WAM WWP WSO	Frame finish WSO WEC +10%		Top finish GEC GAM GWL	Frame finish WSO WEC +10%		Top finish MEC MWL	Frame finish WSO WEC +10%	
<b>3 Select a edge</b> <a href="#">View edge details</a>	 Flat-1  Flat-2 (Black)  Flat-3 (White)			 Flat-1  Flat-2 (Black)  Flat-3 (White)			 Flat-2 (Black)  Flat-3 (White)		
<b>4 Select hardware</b> <a href="#">View hardware details</a>	Hardware N/A			Hardware N/A			Hardware N/A		

## Product features.

- 1" Thick top
- ENVI-CT Finish on wood tops
- Base is Solid Salted Oak with Lofty Ash inserts
- Grey metal finish frame standard

### NOTES

- 120"-168" Wood Tops have 6 Legs
- 198"-240" Wood Tops have 8 Legs

## Options.

### POWER

- Two pods mounted under the hinged seamless grommet. Each pod has 4 power and 2 data ports. Telecom connectors sold separately.
- PSG82-C: Plug with 124" cord (8 power, 2 telecom plates) - \$1875 each
  - W21: Grey Wire Manager (10.5") - \$35 ea.

### PREMIUM FINISH

- WEC: Ebony finish on solid wood frame - 10% upcharge

### PREMIUM METAL FINISH







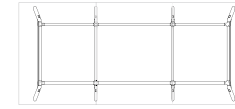

- One Piece Top
- MFGG: Graphite Gray - \$575
- Two Piece Top
- MFGG: Graphite Gray - \$850
- Three Piece Top
- MFGG: Graphite Gray - \$1200

# Thinking quietly.

Conference Tables  
Rectangle - 60" Depth



[View statement of line](#)

1 Select a model w" x d" x h"	weight	Standard Veneer Top Salted Oak Frame		Premium Veneer Top Salted Oak Frame		High Pressure Laminate Top Salted Oak Frame		Thermally Fused Laminate Top Salted Oak Frame	
		<b>3 Piece Top</b> 240 x 60 x 29 216 x 60 x 29 198 x 60 x 29 <b>2 Piece Top</b> 168 x 60 x 29 144 x 60 x 29 120 x 60 x 29	465 420 375 320 310 265	THQ24060RE123W THQ21660RE123W THQ19860RE123W THQ16860RE122W THQ14460RE122W THQ12060RE122W	12582 12048 10328 8624 8235 7832	"P" Option N/A "P" Option N/A "P" Option N/A "P" Option N/A "P" Option N/A "P" Option N/A	THQ24060RE123G THQ21660RE123G THQ19860RE123G THQ16860RE122G THQ14460RE122G THQ12060RE122G	11147 10716 9323 7691 7374 7050	THQ24060RE123M THQ21660RE123M THQ19860RE123M THQ16860RE122M THQ14460RE122M THQ12060RE122M
<b>2 Select a finish</b> <a href="#">View finish details</a>  Metal finish MFG Gray (standard), MFGG Graphite Gray (optional)	Top finish WEC WAM WWP WSO	Frame finish WSO WEC +10%			Top finish GEC GAM GWL	Frame finish WSO WEC +10%	Top finish MEC MWL	Frame finish WSO WEC +10%	
<b>3 Select a edge</b> <a href="#">View edge details</a>	 Flat-1  Flat-2 (Black)  Flat-3 (White)				 Flat-1  Flat-2 (Black)  Flat-3 (White)		 Flat-2 (Black)  Flat-3 (White)		
<b>4 Select hardware</b> <a href="#">View hardware details</a>	Hardware N/A				Hardware N/A		Hardware N/A		

## Product features.

- 1" Thick top
- ENVI-CT Finish on wood tops
- Base is Solid Salted Oak with Lofty Ash inserts
- Grey metal finish frame standard

### NOTES

- 120"-168" Wood Tops have 6 Legs
- 198"-240" Wood Tops have 8 Legs

## Options.

### POWER

- Two pods mounted under the hinged seamless grommet. Each pod has 4 power and 2 data ports. Telecom connectors sold separately.
- PSG82-C: Plug with 124" cord (8 power, 2 telecom plates) - \$1875 each
  - W21: Grey Wire Manager (10.5") - \$35 ea.

### PREMIUM FINISH

- WEC: Ebony finish on solid wood frame - 10% upcharge

### PREMIUM METAL FINISH







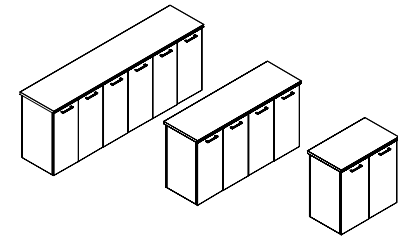















- One Piece Top
- MFGG: Graphite Gray - \$575
- Two Piece Top
- MFGG: Graphite Gray - \$850
- Three Piece Top
- MFGG: Graphite Gray - \$1200

# Thinking quietly.

Full Pedestal Credenzas  
 Conferencing Storage Credenza



[View statement of line](#)

1 Select a model w" x d" x h"	weight	Standard Veneer Top Standard Veneer Chassis		Premium Veneer Top Premium Veneer Chassis		High Pressure Laminate Top High Pressure Laminate Chassis		Thermally Fused Laminate Top Thermally Fused Laminate Chassis	
		<b>Triple Storage</b> 93 x 24 x 36 87 x 24 x 36	390 340	THQ9324CA124W THQ8724CA124W	6715 6574	"P" Option N/A "P" Option N/A		THQ9324CA124G THQ8724CA124G	5814 5691
<b>Double Storage</b> 70 x 24 x 36 64 x 24 x 36 58 x 24 x 36 47 x 24 x 36	290 260 245 200	THQ7024CA124W THQ6424CA124W THQ5824CA124W THQ4724CA124W	4681 4523 4316 4052	"P" Option N/A "P" Option N/A "P" Option N/A "P" Option N/A		THQ7024CA124G THQ6424CA124G THQ5824CA124G THQ4724CA124G	4053 3917 3781 3508	THQ7024CA124M THQ6424CA124M THQ5824CA124M THQ4724CA124M	2670 2621 2572 2473
<b>Single Storage</b> 35 x 24 x 36 29 x 24 x 36	150 135	THQ3524CA124W THQ2924CA124W	2633 2477	"P" Option N/A "P" Option N/A		THQ3524CA124G THQ2924CA124G	2280 2144	THQ3524CA124M THQ2924CA124M	1453 1409
<b>2 Select a finish</b> <a href="#">View finish details</a>		WEC WAM WWP WSO			GEC GAM GWL			MEC MWL	
<b>3 Select a edge</b> <a href="#">View edge details</a>		 Flat-1  Flat-2 (Black)  Flat-3 (White)			 Flat-1  Flat-2 (Black)  Flat-3 (White)			 Flat-2 (Black)  Flat-3 (White)	
<b>4 Select hardware</b> <a href="#">View hardware details</a>		 PL-115 Matte Black  PL-116 Matte Nickel  PL-260 Anodized Aluminum  PL-261 White			 PL-115 Matte Black  PL-116 Matte Nickel  PL-210 Anodized Aluminum  PL-260 Anodized Aluminum  PL-261 White			 PL-115 Matte Black  PL-116 Matte Nickel  PL-210 Anodized Aluminum  PL-260 Anodized Aluminum  PL-261 White	

## Product features.

- Adjustable glides
- "M" styles shelves match finish
- "W"/"G" styles have black adjustable shelf behind door set

### NOTES

- All units are std with flush ends

## Options.

### ACCESSORIES

- REF-01: Modify Storage section for refrigerator - \$205

### AUDIO VISUAL/BACK PANEL WALL ACCESS

- AVR1: AV Exhaust Fan - \$470
- AVR2: AV Pullout Rack - \$1655
- M19: 2 Heat vent/cord access slots in back - \$ 160

### DOOR

- D2: Wood Door Lock - \$100 per door set
- D6: Delete doors - n/c
- D6A: "W"/"G" Styles - Delete Doors and replace black laminate shelf with finished shelf - n/c

### GROMMETS (STANDARD LOCATION)

Specify Color and Left/Right/Center - \$50 ea.

- Black: TM30-R (Right), TM30-L (Left), TM30-C (Center)
- Silver: TM31-R (Right), TM31-L (Left), TM31-C (Center)
- White: TM34-R (Right), TM34-L (Left), TM34-C (Center)

### GROMMETS (NON-STANDARD LOCATION)

Provide drawing w/ Grommet Location and Specify Color - \$95 ea.

- Black: TM30-NS
- Silver: TM31-NS
- White: TM34-NS

### GROMMETS (VERTICAL SURFACE)

Standard Location - \$50 ea.

- Black Plastic Vertical Surface: TM50-C (Bottom Center)

Non-Standard Location - \$95 ea.

- Black Plastic Vertical Surface: TM50-NS

### OPEN PLAN – FINISHED BACK

- OPB: "W" "G" Style - Modify Unit for Open Plan Application - \$195

- OPB: "M" Style - Modify Unit for Open Plan Application - \$95

### SHELF

- S25: Replace Black Laminate Shelf with Finished Shelf - \$80 per shelf

### TRASH CAN

- TRC50: EZ Cargo 50 dual trash can - (1) 8 gallon and (1) 5 gallon - \$680

## Thinking Quietly options.



COMPUTER SUPPORT  
*single monitor arm*

Style Number	List Price
MA1	280

### Specifications

- Available in black or silver
- Desk clamp and mounting included
- Easy assembly and flexibility
- Elastic painting process for a durable and beautiful finish
- Gas spring tension adjustment for counter-balance height adjustment for monitors 1-8 KG
- Gas spring tested to 50,000 repetitions
- Hidden cable management



COMPUTER SUPPORT  
*double monitor arm*

Style Number	List Price
MA2	450

### Specifications

- Available in black or silver
- Desk clamp and mounting included
- Easy assembly and flexibility
- Elastic painting process for a durable and beautiful finish
- Gas spring tension adjustment for counter-balance height adjustment for monitors 1-8 KG
- Gas spring tested to 50,000 repetitions
- Hidden cable management



COMPUTER SUPPORT  
*triple monitor arm*

Style Number	List Price
MA3	530

### Specifications

- Available in black or silver
- Desk clamp and mounting included
- Easy assembly and flexibility
- Elastic painting process for a durable and beautiful finish
- Gas spring tension adjustment for counter-balance height adjustment for monitors 1-8 KG
- Gas spring tested to 50,000 repetitions
- Hidden cable management



COMPUTER SUPPORT  
*quadruple monitor arm*

Style Number	List Price
MA4	705

### Specifications

- Available in black
- Desk clamp and mounting included
- Easy assembly and flexibility
- Elastic painting process for a durable and beautiful finish
- Gas spring tension adjustment for counter-balance height adjustment for monitors 1-8 KG
- Gas spring tested to 50,000 repetitions
- Hidden cable management

Thinking Quietly options.

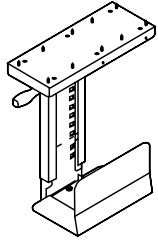

COMPUTER SUPPORT  
*cpu retractable cradle*

Style Number	List Price
K18	205

**Specifications**

- Black Metal CPU Carriage
- Full 360° swivel capability allows easy access to rear of CPU for cables / wires
- Track allows 8- 1/2" extension
- Width Adjustment 5-1/2" to 9-1/4"
- Height adjustment 14- 5/8" to 20- 1/2"
- Black epoxy finish

Notes  
- Factory Installed



DOOR MODIFICATIONS  
*soft close door hinge*

Style Number	List Price
D9SC	20 Per door

**Specifications**

- Snap onto standard door hinge
- Requires (2) per door
- Max door height 43"
- Factory installed where specified
- Individually shipped for field installation

Notes  
- Specify Each Item To Have Slow Close Feature

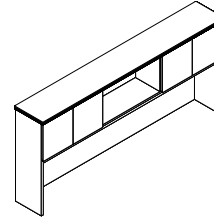

DOOR MODIFICATIONS  
*delete doors*

Style Number	List Price
D6	N/C

**Specifications**

- Standard Door overheads and cabinets can have door deleted for open access. Modification of hinge rails and structural components are made face ready.

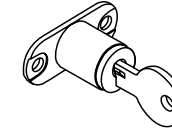

DOOR MODIFICATIONS  
*panel door lock*

Style Number	List Price
D2	100 Per door set

**Specifications**

- Door Locks - 1 Door w/ Lock, Other Door w/ Catch Latch
- Contact Customer Service regarding limited lock locations and keying.

Notes  
- Available on: Panel Doors, Wood Frame Doors, and Silverluma doors



# Thinking Quietly options.

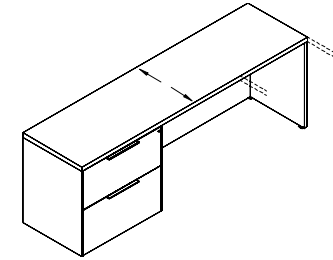
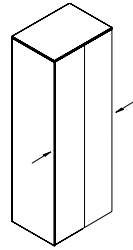
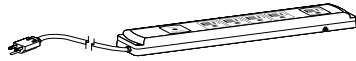

## POWER / DATA *power supply cordset*

Style Number	List Price
PD717	100

### Specifications

- SIZE: 10.75"L x 2.0"W x 1.06"H
- (5) Outlets w/ 10' cord
- Surge suppression (720 Joules)
- 15 Amp breaker
- Available on: Vertical Panels, Cabinet Interiors, and under tops

## PRODUCT MODIFICATIONS *modify width - open/closed storage*

Style Number	List Price
MOD-2	250

### Specifications

- Modify width down on any unit with open or closed storage section: storage credenzas

## PRODUCT MODIFICATIONS *modify width - outside of mod-1, mod-2*

Style Number	List Price
MOD-3	Contact for pricing

### Specifications

- Width modification outside of MOD-1 & MOD-2

## PRODUCT MODIFICATIONS *modify depth - increase depth*

Style Number	List Price
MOD-6	Add 10%

### Specifications

- Increase depth by no more than 6"

#### Notes

- Ex. 24" to 30", 30" to 36", and 36" to 42"
- Add 10% to the unit you want to increase the depth of by no more than 6"

Thinking Quietly options.

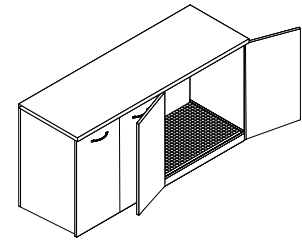

**PRODUCT MODIFICATIONS**  
*modify height*

Style Number	List Price
MOD-7	Contact for pricing

**Specifications**  
- Modify height of a unit

**PRODUCT MODIFICATIONS**  
*modify conference table length and width - 1 piece top*

Style Number	List Price
MOD-8	125

**Specifications**  
- Modify length/width on a 1 piece table top

**PRODUCT MODIFICATIONS**  
*modify conference table length and width - 2/3 piece top*

Style Number	List Price
MOD-9	250

**Specifications**  
- Modify length/width on a 2 or 3 piece table top

**REFRIGERATOR MODIFICATION**  
*refrigerator cabinet modification*

Style Number	List Price
REF01	205

**Specifications**  
 - Open back cutout for venting  
 - Moisture sponge mat  
 - Contaminate ledge  
 - Contact customer service for maximum refrigerator size (Changes based on unit).  
 - Available on: 36" and 42" Storage Credenzas

Thinking Quietly options.

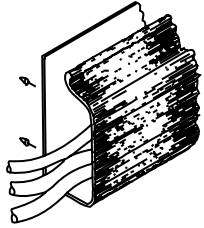

WIRE MANAGEMENT  
*horizontal j-channel wire management raceway*

Style Number	List Price
W1	80 Per 4' section

Specifications

- 4' section for field installation.
- The "J" shape black thermoplastic wire raceway may be added to specified worksurface tops to provide concealed channeling of wires to and from worksurface grommets. For use in open kneespace areas, raceway is attachable to top of back panel with pan head screws. Interior dimensions are 1" x 1- 1/2" providing ample storage for multiple wires and excess cable. Front of raceway flexes out for easy cord insertion.

- Notes
- Units w/ Wire Channel Standard.
  - Field Installation

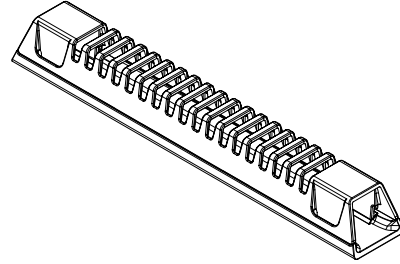

WIRE MANAGEMENT  
*horizontal wire management raceway*

Style Number	List Price
W21	35

Specifications

- 10"W x 1.5"D x 1.25"H
- Grey Wire Manager (10.5")
- Power and data cables can be discretely housed and managed with the W21 Gray Wire Manager. This can be mounted in any location to metal frame or underside of conference tables and runs cables through a 1" channel from power module to hollow steel legs. This keeps cables organized under the table top. Release clips make it simple to snap on and off the Wire Manager for easy organization and access after attached to the table

- Notes
- Field installed

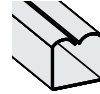

WIRE MANAGEMENT  
*horizontal u-channel wire management raceway*

Style Number	List Price
W2A	80 Per 4' section

Specifications

- 4' section for field installation.
- Notes
- Units w/ Wire Channel Standard.
  - Field Installation



WIRE MANAGEMENT  
*coil wire manager*

Style Number	List Price
W18	160

Specifications

- Weighted Base, Table attachment plate
  - 39- 1/2" Length
  - Black
- Notes
- Location

# Thinking Quietly options.

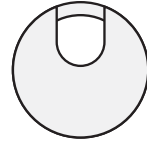
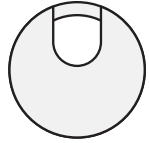

## WIRE MANAGEMENT

*standard location grommets - factory installed*

Style Number	List Price
Standard Location Grommet	
Black	
TM30	50
Silver	
TM31	50
Antique Brass	
TM33	50
White	
TM34	50

### Specifications

- 1 -5/8" Metal Grommet

#### Notes

- \*Units w/ Grommets Standard Are Noted Under Standard Features. Grommets Match Pull Finish - Standard (Unless Specified Otherwise)

## WIRE MANAGEMENT

*non-standard location grommets - factory installed*

Style Number	List Price
Non-Standard Location Grommet	
Black	
TM30 -NS	95
Silver	
TM31 -NS	95
Antique Brass	
TM33 -NS	95
White	
TM34 -NS	95

### Specifications

- 1 -5/8" Metal Grommet

#### Notes

- \*Units w/ Grommets Standard Are Noted Under Standard Features. Grommets Match Pull Finish - Standard (Unless Specified Otherwise)

## WIRE MANAGEMENT

*black plastic vertical surface grommets - factory installed*

Style Number	List Price
Standard Location Grommet	
TM50-C	50
Non-Standard Location Grommet	
TM50-NS	95

### Specifications

- 2 " Black Plastic Grommet

#### Notes

- Standard Location is Bottom Center

## power & data options.

Aircharge wireless charging grommet

Style Number	List Price
 ACWG WIRELESS GROMMET	\$195

## Specifications

- › When used with GROVE Tables an additional \$350 LIST will apply for the special cutout required.
- › AirCharge offers a convenient way to charge any Qi compatible smartphone or device without the need to carry charging cables or find an available power outlet.
- › The Aircharge is powered by the latest Qi compliant IC offering reliable and efficient wireless charging in a convenient 3" grommet hub. Simply place your phone on the Aircharge and an LED will confirm pairing and begin wireless charging.
- › Recess: Efficient space conservation and quick access
- › Input: DC 5V (with included AC power adapter), DC 9V, 1.67A (with optional QC 2.0 power adapter)
- › Output: 5 watts Max. with DC 5V, 2A power adapter, 10 watts Max. with QC 2.0 power adapter
- › Qi V1.2 compliant IC
- › Charging distance: 6mm Max.

Available: All DARRAN collections



## power & data options.

Cove power unit - non-linking

Style Number

List Price



PD-COVE PLUG

\$550

Non-linking version

### Specifications

- › Size 5.75" L x 2.5" W
- › (2) 15 Amp Receptacles and (2) USB charging ports
- › Surface Mount
- › 108" Cord
- › Standard Silver Finish, Available in White or Black Finish upon request
- › ETL Listed

Available: All DARRAN collections



## power & data options.

Cove power unit with daisylink

Style Number	List Price
--------------	------------

### STARTER UNITS



COV-DCH HARDWIRED	\$710
-------------------	-------

Includes (1) Cove unit with Hardwire Infeed - 120"



COV-DCP PLUG	\$800
--------------	-------

Includes (1) Cove unit with Plug infeed -  
Includes 72" Cord and 32" Infeed Jumper for  
104" total cord infeed

### ADDITIONAL LINKING UNITS

COV-DCL	\$575 EACH
---------	------------

Includes Linking Cove unit and Jumper up to  
96", cable length determined by the top size

## Specifications

- › Size: 5.75"L x 2.5"W
- › (2) 15 Amp Receptacles and (2) 2.1 Amp USB charging ports
- › Surface Mount
- › Max Daisy Chain - Hardwire - (9) units; Plug/Corded - (4) units
- › Standard Silver Finish, Available in White or Black Finish upon request
- › ETL Listed

Available: All DARRAN collections



## power & data options.

Cove corded series

### Style Number



PD-COVE-PKO

### List Price

\$800

## Specifications

- › Size 9.5" L x 2.5" W x 3.18" D
- › When used with GROVE Tables an additional \$350 LIST will apply for the special cutout required.
- › (2) Power Receptacles, (2) 2.1 Amp USB charging ports and (1) Telecom Plate Knockout
- › Surface Mount
- › 108" Cord
- › Standard Silver Finish, Available in White or Black Finish upon request
- › ETL Listed

Available: All DARRAN collections

### Telecom Plates

RJ45 (1)	\$35
RJ45 (2)	\$70
RJ45 (3)	\$105
USB (1)	\$70
USB (2)	\$140
RJ11/RJ45	\$70
RJ45/USB	\$105
RJ45/HDMI	\$190
HDMI/DVI	\$325
HDMI/USB	\$205
HDMI/VGA	\$240
VGA/MINI-STEREO	\$155
VGA/USB	\$175

This pod can have up to 1 total plates.

\*All telecom connectors sold separately.





## power & data options.

Dual

Style Number	List Price
STARTER UNITS	
PD-DUAL3P3J	\$1170
3 modules; 3' jumpers	
PD-DUAL3P6J	\$1185
3 modules; 6' jumpers	
PD-DUAL3P12J	\$1200
3 modules; 12' jumpers	
PD-DUAL4P3J	\$1450
4 modules; 3' jumpers	
PD-DUAL4P6J	\$1470
4 modules; 6' jumpers	
PD-DUAL4P12J	\$1490
4 modules; 12' jumpers	
PD-DUAL8P3J	\$2825
8 modules; 3' jumpers	
PD-DUAL8P6J	\$2865
8 modules; 6' jumpers	
PD-DUAL8P12J	\$2905
8 modules; 12' jumpers	

## Specifications

- > Size: 3" x 1.75" x 1.25"
- > (2) 2.4 Amp USB charging ports per module
- > Undersurface mount
- > 72" cord
- > Standard black finish, available in white upon request
- > UL certified

Available: Conference, Milner, Thinking quietly

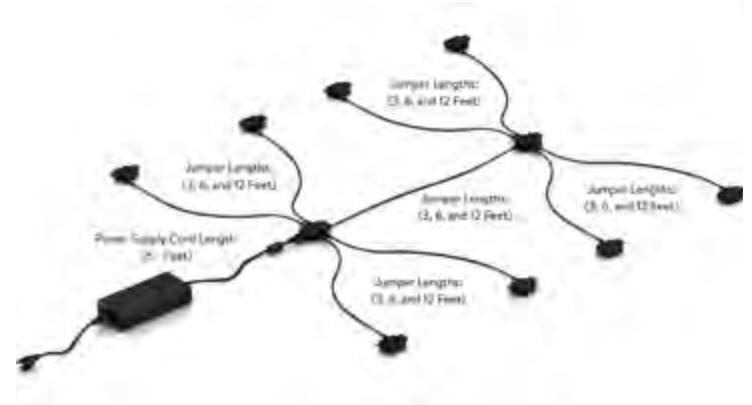

## power & data options.

Keno power unit

Style Number

List Price



PD-KENO

\$195

Select power block to link workstations

### Specifications

- > Size 5.5" L x 2.125" W x 2.5" H
- > 2 TR AC Outlets
- > 1 4.2A USB module w/ 2 charging ports
- > 10' Power cord

Available: EdgeWorks, NSS Open, Rail, Rail Open Office, ThinkingQuietly

#### Telecom Plates

With 120" hardwire power cord.

Two Pack Power Block System: 2PPBS	\$390
Four Pack Power Block System: 4PPBS	\$750
Six Pack Power Block System: 6PPBS	\$1100



White



Black

## power & data options.

Reef power unit with daisylink

Style Number	List Price
 REF310 PLUG	\$1100

## Specifications

- › Size 16.1"L x 6.25"W x 4.89"D
- › When used with GROVE Tables an additional \$350 LIST will apply for the special cutout required.
- › (3) 120V Receptacles, (2) USB charging ports, 1 Data Plate Knockout, (2) Knockouts for RJ45 Data Ports
- › Surface Mount
- › 108" Cord
- › Features Convenience Plug on bottom of unit that allows for max (3) Daisy Chain
- › Standard Black Finish, Available in White or Silver Finish upon request
- › Additional Telecom Plate Knockout
- › RJ45 for Knockouts not required. If not ordered a small hole will be present in the pod in this this location
- › ETL Listed

Available: Conferencing

Telecom Plates	
RJ45 (1)	\$35
RJ45 (2)	\$70
RJ45 (3)	\$105
USB (1)	\$70
USB (2)	\$140
RJ11/RJ45	\$70
RJ45/USB	\$105
RJ45/HDMI	\$190
HDMI/DVI	\$325
HDMI/USB	\$205
HDMI/VGA	\$240
VGA/MINI-STEREO	\$155
VGA/USB	\$175

This pod can have up to 1 total plates.  
\*All telecom connectors sold separately.



## power & data options.

Powered seamless grommet

Style Number	List Price
	
Power/Plug	
PSG82-C: PLUG	\$1875

## Specifications

- › Grommet comes with 2 Power Pods that are mounted under the Seamless Grommet. Pods daisylink together with (2) innerconnecting cables.
- › Size: 11.5" L x 8.25W"
- › (4) Power Receptacles per power pod, 8 total
- › 124" Power cord
- › Standard Black Finish
- › UL Listed
- › (2) 2.1 Dual USB ports per pod, 4 total
- › (2) Data ports per pod, 4 total

Available: Thinking quietly, Diva, EdgeWorks

Telecom Plates	
RJ45 (1)	\$35
RJ45 (2)	\$70
RJ45/HDMI	\$190
HDMI/VGA	\$240
RJ45/VGA	\$190

This pod can have up to 1 total plates.  
\*All telecom connectors sold separately.



## power & data options.

Seclusion corded power unit non-linking

Style Number	List Price
 P2SECL	\$245
Choose from plate mount or clamp mount (seen in photo)	

### Specifications

- > Size: 3.5"L x 2.2"D x 2.5"H
- > (2) Power Receptacles
- > Worksurface Clamp Mount or Plate Under Surface Mount
- > Clamp Accessory accommodates table thickness up to 2"
- > 72" Cord
- > Standard Silver Finish, Black Finish available upon request
- > UL/UCL Listed

Available: All DARRAN collections



Clamp Mount

## power & data options.

Soba wire manager

Style Number	List Price
STARTER UNITS	
SCDW	\$200
White wire manager	
SCDB	\$200
Black wire manager	

## Specifications

- › Dimensions: 9ft x 9in x 3.15in
- › Zips up, bundles and routes loose, messy cables into a single tube
- › Routes and guides cables behind desks, TVs, and anywhere cables tend to get messy
- › Accommodates large or small cables, up to three cables at once
- › Support channels, used to route cables, include powerful adhesive backing which allows easy attachment to surfaces.

Available: All DARRAN collections



## power & data options.

Tully power unit

Style Number	List Price
 PD-TULLY	\$320
Select power block to link workstations	

### Specifications

- › 5.5" W x 3.2" H x 1.81" D
- › Finish: Smooth molded plastic integrated within a single piece cover
- › Mounts to the edge of your work surface, with no table cut outs or installation required.
- › (2) Power receptacles, (2) USB 2.1 Amp ports
- › 72" Cord (10' cord available, contact customer service).
- › Standard in White. Available in gray, black, neon red, harvest pumpkin, light green, daisy blue.
- › UL310, Class 2, FCC Part 15A approved
- › Clamp accessory accomodates table thickness from .75"-1.5"

Available: EdgeWorks, NSS Open, Rail, Rail Open Office, Thinking quietly.

#### Power Block

With 120" hardwire power cord.

Two Pack Power Block System: 2PPBS	\$390
Four Pack Power Block System: 4PPBS	\$750
Six Pack Power Block System: 6PPBS	\$1100

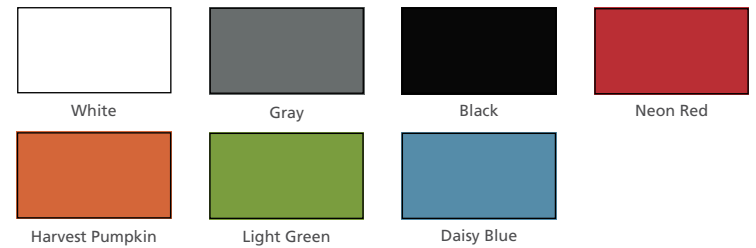

## power & data options.

Tully data power unit

Style Number	List Price
PD-TULLY-DATA	\$400

Select power block to link workstations

### Specifications

- > 5.5" W x 3.2" H x 1.81" D
- > Finish: Smooth molded plastic integrated within a single piece cover
- > Mounts to the edge of your work surface, with no table cut outs or installation required.
- > (2) Power receptacles, (2) knockouts for HDMI, VGA, or RJ45 (Please specify).
- > 72" Cord (10' cord available, contact customer service).
- > Standard in White. Available in gray, black, neon red, harvest pumpkin, light green, daisy blue.
- > UL310, Class 2, FCC Part 15A approved
- > Clamp accessory accommodates table thickness from .75"-1.5"
- > Includes 2 wire management grommets

Available: Bota booth table

Power Block	
With 120" hardwire power cord.	
Two Pack Power Block System 2PPBS	\$390
Four Pack Power Block System 4PPBS	\$750
Six Pack Power Block System 6PPBS	\$1100

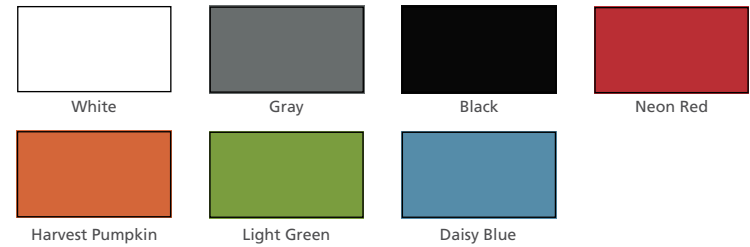



## power & data options.

VILLA Power unit - non-linking

Style Number	List Price
VIL-C PLUG Non-Linking	\$515

## Specifications

- › Size: Top Grommet 5.68" L X 3.39"W; Under Top 12"L x 3.13"W x 3.08"D
- › (2) Power receptacles; (2) USB charging ports and (1) Knockouts for RJ45 Data Ports
- › Surface Mount
- › 72" Cord (Longer cord available, contact Customer Service)
- › Standard Silver Finish, Black Finish available upon request
- › UL or ETL Certified

Available: All DARRAN collections, excludes Grove

RJ45 Knockout RJ45 (1)	\$35
---------------------------	------

