



PREMIER®

Contracted Supplier

Conferencing price list

Conferencing price list

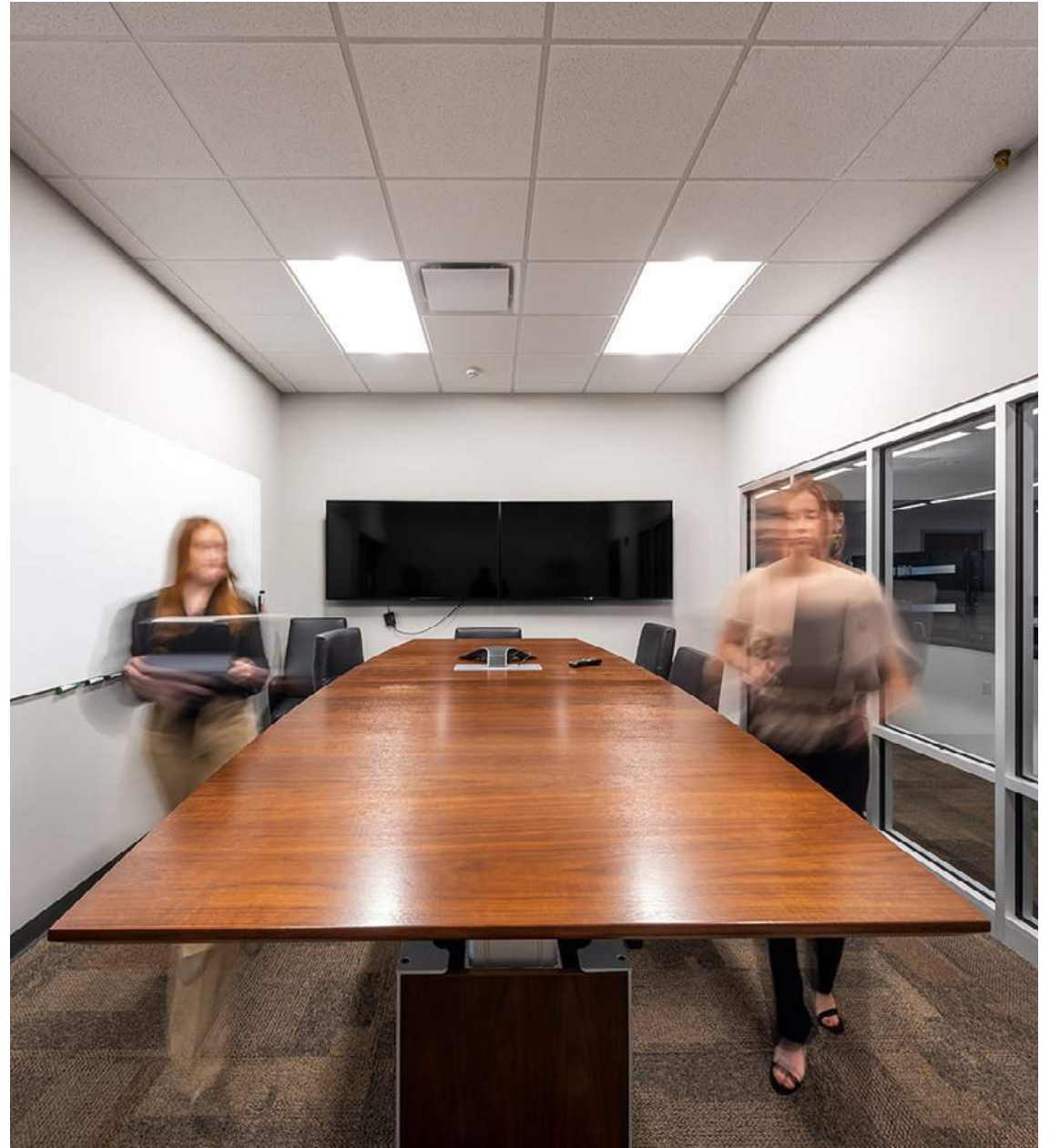

effective july 1, 2021

Conference table of contents

Statement of Line	
Features & Advantages	1
Finishes Specifications	3
Edges.....	4
Pulls Knobs	5
Grommets Grommet Reference.....	6
Ganging Height Reference	7
Tables	8
Drum Bases.....	20
Cube Bases.....	24
Modesty Trough.....	32
Panel Pedestal Bases	33
Traditional Bases	37
Metal Bases	38
Conferencing Legs.....	44
Capitol Park Conferencing	45
Central Park Conferencing.....	47
Jamestown Conferencing.....	42
Not So Square Conferencing.....	55
Prado Conferencing	58
Richmond Park Conferencing.....	60
Rift Conferencing.....	62
Options.....	71
Power & Data	78
Table Base Matrix.....	88

statement of line

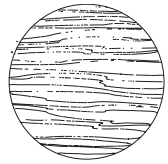

PAGE 8
Conference
Tables

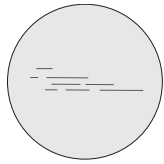

PAGE 9
Conference
Glass Tables

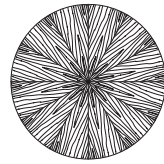

PAGE 10
Conference
Tables

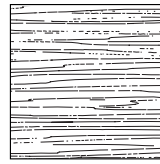

PAGE 11
Conference
Tables



PAGE 12
Conference
Glass Tables

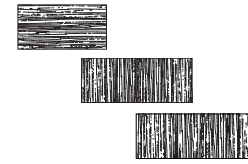

PAGE 13
Conference
Tables

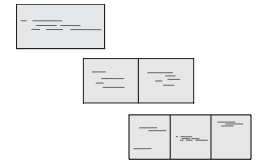

PAGE 14
Conference
Glass Tables

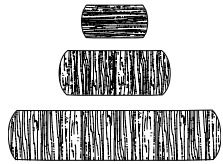

PAGE 15
Conference
Tables

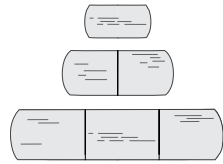

PAGE 16
Conference
Glass Tables

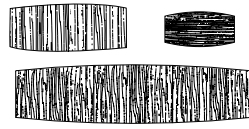

PAGE 17
Conference
Tables

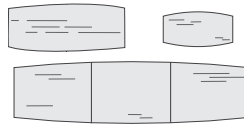

PAGE 18
Conference
Glass Tables

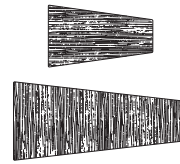

PAGE 19
Conference
Telecom
Tables

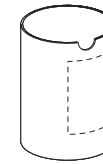

PAGE 20
Conference
Drum
Bases

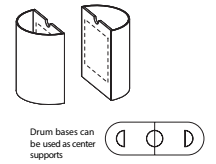

PAGE 21
Conference
Drum
Bases

Drum bases can
be used as center
supports

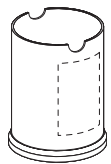
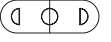

PAGE 22
Conference
Drum
Bases

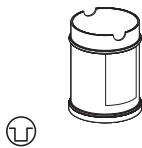

PAGE 23
Conference
Traditional
Drum
Bases

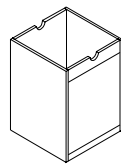

PAGE 24
Conference
Cube
Bases

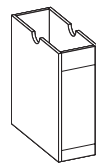

PAGE 25
Conference
Cube
Bases

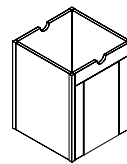

PAGE 26
Conference
Cube
Bases

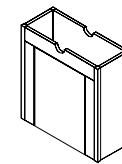

PAGE 27
Conference
Cube
Post
Bases

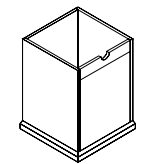

PAGE 28
Conference
Cube
Bases

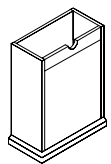

PAGE 29
Conference
Cube
Bases

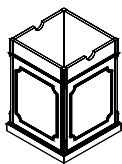

PAGE 30
Conference
Traditional
Cube
Bases

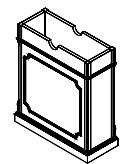

PAGE 31
Conference
Traditional
Cube
Bases

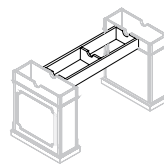

PAGE 32
Conference
Modesty
Trough / Tray
Bases

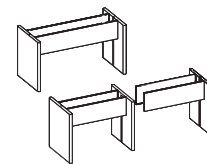

PAGE 33
Conference
Panel
Base W/ Wire
Management
Modesty

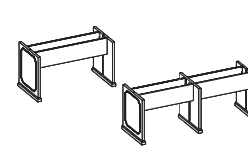

PAGE 34
Conference
Panel
Base W/ Wire
Management
Modesty

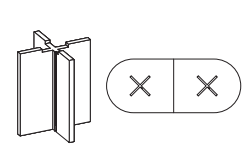

PAGE 35
Conference
Panel
Pedestal
Bases

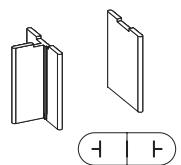

PAGE 36
Conference
Panel
Pedestal
Bases

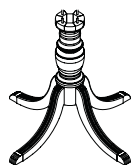

PAGE 37
Conference
Traditional
Metal
Bases

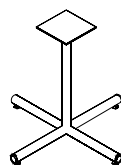

PAGE 38
Conference
Metal
Bases

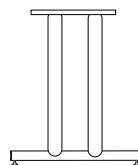

PAGE 39
Conference
Metal
Bases

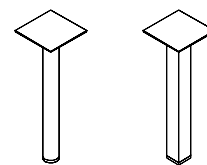

PAGE 40
Conference
Metal
Bases



PAGE 41
Conference
Metal
Bases

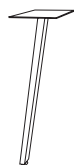

PAGE 42
Conference
Metal
Bases

statement of line

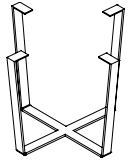

PAGE 43
Conference
Metal Bases

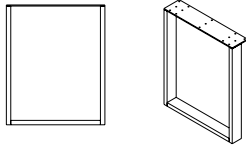

PAGE 44
Conference - Central park
Central Park Base

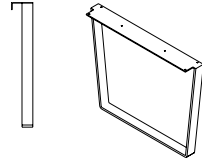

PAGE 45
Conference
Conferencing Legs

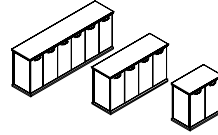

PAGE 46
Conference - Capitol park
Full Pedestal Credenzas

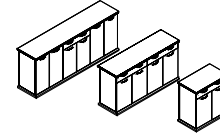

PAGE 47
Conference - Capitol park
Full Pedestal Credenzas

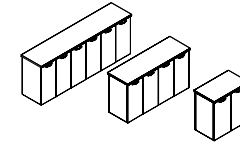

PAGE 48
Conference - Central park
Full Pedestal Credenzas

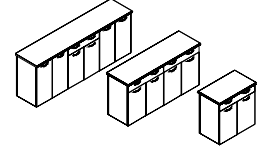

PAGE 49
Conference - Central park
Full Pedestal Credenzas

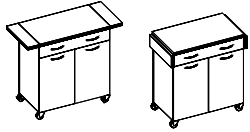

PAGE 50
Conference - Central park
Conferencing Casegoods

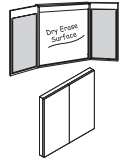

PAGE 51
Conference - Central park
Visual Boards

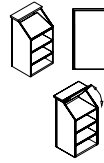

PAGE 52
Conference - Central park
Lecterns

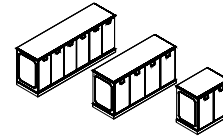

PAGE 53
Conference - Jamestown
Full Pedestal Credenzas

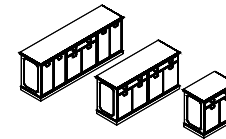

PAGE 54
Conference - Jamestown
Full Pedestal Credenzas



PAGE 55
Conference - Jamestown
Cabinets

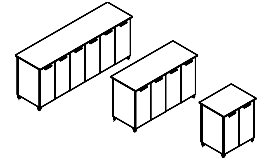

PAGE 56
Conference - NOT SO square
Full Pedestal Credenzas

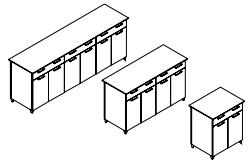

PAGE 57
Conference - NOT SO square
Storage Credenzas

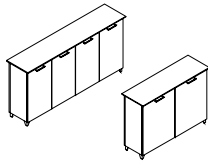

PAGE 58
Conference - NOT SO square
Storage Credenzas

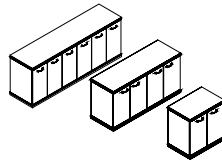

PAGE 59
Conference - Prado
Full Pedestal Credenzas

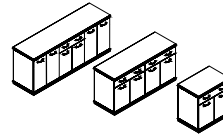

PAGE 60
Conference - Prado
Full Pedestal Credenzas

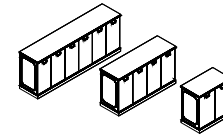

PAGE 61
Conference - Richmond park
Full Pedestal Credenzas

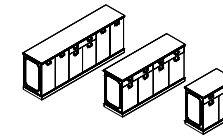

PAGE 62
Conference - Richmond park
Full Pedestal Credenzas

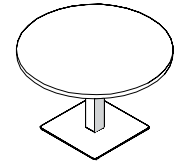

PAGE 63
Conference - Rift
Conference Table

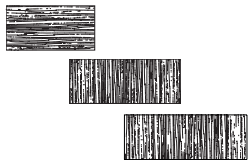

PAGE 64
Conference - Rift
Top

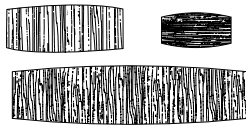

PAGE 65
Conference - Rift
Top

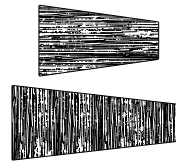

PAGE 66
Conference - Rift
Top

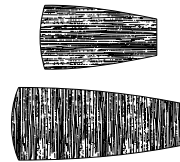

PAGE 67
Conference - Rift
Top

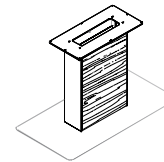

PAGE 68
Conference - Rift
Bases

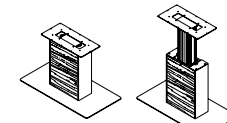

conference height bar height
PAGE 69
Conference - Rift
Bases

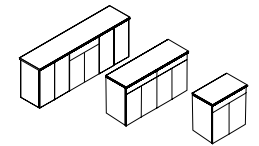

PAGE 70
Conference - Rift
Credenzas

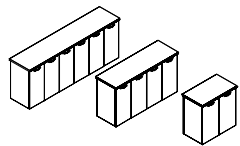

PAGE 71
Conference - Rift
Credenzas

Conference features & advantages

Veneer and HPL tops

Veneer tops and high-pressure laminate tops feature a 45-pound density substrate with balanced 3-ply construction. Tops are 1-5/16" thick. DARRAN only uses HPVA A Grade Flat Cut Cherry, Maple, and Walnut Veneers and A Grade Quartered Oak and Ash Veneers. Cherry and Walnut veneers are book-matched. Oak, Maple, and Ash Veneers are slip-matched. Veneer tops feature a 3mm external solid hardwood band, HPL tops features a 2mm flat PVC band or a 1mm laminate self-edge. Some collections feature double cut reconstituted walnut and oak veneers.

TFL tops

Thermally Fused Laminate tops feature a 45-pound density substrate with balanced 3-ply construction. Tops are 1-1/8" thick. Laminate tops feature a 2mm flat PVC band.

Chassis & pedestal

All pedestals and chassis are constructed with 3/4" thick balanced 3-ply panels. Panels are securely fastened together using rails that are bored and doweled, glued, metal reinforcement brackets and wood cleat construction. Thick end panels are pre-bored to accept a tee nut for the adjustable glide and are reinforced with pvc banding to prevent glide tear out. Glue blocks are used where 3/4" thick panels are joined, bored for tee nut to accept adjustable glide.

Overhead cabinet construction

Freestanding & wall mount

Freestanding Overhead storage cabinets are constructed of 1" and 3/4" thick balanced 3-ply panels. Panels are attached with cam fasteners in conjunction with dowels securely adhered with PVAc (white polyvinyl acetate) glue. All surface mount cabinets connect to work surface with anti-slip tape. Wall mount cabinets are mounted to the wall with steel "z" bracket attachment method using 5mm euro screws to attach to the back of the cabinet. All units ship with a steel "z" bracket. This bracket is mounted to the wall by field installers. Installers are responsible for selecting and supplying appropriate fasteners for wall conditions.

Bookcase construction

All chassis (sides, back, top and bottom panels) are constructed with 3/4" thick balanced 3-ply panels. Panels are attached with cam fasteners in conjunction with dowels securely adhered with PVAc (white polyvinyl acetate) glue. Shelves on all units are 3/4" thick balance 3 ply panels. Optional heavy duty shelves are 1" thick lumber core balanced 5 ply construction.

Tackboards

Wall mount tackboards are constructed of .75" thick fiberboard. The fabric is precisely aligned and fitted to the tackboard with a sock on cover.

Overhead storage tackboards are constructed of .5" thick fiberboard. The fabric is precisely aligned and fitted to the tackboard and adhered to the rigid hardboard with staples.

Adjustable glides

Glides provide 1" of vertical leveling adjustment. Glide bottom is durable metal.

Drawers

All drawers are constructed of four sides and a bottom, which are attached to a drawer front with screws for easy removal. Drawer fronts feature vertically matched veneer within each pedestal. Pencil trays are standard in all box drawers. Jamestown, Prado, Rift, and Spaces feature maple veneer 1/2" thick material for drawer sides, fronts and backs with a UV finish for maximum durability. Drawer bottoms are 7/32" thick 3-ply maple veneer. Drawer boxes are assemble at each corner with dowel joinery for maximum drawer strength. Capitol Park, Central Park, NSsq, Reception Park, and Richmond Park feature drawers that are 1/2" thick wood grained wrapped 5 sided miter-folded construction with 1/8" thick hardboard bottoms.

Drawer fronts

Drawer fronts are vertically matched in balanced sets. Doors feature vertical veneer bookmatched horizontally in sets of 2 / 4 and 6 doors. All drawers and doors have traditional scallop profile edge shape. All tower fronts matched in vertical sets.

Suspensions

All casegoods utilize cold rolled steel zinc plated high-grade drawer suspensions. All suspensions are warranted for the lifetime of the product. Box and File drawers are full extension, featuring steel ball bearings for a smoother quieter range of motion with soft close operation and are rated 100lbs. Lateral file drawers are a progressive action full extension suspension with the soft close operation and is rated at 150lbs. Lateral files include anti tip mechanism that will allow only one drawer at a time to be opened.

Hinges

Units with doors include 95 degree swing hinges.

Filing

Capitol Park, Central Park, NSsq, Reception Park, and Richmond Park feature a highly durable black plastic extrusion that is securely fastened into a route on top of the drawer to support hanging files. An adjustable crossbar is provided for all file drawers that enables legal/letter filing front to back or side-to-side based on the drawer size.

Jamestown, Prado, and Rift feature metal file frames around the perimeter of the drawers with cross bars secured to the drawer sides to support hanging files. A metal

Conference features & advantages

adjustable cross bar is standard with all file drawers to support letter/legal filing front to back or side to side. File drawers have one adjustable cross bar and lateral files have two adjustable cross bars. See filing reference for details.

Locks

Silver, black or bronze face locks are standard on all desks, credenzas, returns, and modular pedestals and match the color of the pull selection. Locks are optional on door storage, overhead storage, towers with doors and all door units. Each drawer pedestal is independently locked. Lock plugs are factory or field installed.

KEYING

Keying is available either factory or field installed. Factory installed keying is random.

Wire management

Wire management capabilities include standard and optional worksurface grommets. Specify W-1 under surface wire channels for organization and management of all communication wires and cords. Horizontal J-Channel wire management (Sku: W-1) is sold separately to conceal wire under worksurfaces.

Grommets

Metal grommets are provided to match the drawer pull selection. Grommet is available in black, silver, white or antique brass. Must specify standard or non-standard location. Black plastic grommets are available as an option for vertical applications.

Powerports

A large selection of powerports are available and handle power, data, docking stations and communication. See options section for selection.

LED tasklights

LED task lighting provides high efficiency, low energy lighting with a long life. Recessed light is encased in silver aluminum channel with milk lense and rounded end caps. Lights are factory installed.

Product specifications listed below:

- Diffuser creates a softer light and eliminates hot spots
- Touch dimmer switch
- Can be "daisy chained" up to 90W
- 4.6 watts per foot
- 120 LEDs per meter
- Certification: UL Listed
- 50,000 hour life span.

Size	Voltage	Wattage	Color Temp.
24" light	12Vdc	9.2	4000K
48" light	12Vdc	18.4	4000K
60" light	12Vdc	23	4000K
72" light	12Vdc	27.6	4000K

Conference finishes | specifications

STANDARD VENEER	PREMIUM VENEER	HIGH PRESSURE LAMINATE	THERMALLY FUSED LAMINATE
WAC Amber Cherry	N/A	GAC Amber Cherry	MAC Amber Cherry
WRC Caramel Cherry	N/A	N/A	N/A
WIC Crimson Cherry	N/A	GIC Crimson Cherry	N/A
WEC Ebony on Cherry	N/A	GEC Ebony	MEC Ebony
WHC Honey Cherry	N/A	GHC Honey Cherry	MHC Honey Cherry
WOC KoKo Cherry	N/A	GOC KoKo Cherry	MOC KoKo Cherry
WAM Alabaster Maple	N/A	GAM Alabaster Maple	N/A
WCM Clear Maple	N/A	GCM Clear Maple	N/A
WWM Wheat Maple	N/A	GWM Wheat Maple	N/A
N/A	WBO Blush Oak	N/A	N/A
N/A	WMO Mocha Oak	N/A	N/A
N/A	WNO Natural Oak	N/A	N/A
N/A	WSO Salted Oak	N/A	N/A
WEW Executive Walnut	N/A	GEW Executive Walnut	N/A
WGW Gunstock Walnut	N/A	N/A	MGW Gunstock Walnut
WBW Henna Walnut	N/A	N/A	N/A
WSW Smokey Walnut	N/A	N/A	N/A
WNW Natural Walnut	N/A	GNW Natural Walnut	N/A
N/A	TBCO Baby's Cheek	N/A	N/A
N/A	TBSW Brown Sugar	N/A	N/A
N/A	TOBW Organic Brown	N/A	N/A
N/A	TSTV Studio Teak Walnut	GSTV Studio Teak Walnut +10%	MTW Studio Teak Walnut
N/A	TSMV Seattle Mist	N/A	N/A
N/A	TSLV Skyline Walnut	GSLV Skyline Walnut + 10%	MSW Skyline Walnut
WWP Designer White Paint	N/A	GWL Designer White	MWL Designer White
PO01 Olive	N/A	N/A	N/A
PO02 Aquavert	N/A	N/A	N/A
PO03 Mushroom	N/A	N/A	N/A
PO04 Burgundy	N/A	N/A	N/A
PO05 Ash	N/A	N/A	N/A
PO06 Powder	N/A	N/A	N/A
PO07 Pebble	N/A	N/A	N/A
PO08 Vapour	N/A	N/A	N/A
PO09 Verde	N/A	N/A	N/A
N/A	N/A	LA01 Bleu Spazio + 20%	N/A
N/A	N/A	LA02 Verde Chairò + 20%	N/A
N/A	N/A	LF01 New Burgundy	N/A
N/A	N/A	LF02 Just Rose	N/A
N/A	N/A	LP01 Surfin USA	N/A
N/A	N/A	LP02 Royal Blue Suede	N/A
N/A	N/A	LN01 Cafe Sienna	N/A

HPL TOPS ON TFL PRODUCTS Add 10% - Available with flat edge only Send 3x3 or larger finish chip for color match. Custom finish upcharge is 3% or \$250 Net (whichever is greater).

Finish

ENVI-CT Green Certified European Technology. Coatings Finish.

Conference edges

Standard profile

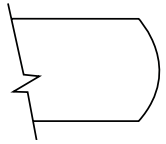

Bullnose

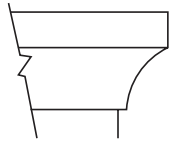

Capitol Park

3mm solid
hardwood band

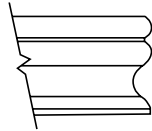

Cobee

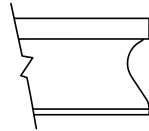

Cove

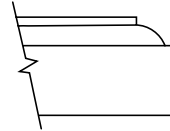

Classic

"W" 3mm solid
hardwood band

"G" HPL self edge

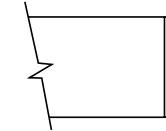

Classic

"W" 3mm solid
hardwood band

"P" 3mm solid
hardwood band

"G" HPL self edge

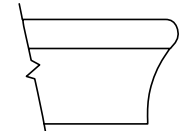

Knife

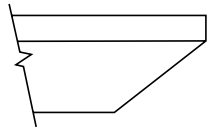

Ledge

"W" 3mm solid
hardwood band

"P" 3mm solid
hardwood band

"G" HPL self edge

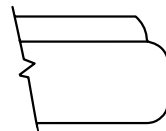

Ogee

"W" 3mm solid
hardwood band

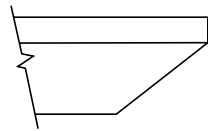

NSS Bevel

"W" 3mm solid
hardwood band

"G" HPL self edge

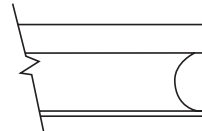

Prado

"W" 3mm solid
hardwood band

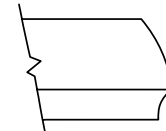

Radius

"W" 3mm solid
hardwood band

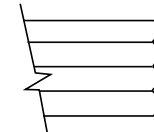

Reed

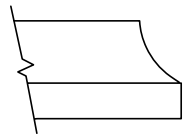

Richmond Park

3mm solid
hardwood band

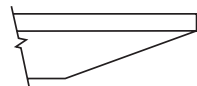

Rift

Rift Profile - Standard
on tables. Only
Available on Table
Desk where option is
shown. Hardwood Rim
Band Species Same As
Surface Veneer

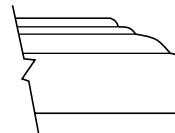

Traditional

"W" 3mm solid
hardwood band

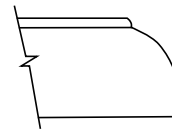

Waterfall

"M" Standard profile

Central Park Edges for "M" Styles
1 mm PVC Edge with Black Foil

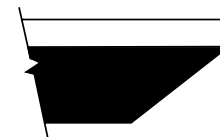

NSS Bevel

2 mm PVC Edge
with Black Foil

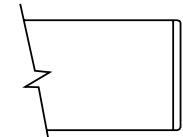

Flat

2 mm PVC
Edge

Conference pulls | knobs

Pulls/knobs

Factory Installed



PL-4 Antique Brass



PL-5 Antique Brass
PL-50 Brushed Pewter

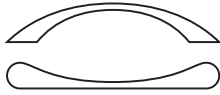

PL-105 Matte Black
PL-106 Matte Nickel

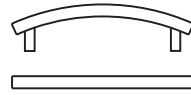

PL-112 Matte Black
PL-113 Matte Nickel

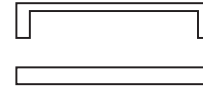

PL-115 Matte Black
PL-116 Matte Nickel

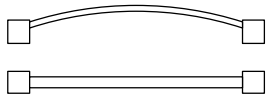

PL-125 Antique Pewter
PL-126 Antique English
PL-127 Matte Black

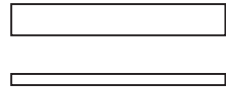

PL-210 Anodized Aluminum



PL-220 Antique Pewter
PL-221 Matte Black

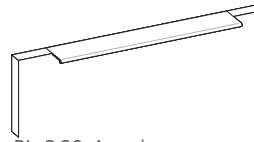

PL-260 Auminum
PL-261 White

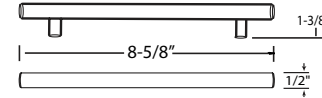

PL-310 Stainless Steel
PL-311 Royal Brass

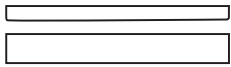

PL-300 Matte Chrome
PL-301 Matte Chrome
PL-302 White
PL-303 White

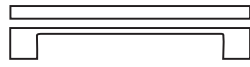

PL-304 Matte Chrome
PL-305 Matte Chrome
PL-306 White
PL-307 White

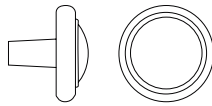

DK-4 Antique Brass

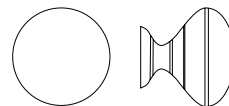

DK-114 Brushed Pewter

Finger pulls

Arrow indicates finger pull location

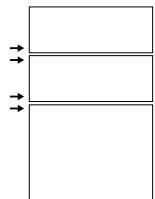

b/b/f

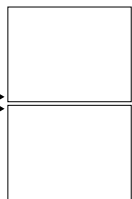

f/f

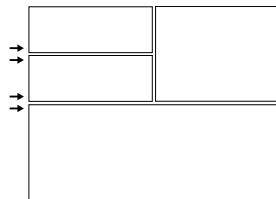

multi

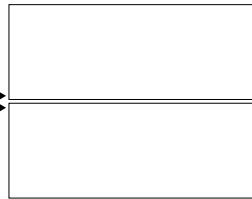

lateral/lateral

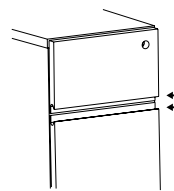

finger pull side view

Conference grommets | grommet reference

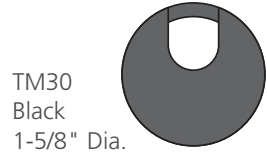

TM30
Black
1-5/8" Dia.

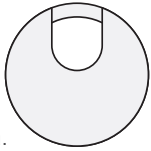

TM31
Silver
1-5/8" Dia.

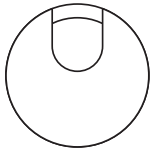

TM34
White
1-5/8" Dia.

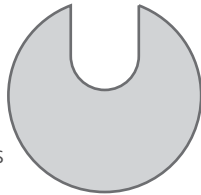

TM33
Antique Brass
2-1/2" Dia.

Optional grommets

Factory Installed

Grommets (Standard Location)

Specify Color and Left/Right/Center - \$50 ea.

- Black: TM30-R (Right), TM30-L (Left), TM30-C (Center)

- Silver: TM31-R (Right), TM31-L (Left), TM31-C (Center)

- Antique Brass: TM33-R (Right), TM33-L (Left), TM33-C (Center)

- White: TM34-R (Right), TM34-L (Left), TM34-C (Center)

Grommets (Non-Standard Location)

Provide drawing w/ Grommet Location and Specify Color - \$95 ea.

- Black: TM30-NS

- Silver: TM31-NS

- Antique Brass: TM33-NS

- White: TM34-NS

TM50
Black
1-5/8" Dia.

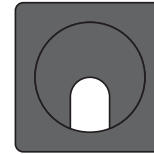

Grommets (vertical surface)

Standard Location - \$50 ea.

- Black Plastic Vertical Surface: TM50-C (Bottom Center)

Non-Standard Location - \$95 ea.

- Black Plastic Vertical Surface: TM50-NS

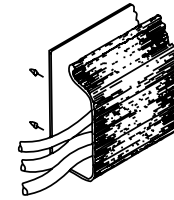

W1

Horizontal J-Channel

Horizontal J-Channel wire management (Sku: W-1) is sold separately to conceal wire under worksurfaces.

Conference ganging | height reference

Ganging – Flush Cut Modification

30”H Casegood Worksurface & Base Ganging Modifications

Depending on style some casegoods are shaped on the ends. For those collections to gang two casegood units, each unit end to be ganged must be flush cut modified for gapless surfaces and cabinet chassis.

Order Option:

- FC-B: Flush Unit Both Sides(Facing) for Ganging - \$100
- FC-L: Flush Unit Left (Facing) for Ganging - \$100
- FC-R: Flush Unit Right (Facing) for Ganging - \$100

Flush cut modification per unit includes all modifications to gang to one end or both ends when units are ganged. Modification includes tops, base and molding.

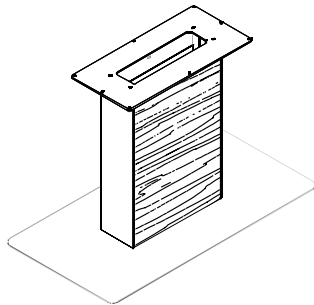

Height adjustable bases range from 29" to 49". Maximum weight capacity of 350 lbs.

Modification reduces width size approximately 1" per end.

Overhead consoles and towers are offered freestanding and ganging – inclusive of flush cut modifications.

Example:

RPC3121100W Two Drawer Lateral File (Left) Flush Cut Right – FC-R...\$100

RPC7221054 Kneespace Credenza (Right) Flush Cut Left – FC-L...\$100

Conference.

Tables
Round

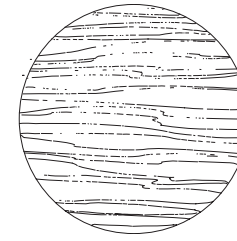

1 Select a model

w" x d" x h"

weight	Standard Veneer Top		Premium Veneer Top		High Pressure Laminate Top		Thermally Fused Laminate Top	
60 DIA x 1-1/2"	125	TBT6060RD500W 2678	TBT6060RD500P 2946	TBT6060RD500G 2678	TBT6060RD500M 815			
54 DIA x 1-1/2"	95	TBT5454RD500W 2368	TBT5454RD500P 2605	TBT5454RD500G 2368	TBT5454RD500M 686			
48 DIA x 1-1/2"	85	TBT4848RD500W 1901	TBT4848RD500P 2091	TBT4848RD500G 1901	TBT4848RD500M 630			
42 DIA x 1-1/2"	75	TBT4242RD500W 1620	TBT4242RD500P 1782	TBT4242RD500G 1620	TBT4242RD500M 596			
36 DIA	50	TBT3636RD500W 1418	TBT3636RD500P 1560	TBT3636RD500G 1418	TBT3636RD500M 551			

[View statement of line](#)

Product features.

- ENVI-CT Finish *Environmental Coatings Technology
- 1-5/16" thick top

Seating accommodations.

- 60" diameter seats six
- 54" diameter seats four to six
- 48" and 42" diameter seats four
- 36" diameter seats three to four to five

2 Select a finish

[View finish details](#)

WAC	WWM	PO02	TBCO	WSO	GAC	GNW	LP01	MAC
WRC	WEW	PO03	TBSW		GIC	GSTV + %10	LP02	MEC
WIC	WGW	PO04	TSTV		GEC	GSLV + %10		MHC
WEC	WBW	PO05	TSMV		GHC	GWL		MOC
WHC	WSW	PO06	TSLV		GOC	LA01 + 20%		MGW
WOC	WNW	PO07	TOBW		GAM	LA02 + 20%		MTW
WAM	WWP		WBO		GCM	LF01		MSW
WCM	PO01		WMO		GWM	LF02		MWL
			WNO		GEW	LN01		

3 Select a edge

[View edge details](#)

Bullnose	Capitol	Classic	Cobee	Flat	Ledge	5%	Capitol	Classic	Cobee	Flat	NSS Bevel
Cove	Flat	Knife	Ledge	Cove	Flat	Knife	Ledge				
Reed	Radius	Traditional	Waterfall	Reed	5%	Traditional	Waterfall				

4 Select hardware





[View hardware details](#)

Hardware N/A	Hardware N/A	Hardware N/A	Hardware N/A
-----------------	-----------------	-----------------	-----------------

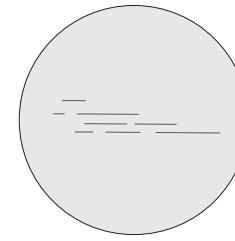
Conference.

Glass Tables
Round



1 Select a model w" x d" x h"	weight	White Glass Gloss Finish		Black Glass Gloss Finish		White Glass SoftEtch™ Finish		Black Glass SoftEtch™ Finish	
		60 DIA x 1-1/2"	290	TBT6060RD500SW	5788	TBT6060RD500SB	5578	TBT6060RD500EW	5788
54 DIA x 1-1/2"	225	TBT5454RD500SW	4834	TBT5454RD500SB	4834	TBT5454RD500EW	4834	TBT5454RD500EB	4834
48 DIA x 1-1/2"	190	TBT4848RD500SW	3978	TBT4848RD500SB	3978	TBT4848RD500EW	3978	TBT4848RD500EB	3978
42 DIA x 1-1/2"	155	TBT4242RD500SW	3222	TBT4242RD500SB	3222	TBT4242RD500EW	3222	TBT4242RD500EB	3222
2 Select a finish <i>View finish details</i>	Finish N/A			Finish N/A		Finish N/A		Finish N/A	
3 Select a edge <i>View edge details</i>	 Infinity			 Infinity		 Infinity		 Infinity	
4 Select hardware <i>View hardware details</i>	Hardware N/A			Hardware N/A		Hardware N/A		Hardware N/A	

[View statement of line](#)

Product features.

- Subtop is recessed 3" and edge is finished to match glass
- Glass features flat polished edge
- Custom back painted colors available upon quote
- Glass is 1/2" thick with 1-1/4" subtop

NOTES

- Any Sherwin Williams, Benjamin Moore or Valspar custom back painted glass color is available for a one-time fee per order for \$1475 list.
- DARRAN makes every effort to produce back painted glass with the best available low iron material for color consistency. Low iron glass is a natural material with slight variation from sheet to sheet.

Seating accommodations.

- 60" diameter seats six
- 54" diameter seats four to six
- 48" and 42" diameter seats four to five

Conference.

Tables
Sunburst Round

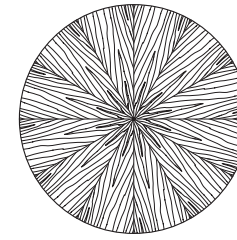

1 Select a model

w" x d" x h"

weight

	Standard Veneer Top	Premium Veneer Top	High Pressure Laminate Top	Thermally Fused Laminate Top
60 DIA x 1-1/2"	125 TBT6060SB500W 3254	TBT6060SB500P 3580	"G" Option N/A	"M" Option N/A
54 DIA x 1-1/2"	95 TBT5454SB500W 2853	TBT5454SB500P 3139	"G" Option N/A	"M" Option N/A
48 DIA x 1-1/2"	85 TBT4848SB500W 2205	TBT4848SB500P 2426	"G" Option N/A	"M" Option N/A
42 DIA x 1-1/2"	75 TBT4242SB500W 1946	TBT4242SB500P 2141	"G" Option N/A	"M" Option N/A
2 Select a finish <i>View finish details</i>				
	WAC WEW WRC WGW WIC WBW WHC WSW WOC WNW WAM WCM WWM	WBO WMO WNO WSO		
3 Select a edge <i>View edge details</i>				
	Bullnose Capitol Classic Cobee	Bullnose Capitol Classic Cobee		
	Cove Flat Knife Ledge	Cove Flat Knife Ledge		
	Reed Radius Traditional Waterfall	Reed Radius Traditional Waterfall		
4 Select hardware <i>View hardware details</i>				
	Hardware N/A	Hardware N/A		

[View statement of line](#)

Product features.

- ENVI-CT Finish *Environmental Coatings Technology
- 1-5/16" thick top

Seating accommodations.

- 60" diameter seats six
- 54" diameter seats four to six
- 48" and 42" diameter seats four to five
- 36" diameter seats three to four

Conference.

Tables
Square

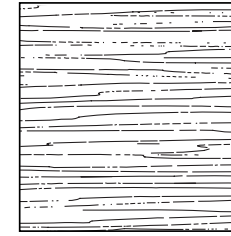

1 Select a model

w" x d" x h"

weight	Standard Veneer Top		Premium Veneer Top		High Pressure Laminate Top		Thermally Fused Laminate Top	
60 x 60 x 1-1/2"	125	TBT6060SQ500W 2139	TBT6060SQ500P 2353	TBT6060SQ500G 2139	TBT6060SQ500M 815			
54 x 54 x 1-1/2"	95	TBT5454SQ500W 1915	TBT5454SQ500P 2107	TBT5454SQ500G 1915	TBT5454SQ500M 686			
48 x 48 x 1-1/2"	85	TBT4848SQ500W 1525	TBT4848SQ500P 1678	TBT4848SQ500G 1525	TBT4848SQ500M 630			
42 x 42 x 1-1/2"	75	TBT4242SQ500W 1459	TBT4242SQ500P 1605	TBT4242SQ500G 1459	TBT4242SQ500M 596			

[View statement of line](#)

Product features.

- ENVI-CT Finish *Environmental Coatings Technology
- 1-5/16" thick top

Seating accommodations.

- 60" seats eight
- 54" seats four to five
- 48" and 42" seats four

2 Select a finish

[View finish details](#)

WAC	WWM	PO02	TBCO	WSO	GAC	GNW	LP01	MAC
WRC	WEW	PO03	TBSW		GIC	GSTV + %10	LP02	MEC
WIC	WGW	PO04	TSTV		GEC	GSLV + %10		MHC
WEC	WBW	PO05	TSMV		GHC	GWL		MOC
WHC	WSW	PO06	TSLV		GOC	LA01 + 20%		MGW
WOC	WNW	PO07	TOBW		GAM	LA02 + 20%		MTW
WAM	WWP		WBO		GCM	LF01		MSW
WCM	PO01		WMO		GWM	LF02		MWL
			WNO		GEW	LN01		

3 Select a edge

[View edge details](#)

Bullnose	Capitol	Classic	Cobee	Flat	Ledge	5% Bullnose	Capitol	Classic	Cobee	Flat	NSS Bevel
Cove	Flat	Knife	Ledge	Cove	Flat	Knife	Ledge				
Reed	Radius	Traditional	Waterfall	Reed	5% Radius	Traditional	Waterfall				

4 Select hardware

[View hardware details](#)





Hardware N/A	Hardware N/A	Hardware N/A	Hardware N/A
-----------------	-----------------	-----------------	-----------------

Conference.

Glass Tables
Square

1 Select a model w" x d" x h"	weight	White Glass Gloss Finish		Black Glass Gloss Finish		White Glass SoftEtch™ Finish		Black Glass SoftEtch™ Finish	
		60 x 60 x 1-1/2"	290	TBT6060SQ500SW	5403	TBT6060SQ500SB	5403	TBT6060SQ500EW	5403
54 x 54 x 1-1/2"	225	TBT5454SQ500SW	4564	TBT5454SQ500SB	4564	TBT5454SQ500EW	4564	TBT5454SQ500EB	4564
48 x 48 x 1-1/2"	190	TBT4848SQ500SW	3812	TBT4848SQ500SB	3812	TBT4848SQ500EW	3812	TBT4848SQ500EB	3812
42 x 42 x 1-1/2"	155	TBT4242SQ500SW	3139	TBT4242SQ500SB	3139	TBT4242SQ500EW	3139	TBT4242SQ500EB	3139

2 Select a finish <i>View finish details</i>	White Glass	Black Glass	White Glass	Black Glass
Finish N/A	Finish N/A	Finish N/A	Finish N/A	Finish N/A

3 Select a edge <i>View edge details</i>	White Glass	Black Glass	White Glass	Black Glass
 Infinity	 Infinity	 Infinity	 Infinity	

4 Select hardware <i>View hardware details</i>	White Glass	Black Glass	White Glass	Black Glass
Hardware N/A	Hardware N/A	Hardware N/A	Hardware N/A	Hardware N/A

[View statement of line](#)

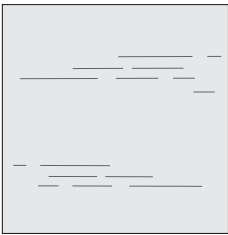

Product features.

- Subtop is recessed 3" and edge is finished to match glass
- Glass features flat polished edge
- Custom back painted colors available upon quote
- Glass is 1/2" thick with 1-1/4" subtop

NOTES

- Any Sherwin Williams, Benjamin Moore or Valspar custom back painted glass color is available for a one-time fee per order for \$1475 list.
- DARRAN makes every effort to produce back painted glass with the best available low iron material for color consistency. Low iron glass is a natural material with slight variation from sheet to sheet.

Seating accommodations.

- 60" seats eight
- 54" seats four to five
- 48" and 42" seats four

Conference.

Tables
Rectangle

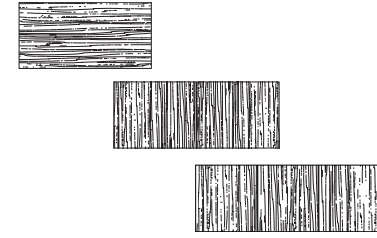

1 Select a model

w" x d" x h"

weight	Standard Veneer Top	Premium Veneer Top	High Pressure Laminate Top	Thermally Fused Laminate Top
3 Piece Top				
240 x 60 x 1-1/2"	615 TBT24060RE500W 8894	TBT24060RE500P 9784	TBT24060RE500G 8894	TBT24060RE500M 2845
240 x 54 x 1-1/2"	555 TBT24054RE500W 8777	TBT24054RE500P 9655	TBT24054RE500G 8777	TBT24054RE500M 2801
2 Piece Top				
216 x 60 x 1-1/2"	555 TBT21660RE500W 7559	TBT21660RE500P 8315	TBT21660RE500G 7559	TBT21660RE500M 2419
216 x 54 x 1-1/2"	505 TBT21654RE500W 7465	TBT21654RE500P 8212	TBT21654RE500G 7465	TBT21654RE500M 2385
192 x 54 x 1-1/2"	450 TBT19254RE500W 5923	TBT19254RE500P 6516	TBT19254RE500G 5923	TBT19254RE500M 1822
168 x 54 x 1-1/2"	330 TBT16854RE500W 5764	TBT16854RE500P 6341	TBT16854RE500G 5764	TBT16854RE500M 1772
144 x 48 x 1-1/2"	250 TBT14448RE500W 5257	TBT14448RE500P 5783	TBT14448RE500G 5257	TBT14448RE500M 1615
120 x 48 x 1-1/2"	210 TBT12048RE500W 4916	TBT12048RE500P 5408	TBT12048RE500G 4916	TBT12048RE500M 1587
1 Piece Top				
96 x 48 x 1-1/2"	170 TBT9648RE500W 2953	TBT9648RE500P 3249	TBT9648RE500G 2953	TBT9648RE500M 957
84 x 42 x 1-1/2"	130 TBT8442RE500W 2854	TBT8442RE500P 3140	TBT8442RE500G 2854	TBT8442RE500M 855
72 x 36 x 1-1/2"	100 TBT7236RE500W 2436	TBT7236RE500P 2680	TBT7236RE500G 2436	TBT7236RE500M 760

[View statement of line](#)

2 Select a finish

[View finish details](#)

WAC	WWM	PO02	TBCO	WSO	GAC	GNW	LP01	MAC
WRC	WEW	PO03	TBSW		GIC	GSTV + %10	LP02	MEC
WIC	WGW	PO04	TSTV		GEC	GSLV + %10		MHC
WEC	WBW	PO05	TSMV		GHC	GWL		MOC
WHC	WSW	PO06	TSLV		GOC	LA01 + 20%		MGW
WOC	WNW	PO07	TOBV		GAM	LA02 + 20%		MTW
WAM	WWP		WBO		GCM	LF01		MSW
WCM	PO01		WMO		GWM	LF02		MWL
			WNO		GEW	LN01		

3 Select an edge

[View edge details](#)

Bullnose	Capitol	Classic	Cobee	Flat	Ledge	5% Bullnose	5% Capitol	5% Classic	5% Cobee	Flat	NSS Bevel
Cove	Flat	Knife	Ledge	Cove	Flat	Knife	Ledge	Cove	Flat	Knife	Ledge
Reed	Radius	Traditional	Waterfall	Reed	5% Radius	5% Traditional	5% Waterfall	Reed	5% Radius	5% Traditional	5% Waterfall

4 Select hardware

[View hardware details](#)

Hardware	Hardware	Hardware	Hardware
N/A	N/A	N/A	N/A

Product features.

- ENVI-CT Finish *Environmental Coatings Technology
- 1-5/16" thick top

Seating accommodations.

- 240" seats sixteen to eighteen
- 216" seats twelve to fourteen
- 192" seats ten to twelve
- 168" seats ten
- 144" and 120" seats eight to ten
- 96" and 84" seats eight
- 72" seats six to eight

Options.





POWER

- REF-310: Reef power unit with daisylink - \$1100 ea
- PD-Cove-PKO: Cove corded series - \$800 ea
- FPDB: Flush power/data bay
- Hardwired: FPDB-H72: 72" Cord - \$1250. FPDB-H108: 108" Cord - \$1300. FPDB-H144: 144" Cord - \$1350. FPDB-H180: 180" Cord - \$1400.
- Power/Plug: FPDB-C72: 72" Cord - \$1250. FPDB-C108: 108" Cord - \$1300. FPDB-C144: 144" Cord - \$1350. FPDB-C180: 180" Cord - \$1400

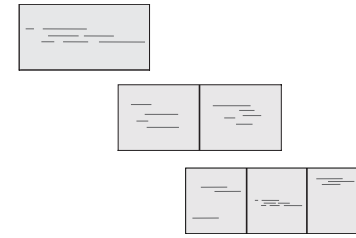
Conference.

Glass Tables
Rectangle



1 Select a model w" x d" x h"	weight	White Glass Gloss Finish		Black Glass Gloss Finish		White Glass SoftEtch™ Finish		Black Glass SoftEtch™ Finish	
3 Piece Top									
240 x 60 x 1-1/2"	1270	TBT24060RE500SW	19464	TBT24060RE500SB	19464	TBT24060RE500EW	19464	TBT24060RE500EB	19464
240 x 54 x 1-1/2"	1145	TBT24054RE500SW	17742	TBT24054RE500SB	17742	TBT24054RE500EW	17742	TBT24054RE500EB	17742
2 Piece Top									
216 x 60 x 1-1/2"	1145	TBT21660RE500SW	17654	TBT21660RE500SB	17654	TBT21660RE500EW	17654	TBT21660RE500EB	17654
216 x 54 x 1-1/2"	1035	TBT21654RE500SW	16120	TBT21654RE500SB	16120	TBT21654RE500EW	16120	TBT21654RE500EB	16120
192 x 54 x 1-1/2"	920	TBT19254RE500SW	14529	TBT19254RE500SB	14529	TBT19254RE500EW	14529	TBT19254RE500EB	14529
168 x 54 x 1-1/2"	740	TBT16854RE500SW	12740	TBT16854RE500SB	12740	TBT16854RE500EW	12740	TBT16854RE500EB	12740
144 x 48 x 1-1/2"	565	TBT14448RE500SW	10130	TBT14448RE500SB	10130	TBT14448RE500EW	10130	TBT14448RE500EB	10130
120 x 48 x 1-1/2"	470	TBT12048RE500SW	8476	TBT12048RE500SB	8476	TBT12048RE500EW	8476	TBT12048RE500EB	8476
1 Piece Top									
96 x 48 x 1-1/2"	380	TBT9648RE500SW	7103	TBT9648RE500SB	7103	TBT9648RE500EW	7103	TBT9648RE500EB	7103
84 x 42 x 1-1/2"	290	TBT8442RE500SW	5585	TBT8442RE500SB	5585	TBT8442RE500EW	5585	TBT8442RE500EB	5585
72 x 36 x 1-1/2"	220	TBT7236RE500SW	4430	TBT7236RE500SB	4430	TBT7236RE500EW	4430	TBT7236RE500EB	4430
2 Select a finish <i>View finish details</i>		Finish N/A		Finish N/A		Finish N/A		Finish N/A	
3 Select a edge <i>View edge details</i>		 Infinity		 Infinity		 Infinity		 Infinity	
4 Select hardware <i>View hardware details</i>		Hardware N/A		Hardware N/A		Hardware N/A		Hardware N/A	

[View statement of line](#)

Product features.

- Subtop is recessed 3" and edge is finished to match glass
- Glass features flat polished edge
- Custom back painted colors available upon quote
- Glass is 1/2" thick with 1-1/4" subtop

NOTES

- Any Sherwin Williams, Benjamin Moore or Valspar custom back painted glass color is available for a one-time fee per order for \$1475 list.
- DARRAN makes every effort to produce back painted glass with the best available low iron material for color consistency. Low iron glass is a natural material with slight variation from sheet to sheet.

Seating accommodations.

- 240" seats sixteen to eighteen
- 216" seats twelve to fourteen
- 192" seats ten to twelve
- 168" seats ten
- 144" and 120" seats eight to ten
- 96" and 84" seats eight
- 72" seats six to eight

Options.

POWER

- Add \$125 per power pod when specifying power on a glass conference table top
- REF-310: Reef power unit with daisylink - \$1100 ea
- PD-Cove-PKO: Cove corded series - \$800 ea
- FPDB: Flush power/data bay
- Hardwired: FPDB-H72: 72" Cord - \$1250. FPDB-H108: 108" Cord - \$1300. FPDB-H144: 144" Cord - \$1350. FPDB-H180: 180" Cord - \$1400.
- Power/Plug: FPDB-C72: 72" Cord - \$1250. FPDB-C108: 108" Cord - \$1300. FPDB-C144: 144" - Cord \$1350. FPDB-C180: 180" Cord - \$1400

Conference.

Tables
Arc End

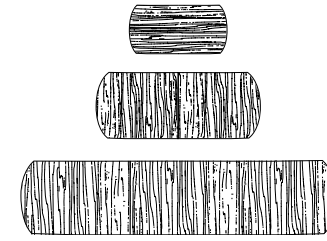

1 Select a model w" x d" x h"	weight	Standard Veneer Top		Premium Veneer Top		High Pressure Laminate Top		Thermally Fused Laminate Top	
3 Piece Top									
240 x 60 x 1-1/2"	590	TBT24060AR500W	9339	TBT24060AR500P	10273	TBT24060AR500G	9339	TBT24060AR500M	2989
240 x 54 x 1-1/2"	535	TBT24054AR500W	9214	TBT24054AR500P	10135	TBT24054AR500G	9214	TBT24054AR500M	2942
2 Piece Top									
216 x 60 x 1-1/2"	535	TBT21660AR500W	7936	TBT21660AR500P	8730	TBT21660AR500G	7936	TBT21660AR500M	2540
216 x 54 x 1-1/2"	485	TBT21654AR500W	7838	TBT21654AR500P	8622	TBT21654AR500G	7838	TBT21654AR500M	2504
192 x 54 x 1-1/2"	430	TBT19254AR500W	6219	TBT19254AR500P	6841	TBT19254AR500G	6219	TBT19254AR500M	1915
168 x 54 x 1-1/2"	310	TBT16854AR500W	6052	TBT16854AR500P	6658	TBT16854AR500G	6052	TBT16854AR500M	1861
144 x 48 x 1-1/2"	230	TBT14448AR500W	5520	TBT14448AR500P	6072	TBT14448AR500G	5520	TBT14448AR500M	1696
120 x 48 x 1-1/2"	190	TBT12048AR500W	5419	TBT12048AR500P	5961	TBT12048AR500G	5419	TBT12048AR500M	1666
1 Piece Top									
96 x 48 x 1-1/2"	150	TBT9648AR500W	3100	TBT9648AR500P	3410	TBT9648AR500G	3100	TBT9648AR500M	1005
84 x 42 x 1-1/2"	110	TBT8442AR500W	2995	TBT8442AR500P	3295	TBT8442AR500G	2995	TBT8442AR500M	898
72 x 36 x 1-1/2"	100	TBT7236AR500W	2557	TBT7236AR500P	2813	TBT7236AR500G	2557	TBT7236AR500M	799
2 Select a finish <i>View finish details</i>		WAC WWM PO02 WRC WEW PO03 WIC WGW PO04 WEC WBW PO05 WHC WSW PO06 WOC WNW PO07 WAM WWP WCM PO01		TBCO WSO TBSW TSTV TSMV TSLV TOBWO WBO WMO WNO		GAC GNW LP01 GIC GSTV + %10LP02 GEC GSLV + %10 GHC GWL GOC LA01 + 20% GAM LA02 + 20% GCM LF01 GWM LF02 GEW LN01		MAC MEC MHC MOC MGW MTW MSW MWL	
3 Select an edge <i>View edge details</i>		Bullnose Capitol Classic Cobee Cove Flat Knife Ledge Reed Radius Traditional Waterfall		Flat Ledge		5% Bullnose Capitol Classic Cobee Cove Flat Knife Ledge Reed 5% Radius Traditional Waterfall		Flat NSS Bevel	
4 Select hardware <i>View hardware details</i>		Hardware N/A		Hardware N/A		Hardware N/A		Hardware N/A	

View statement of line

Product features.

- ENVI-CT Finish *Environmental Coatings Technology
- 1-5/16" thick top

Seating accommodations.

- 240" seats sixteen to eighteen
- 216" seats twelve to fourteen
- 192" seats ten to twelve
- 168" seats ten
- 144" and 120" seats eight to ten
- 96" and 84" seats eight
- 72" seats six to eight

Options.

POWER

- REF-310: Reef power unit with daisylink - \$1100 ea
- PD-Cove-PKO: Cove corded series - \$800 ea
- FPDB: Flush power/data bay
- Hardwired: FPDB-H72: 72" Cord - \$1250. FPDB-H108: 108" Cord - \$1300. FPDB-H144: 144" Cord - \$1350. FPDB-H180: 180" Cord - \$1400.
- Power/Plug: FPDB-C72: 72" Cord - \$1250. FPDB-C108: 108" Cord - \$1300. FPDB-C144: 144" Cord - \$1350. FPDB-C180: 180" Cord - \$1400

Conference.

Glass Tables
Arc End

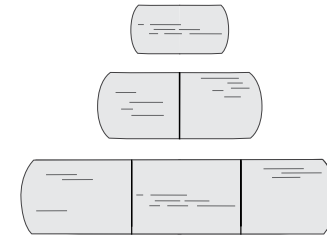

1 Select a model
w" x d" x h"

weight

	White Glass Gloss Finish	Black Glass Gloss Finish	White Glass SoftEtch™ Finish	Black Glass SoftEtch™ Finish
3 Piece Top				
240 x 60 x 1-1/2"	1245 TBT24060AR500SW 21278	TBT24060AR500SB 21278	TBT24060AR500EW 21278	TBT24060AR500EB 21278
240 x 54 x 1-1/2"	1125 TBT24054AR500SW 19573	TBT24054AR500SB 19573	TBT24054AR500EW 19573	TBT24054AR500EB 19573
2 Piece Top				
216 x 60 x 1-1/2"	1125 TBT21660AR500SW 19474	TBT21660AR500SB 19474	TBT21660AR500EW 19474	TBT21660AR500EB 19474
216 x 54 x 1-1/2"	1015 TBT21654AR500SW 17659	TBT21654AR500SB 17659	TBT21654AR500EW 17659	TBT21654AR500EB 17659
192 x 54 x 1-1/2"	900 TBT19254AR500SW 15850	TBT19254AR500SB 15850	TBT19254AR500EW 15850	TBT19254AR500EB 15850
168 x 54 x 1-1/2"	720 TBT16854AR500SW 13837	TBT16854AR500SB 13837	TBT16854AR500EW 13837	TBT16854AR500EB 13837
144 x 48 x 1-1/2"	545 TBT14448AR500SW 10832	TBT14448AR500SB 10832	TBT14448AR500EW 10832	TBT14448AR500EB 10832
120 x 48 x 1-1/2"	450 TBT12048AR500SW 8996	TBT12048AR500SB 8996	TBT12048AR500EW 8996	TBT12048AR500EB 8996
1 Piece Top				
96 x 48 x 1-1/2"	360 TBT9648AR500SW 7644	TBT9648AR500SB 7644	TBT9648AR500EW 7644	TBT9648AR500EB 7644
84 x 42 x 1-1/2"	270 TBT8442AR500SW 5933	TBT8442AR500SB 5933	TBT8442AR500EW 5933	TBT8442AR500EB 5933
72 x 36 x 1-1/2"	220 TBT7236AR500SW 4618	TBT7236AR500SB 4618	TBT7236AR500EW 4618	TBT7236AR500EB 4618

[View statement of line](#)

2 Select a finish
[View finish details](#)

Finish N/A

Finish
N/A

Finish
N/A

Finish
N/A

3 Select an edge
[View edge details](#)



4 Select hardware
[View hardware details](#)

Hardware
N/A

Hardware
N/A

Hardware
N/A

Hardware
N/A

Product features.

- Subtop is recessed 3" and edge is finished to match glass
- Glass features flat polished edge
- Custom back painted colors available upon quote
- Glass is 1/2" thick with 1-1/4" subtop

NOTES

- Any Sherwin Williams, Benjamin Moore or Valspar custom back painted glass color is available for a one-time fee per order for \$1475 list.
- DARRAN makes every effort to produce back painted glass with the best available low iron material for color consistency. Low iron glass is a natural material with slight variation from sheet to sheet.

Seating accommodations.

- 240" seats sixteen to eighteen
- 216" seats twelve to fourteen
- 192" seats ten to twelve
- 168" seats ten
- 144" and 120" seats eight to ten
- 96" and 84" seats eight
- 72" seats six to eight

Options.

POWER

- Add \$125 per power pod when specifying power on a glass conference table top
- REF-310: Reef power unit with daisylink - \$1100 ea
- PD-Cove-PKO: Cove corded series - \$800 ea
- FPDB: Flush power/data bay
- Hardwired: FPDB-H72: 72" Cord - \$1250. FPDB-H108: 108" Cord - \$1300. FPDB-H144: 144" Cord - \$1350. FPDB-H180: 180" Cord - \$1400.
- Power/Plug: FPDB-C72: 72" Cord - \$1250. FPDB-C108: 108" Cord - \$1300. FPDB-C144: 144" - Cord \$1350. FPDB-C180: 180" Cord - \$1400

Conference. Tables Boat

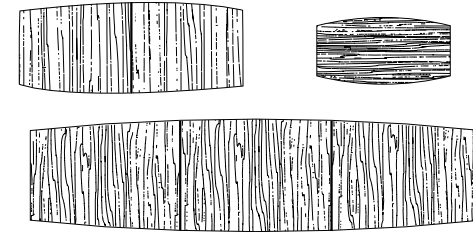

1 Select a model w" x d" x h"	weight	Standard Veneer Top		Premium Veneer Top		High Pressure Laminate Top		Thermally Fused Laminate Top					
3 Piece Top													
240 x 60/48 x 1-1/2"	590	TBT24060BT500W	9339	TBT24060BT500P	10273	TBT24060BT500G	9339	TBT24060BT500M	2989				
240 x 54/42 x 1-1/2"	535	TBT24054BT500W	9214	TBT24054BT500P	10135	TBT24054BT500G	9214	TBT24054BT500M	2942				
2 Piece Top													
216 x 60/48 x 1-1/2"	535	TBT21660BT500W	7936	TBT21660BT500P	8730	TBT21660BT500G	7936	"M" Option N/A					
216 x 54/42 x 1-1/2"	485	TBT21654BT500W	7838	TBT21654BT500P	8622	TBT21654BT500G	7838	"M" Option N/A					
192 x 54/42 x 1-1/2"	430	TBT19254BT500W	6219	TBT19254BT500P	6841	TBT19254BT500G	6219	TBT19254BT500M	1915				
168 x 54 /42 x 1-1/2"	310	TBT16854BT500W	6052	TBT16854BT500P	6658	TBT16854BT500G	6052	TBT16854BT500M	1864				
144 x 48/39 x 1-1/2"	230	TBT14448BT500W	5520	TBT14448BT500P	6072	TBT14448BT500G	5520	TBT14448BT500M	1696				
120 x 48/39 x 1-1/2"	190	TBT12048BT500W	5419	TBT12048BT500P	5961	TBT12048BT500G	5419	TBT12048BT500M	1666				
1 Piece Top													
96 x 48/36 x 1-1/2"	150	TBT9648BT500W	3100	TBT9648BT500P	3410	TBT9648BT500G	3100	TBT9648BT500M	1005				
84 x 42 /32 x 1-1/2"	120	TBT8442BT500W	2995	TBT8442BT500P	3295	TBT8442BT500G	2995	TBT8442BT500M	898				
72 x 36/30 x 1-1/2"	110	TBT7236BT500W	2557	TBT7236BT500P	2813	TBT7236BT500G	2557	TBT7236BT500M	799				
2 Select a finish <i>View finish details</i>													
		WAC	WWM	PO02	TBCO	WSO	GAC	GNW	LP01	MAC			
		WRC	WEW	PO03	TBSW		GIC	GSTV + %10	LP02	MEC			
		WIC	WGW	PO04	TSTV		GEC	GSLV + %10		MHC			
		WEC	WBW	PO05	TSMV		GHC	GWL		MOC			
		WHC	WSW	PO06	TSLV		GOC	LA01 + 20%		MGW			
		WOC	WNW	PO07	TOBW		GAM	LA02 + 20%		MTW			
		WAM	WWP		WBO		GCM	LF01		MSW			
		WCM	PO01		WMO		GWM	LF02		MWL			
					WNO		GEW	LN01					
3 Select an edge <i>View edge details</i>													
		Cove	Flat	Knife	Ledge			Cove	Flat	Knife	Ledge		
		Reed	Radius	Traditional	Waterfall			Reed	Radius	Traditional	Waterfall		
4 Select hardware <i>View hardware details</i>													
		Hardware	N/A		Hardware	N/A	Hardware	N/A		Hardware	N/A		

[View statement of line](#)

Product features.

- ENVI-CT Finish *Environmental Coatings Technology
- 1-5/16" thick top

Seating accommodations.

- 240" seats sixteen to eighteen
- 216" seats twelve to fourteen
- 192" seats ten to twelve
- 168" seats ten
- 144" and 120" seats eight to ten
- 96" and 84" seats eight
- 72" seats six

Options.

POWER

- REF-310: Reef power unit with daisylink - \$1100 ea
- PD-Cove-PKO: Cove corded series - \$800 ea
- FPDB: Flush power/data bay
- Hardwired: FPDB-H72: 72" Cord - \$1250. FPDB-H108: 108" Cord - \$1300. FPDB-H144: 144" Cord - \$1350. FPDB-H180: 180" Cord - \$1400.
- Power/Plug: FPDB-C72: 72" Cord - \$1250. FPDB-C108: 108" Cord - \$1300. FPDB-C144: 144" Cord - \$1350. FPDB-C180: 180" Cord - \$1400

Conference.

Glass Tables
Boat

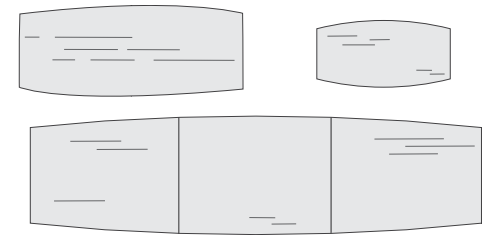

1 Select a model

w" x d" x h"

	weight	White Glass		Black Glass		White Glass		Black Glass	
		Gloss Finish		Gloss Finish		SoftEtch™ Finish		SoftEtch™ Finish	
3 Piece Top									
240 x 60/48 x 1-1/2"	1245	TBT24060BT500SW	21278	TBT24060BT500SB	21278	TBT24060BT500EW	21278	TBT24060BT500EB	21278
240 x 54/42 x 1-1/2"	1125	TBT24054BT500SW	19573	TBT24054BT500SB	19573	TBT24054BT500EW	19573	TBT24054BT500EB	19573
2 Piece Top									
216 x 60/48 x 1-1/2"	1125	TBT21660BT500SW	19474	TBT21660BT500SB	19474	TBT21660BT500EW	19474	TBT21660BT500EB	19474
216 x 54/42 x 1-1/2"	1015	TBT21654BT500SW	17659	TBT21654BT500SB	17659	TBT21654BT500EW	17659	TBT21654BT500EB	17659
192 x 54/42 x 1-1/2"	900	TBT19254BT500SW	15850	TBT19254BT500SB	15850	TBT19254BT500EW	15850	TBT19254BT500EB	15850
168 x 54/42 x 1-1/2"	720	TBT16854BT500SW	13837	TBT16854BT500SB	13837	TBT16854BT500EW	13837	TBT16854BT500EB	13837
144 x 48/39 x 1-1/2"	545	TBT14448BT500SW	10832	TBT14448BT500SB	10832	TBT14448BT500EW	10832	TBT14448BT500EB	10832
120 x 48/39 x 1-1/2"	450	TBT12048BT500SW	8996	TBT12048BT500SB	8996	TBT12048BT500EW	8996	TBT12048BT500EB	8996
1 Piece Top									
96 x 48/36 x 1-1/2"	360	TBT9648BT500SW	7644	TBT9648BT500SB	7644	TBT9648BT500EW	7644	TBT9648BT500EB	7644
84 x 42/32 x 1-1/2"	270	TBT8442BT500SW	5933	TBT8442BT500SB	5933	TBT8442BT500EW	5933	TBT8442BT500EB	5933
72 x 36/30 x 1-1/2"	220	TBT7236BT500SW	4618	TBT7236BT500SB	4618	TBT7236BT500EW	4618	TBT7236BT500EB	4618

[View statement of line](#)

2 Select a finish

[View finish details](#)

Finish N/A

Finish
N/A

Finish
N/A

Finish
N/A

3 Select an edge

[View edge details](#)



4 Select hardware

[View hardware details](#)

Hardware
N/A

Hardware
N/A

Hardware
N/A

Hardware
N/A

Product features.

- Subtop is recessed 3" and edge is finished to match glass
- Glass features flat polished edge
- Custom back painted colors available upon quote
- Glass is 1/2" thick with 1-1/4" subtop

NOTES

- Any Sherwin Williams, Benjamin Moore or Valspar custom back painted glass color is available for a one-time fee per order for \$1475 list.
- DARRAN makes every effort to produce back painted glass with the best available low iron material for color consistency. Low iron glass is a natural material with slight variation from sheet to sheet.

Seating accommodations.

- 240" seats sixteen to eighteen
- 216" seats twelve to fourteen
- 192" seats ten to twelve
- 168" seats ten
- 144" and 120" seats eight to ten
- 96" and 84" seats eight
- 72" seats six

Options.

POWER

- Add \$125 per power pod when specifying power on a glass conference table top
- REF-310: Reef power unit with daisylink - \$1100 ea
- PD-Cove-PKO: Cove corded series - \$800 ea
- FPDB: Flush power/data bay
- Hardwired: FPDB-H72: 72" Cord - \$1250. FPDB-H108: 108" Cord - \$1300. FPDB-H144: 144" Cord - \$1350. FPDB-H180: 180" Cord - \$1400.
- Power/Plug: FPDB-C72: 72" Cord - \$1250. FPDB-C108: 108" Cord - \$1300. FPDB-C144: 144" - Cord \$1350. FPDB-C180: 180" Cord - \$1400

Conference.

Telecom Tables
Wedge

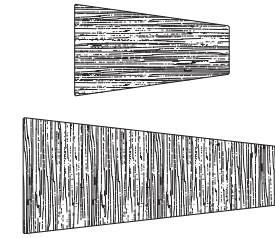

1 Select a model

w" x d" x h"

weight	Standard Veneer Top	Premium Veneer Top	High Pressure Laminate Top	Thermally Fused Laminate Top
2 Piece				
144 x 60/30	250 TBT14460WE400W 6052	TBT14460WE400P 6658	TBT14460WE400G 6052	TBT14460WE400M 2268
132 x 60/30	235 TBT13260WE400W 5858	TBT13260WE400P 6444	TBT13260WE400G 5858	TBT13260WE400M 2083
120 x 54/30	215 TBT12054WE400W 5564	TBT12054WE400P 6121	TBT12054WE400G 5564	TBT12054WE400M 1803
1 Piece				
108 x 54/30	195 TBT10854WE400W 3639	TBT10854WE400P 4003	TBT10854WE400G 3639	TBT10854WE400M 1666
96 x 51/30	170 TBT9651WE400W 3161	TBT9651WE400P 3478	TBT9651WE400G 3161	TBT9651WE400M 1062
84 x 48/30	135 TBT8448WE400W 3054	TBT8448WE400P 3360	TBT8448WE400G 3054	TBT8448WE400M 955
72 x 42/28	105 TBT7242WE400W 2614	TBT7242WE400P 2876	TBT7242WE400G 2614	TBT7242WE400M 854

[View statement of line](#)

2 Select a finish

[View finish details](#)

WAC	WWM	PO02	TBCO	WSO	GAC	GNW	LP01	MAC
WRC	WEW	PO03	TBSW		GIC	GSTV	LP02	MEC
WIC	WGW	PO04	TSTV		GEC	GSLV		MHC
WEC	WBW	PO05	TSMV		GHC	GWL		MOC
WHC	WSW	PO06	TSLV		GOC	LA01 + 20%		MGW
WOC	WNW	PO07	TOBW		GAM	LA02 + 20%		MTW
WAM	WWP		WBO		GCM	LF01		MSW
WCM	PO01		WMO		GWM	LF02		MWL
			WNO		GEW	LN01		

3 Select a edge

[View edge details](#)

Bullnose	Capitol	Classic	Cobee	Flat	Ledge	Bullnose	Capitol	Classic	Cobee	Flat	NSS Bevel
Cove	Flat	Knife	Ledge	Cove	Flat	Knife	Ledge	Reed	Radius	Traditional	Waterfall
Reed	Radius	Traditional	Waterfall	Reed	Radius	Traditional	Waterfall				

4 Select hardware

[View hardware details](#)

Hardware N/A	Hardware N/A	Hardware N/A	Hardware N/A
-----------------	-----------------	-----------------	-----------------

Product features.

- Tops and bases are pre-mounted to ensure proper installation location
- 1-5/16" thick top

Seating accommodations.

- 144" and 120" seats eight to ten
- 132" and 120" seats eight to ten
- 108", 96" and 84" seats eight
- 72" seats four to five

Conference.

Drum Bases
Wood Drum

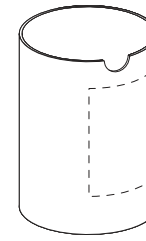

[View statement of line](#)

1 Select a model w" x d" x h"		weight	Standard Veneer	Premium Veneer	High Pressure Laminate	Thermally Fused Laminate
For Tops Over 48" W 24 DIA x 28.75		100	TBB2424WD969W 1575	TBB2424WD969P 1732	"G" Option N/A	"M" Option N/A
For tops 42" - 48" W 20 DIA x 28.75		75	TBB2020WD969W 1497	TBB2020WD969P 1647	"G" Option N/A	"M" Option N/A
For tops less than 42" W 16 DIA x 28.75		60	TBB1616WD969W 1418	TBB1616WD969P 1560	"G" Option N/A	"M" Option N/A
2 Select a finish View finish details			WAC WWM PO02 WRC WEW PO03 WIC WGW PO04 WEC WBW PO05 WHC WSW PO06 WOC WNW PO07 WAM WWP WCM PO01	WBO WMO WSO WNO		
3 Select a edge View edge details			Edge N/A	Edge N/A		
4 Select hardware View hardware details			Hardware N/A	Hardware N/A		

Product features.

- Wire access door and open top and bottom allowing easy wire access
- All finishes are a stain match on maple or oak veneer

NOTES

- Drum bases can be used as center supports
- See base matrix to determine bases for specified top
- On round and square top base ships with weights to prevent tipping

Conference.

Drum Bases
Half Wood Drum

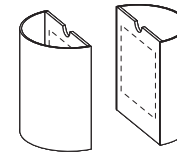

Drum bases can be used as center supports



[View statement of line](#)

1 Select a model w" x d" x h"		Standard Veneer		Premium Veneer		High Pressure Laminate	Thermally Fused Laminate
	weight						
For Tops Over 48" W							
24 x 12 x 28.75	75	TBB2412HD968W	1508	TBB2412HD968P	1659	"G" Option N/A	"M" Option N/A
For tops 42" - 48" W							
20 x 10 x 28.75	60	TBB2010HD968W	1429	TBB2010HD968P	1572	"G" Option N/A	"M" Option N/A
For tops less than 42" W							
16 x 8 x 28.75	50	TBB1608HD968W	1350	TBB1608HD968P	1485	"G" Option N/A	"M" Option N/A
2 Select a finish View finish details		WAC	WWM	PO02	WBO		
		WRC	WEW	PO03	WMO		
		WIC	WGW	PO04	WSO		
		WEC	WBW	PO05	WNO		
		WHC	WSW	PO06			
		WOC	WNW	PO07			
		WAM	WWP				
		WCM	PO01				
3 Select a edge View edge details		Edge			Edge		
		N/A			N/A		
4 Select hardware View hardware details		Hardware			Hardware		
		N/A			N/A		

Product features.

- Wire access door and open top and bottom allowing easy wire access
- All finishes are a stain match on maple or oak veneer

NOTES

- Box bases can be used as center supports
- See base matrix to determine bases for specified top
- On round and square top base ships with weights to prevent tipping

Conference.

Drum Bases

Transitional Wood Cylinder Base

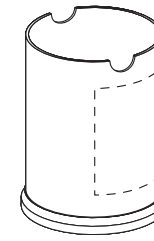

1 Select a model w" x d" x h"		Standard Veneer		Premium Veneer	High Pressure Laminate	Thermally Fused Laminate
	weight					
For Tops Over 48" W						
24 DIA x 28.75	70	TBB2424TC969W	1789	"P" Option N/A	"G" Option N/A	"M" Option N/A
For tops 42" - 48" W						
20 DIA x 28.75	65	TBB2020TC969W	1682	"P" Option N/A	"G" Option N/A	"M" Option N/A
For tops less than 42" W						
16 DIA x 28.75	60	TBB1616TC969W	1575	"P" Option N/A	"G" Option N/A	"M" Option N/A
2 Select a finish <i>View finish details</i>		WAC	WSW	WBO		
		WRC	WNW	WMO		
		WIC		WSO		
		WHC		WNO		
		WOC				
		WEW				
		WGW				
		WBW				
3 Select a edge <i>View edge details</i>		Edge		Edge		
		N/A		N/A		
4 Select hardware <i>View hardware details</i>		Hardware		Hardware		
		N/A		N/A		

[View statement of line](#)

Product features.

- Wire access door and open top and bottom allowing easy wire access
- All finishes are a stain match on maple veneer

NOTES

- Drum bases can be used as center supports
- See base matrix to determine bases for specified top
- On round and square top base ships with weights to prevent tipping

Conference.

Traditional Drum Bases
Traditional Drum



[View statement of line](#)

1 Select a model w" x d" x h"		weight	Standard Veneer	Premium Veneer	High Pressure Laminate	Thermally Fused Laminate
For Tops Over 48" W 24 DIA x 28.75		115	TBB2424TD969W 1789	"P" Option N/A	"G" Option N/A	"M" Option N/A
For tops 42" - 48" W 20 DIA x 28.75		90	TBB2020TD969W 1682	"P" Option N/A	"G" Option N/A	"M" Option N/A
For tops 42" or less 16 DIA x 28.75		75	TBB1616TD969W 1575	"P" Option N/A	"G" Option N/A	"M" Option N/A
2 Select a finish View finish details			WAC WSW WRC WNW WIC WHC WOC WEW WGW WBW			
3 Select a edge View edge details			Edge N/A			
4 Select hardware View hardware details			Hardware N/A			

Product features.

- 2.625" base w/ classic profile
- Beltline moldings
- Plywood drum
- Wire access door and open top and bottom allowing easy wire access
- All finishes are a stain match on maple veneer

NOTES

- Drum bases can be used as center supports
- See base matrix to determine bases for specified top
- On round and square top base ships with weights to prevent tipping

Conference.

Cube Bases
Contemporary Cube Base

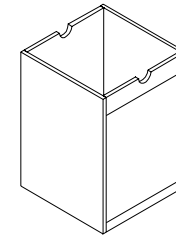

[View statement of line](#)

1 Select a model w" x d" x h"	weight	Standard Veneer			Premium Veneer		High Pressure Laminate	Thermally Fused Laminate	
		For Tops Over 48" W 24 x 24 x 28.75 For tops 42" - 48" W 20 x 20 x 28.75 For tops less than 42" W 16 x 16 x 28.75	85 70 60	TBB2424CC962W TBB2020CC962W TBB1616CC962W	1159 1103 1046	TBB2424CC962P TBB2020CC962P TBB1616CC962P	1275 1214 1151	"G" Option N/A "G" Option N/A "G" Option N/A	TBB2424CC962M TBB2020CC962M TBB1616CC962M
2 Select a finish View finish details		WAC WRC WIC WEC WHC WOC WAM WCM	WWM WEW WGW WBW WSW WNW WWP PO01	PO02 PO03 PO04 PO05 PO06 PO07	TBCO TBSW TSTV TSMV TSLV TOBW WBO WMO WNO	WSO	MAC MEC MHC MOC MGW MTW MSW MWL		
3 Select an edge View edge details		Edge N/A			Edge N/A		Edge N/A		
4 Select hardware View hardware details		Hardware N/A			Hardware N/A		Hardware N/A		

Product features.

- 2 x 4 grommet cutout
- Open top and bottom

NOTES

- Access door standard
- See base matrix to determine bases for specified top

Conference.

Cube Bases
Contemporary Half Cube

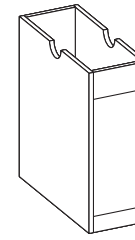

1 Select a model w" x d" x h"		Standard Veneer		Premium Veneer		High Pressure Laminate	Thermally Fused Laminate		
		weight							
For Tops Over 48" W 24 x 10 x 28.75		40	TBB2410CH977W	1030	TBB2410CH977P	1133	"G" Option N/A	TBB2410CH977M	800
For tops 42" - 48" W 20 x 10 x 28.75		30	TBB2010CH977W	980	TBB2010CH977P	1078	"G" Option N/A	TBB2010CH977M	765
For tops less than 42" W 16 x 10 x 28.75		20	TBB1610CH977W	929	TBB1610CH977P	1022	"G" Option N/A	TBB1610CH977M	732
2 Select a finish <i>View finish details</i>		WAC	WWM	PO02	TBCO	WSO		MAC	
		WRC	WEW	PO03	TBSW			MEC	
		WIC	WGW	PO04	TSTV			MHC	
		WEC	WBW	PO05	TSMV			MOC	
		WHC	WSW	PO06	TSLV			MGW	
		WOC	WNW	PO07	TOBW			MTW	
		WAM	WWP		WBO			MSW	
		WCM	PO01		WMO			MWL	
					WNO				
3 Select an edge <i>View edge details</i>		Edge		Edge		Edge		Edge	
		N/A		N/A		N/A		N/A	
4 Select hardware <i>View hardware details</i>		Hardware		Hardware		Hardware		Hardware	
		N/A		N/A		N/A		N/A	

[View statement of line](#)

Product features.

- 2 x 4 grommet cutout
- Open top and bottom

NOTES

- Access door standard
- See base matrix to determine bases for specified top

Conference.

Cube Bases

Contemporary Cube WI Metal Detail

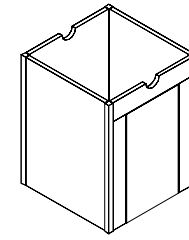

1 Select a model w" x d" x h"		Standard Veneer		Premium Veneer		High Pressure Laminate	Thermally Fused Laminate
	weight						
For Tops Over 48" W							
24 x 24 x 28.75	110	TBB2424CS962W	1772	TBB2424CS962P	1950	"G" Option N/A	TBB2424CS962M 1383
For Tops 42" - 48" W							
20 x 20 x 28.75	85	TBB2020CS962W	1655	TBB2020CS962P	1821	"G" Option N/A	TBB2020CS962M 1289
For tops less than 42" W							
16 x 16 x 28.75	70	TBB1616CS962W	1535	TBB1616CS962P	1689	"G" Option N/A	TBB1616CS962M 1198
2 Select a finish <i>View finish details</i>		WAC	WWM	PO02	TBCO	WSO	MAC
		WRC	WEW	PO03	TBSW		MEC
		WIC	WGW	PO04	TSTV		MHC
		WEC	WBW	PO05	TSMV		MOC
		WHC	WSW	PO06	TSLV		MGW
		WOC	WNW	PO07	TOBW		MTW
		WAM	WWP		WBO		MSW
		WCM	PO01		WMO		MWL
					WNO		
3 Select an edge <i>View edge details</i>		Edge			Edge		Edge
		N/A			N/A		N/A
4 Select hardware <i>View hardware details</i>		Hardware			Hardware		Hardware
		N/A			N/A		N/A

[View statement of line](#)

Product features.

- 2 x 4 grommet cutout
- Adjustable glides
- Anodized aluminum metal feet

NOTES

- Access door
- See base matrix to determine bases for specified top

Conference.

Cube Post Bases

Contemporary Half Cube With Metal Detail

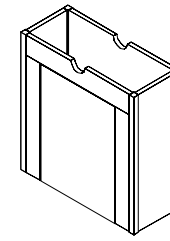

1 Select a model w" x d" x h"		Standard Veneer		Premium Veneer		High Pressure Laminate	Thermally Fused Laminate
	weight						
For Tops Over 48" W							
24 x 10 x 28.75	85	TBB2410HS975W	1637	TBB2410HS975P	1801	"G" Option N/A	TBB2410HS975M 1278
For tops 42" - 48" W							
20 x 10 x 28.75	65	TBB2010HS975W	1548	TBB2010HS975P	1703	"G" Option N/A	TBB2010HS975M 1210
For tops less than 42" W							
16 x 10 x 28.75	45	TBB1610HS975W	1457	TBB1610HS975P	1603	"G" Option N/A	TBB1610HS975M 1137
2 Select a finish <i>View finish details</i>		WAC	WWM	PO02	TBCO	WSO	MAC
		WRC	WEW	PO03	TBSW		MEC
		WIC	WGW	PO04	TSTV		MHC
		WEC	WBW	PO05	TSMV		MOC
		WHC	WSW	PO06	TSLV		MGW
		WOC	WNW	PO07	TOBW		MTW
		WAM	WWP		WBO		MSW
		WCM	PO01		WMO		MWL
					WNO		
3 Select an edge <i>View edge details</i>		Edge			Edge		Edge
		N/A			N/A		N/A
4 Select hardware <i>View hardware details</i>		Hardware			Hardware		Hardware
		N/A			N/A		N/A

[View statement of line](#)

Product features.

- 2 x 4 grommet cutout
- Open top and bottom
- Metal details on each corner anodized aluminum

NOTES

- Access door
- See base matrix to determine bases for specified top

Conference.
Cube Bases
Transitional Cube

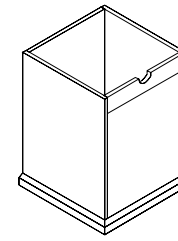

1 Select a model w" x d" x h"		weight	Standard Veneer	Premium Veneer	High Pressure Laminate	Thermally Fused Laminate
For Tops Over 48" W 24 x 24 x 28.75		85	TBB2424TR962W1333	"P" Option N/A	"G" Option N/A	"M" Option N/A
For tops 42" - 48" W 20 x 20 x 28.75		70	TBB2020TR962W1238	"P" Option N/A	"G" Option N/A	"M" Option N/A
For tops less than 42" W 16 x 16 x 28.75		60	TBB1616TR962W1142	"P" Option N/A	"G" Option N/A	"M" Option N/A
2 Select a finish <i>View finish details</i>			WAC WSW PO07 WRC WNW PO08 WIC PO01 PO09 WHC PO02 WOC PO03 WEW PO04 WGW PO05 WBW PO06			
3 Select an edge <i>View edge details</i>			Edge N/A			
4 Select hardware <i>View hardware details</i>			Hardware N/A			

[View statement of line](#)

Product features.

- Open top and bottom
- Transitional - Hardwood base 2 1/2" H

NOTES

- Access door
- See base matrix to determine bases for specified top

Conference.

Cube Bases

Transitional Half Cube

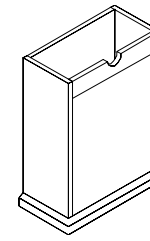

1 Select a model w" x d" x h"		weight	Standard Veneer	Premium Veneer	High Pressure Laminate	Thermally Fused Laminate
For Tops Over 48" W 24 x 10 x 28.75		40	TBB2410TR977W1142	"P" Option N/A	"G" Option N/A	"M" Option N/A
For tops 42" - 48" W 20 x 10 x 28.75		30	TBB2010TR977W1080	"P" Option N/A	"G" Option N/A	"M" Option N/A
For tops less than 42" W 16 x 10 x 28.75		20	TBB1610TR977W1019	"P" Option N/A	"G" Option N/A	"M" Option N/A
2 Select a finish View finish details			WAC WSW PO07 WRC WNW PO08 WIC PO01 PO09 WHC PO02 WOC PO03 WEW PO04 WGW PO05 WBW PO06			
3 Select an edge View edge details			Edge N/A			
4 Select hardware View hardware details			Hardware N/A			

[View statement of line](#)

Product features.

- 2 x 4 grommet cutout
- Transitional - Hardwood base 2 1/2" H
- Open top and bottom

NOTES

- Access door
- See base matrix to determine bases for specified top

Conference.

Traditional Cube Bases
Full Traditional Cabinet Bases

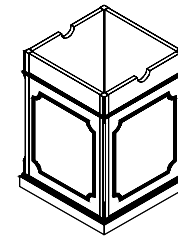

1 Select a model w" x d" x h"		weight	Standard Veneer	Premium Veneer	High Pressure Laminate	Thermally Fused Laminate
For Tops Over 48" W 24 x 24 x 28.75		115	TBB2424TC962W 1846	"P" Option N/A	"G" Option N/A	"M" Option N/A
For tops 42" - 48" W 20 x 20 x 28.75		90	TBB2020TC962W 1705	"P" Option N/A	"G" Option N/A	"M" Option N/A
For tops less than 42" W 16 x 16 x 28.75		75	TBB1616TC962W 1564	"P" Option N/A	"G" Option N/A	"M" Option N/A

2 Select a finish <i>View finish details</i>		WAC	WSW
		WRC	WNW
		WIC	
		WHC	
		WOC	
		WEW	
		WGW	
		WBW	

3 Select a edge <i>View edge details</i>		Edge
		N/A

4 Select hardware <i>View hardware details</i>		Hardware
		N/A

[View statement of line](#)

Product features.

- 2 x 4 grommet cutout
- Hardwood beltline molding
- Hardwood corner post and base
- Molding
- Open bottom
- 3 1/2 base

NOTES

- Access door
- See base matrix to determine bases for specified top

Options.

MOLDING

- DSM2: Delete panel molding - Deduct \$50

Conference.

Traditional Cube Bases
Half Traditional Cabinet Base

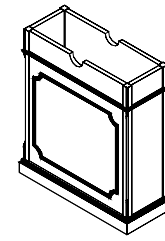

[View statement of line](#)

1 Select a model w" x d" x h"	weight	Standard Veneer	Premium Veneer	High Pressure Laminate	Thermally Fused Laminate
For Tops Over 48" W 24 x 10 x 28.75	90	TBB2410TH977W 1490	"P" Option N/A	"G" Option N/A	"M" Option N/A
For tops 42" - 48" W 20 x 10 x 28.75	70	TBB2010TH977W 1412	"P" Option N/A	"G" Option N/A	"M" Option N/A
For tops less than 42" W 16 x 10 x 28.75	50	TBB1610TH977W 1345	"P" Option N/A	"G" Option N/A	"M" Option N/A

2 Select a finish View finish details	
	WAC WSW WRC WNW WIC WHC WOC WEW WGW WBW

3 Select a edge View edge details	
	Edge N/A

4 Select hardware View hardware details	
	Hardware N/A

Product features.

- 2 x 4 grommet cutout
- Hardwood beltline molding
- Hardwood corner post and base
- Molding
- Open bottom

NOTES

- Access door
- See base matrix to determine bases for specified top

Options.

MOLDING

- DSM2: Delete panel molding - Deduct \$50

Conference.

Modesty Trough / Tray Bases
4 3/4" H Wire Trough Modesty

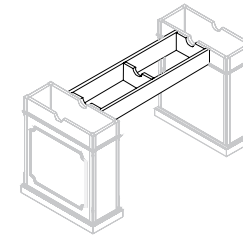

1 Select a model w" x d" x h"		weight	Standard Veneer	Premium Veneer	High Pressure Laminate	Thermally Fused Laminate
Required Trough Modesty for Top Sizes:						
240"	90		WT04-240W 2692	WT04-240P 2962	"G" Option N/A	WT04-240M 1884
216"	100		WT04-216W 2540	WT04-216P	"G" Option N/A	WT04-216M 1778
Required Trough Modesty for Top Sizes:						
192"	210		WT04-192W 2280	WT04-192P 2508	"G" Option N/A	WT04-192M 1671
168"	190		WT04-168W 2134	WT04-168P 2348	"G" Option N/A	WT04-168M 1564
144"	170		WT04-144W 1986	WT04-144P 2185	"G" Option N/A	WT04-144M 1457
Required Trough Modesty for Top Sizes:						
120"	110		WT04-120W 1150	WT04-120P 1265	"G" Option N/A	WT04-120M 844
96"	100		WT04-96W 1003	WT04-96P 1102	"G" Option N/A	WT04-96M 737
84"	95		WT04-84W 856	WT04-84P 942	"G" Option N/A	WT04-84M 630
2 Select a finish <i>View finish details</i>			WAC WWM PO02 WRC WEW PO03 WIC WGW PO04 WEC WBW PO05 WHC WSW PO06 WOC WNW PO07 WAM WWP WCM PO01	TBCO WSO TBSW TSTV TSMV TSLV TOBW WBO WMO WNO		MAC MEC MHC MOC MGW MTW MSW MWL
3 Select a edge <i>View edge details</i>			Edge N/A	Edge N/A		Edge N/A
4 Select hardware <i>View hardware details</i>			Hardware N/A	Hardware N/A		Hardware N/A

[View statement of line](#)

Product features.

- Open Bottom
- Wire grommets and channels

NOTES

- Actual dimension is 4 3/4"
- Interior base molding will be deleted on Traditional bases.
- Must order bases separately. Bases and Rack shipped separately. Requires assembly.
- Trough can be used on both contemporary and traditional bases

Conference.

Panel Base W/ Wire Management Modesty
Panel Base

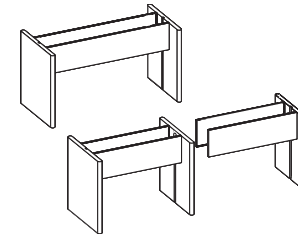

[View statement of line](#)

1 Select a model w" x d" x h"		weight	Standard Veneer	Premium Veneer	High Pressure Laminate	Thermally Fused Laminate	
3 Panel Base for Tables							
240"	205	TBB20424PB972W	5658	TBB20424PB972P	6224	"G" Option N/A	"M" Option N/A
216"	190	TBB18024PB972W	5207	TBB18024PB972P	5728	"G" Option N/A	"M" Option N/A
192"	175	TBB15624PB972W	4758	TBB15624PB972P	5234	"G" Option N/A	"M" Option N/A
168"	160	TBB13224PB972W	4308	TBB13224PB972P	4739	"G" Option N/A	"M" Option N/A
144"	150	TBB10824PB972W	3858	TBB10824PB972P	4244	"G" Option N/A	"M" Option N/A
2 Panel Base for Tables							
120"	100	TBB8424PB972W2633		TBB8424PB972P	2897	"G" Option N/A	"M" Option N/A
96"	100	TBB6024PB972W2155		TBB6024PB972P	2371	"G" Option N/A	"M" Option N/A
84"	100	TBB5424PB972W2098		TBB5424PB972P	2308	"G" Option N/A	"M" Option N/A
2 Select a finish View finish details			WAC WWM PO02 WRC WEW PO03 WIC WGW PO04 WEC WBW PO05 WHC WSW PO06 WOC WNW PO07 WAM WWP WCM PO01	TBCO WSO TBSW TSTV TSMV TSLV TOBW WBO WMO WNO		MAC MEC MHC MOC MGW MTW MSW MWL	
3 Select an edge View edge details			Edge N/A	Edge N/A		Edge N/A	
4 Select hardware View hardware details			Hardware N/A	Hardware N/A		Hardware N/A	

Product features.

- 1.3125" thick end panels
- 3mm wood bands
- Anti-glide tearout band
- Wire management channels
- Wire trough modesty

NOTES

- 2 panel base Factory assembled
- 3 panels - shipped 2 sections
- Base height: 28.75" H

Conference.

Panel Base W/ Wire Management Modesty
Traditional Panel Base

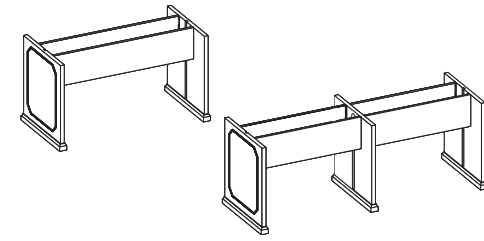

[View statement of line](#)

1 Select a model w" x d" x h"		weight	Standard Veneer	Premium Veneer	High Pressure Laminate	Thermally Fused Laminate
3 Panel Base for Tables						
240"		205	TBB20424TB972W 6223	"P" Option N/A	"G" Option N/A	"M" Option N/A
216"		190	TBB18024TB972W 5728	"P" Option N/A	"G" Option N/A	"M" Option N/A
192"		175	TBB15624TB972W 5234	"P" Option N/A	"G" Option N/A	"M" Option N/A
168"		160	TBB13224TB972W 4739	"P" Option N/A	"G" Option N/A	"M" Option N/A
144"		150	TBB10824TB972W 4244	"P" Option N/A	"G" Option N/A	"M" Option N/A
2 Panel Base for Tables						
120"		100	TBB8424TB972W2896	"P" Option N/A	"G" Option N/A	"M" Option N/A
96"		100	TBB6024TB972W2371	"P" Option N/A	"G" Option N/A	"M" Option N/A
84"		100	TBB5424TB972W2309	"P" Option N/A	"G" Option N/A	"M" Option N/A
2 Select a finish View finish details			WAC WSW WRC WNW WIC WHC WOC WEW WGW WBW			
3 Select a edge View edge details			Edge N/A			
4 Select hardware View hardware details			Hardware N/A			

Product features.

- 1.3125" thick end panels
- 2.125" x 2" hardwood base
- 3mm wood bands
- Scalloped moldings
- Wire management channels
- Wire trough modesty

NOTES

- Base Height: 28.75"H

Options.

MOLDING PANEL

- DSM2: Delete panel molding - Deduct \$50

Conference.

Panel Pedestal Bases
Panel X Base

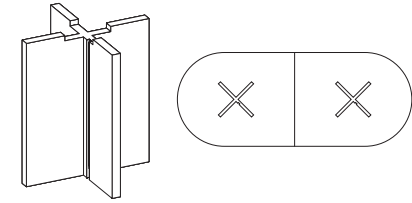

[View statement of line](#)

1 Select a model w" x d" x h"	weight	Standard Veneer	Premium Veneer	High Pressure Laminate	Thermally Fused Laminate
For Tops 60" W and 54" DIA 30 x 30 x 28.75	65	TBB3030PX966W 1440	TBB3030PX966P 1584	"G" Option N/A	TBB3030PX966M 1007
For Tops 48" - 54" W and 42"-48" DIA 24 x 24 x 28.75	55	TBB2424PX966W 1350	TBB2424PX966P 1485	"G" Option N/A	TBB2424PX966M 945
For tops 36" - 42" W (N/A on round tables) 18 x 18 x 28.75	45	TBB1818PX966W 1260	TBB1818PX966P 1386	"G" Option N/A	TBB1818PX966M 894
2 Select a finish View finish details		WAC WWM PO02 WRC WEW PO03 WIC WGW PO04 WEC WBW PO05 WHC WSW PO06 WOC WNW PO07 WAM WWP WCM PO01	TBCO WSO TBSW TSTV TSMV TSLV TOBW WBO WMO WNO		MAC MEC MHC MOC MGW MTW MSW MWL
3 Select a edge View edge details		Edge N/A	Edge N/A		Edge N/A
4 Select hardware View hardware details		Hardware N/A	Hardware N/A		Hardware N/A

Product features.

- 1.3125 thick end panels with 3mm wood bands

NOTES

- Panel x base can be used as center support with Panel T base on 2 pc tops.
- See base matrix to determine bases for specified top

Conference.

Panel Pedestal Bases
Panel T Base

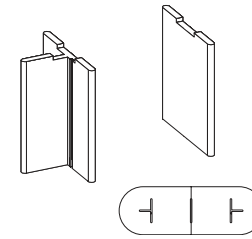

1 Select a model w" x d" x h"		weight	Standard Veneer	Premium Veneer	High Pressure Laminate	Thermally Fused Laminate		
Single Panel Center Support For 2 PC Tops								
24 x 28.75	40		TBB2402SP957W 1007	TBB2402SP957P	1108	"G" Option N/A	TBB2402SP957M	900
End Panel For Tops 48" - 54" W								
24 x 12 x 28.75	80		TBB2412TB963W980	TBB2412TB963P	1078	"G" Option N/A	TBB2412TB963M	878
End Panel For tops 36" - 42" W								
18 x 12 x 28.75	70		TBB1812TB963W917	TBB1812TB963P	1009	"G" Option N/A	TBB1812TB963M	844
2 Select a finish <i>View finish details</i>			WAC WWM PO02 WRC WEW PO03 WIC WGW PO04 WEC WBW PO05 WHC WSW PO06 WOC WNW PO07 WAM WWP WCM PO01	TBCO WSO TBSW TSTV TSMV TSLV TOBW WBO WMO WNO			MAC MEC MHC MOC MGW MTW MSW MWL	
3 Select an edge <i>View edge details</i>			Edge N/A	Edge N/A			Edge N/A	
4 Select hardware <i>View hardware details</i>			Hardware N/A	Hardware N/A			Hardware N/A	

[View statement of line](#)

Product features.

- 1.3125 thick end panels with 3mm wood bands

NOTES

- Not available on round tops
- See base matrix to determine bases for specified top

Conference.

Traditional Bases

Traditional Duncan Phyfe Pedestal Base

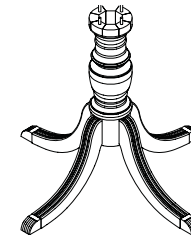

1 Select a model w" x d" x h"		weight	Standard Veneer	Premium Veneer	High Pressure Laminate	Thermally Fused Laminate
31 x 31 x 29.5		35	TBB3131PB955W1784	"P" Option N/A	"G" Option N/A	"M" Option N/A

2 Select a finish <i>View finish details</i>		
WAC	WSW	
WRC	WNW	
WIC		
Metal toe cap finish		
ABT Antique Brass, BPT	WHC	
Pewter	WOC	
	WEW	
	WGW	
	WBW	

3 Select a edge <i>View edge details</i>		Edge
		N/A

4 Select hardware <i>View hardware details</i>		Hardware
		N/A

[View statement of line](#)

Product features.

- 5 3/4" DIA column
- 13 1/2" Curve leg 12" High
- 24" DIA Sub top bolted to top of column (for attachment to top)

Options.

PREMIUM METAL FINISHES

- Specify metal toe cap finish
- Finish comes standard ABT: Antique Brass. Optional finish BPT: Pewter
- n/c

Conference.
Metal Bases
Column "X" Series

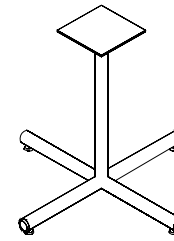

1 Select a model w" x d" x h"		weight	Silver Metal Base			View statement of line	
36 x 36 x 27.75	35	TBB3636MB971	557				
32 x 32 x 27.75	30	TBB3232MB971	536				

2 Select a finish View finish details		MFS						
Metal finish MFS Silver. Additional metal finishes are available, see options.								

3 Select a edge View edge details		Edge						
		N/A						

4 Select hardware View hardware details		Hardware						
		N/A						

Product features.
 - Standard Silver base (optional Black)
 - Available with casters

Options.
CASTERS
 - CAS20L: Casters - \$200 per base
PREMIUM FINISH OPTION
 - MFB: Black metal finish - \$100

Conference.

Metal Bases

Metal Column T-Leg

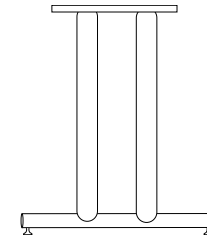

[View statement of line](#)

1 Select a model w" x d" x h"	weight	Silver Metal Base		
Single column T-leg				
30 x 2 x 27.75	20	TBB3002MB956 464		
Double column T-leg				
26 x 2 x 27.75	20	TBB2602MB956 464		
36 x 2 x 27.75	25	TBB3602MB956 497		
42 x 2 x 27.75	30	TBB4202MB956 519		
42 x 3 x 27.75	30	TBB4203MB956 633		
2 Select a finish View finish details		MFS		
<p>Metal finish MFS Silver. Additional metal finishes are available, see options.</p>				
3 Select a edge View edge details		Edge N/A		
4 Select hardware View hardware details		Hardware N/A		

Product features.

- Available with casters. See notes
- Recommended Top Size 36" D - 60" D
- Standard Silver base (optional Black)

NOTES

- Casters not available for TBB3002MB956 and TBB4203MB956

Options.

CASTERS

- CAS20L: Casters - \$100 per base

PREMIUM FINISH OPTION

- MFB: Black metal finish - n/c

Conference.

Metal Bases
Metal Leg - Kd

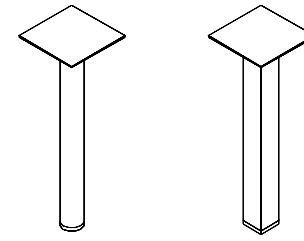

1 Select a model		weight	View statement of line	
w" x d" x h"				
Silver Metal Base				
Round Leg				
3 dia. x 27.75	15	TBB0303MB982	242	
Square Leg				
2.4 x 2.4 x 27.75	15	TBB0303MB976	242	

2 Select a finish		
<i>View finish details</i>	MFS	
Metal finish		
MFS Silver. Additional metal finishes are available, see options.		

3 Select a edge		
<i>View edge details</i>	Edge	
	N/A	

4 Select hardware		
<i>View hardware details</i>	Hardware	
	N/A	

Product features.
 - Available with casters
 - Standard Silver base (optional Black)

Options.
CASTERS
 - CAS20L: Casters - \$100 per base
PREMIUM FINISH OPTION
 - MFB: Black metal finish - \$100

Conference.
 Metal Bases
Tapered Metal Leg



1 Select a model		Silver Metal Base		View statement of line	
w" x d" x h"	weight				
2.375 x 1 x 28	15	TBB0301MB985	274		

2 Select a finish		MFS	
	View finish details		
Metal finish MFS Silver. Additional metal finishes are available, see options.			

3 Select a edge		Edge	
	View edge details	N/A	

4 Select hardware		Hardware	
	View hardware details	N/A	

Product features.
 - Standard Silver base (optional Black)

Options.
PREMIUM FINISH OPTION
 - Specify base metal finish color - \$160 per base
 - MFB: Black, MFW: White

Conference.
Metal Bases
Angled Metal Leg

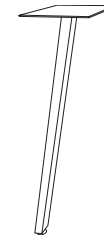

1 Select a model		Black Metal Base			View statement of line	
w" x d" x h"	weight					
1 x 2 x 28.75	15	TBB0102MB979 274				
2 Select a finish		MFS				
View finish details						
Metal finish MFB Black. Additional metal finishes are available, see options.						
3 Select a edge		Edge N/A				
View edge details						
4 Select hardware		Hardware N/A				
View hardware details						

Product features.

- Standard base is MFB Black metal finish (optional MFR Industrial metal finish)

NOTES

- This leg should be used with the Rail Collection

Conference.

Metal Bases

Metal Angled Sleigh Base

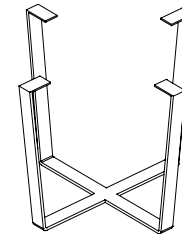

1 Select a model		Silver Metal Base		View statement of line	
w" x d" x h"	weight				
36 x 36 x 28.5	65	TBB3030MB984	1331		

2 Select a finish		MFS	
	View finish details		
<p>Metal finish MFS Silver. Additional metal finishes are available, see options.</p>			

3 Select a edge		Edge	
	View edge details	N/A	

4 Select hardware		Hardware	
	View hardware details	N/A	

Product features.

- Standard Silver base (optional White, Black)

NOTES

- Cannot be used on tops less than 42" depth recommended for tops 48" or greater

Options.

PREMIUM FINISH OPTION

- Specify base metal finish color - \$160 per base
- MFB: Black, MFW: White

Conference - Central park.

Central Park Base
Single Metal "U" Shaped Leg

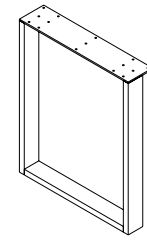

1 Select a model
w" x d" x h"

Weight	Metal Base
24 x 3 x 27.75	30 TBB2403MB954 610
30 x 3 x 27.75	40 TBB3003MB954 660
36 x 3 x 27.75	50 TBB3603MB954 710

[View statement of line](#)

2 Select a finish
[View finish details](#)

Metal finish	Code
MFS Silver	MFS
MFB Black	MFB

Additional metal finishes are available, see options.

3 Select a edge
[View edge details](#)

Edge	Code
N/A	N/A

4 Select hardware
[View hardware details](#)

Hardware	Code
N/A	N/A

Product features.

- Standard black or silver base (optional white)

Options.

PREMIUM FINISH OPTION

- Specify leg metal finish color - \$100 per leg
- MFW: White

WIRE MANAGEMENT

- W17: Wire management cover - \$80
Attaches to the leg by magnets

Conference.

Conferencing Legs
Single Metal Leg

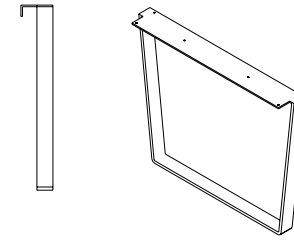

1 Select a model		Silver Metal Base		View statement of line		
w" x d" x h"	weight					
36 x 3 x 27.75	50	NSS3603MB988	653	"P" Option N/A	"G" Option N/A	"M" Option N/A
30 x 3 x 27.75	40	NSS3003MB988	630	"P" Option N/A	"G" Option N/A	"M" Option N/A
2 Select a finish		MFS				
View finish details						
Metal finish						
MFS Silver. Additional metal finishes are available, see options.						
3 Select a edge		Edge N/A		Edge N/A		
View edge details						
4 Select hardware		Hardware N/A		Edge N/A		
View hardware details						

Product features.

- Legs have been laser cut and bent to create unique not so square shape
- Standard Silver base (optional White, Black)
- Top connection of leg is reinforced with turn downs that will keep tops from warping

Options.

PREMIUM FINISH OPTION

- Specify leg metal finish color - \$100 per leg
- MFB: Black, MFW: White

WIRE MANAGEMENT







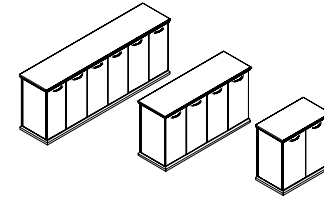



- W17: Wire management cover - \$80
- Attaches to the leg by magnets

Conference - Capitol park.

Full Pedestal Credenzas
 Conferencing Storage Credenza



[View statement of line](#)

1 Select a model w" x d" x h"	weight	Standard Veneer Top		Premium Veneer Top		High Pressure Laminate Top		Thermally Fused Laminate Top	
		Standard Veneer Chassis		Premium Veneer Chassis		Veneer Chassis		Thermally Fused Laminate Chassis	
Triple Storage									
94 x 24 x 36	390	CAP9424CA124W	6106	"P" Option N/A		CAP9424CA124G	6106	"M" Option N/A	
88 x 24 x 36	340	CAP8824CA124W	5976	"P" Option N/A		CAP8824CA124G	5976	"M" Option N/A	
Double Storage				"M" Option N/A					
71 x 24 x 36	290	CAP7124CA124W	4256	"P" Option N/A		CAP7124CA124G	4256	"M" Option N/A	
65 x 24 x 36	260	CAP6524CA124W	4113	"P" Option N/A		CAP6524CA124G	4113	"M" Option N/A	
59 x 24 x 36	245	CAP5924CA124W	3972	"P" Option N/A		CAP5924CA124G	3972	"M" Option N/A	
48 x 24 x 36	200	CAP4824CA124W	3684	"P" Option N/A		CAP4824CA124G	3684	"M" Option N/A	
Single Storage									
36 x 24 x 36	150	CAP3624CA124W	2395	"P" Option N/A		CAP3624CA124G	2395	"M" Option N/A	
30 x 24 x 36	135	CAP3024CA124W	2253	"P" Option N/A		CAP3024CA124G	2253	"M" Option N/A	
2 Select a finish View finish details		WAC	WSW			GAC			
		WRC	WNW			GIC			
		WIC				GHC			
		WHC				GOC			
		WOC				GEW			
		WEW				GNW			
		WGW							
	WBW								
3 Select a edge View edge details									
		Capitol				Capitol			
4 Select hardware View hardware details									
		PL-115 Matte Black PL-116 Matte Nickel		PL-125 Antique Pewter PL-126 Antique English PL-127 Matte Black		PL-115 Matte Black PL-116 Matte Nickel		PL-125 Antique Pewter PL-126 Antique English PL-127 Matte Black	
									
		PL-220 Pewter PL-221 Matte Black				PL-220 Pewter PL-221 Matte Black			
									
		PL-220 Pewter PL-221 Matte Black				PL-220 Pewter PL-221 Matte Black			

Product features.

- Adjustable glides
- Transitional - Hardwood base 2 1/2" H
- "W"/"G" styles have black adjustable shelf behind door set

NOTES

- Ganging: For end to end ganging, specify ganging flush cut modification for each ganged unit

Options.

ACCESSORIES

- REF-01: Modify Storage section for refrigerator - \$205

AUDIO VISUAL

- AVR1: AV Exhaust Fan - \$470
- AVR2: AV Pullout Rack - \$1655

BACK PANEL WALL ACCESS

- M19: 2 Heat vent/cord access slots in back - \$ 160

DOOR

- D2: Door Lock - \$100 per door set
- D6A: "W"/"G" Styles - Delete Doors and replace black laminate shelf with finished shelf - n/c

FLUSH CUT

- FC-B: Flush Unit Both Sides(Facing) for Ganging - \$100
- FC-L: Flush Unit Left (Facing) for Ganging - \$100
- FC-R: Flush Unit Right(Facing) for Ganging - \$100
- Open Plan – Finished Back
- OPB: W "G" Style - Modify Unit for Open Plan Application - \$195 Trash Can
- TRC50: EZ Cargo 50 dual trash can - (1) 8 gallon and (1) 5 gallon - \$680

Conference - Capitol park.

Full Pedestal Credenzas
 Conferencing Buffet Credenza

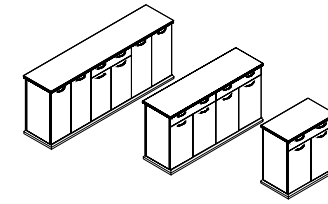

1 Select a model w" x d" x h"	weight	Standard Veneer Top Standard Veneer Chassis		Premium Veneer Top Premium Veneer Chassis		High Pressure Laminate Top Veneer Chassis		Thermally Fused Laminate Top Thermally Fused Laminate Chassis	
		Triple Buffet 94 x 24 x 36 Double Buffet 71 x 24 x 36 Single Buffet 36 x 24 x 36	390 300 175	CAP9424CA126W CAP7124CA126W CAP3624CA126W	6691 5545 3042	"P" Option N/A "P" Option N/A "P" Option N/A	CAP9424CA126G CAP7124CA126G CAP3624CA126G	6691 5545 3042	"M" Option N/A "M" Option N/A "M" Option N/A

2 Select a finish <i>View finish details</i>	WAC WSW WRC WNW WIC WHC WOC WEW WGW WBW		GAC GIC GHC GOC GEW GNW	

3 Select a edge <i>View edge details</i>	Capitol		Capitol	

4 Select hardware <i>View hardware details</i>	PL-115 Matte Black PL-116 Matte Nickel PL-220 Pewter PL-221 Matte Black		PL-125 Antique Pewter PL-126 Antique English PL-127 Matte Black PL-115 Matte Black PL-116 Matte Nickel PL-220 Pewter PL-221 Matte Black		PL-125 Antique Pewter PL-126 Antique English PL-127 Matte Black PL-115 Matte Black PL-116 Matte Nickel PL-220 Pewter PL-221 Matte Black	

[View statement of line](#)

Product features.

- Adjustable glides
- Transitional - Hardwood base 2 1/2" H
- Utility drawer w/ felt liner
- "W"/"G" styles have black adjustable shelf behind door set

NOTES

- Ganging: For end to end ganging, specify ganging flush cut modification for each ganged unit

Options.

DOOR

- D2: Door Lock - \$100 per door set
- D6A: "W"/"G" Styles - Delete Doors and replace black laminate shelf with finished shelf - n/c

FLUSH CUT

- FC-B: Flush Unit Both Sides(Facing) for Ganging - \$100
- FC-L: Flush Unit Left (Facing) for Ganging - \$100
- FC-R: Flush Unit Right(Facing) for Ganging - \$100

OPEN PLAN – FINISHED BACK

- OPB: "W" "G" Style - Modify Unit for Open Plan Application - \$195

TRASH CAN

- TRC50: EZ Cargo 50 dual trash can - (1) 8 gallon and (1) 5 gallon - \$650

Conference - Central park.

Full Pedestal Credenzas
 Conferencing Storage Credenza

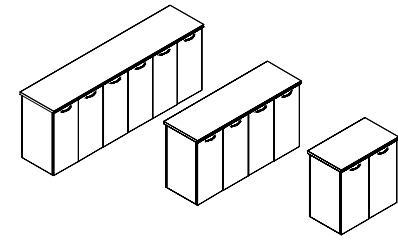

1 Select a model

w" x d" x h"

weight	Standard Veneer Top Standard Veneer Chassis		Premium Veneer Top Premium Veneer Chassis		High Pressure Laminate Top Veneer Chassis		Thermally Fused Laminate Top Thermally Fused Laminate Chassis	
	Triple Storage							
93 x 24 x 36	390	CPC9324CA124W 5834	CPC9324CA124P 6418	CPC9324CA124G 5834	CPC9324CA124M 3042			
87 x 24 x 36	340	CPC8724CA124W 5685	CPC8724CA124P 6254	CPC8724CA124G 5685	CPC8724CA124M 2818			
Double Storage								
70 x 24 x 36	290	CPC7024CA124W 4026	CPC7024CA124P 4429	CPC7024CA124G 4026	CPC7024CA124M 2326			
64 x 24 x 36	260	CPC6424CA124W 3877	CPC6424CA124P 4265	CPC6424CA124G 3877	CPC6424CA124M 2280			
58 x 24 x 36	245	CPC5824CA124W 3652	CPC5824CA124P 4018	CPC5824CA124G 3652	CPC5824CA124M 2234			
47 x 24 x 36	200	CPC4724CA124W 3503	CPC4724CA124P 3854	CPC4724CA124G 3503	CPC4724CA124M 2143			
Single Storage								
35 x 24 x 36	150	CPC3524CA124W 2219	CPC3524CA124P 2441	CPC3524CA124G 2219	CPC3524CA124M 1260			
29 x 24 x 36	135	CPC2924CA124W 2068	CPC2924CA124P 2275	CPC2924CA124G 2068	CPC2924CA124M 1219			

[View statement of line](#)

2 Select a finish

[View finish details](#)

WAC	WWM	PO02	TBCO	WSO	GAC	GNW	LP01	MAC
WRC	WEW	PO03	TBSW		GIC	GSTV +10%	LP02	MEC
WIC	WGW	PO04	TSTV		GEC	GSLV +10%		MHC
WEC	WBW	PO05	TSMV		GHC	GWL		MOC
WHC	WSW	PO06	TSLV		GOC	LA01 + 20%		MGW
WOC	WNW	PO07	TOBW		GAM	LA02 + 20%		MTW
WAM	WWP		WBO		GCM	LF01		MWL
WCM	PO01		WMO		GWM	LF02		MSW
			WNO		GEW	LN01		

3 Select a edge

[View edge details](#)

Bullnose	Classic	Cobee	Cove	Flat	Ledge	Bullnose	Classic	Cobee	Cove	Flat
Flat	Knife	Ledge	Ogee			Flat	Knife	Ledge	Ogee	
Reed	Radius	Waterfall				Reed	Radius	Waterfall		

4 Select hardware

[View hardware details](#)

RL-105 PL-106	PL-112 PL-113	PL-125 PL-127 PL-126	PL-105 PL-106	PL-112 PL-113	PL-125 PL-127 PL-126	PL-105 PL-106	PL-112 PL-113	PL-125 PL-127 PL-126	PL-105 PL-106	PL-112 PL-113	PL-125 PL-127 PL-126
RL-115 PL-116	PL-210	PL-310 PL-311	RL-115 PL-116	PL-210	PL-310 PL-311	RL-115 PL-116	PL-210	PL-310 PL-311	RL-115 PL-116	PL-210	PL-310 PL-311
Touch Latch			Touch Latch			Touch Latch			Touch Latch		

Product features.

- Adjustable glides
- "M" styles shelves match finish
- "W"/"G" styles have black adjustable shelf behind door set

NOTES

- All units are std with flush ends

Options.

ACCESSORIES

- REF-01: Modify Storage section for refrigerator - \$205

AUDIO VISUAL

- AVR1: AV Exhaust Fan - \$470
- AVR2: AV Pullout Rack - \$1655

BACK PANEL WALL ACCESS

- M19: 2 Heat vent/cord access slots in back - \$ 160

DOOR

- D2: Wood Door Lock - \$100 per door set
- D6: Delete doors - n/c
- D6A: "W"/"G" Styles - Delete Doors and replace black laminate shelf with finished shelf - n/c

OPEN PLAN - FINISHED BACK

- OPB: "W" "G" Style - Modify Unit for Open Plan Application - \$195
- OPB: "M" Style - Modify Unit for Open Plan Application - \$95 Shelf
- S25: Replace Black Laminate Shelf with Finished Shelf - \$80 per shelf
- TRC50: EZ Cargo 50 dual trash can - (1) 8 gallon and (1) 5 gallon - \$680

Conference - Central park.

Full Pedestal Credenzas
 Conferencing Buffet Credenza

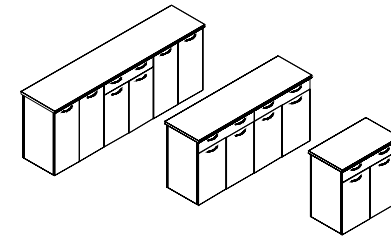

1 Select a model

w" x d" x h"

weight	Standard Veneer Top Standard Veneer Chassis		Premium Veneer Top Premium Veneer Chassis		High Pressure Laminate Top Veneer Chassis		Thermally Fused Laminate Top Thermally Fused Laminate Chassis	
	Triple Buffet 93 x 24 x 36	390	CPC9324CA126W 6438	CPC9324CA126P 7082	CPC9324CA126G 6438	CPC9324CA126M 3412		
Double Buffet 70 x 24 x 36	300	CPC7024CA126W 5233	CPC7024CA126P 5757	CPC7024CA126G 5233	CPC7024CA126M 2698			
Single Buffet 35 x 24 x 36	175	CPC3524CA126W 2907	CPC3524CA126P 3198	CPC3524CA126G 2907	CPC3524CA126M 1448			

[View statement of line](#)

2 Select a finish

[View finish details](#)

WAC	WWM	PO02	TBCO	WSO	GAC	GNW	LP01	MAC
WRC	WEW	PO03	TBSW		GIC	GSTV +10%	LP02	MEC
WIC	WGW	PO04	TSTV		GEC	GSLV +10%		MHC
WEC	WBW	PO05	TSMV		GHC	GWL		MOC
WHC	WSW	PO06	TSLV		GOC	LA01 + 20%		MGW
WOC	WNW	PO07	TOBW		GAM	LA02 + 20%		MTW
WAM	WWP		WBO		GCM	LF01		MWL
WCM	PO01		WMO		GWM	LF02		MSW
			WNO		GEW	LN01		

3 Select a edge

[View edge details](#)

Bullnose	Classic	Cobee	Cove	Flat	Ledge	Bullnose	Classic	Cobee	Cove	Flat
Flat	Knife	Ledge	Ogee	Flat	Knife	Ledge	Ogee	Flat	Knife	Ledge
Reed	Radius	Waterfall		Reed	Radius	Waterfall		Reed	Radius	Waterfall

4 Select hardware

[View hardware details](#)

PL-105 Matte Black PL-106 Matte Nickel	PL-112 Matte Black PL-113 Matte Nickel	PL-105 Matte Black PL-106 Matte Nickel	PL-112 Matte Black PL-113 Matte Nickel	PL-105 Matte Black PL-106 Matte Nickel	PL-112 Matte Black PL-113 Matte Nickel	PL-105 Matte Black PL-106 Matte Nickel	PL-112 Matte Black PL-113 Matte Nickel	PL-105 Matte Black PL-106 Matte Nickel	PL-112 Matte Black PL-113 Matte Nickel
PL-115 Matte Black PL-116 Matte Nickel	PL-125 Antique Pewter PL-126 Antique English PL-127 Matte Black	PL-115 Matte Black PL-116 Matte Nickel	PL-125 Antique Pewter PL-126 Antique English PL-127 Matte Black	PL-115 Matte Black PL-116 Matte Nickel	PL-125 Antique Pewter PL-126 Antique English PL-127 Matte Black	PL-115 Matte Black PL-116 Matte Nickel	PL-125 Antique Pewter PL-126 Antique English PL-127 Matte Black	PL-115 Matte Black PL-116 Matte Nickel	PL-125 Antique Pewter PL-126 Antique English PL-127 Matte Black
FL-210 Anodized Aluminum	Finger Pull "W"/"G"	FL-210 Anodized Aluminum	Finger Pull "W"/"G"	FL-210 Anodized Aluminum	Finger Pull "W"/"G"	FL-210 Anodized Aluminum	Finger Pull "W"/"G"	FL-210 Anodized Aluminum	Finger Pull "W"/"G"

Product features.

- "M" styles have finished adjustable shelf behind door set
- Adjustable glides
- Full extension drawers - locking
- "W"/"G" styles have black adjustable shelf behind door set
- Utility drawer w/ felt liner

NOTES

- All units are std with flush ends

Options.

ACCESSORIES

- REF-01: Modify Storage section for refrigerator - \$205
- Option is available on 93 x 24 x 36

DOOR

- D2: Wood Door Lock - \$100 per door set
- D6: Delete doors - n/c
- D6A: "W"/"G" Styles - Delete Doors and replace black laminate shelf with finished shelf - n/c

OPEN PLAN - FINISHED BACK

- OPB: "W" "G" Style - Modify Unit for Open Plan Application - \$195
- OPB: "M" Style - Modify Unit for Open Plan Application - \$95

TRASH CAN

- TRC50: EZ Cargo 50 dual trash can - (1) 8 gallon and (1) 5 gallon
- \$680

Conference - Central park.

Conferencing Caseloads
Mobile Extension Buffet Cart

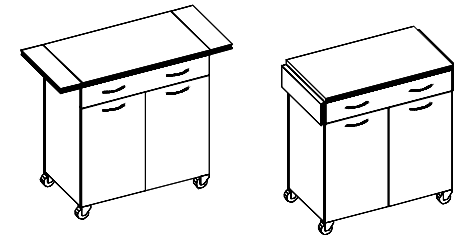

1 Select a model w" x d" x h"	weight	Standard Veneer Top Standard Veneer Chassis		Premium Veneer Top Premium Veneer Chassis		High Pressure Laminate Top Veneer Chassis		Thermally Fused Laminate Top Thermally Fused Laminate Chassis	
		35 x 24 x 36	170	CPC3524SC483W	2671	CPC3524SC483P	2939	"G" Option N/A	CPC3524SC483M
2 Select a finish <i>View finish details</i>		WAC	WWM	PO02	TBCO	WSO		MAC	
		WRC	WEW	PO03	TBSW			MEC	
		WIC	WGW	PO04	TSTV			MHC	
		WEC	WBW	PO05	TSMV			MOC	
		WHC	WSW	PO06	TSLV			MGW	
		WOC	WNW	PO07	TOBW			MTW	
		WAM	WWP		WBO			MWL	
		WCM	PO01		WMO			MSW	
3 Select a edge <i>View edge details</i>		Edge			Edge			Edge	
		N/A			N/A			N/A	
4 Select hardware <i>View hardware details</i>		 		 		 		 	

View statement of line

Product features.

- (2) TM50 grommets in backpanel
- Flat/Flush ends
- Hinged top extensions
- Full extension drawers - locking silver casters
- Open storage & closed cabinet w/ grommet

Conference - Central park.

Visual Boards
Visual Board

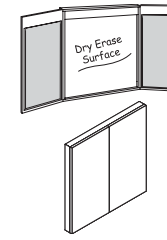

1 Select a model w" x d" x h"	weight	Standard Veneer Top		Premium Veneer Top		High Pressure Laminate Top		Thermally Fused Laminate Top	
		Standard Veneer Chassis		Premium Veneer Chassis		Veneer Chassis		Thermally Fused Laminate Chassis	
48 x 4 x 48	130	CPC4848VB475W	3005	CPC4848VB475P	3306	"G" Option N/A		CPC4848VB475M	1295
36 x 4 x 48	120	CPC3648VB475W	2790	CPC3648VB475P	3069	"G" Option N/A		CPC3648VB475M	1249
48 x 4 x 36	120	CPC4836VB475W	2790	CPC4836VB475P	3069	"G" Option N/A		CPC4836VB475M	1249
36 x 4 x 36	110	CPC3636VB475W	2424	CPC3636VB475P	2667	"G" Option N/A		CPC3636VB475M	1204
2 Select a finish <i>View finish details</i>		WAC	WWM	PO02	TBCO	WSO		MAC	
		WRC	WEW	PO03	TBSW			MEC	
		WIC	WGW	PO04	TSTV			MHC	
		WEC	WBW	PO05	TSMV			MOC	
		WHC	WSW	PO06	TSLV			MGW	
		WOC	WNW	PO07	TOBW			MTW	
		WAM	WWP		WBO			MWL	
		WCM	PO01		WMO			MSW	
					WNO				
3 Select an edge <i>View edge details</i>		Edge			Edge			Edge	
		N/A			N/A			N/A	
4 Select hardware <i>View hardware details</i>		Hardware			Hardware			Hardware	
		N/A			N/A			N/A	

View statement of line

Product features.

- Built-in wall levelers
- Doors are 1" thick
- Fabric tack surface on doors (spinel sandstone)
- Finger pull at bottom
- White dry marker surface

Options.

ACCESSORIES

- DMKIT: Dry market kit for visual board - \$50
- Includes: 4 colored markers, eraser, 4 magnetic pins
- DMRT01: Replace fabric panels with dry marker/erase board - \$100
- FC20: Flip Chart 34" x 20" - \$55 each

Conference - Central park.

Lecterns

Lectern

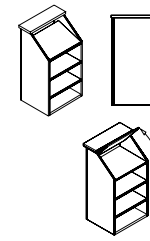

1 Select a model w" x d" x h"	weight	Standard Veneer Top Standard Veneer Chassis		Premium Veneer Top Premium Veneer Chassis		High Pressure Laminate Top Veneer Chassis		Thermally Fused Laminate Top Thermally Fused Laminate Chassis	
		24 x 24 x 46	130	CPC2424LC499W	2812	CPC2424LC499P	3094	"G" Option N/A	CPC2424LC499M
2 Select a finish View finish details		WAC	WWM	PO02	TBCO	WSO		MAC	
		WRC	WEW	PO03	TBSW			MEC	
		WIC	WGW	PO04	TSTV			MHC	
		WEC	WBW	PO05	TSMV			MOC	
		WHC	WSW	PO06	TSLV			MGW	
		WOC	WNW	PO07	TOBW			MTW	
		WAM	WWP		WBO			MWL	
		WCM	PO01		WMO			MSW	
					WNO				
3 Select a edge View edge details		Edge			Edge		Edge	Edge	
		N/A			N/A		N/A	N/A	
4 Select hardware View hardware details		Hardware			Hardware		Hardware	Hardware	
		N/A			N/A		N/A	N/A	

[View statement of line](#)

Product features.





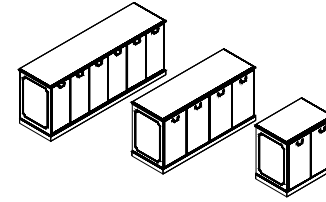

- 2 Adjustable shelves
- Front wheels/casters for easy relocation
- Lectern surface tilts up for storage

Conference - Jamestown.

Full Pedestal Credenzas
 Conferencing Storage Credenza



[View statement of line](#)

1 Select a model w" x d" x h"	weight	Standard Veneer Top	Premium Veneer Top	High Pressure Laminate Top	Thermally Fused Laminate Top
		Standard Veneer Chassis	Premium Veneer Chassis	Veneer Chassis	Thermally Fused Laminate Chassis
Triple Storage					
95 x 24 x 36	390	JCM9524CA124W 7135	"P" Option N/A	JCM9524CA124G 7135	"M" Option N/A
89 x 24 x 36	340	JCM8924CA124W 6506	"P" Option N/A	JCM8924CA124G 6506	"M" Option N/A
Double Storage					
72 x 24 x 36	260	JCM7224CA124W 5359	"P" Option N/A	JCM7224CA124G 5359	"M" Option N/A
66 x 24 x 36	260	JCM6624CA124W 5245	"P" Option N/A	JCM6624CA124G 5245	"M" Option N/A
60 x 24 x 36	245	JCM6024CA124W 5189	"P" Option N/A	JCM6024CA124G 5189	"M" Option N/A
48 x 24 x 36	200	JCM4824CA124W 4672	"P" Option N/A	JCM4824CA124G 4672	"M" Option N/A
Single Storage					
37 x 24 x 36	130	JCM3724CA124W 2735	"P" Option N/A	JCM3724CA124G 2735	"M" Option N/A
31 x 24 x 36	135	JCM3124CA124W 2558	"P" Option N/A	JCM3124CA124G 2558	"M" Option N/A
2 Select a finish View finish details		WAC WSW WRC WNW WIC WEW WEC WHC WOC WGW WBW		GAC GIC GHC GOC GNW GEW	
3 Select a edge View edge details		 Traditional		 Traditional	
4 Select hardware View hardware details		 PL-4 Antique Brass  PL-5 Antique Brass PL-50 Brushed Pewter		 PL-4 Antique Brass  PL-5 Antique Brass PL-50 Brushed Pewter	

Product features.

- Black adjustable shelf behind door set

Options.

ACCESSORIES

- REF-01: Modify Storage section for refrigerator - \$205

AUDIO VISUAL

- AVR1: AV Exhaust Fan - \$470

- AVR2: AV Pullout Rack - \$1655

BACK PANEL WALL ACCESS

- M19: 2 Heat vent/cord access slots in back - \$ 160

MOLDING PANEL

- DSM2: Delete panel molding - Deduct \$50

DOOR

- D2: Wood Door Lock - \$100 per door set

- D6: Delete doors - n/c

Flush Cut

- FC-B: Flush Unit Both Sides(Facing) for Ganging - \$100

- FC-L: Flush Unit Left (Facing) for Ganging - \$100

- FC-R: Flush Unit Right(Facing) for Ganging - \$100

Open Plan – Finished Back

- OPB: "W" "G" Style - Modify Unit for Open Plan Application - \$295

Trash Can

- TRC50: EZ Cargo 50 dual trash can - (1) 8 gallon and (1) 5 gallon

- \$680

Shelves

- S25: Replace Black Laminate Shelf with Finished Shelf - \$80 per shelf



Conference - Jamestown.

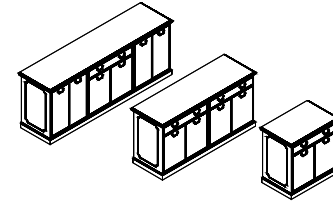



Full Pedestal Credenzas
 Conferencing Buffet Credenza



1 Select a model w" x d" x h"	weight	Standard Veneer Top Standard Veneer Chassis		Premium Veneer Top Premium Veneer Chassis		High Pressure Laminate Top Veneer Chassis		Thermally Fused Laminate Top Thermally Fused Laminate Chassis	
		Triple Buffet 95 x 24 x 36 Double Buffet 72 x 24 x 36 Single Buffet 37 x 24 x 36		JCM9524CA126W 8022	"P" Option N/A	JCM9524CA126G 8022	"M" Option N/A	JCM7224CA126G 6127	"M" Option N/A

2 Select a finish <i>View finish details</i>	WAC WSW WRC WNW WIC WEW WEC WHC WOC WGW WBW		GAC GIC GHC GOC GNW GEW	

3 Select an edge <i>View edge details</i>	 Traditional		 Traditional	

4 Select hardware <i>View hardware details</i>	 PL-4 Antique Brass		 PL-5 Antique Brass PL-50 Brushed Pewter		 PL-4 Antique Brass		 PL-5 Antique Brass PL-50 Brushed Pewter	

[View statement of line](#)

Product features.

- Black adjustable shelf behind door set
- Utility drawer w/ felt liner

Options.

ACCESSORIES

- REF-01: Modify Storage section for refrigerator - \$205
Option is available on 94"

MOLDING

- DSM2: Delete panel molding - Deduct \$50

DOOR

- D6: Delete doors - n/c

FLUSH CUT

- FC-B: Flush Unit Both Sides(Facing) for Ganging - \$100
- FC-L: Flush Unit Left (Facing) for Ganging - \$100
- FC-R: Flush Unit Right(Facing) for Ganging - \$100





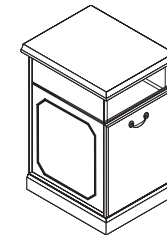

OPEN PLAN – FINISHED BACK

- OPB: "W" "G" Style - Modify Unit for Open Plan Application - \$295
- Trash Can
 - TRC50: EZ Cargo 50 dual trash can - (1) 8 gallon and (1) 5 gallon - \$650
- Shelf
 - S25: Replace Black Laminate Shelf with Finished Shelf - \$80 per shelf

Conference - Jamestown.

Cabinets
Traditional Telephone Cabinet



1 Select a model w" x d" x h"	weight	Standard Veneer Top Standard Veneer Chassis		Premium Veneer Top Premium Veneer Chassis		High Pressure Laminate Top Veneer Chassis		Thermally Fused Laminate Top Thermally Fused Laminate Chassis	
		16 x 22 x 29	50	JCM1622TS487W	2021	"P" Option N/A		JCM1622TS487G	2021
2 Select a finish View finish details		WAC	WSW			GAC			
		WRC	WNW			GIC			
		WIC	WEW			GHC			
		WEC				GOC			
		WHC				GNW			
		WOC				GEW			
		WGW							
		WBW							
3 Select a edge View edge details									
		Traditional				Traditional			
4 Select hardware View hardware details									
		PL-4 Antique Brass		PL-5 Antique Brass PL-50 Brushed Pewter		PL-4 Antique Brass		PL-5 Antique Brass PL-50 Brushed Pewter	

[View statement of line](#)

Product features.

- Hardwood base and moldings

Options.

FLUSH CUT

- FC-B: Flush Unit Both Sides(Facing) for Ganging - \$100
- FC-L: Flush Unit Left (Facing) for Ganging - \$100
- FC-R: Flush Unit Right(Facing) for Ganging - \$100

MOLDING

- STC01: Optional Scalloped Molding - \$105
- DSM2: Delete panel molding - Deduct \$50

OPEN PLAN – FINISHED BACK

- OPB: "W" "G" Style - Modify Unit for Open Plan Application - \$295

Conference - NOT SO square.

Full Pedestal Credenzas
 Conferencing Storage Credenza

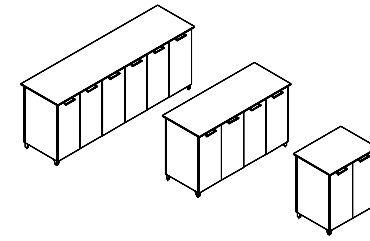

1 Select a model
 w" x d" x h"

weight	Standard Veneer Top Standard Veneer Chassis		Premium Veneer Top Premium Veneer Chassis		High Pressure Laminate Top Veneer Chassis		Thermally Fused Laminate Top Thermally Fused Laminate Chassis	
Triple Storage								
95 x 24 x 36	400	NSS9524CA124W 4441	NSS9524CA124P 4886	NSS9524CA124G 4441	NSS9524CA124G 4441	NSS9524CA124M 3479	NSS9524CA124M 3479	
89 x 24 x 36	360	NSS8924CA124W 4342	NSS8924CA124P 4777	NSS8924CA124G 4342	NSS8924CA124M 3234	NSS8924CA124M 3234		
Double Storage								
72 x 24 x 36	300	NSS7224CA124W 3769	NSS7224CA124P 4146	NSS7224CA124G 3769	NSS7224CA124M 2660	NSS7224CA124M 2660		
66 x 24 x 36	275	NSS6624CA124W 3667	NSS6624CA124P 4034	NSS6624CA124G 3667	NSS6624CA124M 2610	NSS6624CA124M 2610		
60 x 24 x 36	250	NSS6024CA124W 3566	NSS6024CA124P 3923	NSS6024CA124G 3566	NSS6024CA124M 2560	NSS6024CA124M 2560		
48 x 24 x 36	200	NSS4824CA124W 3363	NSS4824CA124P 3700	NSS4824CA124G 3363	NSS4824CA124M 2459	NSS4824CA124M 2459		
Single Storage								
37 x 24 x 36	150	NSS3724CA124W 2025	NSS3724CA124P 2228	NSS3724CA124G 2025	NSS3724CA124M 1451	NSS3724CA124M 1451		
31 x 24 x 36	135	NSS3124CA124W 1879	NSS3124CA124P 2067	NSS3124CA124G 1879	NSS3124CA124M 1406	NSS3124CA124M 1406		

[View statement of line](#)

2 Select a finish
[View finish details](#)

Metal finish
 MFS Silver. Additional metal finishes are available, see options.

WAC	WEW	TBCO	WSO	GAC	GNW	MAC
WEC	WGW	TBSW		GEC	GSTV +10%	MEC
WIC	WBW	TSTV		GIC	GSLV +10%	MOC
WOC	WSW	TSMV		GHC	GWL	MGW
WAM	WNW	TSLV		GOC		MTW
WHC	WWP	TOBWW		GAM		MWL
WCM		WBO		GCM		MHC
WWW		WMO		GWM		MSW
		WNO		GEW		

3 Select a edge
[View edge details](#)

NSS Bevel	NSS Bevel	NSS Bevel	NSS Bevel

4 Select hardware
[View hardware details](#)

PL-115 Matte Black PL-116 Matte Nickel	PL-210 Anodized Aluminum	PL-115 Matte Black PL-116 Matte Nickel	PL-210 Anodized Aluminum	PL-115 Matte Black PL-116 Matte Nickel	PL-210 Anodized Aluminum	PL-115 Matte Black PL-116 Matte Nickel	PL-210 Anodized Aluminum
	"G" Hardware"/>		"G" Hardware"/>		"G" Hardware"/>		"G" Hardware"/>
PL-260 Anodized Aluminum PL-261 White	Finger Pull "W"/>"G"	PL-260 Anodized Aluminum PL-261 White	Finger Pull "W"/>"G"	PL-260 Anodized Aluminum PL-261 White	Finger Pull "W"/>"G"	PL-260 Anodized Aluminum PL-261 White	Finger Pull "W"/>"G"

Product features.

- Adjustable glides
- "M" styles shelves match finish
- Standard Silver feet (optional White, Black)
- Storage cabinet w/ adjustable black laminate shelf
- "W"/"G" styles have black adjustable shelf

NOTES

- Ganging: For end to end ganging, specify ganging flush cut modification for each ganged unit

Options.

ACCESSORIES

- REF-01: Modify Storage section for refrigerator - \$205

AUDIO VISUAL

- AVR1: AV Exhaust Fan - \$470
- AVR2: AV Pullout Rack - \$1655

DOOR

- D2: Wood Door Lock - \$100 per door set
- D6: Delete Doors - n/c
- D6A: "W"/"G" Styles - Delete Doors and replace black laminate shelf with finished shelf - n/c
- D8: Delete feet (includes extended fronts to the floor) - n/c

FLUSH CUT

- FC-B: Flush Unit Both Sides(Facing) for Ganging - \$55
- FC-L: Flush Unit Left (Facing) for Ganging - \$55
- FC-R: Flush Unit Right(Facing) for Ganging - \$55

OPEN PLAN - FINISHED BACK

- OPB: "W" "G" Style - Modify Unit for Open Plan Application - \$195
- OPBM: "M" Style - Modify Unit for Open Plan Application - \$95 Premium Finish Option
- Specify foot metal finish color - \$30 per foot
- MFB: Black, MFW: White Shelf
- S25: Replace Black Laminate Shelf with Finished Shelf - \$80 per shelf
- TRC50: EZ Cargo 50 dual trash can - (1) 8 gallon and (1) 5 gallon - \$680

Conference - NOT SO square.

Storage Credenzas
Buffet / Storage Credenzas

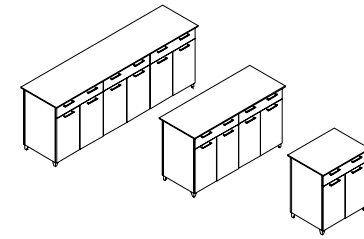

1 Select a model
w" x d" x h"

weight	Standard Veneer Top Standard Veneer Chassis		Premium Veneer Top Premium Veneer Chassis		High Pressure Laminate Top Veneer Chassis		Thermally Fused Laminate Top Thermally Fused Laminate Chassis		
	Triple Storage 95 x 24 x 36 89 x 24 x 36	400 360	NSS9524CA126W NSS8924CA126W	4831 4679	NSS9524CA126P NSS8924CA126P	5315 5147	NSS9524CA126G NSS8924CA126G	4831 4679	NSS9524CA126M NSS8924CA126M
Double Storage 72 x 24 x 36 60 x 24 x 36	300 250	NSS7224CA126W NSS6024CA126W	3994 3792	NSS7224CA126P NSS6024CA126P	4394 4172	NSS7224CA126G NSS6024CA126G	3994 3792	NSS7224CA126M NSS6024CA126M	3072 2972
Single Storage 37 x 24 x 36 31 x 24 x 36	150 135	NSS3724CA126W NSS3124CA126W	2137 1992	NSS3724CA126P NSS3124CA126P	2351 2192	NSS3724CA126G NSS3124CA126G	2137 1992	NSS3724CA126M NSS3124CA126M	1659 1612

[View statement of line](#)

2 Select a finish
[View finish details](#)

Metal finish
MFS Silver. Additional metal finishes are available, see options.

WAC	WEW
WEC	WGW
WIC	WBW
WOC	WSW
WAM	WNW
WHC	WWP
WCM	
WWW	

TBCO	WSO
TBSW	
TSTV	
TSMV	
TSLV	
TOBW	
WBO	
WMO	
WNO	

GAC	GNW
GEC	GSTV +10%
GIC	GSLV +10%
GHC	GWL
GOC	
GAM	
GCM	
GWM	
GEW	

MAC
MEC
MOC
MGW
MTW
MWL
MHC
MSW

3 Select a edge
[View edge details](#)



4 Select hardware
[View hardware details](#)

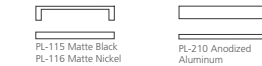
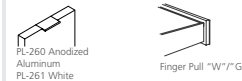
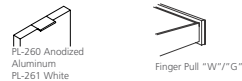

Product features.

- 1 adjustable black laminate shelf behind each door set
- Soft close suspension drawer(s)
- Standard Silver Feet (optional White, Black)

NOTES

- Unit not designed for open plan use. Select OPB for Open Plan application

Options.

DOOR

- D2: Door Lock - \$100 per door set
- D6: Delete Doors - n/c
- D6A: "W" / "G" Styles - Delete Doors and replace black laminate shelf with finished shelf - n/c
- D9SC: Soft Close Door Hinges - \$20 per door

FEET

- D8: Delete feet (includes extended fronts to the floor) - n/c

FLUSH CUT

- FC-B: Flush Unit Both Sides(Facing) for Ganging - \$55
- FC-L: Flush Unit Left (Facing) for Ganging - \$55
- FC-R: Flush Unit Right(Facing) for Ganging - \$55

GROMMETS (STANDARD LOCATION)

- Specify Color and Location (Right/Left/Center) - \$50 ea.
- Black: TM30-R (Right), TM30-L (Left), TM30-C (Center)
- Silver: TM31-R (Right), TM31-L (Left), TM31-C (Center)
- White: TM34-R (Right), TM34-L (Left), TM34-C (Center)

GROMMETS (NON-STANDARD LOCATION)

- Provide drawing w/ Grommet Location and Specify Color - \$95 ea.
- Black: TM30-NS
- Silver: TM31-NS
- White: TM34-NS
- Grommet (Vertical Surface)
- Standard Location - \$50 ea.
- Black Plastic Vertical Surface: TM50-C (Bottom Center)
- Non-Standard Location - \$90 ea.
- Black Plastic Vertical Surface: TM50-NS

Open Plan - Finished Back

- OPB: "W" "G" Style - Modify Unit for Open Plan Application - \$195
- OPBM: "M" Style - Modify Unit for Open Plan Application - \$95
- Premium Finish Option

- Specify foot metal finish color - \$30 per foot

- MFB: Black, MFW: White

Trash Can

- TRC50: EZ Cargo 50 dual trash can - (1) 8 gallon and (1) 5 gallon - \$680

Conference - NOT SO square.

Storage Credenzas
Console Cabinets

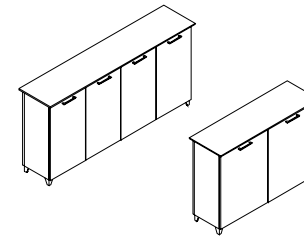

1 Select a model

w" x d" x h"

weight	Standard Veneer Top Standard Veneer Chassis		Premium Veneer Top Premium Veneer Chassis		High Pressure Laminate Top Veneer Chassis		Thermally Fused Laminate Top Thermally Fused Laminate Chassis	
	4 Door							
72 x 15 x 36	210	NSS7215CA524W 3313	NSS7215CA524P 3645	NSS7215CA524G 3313	NSS7215CA524M 2135			
60 x 15 x 36	175	NSS6015CA524W 3234	NSS6015CA524P 3558	NSS6015CA524G 3234	NSS6015CA524M 1945			
2 Door								
48 x 15 x 36	140	NSS4815CA524W 1992	NSS4815CA524P 2192	NSS4815CA524G 1992	NSS4815CA524M 1396			
36 x 15 x 36	110	NSS3615CA524W 1727	NSS3615CA524P 1900	NSS3615CA524G 1727	NSS3615CA524M 1238			

View statement of line

2 Select a finish

View finish details

Metal finish
MFS Silver. Additional metal finishes are available, see options.

WAC	WEW	TBCO	WSO	GAC	GNW	MAC
WEC	WGW	TBSW		GEC	GSTV +10%	MEC
WIC	WBW	TSTV		GIC	GSLV +10%	MOC
WOC	WSW	TSMV		GHC	GWL	MGW
WAM	WNW	TSLV		GOC		MTW
WHC	WWP	TOBW		GAM		MWL
WCM		WBO		GCM		MHC
WWW		WMO		GWM		MSW
		WNO		GEW		

3 Select a edge

View edge details



4 Select hardware

View hardware details

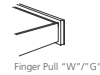
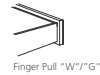
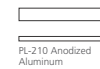
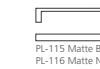
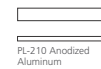
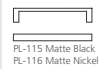
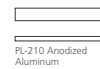
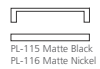
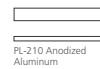
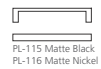

Product features.

- 1 adjustable black laminate shelf behind each section
- Interior shelf depth 12"
- Standard Silver Feet (optional White, Black)

NOTES

- Unit not designed for open plan use. Select OPB for Open Plan application

Options.

DOOR

- D2: Door Lock - \$100 per door set
- D6: Delete Doors - n/c
- D6A: "W"/"G" Styles - Delete Doors and replace black laminate shelf with finished shelf - n/c
- D9SC: Soft Close Door Hinges - \$20 per door

FEET

- D8: Delete feet (includes extended fronts to the floor) - n/c

FLUSH CUT

- FC-B: Flush Unit Both Sides(Facing) for Ganging - \$55
- FC-L: Flush Unit Left (Facing) for Ganging - \$55
- FC-R: Flush Unit Right(Facing) for Ganging - \$55

GROMMETS (STANDARD LOCATION)

- Specify Color and Location (Right/Left/Center) - \$50 ea.
- Black: TM30-R (Right), TM30-L (Left), TM30-C (Center)
- Silver: TM31-R (Right), TM31-L (Left), TM31-C (Center)
- White: TM34-R (Right), TM34-L (Left), TM34-C (Center)
- TM50: Black grommet in back panel - \$45

GROMMETS (NON-STANDARD LOCATION)

- Provide drawing w/ Grommet Location and Specify Color - \$95 ea.
- Black: TM30-NS
- Silver: TM31-NS
- White: TM34-NS
- Grommet (Vertical Surface)
- Standard Location - \$50 ea.
- Black Plastic Vertical Surface: TM50-C (Bottom Center)
- Non-Standard Location - \$90 ea.
- Black Plastic Vertical Surface: TM50-NS

Open Plan - Finished Back

- OPB: "W" "G" Style - Modify Unit for Open Plan Application - \$195
- OPBM: "M" Style - Modify Unit for Open Plan Application - \$95

- Shelves
- S25: "W"/"G" Styles - Replace Black Laminate Shelf with Finished Shelf - \$80 per shelf
- S714F: Heavy Duty Lumber 1" Shelves - \$80 per shelf ("M" Styles - n/a)

Premium Finish Option

- Specify foot metal finish color - \$30 per foot
- MFB: Black, MFW: White

Conference - Prado.

Full Pedestal Credenzas
 Conferencing Storage Credenza

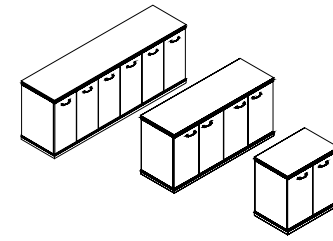

[View statement of line](#)

1 Select a model w" x d" x h"	weight	Standard Veneer Top	Premium Veneer Top	High Pressure Laminate Top	Thermally Fused Laminate Top
		Standard Veneer Chassis	Premium Veneer Chassis	Veneer Chassis	Thermally Fused Laminate Chassis
Triple Storage					
94 x 24 x 36	360	PRA9424CA124W 7396	"P" Option N/A	PRA9424CA124G 7396	"M" Option N/A
88 x 24 x 36	345	PRA8824CA124W 7255	"P" Option N/A	PRA8824CA124G 7255	"M" Option N/A
Double Storage					
71 x 24 x 36	270	PRA7124CA124W 5584	"P" Option N/A	PRA7124CA124G 5584	"M" Option N/A
65 x 24 x 36	260	PRA6524CA124W 5475	"P" Option N/A	PRA6524CA124G 5475	"M" Option N/A
59 x 24 x 36	220	PRA5924CA124W 5371	"P" Option N/A	PRA5924CA124G 5371	"M" Option N/A
48 x 24 x 36	210	PRA4824CA124W 5155	"P" Option N/A	PRA4824CA124G 5155	"M" Option N/A
Single Storage					
36 x 24 x 36	160	PRA3624CA124W 3194	"P" Option N/A	PRA3624CA124G 3194	"M" Option N/A
30 x 24 x 36	150	PRA3024CA124W 3054	"P" Option N/A	PRA3024CA124G 3054	"M" Option N/A
2 Select a finish View finish details	WAC			GAC	
	WRC			GIC	
	WIC			GHC	
	WHC			GOC	
	WOC			GNW	
	WEW			GEW	
	WGW				
	WBW				
	WSW				
	WNW				
3 Select a edge View edge details					
	Prado			Prado	
4 Select hardware View hardware details		PL-115 Matte Black PL-116 Matte Nickel			
		PL-125 Antique Pewter PL-126 Antique English PL-127 Matte Black			

Product features.

- Adjustable glides
- 1 Adjustable black shelf/storage
- Hardwood base / dentil molding

Options.

ACCESSORIES

- REF-01: Modify Storage section for refrigerator - \$205

AUDIO VISUAL

- AVR1: AV Exhaust Fan - \$470
- AVR2: AV Pullout Rack - \$1655

BACK PANEL WALL ACCESS

- M19: 2 Heat vent/cord access slots in back - \$ 160

DOOR

- D2: Wood Door Lock - \$100 per door set

FLUSH CUT





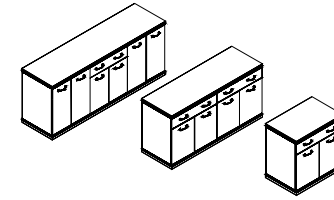

- FC-B: Flush Unit Both Sides(Facing) for Ganging - \$100
- FC-L: Flush Unit Left (Facing) for Ganging - \$100
- FC-R: Flush Unit Right(Facing) for Ganging - \$100
- Open Plan – Finished Back
- OPB: "W" "G" Style - Modify Unit for Open Plan Application - \$195
- Trash Can
- TRC50: EZ Cargo 50 dual trash can - (1) 8 gallon and (1) 5 gallon - \$680
- Shelf
- S25: Replace Black Laminate Shelf with Finished Shelf - \$80 per shelf

Conference - Prado.

Full Pedestal Credenzas
 Conferencing Buffet Credenza

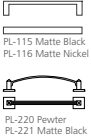

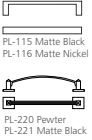
[View statement of line](#)

1 Select a model w" x d" x h"	weight	Standard Veneer Top Standard Veneer Chassis		Premium Veneer Top Premium Veneer Chassis		High Pressure Laminate Top Veneer Chassis		Thermally Fused Laminate Top Thermally Fused Laminate Chassis	
		Triple Buffet 94 x 24 x 36 Double Buffet 71 x 24 x 36 Single Buffet 36 x 24 x 36	350 300 160	PRA9424CA126W PRA7124CA126W PRA3624CA126W	7140 6272 3335	"P" Option N/A "P" Option N/A "P" Option N/A	PRA9424CA126G PRA7124CA126G PRA3624CA126G	7140 6272 3335	"M" Option N/A "M" Option N/A "M" Option N/A
2 Select a finish View finish details		WAC WRC WIC WHC WOC WEW WGW WBW WSW WNW			GAC GIC GHC GOC GNW GEW				
3 Select an edge View edge details		 Prado			 Prado				
4 Select hardware View hardware details									

Product features.

- 1 Adjustable black shelf/storage
- Utility drawer w/ felt liner

Options.

ACCESSORIES

- REF-01: Modify Storage section for refrigerator - \$205

DOOR

- D2: Wood Door Lock - \$100 per door set

FLUSH CUT

- FC-B: Flush Unit Both Sides(Facing) for Ganging - \$100
- FC-L: Flush Unit Left (Facing) for Ganging - \$100
- FC-R: Flush Unit Right(Facing) for Ganging - \$100

OPEN PLAN – FINISHED BACK

- OPB: "W" "G" Style - Modify Unit for Open Plan Application - \$195

TRASH CAN

- TRC50: EZ Cargo 50 dual trash can - (1) 8 gallon and (1) 5 gallon - \$650

Shelf







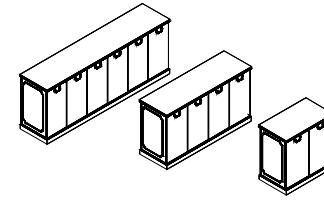

- S25: Replace Black Laminate Shelf with Finished Shelf - \$80 per shelf

Conference - Richmond park.

Full Pedestal Credenzas
 Conferencing Storage Credenza



[View statement of line](#)

1 Select a model w" x d" x h"	weight	Standard Veneer Top Standard Veneer Chassis		Premium Veneer Top Premium Veneer Chassis		High Pressure Laminate Top Veneer Chassis		Thermally Fused Laminate Top Thermally Fused Laminate Chassis	
		Triple Storage 95 x 24 x 36 89 x 24 x 36 Double Storage 72 x 24 x 36 66 x 24 x 36 60 x 24 x 36 48 x 24 x 36 Single Storage 37 x 24 x 36 31 x 24 x 36		390 340 290 260 245 200 150 135	RPC9524CA124W RPC8924CA124W RPC7224CA124W RPC6624CA124W RPC6024CA124W RPC4824CA124W RPC3724CA124W RPC3124CA124W	6548 6396 4600 4449 4300 4000 2654 2504	"P" Option N/A "P" Option N/A "P" Option N/A "P" Option N/A "P" Option N/A "P" Option N/A "P" Option N/A	RPC9524CA124G RPC8924CA124G RPC7224CA124G RPC6624CA124G RPC6024CA124G RPC4824CA124G RPC3724CA124G RPC3124CA124G	6548 6396 4600 4449 4300 4000 2654 2504
2 Select a finish View finish details	WAC WRC WIC WHC WOC WEW WGW WBW WSW WNW					GAC GIC GHC GOC GNW GEW			
3 Select a edge View edge details	 Richmond	 Classic				 Richmond	 Classic		
4 Select hardware View hardware details	 PL-4 Antique Brass	 PL-5 Antique Brass PL-50 Brushed Pewter				 PL-4 Antique Brass	 PL-5 Antique Brass PL-50 Brushed Pewter		

Product features.

- Adjustable black per section laminate shelf
- Adjustable glides
- Traditional - Molding, hardwood base & profile edge on drawers / doors

NOTES

- Ganging: For end to end ganging, specify ganging flush cut modification for each ganged unit

Options.

ACCESSORIES

- REF-01: Modify Storage section for refrigerator - \$205

AUDIO VISUAL

- AVR1: AV Exhaust Fan - \$470
- AVR2: AV Pullout Rack - \$1655

BACK PANEL WALL ACCESS

- M19: 2 Heat vent/cord access slots in back - \$ 160

MOLDING PANEL

- DSM2: Delete panel molding - Deduct \$50

DOOR

- D2: Wood Door Lock - \$100 per door set
- D6: Delete Doors - n/c
- D6A: "W"/"G" Styles - Delete Doors and replace black laminate shelf with finished shelf - n/c

Flush Cut







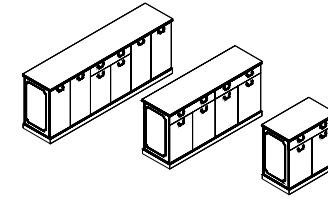

- FC-B: Flush Unit Both Sides(Facing) for Ganging - \$100
- FC-L: Flush Unit Left (Facing) for Ganging - \$100
- FC-R: Flush Unit Right(Facing) for Ganging - \$100
- Open Plan – Finished Back
- OPB: 'W "G" Style - Modify Unit for Open Plan Application - \$295
- Trash Can
- TRC50: EZ Cargo 50 dual trash can - (1) 8 gallon and (1) 5 gallon - \$680

Conference - Richmond park.

Full Pedestal Credenzas
Conferencing Buffet Credenza



[View statement of line](#)

1 Select a model w" x d" x h"	weight	Standard Veneer Top	Premium Veneer Top	High Pressure Laminate Top	Thermally Fused Laminate Top
		Standard Veneer Chassis	Premium Veneer Chassis	Veneer Chassis	Thermally Fused Laminate Chassis
Triple Buffet 95 x 24 x 36	390	RPC9524CA126W 7146	"P" Option N/A	RPC9524CA126G 7146	"M" Option N/A
Double Buffet 72 x 24 x 36	300	RPC7224CA126W 5948	"P" Option N/A	RPC7224CA126G 5948	"M" Option N/A
Single Buffet 37 x 24 x 36	175	RPC3724CA126W 3332	"P" Option N/A	RPC3724CA126G 3332	"M" Option N/A
2 Select a finish View finish details	WAC WRC WIC WHC WOC WEW WGW WBW WSW WNW			GAC	
				GIC GHC GOC GNW GEW	
3 Select a edge View edge details	  Richmond Classic			  Richmond Classic	
4 Select hardware View hardware details	  PL-4 Antique Brass PL-5 Antique Brass PL-50 Brushed Pewter			  PL-4 Antique Brass PL-5 Antique Brass PL-50 Brushed Pewter	

Product features.

- Adjustable glides
- Full extension drawers - locking
- Storage cabinet w/ adjustable black laminate shelf
- Traditional - Molding, hardwood base & profile edge on drawers / doors
- Utility drawer w/ felt liner

NOTES

- Ganging: For end to end ganging, specify ganging flush cut modification for each ganged unit

Options.

ACCESSORIES

- REF-01: Modify Storage section for refrigerator - \$205

AUDIO VISUAL

- AVR1: AV Exhaust Fan - \$470
- AVR2: AV Pullout Rack - \$1655

BACK PANEL WALL ACCESS

- M19: 2 Heat vent/cord access slots in back - \$ 160

MOLDING PANEL

- DSM2: Delete panel molding - Deduct \$50

DOOR

- D6: Delete Doors - n/c
- D6A: "W"/"G" Styles - Delete Doors and replace black laminate shelf with finished shelf - n/c
- Open Plan – Finished Back
- OPB: "W" "G" Style - Modify Unit for Open Plan Application - \$295
- Trash Can
- TRC50: EZ Cargo 50 dual trash can - (1) 8 gallon and (1) 5 gallon - \$650

Conference - Rift.

Conference Table
Round Conference Table With Column

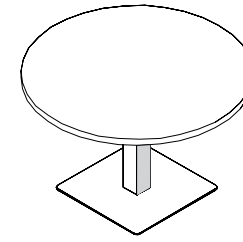

1 Select a model w" x d" x h"

weight	Standard Veneer Top	Premium Veneer Top	High Pressure Laminate Top	Thermally Fused Laminate Top
	Standard Veneer Chassis	Premium Veneer Chassis	Veneer Chassis	Thermally Fused Laminate Chassis
48 DIA x 29.5	160 "W" Option N/A	RFT4848DT089P 2924	"G" Option N/A	"M" Option N/A
42 DIA x 29.5	150 "W" Option N/A	RFT4242DT089P 2814	"G" Option N/A	"M" Option N/A
36 DIA x 29.5	140 "W" Option N/A	RFT3636DT089P 2725	"G" Option N/A	"M" Option N/A
30 DIA x 29.5	135 "W" Option N/A	RFT3030DT089P 2608	"G" Option N/A	"M" Option N/A

[View statement of line](#)

Product features.

- 1 -1/2" Thick work surface
- 4" x 4" Steel column with accent wood panel insert centered under top
- Flat edge standard
- Steel platform with self-leveling cushion bottom

2 Select a finish [View finish details](#)

TBCO
TBSW
TSTV
TSMV
TSLV
TOBW

3 Select a edge [View edge details](#)



4 Select hardware [View hardware details](#)

Hardware
N/A



Seating accommodations.

- 48" and 42" diameter seats four to five
- 36" diameter seats three to four
- 30" diameter seats three

Conference - Rift.

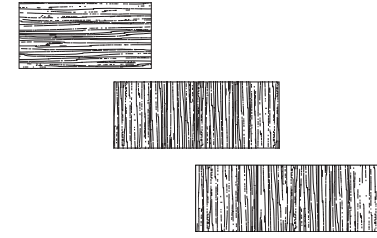
Top
Rectangle



1 Select a model w" x d" x h"	weight	Standard Veneer Top	Premium Veneer Top	High Pressure Laminate Top	Thermally Fused Laminate Top
		Standard Veneer Chassis	Premium Veneer Chassis	Veneer Chassis	Thermally Fused Laminate Chassis
3 Piece Top					
240 x 60	545	"W" Option N/A	RFT24060RE500P	10739	"G" Option N/A
240 x 54	530	"W" Option N/A	RFT24054RE500P	9667	"G" Option N/A
216 x 60	475	"W" Option N/A	RFT21660RE500P	9667	"G" Option N/A
216 x 54	455	"W" Option N/A	RFT21654RE500P	8704	"G" Option N/A
2 Piece Top					
192 x 54	405	"W" Option N/A	RFT19254RE500P	6622	"G" Option N/A
168 x 54	355	"W" Option N/A	RFT16854RE500P	6444	"G" Option N/A
144 x 48	270	"W" Option N/A	RFT14448RE500P	5888	"G" Option N/A
120 x 48	225	"W" Option N/A	RFT12048RE500P	5556	"G" Option N/A
1 Piece Top					
96 x 48	190	"W" Option N/A	RFT9648RE500P	3194	"G" Option N/A
84 x 42	145	"W" Option N/A	RFT8442RE500P	3073	"G" Option N/A
72 x 36	110	"W" Option N/A	RFT7236RE500P	2815	"G" Option N/A
			TBCO TBSW TSTV TSMV TSLV TOBW		
			 Flat  Rift		
			Hardware N/A		

[View statement of line](#)

Product features.

- 1.5" thick tops
- Tops and bases are pre-located to ensure proper installation location

Seating accommodations.

- 240" seats sixteen to eighteen
- 216" seats twelve to fourteen
- 192" seats ten to twelve
- 168" seats ten
- 144" and 120" seats eight to ten
- 96" and 84" seats eight
- 72" seats six to eight

Options.

- Power / data communications support module hardware available in options selection
- Undertop wire trough and channels available in options section

Conference - Rift.

Top
Boat

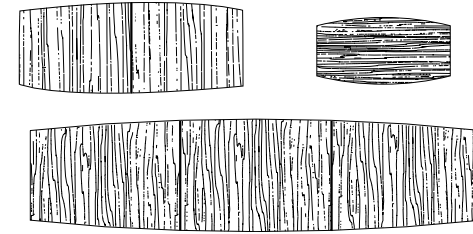

1 Select a model w" x d" x h"

weight

Standard Veneer Top Standard Veneer Chassis	Premium Veneer Top Premium Veneer Chassis	High Pressure Laminate Top Veneer Chassis	Thermally Fused Laminate Top Thermally Fused Laminate Chassis
3 Piece Top			
240 x 60/48	RFT24060BT500P 11275	"G" Option N/A	"M" Option N/A
240 x 54/42	RFT24054BT500P 10150	"G" Option N/A	"M" Option N/A
216 x 60/48	RFT21660BT500P 10150	"G" Option N/A	"M" Option N/A
216 x 54/42	RFT21654BT500P 9138	"G" Option N/A	"M" Option N/A
2 Piece Top			
192 x 54/42	RFT19254BT500P 6953	"G" Option N/A	"M" Option N/A
168 x 54/42	RFT16854BT500P 6767	"G" Option N/A	"M" Option N/A
144 x 48/39	RFT14448BT500P 6183	"G" Option N/A	"M" Option N/A
120 x 48/39	RFT12048BT500P 5833	"G" Option N/A	"M" Option N/A
1 Piece Top			
96 x 48/36	RFT9648BT500P 3354	"G" Option N/A	"M" Option N/A
84 x 42/32	RFT8442BT500P 3227	"G" Option N/A	"M" Option N/A
72 x 36/30	RFT7236BT500P 2956	"G" Option N/A	"M" Option N/A
	TBCO TBSW TSTV TSMV TSLV TOBW		
	 Flat  Rift		
	Hardware N/A		

[View statement of line](#)

Product features.

- 1.5" thick tops
- Tops and bases are pre-located to ensure proper installation location

Seating accommodations.

- 240" seats sixteen to eighteen
- 216" seats twelve to fourteen
- 192" seats ten to twelve
- 168" seats ten
- 144" and 120" seats eight to ten
- 96" and 84" seats eight
- 72" seats six

Options.

- Power / data communications support module hardware available in options selection
- Undertop wire trough and channels available in options section

2 Select a finish [View finish details](#)



3 Select a edge [View edge details](#)

4 Select hardware [View hardware details](#)

Conference - Rift.

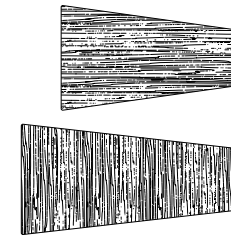
Top
Telecom Wedge



1 Select a model w" x d" x h"	weight	Standard Veneer Top	Premium Veneer Top	High Pressure Laminate Top	Thermally Fused Laminate Top
		Standard Veneer Chassis	Premium Veneer Chassis	Veneer Chassis	Thermally Fused Laminate Chassis
2 Piece					
144 x 60/30	255	"W" Option N/A	RFT14460WE500P 6183	"G" Option N/A	"M" Option N/A
132 x 60/30	240	"W" Option N/A	RFT13260WE500P 6008	"G" Option N/A	"M" Option N/A
120 x 54/30	220	"W" Option N/A	RFT12054WE500P 5833	"G" Option N/A	"M" Option N/A
1 Piece Top					
96 x 51/30	175	"W" Option N/A	RFT9651WE500P 3354	"G" Option N/A	"M" Option N/A
84 x 48/30	135	"W" Option N/A	RFT8448WE500P 3227	"G" Option N/A	"M" Option N/A
72 x 42/28	105	"W" Option N/A	RFT7242WE500P 2956	"G" Option N/A	"M" Option N/A
2 Select a finish View finish details			TBCO TBSW TSTV TSMV TSLV TOBW		
3 Select a edge View edge details			 Flat  Rift		
4 Select hardware View hardware details			Hardware N/A		

[View statement of line](#)

Product features.

- 1.5" thick tops
- Tops and bases are pre-located to ensure proper installation location

NOTES

- Contact Customer Service for Base Suggestions

Seating accommodations.



- 144" and 120" seats eight to ten
- 132" and 120" seats eight to ten
- 108", 96" and 84" seats eight
- 72" seats four to five

Options.

- Power / data communications support module hardware available in options selection
- Undertop wire trough and channels available in options section

Conference - Rift.

Top
Midship

1 Select a model w" x d" x h"	weight	Standard Veneer Top	Premium Veneer Top	High Pressure Laminate Top	Thermally Fused Laminate Top
		Standard Veneer Chassis	Premium Veneer Chassis	Veneer Chassis	Thermally Fused Laminate Chassis
2 Piece					
144 x 60/30	255	"W" Option N/A	RFT14460MD500P 6183	"G" Option N/A	"M" Option N/A
132 x 60/30	240	"W" Option N/A	RFT13260MD500P 6008	"G" Option N/A	"M" Option N/A
120 x 54/30	220	"W" Option N/A	RFT12054MD500P 5833	"G" Option N/A	"M" Option N/A
1 Piece Top					
96 x 51/30	175	"W" Option N/A	RFT9651MD500P 3354	"G" Option N/A	"M" Option N/A
84 x 48/30	135	"W" Option N/A	RFT8448MD500P 3227	"G" Option N/A	"M" Option N/A
72 x 42/28	105	"W" Option N/A	RFT7242MD500P 2956	"G" Option N/A	"M" Option N/A
2 Select a finish <i>View finish details</i>			TBCO TBSW TSTV TSMV TSLV TOBW		
3 Select a edge <i>View edge details</i>			 Flat  Rift		
4 Select hardware <i>View hardware details</i>			Hardware N/A		

[View statement of line](#)

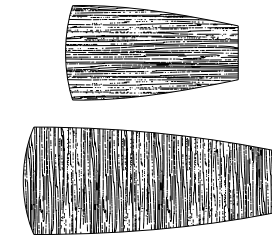

Product features.

- 1.5" thick tops
- Tops and bases are pre-located to ensure proper installation location

NOTES

- Contact Customer Service for Base Suggestions

Seating accommodations.

- 144" seats ten
- 132" and 120" seats eight to ten
- 96" and 84" seats six to eight
- 72" seats four to five

Options.

- Power / data communications support module hardware available in options selection
- Undertop wire trough and channels available in options section

Conference - Rift.

Bases

Stationary Base

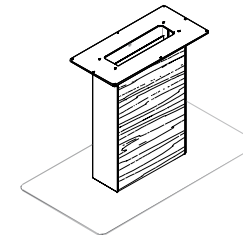

1 Select a model w" x d" x h"	weight	Standard Veneer Top	Premium Veneer Top	High Pressure Laminate Top	Thermally Fused Laminate Top
		Standard Veneer Chassis	Premium Veneer Chassis	Veneer Chassis	Thermally Fused Laminate Chassis
42 x 22	110	"W" Option N/A	RFB4222MB986P 2438	"G" Option N/A	"M" Option N/A
25 x 12	100	"W" Option N/A	RFB2512MB986P 1864	"G" Option N/A	"M" Option N/A
			TBCO TBSW TSTV TSMV TSLV TOBW		
			Edge N/A		
			Hardware N/A		

[View statement of line](#)

Product features.

- Steel column base with accent wood panel insert
- Steel platform base with self-leveling cushion bottom
- Wood panel sides attach with magnet and are easily removable for wire access

NOTES

- Power units can not be specified over base. Wire trough is required if power units are ordered

Conference - Rift.

Bases

Adjustable Height Base

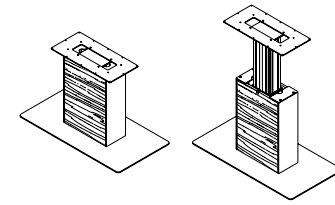

conference height bar height

1 Select a model w" x d" x h"	weight	Standard Veneer Top	Premium Veneer Top	High Pressure Laminate Top	Thermally Fused Laminate Top
		Standard Veneer Chassis	Premium Veneer Chassis	Veneer Chassis	Thermally Fused Laminate Chassis
42 x 22	110	"W" Option N/A	RFB4222MB987P 4754	"G" Option N/A	"M" Option N/A
25 x 12	100	"W" Option N/A	RFB2512MB987P 4180	"G" Option N/A	"M" Option N/A
			TBCO TBSW TSTV TSMV TSLV TOBW		
			Edge N/A		
			Hardware N/A		

[View statement of line](#)

Product features.

- Electronic mechanism with programmable lift
- Steel column base with accent wood panel insert
- Steel platform base with self-leveling cushion bottom
- Wood panel sides attach with magnet and are easily removable for wire access

NOTES

- Power units can not be specified over base. Wire trough is required if power units are ordered

Options.

BASES

Linking Cable

- LINK2: Linking cable: Linkage for two base tables - \$185
- LINK3: Linking cable: Linkage for three base tables - \$315

Conference - Rift.

Credenzas
Buffet Credenza

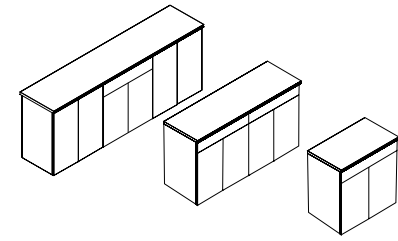

[View statement of line](#)

1 Select a model w" x d" x h"	weight	Standard Veneer Top Standard Veneer Chassis	Premium Veneer Top Premium Veneer Chassis	High Pressure Laminate Top Veneer Chassis	Thermally Fused Laminate Top Thermally Fused Laminate Chassis
Triple Buffet 96 x 22 x 36	490	"W" Option N/A	RFT9622CA126P 7177	"G" Option N/A	"M" Option N/A
Double Buffet 72 x 22 x 36	340	"W" Option N/A	RFT7222CA126P 5618	"G" Option N/A	"M" Option N/A
Single Buffet 36 x 22 x 36	170	"W" Option N/A	RFT3622CA126P 2863	"G" Option N/A	"M" Option N/A
		<p>TBCO TBSW TSTV TSMV TSLV TOBW</p>			
		<p>Edge N/A</p>			

Product features.

- Floor levelers
- Storage cabinet w/ adjustable wood shelf
- Utility drawer w/ felt liner

Options.

ACCESSORIES

- REF-01: Modify Storage section for refrigerator - \$205

DOOR

- D2: Wood Door Lock - \$100 per door set
- D2: Wood Drawer Lock - \$100 per drawer Set

OPEN PLAN – FINISHED BACK

- OPB: "W" "G" Style - Modify Unit for Open Plan Application - \$195

TOP

Clear Top

- CCG-36: clear glass on metal standoffs for 36 degree credenza--\$725 list.
- CCG-72: clear glass on metal standoffs for 72 degree credenza--\$1,225 list.
- CCG-96: clear glass on metal standoffs for 96 degree credenza--\$1,650 list.

Frosted Top

- CFG-36: frosted glass on metal standoffs for 36 degree credenza--\$900 list.
- CFG-72: frosted glass on metal standoffs for 72 degree credenza--\$1,590 list.
- CFG-96: frosted glass on metal standoffs for 96 degree credenza--\$2,115 list.

TRASH CAN

- TRC50: EZ Cargo 50 dual trash can - (1) 8 gallon and (1) 5 gallon - \$680

Conference - Rift.

Credenzas
Storage Credenza

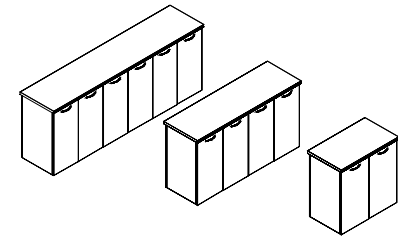

[View statement of line](#)

1 Select a model w" x d" x h"	weight	Standard Veneer Top Standard Veneer Chassis	Premium Veneer Top Premium Veneer Chassis	High Pressure Laminate Top Veneer Chassis	Thermally Fused Laminate Top Thermally Fused Laminate Chassis
Triple Storage 96 x 22 x 36	480	"W" Option N/A	RFT9622CA124P 7047	"G" Option N/A	"M" Option N/A
Double Storage 72 x 22 x 36	330	"W" Option N/A	RFT7222CA124P 5281	"G" Option N/A	"M" Option N/A
Single Storage 36 x 22 x 36	165	"W" Option N/A	RFT3622CA124P 2694	"G" Option N/A	"M" Option N/A
2 Select a finish View finish details			TBCO TBSW TSTV TSMV TSLV TOBW		
3 Select a edge View edge details			Edge N/A		
4 Select hardware View hardware details			<p>PL-300 Matte Chrome PL-301 Matte Chrome PL-302 White PL-303 White PL-304 Matte Chrome PL-305 Matte Chrome PL-306 White PL-307 White</p>		

Product features.

- Adjustable black shelf per door section
- Floor levelers

Options.

ACCESSORIES

- MTL30-S: Silver metal legs - \$315 unit
- MTL30-W: White metal legs - \$420 unit
- REF-01: Modify Storage section for refrigerator - \$205

DOOR

- D2: Wood Door Lock - \$100 per door set

OPEN PLAN – FINISHED BACK

- OPB: "W" "G" Style - Modify Unit for Open Plan Application - \$195

TOP

Clear Top

- CCG-36: clear glass on metal standoffs for 36 degree credenza--\$725 list.
- CCG-72: clear glass on metal standoffs for 72 degree credenza--\$1,225 list.
- CCG-96: clear glass on metal standoffs for 96 degree credenza--\$1,650 list.

Frosted Top

- CFG-36: frosted glass on metal standoffs for 36 degree credenza--\$900 list.
- CFG-72: frosted glass on metal standoffs for 72 degree credenza--\$1,590 list.
- CFG-96: frosted glass on metal standoffs for 96 degree credenza--\$2,115 list.

Conferencing options.

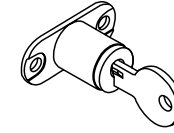
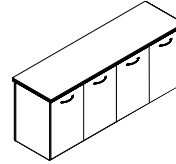
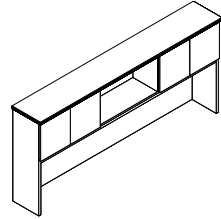

DOOR MODIFICATIONS *soft close door hinge*

Style Number	List Price
D9SC	20 Per door

Specifications

- Snap onto standard door hinge
- Requires (2) per door
- Max door height 43"
- Factory installed where specified
- Individually shipped for field installation

Notes

- Specify Each Item To Have Slow Close Feature

DOOR MODIFICATIONS *delete doors*

Style Number	List Price
D6	N/C

Specifications

- Standard Door overheads and cabinets can have door deleted for open access. Modification of hinge rails and structural components are made face ready.

DOOR MODIFICATIONS *delete doors/replace black laminate shelf w/ finished shelf*

Style Number	List Price
D6A	N/C

Specifications

- Delete doors and replace black laminate shelf with finished shelf

Notes

- Available on: Storage "W"/"G" Style Credenzas

DOOR MODIFICATIONS *panel door lock*

Style Number	List Price
D2	100 Per door set

Specifications

- Door Locks - 1 Door w/ Lock, Other Door w/ Catch Latch
- Contact Customer Service regarding limited lock locations and keying.

Notes

- Available on: Panel Doors, Wood Frame Doors, and Silverluma doors

Conferencing options.

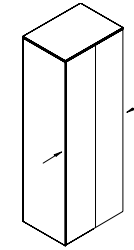
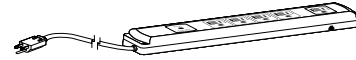
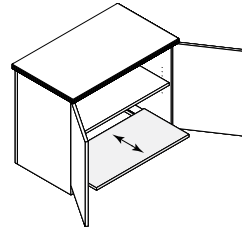
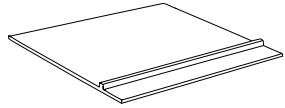

DRAWER OPTIONS - BOTTOM COVER
felt bottom center drawer insert liner

Style Number	List Price
K3	100

Specifications

- Inserts into center drawer and features divider for open pen and pencil storage. Removable for easy cleaning.
- Adds a luxurious touch to center drawers.
- Color: Dark Brown Coal

PEDESTAL MODIFICATIONS
black laminate printer pullout bottom shelf

Style Number	List Price
PPOS	225

Specifications

- Black Laminate pullout shelf on suspension
- Black grommet
- Adjustable Shelf

POWER / DATA
power supply cordset

Style Number	List Price
PD717	100

Specifications

- SIZE: 10.75"L x 2.0"W x 1.06"H
- (5) Outlets w/ 10' cord
- Surge suppression (720 Joules)
- 15 Amp breaker
- Available on: Vertical Panels, Cabinet Interiors, and under tops

PRODUCT MODIFICATIONS
modify width - open/closed storage

Style Number	List Price
MOD-2	250

Specifications

- Modify width down on any unit with open or closed storage section: overheads, wall hung units, storage credenzas, towers

Conferencing options.

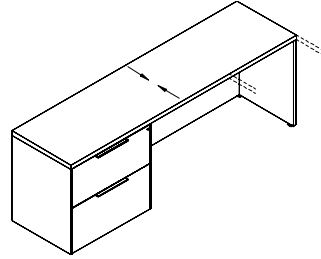

PRODUCT MODIFICATIONS

modify width - outside of mod-1, mod-2

Style Number	List Price
MOD-3	Contact for pricing

Specifications

- Width modification outside of MOD-1 & MOD-2

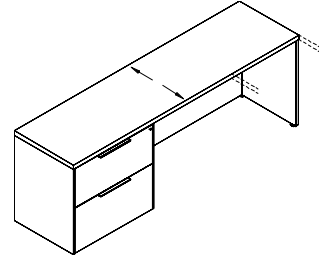

PRODUCT MODIFICATIONS

modify depth - decrease depth

Style Number	List Price
MOD-5	125

Specifications

- Modify depth down (minimum depth for a unit with drawers is 21"D)

Notes
- Ex. 24" to 21", 30" to 24", and 36" to 30"

PRODUCT MODIFICATIONS

modify depth - increase depth

Style Number	List Price
MOD-6	Add 10%

Specifications

- Increase depth by no more than 6"

Notes
- Ex. 24" to 30", 30" to 36", and 36" to 42"
- Add 10% to the unit you want to increase the depth of by no more than 6"

PRODUCT MODIFICATIONS

modify height

Style Number	List Price
MOD-7	Contact for pricing

Specifications

- Modify height of a unit

Conferencing options.

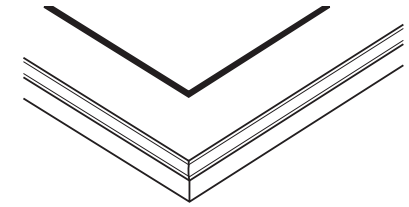
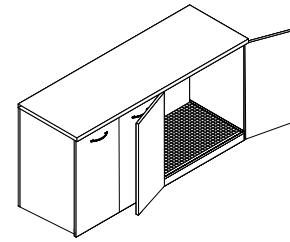

PRODUCT MODIFICATIONS
modify conference table length and width - 1 piece top

Style Number	List Price
MOD-8	125

Specifications

- Modify length/width on a 1 piece table top

PRODUCT MODIFICATIONS
modify conference table length and width - 2/3 piece top

Style Number	List Price
MOD-9	250

Specifications

- Modify length/width on a 2 or 3 piece table top

REFRIGERATOR MODIFICATION
refrigerator cabinet modification

Style Number	List Price
REF01	205

Specifications

- Open back cutout for venting
- Moisture sponge mat
- Contaminate ledge
- Contact customer service for maximum refrigerator size (Changes based on unit).

Notes
 - Available on: 36" and 42" Storage Credenzas

SPECIALTY VENEER ACCENTS
black ebony wood inlay in one piece conference top

Style Number	List Price
One Piece Conference Top T30	765
Two Piece Conference Top T31	1540

Specifications

- Standard veneer top is routed for Ebony wood inlay 1/8" x 3/16" width line. Inlay wood is miter jointed in the corners, hand fitted, glued and sanded flush with top veneer. Inlay forms a 3" border to top edge

Notes
 - Hand fitted miter corner Black Ebony wood inlay installed in standard wood veneer tops

Conferencing options.

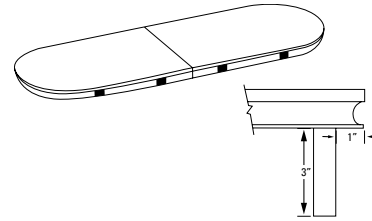
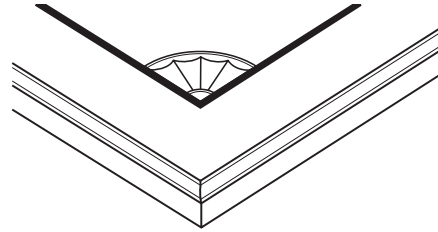
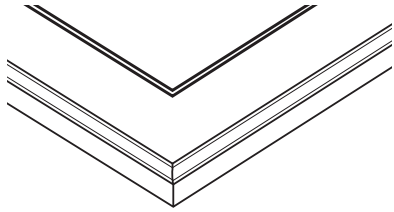

SPECIALTY VENEER ACCENTS *black/white/black wood inlay*

Style Number	List Price
One Piece Top T30BWB	990
Two Piece Top T31BWB	1870

Specifications

- Standard veneer top is routed for wood inlay 1/8" x 3/16" width line. Each color is 1/16" wide. White inlay line is finished over providing a subtle contrast to line detail

- Notes
- Available on: Conferencing Tops
 - Hand fitted miter corner ebony-maple-ebony wood inlay installed in standard veneer top
 - The center white line can be masked off preventing color stains from penetrating. Final top coats are applied over the white line.

SPECIALTY VENEER ACCENTS *black ebony wood inlay w/ wood fan detail - 1 piece conference table top*

Style Number	List Price
One Piece Top T51	1210
Two Piece Top T52	2195

Specifications

- Standard veneer top is routed for wood inlay 1/8" x 3/16" width line. With each 90 degree corner routed for Quarter circle fan inlays. Inlay fans combined with solid black inlay preserves an old traditional appearance. Fans are handcrafted from teakwood, rosewood, mahogany, and other exotic woods. Each piece of veneer is shaded by burning and is hand fitted to a perfect fan shape - truly and old world craft

- Conference tables: 4 fans, one in each corner per top section

- Notes
- Available on: Conferencing Tops
 - Hand fitted miter corner wood inlay and fan installed in standard veneer top
 - Only available on square/ rectangle tops

TOP MODIFICATION *top apron rail*

Style Number	List Price
TAR	Add 10% to top price for apron only to top

Specifications

- 3 x 3/4 thick apron rail is set back under top 1".

- Apron rail is recommended for fixed port installation for power/data support.

- Notes
- Available on: Conferencing Tops only
 - Select power/data support separately.
 - See power options for available apron power

TOP MODIFICATION *top apron rail*

Style Number	List Price
TAR-M	Add 15% (Apron rail with beltline detail)

Specifications

- Traditional with apron rail and molding - available in Cherry and Walnut.

- Notes
- Available on: Conference tops only
 - Select power/data support separately.
 - See power options for available apron power

Conferencing options.

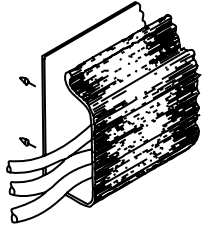

WIRE MANAGEMENT
horizontal j-channel wire management raceway

Style Number	List Price
W1	80 Per 4' section

Specifications

- 4' section for field installation.
- The "J" shape black thermoplastic wire raceway may be added to specified worksurface tops to provide concealed channeling of wires to and from worksurface grommets. For use in open kneespace areas, raceway is attachable to top of back panel with pan head screws. Interior dimensions are 1" x 1- 1/2" providing ample storage for multiple wires and excess cable. Front of raceway flexes out for easy cord insertion.

Notes

- Units w/ Wire Channel Standard.
- Field Installation

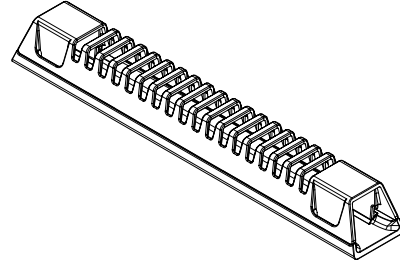

WIRE MANAGEMENT
horizontal wire management raceway

Style Number	List Price
W21	35

Specifications

- 10"W x 1.5"D x 1.25"H
- Grey Wire Manager (10.5")
- Power and data cables can be discretely housed and managed with the W21 Gray Wire Manager. This can be mounted in any location to metal frame or underside of conference tables and runs cables through a 1" channel from power module to hollow steel legs. This keeps cables organized under the table top. Release clips make it simple to snap on and off the Wire Manager for easy organization and access after attached to the table

Notes

- Field installed



WIRE MANAGEMENT
horizontal u-channel wire management raceway

Style Number	List Price
W2A	80 Per 4' section

Specifications

- 4' section for field installation.

Notes

- Units w/ Wire Channel Standard.
- Field Installation



WIRE MANAGEMENT
coil wire manager

Style Number	List Price
W18	160

Specifications

- Weighted Base, Table attachment plate
- 39- 1/2" Length
- Black

Notes

- Location

Conferencing options.

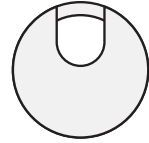
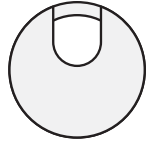

WIRE MANAGEMENT

standard location grommets - factory installed

Style Number	List Price
Standard Location Grommet	
Black	
TM30	50
Silver	
TM31	50
Antique Brass	
TM33	50
White	
TM34	50

Specifications

- 1 -5/8" Metal Grommet

Notes

- *Units w/ Grommets Standard Are Noted Under Standard Features. Grommets Match Pull Finish - Standard (Unless Specified Otherwise)

WIRE MANAGEMENT

non-standard location grommets - factory installed

Style Number	List Price
Non-Standard Location Grommet	
Black	
TM30 -NS	95
Silver	
TM31 -NS	95
Antique Brass	
TM33 -NS	95
White	
TM34 -NS	95

Specifications

- 1 -5/8" Metal Grommet

Notes

- *Units w/ Grommets Standard Are Noted Under Standard Features. Grommets Match Pull Finish - Standard (Unless Specified Otherwise)

WIRE MANAGEMENT

black plastic vertical surface grommets - factory installed

Style Number	List Price
Standard Location Grommet	
TM50-C	50
Non-Standard Location Grommet	
TM50-NS	95

Specifications

- 2 " Black Plastic Grommet

Notes

- Standard Location is Bottom Center

power & data options.

Aircharge wireless charging grommet

Style Number	List Price
 ACWG WIRELESS GROMMET	\$195

Specifications

- › When used with GROVE Tables an additional \$350 LIST will apply for the special cutout required.
- › AirCharge offers a convenient way to charge any Qi compatible smartphone or device without the need to carry charging cables or find an available power outlet.
- › The Aircharge is powered by the latest Qi compliant IC offering reliable and efficient wireless charging in a convenient 3" grommet hub. Simply place your phone on the Aircharge and an LED will confirm pairing and begin wireless charging.
- › Recess: Efficient space conservation and quick access
- › Input: DC 5V (with included AC power adapter), DC 9V, 1.67A (with optional QC 2.0 power adapter)
- › Output: 5 watts Max. with DC 5V, 2A power adapter, 10 watts Max. with QC 2.0 power adapter
- › Qi V1.2 compliant IC
- › Charging distance: 6mm Max.

Available: All DARRAN collections



power & data options.

Cove power unit - non-linking

Style Number

List Price



PD-COVE PLUG

\$550

Non-linking version

Specifications

- › Size 5.75" L x 2.5" W
- › (2) 15 Amp Receptacles and (2) USB charging ports
- › Surface Mount
- › 108" Cord
- › Standard Silver Finish, Available in White or Black Finish upon request
- › ETL Listed

Available: All DARRAN collections



power & data options.

Cove power unit with daisylink

Style Number	List Price
--------------	------------

STARTER UNITS



COV-DCH HARDWIRED	\$710
-------------------	-------

Includes (1) Cove unit with Hardwire Infeed - 120"



COV-DCP PLUG	\$800
--------------	-------

Includes (1) Cove unit with Plug infeed -
Includes 72" Cord and 32" Infeed Jumper for
104" total cord infeed

ADDITIONAL LINKING UNITS

COV-DCL	\$575 EACH
---------	------------

Includes Linking Cove unit and Jumper up to
96", cable length determined by the top size

Specifications

- › Size: 5.75"L x 2.5"W
- › (2) 15 Amp Receptacles and (2) 2.1 Amp USB charging ports
- › Surface Mount
- › Max Daisy Chain - Hardwire - (9) units; Plug/Corded - (4) units
- › Standard Silver Finish, Available in White or Black Finish upon request
- › ETL Listed

Available: All DARRAN collections



power & data options.

Cove corded series

Style Number

List Price



PD-COVE-PKO

\$800

Specifications

- › Size 9.5" L x 2.5" W x 3.18" D
- › When used with GROVE Tables an additional \$350 LIST will apply for the special cutout required.
- › (2) Power Receptacles, (2) 2.1 Amp USB charging ports and (1) Telecom Plate Knockout
- › Surface Mount
- › 108" Cord
- › Standard Silver Finish, Available in White or Black Finish upon request
- › ETL Listed

Available: All DARRAN collections

Telecom Plates

RJ45 (1)	\$35
RJ45 (2)	\$70
RJ45 (3)	\$105
USB (1)	\$70
USB (2)	\$140
RJ11/RJ45	\$70
RJ45/USB	\$105
RJ45/HDMI	\$190
HDMI/DVI	\$325
HDMI/USB	\$205
HDMI/VGA	\$240
VGA/MINI-STEREO	\$155
VGA/USB	\$175

This pod can have up to 1 total plates.

*All telecom connectors sold separately.



power & data options.

Dual

Style Number	List Price
STARTER UNITS	
PD-DUAL3P3J	\$1170
3 modules; 3' jumpers	
PD-DUAL3P6J	\$1185
3 modules; 6' jumpers	
PD-DUAL3P12J	\$1200
3 modules; 12' jumpers	
PD-DUAL4P3J	\$1450
4 modules; 3' jumpers	
PD-DUAL4P6J	\$1470
4 modules; 6' jumpers	
PD-DUAL4P12J	\$1490
4 modules; 12' jumpers	
PD-DUAL8P3J	\$2825
8 modules; 3' jumpers	
PD-DUAL8P6J	\$2865
8 modules; 6' jumpers	
PD-DUAL8P12J	\$2905
8 modules; 12' jumpers	

Specifications

- > Size: 3" x 1.75" x 1.25"
- > (2) 2.4 Amp USB charging ports per module
- > Undersurface mount
- > 72" cord
- > Standard black finish, available in white upon request
- > UL certified

Available: Conference, Milner, ThinkingQuietly

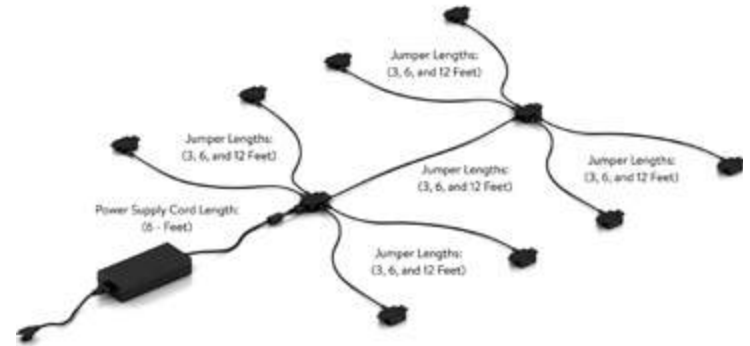

power & data options.

FPDB flush power/data bay

Style Number	List Price
	
Hardwired	
FPDB-H72 72" Cord	\$1250
FPDB-H108 108" Cord	\$1300
FPDB-H144 144" Cord	\$1350
FPDB-H180 180" Cord	\$1400
	
Power/Plug	
FPDB-C72 72" Cord	\$1250
FPDB-C108 108" Cord	\$1300
FPDB-C144 144" Cord	\$1350
FPDB-C180 180" Cord	\$1400

Specifications

- > Size 14.19"L x 6.39"W x 3.38"H
- > (4) 15 Amp receptacles
- > Available in white, silver or black
- > (3) telecom plate cutouts standard
- > (1) Dual USB ports
- > Corded units are UL Listed and CSA Certified. Hardwired Units are CSA Certified
- > Select 72", 108", 144", or 180" power cord or hardwire whip cord

Available: All DARRAN collections, excludes rail and grove

Telecom Plates	
RJ45 (1)	\$35
RJ45 (2)	\$70
RJ45 (3)	\$105
USB (1)	\$70
USB (2)	\$140
RJ11/RJ45	\$70
RJ45/USB	\$105
RJ45/HDMI	\$190
HDMI/DVI	\$325
HDMI/USB	\$205
HDMI/VGA	\$240
VGA/MINI-STEREO	\$155
VGA/USB	\$175

This pod can have up to 3 total plates.
*All telecom connectors sold separately.



Standard underside Convenience plug. Can be used for Daisy Chaining up to (4) total units. Specify hardwired or plug for the first unit in series, daisy chained units will have a plug for connection through convenience plug.

power & data options.

Reef power unit with daisylink

Style Number	List Price
 REF310 PLUG	\$1100

Specifications

- > Size 16.1"L x 6.25"W x 4.89"D
- > When used with GROVE Tables an additional \$350 LIST will apply for the special cutout required.
- > (3) 120V Receptacles, (2) USB charging ports, 1 Data Plate Knockout, (2) Knockouts for RJ45 Data Ports
- > Surface Mount
- > 108" Cord
- > Features Convenience Plug on bottom of unit that allows for max (3) Daisy Chain
- > Standard Black Finish, Available in White or Silver Finish upon request
- > Additional Telecom Plate Knockout
- > RJ45 for Knockouts not required. If not ordered a small hole will be present in the pod in this this location
- > ETL Listed

Available: Conferencing

Telecom Plates

RJ45 (1)	\$35
RJ45 (2)	\$70
RJ45 (3)	\$105
USB (1)	\$70
USB (2)	\$140
RJ11/RJ45	\$70
RJ45/USB	\$105
RJ45/HDMI	\$190
HDMI/DVI	\$325
HDMI/USB	\$205
HDMI/VGA	\$240
VGA/MINI-STEREO	\$155
VGA/USB	\$175

This pod can have up to 1 total plates.
*All telecom connectors sold separately.

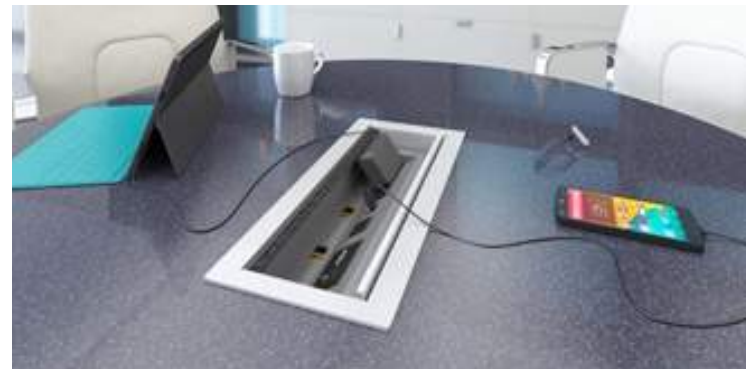

power & data options.

Powered seamless grommet w/ seclusion daisylink

Style Number	List Price
	
Power/Plug	
PSG82-C: PLUG	\$1825

Specifications

- › Grommet comes with 2 Power Pods that are mounted under the Seamless Grommet. Pods daisylink together with (2) innerconnecting cables.
- › Size: 11.5" L x 8.25W"
- › (4) Power Receptacles per power pod, 8 total
- › 124" Power cord
- › Standard Black Finish
- › UL Listed
- › (2) 2.1 Dual USB ports per pod, 4 total
- › (2) Data ports per pod, 4 total

Available: ThinkingQuietly, Diva, EdgeWorks

Telecom Plates	
RJ45 (1)	\$35
RJ45 (2)	\$70
RJ45/HDMI	\$190
HDMI/VGA	\$240
RJ45/VGA	\$190

This pod can have up to 1 total plates.
*All telecom connectors sold separately.



power & data options.

Soba wire manager

Style Number	List Price
STARTER UNITS	
SCDW	\$200
White wire manager	
SCDB	\$200
Black wire manager	

Specifications

- › Dimensions: 9ft x 9in x 3.15in
- › Zips up, bundles and routes loose, messy cables into a single tube
- › Routes and guides cables behind desks, TVs, and anywhere cables tend to get messy
- › Accommodates large or small cables, up to three cables at once
- › Support channels, used to route cables, include powerful adhesive backing which allows easy attachment to surfaces.

Available: All DARRAN collections



TABLE SHAPE

ROUND



- 36 DIA.
- 42 DIA.
- 48 DIA.
- 54 DIA.
- 60 DIA.

SQUARE



- 42 x 42
- 48 x 48
- 54 x 54
- 60 x 60

RECTANGLE



- 72 x 36
- 84 x 42
- 96 x 48
- 120 x 48
- 144 x 48
- 168 x 54
- 192 x 54
- 216 x 54
- 216 x 60
- 240 x 54
- 240 x 60

ARCH RECTANGLE



BOAT SHAPE



- 72 x 36/30
- 84 x 42/32
- 96 x 48/36
- 120 x 48/39
- 144 x 48/39
- 168 x 54/42
- 192 x 54/42
- 216 x 54/39
- 216 x 60/45
- 240 x 54/42
- 240 x 60/48

	T9B1616CS974	T9B2020CS974	T9B2424CS974	T9B1616HS975	T9B2020HS975	T9B2424HS975	T9B1616CC982	T9B2020CC982	T9B2424CC982	T9B1616CH977	T9B2020CH977	T9B2424CH977	T9B1616TR977	T9B2020TR977	T9B2424TR977	T9B1616TC982	T9B2020TC982	T9B2424TC982	T9B1616TH977	T9B2020TH977	T9B2424TH977	T9B3131P9855	
W	16"	20"	24"	16"	20"	24"	16"	20"	24"	16"	20"	24"	16"	20"	24"	16"	20"	24"	16"	20"	24"	27"	
H	28.75"	28.75"	28.75"	28.75"	28.75"	28.75"	28.75"	28.75"	28.75"	28.75"	28.75"	28.75"	28.75"	28.75"	28.75"	28.75"	28.75"	28.75"	28.75"	28.75"	28.75"	29.5"	
ROUND																							1
42 DIA.																							1
48 DIA.																							1
54 DIA.																							
60 DIA.																							
SQUARE																							
42 x 42	1						1									1			1				
48 x 48		1						1									1			1			
54 x 54			1						1									1			1		
60 x 60			1						1									1			1		
RECTANGLE																							
72 x 36				2						2			2						2				2
84 x 42					2						2		2							2			2
96 x 48		2			2			2			2		2				2			2			2
120 x 48		2			*3			2			*3		*3				2			*3			3
144 x 48		2			*3			2			*3		*3				2			*3			3
168 x 54			3			3			3			3		3				3			3		3
192 x 54			3			3			3			3		3				3			3		3
216 x 54			3			4			3			4		4				3			3		4
216 x 60			3			4			3			4		4				3			3		4
240 x 54			4			4			4			4		4				4			4		4
240 x 60			4			4			4			4		4				4			4		4
BOAT SHAPE																							
72 x 36/30	2			2			2			2			2			2			2				2
84 x 42/32	2			2			2			2			2			2			2				2
96 x 48/36		2			2			2			2		2				2			2			2
120 x 48/39		2			2+			2			2+		2+				2			2+			3
144 x 48/39		2+			2+			2+			2+		2+				2+			2+			3
168 x 54/42		2+			2+			2+			2+		2+				2+			2+			2
192 x 54/42		2+			2+			2+			2+		2+				2+			2+			2
216 x 54/39		2+			2+			2+			2+		2+				2+			2+			2
216 x 60/45		2+			2+			2+			2+		2+				2+			2+			2
240 x 54/42		2+			2+			2+			2+		2+				2+			2+			2
240 x 60/48		2+			2+			2+			2+		2+				2+			2+			2

*Bases can be deleted when trough is specified.

TABLE SHAPE



SQUARE



RECTANGLE



ARCH RECTANGLE



BOAT SHAPE



	TBB1616WD969	TBB2020WD969	TBB2424WD969	TBB1616TD969	TBB2020TD969	TBB2424TD969	TBB1608HD968	TBB2010HD968	TBB2412HD968	NSS0301MB985	NSS3030MB984	TBB0303MB982	TBB0303MB976	TBB3232MB971	TBB3636MB971	TBB2403MB954	TBB3003MB954	TBB3603MB954	NSS3003MB988	NSS3603MB988	TBB0102MB979	TBB3002MB956	TBB2602MB956	TBB3602MB956	TBB4202MB956	TBB4203MB956
W	16 DIA.	20 DIA.	24 DIA.	16 DIA.	20 DIA.	24 DIA.	16"	20"	24"	3.75"	30"	3 DIA.	3"	32"	36"	24	30"	36"	30"	36"	2"	30"	26"	36"	42"	42"
H	28.75"	28.75"	28.75"	28.75"	28.75"	28.75"	8"	10"	12"	28.5"	28.5"	27.75"	27.75"	27.75"	27.75"	3"	3"	3"	3"	3"	28.75"	27.75"	27.75"	27.75"	27.75"	27.75"
36 DIA.	1			1						4	1	4	4	1							4					
42 DIA.		1			1					4	1	4	4	1							4					
48 DIA.		1			1					4	1	4	4		1						4					
54 DIA.			1			1				4	1	4	4								4					
60 DIA.			1			1				4	1	4	4								4					
42 x 42										4	1	4	4								4					
48 x 48										4	1	4	4								4					
54 x 54										4	1	4	4								4					
60 x 60										4	1	4	4								4					
72 x 36	2			2			2			4		4	4			2			2		4	2	2			
84 x 42		2			2			2		4	2	4	4	2		2				2	4				2	
96 x 48		2			2			2			2	6	6		2	2				2	6					2
120 x 48		2			2			*2+ 1(2010CH)			3	6	6		2	3				3	6					3
144 x 48		2			2			*2+ 1(2010CH)			4	6	6		3	3				3	6					3
168 x 54			3			3			2+ 1(2410CH)								3									3
192 x 54			3			3			2+ 1(2410CH)								4									4
216 x 54			3			3											4									4
216 x 60			3			3												4								4
240 x 54			4			4												6								6
240 x 60			4			4												6								6
72 x 36/30	2			2			2												2			2	2			
84 x 42/32	2			2			2					4	4	2					2		4		2			
96 x 48/36		2			2			2				6	6	2						2	6			2		
120 x 48/39	2+ 1(2020WD)	2		2+ 1(2020TD)	2		2+ 1(2010CH)	2				6	6		2					3	6					3
144 x 48/39	2+ 1(2020WD)			2+ 1(2020TD)			2+ 1(2010CH)					6	6		3					3	6					3
168 x 54/42	2+ 1(2424WD)			2+ 1(2424TD)			2+ 1(2410CH)													3	6					3
192 x 54/42	2+ 1(2424WD)			2+ 1(2424TD)			2+ 1(2410CH)													3	6					4
216 x 54/39	2+ 1(2424WD)			2+ 1(2424TD)			2+ 1(2410CH)													3	6					4
216 x 60/45	2+ 1(2424WD)			2+ 1(2424TD)			2+ 1(2410CH)													3	6					4
240 x 54/42	2+ 2(2424WD)			2+ 2(2424TD)			2+ 2(2410CH)													3	6					6
240 x 60/48	2+ 2(2424WD)			2+ 2(2424TD)			2+ 2(2410CH)													3	6					6

*Bases can be deleted when trough is specified.

TABLE SHAPE

ROUND

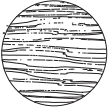

36 DIA.
42 DIA.
48 DIA.
54 DIA.
60 DIA.

SQUARE



42 x 42
48 x 48
54 x 54
60 x 60

RECTANGLE



72 x 36
84 x 42
96 x 48
120 x 48
144 x 48
168 x 54
192 x 54
216 x 54
216 x 60
240 x 54
240 x 60

ARCH RECTANGLE



BOAT SHAPE



72 x 36/30
84 x 42/32
96 x 48/36
120 x 48/39
144 x 48/39
168 x 54/42
192 x 54/42
216 x 54/39
216 x 60/45
240 x 54/42
240 x 60/48

	TBB1812TB963 18" 28.75"	TBB2412TB963 24" 28.75"	TBB1818PYX966 18" 28.75"	TBB2424PYX966 24" 28.75"	TBB3030PYX966 30" 28.75"	TBB5424PB972 84" 28.75"	TBB6024PB972 96" 28.75"	TBB8424PB972 120" 28.75"	TBB10824PB972 144" 28.75"	TBB13224PB972 168" 28.75"	TBB15624PB972 192" 28.75"	TBB18024PB972 216" 28.75"	TBB20424PB972 240" 28.75"	TBB5424TB972 84" 28.75"	TBB6024TB972 96" 28.75"	TBB8424TB972 120" 28.75"	TBB10824TB972 144" 28.75"	TBB13224TB972 168" 28.75"	TBB15624TB972 192" 28.75"	TBB18024TB972 216" 28.75"	TBB20424TB972 240" 28.75"	
ROUND				1																		
42 DIA.				1																		
48 DIA.				1																		
54 DIA.					1																	
60 DIA.																						
SQUARE				1																		
42 x 42				1																		
48 x 48				1																		
54 x 54					1																	
60 x 60																						
RECTANGLE	2		2																			
72 x 36	2		2			1								1								
84 x 42		2		2			1								1							
96 x 48		2		2			1								1							
120 x 48		2+		3				1							1							
144 x 48		2+		3				1							1							
168 x 54					3				1							1						
192 x 54					3				1								1				1	
216 x 54					3							1							1			
216 x 60										1									1			
240 x 54												1										1
240 x 60													1									1
BOAT SHAPE	2																					
72 x 36/30	2																					
84 x 42/32	2					1								1								
96 x 48/36		2		2			1								1							
120 x 48/39		2+		2				1							1							
144 x 48/39		2+		3				1							1							
168 x 54/42					2+				1							1						
192 x 54/42					2+				1								1				1	
216 x 54/39					2+							1									1	
216 x 60/45										1											1	
240 x 54/42												1									1	
240 x 60/48					2+								1									1

RFB2512MB986
RFB4221MB986

TABLE SHAPE

BOAT



72 x 36	2	
84 x 42	2	
96 x 48	2	
120 x 48	3	
144 x 48	3	
168 x 54		3
192 x 54		3
216 x 54		4
216 x 60		4
240 x 54		4
240 x 60		4

RECTANGLE

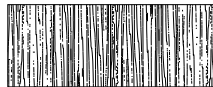

72 x 36	2	
84 x 42	2	
96 x 48	2	
120 x 48	3	
144 x 48	3	
168 x 54		3
192 x 54		3
216 x 54		4
216 x 60		4
240 x 54		4
240 x 60		4

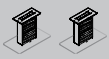

Diva price list



effective july 1, 2021

designed by thinkingworks design studio

Diva table of contents

Statement of Line	
Features & Advantages	1
Finishes.....	2
Specifications.....	3
Edges.....	5
Grommet Grommet Reference	6
Round Conference Tables.....	7
Square Conference Tables	9
42" Depth Conference Tables	11
48" Depth Conference Tables	15
54" Depth Conference Tables	19
Credenzas.....	23
Options.....	25
Power & Data	29

Diva statement of line



PAGE 7
Conference Tables

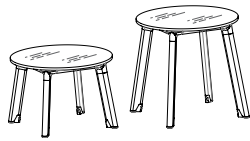

PAGE 8
Glass Conference Tables



PAGE 9
Conference Tables



PAGE 10
Glass Conference Tables

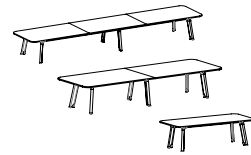

PAGE 11
Conference Tables

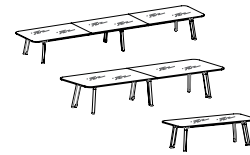

PAGE 12
Glass Conference Tables



PAGE 13
Conference Tables



PAGE 14
Glass Conference Tables

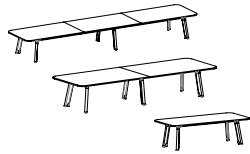

PAGE 15
Conference Tables



PAGE 16
Glass Conference Tables

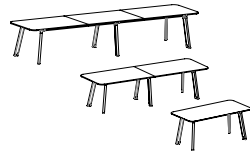

PAGE 17
Conference Tables



PAGE 18
Glass Conference Tables

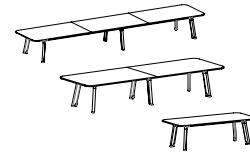

PAGE 19
Conference Tables



PAGE 20
Glass Conference Tables

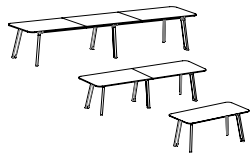

PAGE 21
Conference Tables



PAGE 22
Glass Conference Tables

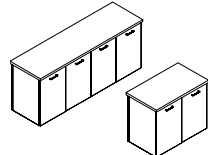

PAGE 23
Full Pedestal Credenzas

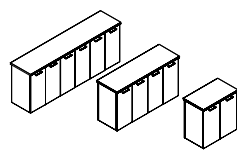

PAGE 24
Full Pedestal Credenzas

Diva features & advantages

Veneer and HPL tops

Veneer tops and high-pressure laminate tops feature a 45-pound density substrate with balanced 3-ply construction. Tops are 1" thick. DARRAN only uses HPVA A Grade Flat Cut Cherry, Maple, and Walnut Veneers and A Grade Quartered Oak and Ash Veneers. Cherry and Walnut veneers are book-matched. Oak, Maple, and Ash Veneers are slip-matched. Veneer tops feature a 3mm external solid hardwood band, HPL tops features a 2mm flat PVC band or a 1mm laminate self-edge. Some collections feature double cut reconstituted walnut and oak veneers.

TFL tops

Thermally Fused Laminate tops feature a 45-pound density substrate with balanced 3-ply construction. Tops are 1" thick. Laminate tops feature a 2mm flat PVC band.

Wire management

Power and data are concealed without notice under the beautiful quartered Ash surface of the table. A system of W21 cable clips and connectors run cords safely and cleanly around corners. Cable management is accessed by integrated undercarriage panels that easily slide from open to close. Solid wood legs feature a cavity that runs power to the floor. Specify W21 under surface wire channels for organization and management of all communication wires and cords. Sold separately to conceal wire under worksurfaces.

Seamless grommets

The Seamless Grommet includes 8 power and 2 data plate.

PSG82: Power Seamless Grommet - \$1,875

The Seamless Grommet is configured to include Seclusion Power Pods mounted under the hinged Seamless Grommet. Each Seclusion has 4-power and one customizable data plate.

Diva finishes | specifications

STANDARD VENEER	PREMIUM VENEER	HIGH PRESSURE LAMINATE	THERMALLY FUSED LAMINATE
WLA Lofty Ash.....	N/A	N/A	N/A
WEC Ebony.....	N/A	GEC Ebony.....	MEC Ebony
WAM Alabaster Maple.....	N/A	GAM Alabaster Maple.....	N/A
WWP Designer White Paint.....	N/A	GWL Designer White	MWL Designer White

*WLA Lofty Ash features matte 5% sheen. All other finishes are 40% sheen.

Send 3x3 or larger finish chip for color match. Custom finish upcharge is 3% or \$250 Net (). When specifying a standard Cherry, Oak, or Walnut finish on Quartered Ash Veneer a 3% or \$250 Net finish upcharge is applied.

Undercarriage finish

Undercarriage is Ash veneer ply, formed and finished in Lofty Ash only. Cable management is accessed by integrated undercarriage panels that easily slide from open to close.

Diva specifications

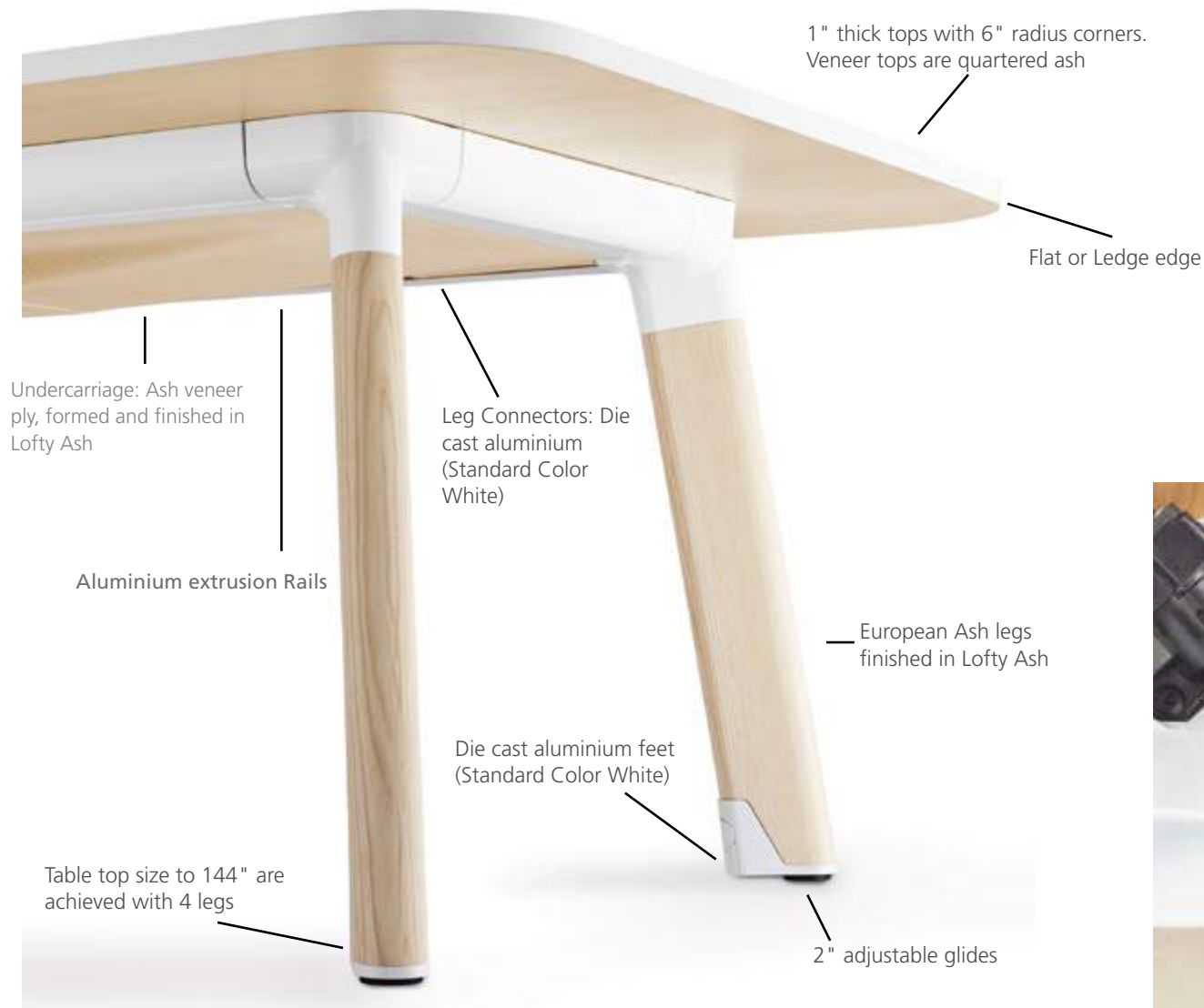

Undercarriage: Ash veneer ply, formed and finished in Lofty Ash

Leg Connectors: Die cast aluminium (Standard Color White)

Aluminium extrusion Rails

European Ash legs finished in Lofty Ash

Die cast aluminium feet (Standard Color White)

Table top size to 144" are achieved with 4 legs

2" adjustable glides

Diva is available in seated height and standing height (for certain size tables).



Power/data in hollow legs

Diva offers hollow solid Ash wood legs for clean wire management. Power & data wires gain access to the table through the die-cast feet on Diva's legs.

Diva specifications



Diva undercarriage is always finished in WLA Lofty Ash finish

Undercarriage

Undercarriage conceals wires and powerpods. W21 wire management clips can be specified to assist in managing cables under the table. The undercarriage consists of a sliding panel system to conceal wires below the table and provide a "complete finish" to the table.

Diva has an undercarriage which is designed to provide a "complete finish" to the table. The undercarriage conceals all wiring to the powerbox and can be removed by an un-trained worker to gain access to under-table wiring.

Rails

The rails were designed using Finite Element Analysis, assessing minimal material input for greater strength and durability. Diva can comfortably be produced as a 144" table with only 4 legs.

Leg to rail connectors

The die cast Leg and Rail connectors feature a patented design for joining rails together. The patented clamping system eliminates exposed screws and enhances the level of finish on the Diva table system.

Diva edges

Standard profile

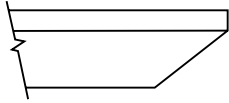

"W" "P" 3mm Hardwood Band
HPL Self Laminate Band

Ledge-1
"W" "G"

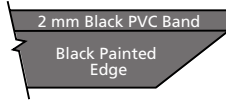

2 mm Black PVC Band
Black Painted Edge

Ledge-2
"W" "G"

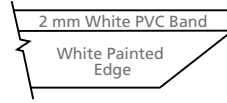

2 mm White PVC Band
White Painted Edge

Ledge-3
"W" "G"

*Ledge-1 not available in GWL finish

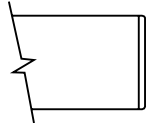

"W" "P" 3mm Hardwood Band
"G" HPL Self Laminate Band

Flat-1
"W" "G"

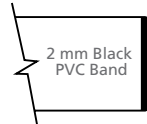

2 mm Black PVC Band

Flat-2
"W" "G"

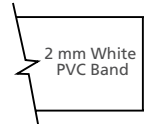

2 mm White PVC Band

Flat-3
"W" "G"

*Flat-1 not available in GWL finish

Diva grommets | grommet reference

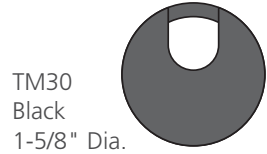

TM30
Black
1-5/8" Dia.

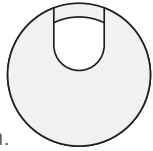

TM31
Silver
1-5/8" Dia.

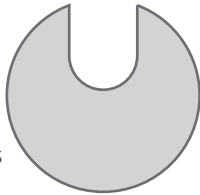

TM33
Antique Brass
2-1/2" Dia.

Optional Grommets

Factory Installed

Grommets (Standard Location)

Specify Color and Left/Right/Center - \$50 ea.

- Black: TM30-R (Right), TM30-L (Left), TM30-C (Center)

- Silver: TM31-R (Right), TM31-L (Left), TM31-C (Center)

- Antique Brass: TM33-R (Right), TM33-L (Left), TM33-C (Center)

Grommets (Non-Standard Location)

Provide drawing w/ Grommet Location and Specify Color - \$95 ea.

- Black: TM30-NS

- Silver: TM31-NS

- Antique Brass: TM33-NS

TM50
Black
1-5/8" Dia.



Grommets (vertical surface)

Standard Location - \$50 ea.

- Black Plastic Vertical Surface: TM50-C (Bottom Center)

Non-Standard Location - \$95 ea.

- Black Plastic Vertical Surface: TM50-NS

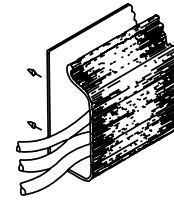

W1

Horizontal J-Channel

Horizontal J-Channel wire management (Sku: W-1) is sold separately to conceal wire under worksurfaces.

Standard grommet location reference











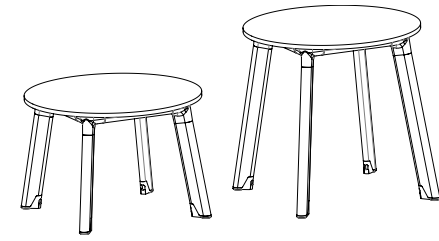





Credenza

Specify Right or Left Grommet

Diva.

Conference Tables Round



1 Select a model w" x d" x h"	weight	Standard Veneer Top Lofty Ash Base		Premium Veneer Top Lofty Ash Base		High Pressure Laminate Top Lofty Ash Base		Thermally Fused Laminate Top Lofty Ash Base	
Sitting Height 48 DIA x 29 42 DIA x 29	125 115	DIV4848RD121W DIV4242RD121W	4747 4716	"P" Option N/A "P" Option N/A		DIV4848RD121G DIV4242RD121G	4473 4450	DIV4848RD121M DIV4242RD121M	4045 4004
Standing Height 48 DIA x 42 42 DIA x 42	145 135	DIV4848RD141W DIV4242RD141W	5312 5283	"P" Option N/A "P" Option N/A		DIV4848RD141G DIV4242RD141G	5246 5017	DIV4848RD141M DIV4242RD141M	4610 4571
2 Select a finish <i>View finish details</i>		Top finishes WLA WEC WAM WWP	Leg finishes WEC +5% WLA			Top finishes GEC GAM GWL	Leg finishes WEC +5% WLA	Top finishes MEC MWL	Leg finishes WEC +5% WLA
3 Select a edge <i>View edge details</i>		 Flat-1  Flat-2 Black  Flat-3 White  Ledge-1 Finished  Ledge-2 Black  Ledge-3 White				 Flat-1  Flat-2 Black  Flat-3 White  Ledge-1 Finished  Ledge-2 Black  Ledge-3 White	 Flat-2 (Black)  Flat-3 (White)		
4 Select hardware <i>View hardware details</i>		Hardware N/A				Hardware N/A		Hardware N/A	

View statement of line

Product features.

- 1" Thick top
- ENVI-CT finish on wood tops
- Heels and Leg Connectors: Die cast aluminium white metal finish (standard)
- Legs: Solid European Lofty Ash finish with hollow center for cable management
- Rails: Aluminium extrusion, white metal finish
- 2" Adjustable glide

Options.

PREMIUM METAL FINISHES

- Specify MFB: Black for Leg and Rail Finish Color: \$395

POWER

- Two pods mounted under the hinged seamless grommet. Each pod has 4 power and 2 data ports. Telecom connectors sold separately.
- PSG82-C: Plug with 124" cord (8 power, 2 telecom plates) - \$1875 each

PREMIUM SOLID WOOD LEG FINISH

- WEC: Ebony Finish - 5% upcharge

Diva.

Glass Conference Tables Round



[View statement of line](#)

1 Select a model w" x d" x h"	weight	White Glass Top Lofty Ash Base		
Sitting Height				
48 DIA x 29	165	DIV4848RD121SW	6760	
42 DIA x 29	145	DIV4242RD121SW	6259	
Standing Height				
48 DIA x 42	185	DIV4848RD141SW	7326	
42 DIA x 42	165	DIV4242RD141SW	6826	

2 Select a finish View finish details	Leg finishes
Metal finish MFW White. Additional metal finishes are available, see options.	WEC +5% WLA

3 Select a edge View edge details	Flat Polished

4 View hardware details	Hardware N/A

Product features.

- 1/4" Thick White back painted glass top w/ 1" white subtop (optional black back painted glass available w/ 1" black subtop - n/c)
- 2" Adjustable glide
- Glass top is Ice White back painted (standard) or Black Opaque (optional)
- Heels and Leg Connectors: Die cast aluminium white metal finish (standard)
- Legs: Solid European Lofty Ash finish with hollow center for cable management
- Rails: Aluminium extrusion, white metal finish

Options.

GLASS FINISH COLOR

- BG1: Black opaque glass - n/c

PREMIUM METAL FINISHES

- Specify MFB: Black for Leg and Rail Finish Color: \$395

PREMIUM SOLID WOOD LEG FINISH

- WEC: Ebony Finish - 5% upcharge

Diva.

Conference Tables Square

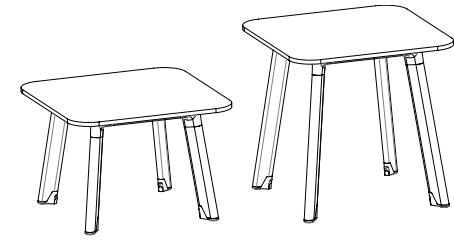

1 Select a model w" x d" x h"	weight	Standard Veneer Top Lofty Ash Base		Premium Veneer Top Lofty Ash Base		High Pressure Laminate Top Lofty Ash Base		Thermally Fused Laminate Top Lofty Ash Base	
		Sitting Height 48 x 48 x 29 42 x 42 x 29 Standing Height 48 x 48 x 42 42 x 42 x 42		DIV4848SQ121W DIV4242SQ121W	4747 4716	"P" Option N/A "P" Option N/A	DIV4848SQ121G DIV4242SQ121G	4473 4450	DIV4848SQ121M DIV4242SQ121M
		DIV4848SQ141W DIV4242SQ141W	5312 5283	"P" Option N/A "P" Option N/A	DIV4848SQ141G DIV4242SQ141G	5246 5017	DIV4848SQ141M DIV4242SQ141M	4610 4571	
2 Select a finish <i>View finish details</i>		Top finishes WLA WEC WAM WWP Metal finish MFW White. Additional metal finishes are available, see options.	Leg finishes WEC +5% WLA		Top finishes GEC GAM GWL Leg finishes WEC +5% WLA		Top finishes MEC MWL Leg finishes WEC +5% WLA		
3 Select a edge <i>View edge details</i>									
4 Select hardware <i>View hardware details</i>		Hardware N/A			Hardware N/A		Hardware N/A		

View statement of line

Product features.

- 1" Thick top
- ENVI-CT finish on wood tops
- Heels and Leg Connectors: Die cast aluminium white metal finish (standard)
- Legs: Solid European Lofty Ash finish with hollow center for cable management
- Rails: Aluminium extrusion, white metal finish
- 2" Adjustable glide
- 6" Radius corners

Options.

EDGE

- SC1: Modify radius corner to square corner - n/c

PREMIUM METAL FINISHES

- Specify MFB: Black for Leg and Rail Finish Color: \$395

POWER

- Two pods mounted under the hinged seamless grommet. Each pod has 4 power and 2 data ports. Telecom connectors sold separately.
- PSG82-C: Plug with 124" cord (8 power, 2 telecom plates) - \$1875 each

PREMIUM SOLID WOOD LEG FINISH

- WEC: Ebony Finish - 5% upcharge

Diva.

Glass Conference Tables Square



[View statement of line](#)

1 Select a model w" x d" x h"	weight	White Glass Top Lofty Ash Base		
Sitting Height				
48 x 48 x 29	175	DIV4848SQ121SW	6760	
42 x 42 x 29	155	DIV4242SQ121SW	6259	
Standing Height				
48 x 48 x 42	195	DIV4848SQ141SW	7326	
42 x 42 x 42	175	DIV4242SQ141SW	6826	

2 Select a finish View finish details	Leg finishes
Metal finish MFW White. Additional metal finishes are available, see options.	WEC +5% WLA

3 Select a edge View edge details	Flat Polished

4 View hardware details	Hardware N/A

Product features.

- 1/4" Thick White back painted glass top w/ 1" white subtop (optional black back painted glass available w/ 1" black subtop - n/c)
- Heels and Leg Connectors: Die cast aluminium white metal finish (standard)
- Legs: Solid European Lofty Ash finish with hollow center for cable management
- Rails: Aluminium extrusion, white metal finish
- 2" Adjustable glide
- 6" Radius corners

Options.

EDGE

- SC1: Modify radius corner to square corner - n/c

PREMIUM METAL FINISHES

- Specify MFB: Black for Leg and Rail Finish Color: \$395

PREMIUM SOLID WOOD LEG FINISH

- WEC: Ebony Finish - 5% upcharge

Diva.

Conference Tables
42" Depth - Rectangle - Sitting Height

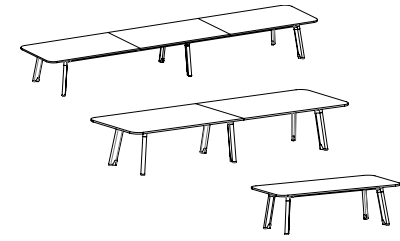

[View statement of line](#)

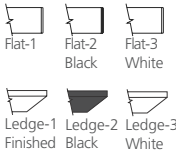
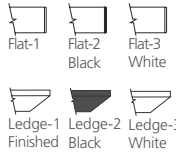
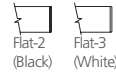
1 Select a model w" x d" x h"	weight	Standard Veneer Top Lofty Ash Base		Premium Veneer Top Lofty Ash Base		High Pressure Laminate Top Lofty Ash Base		Thermally Fused Laminate Top Lofty Ash Base	
		3 Piece Top (6 legs)							
240 x 42 x 29	410	DIV24042RE123W	13357	"P" Option N/A		DIV24042RE123G	12301	DIV24042RE123M	10509
216 x 42 x 29	380	DIV21642RE123W	12419	"P" Option N/A		DIV21642RE123G	11437	DIV21642RE123M	9850
198 x 42 x 29	350	DIV19842RE123W	10973	"P" Option N/A		DIV19842RE123G	10226	DIV19842RE123M	8930
2 Piece Top (6 legs, tops 144" or smaller have 4 legs)									
240 x 42 x 29	410	DIV24042RE122W	13055	"P" Option N/A		DIV24042RE122G	12013	"M" Option N/A	
216 x 42 x 29	380	DIV21642RE122W	12140	"P" Option N/A		DIV21642RE122G	11173	DIV21642RE122M	9575
198 x 42 x 29	350	DIV19842RE122W	10889	"P" Option N/A		DIV19842RE122G	10161	DIV19842RE122M	8810
168 x 42 x 29	315	DIV16842RE122W	10291	"P" Option N/A		DIV16842RE122G	9616	DIV16842RE122M	8404
144 x 42 x 29	280	DIV14442RE122W	8159	"P" Option N/A		DIV14442RE122G	7538	DIV14442RE122M	6467
120 x 42 x 29	245	DIV12042RE122W	7412	"P" Option N/A		DIV12042RE122G	6844	DIV12042RE122M	6025
1 Piece Top (4 legs)									
120 x 42 x 29	245	DIV12042RE121W	7329	"P" Option N/A		DIV12042RE121G	6775	"M" Option N/A	
96 x 42 x 29	210	DIV9642RE121W	5869	"P" Option N/A		DIV9642RE121G	5501	DIV9642RE121M	4860
84 x 42 x 29	185	DIV8442RE121W	5731	"P" Option N/A		DIV8442RE121G	5390	DIV8442RE121M	4801
72 x 42 x 29	165	DIV7242RE121W	5229	"P" Option N/A		DIV7242RE121G	4909	DIV7242RE121M	4369
2 Select a finish View finish details		Top finishes	Leg finishes			Top finishes	Leg finishes	Top finishes	Leg finishes
Metal finish MFW White. Additional metal finishes are available, see options.		WLA WEC WAM WWP	WEC +5% WLA			GEC GAM GWL	WEC +5% WLA	MEC MWL	WEC +5% WLA
3 Select a edge View edge details									
4 Select hardware View hardware details		Hardware N/A		Hardware N/A		Hardware N/A		Hardware N/A	

Product features.

- 1" Thick top
- ENVI-CT finish on wood tops
- Heels and Leg Connectors: Die cast aluminium white metal finish (standard)
- Legs: Solid European Lofty Ash finish with hollow center for cable management
- Rails: Aluminium extrusion, white metal finish
- 2" Adjustable glide
- Under carriage: Lofty Ash Veneer Sliding Panels
- 6" Radius corners

Options.

EDGE

- SC1: Modify radius corner to square corner - n/c

PREMIUM METAL FINISHES

- Specify MFB: Black: \$395 (1pc top), \$595 (2pc top), \$790 (3pc top)

POWER

- Two pods mounted under the hinged seamless grommet. Each pod has 4 power and 2 data ports. Telecom connectors sold separately.
- PSG82-C: Plug with 124" cord (8 power, 2 telecom plates) - \$1875 each

PREMIUM SOLID WOOD LEG FINISH

- WEC: Ebony Finish - 5% upcharge

Diva.

Glass Conference Tables
42" Depth - Rectangle - Sitting Height

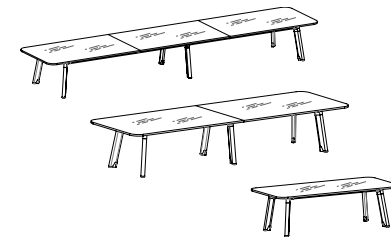

[View statement of line](#)

1 Select a model w" x d" x h"	weight	White Glass Top Lofty Ash Base		
3 Piece Top (6 legs)				
240 x 42 x 29	640	DIV24042RE123SW	22166	
216 x 42 x 29	585	DIV21642RE123SW	20347	
198 x 42 x 29	540	DIV19842RE123SW	18242	
2 Piece Top (6 legs, tops 144" or smaller have 4 legs)				
240 x 42 x 29	640	DIV24042RE122SW	21864	
216 x 42 x 29	585	DIV216842RE122SW	20068	
198 x 42 x 29	540	DIV19842RE122SW	18156	
168 x 42 x 29	475	DIV16842RE122SW	16457	
144 x 42 x 29	415	DIV14442RE122SW	13444	
120 x 42 x 29	360	DIV12042RE122SW	11816	
1 Piece Top (4 legs)				
120 x 42 x 29	360	DIV12042RE121SW	11733	
96 x 42 x 29	300	DIV9642RE121SW	9392	
84 x 42 x 29	275	DIV8442RE121SW	8815	
72 x 42 x 29	250	DIV7242RE121SW	7872	

2 Select a finish	Leg finishes
View finish details	WEC +5%
	WLA
Metal finish MFW White. Additional metal finishes are available, see options.	

3 Select a edge	
View edge details	
	Flat
	Polished

4	Hardware
View hardware details	N/A

Product features.

- 1/4" Thick White back painted glass top w/ 1" white subtop (optional black back painted glass available w/ 1" black subtop - n/c)
- Heels and Leg Connectors: Die cast aluminium white metal finish (standard)
- Legs: Solid European Lofty Ash finish with hollow center for cable management
- Rails: Aluminium extrusion, white metal finish
- 2" Adjustable glide
- Under carriage: Lofty Ash Veneer Sliding Panels
- 6" Radius corners

Options.

EDGE

- SC1: Modify radius corner to square corner - n/c

PREMIUM METAL FINISHES

- Specify MFB: Black: \$395 (1pc top), \$595 (2pc top), \$790 (3pc top)

PREMIUM SOLID WOOD LEG FINISH







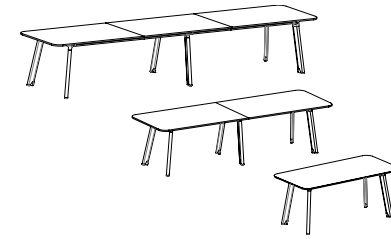







- WEC: Ebony Finish - 5% upcharge

Diva.

Conference Tables
42" Depth - Rectangle - Standing Height



[View statement of line](#)

1 Select a model w" x d" x h"	weight	Standard Veneer Top Lofty Ash Base		Premium Veneer Top Lofty Ash Base		High Pressure Laminate Top Lofty Ash Base		Thermally Fused Laminate Top Lofty Ash Base		
		3 Piece Top (6 legs)								
240 x 42 x 42	450	DIV24042RE143W	13551	"P" Option N/A		DIV24042RE143G	12496	DIV24042RE143M	10704	
216 x 42 x 42	420	DIV21642RE143W	12613	"P" Option N/A		DIV21642RE143G	11631	DIV21642RE143M	10044	
198 x 42 x 42	390	DIV19842RE143W	11139	"P" Option N/A		DIV19842RE143G	10421	DIV19842RE143M	9125	
2 Piece Top (6 legs, tops 144" or smaller have 4 legs)										
240 x 42 x 42	440	DIV24042RE142W	13272	"P" Option N/A		DIV24042RE142G	12230	"M" Option N/A		
216 x 42 x 42	410	DIV21642RE142W	12334	"P" Option N/A		DIV21642RE142G	11367	DIV21642RE142M	9770	
198 x 42 x 42	390	DIV19842RE142W	11083	"P" Option N/A		DIV19842RE142G	10355	DIV19842RE142M	9004	
168 x 42 x 42	345	DIV16842RE142W	10445	"P" Option N/A		DIV16842RE142G	9770	DIV16842RE142M	8558	
144 x 42 x 42	310	DIV14442RE142W	9177	"P" Option N/A		DIV14442RE142G	8556	DIV14442RE142M	7485	
120 x 42 x 42	275	DIV12042RE142W	7984	"P" Option N/A		DIV12042RE142G	7416	DIV12042RE142M	6551	
1 Piece Top (4 legs)										
120 x 42 x 42	265	DIV12042RE141W	7901	"P" Option N/A		DIV12042RE141G	7347	"M" Option N/A		
96 x 42 x 42	230	DIV9642RE141W	6436	"P" Option N/A		DIV9642RE141G	6066	DIV9642RE141M	5426	
84 x 42 x 42	205	DIV8442RE141W	6298	"P" Option N/A		DIV8442RE141G	5957	DIV8442RE141M	5366	
72 x 42 x 42	185	DIV7242RE141W	5801	"P" Option N/A		DIV7242RE141G	5481	DIV7242RE141M	4941	
2 Select a finish View finish details		Top finishes	Leg finishes			Top finishes	Leg finishes	Top finishes	Leg finishes	
	Metal finish MFW White. Additional metal finishes are available, see options.	WLA WEC WAM WWP	WEC +5% WLA			GEC GAM GWL	WEC +5% WLA	MEC MWL	WEC +5% WLA	
3 Select a edge View edge details		 Flat-1	 Flat-2 Black	 Flat-3 White		 Flat-1	 Flat-2 Black	 Flat-3 White	 Flat-2 (Black)	 Flat-3 (White)
		 Ledge-1 Finished	 Ledge-2 Black	 Ledge-3 White		 Ledge-1 Finished	 Ledge-2 Black	 Ledge-3 White		
4 Select hardware View hardware details		Hardware N/A				Hardware N/A		Hardware N/A		

Product features.

- 1" Thick top
- ENVI-CT finish on wood tops
- Heels and Leg Connectors: Die cast aluminium white metal finish (standard)
- Legs: Solid European Lofty Ash finish with hollow center for cable management
- Rails: Aluminium extrusion, white metal finish
- 2" Adjustable glide
- Under carriage: Lofty Ash Veneer Sliding Panels
- 6" Radius corners

Options.

EDGE

- SC1: Modify radius corner to square corner - n/c

PREMIUM METAL FINISHES

- Specify MFB: Black: \$395 (1pc top), \$595 (2pc top), \$790 (3pc top)

POWER

- Two pods mounted under the hinged seamless grommet. Each pod has 4 power and 2 data ports. Telecom connectors sold separately.
- PSG82-C: Plug with 124" cord (8 power, 2 telecom plates) - \$1875 each

PREMIUM SOLID WOOD LEG FINISH

- WEC: Ebony Finish - 5% upcharge

Diva.

Glass Conference Tables
42" Depth - Rectangle - Standing Height

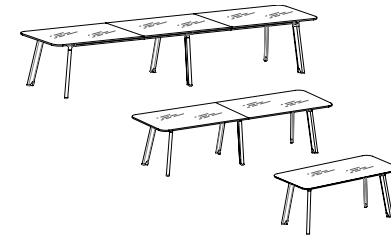

[View statement of line](#)

1 Select a model w" x d" x h"	weight	White Glass Top Lofty Ash Base		
3 Piece Top (6 legs)				
240 x 42 x 42	680	DIV24042RE143SW	22360	
216 x 42 x 42	625	DIV21642RE143SW	20541	
198 x 42 x 42	580	DIV19842RE143SW	18407	
2 Piece Top (6 legs, tops 144" or smaller have 4 legs)				
240 x 42 x 42	670	DIV24042RE142SW	22081	
216 x 42 x 42	615	DIV21642RE142SW	20262	
198 x 42 x 42	580	DIV19842RE142SW	18351	
168 x 42 x 42	505	DIV16842RE142SW	16611	
144 x 42 x 42	445	DIV14442RE142SW	14462	
120 x 42 x 42	390	DIV12042RE142SW	12388	
1 Piece Top (4 legs)				
120 x 42 x 42	380	DIV12042RE141SW	12305	
96 x 42 x 42	320	DIV9642RE141SW	9959	
84 x 42 x 42	295	DIV8442RE141SW	9381	
72 x 42 x 42	265	DIV7242RE141SW	8444	

2 Select a finish	Leg finishes
View finish details	WEC +5%
	WLA
Metal finish MFW White. Additional metal finishes are available, see options.	

3 Select an edge	Flat Polished
View edge details	<input type="checkbox"/>
	<input type="checkbox"/>

4	Hardware N/A
View hardware details	

Product features.

- 1/4" Thick White back painted glass top w/ 1" white subtop (optional black back painted glass available w/ 1" black subtop - n/c)
- Heels and Leg Connectors: Die cast aluminium white metal finish (standard)
- Legs: Solid European Lofty Ash finish with hollow center for cable management
- Rails: Aluminium extrusion, white metal finish
- 2" Adjustable glide
- Under carriage: Lofty Ash Veneer Sliding Panels
- 6" Radius corners

Options.

EDGE

- SC1: Modify radius corner to square corner - n/c

PREMIUM METAL FINISHES

- Specify MFB: Black: \$395 (1pc top), \$595 (2pc top), \$790 (3pc top)

PREMIUM SOLID WOOD LEG FINISH







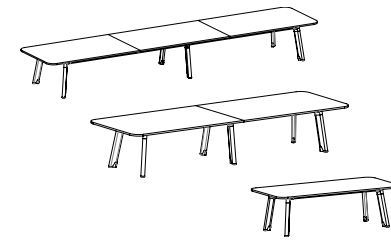







- WEC: Ebony Finish - 5% upcharge

Diva.

Conference Tables
48" Depth - Rectangle - Sitting Height



[View statement of line](#)

1 Select a model w" x d" x h"	weight	Standard Veneer Top Lofty Ash Base		Premium Veneer Top Lofty Ash Base		High Pressure Laminate Top Lofty Ash Base		Thermally Fused Laminate Top Lofty Ash Base	
		3 Piece Top (6 legs)							
240 x 48 x 29	450	DIV24048RE123W	13934	"P" Option N/A		DIV24048RE123G	12728	DIV24048RE123M	10680
216 x 48 x 29	415	DIV21648RE123W	12963	"P" Option N/A		DIV21648RE123G	11840	DIV21648RE123M	10028
198 x 48 x 29	380	DIV19848RE123W	11534	"P" Option N/A		DIV19848RE123G	10680	DIV19848RE123M	9198
2 Piece Top (6 legs, tops 144" or smaller have 4 legs)									
240 x 48 x 29	450	DIV24048RE122W	13838	"P" Option N/A		DIV24048RE122G	12647	"M" Option N/A	
216 x 48 x 29	415	DIV21648RE122W	12867	"P" Option N/A		DIV21648RE122G	11760	DIV21648RE122M	9936
198 x 48 x 29	380	DIV19848RE122W	11438	"P" Option N/A		DIV19848RE122G	10605	DIV19848RE122M	9060
168 x 48 x 29	345	DIV16848RE122W	10798	"P" Option N/A		DIV16848RE122G	10028	DIV16848RE122M	8643
144 x 48 x 29	300	DIV14448RE122W	8627	"P" Option N/A		DIV14448RE122G	7916	DIV14448RE122M	6692
120 x 48 x 29	265	DIV12048RE122W	7838	"P" Option N/A		DIV12048RE122G	7191	DIV12048RE122M	6200
1 Piece Top (4 legs)									
120 x 48 x 29	265	DIV12048RE121W	7743	"P" Option N/A		DIV12048RE121G	7110	"M" Option N/A	
96 x 48 x 29	230	DIV9648RE121W	6146	"P" Option N/A		DIV9648RE121G	5726	DIV9648RE121M	4994
84 x 48 x 29	200	DIV8448RE121W	5990	"P" Option N/A		DIV8448RE121G	5600	DIV8448RE121M	4925
72 x 48 x 29	180	DIV7248RE121W	5468	"P" Option N/A		DIV7248RE121G	5102	DIV7248RE121M	4484
2 Select a finish View finish details		Top finishes WLA WEC WAM WWP	Leg finishes WEC +5% WLA			Top finishes GEC GAM GWL	Leg finishes WEC +5% WLA	Top finishes MEC MWL	Leg finishes WEC +5% WLA
3 Select a edge View edge details		 Flat-1  Flat-2 Black  Flat-3 White				 Flat-1  Flat-2 Black  Flat-3 White		 Flat-2 (Black)  Flat-3 (White)	
		 Ledge-1 Finished  Ledge-2 Black  Ledge-3 White				 Ledge-1 Finished  Ledge-2 Black  Ledge-3 White			
4 Select hardware View hardware details		Hardware N/A				Hardware N/A		Hardware N/A	

Product features.

- 1" Thick top
- ENVI-CT finish on wood tops
- Heels and Leg Connectors: Die cast aluminium white metal finish (standard)
- Legs: Solid European Lofty Ash finish with hollow center for cable management
- Rails: Aluminium extrusion, white metal finish
- 2" Adjustable glide
- Under carriage: Lofty Ash Veneer Sliding Panels
- 6" Radius corners

Options.

EDGE

- SC1: Modify radius corner to square corner - n/c

PREMIUM METAL FINISHES

- Specify MFB: Black: \$395 (1pc top), \$595 (2pc top), \$790 (3pc top)

POWER

- Two pods mounted under the hinged seamless grommet. Each pod has 4 power and 2 data ports. Telecom connectors sold separately.
- PSG82-C: Plug with 124" cord (8 power, 2 telecom plates) - \$1875 each

PREMIUM SOLID WOOD LEG FINISH

- WEC: Ebony Finish - 5% upcharge

Diva.

Glass Conference Tables
48" Depth - Rectangle - Sitting Height

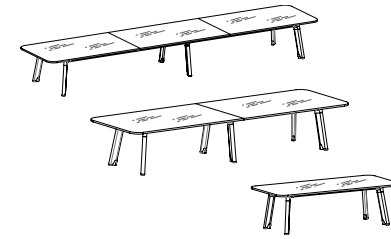

[View statement of line](#)

1 Select a model w" x d" x h"	weight	White Glass Top Lofty Ash Base		
3 Piece Top (6 legs)				
240 x 48 x 29	710	DIV24048RE123SW	24001	
216 x 48 x 29	650	DIV21648RE123SW	22023	
198 x 48 x 29	595	DIV19848RE123SW	19839	
2 Piece Top (6 legs, tops 144" or smaller have 4 legs)				
240 x 48 x 29	710	DIV24048RE122SW	23905	
216 x 48 x 29	650	DIV21648RE122SW	21927	
198 x 48 x 29	595	DIV19848RE122SW	19743	
168 x 48 x 29	530	DIV16848RE122SW	17845	
144 x 48 x 29	455	DIV14448RE122SW	14667	
120 x 48 x 29	395	DIV12048RE122SW	12872	
1 Piece Top (4 legs)				
120 x 48 x 29	395	DIV12048RE121SW	12776	
96 x 48 x 29	335	DIV9648RE121SW	10173	
84 x 48 x 29	305	DIV8448RE121SW	9514	
72 x 48 x 29	275	DIV7248RE121SW	8488	

2 Select a finish View finish details	Leg finishes
Metal finish MFW White. Additional metal finishes are available, see options.	WEC +5% WLA

3 Select a edge View edge details	Flat Polished
	<input type="checkbox"/> Flat <input type="checkbox"/> Polished

4 View hardware details	Hardware N/A

Product features.

- 1/4" Thick White back painted glass top w/ 1" white subtop (optional black back painted glass available w/ 1" black subtop - n/c)
- Heels and Leg Connectors: Die cast aluminium white metal finish (standard)
- Legs: Solid European Lofty Ash finish with hollow center for cable management
- Rails: Aluminium extrusion, white metal finish
- 2" Adjustable glide
- Under carriage: Lofty Ash Veneer Sliding Panels
- 6" Radius corners

Options.

EDGE

- SC1: Modify radius corner to square corner - n/c

PREMIUM METAL FINISHES

- Specify MFB: Black: \$395 (1pc top), \$595 (2pc top), \$790 (3pc top)

PREMIUM SOLID WOOD LEG FINISH







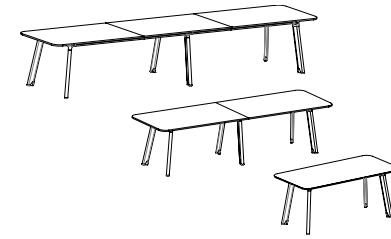







- WEC: Ebony Finish - 5% upcharge

Diva.

Conference Tables
48" Depth - Rectangle - Standing Height



[View statement of line](#)

1 Select a model w" x d" x h"	weight	Standard Veneer Top Lofty Ash Base		Premium Veneer Top Lofty Ash Base		High Pressure Laminate Top Lofty Ash Base		Thermally Fused Laminate Top Lofty Ash Base	
		3 Piece Top (6 legs)							
240 x 48 x 42	490	DIV24048RE143W	14151	"P" Option N/A		DIV24048RE143G	12945	DIV24048RE143M	10897
216 x 48 x 42	455	DIV21648RE143W	13157	"P" Option N/A		DIV21648RE143G	12035	DIV21648RE143M	10222
198 x 48 x 42	420	DIV19848RE143W	11728	"P" Option N/A		DIV19848RE143G	10874	DIV19848RE143M	9392
2 Piece Top (6 legs, tops 144" or smaller have 4 legs)									
240 x 48 x 42	480	DIV24048RE142W	14056	"P" Option N/A		DIV24048RE142G	12865	"M" Option N/A	
216 x 48 x 42	445	DIV21648RE142W	13061	"P" Option N/A		DIV21648RE142G	11955	DIV21648RE142M	10131
198 x 48 x 42	410	DIV19848RE142W	11632	"P" Option N/A		DIV19848RE142G	10799	DIV19848RE142M	9255
168 x 48 x 42	375	DIV16848RE142W	10952	"P" Option N/A		DIV16848RE142G	10182	DIV16848RE142M	8797
144 x 48 x 42	330	DIV14448RE142W	9645	"P" Option N/A		DIV14448RE142G	8935	DIV14448RE142M	7711
120 x 48 x 42	295	DIV12048RE142W	8410	"P" Option N/A		DIV12048RE142G	7763	DIV12048RE142M	6772
1 Piece Top (4 legs)									
120 x 48 x 42	285	DIV12048RE141W	8315	"P" Option N/A		DIV12048RE141G	7682	"M" Option N/A	
96 x 48 x 42	250	DIV9648RE141W	6713	"P" Option N/A		DIV9648RE141G	6292	DIV9648RE141M	5560
84 x 48 x 42	220	DIV8448RE141W	6556	"P" Option N/A		DIV8448RE141G	6166	DIV8448RE141M	5491
72 x 48 x 42	200	DIV7248RE141W	6040	"P" Option N/A		DIV7248RE141G	5674	DIV7248RE141M	5056
2 Select a finish View finish details		Top finishes WLA WEC WAM WWP	Leg finishes WEC +5% WLA			Top finishes GEC GAM GWL	Leg finishes WEC +5% WLA	Top finishes MEC MWL	Leg finishes WEC +5% WLA
3 Select a edge View edge details		 Flat-1  Flat-2 Black  Flat-3 White				 Flat-1  Flat-2 Black  Flat-3 White		 Flat-2 (Black)  Flat-3 (White)	
		 Ledge-1 Finished  Ledge-2 Black  Ledge-3 White				 Ledge-1 Finished  Ledge-2 Black  Ledge-3 White			
4 Select hardware View hardware details		Hardware N/A				Hardware N/A		Hardware N/A	

Product features.

- 1" Thick top
- ENVI-CT finish on wood tops
- Heels and Leg Connectors: Die cast aluminium white metal finish (standard)
- Legs: Solid European Lofty Ash finish with hollow center for cable management
- Rails: Aluminium extrusion, white metal finish
- 2" Adjustable glide
- Under carriage: Lofty Ash Veneer Sliding Panels
- 6" Radius corners

Options.

EDGE

- SC1: Modify radius corner to square corner - n/c

PREMIUM METAL FINISHES

- Specify MFB: Black: \$395 (1pc top), \$595 (2pc top), \$790 (3pc top)

POWER

- Two pods mounted under the hinged seamless grommet. Each pod has 4 power and 2 data ports. Telecom connectors sold separately.
- PSG82-C: Plug with 124" cord (8 power, 2 telecom plates) - \$1875 each

PREMIUM SOLID WOOD LEG FINISH

- WEC: Ebony Finish - 5% upcharge

Diva.

Glass Conference Tables
48" Depth - Rectangle - Standing Height

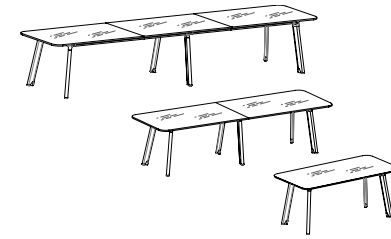

[View statement of line](#)

1 Select a model w" x d" x h"	weight	White Glass Top Lofty Ash Base		
3 Piece Top (6 legs)				
240 x 48 x 42	750	DIV24048RE143SW	24218	
216 x 48 x 42	690	DIV21648RE143SW	22218	
198 x 48 x 42	635	DIV19848RE143SW	20034	
2 Piece Top (6 legs, tops 144" or smaller have 4 legs)				
240 x 48 x 42	740	DIV24048RE142SW	24123	
216 x 48 x 42	680	DIV21648RE142SW	22122	
198 x 48 x 42	625	DIV19848RE142SW	19938	
168 x 48 x 42	560	DIV16848RE142SW	17999	
144 x 48 x 42	485	DIV14448RE142SW	15685	
120 x 48 x 42	425	DIV12048RE142SW	13444	
1 Piece Top (4 legs)				
120 x 48 x 42	415	DIV12048RE141SW	13348	
96 x 48 x 42	355	DIV9648RE141SW	10740	
84 x 48 x 42	325	DIV8448RE141SW	10080	
72 x 48 x 42	295	DIV7248RE141SW	9060	

2 Select a finish View finish details	Leg finishes
Metal finish MFW White. Additional metal finishes are available, see options.	WEC +5% WLA

3 Select a edge View edge details	Flat Polished
	Flat
	Polished

4 View hardware details	Hardware N/A
	N/A

Product features.

- 1/4" Thick White back painted glass top w/ 1" white subtop (optional black back painted glass available w/ 1" black subtop - n/c)
- Heels and Leg Connectors: Die cast aluminium white metal finish (standard)
- Legs: Solid European Lofty Ash finish with hollow center for cable management
- Rails: Aluminium extrusion, white metal finish
- 2" Adjustable glide
- Under carriage: Lofty Ash Veneer Sliding Panels
- 6" Radius corners

Options.

EDGE

- SC1: Modify radius corner to square corner - n/c

PREMIUM METAL FINISHES

- Specify MFB: Black: \$395 (1pc top), \$595 (2pc top), \$790 (3pc top)

PREMIUM SOLID WOOD LEG FINISH







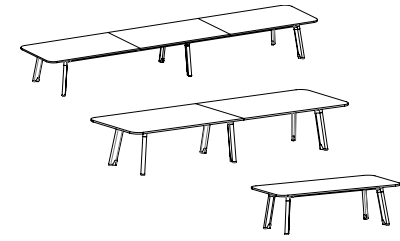







- WEC: Ebony Finish - 5% upcharge

Diva.

Conference Tables
54" Depth - Rectangle - Sitting Height



[View statement of line](#)

1 Select a model w" x d" x h"	weight	Standard Veneer Top Lofty Ash Base		Premium Veneer Top Lofty Ash Base		High Pressure Laminate Top Lofty Ash Base		Thermally Fused Laminate Top Lofty Ash Base	
		3 Piece Top (6 legs)							
240 x 54 x 29	495	DIV24054RE123W	14690	"P" Option N/A		DIV24054RE123G	13339	DIV24054RE123M	10714
216 x 54 x 29	445	DIV21654RE123W	13755	"P" Option N/A		DIV21654RE123G	12481	DIV21654RE123M	9810
198 x 54 x 29	405	DIV19854RE123W	12135	"P" Option N/A		DIV19854RE123G	11165	DIV19854RE123M	9215
2 Piece Top (6 legs, tops 144" or smaller have 4 legs)									
240 x 54 x 29	495	DIV24054RE122W	14594	"P" Option N/A		DIV24054RE122G	13259	"M" Option N/A	
216 x 54 x 29	445	DIV21654RE122W	13659	"P" Option N/A		DIV21654RE122G	12401	DIV21654RE122M	9719
198 x 54 x 29	405	DIV19854RE122W	12038	"P" Option N/A		DIV19854RE122G	11092	DIV19854RE122M	9124
168 x 54 x 29	370	DIV16854RE122W	11387	"P" Option N/A		DIV16854RE122G	10502	DIV16854RE122M	8717
144 x 54 x 29	335	DIV14454RE122W	9137	"P" Option N/A		DIV14454RE122G	8328	DIV14454RE122M	6767
120 x 54 x 29	290	DIV12054RE122W	8301	"P" Option N/A		DIV12054RE122G	7562	DIV12054RE122M	6269
1 Piece Top (4 legs)									
120 x 54 x 29	290	DIV12054RE121W	8205	"P" Option N/A		DIV12054RE121G	7488	"M" Option N/A	
2 Select a finish View finish details		Top finishes WLA WEC WAM WWP	Leg finishes WEC +5% WLA			Top finishes GEC GAM GWL	Leg finishes WEC +5% WLA	Top finishes MEC MWL	Leg finishes WEC +5% WLA
3 Select a edge View edge details		 Flat-1  Flat-2 Black  Flat-3 White				 Flat-1  Flat-2 Black  Flat-3 White		 Flat-2 (Black)  Flat-3 (White)	
		 Ledge-1 Finished  Ledge-2 Black  Ledge-3 White				 Ledge-1 Finished  Ledge-2 Black  Ledge-3 White			
4 Select hardware View hardware details		Hardware N/A				Hardware N/A		Hardware N/A	

Product features.

- 1" Thick top
- ENVI-CT finish on wood tops
- Heels and Leg Connectors: Die cast aluminium white metal finish (standard)
- Legs: Solid European Lofty Ash finish with hollow center for cable management
- Rails: Aluminium extrusion, white metal finish
- 2" Adjustable glide
- Under carriage: Lofty Ash Veneer Sliding Panels
- 6" Radius corners

Options.

EDGE

- SC1: Modify radius corner to square corner - n/c

PREMIUM METAL FINISHES

- Specify MFB: Black: \$395 (1pc top), \$595 (2pc top), \$790 (3pc top)

POWER

- Two pods mounted under the hinged seamless grommet. Each pod has 4 power and 2 data ports. Telecom connectors sold separately.
- PSG82-C: Plug with 124" cord (8 power, 2 telecom plates) - \$1875 each

PREMIUM SOLID WOOD LEG FINISH

- WEC: Ebony Finish - 5% upcharge

Diva.

Glass Conference Tables
54" Depth - Rectangle - Sitting Height

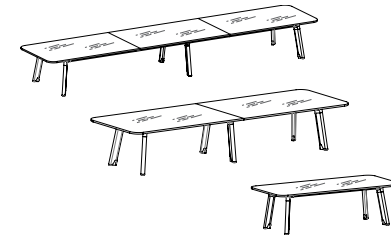

[View statement of line](#)

1 Select a model w" x d" x h"	weight	White Glass Top Lofty Ash Base		
3 Piece Top (6 legs)				
240 x 54 x 29	790	DIV24054RE123SW	26016	
216 x 54 x 29	710	DIV21654RE123SW	23948	
198 x 54 x 29	650	DIV19854RE123SW	21479	
2 Piece Top (6 legs, tops 144" or smaller have 4 legs)				
240 x 54 x 29	790	DIV24054RE122SW	25920	
216 x 54 x 29	710	DIV21654RE122SW	23852	
198 x 54 x 29	650	DIV19854RE122SW	21382	
168 x 54 x 29	575	DIV16854RE122SW	19315	
144 x 54 x 29	510	DIV14454RE122SW	15933	
120 x 54 x 29	435	DIV12054RE122SW	13964	
1 Piece Top (4 legs)				
120 x 54 x 29	435	DIV12054RE121SW	13867	

2 Select a finish View finish details	Leg finishes
Metal finish MFW White. Additional metal finishes are available, see options.	WEC +5% WLA

3 Select a edge View edge details	Flat Polished

4 View hardware details	Hardware N/A

Product features.

- 1/4" Thick White back painted glass top w/ 1" white subtop (optional black back painted glass available w/ 1" black subtop - n/c)
- Heels and Leg Connectors: Die cast aluminium white metal finish (standard)
- Legs: Solid European Lofty Ash finish with hollow center for cable management
- Rails: Aluminium extrusion, white metal finish
- 2" Adjustable glide
- Under carriage: Lofty Ash Veneer Sliding Panels
- 6" Radius corners

Options.

EDGE

- SC1: Modify radius corner to square corner - n/c

PREMIUM METAL FINISHES

- Specify MFB: Black: \$395 (1pc top), \$595 (2pc top), \$790 (3pc top)

PREMIUM SOLID WOOD LEG FINISH







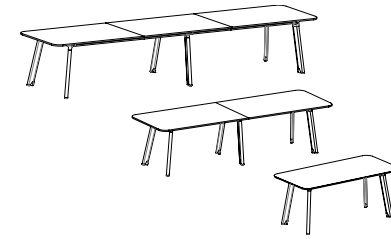







- WEC: Ebony Finish - 5% upcharge

Diva.

Conference Tables
54" Depth - Rectangle - Standing Height



[View statement of line](#)

1 Select a model w" x d" x h"	weight	Standard Veneer Top Lofty Ash Base		Premium Veneer Top Lofty Ash Base		High Pressure Laminate Top Lofty Ash Base		Thermally Fused Laminate Top Lofty Ash Base	
		3 Piece Top (6 legs)							
240 x 54 x 42	535	DIV24054RE143W	14907	"P" Option N/A		DIV24054RE143G	13556	DIV24054RE143M	10931
216 x 54 x 42	485	DIV21654RE143W	13950	"P" Option N/A		DIV21654RE143G	12676	DIV21654RE143M	10005
198 x 54 x 42	445	DIV19854RE143W	12329	"P" Option N/A		DIV19854RE143G	11360	DIV19854RE143M	9410
2 Piece Top (6 legs, tops 144" or smaller have 4 legs)									
240 x 54 x 42	525	DIV24054RE142W	14812	"P" Option N/A		DIV24054RE142G	13476	"M" Option N/A	
216 x 54 x 42	485	DIV21654RE142W	13854	"P" Option N/A		DIV21654RE142G	12595	DIV21654RE142M	9913
198 x 54 x 42	445	DIV19854RE142W	12236	"P" Option N/A		DIV19854RE142G	11286	DIV19854RE142M	9318
168 x 54 x 42	400	DIV16854RE142W	11542	"P" Option N/A		DIV16854RE142G	10657	DIV16854RE142M	8872
144 x 54 x 42	365	DIV14454RE142W	10156	"P" Option N/A		DIV14454RE142G	9346	DIV14454RE142M	7785
120 x 54 x 42	320	DIV12054RE142W	8873	"P" Option N/A		DIV12054RE142G	8134	DIV12054RE142M	6841
1 Piece Top (4 legs)									
120 x 54 x 42	310	DIV12054RE141W	8777	"P" Option N/A		DIV12054RE141G	8060	"M" Option N/A	
2 Select a finish View finish details		Top finishes WLA WEC WAM WWP	Leg finishes WEC +5% WLA			Top finishes GEC GAM GWL	Leg finishes WEC +5% WLA	Top finishes MEC MWL	Leg finishes WEC +5% WLA
3 Select a edge View edge details		 Flat-1  Flat-2 Black  Flat-3 White				 Flat-1  Flat-2 Black  Flat-3 White		 Flat-2 (Black)  Flat-3 (White)	
		 Ledge-1 Finished  Ledge-2 Black  Ledge-3 White				 Ledge-1 Finished  Ledge-2 Black  Ledge-3 White			
4 Select hardware View hardware details		Hardware N/A				Hardware N/A		Hardware N/A	

Product features.

- 1" Thick top
- ENVI-CT finish on wood tops
- Heels and Leg Connectors: Die cast aluminium white metal finish (standard)
- Legs: Solid European Lofty Ash finish with hollow center for cable management
- Rails: Aluminium extrusion, white metal finish
- 2" Adjustable glide
- Under carriage: Lofty Ash Veneer Sliding Panels
- 6" Radius corners

Options.

EDGE

- SC1: Modify radius corner to square corner - n/c

PREMIUM METAL FINISHES

- Specify MFB: Black: \$395 (1pc top), \$595 (2pc top), \$790 (3pc top)

POWER

- Two pods mounted under the hinged seamless grommet. Each pod has 4 power and 2 data ports. Telecom connectors sold separately.
- PSG82-C: Plug with 124" cord (8 power, 2 telecom plates) - \$1875 each

PREMIUM SOLID WOOD LEG FINISH

- WEC: Ebony Finish - 5% upcharge

Diva.

Glass Conference Tables
54" Depth - Rectangle - Standing Height

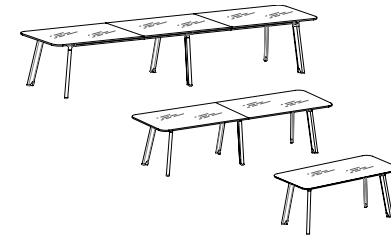

[View statement of line](#)

1 Select a model w" x d" x h"	weight	White Glass Top Lofty Ash Base		
3 Piece Top (6 legs)				
240 x 54 x 42	830	DIV24054RE143SW	26233	
216 x 54 x 42	750	DIV21654RE143SW	24143	
198 x 54 x 42	690	DIV19854RE143SW	21674	
2 Piece Top (6 legs, tops 144" or smaller have 4 legs)				
240 x 54 x 42	820	DIV24054RE142SW	26137	
216 x 54 x 42	750	DIV21654RE142SW	24047	
198 x 54 x 42	690	DIV19854RE142SW	21579	
168 x 54 x 42	605	DIV16854RE142SW	19470	
144 x 54 x 42	540	DIV14454RE142SW	16951	
120 x 54 x 42	465	DIV12054RE142SW	14536	
1 Piece Top (4 legs)				
120 x 54 x 42	455	DIV12054E141SW	14439	

2 Select a finish	Leg finishes
View finish details	WEC +5%
Metal finish MFW White. Additional metal finishes are available, see options.	WLA

3 Select a edge	
View edge details	
	Flat
	Polished

4	Hardware
View hardware details	N/A

Product features.

- 1/4" Thick White back painted glass top w/ 1" white subtop (optional black back painted glass available w/ 1" black subtop - n/c)
- Heels and Leg Connectors: Die cast aluminium white metal finish (standard)
- Legs: Solid European Lofty Ash finish with hollow center for cable management
- Rails: Aluminium extrusion, white metal finish
- 2" Adjustable glide
- Under carriage: Lofty Ash Veneer Sliding Panels
- 6" Radius corners

Options.

EDGE

- SC1: Modify radius corner to square corner - n/c

PREMIUM METAL FINISHES

- Specify MFB: Black: \$395 (1pc top), \$595 (2pc top), \$790 (3pc top)

PREMIUM SOLID WOOD LEG FINISH

- WEC: Ebony Finish - 5% upcharge

Diva.

Full Pedestal Credenzas Storage Credenza

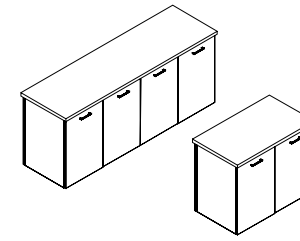

[View statement of line](#)

1 Select a model w" x d" x h"	weight	Standard Veneer Top Standard Veneer Chassis		Premium Veneer Top Premium Veneer Chassis		High Pressure Laminate Top Standard Veneer Chassis		Thermally Fused Laminate Top Thermally Fused Laminate Chassis	
		70 x 24 x 29	225	DIV7024CA125W	3526	"P" Option N/A	DIV7024CA125G	3358	DIV7024CA125M
58 x 24 x 29	195	DIV5824CA125W	3166	"P" Option N/A	DIV5824CA125G	3015	DIV5824CA125M	1940	
35 x 24 x 29	130	DIV3524CA125W	1962	"P" Option N/A	DIV3524CA125G	1868	DIV3524CA125M	1247	
29 x 24 x 29	115	DIV2924CA125W	1826	"P" Option N/A	DIV2924CA125G	1739	DIV2924CA125M	1162	

2 Select a finish View finish details	3 Select an edge View edge details	4 Select hardware View hardware details
WLA WEC WAM WWP		
GEC GAM GWL		
MEC MWL		

Product features.

- "M" styles shelves match finish
- "W"/"G" styles have black adjustable shelf behind door set

NOTES

- All units are standard w/ flush ends
- Unit not designed for open plan use, standard with unfinished back. Select OPB Option for Open Plan application.

Options.

DOOR

- D2: Wood Door Lock - \$100 per door set
- D6A: "W"/"G" Styles - Delete Doors and replace black laminate shelf with finished shelf - n/c
- D95C: Soft Close Door Hinges - \$20 per door
- WPD3061: Designer White - \$80 per door

GROMMETS (STANDARD LOCATION)

Specify Color and Left/Right/Center - \$50 ea.

- Black: TM30-R (Right), TM30-L (Left), TM30-C (Center)
- White: TM34-R (Right), TM34-L (Left), TM34-C (Center)

GROMMETS (NON-STANDARD LOCATION)

Provide drawing w/ Grommet Location and Specify Color - \$95 ea.

- Black: TM30-NS
- White: TM34-NS

GROMMETS (VERTICAL SURFACE)

Standard Location - \$50 ea.

- Black Plastic Vertical Surface: TM50-C (Bottom Center)

Non-Standard Location - \$95 ea.

- Black Plastic Vertical Surface: TM50-NS

OPEN PLAN – FINISHED BACK

- OPB: "W" "G" Style - Modify Unit for Open Plan Application - \$195
- OPB: "M" Style - Modify Unit for Open Plan Application - \$95

SHELF

- S25: Replace Black Laminate Shelf with Finished Shelf - \$80 per shelf ("W"/"G" styles only)

Diva.

Full Pedestal Credenzas Conferencing Storage Credenza

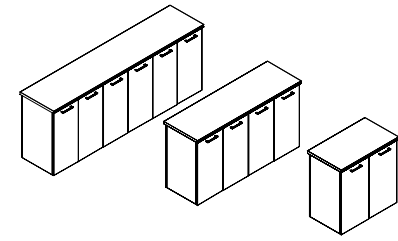

[View statement of line](#)

1 Select a model w" x d" x h"	weight	Standard Veneer Top Standard Veneer Chassis		Premium Veneer Top Premium Veneer Chassis		High Pressure Laminate Top Standard Veneer Chassis		Thermally Fused Laminate Top Thermally Fused Laminate Chassis	
		Triple Storage 93 x 24 x 36 87 x 24 x 36	390 340	DIV9324CA124W DIV8724CA124W	6395 6260	"P" Option N/A "P" Option N/A		DIV9324CA124G DIV8724CA124G	6090 5961
Double Storage 70 x 24 x 36 64 x 24 x 36 58 x 24 x 36 47 x 24 x 36	290 260 245 200	DIV7024CA124W DIV6424CA124W DIV5824CA124W DIV4724CA124W	4458 4309 4160 4316	"P" Option N/A "P" Option N/A "P" Option N/A "P" Option N/A		DIV7024CA124G DIV6424CA124G DIV5824CA124G DIV4724CA124G	4245 4104 3961 3674	DIV7024CA124M DIV6424CA124M DIV5824CA124M DIV4724CA124M	2798 2746 2695 2592
Single Storage 35 x 24 x 36 29 x 24 x 36	150 135	DIV3524CA124W DIV2924CA124W	2507 2359	"P" Option N/A "P" Option N/A		DIV3524CA124G DIV2924CA124G	2389 2246	DIV3524CA124M DIV2924CA124M	1522 1476
2 Select a finish View finish details		WLA WEC WAM WWP				GEC GAM GWL		MEC MWL	
3 Select a edge View edge details		 Flat-1 Flat-2 Flat-3 Black White Ledge-1 Ledge-2 Ledge-3 Finished Black White				 Flat-1 Flat-2 Flat-3 Black White Ledge-1 Ledge-2 Ledge-3 Finished Black White		 Flat-2 Flat-3 (Black) (White)	
4 Select hardware View hardware details		 PL-115 Matte Black PL-116 Matte Nickel PL-210 Anodized Aluminum PL-260 Anodized Aluminum PL-261 White				 PL-115 Matte Black PL-116 Matte Nickel PL-210 Anodized Aluminum PL-260 Anodized Aluminum PL-261 White		 PL-115 Matte Black PL-116 Matte Nickel PL-210 Anodized Aluminum PL-260 Anodized Aluminum PL-261 White	

Product features.

- Adjustable glides
- "M" styles shelves match finish
- "W"/"G" styles have black adjustable shelf behind door set

NOTES

- All units are std with flush ends

Options.

ACCESSORIES

- REF-01: Modify Storage section for refrigerator - \$205

AUDIO VISUAL

- AVR1: AV Exhaust Fan - \$470
- AVR2: AV Pullout Rack - \$1655

BACK PANEL WALL ACCESS

- M19: 2 Heat vent/cord access slots in back - \$ 160

DOOR

- D2: Wood Door Lock - \$100 per door set
- D6A: "W"/"G" Styles - Delete Doors and replace black laminate shelf with finished shelf - n/c

GROMMETS (STANDARD LOCATION)

Specify Color and Left/Right/Center - \$50 ea.

- Black: TM30-R (Right), TM30-L (Left), TM30-C (Center)
- White: TM34-R (Right), TM34-L (Left), TM34-C (Center)

GROMMETS (NON-STANDARD LOCATION)

Provide drawing w/ Grommet Location and Specify Color - \$95 ea.

- Black: TM30-NS
- White: TM34-NS

GROMMETS (VERTICAL SURFACE)

Standard Location - \$50 ea.

- Black Plastic Vertical Surface: TM50-C (Bottom Center)
- Non-Standard Location - \$95 ea.
- Black Plastic Vertical Surface: TM50-NS

OPEN PLAN – FINISHED BACK

- OPB: "W" "G" Style - Modify Unit for Open Plan Application - \$195
- OPB: "M" Style - Modify Unit for Open Plan Application - \$95

SHELF

- S25: Replace Black Laminate Shelf with Finished Shelf - \$80 per shelf ("W"/"G" styles only)

TRASH CAN

- TRC50: EZ Cargo 50 dual trash can - (1) 8 gallon and (1) 5 gallon - \$680

Diva options.

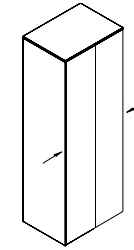
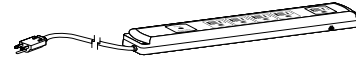
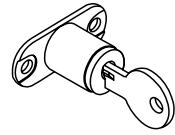
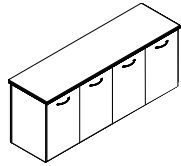

DOOR MODIFICATIONS

delete doors/replace black laminate shelf w/ finished shelf

Style Number	List Price
D6A	N/C

DOOR MODIFICATIONS

panel door lock

Style Number	List Price
D2	100 Per door set

POWER / DATA

power supply cordset

Style Number	List Price
PD717	100

PRODUCT MODIFICATIONS

modify width - open/closed storage

Style Number	List Price
MOD-2	250

Specifications

- Delete doors and replace black laminate shelf with finished shelf

Notes

- Available on: All Storage "W"/"G" Style Credenzas.

Specifications

- Door Locks - 1 Door w/ Lock, Other Door w/ Catch Latch
- Contact Customer Service regarding limited lock locations and keying.

Notes

- Available on: Panel Doors, Wood Frame Doors, and Silverluma doors

Specifications

- SIZE: 10.75"L x 2.0"W x 1.06"H
- (5) Outlets w/ 10' cord
- Surge suppression (720 Joules)
- 15 Amp breaker
- Available on: Vertical Panels, Cabinet Interiors, and under tops

Specifications

- Modify width down on any unit with open or closed storage section: storage credenzas

Diva options.

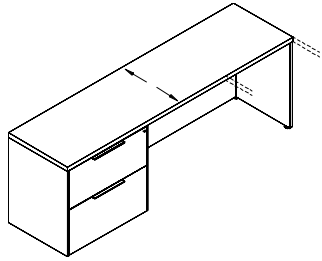

PRODUCT MODIFICATIONS *modify depth - increase depth*

Style Number	List Price
MOD-6	Add 10%

Specifications

- Increase depth by no more than 6"

Notes

- Ex. 24" to 30", 30" to 36", and 36" to 42"
- Add 10% to the unit you want to increase the depth of by no more than 6"

PRODUCT MODIFICATIONS *modify height*

Style Number	List Price
MOD-7	Contact for pricing

Specifications

- Modify height of a unit

PRODUCT MODIFICATIONS *modify conference table length and width - 1 piece top*

Style Number	List Price
MOD-8	125

Specifications

- Modify length/width on a 1 piece table top

PRODUCT MODIFICATIONS *modify conference table length and width - 2/3 piece top*

Style Number	List Price
MOD-9	250

Specifications

- Modify length/width on a 2 or 3 piece table top

Diva options.

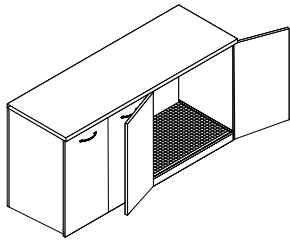

REFRIGERATOR MODIFICATION
refrigerator cabinet modification

Style Number	List Price
REF01	205

Specifications

- Open back cutout for venting
- Moisture sponge mat
- Contaminate ledge
- Contact customer service for maximum refrigerator size (Changes based on unit).

Notes

- Available on: 36" and 42" Storage Credenzas

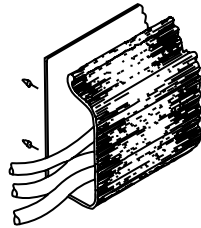

WIRE MANAGEMENT
horizontal j-channel wire management raceway

Style Number	List Price
W1	80 Per 4' section

Specifications

- 4' section for field installation.
- The "J" shape black thermoplastic wire raceway may be added to specified worksurface tops to provide concealed channeling of wires to and from worksurface grommets. For use in open kneespace areas, raceway is attachable to top of back panel with pan head screws. Interior dimensions are 1" x 1- 1/2" providing ample storage for multiple wires and excess cable. Front of raceway flexes out for easy cord insertion.

Notes

- Units w/ Wire Channel Standard.
- Field Installation

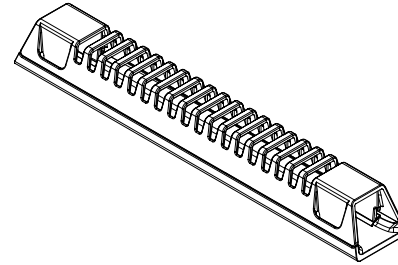

WIRE MANAGEMENT
horizontal wire management raceway

Style Number	List Price
W21	35

Specifications

- 10"W x 1.5"D x 1.25"H
- Grey Wire Manager (10.5")
- Power and data cables can be discretely housed and managed with the W21 Gray Wire Manager. This can be mounted in any location to metal frame or underside of conference tables and runs cables through a 1" channel from power module to hollow steel legs. This keeps cables organized under the table top. Release clips make it simple to snap on and off the Wire Manager for easy organization and access after attached to the table

Notes

- Field installed

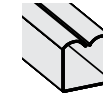

WIRE MANAGEMENT
horizontal u-channel wire management raceway

Style Number	List Price
W2A	80 Per 4' section

Specifications

- 4' section for field installation.

Notes

- Units w/ Wire Channel Standard.
- Field Installation

Diva options.



WIRE MANAGEMENT *coil wire manager*

Style Number	List Price
W18	160

Specifications

- Weighted Base, Table attachment plate
- 39- 1/2" Length
- Black

- Notes
- Location

power & data options.

Aircharge wireless charging grommet

Style Number	List Price
 ACWG WIRELESS GROMMET	\$195

Specifications

- › When used with GROVE Tables an additional \$350 LIST will apply for the special cutout required.
- › AirCharge offers a convenient way to charge any Qi compatible smartphone or device without the need to carry charging cables or find an available power outlet.
- › The Aircharge is powered by the latest Qi compliant IC offering reliable and efficient wireless charging in a convenient 3" grommet hub. Simply place your phone on the Aircharge and an LED will confirm pairing and begin wireless charging.
- › Recess: Efficient space conservation and quick access
- › Input: DC 5V (with included AC power adapter), DC 9V, 1.67A (with optional QC 2.0 power adapter)
- › Output: 5 watts Max. with DC 5V, 2A power adapter, 10 watts Max. with QC 2.0 power adapter
- › Qi V1.2 compliant IC
- › Charging distance: 6mm Max.

Available: All DARRAN collections



power & data options.

Cove power unit - non-linking

Style Number

List Price



PD-COVE PLUG

\$550

Non-linking version

Specifications

- › Size 5.75" L x 2.5" W
- › (2) 15 Amp Receptacles and (2) USB charging ports
- › Surface Mount
- › 108" Cord
- › Standard Silver Finish, Available in White or Black Finish upon request
- › ETL Listed

Available: All DARRAN collections



power & data options.

Cove power unit with daisylink

Style Number	List Price
--------------	------------

STARTER UNITS



COV-DCH HARDWIRED	\$710
-------------------	-------

Includes (1) Cove unit with Hardwire Infeed - 120"



COV-DCP PLUG	\$800
--------------	-------

Includes (1) Cove unit with Plug infeed -
Includes 72" Cord and 32" Infeed Jumper for
104" total cord infeed

ADDITIONAL LINKING UNITS

COV-DCL	\$575 EACH
---------	------------

Includes Linking Cove unit and Jumper up to
96", cable length determined by the top size

Specifications

- › Size: 5.75"L x 2.5"W
- › (2) 15 Amp Receptacles and (2) 2.1 Amp USB charging ports
- › Surface Mount
- › Max Daisy Chain - Hardwire - (9) units; Plug/Corded - (4) units
- › Standard Silver Finish, Available in White or Black Finish upon request
- › ETL Listed

Available: All DARRAN collections



power & data options.

Cove corded series

Style Number

List Price



PD-COVE-PKO

\$800

Specifications

- › Size 9.5" L x 2.5" W x 3.18" D
- › When used with GROVE Tables an additional \$350 LIST will apply for the special cutout required.
- › (2) Power Receptacles, (2) 2.1 Amp USB charging ports and (1) Telecom Plate Knockout
- › Surface Mount
- › 108" Cord
- › Standard Silver Finish, Available in White or Black Finish upon request
- › ETL Listed

Available: All DARRAN collections

Telecom Plates

RJ45 (1)	\$35
RJ45 (2)	\$70
RJ45 (3)	\$105
USB (1)	\$70
USB (2)	\$140
RJ11/RJ45	\$70
RJ45/USB	\$105
RJ45/HDMI	\$190
HDMI/DVI	\$325
HDMI/USB	\$205
HDMI/VGA	\$240
VGA/MINI-STEREO	\$155
VGA/USB	\$175

This pod can have up to 1 total plates.
*All telecom connectors sold separately.



power & data options.

Powered seamless grommet

Style Number	List Price
	
Power/Plug	
PSG82-C: PLUG	\$1875

Specifications

- › Grommet comes with 2 Power Pods that are mounted under the Seamless Grommet. Pods daisylink together with (2) innerconnecting cables.
- › Soft close door
- › Size: 11.5”L x 8.25W”
- › (4) Power Receptacles per power pod, 8 total
- › 124” Power cord
- › Standard Black Finish
- › UL Listed
- › (2) 2.1 Dual USB ports per pod, 4 total
- › (2) Data ports per pod, 4 total
- › Contact customer service when daisy chaining 2 Seamless grommets together.

Available: ThinkingQuietly, Diva, EdgeWorks, Rift, Conference

Telecom Plates	
RJ45 (1)	\$35
RJ45 (2)	\$70
RJ45/HDMI	\$190
HDMI/VGA	\$240
RJ45/VGA	\$190

This pod can have up to 1 total plates.

*All telecom connectors sold separately.



power & data options.

VILLA Power unit - non-linking

Style Number	List Price
VIL-C PLUG Non-Linking	\$515

Specifications

- › Size: Top Grommet 5.68" L X 3.39"W; Under Top 12"L x 3.13"W x 3.08"D
- › (2) Power receptacles; (2) USB charging ports and (1) Knockouts for RJ45 Data Ports
- › Surface Mount
- › 72" Cord (Longer cord available, contact Customer Service)
- › Standard Silver Finish, Black Finish available upon request
- › UL or ETL Certified

Available: All DARRAN collections, excludes Grove

RJ45 Knockout	
RJ45 (1)	\$35



EdgeWorks price list



effective july 1, 2021

designed by thinkingworks design studio

EdgeWorks table of contents

Statement of Line	
Features & Advantages	1
Finishes Specifications	3
Metal Finishes Specifications	4
Wire Management.....	6
Interconnecting Rails.....	7
Measurements.....	8
Edges Pulls.....	9
Grommets	10
Grain Direction	11
Drawer Dimensions.....	12
Inline Workstations	15
Facing Workstations.....	18
Workstation Tops	23
Freestanding Desk.....	25
Workstation Returns	26
Training Tables.....	29
Workstation Credenzas.....	34
Mobile Pedestals	35
Screens	37
Wall Hung Units.....	43
Tackboards, Veneer Panels, Marker Boards, Glassboards.....	46
Accessories	48
Round Conference Tables.....	52
Square Conference Tables	54
Conference Tables.....	56
Conferencing Credenzas.....	76
Options.....	77
Power & Data	84

EdgeWorks statement of line

29" unit with basket shown



PAGE 15
Workstations



PAGE 16
Workstations



PAGE 17
Workstations

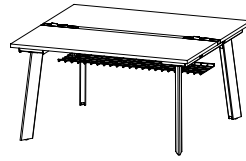

PAGE 18
Workstations



PAGE 19
Workstations



PAGE 20
Workstations



PAGE 21
Workstations



PAGE 22
Workstations

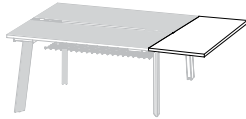

PAGE 23
Workstation Tops

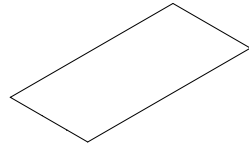

PAGE 24
Workstation Tops

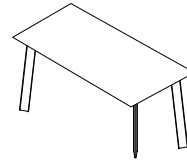

PAGE 25
Freestanding Desk

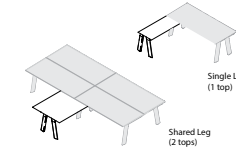

PAGE 26
Return

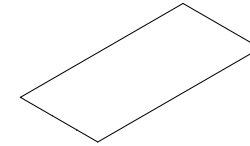

PAGE 27
Return

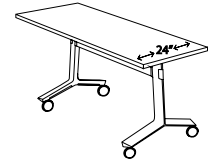

PAGE 28
Training table



PAGE 29
Training table

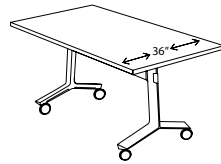

PAGE 30
Training table

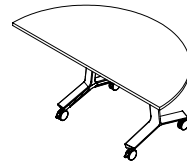

PAGE 31
Training table

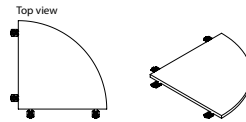

PAGE 32
Training Table Top



PAGE 33
Privacy Screen

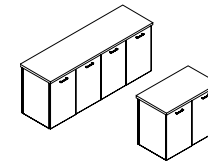

PAGE 34
Full Pedestal Credenzas



PAGE 35
Pedestals

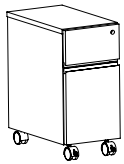

PAGE 36
Pedestals

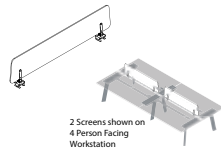

PAGE 37
Privacy Screen

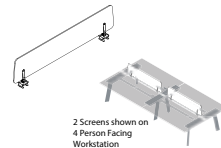

PAGE 38
Privacy Screen

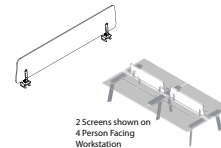

PAGE 39
Privacy Screen

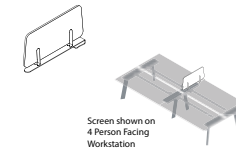

PAGE 40
Interpersonal Screen

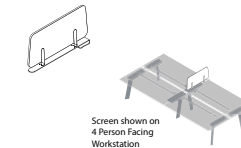

PAGE 41
Interpersonal Screen

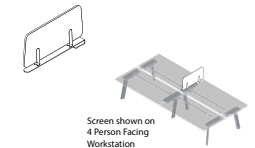

PAGE 42
Interpersonal Screen

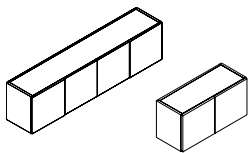

PAGE 43
Single Height Wall Hung Overheads

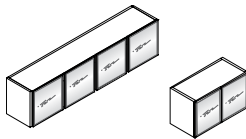

PAGE 44
Single Height Wall Hung Overheads

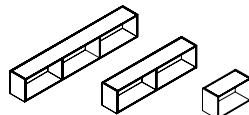

PAGE 45
Single Height Wall Hung Overheads

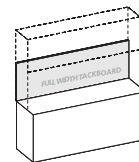

PAGE 46
Wall Hung Tackboards

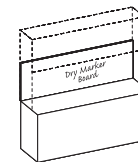

PAGE 47
Wall Hung Marker Boards

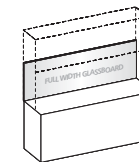

PAGE 48
Wall Hung Veneer Panel

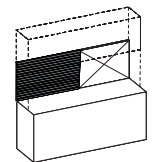

PAGE 49
Wall Hung Glassboards

EdgeWorks statement of line

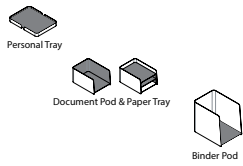

PAGE 50
Metal Accessories

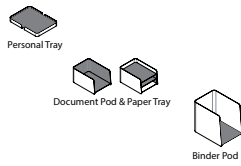

PAGE 51
Metal Accessories



PAGE 52
Conference Tables



PAGE 53
Glass Conference Tables

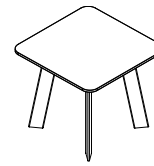

PAGE 54
Conference Tables

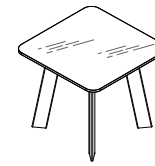

PAGE 55
Glass Conference Tables

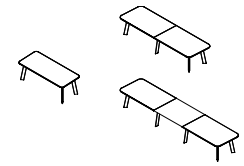

PAGE 56
Conference Tables

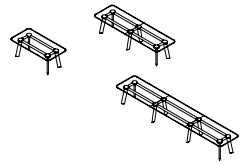

PAGE 57
Glass Conference Tables

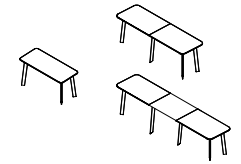

PAGE 58
Conference Tables

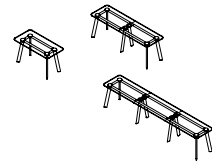

PAGE 59
Glass Conference Tables

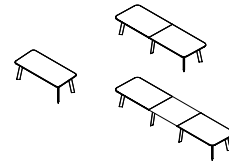

PAGE 60
Conference Tables

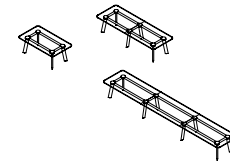

PAGE 61
Glass Conference Tables

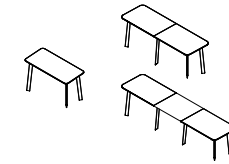

PAGE 62
Conference Tables

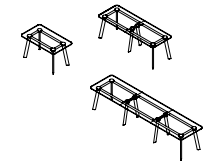

PAGE 63
Glass Conference Tables

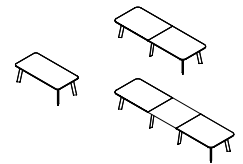

PAGE 64
Conference Tables

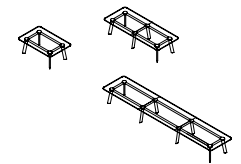

PAGE 65
Glass Conference Tables

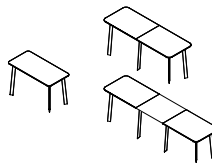

PAGE 66
Conference Tables

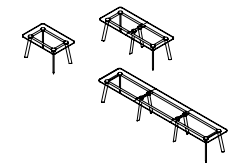

PAGE 67
Glass Conference Tables

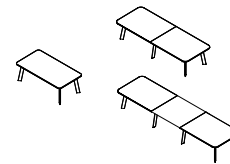

PAGE 68
Conference Tables

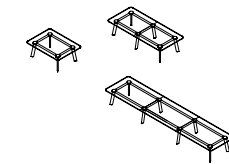

PAGE 69
Glass Conference Tables

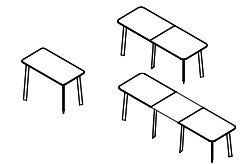

PAGE 70
Conference Tables

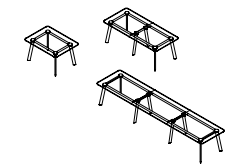

PAGE 71
Glass Conference Tables

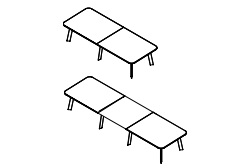

PAGE 72
Conference Tables

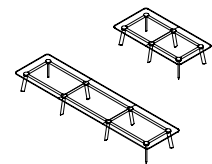

PAGE 73
Glass Conference Tables

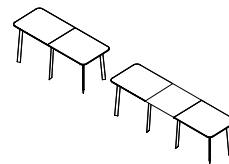

PAGE 74
Conference Tables

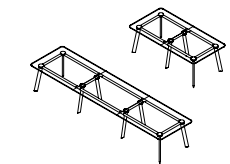

PAGE 75
Glass Conference Tables

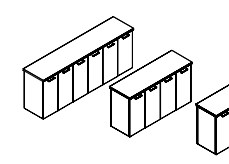

PAGE 76
Full Pedestal Credenzas

EdgeWorks features & advantages

Veneer

DARRAN only uses HPVA AA Grade Flat Cut Cherry, Maple, and Walnut Veneers and AA Grade Quartered Oak and Ash Veneers. EdgeWorks is also available in double cut reconstituted walnut and oak patterns made from rapidly renewable wood veneer providing a repeatable consistent straight grain pattern. All veneers are selected and matched for balance and consistency.

Veneer Tops

EdgeWorks veneer tops feature a 45-pound density substrate with balanced 3-ply construction. Tops are 1" thick on MDF core comprised of 100% recycled and recovered wood fibers. All veneer tops are slipmatched and feature a 3mm external solid hardwood band or profile edge.

Laminate Tops

EdgeWorks high-pressure laminate tops feature a 45-pound density substrate with balanced 3-ply construction. Tops are 1" thick on MDF core comprised of 100% recycled and recovered wood fibers. All high pressure laminate tops are available with a profile edge, laminate self-edge or 2mm PVC edge band. Laminates in wood grain patterns feature a fine grain texture that features the polish and luxe of a real wood veneer with a subtle narrow grain structure.

TFL top

Thermally Fused Laminate tops feature a 45-pound density substrate with balanced 3-ply construction. Tops are 1" thick on MDF core that is comprised of 100% recycled and recovered wood fibers. All Thermally Fused Laminate tops are available with a 2mm flat PVC band. Laminates in wood grain patterns feature Timberline Texture providing the grain pattern of wood.

Cleaning wood & laminate

In addition to regular dusting, give your furniture an occasional cleaning in accordance with our cleaning instructions. DARRAN wood and laminate products can be cleaned with a soft cloth and a mild soap and water mixture. Use approximately 32 oz of water mixed with one tablespoon of dish soap, always wiping with the grain. Dry with a soft cloth, going with the grain, to avoid spotting or streaking.

Wood products should be waxed periodically using a non-wax liquid; please do not use any waxy polish or cleaner. Interior of drawers may also be cleaned with mild soap and water mixture, or any household cleaner that is not petroleum or thinner-based.

Chassis & pedestal

Chassis components are $\frac{3}{4}$ " thick core of particle board or MDF rated EPP/SCS/CARB-II material with 3-ply balanced construction. Pedestal and Cabinets feature dowel

construction reinforced with steel bracket plates, wood cleats, screws and glue. All units are standard with 1" adjustable glides that allow for leveling of units that are secured in solid wood glide blocks to prevent tearout.

Cabinet construction

Wall mount cabinets are mounted to the wall with steel "z" bracket attachment method using 5mm euro screws to attach to the back of the cabinet. All units ship with a steel "z" bracket. This bracket is mounted to the wall by field installers. Installers are responsible for selecting and supplying appropriate fasteners for wall conditions.

Tackboards

Wall mount tackboards are constructed of .75" thick fiberboard. The fabric is precisely aligned and fitted to the tackboard with a sock on cover.

Adjustable Glides

Glides provide 3" of vertical leveling adjustment. Glide bottom is durable plastic.

Adjustable glides

Glides provide 1" of vertical leveling adjustment. Glide bottom is durable metal. Glides are secured in solid wood blocks that are screwed and glued for durability.

Drawers

All drawers are constructed with mitre joint/dowel construction in a natural maple finish with four sides and a bottom, which are attached to a drawer front with screws for easy removal. Drawer fronts are vertically matched in balanced sets. Pencil trays are standard in all box drawers. Drawers are constructed of 1/2" thick wood grained wrapped 5 sided miter-folded construction with 1/4" thick hardboard bottoms reinforced for heavy weight capacity. Drawers have been tested and pass BIFMA 50,000 cycle test. All drawers are guaranteed lifetime with free replacement warranty.

Drawer fronts

Drawer fronts are vertically matched in balanced sets.

Optional wood drawers

Optional hardwood veneer plywood drawers feature banded top and bottom edges for smoothness. Drawers are dowel joint construction with a UV cured finish over maple veneers, plus a lifetime free replacement guarantee.

Optional Wood Drawer (Any Size) – Option Code P33...\$45 List Price Per Drawer.

EdgeWorks features & advantages

Suspensions

All casegoods utilize cold rolled steel zinc plated high-grade drawer suspensions. All suspensions are warranted for the lifetime of the product. Box and File drawers are full extension, featuring steel ball bearings for a smoother quieter range of motion and are rated 100lbs. Lateral file drawers are a progressive action full extension suspension and is rated at 150lbs. Veneer and High Pressure laminate casegoods feature soft close suspension. Thermally Fused Laminate casegoods feature standard suspensions. Lateral files include anti tip mechanism that allow only one drawer to be opened at a time.

Filing

EdgeWorks features a highly durable black plastic extrusion that is securely fastened into a route on top of the drawer to support hanging files. An adjustable crossbar is provided for all file drawers that enables legal/letter filing front to back or side-to-side based on the drawer size.

Locks (all collections except Chameleon)

Locks are Standard on all drawers below the worksurface. Random lock cores are installed at the factory. Some units may be shipped with the same key number. Locks are Silver, Black or Bronze and match pull finish unless otherwise specified.

DARRAN will also send lock cores separately to the dealer at your request. These units will be send with an empty lock core and the Dealer will receive a shipment of the requested lock core/keys.

Keying

Keying is available either factory or field installed. Factory installed keying is random.

Power

A large selection of power pods are available and handle power, data, docking stations and communication. See options section for selection.

Wire management

Wire management capabilities include standard and optional worksurface grommets. Specify W21 under surface wire channels for organization and management of all communication wires and cords. Sold separately to conceal wire under worksurfaces.

Grommets

Metal grommets are provided to match the drawer pull selection. Grommet is available in black, silver or white. Must specify standard or non-standard location. Black plastic grommets are available as an option for vertical applications.

LED tasklights

LED task lighting provides high efficiency, low energy lighting with a long life. Recessed light is encased in silver aluminum channel with milk lense and rounded end caps. Lights are factory installed. Product specifications listed below:

- Diffuser creates a softer light and eliminates hot spots
- Touch dimmer switch
- Can be "daisy chained" up to 90W
- 4.6 watts per foot
- 120 LEDs per meter
- Certification: UL Listed
- 50,000 hour life span.

Color Temp is 4000K

EdgeWorks finishes | specifications

STANDARD VENEER	PREMIUM VENEER	HIGH PRESSURE LAMINATE	THERMALLY FUSED LAMINATE
*WLA Lofty Ash.....	N/A	N/A	N/A
WAC Amber Cherry	N/A	GAC Amber Cherry	MAC Amber Cherry
WEC Ebony.....	N/A	GEC Ebony	MEC Ebony
WOC KoKo Cherry.....	N/A	GOC KoKo Cherry	MOC KoKo Cherry
WAM Alabaster Maple.....	N/A	GAM Alabaster Maple	N/A
WCM Clear Maple	N/A	GCM Clear Maple	N/A
WWM Wheat Maple.....	N/A	GWM Wheat Maple	N/A
N/A.....	WBO Blush Oak.....	N/A	N/A
N/A.....	WMO Mocha Oak	N/A	N/A
N/A.....	*WSO Salted Oak.....	N/A	N/A
WGW Gunstock Walnut.....	N/A	N/A	MGW Gunstock Walnut
WBW Henna Walnut.....	N/A	N/A	N/A
WSW Smokey Walnut.....	N/A	N/A	N/A
WNW Natural Walnut	N/A	GNW Natural Walnut	N/A
N/A.....	TBCO Baby's Cheek	N/A	N/A
N/A.....	TBSW Brown Sugar	N/A	N/A
N/A.....	TSTV Studio Teak Walnut.....	GSTV Studio Teak Walnut	MTW Studio Teak Walnut
N/A.....	TSMV Seattle Mist	N/A	N/A
N/A.....	TSLV Skyline Walnut	GSLV Skyline Walnut	MSW Skyline Walnut
N/A.....	TOBW Organic Brown	N/A	N/A
WWP Designer White Paint.....	N/A	GWL Designer White	MWL Designer White

HPL TOPS ON TFL PRODUCTS Add 10% - Available with flat edge only

*WSO Salted Oak and WLA Lofty Ash Features matte 5% sheen. All other finishes are 40% sheen

For custom Fenix laminate pricing call our Customer Service at 1-800-334-7891

Send 3x3 or larger finish chip for color match. Custom finish upcharge is 3% or \$250 Net (whichever is greater).

Finish

ENVI-CT Green Certified European Technology Coatings

Finish.

EdgeWorks metal finishes | specifications

Metal is standard in MFMB Black. Premium Metal Finish: Priced per unit on product page.



MFMB
Matte Black
(Standard)



MFS
Silver
(Premium)



MFGG
Graphite
Gray
(Premium)



MFW
White
(Premium)



MFSS
Salmon
Sienna
(Premium)



MFSA
Surfin
Aquavert
(Premium)



MFPS
Pistachio
(Premium)



MFOS
Oyster
(Premium)



MFNA
Navy
(Premium)



MFOL
Olive
(Premium)



MFGB
Grey
Beige
(Premium)

EdgeWorks acoustic material | specifications

Central and Interpersonal Privacy Screens available in SCG Charcoal Gray and SHG Heather Gray acoustic material.



SCG
Charcoal Gray



SHG
Heather Gray



Acoustic material is mounted between die cast spacer blocks creating personal space.

EdgeWorks metal finishes | specifications

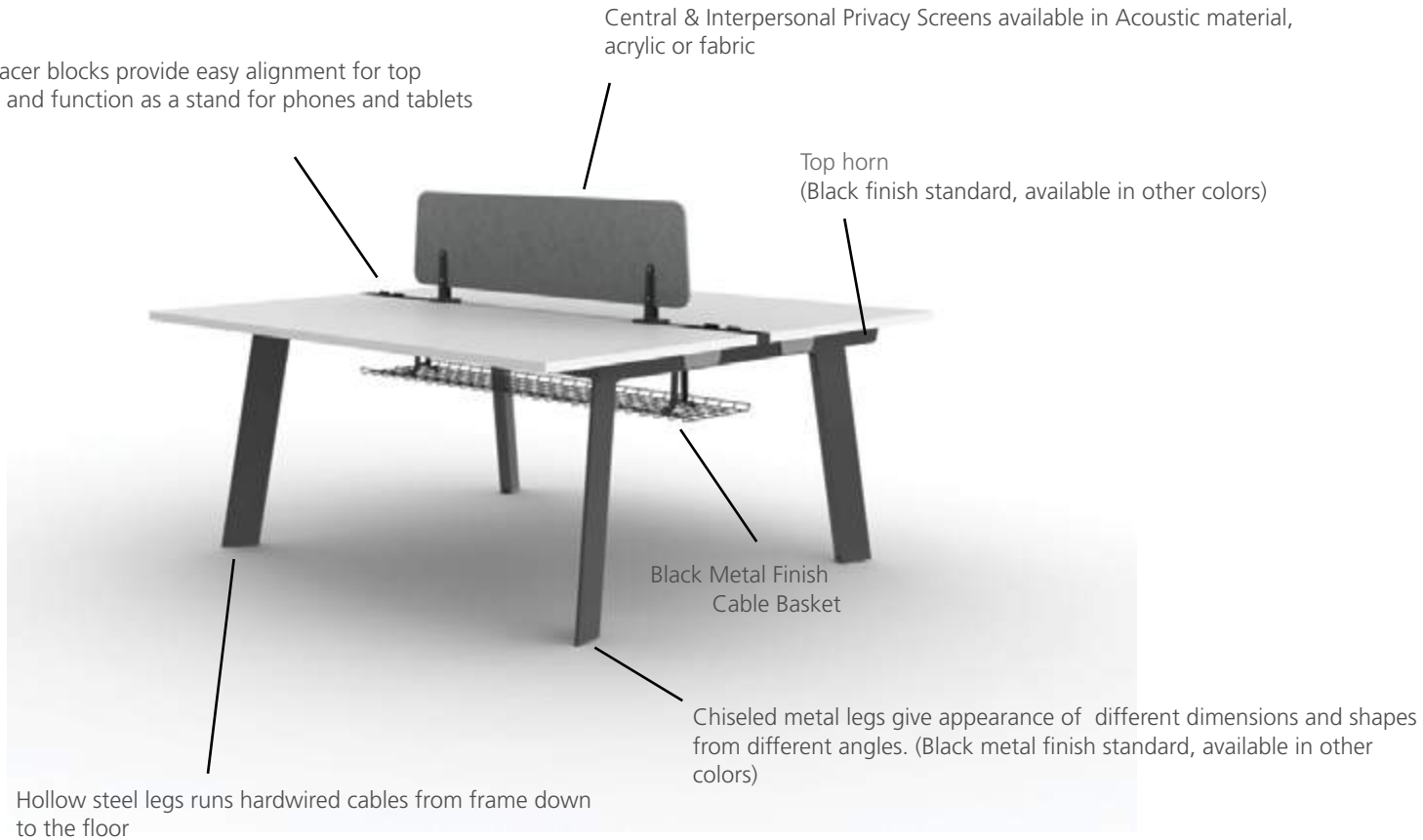

EdgeWorks training table | power guide

Tables can be ganged together for larger workspaces and connected with infeed jumper cables. Power pods are available in black, white and silver.



1 Power Pod:

- PD-Cove-PKO-TT: Cover Power Unit with 2 power, 2 USB and 1 telecom plate - \$435

Choose Your Infeed:

- PFC72: 72" 3 prong plug power infeed - \$225
- PFHRD120: 120" hardwire whip power infeed - \$210

Choose Jumper Length:

- JCTT84: Jumper for 84" workspaces - \$145
- JCTT72: Jumper for 72" workspaces - \$135
- JCTT66: Jumper for 66" workspaces - \$130
- JCTT60: Jumper for 60" workspaces - \$125
- JCTT54: Jumper for 54" workspaces - \$120
- JCTT48: Jumper for 48" workspaces - \$115
- JCTT42: Jumper for 42" workspaces - \$110

Choose 1 Telecom Plate:

- RJ45 (1) - \$35
- RJ45 (2) - \$70
- RJ45 (3) - \$105
- USB (1) - \$70
- USB (2) - \$140
- RJ45/USB - \$105
- RJ45/HDMI - \$190
- HDMI/USB - \$205

Bottom View

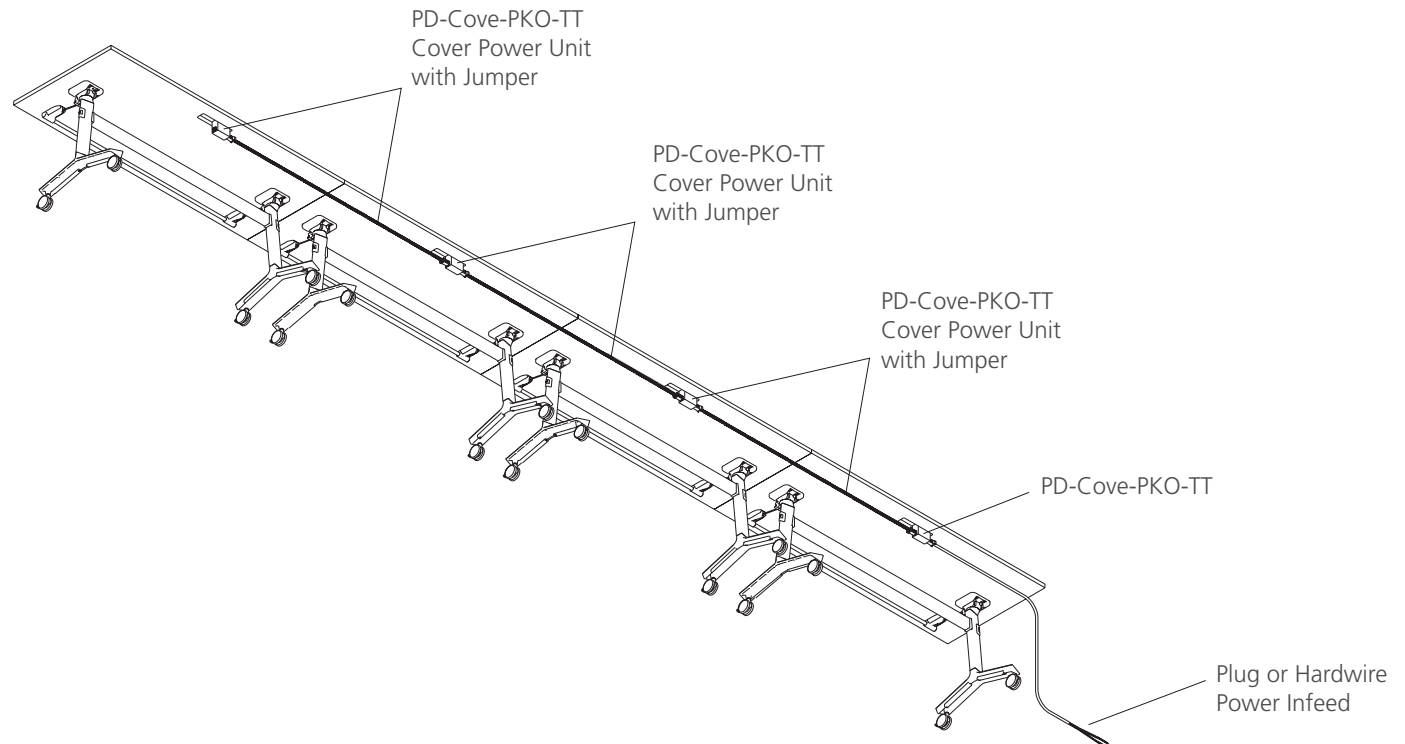

EdgeWorks wire management

Conference wire management

Power and data cables can be discretely housed and managed with the W21 Grey Wire Manager. This can be mounted in any location to metal frame or underside of conference tables and runs cables through a 1" channel from power module to hollow steel legs. This keeps cables organized under the table top. Release clips make it simple to snap on and off the Wire Manager for easy organization and access after attached to the table

W21: Grey Wire Manager (10.5") - \$35



W21 Grey Wire Manager
10"W x 1.5"D x 1.25"H

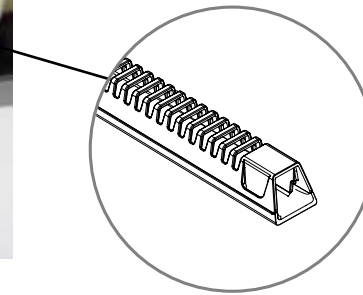

Workstation wire management

Wire baskets secure the underside of tops with cWips enabling the easy removal and adjustment of wires. Baskets come standard on all Workstations.

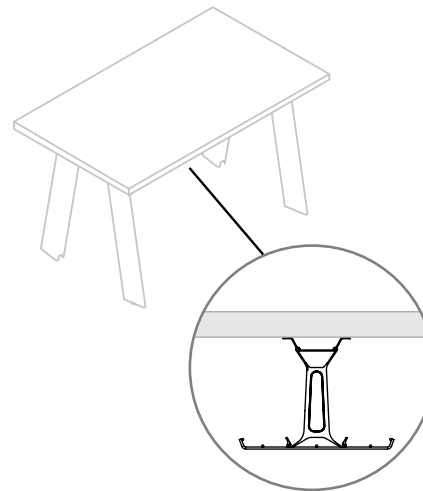
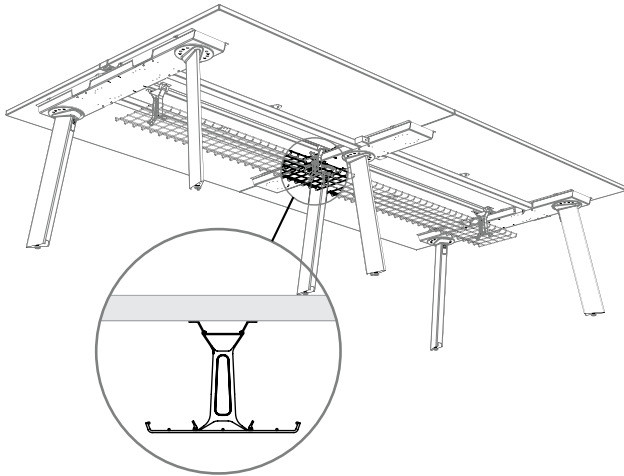

Cable baskets attach to underside of worksurface.

Double Sided Baskets for facing and inline workstations.

Neat thinking

With ample capacity within the hollow steel leg for hardwired cables or data that can be discretely housed and managed.



EdgeWorks interconnecting rails

The EdgeWorks workstation top horn is designed to accommodate rails that interconnect to allow for the easy addition or removal of a section of the workstation. This is a good selling point for clients who are looking to expand in the future, and considers the environment by conserving materials.

Touchdown extension top

Touchdown extension top enhances communication and collaboration, making workstations a functional meeting space.

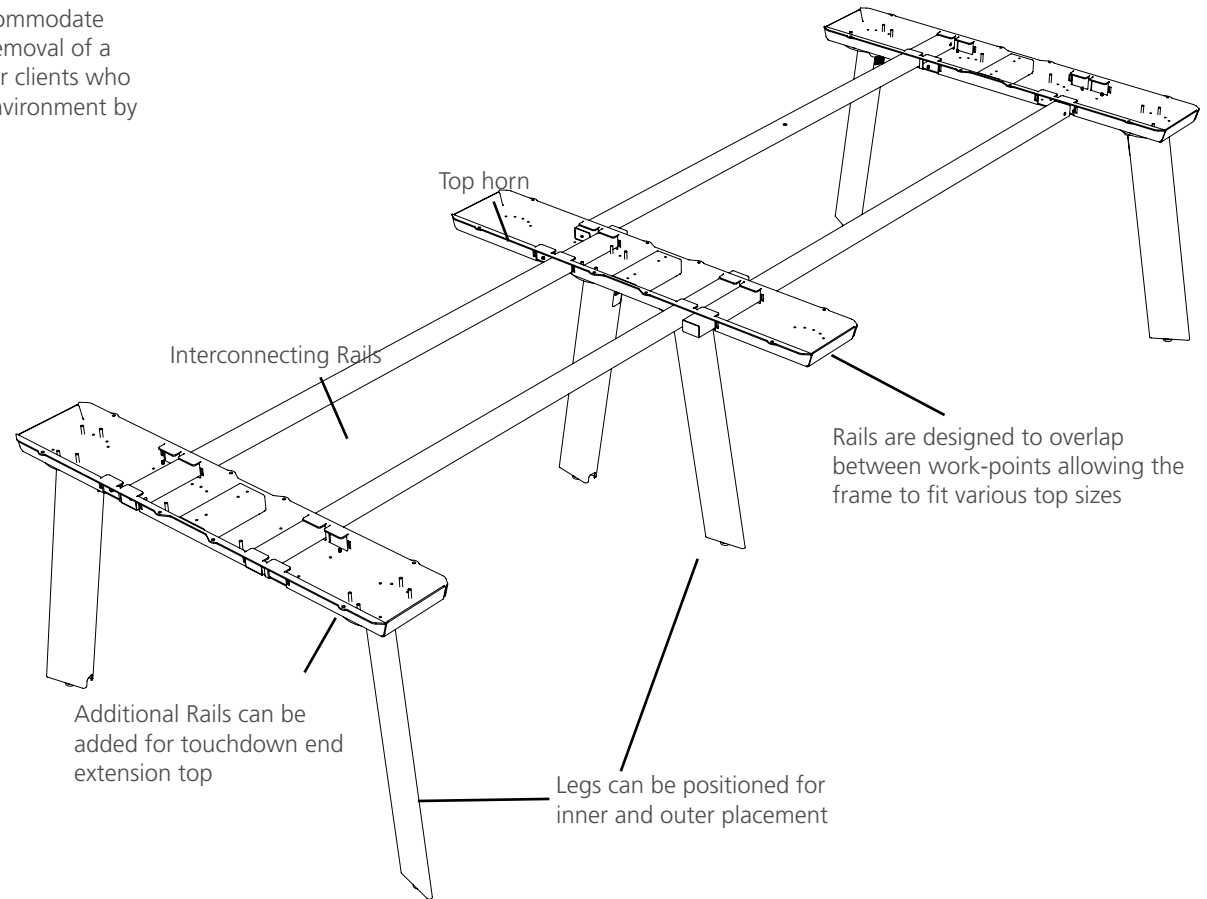

Top horn and leg position



Attach worktop to the top horn

A single leg can be rotated on the top horn for right, left and center position increasing the design flexibility

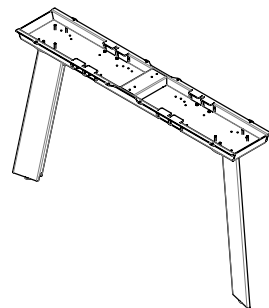

End Leg Set
(Top horn + 2 Legs Outset)

OR

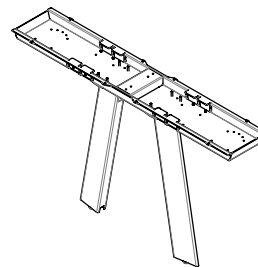

Middle Leg Set
(Top horn + 2 Legs In set)

EdgeWorks 4 person workstation measurements

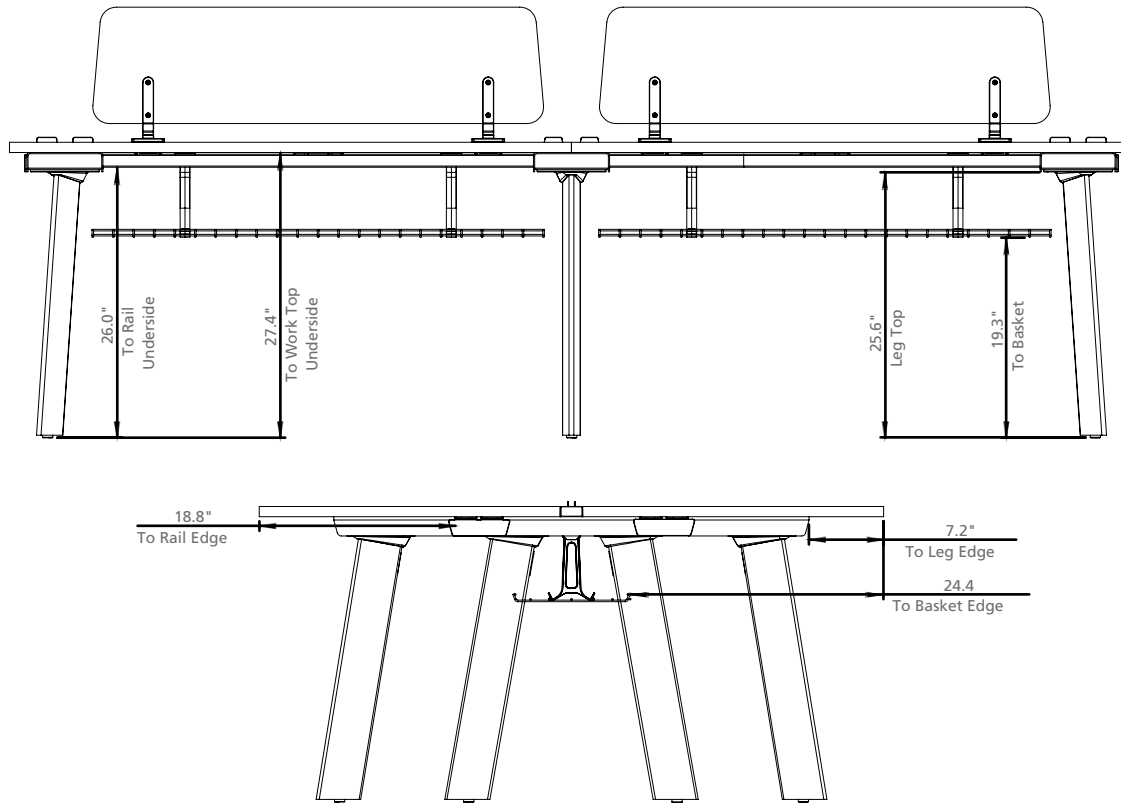

EdgeWorks edges | pulls

Standard profile

"W" "P" "G" Standard profile

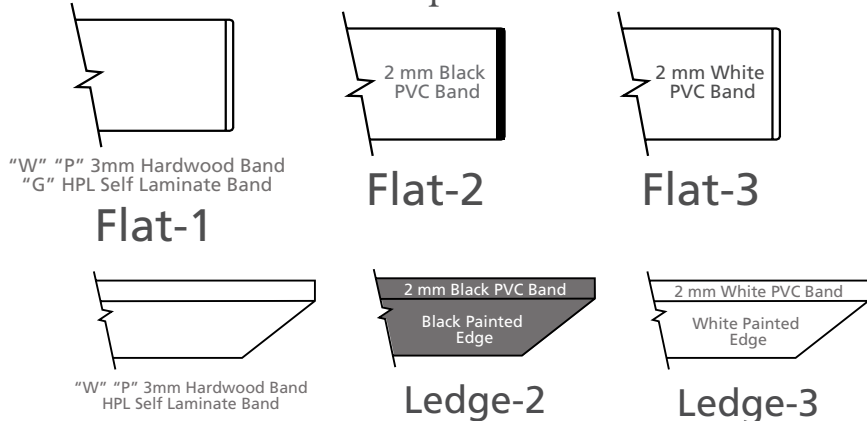

"W" "P" 3mm Hardwood Band
"G" HPL Self Laminate Band

Flat-1

Flat-2

Flat-3

Ledge-1

Ledge-2

Ledge-3

*Flat-1 not available
in GWL finish

"M" Standard profile

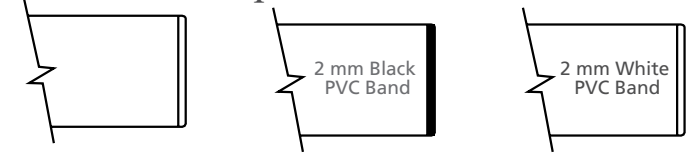

Flat-1

Flat-2

Flat-3

Pulls

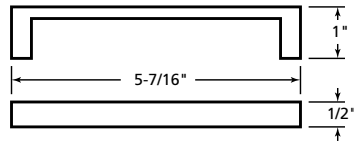

PL-115 Matte Black
PL-116 Matte Nickel

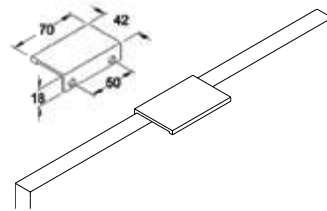

PL-260 Anodized Aluminum
PL-261 White
(Drawers Only)
Optional \$15 list per pull

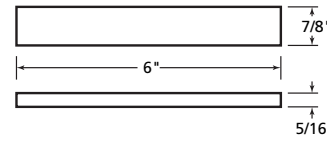

PL-210 Anodized Aluminum

Finger pulls

Arrow indicates finger pull location

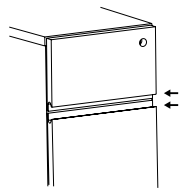

Finger Pull available on
"W" "P" "G" Mobile Pedestals

EdgeWorks grommets | grommet reference

TM30
Black
1-5/8" Dia.

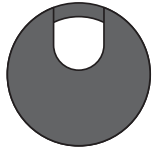

TM31
Silver
1-5/8" Dia.

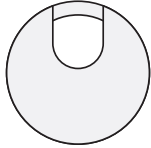

TM34
White
1-5/8" Dia.

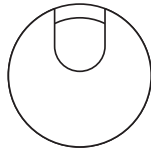

Optional grommets

Factory Installed

Grommets (Standard Location)

Specify Color and Left/Right/Center - \$50 ea.

- Black: TM30-R (Right), TM30-L (Left), TM30-C (Center)

- Silver: TM31-R (Right), TM31-L (Left), TM31-C (Center)

- Antique Brass: TM33-R (Right), TM33-L (Left), TM33-C (Center)

Grommets (Non-Standard Location)

Provide drawing w/ Grommet Location and Specify

Color - \$95 ea.

- White: TM34-NS

TM50
Black
1-5/8" Dia.



Grommets (vertical surface)

Standard Location - \$50 ea.

- Black Plastic Vertical Surface: TM50-C (Bottom Center)

Non-Standard Location - \$95 ea.

- Black Plastic Vertical Surface: TM50-NS

Conference wire management

Power and data cables can be discretely housed and managed.

10"W x 1.5"D x 1.25"H

W21: Grey Wire Manager (10.5") - \$35

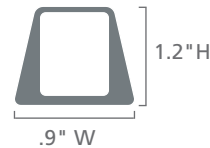
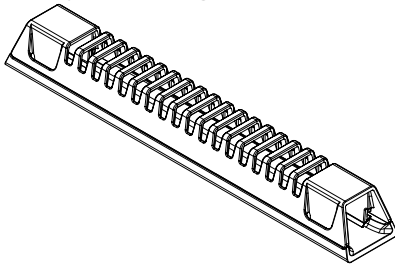

Vertebrae wire management

W22 - Vertebrae (Clear) - \$135

W23 - Vertebrae (Gray) - \$140

*Field Installed



Standard grommet location reference

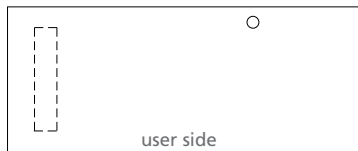

Return (Left leg shown)
Left Leg - Right Grommet



Return (Right leg shown)
Right Leg - Left Grommet



Full Pedestal Credenza
Center Grommet

EdgeWorks grain direction

Grain direction

Veneer chassis parts are vertical grain. The backs of Thermally Fused Laminate overheads, wall hungs, wall hung shelves and flush chassis desks are horizontal grain. Bridges, returns, and credenza kneespace Thermally Fused Laminate backs over 60" are horizontal grain. Doors feature vertical veneer bookmatched horizontally in sets of 2,4, and 6 doors. Tower fronts are matched in vertical sets.

"W" & "P" conference

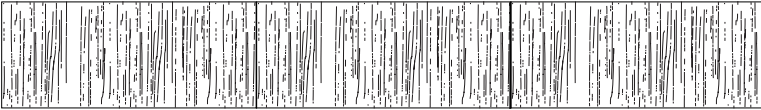
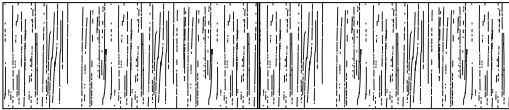

"G" & "M" conference

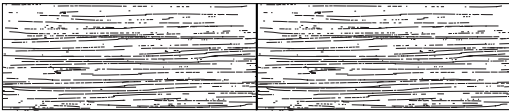

Worksurfaces



Desk

EdgeWorks Drawer dimensions | filing reference

Interior drawer dimensions

UNIT DEPTH	DRAWER TYPE	OVERALL DIMENSIONS			INTERIOR DRAWER DIMENSIONS			NOTES
		W	D	H	W	D	H	
15-5/8" Letter	18" Box	13-1/8	16-1/16	4	12-1/8	15-1/16	3-7/16	Units less than 72"
	18" File	13-1/8	16-1/16	9-13/16	12-1/8	15-1/16	9-5/16	Units less than 72"
	10" Box	7-1/2	16-1/16	4	6-1/2	15-1/16	3-7/16	
	10" File	7-1/2	16-1/16	9-13/16	6-1/2	15-1/16	9-5/16	

Filing reference

Filing for 18" depth units

13 1/8" Wide File Drawer - 16 1/16" Deep

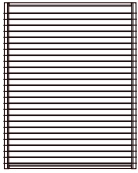

Letter Front to Back

Filing for 10" depth units

7-1/2" Wide File Drawer - 16 1/16" Deep



Letter Side to Side

Edgeworks.

Workstations

1 Person Inline Workstation

1 Select a model w" x d" x h"	weight	Standard Veneer Top Matte Black Metal Base		Premium Veneer Top Matte Black Metal Frame		High Pressure Laminate Top Matte Black Metal Base		Thermally Fused Laminate Top Matte Black Metal Base																																																																																	
		<p>29" Depth with wire basket</p> <table border="1"> <tr><td>72 x 29 x 29</td><td>115</td><td>EDG7229WP903W</td><td>2599</td><td>EDG7229WP903P</td><td>2859</td><td>EDG7229WP903G</td><td>2458</td><td>EDG7229WP903M</td><td>2233</td></tr> <tr><td>66 x 29 x 29</td><td>145</td><td>EDG6629WP903W</td><td>2582</td><td>EDG6629WP903P</td><td>2840</td><td>EDG6629WP903G</td><td>2446</td><td>EDG6629WP903M</td><td>2222</td></tr> <tr><td>60 x 29 x 29</td><td>100</td><td>EDG6029WP903W</td><td>2567</td><td>EDG6029WP903P</td><td>2824</td><td>EDG6029WP903G</td><td>2436</td><td>EDG6029WP903M</td><td>2152</td></tr> <tr><td>54 x 29 x 29</td><td>95</td><td>EDG5429WP903W</td><td>2550</td><td>EDG5429WP903P</td><td>2805</td><td>EDG5429WP903G</td><td>2424</td><td>EDG5429WP903M</td><td>2140</td></tr> </table> <p>24" Depth without wire basket</p> <table border="1"> <tr><td>72 x 24 x 29</td><td>105</td><td>EDG7224WP903W</td><td>2348</td><td>EDG7224WP903P</td><td>2583</td><td>EDG7224WP903G</td><td>2231</td><td>EDG7224WP903M</td><td>2004</td></tr> <tr><td>66 x 24 x 29</td><td>95</td><td>EDG6624WP903W</td><td>2332</td><td>EDG6624WP903P</td><td>2566</td><td>EDG6624WP903G</td><td>2215</td><td>EDG6624WP903M</td><td>1993</td></tr> <tr><td>60 x 24 x 29</td><td>90</td><td>EDG6024WP903W</td><td>2315</td><td>EDG6024WP903P</td><td>2547</td><td>EDG6024WP903G</td><td>2200</td><td>EDG6024WP903M</td><td>1922</td></tr> <tr><td>54 x 24 x 29</td><td>85</td><td>EDG5424WP903W</td><td>2298</td><td>EDG5424WP903P</td><td>2528</td><td>EDG5424WP903G</td><td>2090</td><td>EDG5424WP903M</td><td>1912</td></tr> </table>										72 x 29 x 29	115	EDG7229WP903W	2599	EDG7229WP903P	2859	EDG7229WP903G	2458	EDG7229WP903M	2233	66 x 29 x 29	145	EDG6629WP903W	2582	EDG6629WP903P	2840	EDG6629WP903G	2446	EDG6629WP903M	2222	60 x 29 x 29	100	EDG6029WP903W	2567	EDG6029WP903P	2824	EDG6029WP903G	2436	EDG6029WP903M	2152	54 x 29 x 29	95	EDG5429WP903W	2550	EDG5429WP903P	2805	EDG5429WP903G	2424	EDG5429WP903M	2140	72 x 24 x 29	105	EDG7224WP903W	2348	EDG7224WP903P	2583	EDG7224WP903G	2231	EDG7224WP903M	2004	66 x 24 x 29	95	EDG6624WP903W	2332	EDG6624WP903P	2566	EDG6624WP903G	2215	EDG6624WP903M	1993	60 x 24 x 29	90	EDG6024WP903W	2315	EDG6024WP903P	2547	EDG6024WP903G	2200	EDG6024WP903M	1922	54 x 24 x 29	85	EDG5424WP903W	2298	EDG5424WP903P	2528	EDG5424WP903G	2090
72 x 29 x 29	115	EDG7229WP903W	2599	EDG7229WP903P	2859	EDG7229WP903G	2458	EDG7229WP903M	2233																																																																																
66 x 29 x 29	145	EDG6629WP903W	2582	EDG6629WP903P	2840	EDG6629WP903G	2446	EDG6629WP903M	2222																																																																																
60 x 29 x 29	100	EDG6029WP903W	2567	EDG6029WP903P	2824	EDG6029WP903G	2436	EDG6029WP903M	2152																																																																																
54 x 29 x 29	95	EDG5429WP903W	2550	EDG5429WP903P	2805	EDG5429WP903G	2424	EDG5429WP903M	2140																																																																																
72 x 24 x 29	105	EDG7224WP903W	2348	EDG7224WP903P	2583	EDG7224WP903G	2231	EDG7224WP903M	2004																																																																																
66 x 24 x 29	95	EDG6624WP903W	2332	EDG6624WP903P	2566	EDG6624WP903G	2215	EDG6624WP903M	1993																																																																																
60 x 24 x 29	90	EDG6024WP903W	2315	EDG6024WP903P	2547	EDG6024WP903G	2200	EDG6024WP903M	1922																																																																																
54 x 24 x 29	85	EDG5424WP903W	2298	EDG5424WP903P	2528	EDG5424WP903G	2090	EDG5424WP903M	1912																																																																																
2 Select a finish <i>View finish details</i>		WLA WNW WAC WWP WEC	TBCO TBSW TSTV TSMV TSLV TOBV WBO WMO WSO		GAC GSLV +10% GEC GWL GOC GAM GCM GWM GNW GSTV +10%		MAC MEC MOC MGW MSW MTW MWL																																																																																		
Metal finish MFMB Matte Black. Additional metal finishes are available, see options.		WOC WAM WCM WWM WGW WBW WSW																																																																																							
3 Select an edge <i>View edge details</i>		Flat-1 Flat-2 (Black) Flat-3 (White)	Flat-1 Flat-2 (Black) Flat-3 (White)		Flat-1 Flat-2 (Black) Flat-3 (White)		Flat-1 Flat-2 (Black) Flat-3 (White)																																																																																		
4 Select hardware <i>View hardware details</i>		Hardware N/A	Hardware N/A		Hardware N/A		Hardware N/A																																																																																		

[View statement of line](#)

29" unit with basket shown

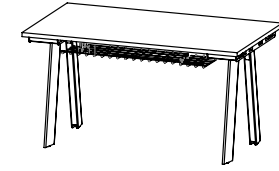

Product features.

- 1" Thick top
- ENVI-CT finish on wood tops
- Matte black metal finish base standard
- (1) top
- (1) black metal finish wire basket (29" depth)
- Optional Metal accessories are mounted to the worksurface, matte black metal finish is standard
- 3" Adjustable glide

Options.

ACCESSORIES

- EA53: Personal Tray - \$270 ea.
- EA54: Document Pod & Paper Try - \$375 ea.
- EA55: Binder Pod - \$290 ea.

POWER BLOCK

- 1IPBS: One In-Line Power Block System with Hardwire - \$390
- Specify hardwired or plug infeed. Plug infeed will require wire management W22 - \$130 Vertebrae (Clear) or W23 - \$135 Vertebrae (Gray)
- Includes (1) Power Block and Infeed
- Each power block has 8 duplex outlets

WORKSURFACE CLAMP MOUNT POWER

- PD-KENO: Keno power pod with clamp - \$195 ea.
- PD-TULLY: Tully power pod with clamp - \$320 ea.
- P2SECL: Seclusion Power Clamp - \$245 ea.

PREMIUM METAL FINISHES

- Specify Top Horn and Leg Metal Finish Color: \$630
- MFV: White, MFS: Silver, MFGG: Graphite Gray, MFSS: Salmon Sienna, MFSA: Surfin Aquavert, MFPS: Pistachio, MFOS: Oyster, MFNA: Navy, MFOL: Olive, MFGB: Grey Beige

PLANK MATCH VENEER

- RPMV: Random Walnut Plank Match Veneer (Horizontal Grain with 25%+ Sap) - Add 10%. Clear coat only.

Edgeworks.

Workstations
2 Person Inline Workstation

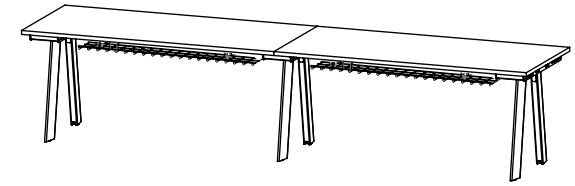

DARRAN™

1 Select a model w" x d" x h"	weight	Standard Veneer Top Matte Black Metal Base		Premium Veneer Top Matte Black Metal Frame		High Pressure Laminate Top Matte Black Metal Base		Thermally Fused Laminate Top Matte Black Metal Base	
72" Worksurfaces 144 x 29 x 29	220	EDG14429WP903W	4516	EDG14429WP903P	4968	EDG14429WP903G	4232	EDG14429WP903M	3784
66" Worksurfaces 132 x 29 x 29	210	EDG13229WP903W	4482	EDG13229WP903P	4931	EDG13229WP903G	4210	EDG13229WP903M	3773
60" Worksurfaces 120 x 29 x 29	190	EDG12029WP903W	4450	EDG12029WP903P	4895	EDG12029WP903G	4188	EDG12029WP903M	3620
54" Worksurfaces 108 x 29 x 29	180	EDG10829WP903W	4417	EDG10829WP903P	4859	EDG10829WP903G	4166	EDG10829WP903M	3598

2 Select a finish <i>View finish details</i>	Metal finish MFMB Matte Black. Additional metal finishes are available, see options.		TBCO TBSW TSTV TSMV TSLV TOBW WBO WMO WSO	GAC GSLV +10% GEC GWL		MAC MEC MOC MGW MSW MTW MWL			
	WLA WNW WAC WWP WEC WOC WAM WCM WWM WGW WBW WSW								
3 Select a edge <i>View edge details</i>									
	Flat-1	Flat-2 (Black)	Flat-3 (White)	Flat-1	Flat-2 (Black)	Flat-3 (White)	Flat-1	Flat-2 (Black)	Flat-3 (White)

4 Select hardware <i>View hardware details</i>	Hardware N/A	Hardware N/A	Hardware N/A	Hardware N/A

[View statement of line](#)

Product features.

- 1" Thick top
- ENVI-CT finish on wood tops
- Matte black metal finish base standard
- (2) tops, (2) black metal finish wire baskets
- Optional Metal accessories are mounted to the worksurface, matte black metal finish is standard
- 3" Adjustable glide

Options.

ACCESSORIES

- EA53: Personal Tray - \$270 ea.
- EA54: Document Pod & Paper Try - \$375 ea.
- EA55: Binder Pod - \$290 ea.

POWER BLOCK

- 2IPBS: Two In-Line Power Block System with Hardwire - \$750
- Specify hardwired or plug infeed. Plug infeed will require wire management W22 - \$130 Vertebrae (Clear) or W23 - \$135 Vertebrae (Gray)
- Includes (2) Power Blocks, (1) Jumper and Infeed
- Each power block has 8 duplex outlets

WORKSURFACE CLAMP MOUNT POWER

- PD-KENO: Keno power pod with clamp - \$195 ea.
- PD-TULLY: Tully power pod with clamp - \$320 ea.
- P2SECL: Seclusion Power Clamp - \$245 ea.

PREMIUM METAL FINISHES

- Specify Top Horn and Leg Metal Finish Color: \$1,010
- MFW: White, MFS: Silver, MFGG: Graphite Gray, MFSS: Salmon Sienna, MFSA: Surfin Aquavert, MFPS: Pistachio, MFOS: Oyster, MFNA: Navy, MFOL: Olive, MFGB: Grey Beige









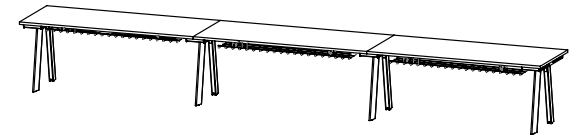



PLANK MATCH VENEER

- RPMV: Random Walnut Plank Match Veneer (Horizontal Grain with 25%+ Sap) - Add 10%. Clear coat only.

Edgeworks.

Workstations
3 Person Inline Workstation



1 Select a model w" x d" x h"	weight	Standard Veneer Top Matte Black Metal Base		Premium Veneer Top Matte Black Metal Frame		High Pressure Laminate Top Matte Black Metal Base		Thermally Fused Laminate Top Matte Black Metal Base	
72" Worksurfaces 216 x 29 x 29	325	EDG21629WP903W	6426	EDG21629WP903P	7069	EDG21629WP903G	6001	EDG21629WP903M	5329
66" Worksurfaces 198 x 29 x 29	310	EDG19829WP903W	6377	EDG19829WP903P	7015	EDG19829WP903G	5968	EDG19829WP903M	5297
60" Worksurfaces 180 x 29 x 29	280	EDG18029WP903W	6328	EDG18029WP903P	6961	EDG18029WP903G	5935	EDG18029WP903M	5084
54" Worksurfaces 162 x 29 x 29	265	EDG16229WP903W	6280	EDG16229WP903P	6908	EDG16229WP903G	5902	EDG16229WP903M	5050
2 Select a finish <i>View finish details</i> Metal finish MFMB Matte Black. Additional metal finishes are available, see options.		WLA WAC WEC WOC WAM WCM WWM WGW WBW WSW	WNW WWP	TBCO TBSW TSTV TSMV TSLV TOBW WBO WMO WSO		GAC GEC GOC GAM GCM GWM GNW GSTV +10%	GSLV +10% GWL	MAC MEC MOC MGW MSW MTW MWL	
3 Select an edge <i>View edge details</i>		 Flat-1  Flat-2 (Black)  Flat-3 (White)		 Flat-1  Flat-2 (Black)  Flat-3 (White)		 Flat-1  Flat-2 (Black)  Flat-3 (White)		 Flat-1  Flat-2 (Black)  Flat-3 (White)	
4 Select hardware <i>View hardware details</i>		Hardware N/A		Hardware N/A		Hardware N/A		Hardware N/A	

[View statement of line](#)

Product features.

- 1" Thick top
- ENVI-CT finish on wood tops
- Matte black metal finish base standard
- (3) tops, (3) black metal finish wire baskets
- Optional Metal accessories are mounted to the worksurface, matte black metal finish is standard
- 3" Adjustable glide

Options.

ACCESSORIES

- EA53: Personal Tray - \$270 ea.
- EA54: Document Pod & Paper Try - \$375 ea.
- EA55: Binder Pod - \$290 ea.

POWER BLOCK

- 3IPBS: Three In-Line Power Block System with Hardwire - \$1,100
- Specify hardwired or plug infeed. Plug infeed will require wire management W22 - \$130 Vertebrae (Clear) or W23 - \$135 Vertebrae (Gray)
- Includes (3) Power Blocks, (2) Jumpers and Infeed
- Each power block has 8 duplex outlets
- Plug Infeed can be daisy chained up to 16 duplex outlets on one 20 amp circuit

WORKSURFACE CLAMP MOUNT POWER

- PD-KENO: Keno power pod with clamp - \$195 ea.
- PD-TULLY: Tully power pod with clamp - \$320 ea.
- P2SECL: Seclusion Power Clamp - \$245 ea.

PREMIUM METAL FINISHES

- Specify Top Horn and Leg Metal Finish Color: \$1,355
- MFV: White, MFS: Silver, MFGG: Graphite Gray, MFSS: Salmon Sienna, MFSA: Surfin Aquavert, MFPS: Pistachio, MFOS: Oyster, MFNA: Navy, MFOL: Olive, MFGB: Grey Beige

PLANK MATCH VENEER

- RPMV: Random Walnut Plank Match Veneer (Horizontal Grain with 25%+ Sap) - Add 10%. Clear coat only.

Edgeworks.

Workstations
2 Person Facing Workstation

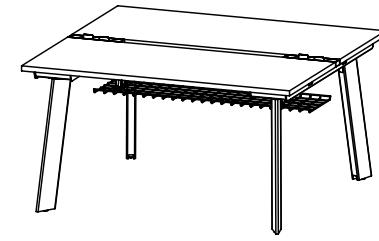

1 Select a model w" x d" x h"	weight	Standard Veneer Top Matte Black Metal Base		Premium Veneer Top Matte Black Metal Frame		High Pressure Laminate Top Matte Black Metal Base		Thermally Fused Laminate Top Matte Black Metal Base																																																																																	
		<p>Worksurface Dimensions</p> <p>29" Depth</p> <table border="1"> <tr><td>72 x 60 x 29</td><td>210</td><td>EDG7260WP900W</td><td>3844</td><td>EDG7260WP900P</td><td>4228</td><td>EDG7260WP900G</td><td>3560</td><td>EDG7260WP900M</td><td>3113</td></tr> <tr><td>66 x 60 x 29</td><td>200</td><td>EDG6660WP900W</td><td>3812</td><td>EDG6660WP900P</td><td>4194</td><td>EDG6660WP900G</td><td>3538</td><td>EDG6660WP900M</td><td>3091</td></tr> <tr><td>60 x 60 x 29</td><td>180</td><td>EDG6060WP900W</td><td>3778</td><td>EDG6060WP900P</td><td>4156</td><td>EDG6060WP900G</td><td>3516</td><td>EDG6060WP900M</td><td>2948</td></tr> <tr><td>54 x 60 x 29</td><td>170</td><td>EDG5460WP900W</td><td>3746</td><td>EDG5460WP900P</td><td>4121</td><td>EDG5460WP900G</td><td>3494</td><td>EDG5460WP900M</td><td>2927</td></tr> </table> <p>23" Depth</p> <table border="1"> <tr><td>72 x 48 x 29</td><td>200</td><td>EDG7248WP900W</td><td>3506</td><td>EDG7248WP900P</td><td>3857</td><td>EDG7248WP900G</td><td>3266</td><td>EDG7248WP900M</td><td>2992</td></tr> <tr><td>66 x 48 x 29</td><td>190</td><td>EDG6648WP900W</td><td>3473</td><td>EDG6648WP900P</td><td>3821</td><td>EDG6648WP900G</td><td>3244</td><td>EDG6648WP900M</td><td>2883</td></tr> <tr><td>60 x 48 x 29</td><td>170</td><td>EDG6048WP900W</td><td>3440</td><td>EDG6048WP900P</td><td>3784</td><td>EDG6048WP900G</td><td>3222</td><td>EDG6048WP900M</td><td>2774</td></tr> <tr><td>54 x 48 x 29</td><td>160</td><td>EDG5448WP900W</td><td>3407</td><td>EDG5448WP900P</td><td>3748</td><td>EDG5448WP900G</td><td>3200</td><td>EDG5448WP900M</td><td>2752</td></tr> </table>										72 x 60 x 29	210	EDG7260WP900W	3844	EDG7260WP900P	4228	EDG7260WP900G	3560	EDG7260WP900M	3113	66 x 60 x 29	200	EDG6660WP900W	3812	EDG6660WP900P	4194	EDG6660WP900G	3538	EDG6660WP900M	3091	60 x 60 x 29	180	EDG6060WP900W	3778	EDG6060WP900P	4156	EDG6060WP900G	3516	EDG6060WP900M	2948	54 x 60 x 29	170	EDG5460WP900W	3746	EDG5460WP900P	4121	EDG5460WP900G	3494	EDG5460WP900M	2927	72 x 48 x 29	200	EDG7248WP900W	3506	EDG7248WP900P	3857	EDG7248WP900G	3266	EDG7248WP900M	2992	66 x 48 x 29	190	EDG6648WP900W	3473	EDG6648WP900P	3821	EDG6648WP900G	3244	EDG6648WP900M	2883	60 x 48 x 29	170	EDG6048WP900W	3440	EDG6048WP900P	3784	EDG6048WP900G	3222	EDG6048WP900M	2774	54 x 48 x 29	160	EDG5448WP900W	3407	EDG5448WP900P	3748	EDG5448WP900G	3200
72 x 60 x 29	210	EDG7260WP900W	3844	EDG7260WP900P	4228	EDG7260WP900G	3560	EDG7260WP900M	3113																																																																																
66 x 60 x 29	200	EDG6660WP900W	3812	EDG6660WP900P	4194	EDG6660WP900G	3538	EDG6660WP900M	3091																																																																																
60 x 60 x 29	180	EDG6060WP900W	3778	EDG6060WP900P	4156	EDG6060WP900G	3516	EDG6060WP900M	2948																																																																																
54 x 60 x 29	170	EDG5460WP900W	3746	EDG5460WP900P	4121	EDG5460WP900G	3494	EDG5460WP900M	2927																																																																																
72 x 48 x 29	200	EDG7248WP900W	3506	EDG7248WP900P	3857	EDG7248WP900G	3266	EDG7248WP900M	2992																																																																																
66 x 48 x 29	190	EDG6648WP900W	3473	EDG6648WP900P	3821	EDG6648WP900G	3244	EDG6648WP900M	2883																																																																																
60 x 48 x 29	170	EDG6048WP900W	3440	EDG6048WP900P	3784	EDG6048WP900G	3222	EDG6048WP900M	2774																																																																																
54 x 48 x 29	160	EDG5448WP900W	3407	EDG5448WP900P	3748	EDG5448WP900G	3200	EDG5448WP900M	2752																																																																																
2 Select a finish <i>View finish details</i>		WLA WNW WAC WWP WEC Metal finish MFMB Matte Black. Additional metal finishes are available, see options.	TBCO TBSW TSTV TSMV TSLV TOBWS WBO WMO WSO	GAC GSWL +10% GEC GWL GOC GAM GCM GWM GNW GSTV +10%	MAC MEC MOC MGW MSW MTW MWL	3 Select an edge <i>View edge details</i>																																																																																			
4 Select hardware <i>View hardware details</i>		Hardware N/A	Hardware N/A	Hardware N/A	Hardware N/A	3 Select an edge <i>View edge details</i>																																																																																			

[View statement of line](#)

Product features.

- 1" Thick top
- ENVI-CT finish on wood tops
- Expandable frame matte black metal finish standard
- (2) tops, (1) black metal finish wire basket
- Optional Metal accessories are center mounted, matte black metal finish is standard
- 3" Adjustable glide

Options.

ACCESSORIES

- EA50: Personal Tray - \$270 ea.
- EA51: Document Pod & Paper Tray - \$375 ea.
- EA52: Binder Pod - \$290 ea.

POWER BLOCK

- 2PPBS: Two Pack Power Block System with Hardwire - \$390
- Specify hardwired or plug infeed. Plug infeed will require wire management W22 - \$130 Vertebrae (Clear) or W23 - \$135 Vertebrae (Gray)
- Includes (1) Power Block and Infeed
- Each power block has 8 duplex outlets

WORKSURFACE CLAMP MOUNT POWER

- PD-KENO: Keno power pod with clamp - \$195 ea.
- PD-TULLY: Tully power pod with clamp - \$320 ea.
- P2SECL: Seclusion Power Clamp - \$245 ea.

PREMIUM METAL FINISHES

- Specify Top Horn and Leg Metal Finish Color: \$630
- MFW: White, MFS: Silver, MFGG: Graphite Gray, MFSS: Salmon Sienna, MFSA: Surfin Aquavert, MFPS: Pistachio, MFOS: Oyster, MFNA: Navy, MFOL: Olive, MFGB: Grey Beige

PLANK MATCH VENEER

- RPMV: Random Walnut Plank Match Veneer (Horizontal Grain with 25%+ Sap) - Add 10%. Clear coat only.

Edgeworks.

Workstations

4 Person Facing Workstation

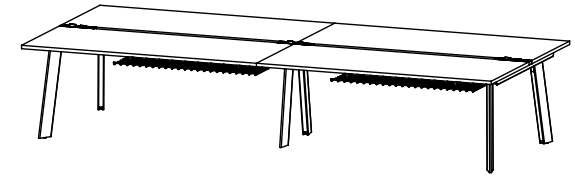

1 Select a model

w" x d" x h"

weight	Standard Veneer Top Matte Black Metal Base	Premium Veneer Top Matte Black Metal Frame	High Pressure Laminate Top Matte Black Metal Base	Thermally Fused Laminate Top Matte Black Metal Base
72" Worksurfaces				
144 x 60 x 29	390 EDG14460WP900W 6880	EDG14460WP900P 7568	EDG14460WP900G 6312	EDG14460WP900M 5416
144 x 48 x 29	370 EDG14448WP900W 6203	EDG14448WP900P 6823	EDG14448WP900G 5722	EDG14448WP900M 5001
66" Worksurfaces				
132 x 60 x 29	370 EDG13260WP900W 6814	EDG13260WP900P 7496	EDG13260WP900G 6268	EDG13260WP900M 5373
132 x 48 x 29	350 EDG13248WP900W 6137	EDG13248WP900P 6751	EDG13248WP900G 5678	EDG13248WP900M 4958
60" Worksurfaces				
120 x 60 x 29	330 EDG12060WP900W 6749	EDG12060WP900P 7424	EDG12060WP900G 6224	EDG12060WP900M 5089
120 x 48 x 29	310 EDG12048WP900W 6072	EDG12048WP900P 6680	EDG12048WP900G 5635	EDG12048WP900M 4739
54" Worksurfaces				
108 x 60 x 29	310 EDG10860WP900W 6683	EDG10860WP900P 7352	EDG10860WP900G 6181	EDG10860WP900M 5045
108 x 48 x 29	290 EDG10848WP900W 6006	EDG10848WP900P 6607	EDG10848WP900G 5591	EDG10848WP900M 4696

[View statement of line](#)

2 Select a finish

[View finish details](#)

Metal finish
MFMB Matte Black.
Additional metal finishes are available, see options.

- WLA WNW
- WAC WWP
- WEC
- WOC
- WAM
- WCM
- WWM
- WGW
- WBW
- WSW

- TBCO
- TBSW
- TSTV
- TSMV
- TSLV
- TOBW
- WBO
- WMO
- WSO

- GAC GSLV +10%
- GEC GWL
- GOC
- GAM
- GCM
- GWM
- GNW
- GSTV
- +10%

- MAC
- MEC
- MOC
- MGW
- MSW
- MTW
- MWL

3 Select an edge

[View edge details](#)

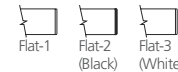
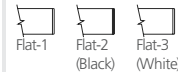
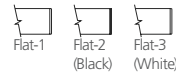

4 Select hardware

[View hardware details](#)

Hardware
N/A

Hardware
N/A

Hardware
N/A

Hardware
N/A

Product features.

- 1" Thick top
- ENVI-CT finish on wood tops
- Expandable frame matte black metal finish standard
- (4) tops, (2) black metal finish wire baskets
- Legs can be positioned for inner or outer placement
- Optional Metal accessories are center mounted, matte black metal finish is standard
- 3" Adjustable glide

NOTES

- 60" Depth Workstations feature 29" Worksurfaces
- 48" Depth Workstations feature 23" Worksurfaces

Options.

ACCESSORIES

- EA50: Personal Tray - \$270 ea.
- EA51: Document Pod & Paper Tray - \$375 ea.
- EA52: Binder Pod - \$290 ea.

POWER BLOCK

- 4PPBS: Four Pack Power Block System with Hardwire - \$750
- Specify hardwired or plug infeed. Plug infeed will require wire management W22 - \$130 Vertebrae (Clear) or W23 - \$135 Vertebrae (Gray)
- Includes (2) Power Blocks, (1) Jumper and Infeed
- Each power block has 8 duplex outlets

WORKSURFACE CLAMP MOUNT POWER

- PD-KENO: Keno power pod with clamp - \$195 ea.
- PD-TULLY: Tully power pod with clamp - \$320 ea.
- P2SECL: Seclusion Power Clamp - \$245 ea.

PREMIUM METAL FINISHES

- Specify Top Horn and Leg Metal Finish Color: \$1,010
- MFW: White, MFS: Silver, MFGG: Graphite Gray, MFSS: Salmon Sienna, MFSA: Surfing Aquavert, MFPS: Pistachio, MFOS: Oyster, MFNA: Navy, MFOL: Olive, MFGB: Grey Beige

PLANK MATCH VENEER

- RPMV: Random Walnut Plank Match Veneer (Horizontal Grain with 25%+ Sap) - Add 10%. Clear coat only.

Edgeworks.

Workstations
6 Person Facing Workstation

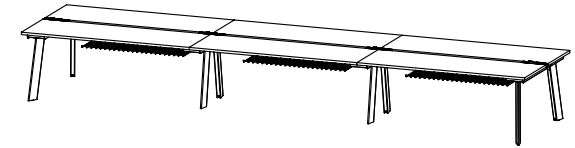

1 Select a model w" x d" x h"	weight	Standard Veneer Top Matte Black Metal Base		Premium Veneer Top Matte Black Metal Frame		High Pressure Laminate Top Matte Black Metal Base		Thermally Fused Laminate Top Matte Black Metal Base	
		72" Worksurfaces 216 x 60 x 29 216 x 48 x 29 66" Worksurfaces 198 x 60 x 29 198 x 48 x 29 60" Worksurfaces 180 x 60 x 29 180 x 48 x 29 54" Worksurfaces 162 x 60 x 29 162 x 48 x 29		570 EDG21660WP900W 9910 540 EDG21648WP900W 8894 540 EDG19860WP900W 9811 510 EDG19848WP900W 8796 480 EDG18060WP900W 9714 450 EDG18048WP900W 8698 450 EDG16260WP900W 9615 420 EDG16248WP900W 8600	EDG21660WP900P 10901 EDG21648WP900P 9783 EDG19860WP900P 10793 EDG19848WP900P 9676 EDG18060WP900P 10686 EDG18048WP900P 9568 EDG16260WP900P 10577 EDG16248WP900P 9460	10901 9783 10793 9676 10686 9568 10577 9460	GAC GSLV +10% GEC GWL GOC GAM GCM GWM GNW GSTV +10%	6958 8173 8993 8108 8927 8042 8862 7977	EDG21660WP900G EDG21648WP900G EDG19860WP900G EDG19848WP900G EDG18060WP900G EDG18048WP900G EDG16260WP900G EDG16248WP900G

2 Select a finish <i>View finish details</i>	Metal finish MFMB Matte Black. Additional metal finishes are available, see options.		TBCO TBSW TSTV TSMV TSLV TOBW WBO WMO WSO	GAC GSLV +10% GEC GWL GOC GAM GCM GWM GNW GSTV +10%	MAC MEC MOC MGW MSW MTW MWL
	WLA WNW WAC WWP WEC WOC WAM WCM WWM WGW WBW WSW				

3 Select an edge <i>View edge details</i>	Flat-1 Flat-2 (Black) Flat-3 (White)			Flat-1 Flat-2 (Black) Flat-3 (White)			Flat-1 Flat-2 (Black) Flat-3 (White)		

4 Select hardware <i>View hardware details</i>	Hardware N/A	Hardware N/A	Hardware N/A	Hardware N/A

[View statement of line](#)

Product features.

- 1" Thick top
- ENVI-CT finish on wood tops
- Expandable frame matte black metal finish standard
- (6) tops, (3) black metal finish wire baskets
- Legs can be positioned for inner or outer placement
- Optional Metal accessories are center mounted, matte black metal finish is standard
- 3" Adjustable glide

NOTES

- 60" Depth Workstations feature 29" Worksurfaces
- 48" Depth Workstations feature 23" Worksurfaces

Options.

ACCESSORIES

- EA50: Personal Tray - \$270 ea.
- EA51: Document Pod & Paper Tray - \$375 ea.
- EA52: Binder Pod - \$290 ea.

POWER BLOCK

- 6PPBS: Six Pack Power Block System with Hardwire - \$1,100
- Specify hardwired or plug infeed. Plug infeed will require wire management W22 - \$130 Vertebrae (Clear) or W23 - \$135 Vertebrae (Gray)
- Includes (3) Power Blocks, (2) Jumpers and Infeed
- Each power block has 8 duplex outlets
- Plug Infeed can be daisy chained up to 16 duplex outlets on one 20 amp circuit

WORKSURFACE CLAMP MOUNT POWER

- PD-KENO: Keno power pod with clamp - \$195 ea.
- PD-TULLY: Tully power pod with clamp - \$320 ea.
- P2SECL: Seclusion Power Clamp - \$245 ea.

PREMIUM METAL FINISHES

- Specify Top Horn and Leg Metal Finish Color: \$1,355
- MFW: White, MFS: Silver, MFGG: Graphite Gray, MFSS: Salmon Sienna, MFSA: Surfin Aquavert, MFPS: Pistachio, MFOS: Oyster, MFNA: Navy, MFOL: Olive, MFGB: Grey Beige









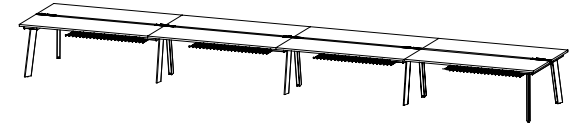



PLANK MATCH VENEER

- RPMV: Random Walnut Plank Match Veneer (Horizontal Grain with 25%+ Sap) - Add 10%. Clear coat only.

Edgeworks.

Workstations
8 Person Facing Workstation



1 Select a model w" x d" x h"	weight	Standard Veneer Top Matte Black Metal Base		Premium Veneer Top Matte Black Metal Frame		High Pressure Laminate Top Matte Black Metal Base		Thermally Fused Laminate Top Matte Black Metal Base				
		72" Worksurfaces 288 x 60 x 29 288 x 48 x 29 66" Worksurfaces 264 x 60 x 29 264 x 48 x 29 60" Worksurfaces 240 x 60 x 29 240 x 48 x 29 54" Worksurfaces 216 x 60 x 29 216 x 48 x 29	760 720 720 680 640 600 600 560	EDG28860WP908W EDG28848WP908W EDG26460WP908W EDG26448WP908W EDG24060WP908W EDG24048WP908W EDG21660WP908W EDG21648WP908W	12946 11592 12815 11461 12684 11330 12553 11199	EDG28860WP908P EDG28848WP908P EDG26460WP908P EDG26448WP908P EDG24060WP908P EDG24048WP908P EDG21660WP908P EDG21648WP908P	14241 12751 14097 12608 13953 12463 13809 12319	EDG28860WP908G EDG28848WP908G EDG26460WP908G EDG26448WP908G EDG24060WP908G EDG24048WP908G EDG21660WP908G EDG21648WP908G	11810 10631 11723 10544 11636 10456 11548 10369	EDG28860WP908M EDG28848WP908M EDG26460WP908M EDG26448WP908M EDG24060WP908M EDG24048WP908M EDG21660WP908M EDG21648WP908M	10019 9102 9954 9037 9888 8971 9823 8906	
2 Select a finish View finish details Metal finish MFMB Matte Black. Additional metal finishes are available, see options.	WLA WNW WAC WWP WEC WOC WAM WCM WWM WGW WBW WSW	TBCO TBSW TSTV TSMV TSLV TOBW WBO WMO WSO	GAC GSWL +10% GEC GWL GOC GAM GCM GWM GNW GSTV +10%	MAC MEC MOC MGW MSW MTW MWL	 Flat-1  Flat-2 (Black)  Flat-3 (White)	 Flat-1  Flat-2 (Black)  Flat-3 (White)	 Flat-1  Flat-2 (Black)  Flat-3 (White)	 Flat-1  Flat-2 (Black)  Flat-3 (White)	Hardware N/A	Hardware N/A	Hardware N/A	Hardware N/A
3 Select an edge View edge details												
4 Select hardware View hardware details												

[View statement of line](#)

Product features.

- 1" Thick top
- ENVI-CT finish on wood tops
- Expandable frame matte black metal finish standard
- (8) tops, (4) black metal finish wire baskets
- Legs can be positioned for inner or outer placement
- Optional Metal accessories are center mounted, matte black metal finish is standard
- 3" Adjustable glide

NOTES

- 60" Depth Workstations feature 29" Worksurfaces
- 48" Depth Workstations feature 23" Worksurfaces

Options.

ACCESSORIES

- EA50: Personal Tray - \$270 ea.
- EA51: Document Pod & Paper Tray - \$375 ea.
- EA52: Binder Pod - \$290 ea.

POWER BLOCK

- 8PPBS: Eight Pack Power Block System with Hardwire - \$1,500
- Specify hardwired or plug infeed. Plug infeed will require wire management W22 - \$130 Vertebrae (Clear) or W23 - \$135 Vertebrae (Gray)
- Includes (4) Power Blocks, (3) Jumpers and Infeed
- Each power block has 8 duplex outlets
- Plug Infeed can be daisy chained up to 16 duplex outlets on one 20 amp circuit

WORKSURFACE CLAMP MOUNT POWER

- PD-KENO: Keno power pod with clamp - \$195 ea.
- PD-TULLY: Tully power pod with clamp - \$320 ea.
- P2SECL: Seclusion Power Clamp - \$245 ea.

PREMIUM METAL FINISHES

- Specify Top Horn and Leg Metal Finish Color: \$990
- MFV: White, MFS: Silver, MFGG: Graphite Gray, MFSS: Salmon Sienna, MFSA: Surfin Aquavert, MFPS: Pistachio, MFOS: Oyster, MFNA: Navy, MFOL: Olive, MFGB: Grey Beige

PLANK MATCH VENEER

- RPMV: Random Walnut Plank Match Veneer (Horizontal Grain with 25%+ Sap) - Add 10%. Clear coat only.

Edgeworks.

Workstations
10 Person Facing Workstation



1 Select a model w" x d" x h"	weight	Standard Veneer Top Matte Black Metal Base		Premium Veneer Top Matte Black Metal Frame		High Pressure Laminate Top Matte Black Metal Base		Thermally Fused Laminate Top Matte Black Metal Base		
		72" Worksurfaces 360 x 60 x 29 360 x 48 x 29 66" Worksurfaces 330 x 60 x 29 330 x 48 x 29 60" Worksurfaces 300 x 60 x 29 300 x 48 x 29 54" Worksurfaces 270 x 60 x 29 270 x 48 x 29		950 EDG36060WP900W 15982 900 EDG36048WP900W 14289 900 EDG33060WP900W 15817 850 EDG33048WP900W 14125 800 EDG30060WP900W 15654 750 EDG30048WP900W 13961 750 EDG27060WP900W 15485 700 EDG27048WP900W 13792	EDG36060WP900P 17581 EDG36048WP900P 15718 EDG33060WP900P 17399 EDG33048WP900P 15538 EDG30060WP900P 17220 EDG30048WP900P 15358 EDG27060WP900P 17034 EDG27048WP900P 15172	EDG36060WP900G 12378 EDG36048WP900G 13087 EDG33060WP900G 14453 EDG33048WP900G 12978 EDG30060WP900G 14344 EDG30048WP900G 12869 EDG27060WP900G 14229 EDG27048WP900G 12755	EDG36060WP900M 12323 EDG36048WP900M 11111 EDG33060WP900M 12236 EDG33048WP900M 11024 EDG30060WP900M 12138 EDG30048WP900M 10925 EDG27060WP900M 12072 EDG27048WP900M 10860			
2 Select a finish View finish details Metal finish MFMB Matte Black. Additional metal finishes are available, see options.	WLA WNW WAC WWP WEC WOC WAM WCM WWM WGW WBW WSW	TBCO TBSW TSTV TSMV TSLV TOBW WBO WMO WSO	GAC GSLV +10% GEC GWL GOC GAM GCM GWM GNW GSTV +10%	MAC MEC MOC MGW MSW MTW MWL						
3 Select a edge View edge details	Flat-1 Flat-2 (Black) Flat-3 (White)	Flat-1 Flat-2 (Black) Flat-3 (White)	Flat-1 Flat-2 (Black) Flat-3 (White)	Flat-1 Flat-2 (Black) Flat-3 (White)						
4 Select hardware View hardware details	Hardware N/A	Hardware N/A	Hardware N/A	Hardware N/A						

[View statement of line](#)

Product features.

- 1" Thick top
- ENVI-CT finish on wood tops
- Expandable frame matte black metal finish standard
- (10) tops, (5) black metal finish wire baskets
- Legs can be positioned for inner or outer placement
- Optional Metal accessories are center mounted , matte black metal finish is standard
- 3" Adjustable glide

NOTES

- 60" Depth Workstations feature 29" Worksurfaces
- 48" Depth Workstations feature 23" Worksurfaces

Options.

ACCESSORIES

- EA50: Personal Tray - \$270 ea.
- EA51: Document Pod & Paper Tray - \$375 ea.
- EA52: Binder Pod - \$290 ea.

POWER BLOCK

- 10PPBS: Ten Pack Power Block System with Hardwire - \$1,850
- Specify hardwired or plug infeed. Plug infeed will require wire management W22 - \$130 Vertebrae (Clear) or W23 - \$135 Vertebrae (Gray)
- Includes (5) Power Blocks, (4) Jumpers and Infeed
- Each power block has 8 duplex outlets
- Plug Infeed can be daisy chained up to 16 duplex outlets on one 20 amp circuit

WORKSURFACE CLAMP MOUNT POWER

- PD-KENO: Keno power pod with clamp - \$195 ea.
- PD-TULLY: Tully power pod with clamp - \$320 ea.
- P2SECL: Seclusion Power Clamp - \$245 ea.

PREMIUM METAL FINISHES

- Specify Top Horn and Leg Metal Finish Color: \$1,190
- MFW: White, MFS: Silver, MFGG: Graphite Gray, MFSS: Salmon Sienna, MFSA: Surfin Aquavert, MFPS: Pistachio, MFOS: Oyster, MFNA: Navy, MFOL: Olive, MFGB: Grey Beige

PLANK MATCH VENEER

- RPMV: Random Walnut Plank Match Veneer (Horizontal Grain with 25%+ Sap) - Add 10%. Clear coat only.

Edgeworks.

Workstation Tops
Touchdown End Extension Top

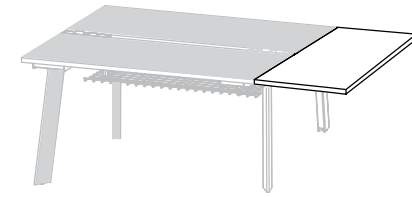

[View statement of line](#)

1 Select a model w" x d" x h"	weight	Standard Veneer Top		Premium Veneer Top		High Pressure Laminate Top		Thermally Fused Laminate Top	
		60"D Touchdown Top 18 x 60 x 29	50	EDG6018ET904W	704	EDG6018ET904P	775	EDG6018ET904G	595
48"D Touchdown Top 18 x 48 x 29	45	EDG4818ET904W	688	EDG4818ET904P	757	EDG4818ET904G	584	EDG4818ET904M	361

2 Select a finish View finish details	Standard Veneer Top		Premium Veneer Top		High Pressure Laminate Top		Thermally Fused Laminate Top	
	View finish details	WLA	WNW	TBCO	TBSW	GAC	GSLV +10%	MAC
	WAC	WWP	TSTV	TSMV	GEC	GWL	MEC	
	WEC		TSLV	TOBW	GOC		MOC	
	WOC		WBO	WMO	GAM		MGW	
	WAM		WSO		GCM		MSW	
	WCM				GWM		MTW	
	WWW				GNW		MWL	
	WGW				GSTV			
	WBW				+10%			
	WSW							

3 Select a edge View edge details	Standard Veneer Top		Premium Veneer Top		High Pressure Laminate Top		Thermally Fused Laminate Top		
	View edge details								
	Flat-1	Flat-2 (Black)	Flat-3 (White)	Flat-1	Flat-2 (Black)	Flat-3 (White)	Flat-1	Flat-2 (Black)	Flat-3 (White)

4 Select hardware View hardware details	Standard Veneer Top		Premium Veneer Top		High Pressure Laminate Top		Thermally Fused Laminate Top	
	View hardware details	Hardware	N/A	Hardware	N/A	Hardware	N/A	Hardware

Product features.

- 1" Thick top
- ENVI-CT finish on wood tops
- Touchdown extension top will fit facing workstations; 60" Depth Touchdowns match to 29" Worksurfaces, 48" D Touchdowns match to 23" Worksurfaces
- Workstation frames expand to fit touchdown end extension top

NOTES

- For field installation with existing bases

Options.

PLANK MATCH VENEER

- RPMV: Random Walnut Plank Match Veneer (Horizontal Grain with 25%+ Sap) - Add 10%. Clear coat only.







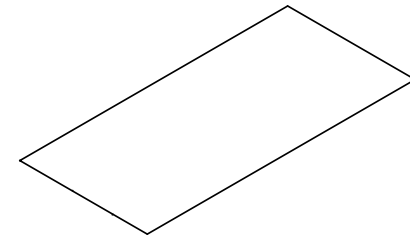

Edgeworks.

Workstation Tops

Rectangle Workstation - Top Only



[View statement of line](#)

1 Select a model w" x d" x h"	weight	Standard Veneer Top		Premium Veneer Top		High Pressure Laminate Top		Thermally Fused Laminate Top		
		72 x 29 x 1	75	EDG7229WT902W	907	EDG7229WT902P	998	EDG7229WT902G	764	EDG7229WT902M
66 x 29 x 1	70	EDG6629WT902W	890	EDG6629WT902P	979	EDG6629WT902G	754	EDG6629WT902M	469	
60 x 29 x 1	60	EDG6029WT902W	874	EDG6029WT902P	961	EDG6029WT902G	743	EDG6029WT902M	459	
54 x 29 x 1	55	EDG5429WT902W	857	EDG5429WT902P	943	EDG5429WT902G	732	EDG5429WT902M	448	
2 Select a finish View finish details		WLA	WNW	TBCO		GAC	GSLV +10%	MAC		
		WAC	WWP	TBSW		GEC	GWL	MEC		
		WEC		TSTV		GOC		MOC		
		WOC		TSMV		GAM		MGW		
		WAM		TSLV		GCM		MSW		
		WCM		TOBW		GWM		MTW		
		WWW		WBO		GNW		MWL		
		WGW		WMO		GSTV				
		WBW		WSO		+10%				
		WSW								
3 Select a edge View edge details		 Flat-1	 Flat-2 (Black)	 Flat-3 (White)	 Flat-1	 Flat-2 (Black)	 Flat-3 (White)	 Flat-1	 Flat-2 (Black)	 Flat-3 (White)
4 Select hardware View hardware details		Hardware N/A		Hardware N/A		Hardware N/A		Hardware N/A		

Product features.

- 1" Thick top
- ENVI-CT finish on wood tops

NOTES

- For field installation with existing bases

Options.

PLANK MATCH VENEER

- RPMV: Random Walnut Plank Match Veneer (Horizontal Grain with 25%+ Sap) - Add 10%. Clear coat only.

Edgeworks.

Freestanding Desk
Table Desk With Metal Bases

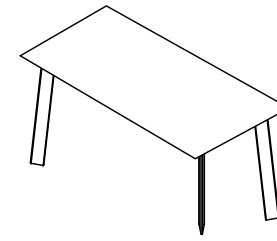

1 Select a model w" x d" x h"	weight	Standard Veneer Top Matte Black Metal Base		Premium Veneer Top Matte Black Metal Frame		High Pressure Laminate Top Matte Black Metal Base		Thermally Fused Laminate Top Matte Black Metal Base	
		72 x 30 x 29	115	EDG7230DS048W	2599	EDG7230DS048P	2859	EDG7230DS048G	2458
66 x 30 x 29	145	EDG6630DS048W	2582	EDG6630DS048P	2841	EDG6630DS048G	2446	EDG6630DS048M	2222
60 x 30 x 29	100	EDG6030DS048W	2567	EDG6030DS048P	2824	EDG6030DS048G	2436	EDG6030DS048M	2152
54 x 30 x 29	95	EDG5430DS048W	2550	EDG5430DS048P	2805	EDG5430DS048G	2424	EDG5430DS048M	2140

2 Select a finish <i>View finish details</i>	Standard Veneer Top		Premium Veneer Top		High Pressure Laminate Top		Thermally Fused Laminate Top	
	Metal finish MFMB Matte Black. Additional metal finishes are available, see options.	WLA	WNW	TBCO	GAC	GSLV +10%	MAC	MEC
	WAC	WWP	TBSW	GEC	GWL	MOC	MGW	
	WEC		TSTV	GOC		MSW	MTW	
	WOC		TSMV	GAM		MWL		
	WAM		TSLV	GCM				
	WCM		TOBW	GWM				
	WWM		WBO	GNW				
	WGW		WMO	GSTV				
	WBW		WSO	+10%				
	WSW							

3 Select a edge <i>View edge details</i>	Standard Veneer Top		Premium Veneer Top		High Pressure Laminate Top		Thermally Fused Laminate Top		
		Flat-1	Flat-2 (Black)	Flat-3 (White)	Flat-1	Flat-2 (Black)	Flat-3 (White)	Flat-1	Flat-2 (Black)
	Ledge-1 (Finished)	Ledge-2 (Black)	Ledge-3 (White)	Ledge-1 (Finished)	Ledge-2 (Black)	Ledge-3 (White)	Ledge-1 (Finished)	Ledge-2 (Black)	Ledge-3 (White)

4 Select hardware <i>View hardware details</i>	Standard Veneer Top		Premium Veneer Top		High Pressure Laminate Top		Thermally Fused Laminate Top	
		Hardware	N/A	Hardware	Hardware	Hardware	Hardware	Hardware
	N/A		N/A	N/A	N/A	N/A	N/A	

[View statement of line](#)

Product features.

- 1" Thick top
- ENVI-CT finish on wood tops
- Matte black metal finish base standard
- 3" Adjustable glide

NOTES

- Freestanding use or with return

Options.

ACCESSORIES

- K28: Articulating Keyboard w/ Mouse - \$390

GROMMETS (STANDARD LOCATION)

Specify Color and Location Right/Left - \$50 ea.

- Black: TM30-R (Left leg, right grommet), TM30-L (Right leg, left grommet)
- Silver: TM31-R (Left leg, right grommet), TM31-L (Right leg, left grommet)
- White: TM34-R (Left leg, right grommet), TM34-L (Right leg, left grommet)

GROMMETS (NON-STANDARD LOCATION)

Provide drawing w/ Grommet Location and Specify Color - \$95 ea.

- Black: TM30-NS
- Silver: TM31-NS
- White: TM34-NS

MODESTY

- MC51: Half veneer/laminate modesty - \$130

PREMIUM METAL FINISHES

- Specify Top Horn and Leg Metal Finish Color: \$630
- MFW: White, MFS: Silver, MFGG: Graphite Gray, MFSS: Salmon Sienna, MFSA: Surfing Aquavert, MFPS: Pistachio, MFOS: Oyster, MFNA: Navy, MFOL: Olive, MFGB: Grey Beige

PLANK MATCH VENEER

- RPMV: Random Walnut Plank Match Veneer (Horizontal Grain with 25%+ Sap) - Add 10%. Clear coat only.

Edgeworks.

Return
Workstation Return

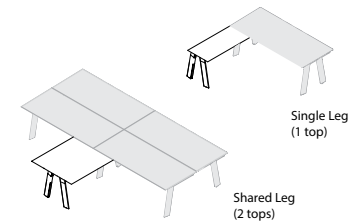

[View statement of line](#)

1 Select a model w" x d" x h"	weight	Standard Veneer Top		Premium Veneer Top		High Pressure Laminate Top		Thermally Fused Laminate Top	
Single Leg (1 top)									
48 x 23 x 29	85	EDG4823RE193W	1704	EDG4823RE193P	1875	EDG4823RE193G	1611	EDG4823RE193M	1409
42 x 23 x 29	80	EDG4223RE193W	1628	EDG4223RE193P	1791	EDG4223RE193G	1545	EDG4223RE193M	1371
36 x 23 x 29	75	EDG3623RE193W	1551	EDG3623RE193P	1707	EDG3623RE193G	1485	EDG3623RE193M	1332
Shared Leg (2 tops)									
48 x 30 x 29	150	EDG4830RE194W	2785	EDG4830RE194P	3064	EDG4830RE194G	2616	EDG4830RE194M	2228
42 x 30 x 29	140	EDG4230RE194W	2632	EDG4230RE194P	2896	EDG4230RE194G	2473	EDG4230RE194M	2152
36 x 30 x 29	130	EDG3630RE194W	2479	EDG3630RE194P	2727	EDG3630RE194G	2354	EDG3630RE194M	2075
2 Select a finish View finish details		WLA WNW WAC WWP WEC Metal finish MFMB Matte Black. Additional metal finishes are available, see options.		TBCO TBSW TSTV TSMV TSLV TOBW WBO WMO WSO		GAC GSWL +10% GEC GWL GOC GAM GCM GWM GNW GSTV +10%		MAC MEC MOC MGW MSW MTW MWL	
3 Select an edge View edge details		Flat-1 Flat-2 (Black) Flat-3 (White)		Flat-1 Flat-2 (Black) Flat-3 (White)		Flat-1 Flat-2 (Black) Flat-3 (White)		Flat-1 Flat-2 (Black) Flat-3 (White)	
4 Select hardware View hardware details		Hardware N/A		Hardware N/A		Hardware N/A		Hardware N/A	

Product features.

- 1" Thick top
- ENVI-CT finish on wood tops
- Matte black metal finish base standard
- Expandable frame
- 3" Adjustable glide

NOTES

- Shared leg is for use with 2 person inline unit
- Shared leg has two tops
- Legs can be positioned for inner or outer placement

Options.

GROMMETS (STANDARD LOCATION)

Specify Color and Location Right/Left - \$50 ea.

- Black: TM30-R (Left leg, right grommet), TM30-L (Right leg, left grommet)
- Silver: TM31-R (Left leg, right grommet), TM31-L (Right leg, left grommet)
- White: TM34-R (Left leg, right grommet), TM34-L (Right leg, left grommet)

GROMMETS (NON-STANDARD LOCATION)

Provide drawing w/ Grommet Location and Specify Color - \$95 ea.

- Black: TM30-NS
- Silver: TM31-NS
- White: TM34-NS

PREMIUM METAL FINISHES

- Specify Top Horn and Leg Metal Finish Color: \$200
- MFW: White, MFS: Silver, MFGG: Graphite Gray, MFSS: Salmon Sienna, MFSA: Surfing Aquavert, MFPS: Pistachio, MFOS: Oyster, MFNA: Navy, MFOL: Olive, MFGB: Grey Beige

PLANK MATCH VENEER

- RPMV: Random Walnut Plank Match Veneer (Horizontal Grain with 25%+ Sap) - Add 10%. Clear coat only.

Edgeworks.

Return

Workstation Return - Top Only

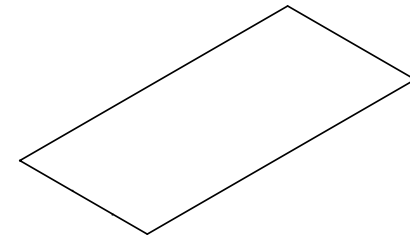

1 Select a model w" x d" x h"	weight	Standard Veneer Top		Premium Veneer Top		High Pressure Laminate Top		Thermally Fused Laminate Top	
		48 x 23 x 1	45	EDG4823WT902W	672	EDG4823WT902P	740	EDG4823WT902G	568
42 x 23 x 1	40	EDG4223WT902W	655	EDG4223WT902P	721	EDG4223WT902G	557	EDG4223WT902M	339
36 x 23 x 1	35	EDG3623WT902W	639	EDG3623WT902P	703	EDG3623WT902G	546	EDG3623WT902M	317

2 Select a finish <i>View finish details</i>	Standard Veneer Top		Premium Veneer Top		High Pressure Laminate Top		Thermally Fused Laminate Top	
		WLA	WNW	TBCO	GAC	GSLV +10%	MAC	
	WAC	WWP	TBSW	GEC	GWL	MEC		
	WEC		TSTV	GOC		MOC		
	WOC		TSMV	GAM		MGW		
	WAM		TSLV	GCM		MSW		
	WCM		TOBW	GWM		MTW		
	WWM		WBO	GNW		MWL		
	WGW		WMO	GSTV				
	WBW		WSO	+10%				
	WSW							

3 Select an edge <i>View edge details</i>	Standard Veneer Top		Premium Veneer Top		High Pressure Laminate Top		Thermally Fused Laminate Top		
		Flat-1	Flat-2 (Black)	Flat-3 (White)	Flat-1	Flat-2 (Black)	Flat-3 (White)	Flat-1	Flat-2 (Black)

4 Select hardware <i>View hardware details</i>	Standard Veneer Top		Premium Veneer Top		High Pressure Laminate Top		Thermally Fused Laminate Top	
		Hardware N/A		Hardware N/A	Hardware N/A		Hardware N/A	

[View statement of line](#)

Product features.

- 1" Thick top
- ENVI-CT finish on wood tops

NOTES

- For field installation with existing bases

Options.

GROMMETS (STANDARD LOCATION)

Specify Color and Left/Right/Center - \$50 ea.

- Black: TM30-R (Right), TM30-L (Left)
- Silver: TM31-R (Right), TM31-L (Left)
- White: TM34-R (Right), TM34-L (Left)

GROMMETS (NON-STANDARD LOCATION)

Provide drawing w/ Grommet Location and Specify Color - \$95 ea.

- Black: TM30-NS
- Silver: TM31-NS
- White: TM34-NS

PLANK MATCH VENEER

- RPMV: Random Walnut Plank Match Veneer (Horizontal Grain with 25%+ Sap) - Add 10%. Clear coat only.

Edgeworks.

Training table
Rectangular Top

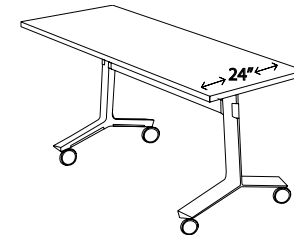

1 Select a model w" x d" x h"	weight	Standard Veneer Top Matte Black Metal Base		Premium Veneer Top Matte Black Metal Frame		High Pressure Laminate Top Matte Black Metal Base		Thermally Fused Laminate Top Matte Black Metal Base		
		84 x 24 x 28.5	230	EDG8424FN121W	2207	EDG8424FN121P	2428	EDG8424FN121G	2064	EDG8424FN121M
72 x 24 x 28.5	215	EDG7224FN121W	2174	EDG7224FN121P	2391	EDG7224FN121G	2043	EDG7224FN121M	1823	
66 x 24 x 28.5	200	EDG6624FN121W	2136	EDG6624FN121P	2350	EDG6624FN121G	2012	EDG6624FN121M	1791	
60 x 24 x 28.5	185	EDG6024FN121W	2119	EDG6024FN121P	2331	EDG6024FN121G	2001	EDG6024FN121M	1781	
54 x 24 x 28.5	170	EDG5424FN121W	2081	EDG5424FN121P	2289	EDG5424FN121G	1970	EDG5424FN121M	1749	
48 x 24 x 28.5	155	EDG4824FN121W	2064	EDG4824FN121P	2270	EDG4824FN121G	1959	EDG4824FN121M	1739	
42 x 24 x 28.5	140	EDG4224FN121W	2027	EDG4224FN121P	2230	EDG4224FN121G	1928	EDG4224FN121M	1707	
2 Select a finish <i>View finish details</i>		WLA WNW		TBCO		GAC LP01 LW01		MAC		
Metal finish MFMB Matte Black. Additional metal finishes are available, see options.		WAC WWP		TBSW		GEC LP02 LW02		MEC		
		WEC		TSTV		GOC LF01 LW04		MOC		
		WOC		TSMV		GAM LF02 LW05		MGW		
		WAM		TSLV		GCM LF03 LW06		MSW		
		WCM		TOBW		GWM LN01 LW07		MTW		
		WWM		WBO		GNW LA01 + 20%		MWL		
		WGW		WMO		GWL LA02 + 20%				
		WBW		WSO		GSTV +10%				
		WSW				GSLV +10%				
3 Select a edge <i>View edge details</i>		Flat-1	Flat-2 (Black)	Flat-3 (White)	Flat-1	Flat-2 (Black)	Flat-3 (White)	Flat-1	Flat-2 (Black)	Flat-3 (White)
4 Select hardware <i>View hardware details</i>		Hardware N/A		Hardware N/A		Hardware N/A		Hardware N/A		

View statement of line

Product features.

- 1" Thick top
- ENVI-CT Finish on wood tops
- Easy to use folding mechanism
- Matte black metal finish base standard
- 2 locking casters, 2 non-locking casters

Options.

PREMIUM METAL FINISHES

- Specify Top Horn and Leg Metal Finish Color: \$300
- MFW: White, MFS: Silver, MFGG: Graphite Gray, MFSS: Salmon Sienna, MFSA: Surfin Aquavert, MFPS: Pistachio, MFOS: Oyster, MFNA: Navy, MFOL: Olive, MFGB: Grey Beige

COVE DAISYLINK POWER

Power Pod

- PD-Cove-PKO-TT: Cove Power Unit with 2 power, 2 USB and 1 telecom plate - \$435

Infeed

- PFC72: 72" 3 prong plug power infeed - \$225
- PFHRD120: 120" hardwire whip power infeed - \$210

Jumper

- JCTT84: Jumper for 84" worksurfaces - \$145
- JCTT72: Jumper for 72" worksurfaces - \$135
- JCTT66: Jumper for 66" worksurfaces - \$130
- JCTT60: Jumper for 60" worksurfaces - \$125
- JCTT54: Jumper for 54" worksurfaces - \$120
- JCTT48: Jumper for 48" worksurfaces - \$115
- JCTT42: Jumper for 48" worksurfaces - \$110

Telecom Plate

- RJ45 (1) - \$35, RJ45 (2) - \$70, RJ45 (3) - \$105, USB (1) - \$70, USB (2) - \$140, RJ45/USB - \$105, RJ45/HDMI - \$190, HDMI/USB - \$205

Edgeworks.

Training table
Rectangular Top

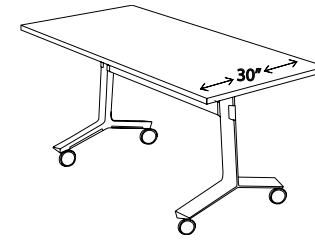

1 Select a model w" x d" x h"	weight	Standard Veneer Top Matte Black Metal Base		Premium Veneer Top Matte Black Metal Frame		High Pressure Laminate Top Matte Black Metal Base		Thermally Fused Laminate Top Matte Black Metal Base	
		84 x 30 x 28.5	245	EDG8430FN121W	2377	EDG8430FN121P	2615	EDG8430FN121G	2220
72 x 30 x 28.5	230	EDG7230FN121W	2344	EDG7230FN121P	2578	EDG7230FN121G	2199	EDG7230FN121M	1912
66 x 30 x 28.5	215	EDG6630FN121W	2306	EDG6630FN121P	2537	EDG6630FN121G	2167	EDG6630FN121M	1881
60 x 30 x 28.5	200	EDG6030FN121W	2289	EDG6030FN121P	2518	EDG6030FN121G	2157	EDG6030FN121M	1870
54 x 30 x 28.5	185	EDG5430FN121W	2251	EDG5430FN121P	2476	EDG5430FN121G	2125	EDG5430FN121M	1839
48 x 30 x 28.5	170	EDG4830FN121W	2234	EDG4830FN121P	2457	EDG4830FN121G	2115	EDG4830FN121M	1828
42 x 30 x 28.5	155	EDG4230FN121W	2197	EDG4230FN121P	2417	EDG4230FN121G	2083	EDG4230FN121M	1797
		WLA WNW WAC WWP WEC Metal finish MFMB Matte Black. Additional metal finishes are available, see options.		TBCO TBSW TSTV TSMV TSLV TOBW WBO WMO WSO		GAC LP01 LW01 GEC LP02 LW02 GOC LF01 LW04 GAM LF02 LW05 GCM LF03 LW06 GWM LN01 LW07 GNW LA01 + 20% GWL LA02 + 20% GSTV +10% GSLV +10%		MAC MEC MOC MGW MSW MTW MWL	
2 Select a finish View finish details		Flat-1 Flat-2 Flat-3 (Black) (White)		Flat-1 Flat-2 Flat-3 (Black) (White)		Flat-1 Flat-2 Flat-3 (Black) (White)		Flat-1 Flat-2 Flat-3 (Black) (White)	
3 Select an edge View edge details									
4 Select hardware View hardware details		Hardware N/A		Hardware N/A		Hardware N/A		Hardware N/A	

[View statement of line](#)

Product features.

- 1" Thick top
- ENVI-CT Finish on wood tops
- Easy to use folding mechanism
- Matte black metal finish base standard
- 2 locking casters, 2 non-locking casters

Options.

PREMIUM METAL FINISHES

- Specify Top Horn and Leg Metal Finish Color: \$300
- MFW: White, MFS: Silver, MFGG: Graphite Gray, MFSS: Salmon Sienna, MFSA: Surfin Aquavert, MFPS: Pistachio, MFOS: Oyster, MFNA: Navy, MFOL: Olive, MFGB: Grey Beige

COVE DAISYLINK POWER

Power Pod

- PD-Cove-PKO-TT: Cove Power Unit with 2 power, 2 USB and 1 telecom plate - \$435

Infeed

- PFC72: 72" 3 prong plug power infeed - \$225
- PFHRD120: 120" hardwire whip power infeed - \$210

Jumper

- JCTT84: Jumper for 84" worksurfaces - \$145
- JCTT72: Jumper for 72" worksurfaces - \$135
- JCTT66: Jumper for 66" worksurfaces - \$130
- JCTT60: Jumper for 60" worksurfaces - \$125
- JCTT54: Jumper for 54" worksurfaces - \$120
- JCTT48: Jumper for 48" worksurfaces - \$115
- JCTT42: Jumper for 48" worksurfaces - \$110

Telecom Plate

- RJ45 (1) - \$35, RJ45 (2) - \$70, RJ45 (3) - \$105, USB (1) - \$70, USB (2) - \$140, RJ45/USB - \$105, RJ45/HDMI - \$190, HDMI/USB - \$205

Edgeworks.

Training table
Rectangular Top

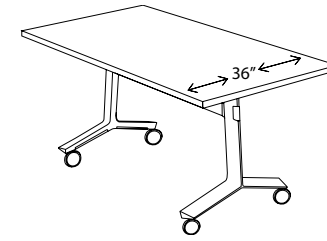

1 Select a model w" x d" x h"	weight	Standard Veneer Top Matte Black Metal Base		Premium Veneer Top Matte Black Metal Frame		High Pressure Laminate Top Matte Black Metal Base		Thermally Fused Laminate Top Matte Black Metal Base	
		84 x 36 x 28.5	260	EDG8436FN121W	2558	EDG8436FN121P	2814	EDG8436FN121G	2378
72 x 36 x 28.5	245	EDG7236FN121W	2520	EDG7236FN121P	2772	EDG7236FN121G	2353	EDG7236FN121M	2009
66 x 36 x 28.5	230	EDG6636FN121W	2480	EDG6636FN121P	2728	EDG6636FN121G	2319	EDG6636FN121M	1975
60 x 36 x 28.5	215	EDG6036FN121W	2461	EDG6036FN121P	2707	EDG6036FN121G	2307	EDG6036FN121M	1962
54 x 36 x 28.5	200	EDG5436FN121W	2421	EDG5436FN121P	2663	EDG5436FN121G	2273	EDG5436FN121M	1929
48 x 36 x 28.5	185	EDG4836FN121W	2402	EDG4836FN121P	2642	EDG4836FN121G	2261	EDG4836FN121M	1916
42 x 36 x 28.5	170	EDG4236FN121W	2363	EDG4236FN121P	2599	EDG4236FN121G	2227	EDG4236FN121M	1883

2 Select a finish <i>View finish details</i>	Metal finish MFMB Matte Black. Additional metal finishes are available, see options.		TBCO TBSW TSTV TSMV TSLV TOBW WBO WMO WSO	GAC LP01 LW01 GEC LP02 LW02 GOC LF01 LW04 GAM LF02 LW05 GCM LF03 LW06 GWM LN01 LW07 GNW LA01 + 20% GWL LA02 + 20% GSTV +10% GSLV +10%			MAC MEC MOC MGW MSW MTW MWL
	WLA WNW WAC WWP WEC WOC WAM WCM WWM WGW WBW WSW				Flat-1 Flat-2 (Black) Flat-3 (White)	Flat-1 Flat-2 (Black) Flat-3 (White)	

3 Select an edge <i>View edge details</i>	Hardware N/A		Hardware N/A			Hardware N/A		

4 Select hardware <i>View hardware details</i>	Hardware N/A		Hardware N/A			Hardware N/A		

View statement of line

Product features.

- 1" Thick top
- ENVI-CT Finish on wood tops
- Easy to use folding mechanism
- Matte black metal finish base standard
- 2 locking casters, 2 non-locking casters

Options.

PREMIUM METAL FINISHES

- Specify Top Horn and Leg Metal Finish Color: \$300
- MFW: White, MFS: Silver, MFGG: Graphite Gray, MFSS: Salmon Sienna, MFSA: Surfin Aquavert, MFPS: Pistachio, MFOS: Oyster, MFNA: Navy, MFOL: Olive, MFGB: Grey Beige

COVE DAISYLINK POWER

Power Pod

- PD-Cove-PKO-TT: Cove Power Unit with 2 power, 2 USB and 1 telecom plate - \$435

Infeed

- PFC72: 72" 3 prong plug power infeed - \$225
- PFHRD120: 120" hardwire whip power infeed - \$210

Jumper

- JCTT84: Jumper for 84" worksurfaces - \$145
- JCTT72: Jumper for 72" worksurfaces - \$135
- JCTT66: Jumper for 66" worksurfaces - \$130
- JCTT60: Jumper for 60" worksurfaces - \$125
- JCTT54: Jumper for 54" worksurfaces - \$120
- JCTT48: Jumper for 48" worksurfaces - \$115
- JCTT42: Jumper for 48" worksurfaces - \$110

Telecom Plate

- RJ45 (1) - \$35, RJ45 (2) - \$70, RJ45 (3) - \$105, USB (1) - \$70, USB (2) - \$140, RJ45/USB - \$105, RJ45/HDMI - \$190, HDMI/USB - \$205

Edgeworks.

Training table
Half Round Top

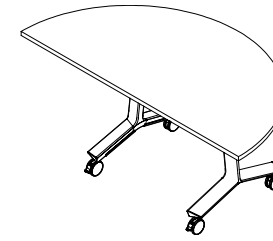

1 Select a model w" x d" x h"	weight	Standard Veneer Top	Premium Veneer Top	High Pressure Laminate Top	Thermally Fused Laminate Top	
		Matte Black Metal Base	Matte Black Metal Frame	Matte Black Metal Base	Matte Black Metal Base	
Use with 36" depth tops back to back						
72 x 36 x 28.5	230	EDG7236HR121W 2520	EDG7236HR121P 2772	EDG7236HR121G 2353	EDG7236HR121M 2009	
Use with 30" depth tops back to back						
60 x 30 x 28.5	185	EDG6030HR121W 2289	EDG6030HR121P 2518	EDG6030HR121G 2157	EDG6030HR121M 1870	
48 x 30 x 28.5	170	EDG4830HR121W 2064	EDG4830HR121P 2270	EDG4830HR121G 1959	EDG4830HR121M 1739	
2 Select a finish <i>View finish details</i> Metal finish MFMB Matte Black. Additional metal finishes are available, see options.		WLA WNW WAC WWP WEC WOC WAM WCM WWM WGW WBW WSW	TBCO TBSW TSTV TSMV TSLV TOBW WBO WMO WSO	GAC LP01 LW01 GEC LP02 LW02 GOC LF01 LW04 GAM LF02 LW05 GCM LF03 LW06 GWM LN01 LW07 GNW LA01 + 20% GWL LA02 + 20% GSTV +10% GSLV +10%	MAC MEC MOC MGW MSW MTW MWL	
	3 Select an edge <i>View edge details</i>	Flat-1	Flat-1	Flat-1	Flat-1	Flat-1
		Flat-2 (Black)	Flat-2 (Black)	Flat-2 (Black)	Flat-2 (Black)	Flat-2 (Black)
		Flat-3 (White)	Flat-3 (White)	Flat-3 (White)	Flat-3 (White)	Flat-3 (White)
	4 Select hardware <i>View hardware details</i>	Hardware N/A	Hardware N/A	Hardware N/A	Hardware N/A	Hardware N/A

[View statement of line](#)

Product features.

- 1" Thick top
- ENVI-CT Finish on wood tops
- Easy to use folding mechanism
- Matte black metal finish base standard
- 2 locking casters, 2 non-locking casters

Options.

PREMIUM METAL FINISHES

- Specify Top Horn and Leg Metal Finish Color: \$300
- MFW: White, MFS: Silver, MFGG: Graphite Gray, MFSS: Salmon Sienna, MFSA: Surfin Aquavert, MFPS: Pistachio, MFOS: Oyster, MFNA: Navy, MFOL: Olive, MFGB: Grey Beige

COVE DAISYLINK POWER

- Power Pod
- PD-Cove-PKO-TT: Cove Power Unit with 2 power, 2 USB and 1 telecom plate - \$435

INFEEED

- PFC72: 72" 3 prong plug power infeed - \$225
- PFHRD120: 120" hardwire whip power infeed - \$210

JUMPER

- JCTT84: Jumper for 84" worksurfaces - \$145
- JCTT72: Jumper for 72" worksurfaces - \$135
- JCTT66: Jumper for 66" worksurfaces - \$130
- JCTT60: Jumper for 60" worksurfaces - \$125
- JCTT54: Jumper for 54" worksurfaces - \$120
- JCTT48: Jumper for 48" worksurfaces - \$115
- JCTT42: Jumper for 48" worksurfaces - \$110

TELECOM PLATE

- RJ45 (1) - \$35, RJ45 (2) - \$70, RJ45 (3) - \$105, USB (1) - \$70, USB (2) - \$140, RJ45/USB - \$105, RJ45/HDMI - \$190, HDMI/USB - \$205

Edgeworks.

Training Table Top
Corner Top

Top view

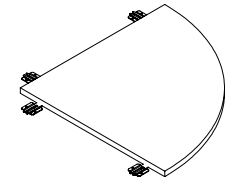
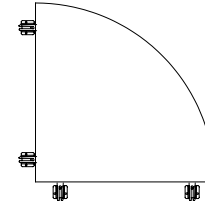

1 Select a model
w" x d" x h"

weight	Standard Veneer Top	Premium Veneer Top	High Pressure Laminate Top	Thermally Fused Laminate Top
36 x 36	35 EDG3636CT121W 675	EDG3636CT121P 743	EDG3636CT121G 574	EDG3636CT121M 428
30 x 30	25 EDG3030CT121W 640	EDG3030CT121P 704	EDG3030CT121G 544	EDG3030CT121M 410
24 x 24	20 EDG2424CT121W 605	EDG2424CT121P 666	EDG2424CT121G 515	EDG2424CT121M 392

View statement of line

Product features.

- 1" Thick top
- ENVI-CT Finish on wood tops

NOTES

- Corner tops connect with ganging device

2 Select a finish
View finish details

WLA WNW
WAC WWP
WEC
WOC
WAM
WCM
WWM
WGW
WBW
WSW

TBCO
TBSW
TSTV
TSMV
TSLV
TOBW
WBO
WMO
WSO

GAC LP01 LW01
GEC LP02 LW02
GOC LF01 LW04
GAM LF02 LW05
GCM LF03 LW06
GWM LN01 LW07
GNW LA01 + 20%
GWL LA02 + 20%
GSTV +10%
GSLV +10%

MAC
MEC
MOC
MGW
MSW
MTW
MWL

3 Select a edge
View edge details

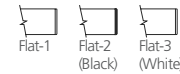
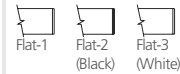

4 Select hardware
View hardware details

Hardware
N/A

Hardware
N/A

Hardware
N/A

Hardware
N/A

Edgeworks.

Privacy Screen
Folding modesty

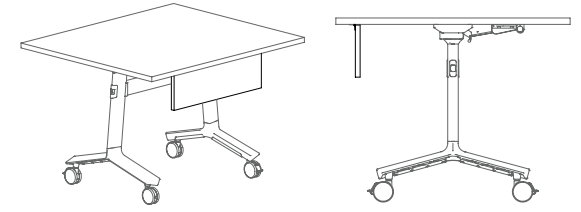

View statement of line

1 Select a model		Frosted Acrylic Privacy Screen	High Pressure Laminate Screen	Thermally Fused Laminate Screen
w" x d" x h"	weight			
For 84" & 72" Worksurfaces				
57 x .75 x 8	8	EDG5708MS588A 260	EDG5708MS588G 270	EDG5708MS588M 220
For 66" & 60" Worksurfaces				
46 x .75 x 8	7	EDG4608MS588A 235	EDG4608MS588G 260	EDG4608MS588M 210
For 54" & 48" Worksurfaces				
35 x .75 x 8	6	EDG3508MS588A 210	EDG3508MS588G 250	EDG3508MS588M 200
For 42" Worksurfaces				
24 x .75 x 8	5	EDG2408MS588A 185	EDG2408MS588G 240	EDG2408MS588M 190
2 Select a finish		AF	GAC LP01 LW01 GEC LP02 LW02 GOC LF01 LW04 GAM LF02 LW05 GCM LF03 LW06 GWM LN01 LW07 GNW LA01 + 20% GWL LA02 + 20% GSTV +10% GSLV +10%	MAC MEC MOC MGW MSW MTW MWL
3 Select a edge		Edge N/A	Edge N/A	Edge N/A
4 Hardware		N/A	Hardware N/A	Hardware N/A

Product features.

- 3/4" Thick modesty

NOTES







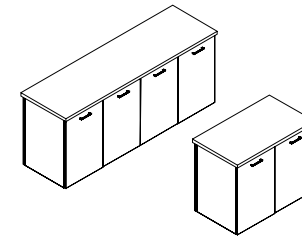























- When using the folding mechanism the modesty swings down to align with the top. Allowing the tables to nest while stowed away

Edgeworks.

Full Pedestal Credenzas
Storage Credenza



[View statement of line](#)

1 Select a model w" x d" x h"	weight	Standard Veneer Top Standard Veneer Chassis		Premium Veneer Top Premium Veneer Chassis		High Pressure Laminate Top Standard Veneer Chassis		Thermally Fused Laminate Top Thermally Fused Laminate Chassis	
		Double Storage 72 x 24 x 29 66 x 24 x 29 60 x 24 x 29 Single Storage 36 x 24 x 29		EDG7224CA125W 3259 EDG6624CA125W 3031 EDG6024CA125W 2932	EDG7224CA125P 3585 EDG6624CA125P 3334 EDG6024CA125P 3226	EDG7224CA125G 3259 EDG6624CA125G 3031 EDG6024CA125G 2932	EDG3624CA125W 1838	EDG3624CA125P 2022	EDG3624CA125G 1838
2 Select a finish View finish details		WLA WNW WAC WWP WEC WOC WAM WCM WWM WGW WBW WSW	TBCO TBSW TSTV TSMV TSLV TOBW WBO WMO WSO	GAC GSLV +10% GEC GWL GOC GAM GCM GWM GNW GSTV +10%		MAC MEC MOC MGW MSW MTW MWL			
3 Select a edge View edge details		 Flat-1  Flat-2 (Black)  Flat-3 (White)	 Flat-1  Flat-2 (Black)  Flat-3 (White)	 Flat-1  Flat-2 (Black)  Flat-3 (White)  Ledge-1 (Finished)  Ledge-2 (Black)  Ledge-3 (White)		 Flat-1  Flat-2 (Black)  Flat-3 (White)			
4 Select hardware View hardware details		 PL-115 Matte Black  PL-116 Matte Nickel  PL-260 Anodized Aluminum  PL-261 White	 PL-115 Matte Black  PL-116 Matte Nickel  PL-210 Anodized Aluminum  PL-261 White	 PL-115 Matte Black  PL-116 Matte Nickel  PL-260 Anodized Aluminum  PL-261 White		 PL-115 Matte Black  PL-116 Matte Nickel  PL-210 Anodized Aluminum  PL-261 White			

Product features.

- Black adjustable shelf behind door set

NOTES

- "M" Styles have matching "M" Finish Shelf
- All units are standard w/ flush ends
- Unit not designed for open plan use, standard with unfinished back. Select OPB Option for Open Plan application.

Options.

DOOR

- D2: Door Lock - \$100 per door set
- D6: Delete doors - n/c
- D6A: "W"/"G" Styles - Delete Doors and replace black laminate shelf with finished shelf - n/c
- D9SC: Soft Close Door Hinges - \$20 per door
- WPD3061: Designer White - \$80 per door

GROMMETS (STANDARD LOCATION)

- Specify Color and Location Right/Left - \$50 ea.
- Black: TM30-R (Right), TM30-L (Left), TM30-C (Center)
 - Silver: TM31-R (Right), TM31-L (Left), TM31-C (Center)
 - White: TM34-R (Right), TM34-L (Left), TM34-C (Center)

GROMMETS (NON-STANDARD LOCATION)

- Provide drawing w/ Grommet Location and Specify Color - \$95 ea.
- Black: TM30-NS
 - Silver: TM31-NS
 - White: TM34-NS

GROMMETS (VERTICAL SURFACE)

- Standard Location - \$50 ea.
- Black Plastic Vertical Surface: TM50-C (Bottom Center)

NON-STANDARD LOCATION - \$95 EA.

#NAME?

OPEN PLAN – FINISHED BACK

- OPB: "W" "G" Style - Modify Unit for Open Plan Application - \$195
- OPB: "M" Style - Modify Unit for Open Plan Application - \$95 Shelf
- S25: Replace Black Laminate Shelf with Finished Shelf - \$80 per shelf ("W" styles only)

Edgeworks.

Pedestals

Open Plan Mobile Desk Pedestal With Casters

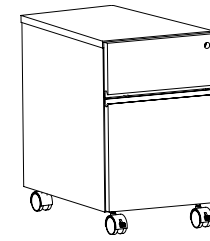

1 Select a model w" x d" x h"	weight	Standard Veneer Top Standard Veneer Chassis		Premium Veneer Top Premium Veneer Chassis		High Pressure Laminate Top Standard Veneer Chassis		Thermally Fused Laminate Top Thermally Fused Laminate Chassis																																																																																																														
		Box/File Pedestal 16 x 18 x 22	55	EDG1618PD423W	1201	EDG1618PD423P	1322	"G" Option N/A		EDG1618PD423M	1016																																																																																																											
<p>2 Select a finish <i>View finish details</i></p> <table border="0"> <tr> <td>WLA</td> <td>WNW</td> <td>TBCO</td> <td>GAC</td> <td>GSLV +10%</td> <td>MAC</td> </tr> <tr> <td>WAC</td> <td>WWP</td> <td>TBSW</td> <td>GEC</td> <td>GWL</td> <td>MEC</td> </tr> <tr> <td>WEC</td> <td></td> <td>TSTV</td> <td>GOC</td> <td></td> <td>MOC</td> </tr> <tr> <td>WOC</td> <td></td> <td>TSMV</td> <td>GAM</td> <td></td> <td>MGW</td> </tr> <tr> <td>WAM</td> <td></td> <td>TSLV</td> <td>GCM</td> <td></td> <td>MSW</td> </tr> <tr> <td>WCM</td> <td></td> <td>TOBW</td> <td>GWM</td> <td></td> <td>MTW</td> </tr> <tr> <td>WWM</td> <td></td> <td>WBO</td> <td>GNW</td> <td></td> <td>MWL</td> </tr> <tr> <td>WGW</td> <td></td> <td>WMO</td> <td>GSTV</td> <td></td> <td></td> </tr> <tr> <td>WBW</td> <td></td> <td>WSO</td> <td>+10%</td> <td></td> <td></td> </tr> <tr> <td>WSW</td> <td></td> <td></td> <td></td> <td></td> <td></td> </tr> </table> <p>3 Select a edge <i>View edge details</i></p> <table border="0"> <tr> <td>Flat-1</td> <td>Flat-2 (Black)</td> <td>Flat-3 (White)</td> <td>Flat-1</td> <td>Flat-2 (Black)</td> <td>Flat-3 (White)</td> <td>Flat-1</td> <td>Flat-2 (Black)</td> <td>Flat-3 (White)</td> <td>Flat-1</td> <td>Flat-2 (Black)</td> <td>Flat-3 (White)</td> </tr> <tr> <td>Ledge-1 (Finished)</td> <td>Ledge-2 (Black)</td> <td>Ledge-3 (White)</td> <td>Ledge-1 (Finished)</td> <td>Ledge-2 (Black)</td> <td>Ledge-3 (White)</td> <td>Ledge-1 (Finished)</td> <td>Ledge-2 (Black)</td> <td>Ledge-3 (White)</td> <td>Ledge-1 (Finished)</td> <td>Ledge-2 (Black)</td> <td>Ledge-3 (White)</td> </tr> </table> <p>4 Select hardware <i>View hardware details</i></p> <table border="0"> <tr> <td>PL-115 Matte Black</td> <td>PL-116 Matte Nickel</td> <td>PL-210 Anodized Aluminum</td> <td>PL-115 Matte Black</td> <td>PL-116 Matte Nickel</td> <td>PL-210 Anodized Aluminum</td> <td>PL-115 Matte Black</td> <td>PL-116 Matte Nickel</td> <td>PL-210 Anodized Aluminum</td> <td>PL-115 Matte Black</td> <td>PL-116 Matte Nickel</td> <td>PL-210 Anodized Aluminum</td> </tr> <tr> <td>PL-260 Anodized Aluminum</td> <td>PL-261 White</td> <td>Finger Pull "W"/"G"</td> <td>PL-260 Anodized Aluminum</td> <td>PL-261 White</td> <td>Finger Pull "W"/"G"</td> <td>PL-260 Anodized Aluminum</td> <td>PL-261 White</td> <td>Finger Pull "W"/"G"</td> <td>PL-260 Anodized Aluminum</td> <td>PL-261 White</td> <td>Finger Pull "W"/"G"</td> </tr> </table>											WLA	WNW	TBCO	GAC	GSLV +10%	MAC	WAC	WWP	TBSW	GEC	GWL	MEC	WEC		TSTV	GOC		MOC	WOC		TSMV	GAM		MGW	WAM		TSLV	GCM		MSW	WCM		TOBW	GWM		MTW	WWM		WBO	GNW		MWL	WGW		WMO	GSTV			WBW		WSO	+10%			WSW						Flat-1	Flat-2 (Black)	Flat-3 (White)	Flat-1	Flat-2 (Black)	Flat-3 (White)	Flat-1	Flat-2 (Black)	Flat-3 (White)	Flat-1	Flat-2 (Black)	Flat-3 (White)	Ledge-1 (Finished)	Ledge-2 (Black)	Ledge-3 (White)	Ledge-1 (Finished)	Ledge-2 (Black)	Ledge-3 (White)	Ledge-1 (Finished)	Ledge-2 (Black)	Ledge-3 (White)	Ledge-1 (Finished)	Ledge-2 (Black)	Ledge-3 (White)	PL-115 Matte Black	PL-116 Matte Nickel	PL-210 Anodized Aluminum	PL-115 Matte Black	PL-116 Matte Nickel	PL-210 Anodized Aluminum	PL-115 Matte Black	PL-116 Matte Nickel	PL-210 Anodized Aluminum	PL-115 Matte Black	PL-116 Matte Nickel	PL-210 Anodized Aluminum	PL-260 Anodized Aluminum	PL-261 White	Finger Pull "W"/"G"	PL-260 Anodized Aluminum	PL-261 White	Finger Pull "W"/"G"	PL-260 Anodized Aluminum	PL-261 White	Finger Pull "W"/"G"	PL-260 Anodized Aluminum	PL-261 White	Finger Pull "W"/"G"
WLA	WNW	TBCO	GAC	GSLV +10%	MAC																																																																																																																	
WAC	WWP	TBSW	GEC	GWL	MEC																																																																																																																	
WEC		TSTV	GOC		MOC																																																																																																																	
WOC		TSMV	GAM		MGW																																																																																																																	
WAM		TSLV	GCM		MSW																																																																																																																	
WCM		TOBW	GWM		MTW																																																																																																																	
WWM		WBO	GNW		MWL																																																																																																																	
WGW		WMO	GSTV																																																																																																																			
WBW		WSO	+10%																																																																																																																			
WSW																																																																																																																						
Flat-1	Flat-2 (Black)	Flat-3 (White)	Flat-1	Flat-2 (Black)	Flat-3 (White)	Flat-1	Flat-2 (Black)	Flat-3 (White)	Flat-1	Flat-2 (Black)	Flat-3 (White)																																																																																																											
Ledge-1 (Finished)	Ledge-2 (Black)	Ledge-3 (White)	Ledge-1 (Finished)	Ledge-2 (Black)	Ledge-3 (White)	Ledge-1 (Finished)	Ledge-2 (Black)	Ledge-3 (White)	Ledge-1 (Finished)	Ledge-2 (Black)	Ledge-3 (White)																																																																																																											
PL-115 Matte Black	PL-116 Matte Nickel	PL-210 Anodized Aluminum	PL-115 Matte Black	PL-116 Matte Nickel	PL-210 Anodized Aluminum	PL-115 Matte Black	PL-116 Matte Nickel	PL-210 Anodized Aluminum	PL-115 Matte Black	PL-116 Matte Nickel	PL-210 Anodized Aluminum																																																																																																											
PL-260 Anodized Aluminum	PL-261 White	Finger Pull "W"/"G"	PL-260 Anodized Aluminum	PL-261 White	Finger Pull "W"/"G"	PL-260 Anodized Aluminum	PL-261 White	Finger Pull "W"/"G"	PL-260 Anodized Aluminum	PL-261 White	Finger Pull "W"/"G"																																																																																																											

View statement of line

Product features.

- Anti-tilt safety feature
- Finished all sides and top - open plan
- Full extension drawers - locking
- 3" Hollow wheel caster

Options.

CUSHION

- BC16: Bench Cushion
- Specify fabric grade (1 yd. required)

DRAWER

- P33: Wood Drawer Upgrade - \$45 per drawer

BC16 Cushion fabric grades.

COM	COL	1	2	3
224	N/A	261	279	297
4	5	6	7	8
315	333	351	369	387
9	10	11/L1	12	13/L2
405	423	441	459	495

Edgeworks.

Pedestals

Open Plan Mini Mobile Desk Pedestal With Casters

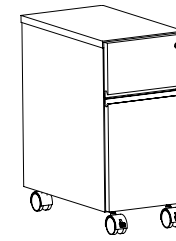

[View statement of line](#)

1 Select a model w" x d" x h"	weight	Standard Veneer Top Standard Veneer Chassis		Premium Veneer Top Premium Veneer Chassis		High Pressure Laminate Top Standard Veneer Chassis		Thermally Fused Laminate Top Thermally Fused Laminate Chassis	
		Box/File Mini Pedestal 10 x 18 x 22	40	EDG1018PD423W	1141	EDG1018PD423P	1256	"G" Option N/A	EDG1018PD423M
2 Select a finish View finish details		WLA WNW WAC WWP WEC WOC WAM WCM WWM WGW WBW WSW		TBCO TBSW TSTV TSMV TSLV TOBW WBO WMO WSO		GAC GSWL +10% GEC GWL GOC GAM GCM GWM GNW GSTV +10%		MAC MEC MOC MGW MSW MTW MWL	
3 Select a edge View edge details		Flat-1 Flat-2 (Black) Flat-3 (White) Ledge-1 (Finished) Ledge-2 (Black) Ledge-3 (White)		Flat-1 Flat-2 (Black) Flat-3 (White) Ledge-1 (Finished) Ledge-2 (Black) Ledge-3 (White)		Flat-1 Flat-2 (Black) Flat-3 (White) Ledge-1 (Finished) Ledge-2 (Black) Ledge-3 (White)		Flat-1 Flat-2 (Black) Flat-3 (White)	
4 Select hardware View hardware details		PL-115 Matte Black PL-116 Matte Nickel PL-260 Anodized Aluminum PL-261 White Finger Pull "W"/"G"		PL-115 Matte Black PL-116 Matte Nickel PL-210 Anodized Aluminum Finger Pull "W"/"G"		PL-115 Matte Black PL-116 Matte Nickel PL-210 Anodized Aluminum Finger Pull "W"/"G"		PL-115 Matte Black PL-116 Matte Nickel PL-210 Anodized Aluminum Finger Pull "W"/"G"	

Product features.

- Anti-tilt safety feature
- Finished all sides and top - open plan
- Full extension drawers - locking
- 3" Hollow wheel caster

Options.

CUSHION

- BC10: Bench Cushion
- Specify fabric grade (.5 yd. required)

DRAWER

- P33: Wood Drawer Upgrade - \$45 per drawer

BC10 Cushion fabric grades.

COM	COL	1	2	3
203	N/A	240	258	276
4	5	6	7	8
294	312	330	348	366
9	10	11/L1	12	13/L2
384	402	420	438	474

Edgeworks.

Privacy Screen

Fabric Inline & Facing Screen

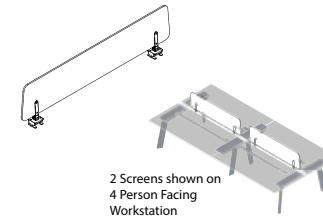

[View statement of line](#)

1	Select a model	Privacy Screen			
	w" x d" x h"	weight			
	Inline Workstation Screens				
	42 x 1 x 12.75	10	EDG4213PIS603	475	
	Facing Workstation Central Screens				
	42 x 1 x 12.75	10	EDG4213PFS603	475	
2	Select a finish	MFMB			
	View finish details				
	Metal finish				
	MFMB Matte Black.				
	Additional metal finishes are available, see options.				
3	Select a edge	Edge			
	View edge details	N/A			
4	Select hardware	Hardware			
	View hardware details	N/A			

Product features.

- Fabric panels are double sided with angled sides
- Panels are mounted on die cast space blocks between workstations
- Specify only one between two facing units
- Mounting brackets are matte black metal finish

Options.

PREMIUM METAL FINISHES

- Specify Screen Brackets Metal Finish Color: \$55
- MFW: White, MFS: Silver, MFGG: Graphite Gray, MFSS: Salmon Sienna, MFSA: Surfin Aquavert, MFPS: Pistachio, MFOS: Oyster, MFNA: Navy, MFOL: Olive, MFGB: Grey Beige

Screen fabric grades.

COM	COL	1	2	3
463	N/A	523	553	583
4	5	6	7	8
613	643	673	703	733
9	10	11	12	13
763	793	823	853	913

Edgeworks.

Privacy Screen
Acrylic Inline & Facing Screen

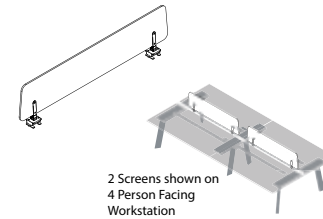

[View statement of line](#)

1 Select a model w" x d" x h"	weight	Privacy Screen			
Inline Workstation Screens 42 x .5 x 12.75	10	EDG4213PIS601 464			
Facing Workstation Central Screens 42 x .5 x 12.75	10	EDG4213PFS601 464			
2 Select a finish View finish details Metal finish MFMB Matte Black. Additional metal finishes are available, see options.		MFMB			
3 Select a edge View edge details		Edge N/A			
4 Select hardware View hardware details		Hardware N/A			

Product features.

- Acrylic panels are double sided with angled sides
- Panels are mounted on die cast space blocks between workstations
- Specify only one between two facing units
- Acrylic panels are opaque white
- Mounting brackets are matte black metal finish

Options.

PREMIUM METAL FINISHES

- Specify Screen Brackets Metal Finish Color: \$55
- MFW: White, MFS: Silver, MFGG: Graphite Gray, MFSS: Salmon Sienna, MFSA: Surfin Aquavert, MFPS: Pistachio, MFOS: Oyster, MFNA: Navy, MFOL: Olive, MFGB: Grey Beige

Edgeworks.

Privacy Screen

Acoustic Inline & Facing Central Screen

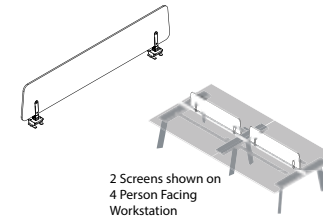

[View statement of line](#)

1 Select a model w" x d" x h"	weight	Privacy Screen			
Inline Workstation Screens 42 x .5 x 12.75	10	EDG4213PIS602 536			
Facing Workstation Central Screens 42 x .5 x 12.75	10	EDG4213PFS602 536			
2 Select a finish View finish details Metal finish MFMB Matte Black. Additional metal finishes are available, see options.		MFMB			
3 Select a edge View edge details		Edge N/A			
4 Select acoustic color View hardware details		SCG SHG			

Product features.

- Acoustic panels are double sided with angled sides
- Panels are mounted on die cast space blocks between workstations
- Specify only one between two facing units
- Acoustic material panels are light gray
- Mounting brackets are matte black metal finish

Options.

PREMIUM METAL FINISHES

- Specify Screen Brackets Metal Finish Color: \$55
- MFW: White, MFS: Silver, MFGG: Graphite Gray, MFSS: Salmon Sienna, MFSA: Surfin Aquavert, MFPS: Pistachio, MFOS: Oyster, MFNA: Navy, MFOL: Olive, MFGB: Grey Beige

Edgeworks.

Interpersonal Screen
Fabric Interpersonal Screen

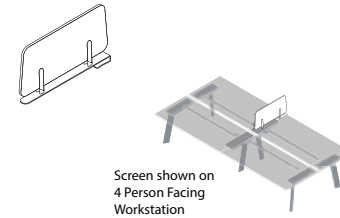

[View statement of line](#)

1	Select a model	Interpersonal Screen			
	w" x d" x h"	weight			
	24 x .5 x 12.75	5	EDG2413PS603	317	
2	Select a finish	MFMB			
	View finish details				
	Metal finish MFMB Matte Black. Additional metal finishes are available, see options.				
3	Select a edge	Edge			
	View edge details	N/A			
4	Select hardware	Hardware			
	View hardware details	N/A			

Product features.

- Fabric panels are double sided with angled sides
- Panels are mounted on die cast space blocks between workstations
- Specify only one between two facing units
- Mounting brackets are matte black metal finish

Options.

PREMIUM METAL FINISHES

- Specify Screen Brackets Metal Finish Color: \$55
- MFW: White, MFS: Silver, MFGG: Graphite Gray, MFSS: Salmon Sienna, MFSA: Surfin Aquavert, MFPS: Pistachio, MFOS: Oyster, MFNA: Navy, MFOL: Olive, MFGB: Grey Beige

Screen fabric grades

COM	COL	1	2	3
313	N/A	353	373	393
4	5	6	7	8
413	433	453	473	493
9	10	11	12	13
513	533	553	573	613

Edgeworks.

Interpersonal Screen
Acrylic Interpersonal Screen

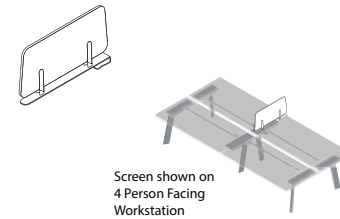

1 Select a model		Interpersonal Screen		View statement of line	
w" x d" x h"	weight				
24 x .5 x 12.75	5	EDG2413PS604	311		
2 Select a finish		MFMB			
View finish details					
Metal finish MFMB Matte Black. Additional metal finishes are available, see options.					
3 Select a edge		Edge N/A			
View edge details					
4 Select hardware		Hardware N/A			
View hardware details					

Product features.

- Acrylic panels are double sided with angled sides
- Specify only one between two facing units
- Acrylic panels are opaque white
- Mounting brackets are matte black metal finish

Options.

PREMIUM METAL FINISHES

- Specify Screen Brackets Metal Finish Color: \$55
- MFW: White, MFS: Silver, MFGG: Graphite Gray, MFSS: Salmon Sienna, MFSA: Surfin Aquavert, MFPS: Pistachio, MFOS: Oyster, MFNA: Navy, MFOL: Olive, MFGB: Grey Beige

Edgeworks.

Interpersonal Screen
Acoustic Material Interpersonal Screen

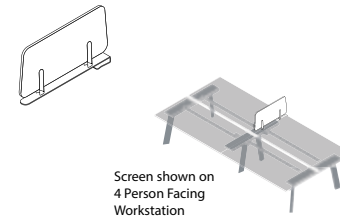

[View statement of line](#)

1	Select a model	Interpersonal Screen			
	w" x d" x h"				
	24 x .5 x 12.75	5	EDG2413PS602	361	
2	Select a finish	MFMB			
	View finish details				
	Metal finish MFMB Matte Black. Additional metal finishes are available, see options.				
3	Select a edge	Edge N/A			
	View edge details				
4	Select acoustic color	SCG SHG			
	View hardware details				

Product features.

- Acoustic panels are double sided with angled sides
- Panels are mounted on die cast space blocks between workstations
- Specify only one between two inline units
- Acoustic material panels are light gray
- Mounting brackets are matte black metal finish

Options.

PREMIUM METAL FINISHES

- Specify Screen Brackets Metal Finish Color: \$55
- MFW: White, MFS: Silver, MFGG: Graphite Gray, MFSS: Salmon Sienna, MFSA: Surfin Aquavert, MFPS: Pistachio, MFOS: Oyster, MFNA: Navy, MFOL: Olive, MFGB: Grey Beige

Edgeworks.

Single Height Wall Hung Overheads
14" D Panel Doors - 1/2 Section

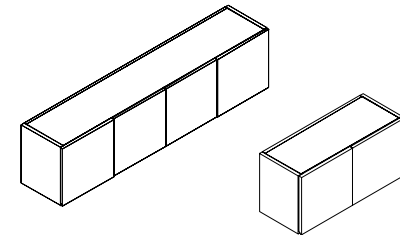

1 Select a model w" x d" x h"

weight	Standard Veneer	Premium Veneer	High Pressure Laminate	Thermally Fused Laminate
4 Door / 2 Section				
78 x 14 x 18	195 EDG7818WH330W 2997	EDG7818WH330P 3297	"G" Option N/A	EDG7818WH330M 1578
72 x 14 x 18	180 EDG7218WH330W 2506	EDG7218WH330P 2757	"G" Option N/A	EDG7218WH330M 1458
66 x 14 x 18	160 EDG6618WH330W 2468	EDG6618WH330P 2715	"G" Option N/A	EDG6618WH330M 1414
60 x 14 x 18	135 EDG6018WH330W 2429	EDG6018WH330P 2672	"G" Option N/A	EDG6018WH330M 1371
48 x 14 x 18	125 EDG4818WH330W 1856	EDG4818WH330P 2042	"G" Option N/A	EDG4818WH330M 1305
2 Door / 1 Section				
42 x 14 x 18	95 EDG4218WH330W 1624	EDG4218WH330P 1787	"G" Option N/A	EDG4218WH330M 1117
36 x 14 x 18	75 EDG3618WH330W 1393	EDG3618WH330P 1533	"G" Option N/A	EDG3618WH330M 929

View statement of line

2 Select a finish *View finish details*

WLA WNW
WAC WWP
WEC
WOC
WAM
WCM
WWM
WGW
WBW
WSW

TBCO
TBSW
TSTV
TSMV
TSLV
TOBW
WBO
WMO
WSO

GAC GSLV +10%
GEC GWL
GOC
GAM
GCM
GWM
GNW
GSTV
+10%

MAC
MEC
MOC
MGW
MSW
MTW
MWL

3 Select an edge *View edge details*

Edge
N/A

Edge
N/A

Edge
N/A

Edge
N/A

4 Select hardware *View hardware details*

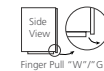
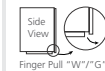
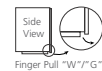

Product features.

- Doors fully matched set
- Finished top
- Interior cabinet depth 12"
- Mounting wall rail included
- Panel doors with concealed finger pull

NOTES

- All units are standard w/ flush ends
- Proper installation is critical to ensure safety from possible falling cabinets. The factory assumes no liability for damage or injury from The following: installation into non-load bearing or unlevel walls. Improper fasteners used in installation. Overloading of cabinets resulting in failures of wall and surrounding structures, fasteners, or cabinet construction. Misuse of cabinets for intended purposes.

Options.

DOOR

- D2: Door Lock - \$100 per door set
- D6: Delete doors - n/c
- D9SC: Soft Close Door Hinges - \$20 per door
- WPD3061: Designer White - \$80 per door

RECESSED TASK LIGHT

- LT-LED24R: 24" LED Task light - \$190
- LT-LED48R: 48" LED Task light - \$245
- LT-LED60R: 60" LED Task light - \$310
- LT-LED72R: 72" LED Task light - \$335

Edgeworks.

Single Height Wall Hung Overheads

14" D Silverluma Frame / Frosted Doors - 1/2 Section

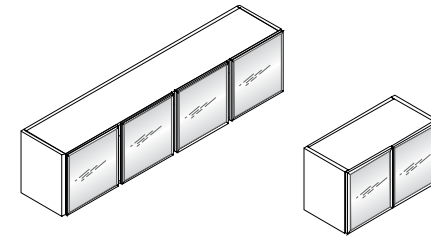

1 Select a model w" x d" x h"

weight	Standard Veneer		Premium Veneer		High Pressure Laminate		Thermally Fused Laminate	
4 Door / 2 Section								
78 x 14 x 18	195	EDG7818WH331W 3478	EDG7818WH331P 3826	"G" Option N/A	EDG7818WH331M 1846			
72 x 14 x 18	180	EDG7218WH331W 2905	EDG7218WH331P 3196	"G" Option N/A	EDG7218WH331M 1720			
66 x 14 x 18	160	EDG6618WH331W 2812	EDG6618WH331P 3094	"G" Option N/A	EDG6618WH331M 1676			
60 x 14 x 18	135	EDG6018WH331W 2725	EDG6018WH331P 2998	"G" Option N/A	EDG6018WH331M 1633			
48 x 14 x 18	125	EDG4818WH331W 2083	EDG4818WH331P 2292	"G" Option N/A	EDG4818WH331M 1572			
2 Door / 1 Section								
42 x 14 x 18	95	EDG4218WH331W 2001	EDG4218WH331P 2202	"G" Option N/A	EDG4218WH331M 1418			
36 x 14 x 18	75	EDG3618WH331W 1589	EDG3618WH331P 1748	"G" Option N/A	EDG3618WH331M 1038			
2 Select a finish <i>View finish details</i>								
	WLA	WNW	TBCO	GAC	GSLV +10%	MAC		
	WAC	WWP	TBSW	GEC	GWL	MEC		
	WEC		TSTV	GOC		MOC		
	WOC		TSMV	GAM		MGW		
	WAM		TSLV	GCM		MSW		
	WCM		TOBW	GWM		MTW		
	WWM		WBO	GNW		MWL		
	WGW		WMO	GSTV				
	WBW		WSO	+10%				
	WSW							
3 Select an edge <i>View edge details</i>								
	Edge		Edge	Edge		Edge		
	N/A		N/A	N/A		N/A		
4 Select hardware <i>View hardware details</i>								
								
		Finger Pull "W"/"G"		Finger Pull "W"/"G"		Finger Pull "W"/"G"		Finger Pull "W"/"G"

View statement of line

Product features.

- Finished top
- Interior cabinet depth 12"
- Mounting wall rail included

NOTES

- All units are standard w/ flush ends
- Proper installation is critical to ensure safety from possible falling cabinets. The factory assumes no liability for damage or injury from the following: installation into non-load bearing or unlevel walls. Improper fasteners used in installation. Overloading of cabinets resulting in failures of wall and surrounding structures, fasteners, or cabinet construction. Misuse of cabinets for intended purposes.

Options.

DOOR

- D2: Door Lock - \$100 per door set
- D9SC: Soft Close Door Hinges - \$20 per door
- DWF1: 2" Wood frame replaces SilverLuma Frame - n/c ("W" only)
- DWF2: 2" Wood frame w/ pull replaces SilverLuma Frame - \$20 per door ("W" only)

INTERIOR CABINET LIGHT

- LEDPK starter kit includes Infeed, 1 Puck Interior Light and the ability to daisy chain up to 6 total Puck Lights
- LEDPK: LED Puck Starter Kit - \$310
- PK: 1 LED Interior Light - \$130 ea.

RECESSED TASK LIGHT

- LT-LED24R: 24" LED Task light - \$190
- LT-LED48R: 48" LED Task light - \$245
- LT-LED60R: 60" LED Task light - \$310
- LT-LED72R: 72" LED Task light - \$335

Edgeworks.

Single Height Wall Hung Overheads
14" D Open Storage Cabinet - 1/2 Section

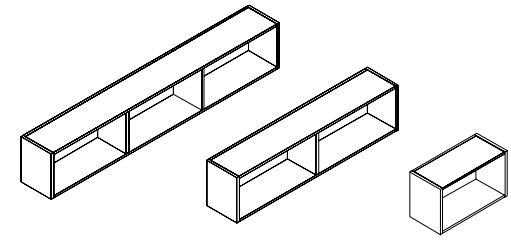

1 Select a model w" x d" x h"		weight	Standard Veneer	Premium Veneer	High Pressure Laminate	Thermally Fused Laminate
3 Section 78 x 14 x 18		185	EDG7818WH332W 2905	EDG7818WH332P 3196	"G" Option N/A	EDG7818WH332M 1294
2 Section 72 x 14 x 18		170	EDG7218WH332W 2375	EDG7218WH332P 2613	"G" Option N/A	EDG7218WH332M 1223
66 x 14 x 18		150	EDG6618WH332W 2337	EDG6618WH332P 2571	"G" Option N/A	EDG6618WH332M 1185
60 x 14 x 18		125	EDG6018WH332W 2305	EDG6018WH332P 2536	"G" Option N/A	EDG6018WH332M 1141
48 x 14 x 18		115	EDG4818WH332W 1720	EDG4818WH332P 1892	"G" Option N/A	EDG4818WH332M 1075
1 Section 42 x 14 x 18		80	EDG4218WH332W 1507	EDG4218WH332P 1658	"G" Option N/A	EDG4218WH332M 939
36 x 14 x 18		60	EDG3618WH332W 1294	EDG3618WH332P 1424	"G" Option N/A	EDG3618WH332M 803
2 Select a finish <i>View finish details</i>			WLA WNW WAC WWP WEC WOC WAM WCM WWM WGW WBW WSW	TBCO TBSW TSTV TSMV TSLV TOBW WBO WMO WSO	GAC GSLV +10% GEC GWL GOC GAM GCM GWM GNW GSTV +10%	MAC MEC MOC MGW MSW MTW MWL
3 Select an edge <i>View edge details</i>			Edge N/A	Edge N/A	Edge N/A	Edge N/A
4 Select hardware <i>View hardware details</i>			Hardware N/A	Hardware N/A	Hardware N/A	Hardware N/A

View statement of line

Product features.

- Finished top
- Interior cabinet depth 12"
- Mounting wall rail included

NOTES

- 3 Section Overhead Available w/ 1 or 2 Sliding Doors
- 2 Section available w/ 1 sliding door
- All units are standard w/ flush ends
- Proper installation is critical to ensure safety from possible falling cabinets. The factory assumes no liability for damage or injury from The following: installation into non-load bearing or unlevel walls. Improper fasteners used in installation. Overloading of cabinets resulting in failures of wall and surrounding structures, fasteners, or cabinet construction. Misuse of cabinets for intended purposes.

Options.

DOOR

- Not available in 29" and 35"
- SLD17WD: Panel Door - \$260 per door
- SLD17LD: White Laminate Door - \$205 per door
- SLD17FD: SilverLuma / Frost Door - \$365 per door

INTERIOR CABINET LIGHT

- LEDPK starter kit includes Infeed, 1 Puck Interior Light and the ability to daisy chain up to 6 total Puck Lights
- LEDPK: LED Puck Starter Kit - \$310
- PK: 1 LED Interior Light - \$130 ea.

RECESSED TASK LIGHT

- LT-LED24R: 24" LED Task light - \$190
- LT-LED48R: 48" LED Task light - \$245
- LT-LED60R: 60" LED Task light - \$310
- LT-LED72R: 72" LED Task light - \$335

EdgeWorks tackboards.

Wall hung tackboard
Full width tackboards

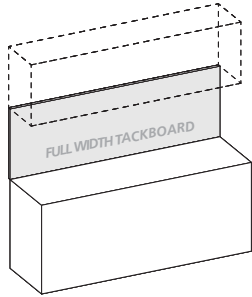

78	78 x .75 x 24	FTWH7824	388	474	519	564	608	653	698	743	787	832	877	921	966	1056
72	72 x .75 x 24	FTWH7224	355	437	478	520	562	603	645	686	728	770	811	853	894	978
66	66 x .75 x 24	FTWH6624	322	399	437	474	512	549	587	624	661	699	736	774	811	886
60	60 x .75 x 24	FTWH6024	294	362	395	428	462	495	528	562	595	628	661	695	728	795
48	48 x .75 x 24	FTWH4824	236	293	321	349	378	406	434	462	490	518	546	574	602	658
42	42 x .75 x 24	FTWH4224	206	256	281	305	330	354	379	402	427	451	476	500	525	574
36	36 x .75 x 24	FTWH3624	176	218	239	260	281	302	322	343	364	385	406	426	447	489

Standard Features

- Constructed of .5" thick fiberboard
- Hung with Z-Strip mounting system

- Fabric is precisely aligned and fitted to the tackboard
- Adhered to the rigid hardboard with staples

Wall hung tackboard
Half width tackboards

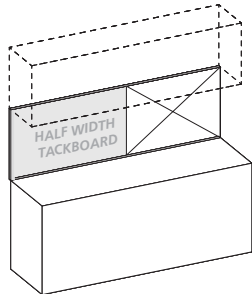

78 Half Width	39 x .75 x 24	FTWH3924	194	237	260	282	305	327	349	371	394	416	439	461	484	528
72 Half Width	36 x .75 x 24	FTWH3624	178	218	239	260	281	302	322	343	364	385	406	426	447	489
66 Half Width	33 x .75 x 24	FTWH3324	161	200	218	237	256	275	293	312	331	349	368	387	406	443

Standard Features

- Constructed of .5" thick fiberboard
- Fabric is precisely aligned and fitted to the tackboard
- Adhered to the rigid hardboard with staples
- Hung with Z-Strip mounting system

Notes

- Half width tackboards can be specified and combined with a Veneer Panel, Marker Board or Glass Board. See "Half Width" items under product width.
- Specify right or left facing tackboard

EdgeWorks tackboards.

Wall hung dry marker board
Full width dry marker board

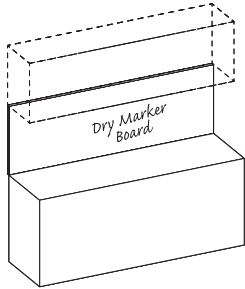

78	78 x .75 x 24	DMWH7824	948
72	72 x .75 x 24	DMWH7224	874
66	66 x .75 x 24	DMWH6624	799
60	60 x .75 x 24	DMWH6024	724
48	48 x .75 x 24	DMWH4824	587
42	42 x .75 x 24	DMWH4224	512
36	36 x .75 x 24	DMWH3624	437

Standard Features

- Dry marker panel has edge trim molding
- Standard magnetic surface

- Hung with Z-Strip mounting system

Wall hung dry marker board
Half width dry marker board

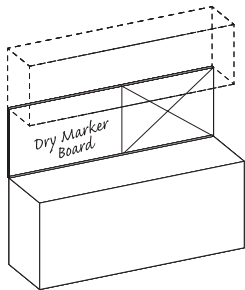

78 Half Width	39 x .75 x 24	DMWH3924	474
72 Half Width	36 x .75 x 24	DMWH3624	437
66 Half Width	33 x .75 x 24	DMWH3324	399

Standard Features

- Dry marker panel has edge trim molding
- Standard magnetic surface
- Hung with Z-Strip mounting system

Notes

- Half width dry marker boards can be specified and combined with a Tackboard, Veneer Panel or Glass Board. See "Half Width" items under product width.
- Specify right or left facing dry marker board

EdgeWorks tackboards.

Wall hung veneer panel
Full width veneer panel

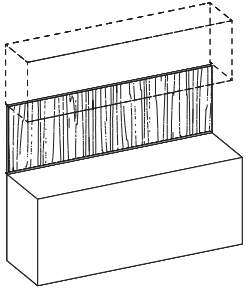

78	78 x .75 x 24	VPWH7824	790
72	72 x .75 x 24	VPWH7224	728
66	66 x .75 x 24	VPWH6624	666
60	60 x .75 x 24	VPWH6024	603
48	48 x .75 x 24	VPWH4824	489
42	42 x .75 x 24	VPWH4224	426
36	36 x .75 x 24	VPWH3624	364

Standard Features

- Hung with Z-Strip mounting system

Notes

- Veneer edges.
- Vertical wire channels on back for task light cords
- Steel mounting wall channel is recessed for flush mounting
- Can be used with or without overhead cabinet
- Required for other accessory panels

Wall hung veneer panel
Half width veneer panel

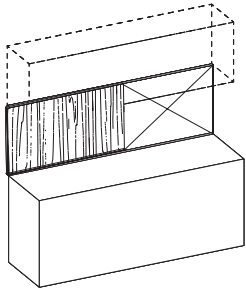

78 Half Width	39 x .75 x 24	VPWH3924	395
72 Half Width	36 x .75 x 24	VPWH3624	364
66 Half Width	33 x .75 x 24	VPWH3324	333

Standard Features

- Veneer edges
- Vertical wire channels on back for task light cords
- Steel mounting wall channel is recessed for flush mounting
- Hung with Z-Strip mounting system

Notes

- Half width veneer panels can be specified and combined with a Tackboard, Marker Board or Glass Board. See "Half Width" items under product width.
- Specify right or left facing veneer panel
- Can be used with or without overhead cabinet
- Required for other accessory panels

EdgeWorks tackboards.

Wall hung glassboard
Full width glassboard

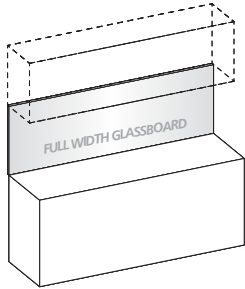

78	78 x .75 x 24	GBWH7824	2281
72	72 x .75 x 24	GBWH7224	2114
66	66 x .75 x 24	GBWH6624	1948
60	60 x .75 x 24	GBWH6024	1780
48	48 x .75 x 24	GBWH4824	1476
42	42 x .75 x 24	GBWH4224	1309
36	36 x .75 x 24	GBWH3624	1142

Standard Features
- 4 mm tempered glass

Notes
- Use glass cleaner or alcohol to clean
- Standard dry erase markers may be used
- Earth magnets are required to hold items securely in place
- Hung with Z-Strip mounting system

Wall hung glassboard
Half width glassboard

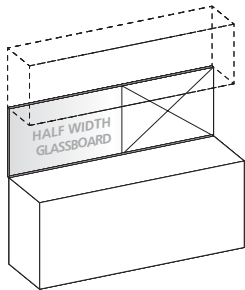

78 Half Width	39 x .75 x 24	GBWH3924	1232
72 Half Width	36 x .75 x 24	GBWH3624	1142
66 Half Width	33 x .75 x 24	GBWH3324	1059

Standard Features
- 4 mm tempered glass
- Hung with Z-Strip mounting system

Notes
- Half width glassboards can be specified and combined with a Tackboard, Veneer panel or Marker Board. See "Half Width" items under product width.
- Specify right or left facing glassboard
- Use glass cleaner or alcohol to clean
- Standard dry erase markers may be used
- Earth magnets are required to hold items securely in place

Edgeworks.

Metal Accessories

Inline Worksurface Accessories



Personal Tray

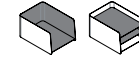

Document Pod & Paper Tray



Binder Pod

[View statement of line](#)

1 Select a model		weight	Accessory		
w" x d" x h"					
Personal Tray					
13 x 9 x 3	4	EA53	267		
Document Pod & Paper Tray					
9 x 14 x 7	12	EA54	371		
Binder Pod					
9 x 14 x 12	12	EA55	289		

2 Select a finish		MFMB
View finish details		
Metal finish		
MFMB Matte Black.		
Additional metal finishes are available, see options.		

3 Select a edge		Edge
View edge details		N/A

4 Select hardware		Hardware
View hardware details		N/A

Product features.

- Metal accessories are mounted on die cast aluminum spacer blocks for inline workstations
- Accessories come standard in matte black powdercoat

Options.

PREMIUM METAL FINISHES

- Specify Accessory Brackets Metal Finish Color: \$55 ea. and/or Accessory Metal Finish Color: \$100 ea.
- MFW: White, MFS: Silver, MFGG: Graphite Gray, MFSS: Salmon Sienna, MFSA: Surfin Aquavert, MFPS: Pistachio, MFOS: Oyster, MFNA: Navy, MFOL: Olive, MFGB: Grey Beige

Edgeworks.

Metal Accessories

Facing Workstation Accessories



Personal Tray

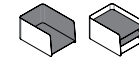

Document Pod & Paper Tray



Binder Pod

[View statement of line](#)

1 Select a model w" x d" x h"		weight	Accessory		
Personal Tray	13 x 9 x 3	4	EA50	267	
Document Pod & Paper Tray	9 x 14 x 7	12	EA51	371	
Binder Pod	9 x 14 x 12	12	EA52	289	

2 Select a finish View finish details		
Metal finish MFMB Matte Black. Additional metal finishes are available, see options.		MFMB

3 Select a edge View edge details		
		Edge N/A

4 Select hardware View hardware details		
		Hardware N/A

Product features.

- Metal accessories are center mounted on die cast aluminum spacer blocks for facing workstations
- Accessories come standard in matte black powdercoat

Options.

PREMIUM METAL FINISHES

- Specify Accessory Brackets Metal Finish Color: \$55 ea. and/or Accessory Metal Finish Color: \$100 ea.
- MFW: White, MFS: Silver, MFGG: Graphite Gray, MFSS: Salmon Sienna, MFSA: Surfin Aquavert, MFPS: Pistachio, MFOS: Oyster, MFNA: Navy, MFOL: Olive, MFGB: Grey Beige

Edgeworks.

Conference Tables
Round Frameless

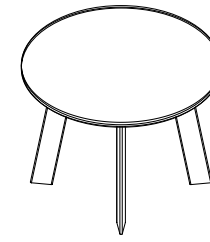

1 Select a model w" x d" x h"	weight	Standard Veneer Top Matte Black Metal Base		Premium Veneer Top Matte Black Metal Base		High Pressure Laminate Top Matte Black Metal Base		Thermally Fused Laminate Top Matte Black Metal Base	
		Sitting Height							
54 DIA x 29	85	EDG5454RD121W	3227	EDG5454RD121P	3550	EDG5454RD121G	3036	EDG5454RD121M	2582
48 DIA x 29	105	EDG4848RD121W	2954	EDG4848RD121P	3249	EDG4848RD121G	2779	EDG4848RD121M	2419
42 DIA x 29	95	EDG4242RD121W	2927	EDG4242RD121P	3220	EDG4242RD121G	2757	EDG4242RD121M	2386
Standing Height									
54 DIA x 42	95	EDG5454RD141W	3511	EDG5454RD141P	3863	EDG5454RD141G	3320	EDG5454RD141M	2866
48 DIA x 42	115	EDG4848RD141W	3238	EDG4848RD141P	3562	EDG4848RD141G	3063	EDG4848RD141M	2703
42 DIA x 42	105	EDG4242RD141W	3210	EDG4242RD141P	3531	EDG4242RD141G	3041	EDG4242RD141M	2670
2 Select a finish <i>View finish details</i>		WLA WNW WAC WWP WEC WOC WAM WCM WWM WGW WBW WSW		TBCO TBSW TSTV TSMV TSLV TOBW WBO WMO WSO		GAC GSWL +10% GEC GWL GOC GAM GCM GWM GNW GSTV +10%		MAC MEC MOC MGW MSW MTW MWL	
3 Select an edge <i>View edge details</i>		Flat-1 Flat-2 (Black) Flat-3 (White) Ledge-1 (Finished) Ledge-2 (Black) Ledge-3 (White)		Flat-1 Flat-2 (Black) Flat-3 (White) Ledge-1 (Finished) Ledge-2 (Black) Ledge-3 (White)		Flat-1 Flat-2 (Black) Flat-3 (White) Ledge-1 (Finished) Ledge-2 (Black) Ledge-3 (White)		Flat-1 Flat-2 (Black) Flat-3 (White)	
4 Select hardware <i>View hardware details</i>		Hardware N/A		Hardware N/A		Hardware N/A		Hardware N/A	

[View statement of line](#)

Product features.

- 1" Thick top
- ENVI-CT finish on wood tops
- Matte black metal finish base standard
- 3" Adjustable glide

Options.

POWER

- Two pods mounted under the hinged seamless grommet. Each pod has 4 power and 2 data ports. Telecom connectors sold separately.
- PSG82-C: Plug with 124" cord (8 power, 2 telecom plates) - \$1875 each
- W21: Grey Wire Manager (10.5") - \$35 ea.

PREMIUM METAL FINISHES

- Specify Top Horn and Leg Metal Finish Color: \$630
- MFW: White, MFS: Silver, MFGG: Graphite Gray, MFSS: Salmon Sienna, MFSA: Surfin Aquavert, MFPS: Pistachio, MFOS: Oyster, MFNA: Navy, MFOL: Olive, MFGB: Grey Beige



PLANK MATCH VENEER

- RPMV: Random Walnut Plank Match Veneer (Horizontal Grain with 25%+ Sap) - Add 10%. Clear coat only.

Edgeworks.

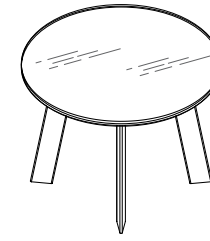
Glass Conference Tables
Round Frameless



1 Select a model w" x d" x h"	weight	Clear Gloss Glass Top Matte Black Metal Base		White Gloss Glass Top Matte Black Metal Base		Black Gloss Glass Top Matte Black Metal Base	
Sitting Height							
54 DIA x 29	85	EDG5454RD121SC	4554	EDG5454RD121SW	6212	EDG5454RD121SB	6212
48 DIA x 29	105	EDG4848RD121SC	4002	EDG4848RD121SW	5312	EDG4848RD121SB	5312
42 DIA x 29	95	EDG4242RD121SC	3729	EDG4242RD121SW	4733	EDG4242RD121SB	4733
Standing Height							
54 DIA x 42	95	EDG5454RD141SC	4838	EDG5454RD141SW	6496	EDG5454RD141SB	6496
48 DIA x 42	115	EDG4848RD141SC	4286	EDG4848RD141SW	5596	EDG4848RD141SB	5596
42 DIA x 42	105	EDG4242RD141SC	4013	EDG4242RD141SW	5017	EDG4242RD141SB	5017
2 Select a finish <i>View finish details</i>		MFMB		MFMB		MFMB	
Metal finish MFMB Matte Black. Additional metal finishes are available, see options.							
3 Select an edge <i>View edge details</i>							
		Flat		Flat		Flat	
4 Select hardware <i>View hardware details</i>		Hardware N/A		Hardware N/A		Hardware N/A	

[View statement of line](#)

Product features.

- 1/2" Clear glass top
- Matte black metal finish base standard
- 3" Adjustable glide
- Wood subtop underneath glass
- Glass tops are gloss finish, see options for Soft Etch Glass tops

Options.

PREMIUM METAL FINISHES

- Specify Top Horn and Leg Metal Finish Color: \$630
- MFW: White, MFS: Silver, MFGG: Graphite Gray, MFSS: Salmon Sienna, MFSA: Surfin Aquavert, MFPS: Pistachio, MFOS: Oyster, MFNA: Navy, MFOL: Olive, MFGB: Grey Beige

GLASS FINISH

- Optional Soft Etch Finished glass
- EB: Black Soft Etch Glass, EW: White Soft Etch Glass - n/c

Edgeworks.

Conference Tables
Square Frameless

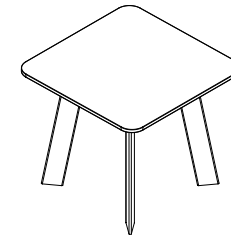

1 Select a model

w" x d" x h"

weight	Standard Veneer Top Matte Black Metal Base		Premium Veneer Top Matte Black Metal Base		High Pressure Laminate Top Matte Black Metal Base		Thermally Fused Laminate Top Matte Black Metal Base	
Sitting Height								
54 x 54 x 29	130	EDG5454SQ121W 3227	EDG5454SQ121P 3550	EDG5454SQ121G 3036	EDG5454SQ121M 2582			
48 x 48 x 29	110	EDG4848SQ121W 2954	EDG4848SQ121P 3249	EDG4848SQ121G 2779	EDG4848SQ121M 2419			
42 x 42 x 29	100	EDG4242SQ121W 2927	EDG4242SQ121P 3220	EDG4242SQ121G 2757	EDG4242SQ121M 2386			
Standing Height								
54 x 54 x 42	140	EDG5454SQ141W 3511	EDG5454SQ141P 3863	EDG5454SQ141G 3320	EDG5454SQ141M 2866			
48 x 48 x 42	120	EDG4848SQ141W 3238	EDG4848SQ141P 3562	EDG4848SQ141G 3063	EDG4848SQ141M 2703			
42 x 42 x 42	110	EDG4242SQ141W 3210	EDG4242SQ141P 3531	EDG4242SQ141G 3041	EDG4242SQ141M 2670			

[View statement of line](#)

2 Select a finish

[View finish details](#)

Metal finish
MFMB Matte Black.
Additional metal finishes are available, see options.

- WLA WNW
- WAC WWP
- WEC
- WOC
- WAM
- WCM
- WWM
- WGW
- WBW
- WSW

- TBCO
- TBSW
- TSTV
- TSMV
- TSLV
- TOBW
- WBO
- WMO
- WSO

- GAC GSLV +10%
- GEC GWL
- GOC
- GAM
- GCM
- GWM
- GNW
- GSTV
- +10%

- MAC
- MEC
- MOC
- MGW
- MSW
- MTW
- MWL

3 Select a edge

[View edge details](#)

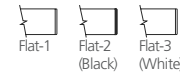
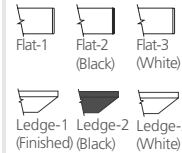
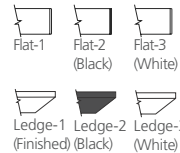
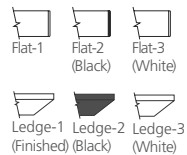

4 Select hardware

[View hardware details](#)

Hardware
N/A

Hardware
N/A

Hardware
N/A

Hardware
N/A

Product features.

- 1" Thick top
- ENVI-CT finish on wood tops
- Matte black metal finish base standard
- 6" Radius corners
- 3" Adjustable glide

Options.

EDGE

- SC1: Modify radius corner to square corner - n/c

POWER

- Two pods mounted under the hinged seamless grommet. Each pod has 4 power and 2 data ports. Telecom connectors sold separately.
- PSG82-C: Plug with 124" cord (8 power, 2 telecom plates) - \$1875 each
- W21: Grey Wire Manager (10.5") - \$35 ea.

PREMIUM METAL FINISHES

- Specify Top Horn and Leg Metal Finish Color: \$630
- MFW: White, MFS: Silver, MFGG: Graphite Gray, MFSS: Salmon Sienna, MFSA: Surfin Aquavert, MFPS: Pistachio, MFOS: Oyster, MFNA: Navy, MFOL: Olive, MFGB: Grey Beige



PLANK MATCH VENEER

- RPMV: Random Walnut Plank Match Veneer (Horizontal Grain with 25%+ Sap) - Add 10%. Clear coat only.

Edgeworks.

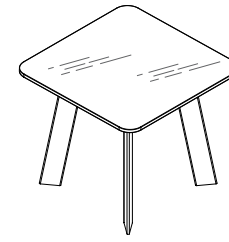
Glass Conference Tables
Square Frameless



1 Select a model w" x d" x h"	weight	Clear Gloss Glass Top Matte Black Metal Base		White Gloss Glass Top Matte Black Metal Base		Black Gloss Glass Top Matte Black Metal Base	
Sitting Height							
54 x 54 x 29	130	EDG5454SQ121SC	4554	EDG5454SQ121SW	6212	EDG5454SQ121SB	6212
48 x 48 x 29	110	EDG4848SQ121SC	4002	EDG4848SQ121SW	5312	EDG4848SQ121SB	5312
42 x 42 x 29	100	EDG4242SQ121SC	3729	EDG4242SQ121SW	4733	EDG4242SQ121SB	4733
Standing Height							
54 x 54 x 42	140	EDG5454SQ141SC	4838	EDG5454SQ141SW	6496	EDG5454SQ141SB	6496
48 x 48 x 42	120	EDG4848SQ141SC	4286	EDG4848SQ141SW	5596	EDG4848SQ141SB	5596
42 x 42 x 42	110	EDG4242SQ141SC	4013	EDG4242SQ141SW	5017	EDG4242SQ141SB	5017
2 Select a finish <i>View finish details</i>		MFMB		MFMB		MFMB	
Metal finish MFMB Matte Black. Additional metal finishes are available, see options.							
3 Select an edge <i>View edge details</i>							
		Flat		Flat		Flat	
4 Select hardware <i>View hardware details</i>		Hardware N/A		Hardware N/A		Hardware N/A	

View statement of line

Product features.

- 1/2" Clear glass top
- Matte black metal finish base standard
- 6" Radius corners
- 3" Adjustable glide
- Wood subtop underneath glass
- Glass tops are gloss finish, see options for Soft Etch Glass tops

Options.

EDGE

- SC1: Modify radius corner to square corner - n/c

PREMIUM METAL FINISHES

- Specify Top Horn and Leg Metal Finish Color: \$630
- MFW: White, MFS: Silver, MFGG: Graphite Gray, MFSS: Salmon Sienna, MFSA: Surfin Aquavert, MFPS: Pistachio, MFOS: Oyster, MFNA: Navy, MFOL: Olive, MFGB: Grey Beige

GLASS FINISH

- Optional Soft Etch Finished glass
- EB: Black Soft Etch Glass, EW: White Soft Etch Glass - n/c

Edgeworks.

Conference Tables
Rectangle 36" Depth Sitting Height

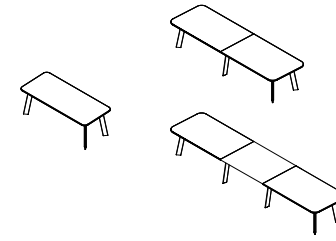

[View statement of line](#)

1 Select a model w" x d" x h"	weight	Standard Veneer Top Matte Black Metal Base		Premium Veneer Top Matte Black Metal Base		High Pressure Laminate Top Matte Black Metal Base		Thermally Fused Laminate Top Matte Black Metal Base	
		3 Piece Top 240 x 36 x 29 216 x 36 x 29 198 x 36 x 29 2 Piece Top 168 x 36 x 29 144 x 36 x 29 120 x 36 x 29 1 Piece Top 96 x 36 x 29 84 x 36 x 29 72 x 36 x 29		430 EDG24036RE123W 11580 360 EDG21636RE123W 9577 265 EDG19836RE123W 8692 265 EDG16836RE122W 6738 240 EDG14436RE122W 6508 215 EDG12036RE122W 6280 735 EDG9636RE121W 3833 145 EDG8436RE121W 3735 135 EDG7236RE121W 3637	EDG24036RE123P 12738 EDG21636RE123P 10535 EDG19836RE123P 9562 EDG16836RE122P 7412 EDG14436RE122P 7159 EDG12036RE122P 6908 EDG9636RE121P 4217 EDG8436RE121P 4109 EDG7236RE121P 4001	EDG24036RE123G 10986 EDG21636RE123G 9025 EDG19836RE123G 8272 EDG16836RE122G 6355 EDG14436RE122G 6159 EDG12036RE122G 5962 EDG9636RE121G 3625 EDG8436RE121G 3538 EDG7236RE121G 3456	EDG24036RE123M 10014 EDG21636RE123M 8201 EDG19836RE123M 7524 EDG16836RE122M 5734 EDG14436RE122M 5668 EDG12036RE122M 5602 EDG9636RE121M 3238 EDG8436RE121M 3205 EDG7236RE121M 3172	WLA WNW WAC WWP WEC WOC WAM WCM WWM WGW WBW WSW TBCO TBSW TSTV TSMV TSLV TOBW WBO WMO WSO GAC GSWL +10% GEC GWL GOC GAM GCM GWM GNW GSTV +10% MAC MEC MOC MGW MSW MTW MWL	Flat-1 Flat-2 Flat-3 (Black) (White) Ledge-1 Ledge-2 Ledge-3 (Finished) (Black) (White) Flat-1 Flat-2 Flat-3 (Black) (White) Ledge-1 Ledge-2 Ledge-3 (Finished) (Black) (White) Flat-1 Flat-2 Flat-3 (Black) (White) Ledge-1 Ledge-2 Ledge-3 (Finished) (Black) (White)

Product features.

- 1" Thick top with rounded edges
- ENVI-CT finish on wood tops
- Matte black metal finish base standard
- 6" Radius corners
- 3" Adjustable glide

NOTES

- 4 leg: 72" - 96" width
- 6 leg: 120" - 168" width
- 8 leg: 198" - 240" width

Options.

EDGE

- SC1: Modify radius corner to square corner - n/c

INSET LEGS

- IL2: Inset legs for two piece top - 10% upcharge
- IL3: Inset legs for a three piece top - 10% upcharge

POWER

- Two pods mounted under the hinged seamless grommet. Each pod has 4 power and 2 data ports. Telecom connectors sold separately.
- PSG82-C: Plug with 124" cord (8 power, 2 telecom plates) - \$1875 each
- W21: Grey Wire Manager (10.5") - \$35 ea.

PREMIUM METAL FINISHES

- Specify Top Horn and Leg Metal Finish Color: \$660 (1) Piece Top, \$1,010 (2) Piece Top, \$1,355 (3) Piece Top
- MFW: White, MFS: Silver, MFGG: Graphite Gray, MFSS: Salmon Sienna, MFSA: Surfin Aquavert, MFPS: Pistachio, MFOS: Oyster, MFNA: Navy, MFOL: Olive, MFGB: Grey Beige
- PLANK MATCH VENEER
- RPMV: Random Walnut Plank Match Veneer (Horizontal Grain with 25%+ Sap) - Add 10%. Clear coat only.

Edgeworks.

Glass Conference Tables
Rectangle 36" Depth Sitting Height

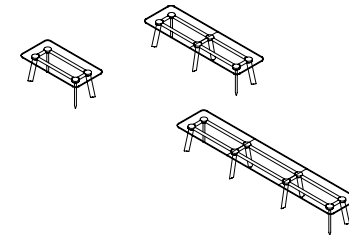

1 Select a model w" x d" x h"	weight	Clear Gloss Glass Top Matte Black Metal Base		White Gloss Glass Top Matte Black Metal Base		Black Gloss Glass Top Matte Black Metal Base	
3 Piece Top							
240 x 36 x 29	430	EDG24036RE123SC	12596	EDG24036RE123SW	17510	EDG24036RE123SB	17510
216 x 36 x 29	360	EDG21636RE123SC	10478	EDG21636RE123SW	14900	EDG21636RE123SB	14900
198 x 36 x 29	265	EDG19836RE123SC	10183	EDG19836RE123SW	14238	EDG19836RE123SB	14238
2 Piece Top							
168 x 36 x 29	265	EDG16836RE122SC	7704	EDG16836RE122SW	11144	EDG16836RE122SB	11144
144 x 36 x 29	240	EDG14436RE122SC	7311	EDG14436RE122SW	10260	EDG14436RE122SB	10260
120 x 36 x 29	215	EDG12036RE122SC	6918	EDG12036RE122SW	9375	EDG12036RE122SB	9375
1 Piece Top							
96 x 36 x 29	735	EDG9636RE121SC	4526	EDG9636RE121SW	6492	EDG9636RE121SB	6492
84 x 36 x 29	145	EDG8436RE121SC	4330	EDG8436RE121SW	6050	EDG8436RE121SB	6050
72 x 36 x 29	135	EDG7236RE121SC	4133	EDG7236RE121SW	5608	EDG7236RE121SB	5608
2 Select a finish View finish details		MFMB		MFMB		MFMB	
Metal finish MFMB Matte Black. Additional metal finishes are available, see options.							
3 Select a edge View edge details		Flat		Flat		Flat	
4 Select hardware View hardware details		Hardware N/A		Hardware N/A		Hardware N/A	

View statement of line

Product features.

- 1/2" Clear glass top
- Matte black metal finish base standard
- 6" Radius corners
- 3" Adjustable glide
- Glass tops are glass finish, see options for Soft Etch Glass tops

NOTES

- Contact our customer service department for custom inset leg quote with glass tops
- 4 leg: 72" - 96" width
- 6 leg: 120" - 168" width
- 8 leg: 198" - 240" width

Options.

EDGE

- SC1: Modify radius corner to square corner - n/c

PREMIUM METAL FINISHES

- Specify Top Horn and Leg Metal Finish Color: \$660 (1) Piece Top, \$1,010 (2) Piece Top, \$1,355 (3) Piece Top
- MFV: White, MFS: Silver, MFGG: Graphite Gray, MFSS: Salmon Sienna, MFSA: Surfin Aquavert, MFPS: Pistachio, MFOS: Oyster, MFNA: Navy, MFOL: Olive, MFGB: Grey Beige

GLASS FINISH

- Optional Soft Etch Finished glass
- EB: Black Soft Etch Glass, EW: White Soft Etch Glass - n/c

POWER

- Glasspod cutouts will include an additional fee of \$125 per pod
- REF-310: Reef power unit with daisylink - \$1100 ea
- PD-Cove-PKO: Cove corded series - \$800 ea
- FPDB: Flush power/data bay
- Hardwired: FPDB-H72: 72" Cord - \$1250. FPDB-H108: 108" Cord - \$1300. FPDB-H144: 144" Cord - \$1350. FPDB-H180: 180" Cord - \$1400.
- Power/Plug: FPDB-C72: 72" Cord - \$1250. FPDB-C108: 108" Cord - \$1300. FPDB-C144: 144" - Cord \$1350. FPDB-C180: 180" Cord - \$1400

Edgeworks.

Conference Tables
Rectangle 36" Depth Standing Height

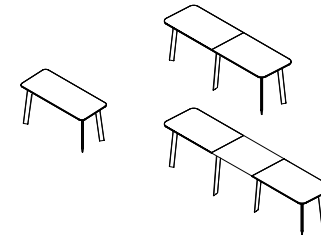

[View statement of line](#)

1 Select a model w" x d" x h"	weight	Standard Veneer Top Matte Black Metal Base		Premium Veneer Top Matte Black Metal Base		High Pressure Laminate Top Matte Black Metal Base		Thermally Fused Laminate Top Matte Black Metal Base	
		3 Piece Top 240 x 36 x 42 216 x 36 x 42 198 x 36 x 42 2 Piece Top 168 x 36 x 42 144 x 36 x 42 120 x 36 x 42 1 Piece Top 96 x 36 x 42 84 x 36 x 42 72 x 36 x 42		430 EDG24036RE143W 12291 360 EDG21636RE143W 10145 265 EDG19836RE143W 9260 265 EDG16836RE142W 7164 240 EDG14436RE142W 6935 215 EDG12036RE142W 6705 735 EDG9636RE141W 4259 145 EDG8436RE141W 4019 135 EDG7236RE141W 3921	EDG24036RE143P 13521 EDG21636RE143P 11160 EDG19836RE143P 10186 EDG16836RE142P 7881 EDG14436RE142P 7629 EDG12036RE142P 7376 EDG9636RE141P 4685 EDG8436RE141P 4421 EDG7236RE141P 4314	EDG24036RE143G 11696 EDG21636RE143G 9593 EDG19836RE143G 8840 EDG16836RE142G 6782 EDG14436RE142G 6585 EDG12036RE142G 6393 EDG9636RE141G 4052 EDG8436RE141G 3822 EDG7236RE141G 3740	EDG24036RE143M 10723 EDG21636RE143M 8769 EDG19836RE143M 8092 EDG16836RE142M 6159 EDG14436RE142M 6093 EDG12036RE142M 6028 EDG9636RE141M 3664 EDG8436RE141M 3489 EDG7236RE141M 3456		
2 Select a finish View finish details Metal finish MFMB Matte Black. Additional metal finishes are available, see options.	WLA WNW WAC WWP WEC WOC WAM WCM WWM WGW WBW WSW	TBCO TBSW TSTV TSMV TSLV TOBW WBO WMO WSO	GAC GSWL +10% GEC GWL GOC GAM GCM GWM GNW GSTV +10%	MAC MEC MOC MGW MSW MTW MWL					
3 Select a edge View edge details									
4 Select hardware View hardware details	Hardware N/A	Hardware N/A	Hardware N/A	Hardware N/A					

Product features.

- 1" Thick top with rounded edges
- ENVI-CT finish on wood tops
- Matte black metal finish base standard
- 6" Radius corners
- 3" Adjustable glide

NOTES

- 4 leg: 72" - 96" width
- 6 leg: 120" - 168" width
- 8 leg: 198" - 240" width

Options.

EDGE

- SC1: Modify radius corner to square corner - n/c

INSET LEGS

- IL2: Inset legs for two piece top - 10% upcharge
- IL3: Inset legs for a three piece top - 10% upcharge

POWER

- Two pods mounted under the hinged seamless grommet. Each pod has 4 power and 2 data ports. Telecom connectors sold separately.
- PSG82-C: Plug with 124" cord (8 power, 2 telecom plates) - \$1875 each
- W21: Grey Wire Manager (10.5") - \$35 ea.

PREMIUM METAL FINISHES

- Specify Top Horn and Leg Metal Finish Color: \$660 (1) Piece Top, \$1,010 (2) Piece Top, \$1,355 (3) Piece Top
- MFW: White, MFS: Silver, MFGG: Graphite Gray, MFSS: Salmon Sienna, MFSA: Surfin Aquavert, MFPS: Pistachio, MFOS: Oyster, MFNA: Navy, MFOL: Olive, MFGB: Grey Beige
- PLANK MATCH VENEER
- RPMV: Random Walnut Plank Match Veneer (Horizontal Grain with 25%+ Sap) - Add 10%. Clear coat only.

Edgeworks.

Glass Conference Tables
Rectangle 36" Depth Standing Height

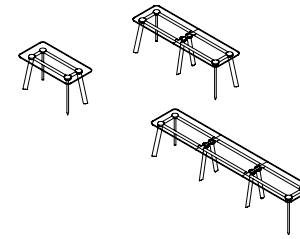

1 Select a model w" x d" x h"	weight	Clear Gloss Glass Top Matte Black Metal Base		White Gloss Glass Top Matte Black Metal Base		Black Gloss Glass Top Matte Black Metal Base	
		3 Piece Top					
240 x 36 x 42	430	EDG24036RE143SC	13306	EDG24036RE143SW	18220	EDG24036RE143SB	18220
216 x 36 x 42	360	EDG21636RE143SC	11046	EDG21636RE143SW	15468	EDG21636RE143SB	15468
198 x 36 x 42	265	EDG19836RE143SC	10750	EDG19836RE143SW	14805	EDG19836RE143SB	14805
2 Piece Top							
168 x 36 x 42	265	EDG16836RE142SC	8130	EDG16836RE142SW	11570	EDG16836RE142SB	11570
144 x 36 x 42	240	EDG14436RE142SC	7737	EDG14436RE142SW	10685	EDG14436RE142SB	10685
120 x 36 x 42	215	EDG12036RE142SC	7343	EDG12036RE142SW	9801	EDG12036RE142SB	9801
1 Piece Top							
96 x 36 x 42	735	EDG9636RE141SC	4810	EDG9636RE141SW	6776	EDG9636RE141SB	6776
84 x 36 x 42	145	EDG8436RE141SC	4613	EDG8436RE141SW	6334	EDG8436RE141SB	6334
72 x 36 x 42	135	EDG7236RE141SC	4417	EDG7236RE141SW	5892	EDG7236RE141SB	5892
2 Select a finish View finish details		MFMB		MFMB		MFMB	
Metal finish MFMB Matte Black. Additional metal finishes are available, see options.							
3 Select an edge View edge details		Flat		Flat		Flat	
4 Select hardware View hardware details		Hardware N/A		Hardware N/A		Hardware N/A	

View statement of line

Product features.

- 1/2" Clear glass top
- Matte black metal finish base standard
- 6" Radius corners
- 3" Adjustable glide
- Glass tops are glass finish, see options for Soft Etch Glass tops

NOTES

- Contact our customer service department for custom inset leg quote with glass tops
- 4 leg: 72" - 96" width
- 6 leg: 120" - 168" width
- 8 leg: 198" - 240" width

Options.

EDGE

- SC1: Modify radius corner to square corner - n/c

PREMIUM METAL FINISHES

- Specify Top Horn and Leg Metal Finish Color: \$660 (1) Piece Top, \$1,010 (2) Piece Top, \$1,355 (3) Piece Top
- MFW: White, MFS: Silver, MFGG: Graphite Gray, MFSS: Salmon Sienna, MFSA: Surfin Aquavert, MFPS: Pistachio, MFOS: Oyster, MFNA: Navy, MFOL: Olive, MFGB: Grey Beige

GLASS FINISH

- Optional Soft Etch Finished glass
- EB: Black Soft Etch Glass, EW: White Soft Etch Glass - n/c

POWER

- Glasspod cutouts will include an additional fee of \$125 per pod
- REF-310: Reef power unit with daisylink - \$1100 ea
- PD-Cove-PKO: Cove corded series - \$800 ea
- FPDB: Flush power/data bay
- Hardwired: FPDB-H72: 72" Cord - \$1250. FPDB-H108: 108" Cord - \$1300. FPDB-H144: 144" Cord - \$1350. FPDB-H180: 180" Cord - \$1400.
- Power/Plug: FPDB-C72: 72" Cord - \$1250. FPDB-C108: 108" Cord - \$1300. FPDB-C144: 144" Cord - \$1350. FPDB-C180: 180" Cord - \$1400

Edgeworks.

Conference Tables

Rectangle 42" Depth Sitting Height

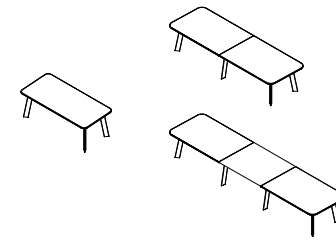

1 Select a model w" x d" x h"	weight	Standard Veneer Top Matte Black Metal Base		Premium Veneer Top Matte Black Metal Base		High Pressure Laminate Top Matte Black Metal Base		Thermally Fused Laminate Top Matte Black Metal Base	
		3 Piece Top 240 x 42 x 29 216 x 42 x 29 198 x 42 x 29 2 Piece Top 168 x 42 x 29 144 x 42 x 29 120 x 42 x 29 1 Piece Top 96 x 42 x 29 84 x 42 x 29 72 x 42 x 29		470 EDG24042RE123W 12089 390 EDG21642RE123W 10046 365 EDG19842RE123W 9031 295 EDG16842RE122W 7071 260 EDG14442RE122W 6841 235 EDG12042RE122W 6607 175 EDG9642RE121W 4019 160 EDG8442RE121W 3909 150 EDG7242RE121W 3800	EDG24042RE123P 13298 EDG21642RE123P 11051 EDG19842RE123P 9935 EDG16842RE122P 7779 EDG14442RE122P 7526 EDG12042RE122P 7268 EDG9642RE121P 4421 EDG8442RE121P 4300 EDG7242RE121P 4180	EDG24042RE123G 11417 EDG21642RE123G 9424 EDG19842RE123G 8561 EDG16842RE122G 6634 EDG14442RE122G 6443 EDG12042RE122G 6241 EDG9642RE121G 3778 EDG8442RE121G 3686 EDG7242RE121G 3593	EDG24042RE123M 10123 EDG21642RE123M 8299 EDG19842RE123M 7612 EDG16842RE122M 5809 EDG14442RE122M 5734 EDG12042RE122M 5657 EDG9642RE121M 3320 EDG8442RE121M 3266 EDG7242RE121M 3205		
2 Select a finish View finish details Metal finish MFMB Matte Black. Additional metal finishes are available, see options.	WLA WNW WAC WWP WEC WOC WAM WCM WWM WGW WBW WSW	TBCO TBSW TSTV TSMV TSLV TOBW WBO WMO WSO	GAC GSWL +10% GEC GWL GOC GAM GCM GWM GNW GSTV +10%	MAC MEC MOC MGW MSW MTW MWL					
3 Select a edge View edge details									
4 Select hardware View hardware details	Hardware N/A	Hardware N/A	Hardware N/A	Hardware N/A					

[View statement of line](#)

Product features.

- 1" Thick top with rounded edges
- ENVI-CT finish on wood tops
- Matte black metal finish base standard
- 6" Radius corners
- 3" Adjustable glide

NOTES

- 4 leg: 72" - 96" width
- 6 leg: 120" - 168" width
- 8 leg: 198" - 240" width

Options.

EDGE

- SC1: Modify radius corner to square corner - n/c

INSET LEGS

- IL2: Inset legs for two piece top - 10% upcharge
- IL3: Inset legs for a three piece top - 10% upcharge

POWER

- Two pods mounted under the hinged seamless grommet. Each pod has 4 power and 2 data ports. Telecom connectors sold separately.
- PSG82-C: Plug with 124" cord (8 power, 2 telecom plates) - \$1875 each
- W21: Grey Wire Manager (10.5") - \$35 ea.

PREMIUM METAL FINISHES

- Specify Top Horn and Leg Metal Finish Color: \$660 (1) Piece Top, \$1,010 (2) Piece Top, \$1,355 (3) Piece Top
- MFW: White, MFS: Silver, MFGG: Graphite Gray, MFSS: Salmon Sienna, MFSA: Surfin Aquavert, MFPS: Pistachio, MFOS: Oyster, MFNA: Navy, MFOL: Olive, MFGB: Grey Beige
- PLANK MATCH VENEER
- RPMV: Random Walnut Plank Match Veneer (Horizontal Grain with 25%+ Sap) - Add 10%. Clear coat only.

Edgeworks.

Glass Conference Tables
Rectangle 42" Depth Sitting Height

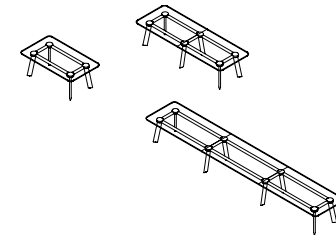

1 Select a model w" x d" x h"	weight	Clear Gloss Glass Top Matte Black Metal Base		White Gloss Glass Top Matte Black Metal Base		Black Gloss Glass Top Matte Black Metal Base	
3 Piece Top							
240 x 42 x 29	470	EDG24042RE123SC	13252	EDG24042RE123SW	18984	EDG24042RE123SB	18984
216 x 42 x 29	390	EDG21642RE123SC	11068	EDG21642RE123SW	16227	EDG21642RE123SB	16227
198 x 42 x 29	365	EDG19842RE123SC	10723	EDG19842RE123SW	15453	EDG19842RE123SB	15453
2 Piece Top							
168 x 42 x 29	295	EDG16842RE122SC	8163	EDG16842RE122SW	12176	EDG16842RE122SB	12176
144 x 42 x 29	260	EDG14442RE122SC	7704	EDG14442RE122SW	11144	EDG14442RE122SB	11144
120 x 42 x 29	235	EDG12042RE122SC	7246	EDG12042RE122SW	10112	EDG12042RE122SB	10112
1 Piece Top							
96 x 42 x 29	175	EDG9642RE121SC	4788	EDG9642RE121SW	7081	EDG9642RE121SB	7081
84 x 42 x 29	160	EDG8442RE121SC	4559	EDG8442RE121SW	6567	EDG8442RE121SB	6567
72 x 42 x 29	150	EDG7242RE121SC	4330	EDG7242RE121SW	6050	EDG7242RE121SB	6050
2 Select a finish View finish details		MFMB		MFMB		MFMB	
Metal finish MFMB Matte Black. Additional metal finishes are available, see options.							
3 Select an edge View edge details		Flat		Flat		Flat	
4 Select hardware View hardware details		Hardware N/A		Hardware N/A		Hardware N/A	

[View statement of line](#)

Product features.

- 1/2" Clear glass top
- Matte black metal finish base standard
- 6" Radius corners
- 3" Adjustable glide
- Glass tops are glass finish, see options for Soft Etch Glass tops

NOTES

- Contact our customer service department for custom inset leg quote with glass tops
- 4 leg: 72" - 96" width
- 6 leg: 120" - 168" width
- 8 leg: 198" - 240" width

Options.

EDGE

- SC1: Modify radius corner to square corner - n/c

PREMIUM METAL FINISHES

- Specify Top Horn and Leg Metal Finish Color: \$660 (1) Piece Top, \$1,010 (2) Piece Top, \$1,355 (3) Piece Top
- MFV: White, MFS: Silver, MFGG: Graphite Gray, MFSS: Salmon Sienna, MFSA: Surfin Aquavert, MFPS: Pistachio, MFOS: Oyster, MFNA: Navy, MFOL: Olive, MFGB: Grey Beige

GLASS FINISH

- Optional Soft Etch Finished glass
- EB: Black Soft Etch Glass, EW: White Soft Etch Glass - n/c

POWER

- Glasspod cutouts will include an additional fee of \$125 per pod
- REF-310: Reef power unit with daisylink - \$1100 ea
- PD-Cove-PKO: Cove corded series - \$800 ea
- FPDB: Flush power/data bay
- Hardwired: FPDB-H72: 72" Cord - \$1250. FPDB-H108: 108" Cord - \$1300. FPDB-H144: 144" Cord - \$1350. FPDB-H180: 180" Cord - \$1400.
- Power/Plug: FPDB-C72: 72" Cord - \$1250. FPDB-C108: 108" Cord - \$1300. FPDB-C144: 144" - Cord \$1350. FPDB-C180: 180" Cord - \$1400

Edgeworks.

Conference Tables
Rectangle 42" Depth Standing Height

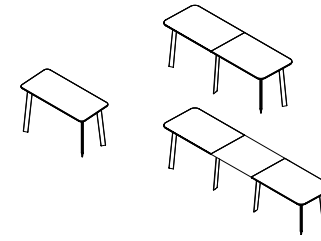

[View statement of line](#)

1 Select a model w" x d" x h"	weight	Standard Veneer Top Matte Black Metal Base		Premium Veneer Top Matte Black Metal Base		High Pressure Laminate Top Matte Black Metal Base		Thermally Fused Laminate Top Matte Black Metal Base	
		3 Piece Top 240 x 42 x 42 216 x 42 x 42 198 x 42 x 42 2 Piece Top 168 x 42 x 42 144 x 42 x 42 120 x 42 x 42 1 Piece Top 96 x 42 x 42 84 x 42 x 42 72 x 42 x 42		470 EDG24042RE143W 12798 390 EDG21642RE143W 10614 365 EDG19842RE143W 9599 295 EDG16842RE142W 7496 260 EDG14442RE142W 7268 235 EDG12042RE142W 7032 175 EDG9642RE141W 4445 160 EDG8442RE141W 4193 150 EDG7242RE141W 4084	EDG24042RE143P 14078 EDG21642RE143P 11675 EDG19842RE143P 10559 EDG16842RE142P 8246 EDG14442RE142P 7995 EDG12042RE142P 7736 EDG9642RE141P 4890 EDG8442RE141P 4613 EDG7242RE141P 4493	14078 11675 10559 8246 7995 7736 4890 4613 4493	EDG24042RE143G 12126 EDG21642RE143G 9992 EDG19842RE143G 9129 EDG16842RE142G 7060 EDG14442RE142G 6869 EDG12042RE142G 6666 EDG9642RE141G 4205 EDG8442RE141G 3970 EDG7242RE141G 3877	12126 9992 9129 7060 6869 6666 4205 3970 3877	EDG24042RE143M 10833 EDG21642RE143M 8867 EDG19842RE143M 8180 EDG16842RE142M 6236 EDG14442RE142M 6159 EDG12042RE142M 6083 EDG9642RE141M 3746 EDG8442RE141M 3550 EDG7242RE141M 3489
2 Select a finish View finish details Metal finish MFMB Matte Black. Additional metal finishes are available, see options.	WLA WNW WAC WWP WEC WOC WAM WCM WWM WGW WBW WSW	TBCO TBSW TSTV TSMV TSLV TOBW WBO WMO WSO	GAC GSWL +10% GEC GWL GOC GAM GCM GWM GNW GSTV +10%	MAC MEC MOC MGW MSW MTW MWL					
3 Select a edge View edge details									
4 Select hardware View hardware details	Hardware N/A	Hardware N/A	Hardware N/A	Hardware N/A					

Product features.

- 1" Thick top with rounded edges
- ENVI-CT finish on wood tops
- Matte black metal finish base standard
- 6" Radius corners
- 3" Adjustable glide

NOTES

- 4 leg: 72" - 96" width
- 6 leg: 120" - 168" width
- 8 leg: 198" - 240" width

Options.

EDGE

- SC1: Modify radius corner to square corner - n/c

INSET LEGS

- IL2: Inset legs for two piece top - 10% upcharge
- IL3: Inset legs for a three piece top - 10% upcharge

POWER

- Two pods mounted under the hinged seamless grommet. Each pod has 4 power and 2 data ports. Telecom connectors sold separately.
- PSG82-C: Plug with 124" cord (8 power, 2 telecom plates) - \$1875 each
- W21: Grey Wire Manager (10.5") - \$35 ea.



PREMIUM METAL FINISHES

- Specify Top Horn and Leg Metal Finish Color: \$660 (1) Piece Top, \$1,010 (2) Piece Top, \$1,355 (3) Piece Top
- MFW: White, MFS: Silver, MFGG: Graphite Gray, MFSS: Salmon Sienna, MFSA: Surfin Aquavert, MFPS: Pistachio, MFOS: Oyster, MFNA: Navy, MFOL: Olive, MFGB: Grey Beige
- PLANK MATCH VENEER
- RPMV: Random Walnut Plank Match Veneer (Horizontal Grain with 25%+ Sap) - Add 10%. Clear coat only.

Edgeworks.

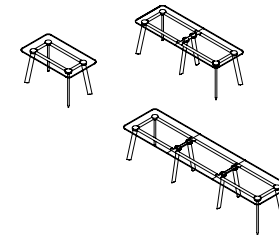
Glass Conference Tables
Rectangle 42" Depth Standing Height



1 Select a model w" x d" x h"	weight	Clear Gloss Glass Top Matte Black Metal Base		White Gloss Glass Top Matte Black Metal Base		Black Gloss Glass Top Matte Black Metal Base	
3 Piece Top							
240 x 42 x 42	470	EDG24042RE143SC	13961	EDG24042RE143SW	19694	EDG24042RE143SB	19694
216 x 42 x 42	390	EDG21642RE143SC	11636	EDG21642RE143SW	16795	EDG21642RE143SB	16795
198 x 42 x 42	365	EDG19842RE143SC	11291	EDG19842RE143SW	16021	EDG19842RE143SB	16021
2 Piece Top							
168 x 42 x 42	295	EDG16842RE142SC	8588	EDG16842RE142SW	12602	EDG16842RE142SB	12602
144 x 42 x 42	260	EDG14442RE142SC	8130	EDG14442RE142SW	11570	EDG14442RE142SB	11570
120 x 42 x 42	235	EDG12042RE142SC	7671	EDG12042RE142SW	10538	EDG12042RE142SB	10538
1 Piece Top							
96 x 42 x 42	175	EDG9642RE141SC	5072	EDG9642RE141SW	7365	EDG9642RE141SB	7365
84 x 42 x 42	160	EDG8442RE141SC	4843	EDG8442RE141SW	6850	EDG8442RE141SB	6850
72 x 42 x 42	150	EDG7242RE141SC	4613	EDG7242RE141SW	6334	EDG7242RE141SB	6334
2 Select a finish <i>View finish details</i>		MFMB		MFMB		MFMB	
Metal finish MFMB Matte Black. Additional metal finishes are available, see options.							
3 Select an edge <i>View edge details</i>							
		Flat		Flat		Flat	
4 Select hardware <i>View hardware details</i>		Hardware N/A		Hardware N/A		Hardware N/A	

[View statement of line](#)

Product features.

- 1/2" Clear glass top
- Matte black metal finish base standard
- 6" Radius corners
- 3" Adjustable glide
- Glass tops are glass finish, see options for Soft Etch Glass tops

NOTES

- Contact our customer service department for custom inset leg quote with glass tops
- 4 leg: 72" - 96" width
- 6 leg: 120" - 168" width
- 8 leg: 198" - 240" width

Options.

EDGE

- SC1: Modify radius corner to square corner - n/c

PREMIUM METAL FINISHES

- Specify Top Horn and Leg Metal Finish Color: \$660 (1) Piece Top, \$1,010 (2) Piece Top, \$1,355 (3) Piece Top
- MFV: White, MFS: Silver, MFGG: Graphite Gray, MFSS: Salmon Sienna, MFSA: Surfin Aquavert, MFPS: Pistachio, MFOS: Oyster, MFNA: Navy, MFOL: Olive, MFGB: Grey Beige

GLASS FINISH

- Optional Soft Etch Finished glass
- EB: Black Soft Etch Glass, EW: White Soft Etch Glass - n/c

POWER

- Glasspod cutouts will include an additional fee of \$125 per pod
- REF-310: Reef power unit with daisylink - \$1100 ea
- PD-Cove-PKO: Cove corded series - \$800 ea
- FPDB: Flush power/data bay
- Hardwired: FPDB-H72: 72" Cord - \$1250. FPDB-H108: 108" Cord - \$1300. FPDB-H144: 144" Cord - \$1350. FPDB-H180: 180" Cord - \$1400.
- Power/Plug: FPDB-C72: 72" Cord - \$1250. FPDB-C108: 108" Cord - \$1300. FPDB-C144: 144" - Cord \$1350. FPDB-C180: 180" Cord - \$1400

Edgeworks.

Conference Tables

Rectangle 48" Depth Sitting Height

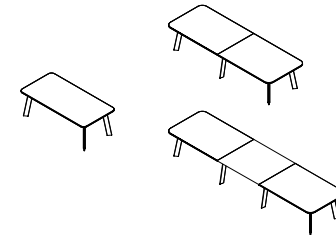

[View statement of line](#)

1 Select a model w" x d" x h"	weight	Standard Veneer Top Matte Black Metal Base		Premium Veneer Top Matte Black Metal Base		High Pressure Laminate Top Matte Black Metal Base		Thermally Fused Laminate Top Matte Black Metal Base	
		3 Piece Top 240 x 48 x 29 216 x 48 x 29 198 x 48 x 29 2 Piece Top 168 x 48 x 29 144 x 48 x 29 120 x 48 x 29 1 Piece Top 96 x 48 x 29 84 x 48 x 29 72 x 48 x 29		310 EDG24048RE123W 12318 420 EDG21648RE123W 10614 400 EDG19848RE123W 9457 325 EDG16848RE122W 7469 280 EDG14448RE122W 7207 255 EDG12048RE122W 6940 195 EDG9648RE121W 4237 175 EDG8448RE121W 4111 165 EDG7248RE121W 3986	EDG24048RE123P 13550 EDG21648RE123P 11675 EDG19848RE123P 10403 EDG16848RE122P 8216 EDG14448RE122P 7928 EDG12048RE122P 7634 EDG9648RE121P 4661 EDG8448RE121P 4523 EDG7248RE121P 4385	EDG24048RE123G 11936 EDG21648RE123G 9905 EDG19848RE123G 8922 EDG16848RE122G 6972 EDG14448RE122G 6754 EDG12048RE122G 6525 EDG9648RE121G 3953 EDG8448RE121G 3860 EDG7248RE121G 3756	EDG24048RE123M 10233 EDG21648RE123M 8398 EDG19848RE123M 7639 EDG16848RE122M 5826 EDG14448RE122M 5739 EDG12048RE122M 5712 EDG9648RE121M 3363 EDG8448RE121M 3303 EDG7248RE121M 3238	WLA WNW WAC WWP WEC WOC WAM WCM WWM WGW WBW WSW TBCO TBSW TSTV TSMV TSLV TOBW WBO WMO WSO GAC GSWL +10% GEC GWL GOC GAM GCM GWM GNW GSTV +10% MAC MEC MOC MGW MSW MTW MWL	Flat-1 Flat-2 Flat-3 (Black) (White) Ledge-1 Ledge-2 Ledge-3 (Finished) (Black) (White) Flat-1 Flat-2 Flat-3 (Black) (White) Ledge-1 Ledge-2 Ledge-3 (Finished) (Black) (White) Flat-1 Flat-2 Flat-3 (Black) (White) Ledge-1 Ledge-2 Ledge-3 (Finished) (Black) (White)

Product features.

- 1" Thick top with rounded edges
- ENVI-CT finish on wood tops
- Matte black metal finish base standard
- 6" Radius corners
- 3" Adjustable glide

NOTES

- 4 leg: 72" - 96" width
- 6 leg: 120" - 168" width
- 8 leg: 198" - 240" width

Options.

EDGE

- SC1: Modify radius corner to square corner - n/c

INSET LEGS

- IL2: Inset legs for two piece top - 10% upcharge
- IL3: Inset legs for a three piece top - 10% upcharge

POWER

- Two pods mounted under the hinged seamless grommet. Each pod has 4 power and 2 data ports. Telecom connectors sold separately.
- PSG82-C: Plug with 124" cord (8 power, 2 telecom plates) - \$1875 each
- W21: Grey Wire Manager (10.5") - \$35 ea.



PREMIUM METAL FINISHES

- Specify Top Horn and Leg Metal Finish Color: \$660 (1) Piece Top, \$1,010 (2) Piece Top, \$1,355 (3) Piece Top
- MFW: White, MFS: Silver, MFGG: Graphite Gray, MFSS: Salmon Sienna, MFSA: Surfin Aquavert, MFPS: Pistachio, MFOS: Oyster, MFNA: Navy, MFOL: Olive, MFGB: Grey Beige
- PLANK MATCH VENEER
- RPMV: Random Walnut Plank Match Veneer (Horizontal Grain with 25%+ Sap) - Add 10%. Clear coat only.

Edgeworks.

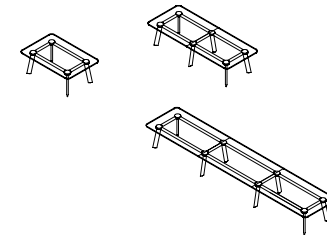
Glass Conference Tables
Rectangle 48" Depth Sitting Height



1 Select a model w" x d" x h"	weight	Clear Gloss Glass Top Matte Black Metal Base		White Gloss Glass Top Matte Black Metal Base		Black Gloss Glass Top Matte Black Metal Base	
		3 Piece Top 240 x 48 x 29 216 x 48 x 29 198 x 48 x 29 2 Piece Top 168 x 48 x 29 144 x 48 x 29 120 x 48 x 29 1 Piece Top 96 x 48 x 29 84 x 48 x 29 72 x 48 x 29	310 420 400 325 280 255 195 175 165	EDG24048RE123SC EDG21648RE123SC EDG19848RE123SC EDG16848RE122SC EDG14448RE122SC EDG12048RE122SC EDG9648RE121SC EDG8448RE121SC EDG7248RE121SC	13907 11657 11264 8622 8097 7573 5050 4788 4526	EDG24048RE123SW EDG21648RE123SW EDG19848RE123SW EDG16848RE122SW EDG14448RE122SW EDG12048RE122SW EDG9648RE121SW EDG8448RE121SW EDG7248RE121SW	20459 17554 16669 13208 12029 10849 7671 7081 6492
2 Select a finish MFMB View finish details Metal finish MFMB Matte Black. Additional metal finishes are available, see options.				MFMB		MFMB	
3 Select a edge View edge details  Flat				 Flat		 Flat	
4 Select hardware View hardware details Hardware N/A				Hardware N/A		Hardware N/A	

[View statement of line](#)

Product features.

- 1/2" Clear glass top
- Matte black metal finish base standard
- 6" Radius corners
- 3" Adjustable glide
- Glass tops are glass finish, see options for Soft Etch Glass tops

NOTES

- Contact our customer service department for custom inset leg quote with glass tops
- 4 leg: 72" - 96" width
- 6 leg: 120" - 168" width
- 8 leg: 198" - 240" width

Options.

EDGE

- SC1: Modify radius corner to square corner - n/c

PREMIUM METAL FINISHES

- Specify Top Horn and Leg Metal Finish Color: \$660 (1) Piece Top, \$1,010 (2) Piece Top, \$1,355 (3) Piece Top
- MFV: White, MFS: Silver, MFGG: Graphite Gray, MFSS: Salmon Sienna, MFSA: Surfin Aquavert, MFPS: Pistachio, MFOS: Oyster, MFNA: Navy, MFOL: Olive, MFGB: Grey Beige

GLASS FINISH

- Optional Soft Etch Finished glass
- EB: Black Soft Etch Glass, EW: White Soft Etch Glass - n/c

POWER

- Glasspod cutouts will include an additional fee of \$125 per pod
- REF-310: Reef power unit with daisylink - \$1100 ea
- PD-Cove-PKO: Cove corded series - \$800 ea
- FPDB: Flush power/data bay
- Hardwired: FPDB-H72: 72" Cord - \$1250. FPDB-H108: 108" Cord - \$1300. FPDB-H144: 144" Cord - \$1350. FPDB-H180: 180" Cord - \$1400.
- Power/Plug: FPDB-C72: 72" Cord - \$1250. FPDB-C108: 108" Cord - \$1300. FPDB-C144: 144" - Cord \$1350. FPDB-C180: 180" Cord - \$1400

Edgeworks.

Conference Tables
Rectangle 48" Depth Standing Height

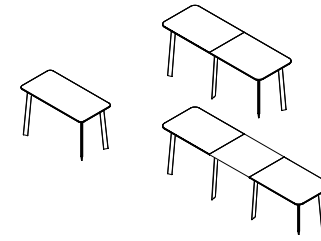

[View statement of line](#)

1 Select a model w" x d" x h"	weight	Standard Veneer Top Matte Black Metal Base		Premium Veneer Top Matte Black Metal Base		High Pressure Laminate Top Matte Black Metal Base		Thermally Fused Laminate Top Matte Black Metal Base	
		3 Piece Top 240 x 48 x 42 216 x 48 x 42 198 x 48 x 42 2 Piece Top 168 x 48 x 42 144 x 48 x 42 120 x 48 x 42 1 Piece Top 96 x 48 x 42 84 x 48 x 42 72 x 48 x 42		310 EDG24048RE143W 13229 420 EDG21648RE143W 11182 400 EDG19848RE143W 10025 325 EDG16848RE142W 7786 280 EDG14448RE142W 7634 255 EDG12048RE142W 7365 195 EDG9648RE141W 4663 175 EDG8448RE141W 4395 165 EDG7248RE141W 4270	EDG24048RE143P 14552 EDG21648RE143P 12300 EDG19848RE143P 11028 EDG16848RE142P 8565 EDG14448RE142P 8398 EDG12048RE142P 8102 EDG9648RE141P 5130 EDG8448RE141P 4835 EDG7248RE141P 4697	TBCO TBSW TSTV TSMV TSLV TOBW WBO WMO WSO	GAC GSWL +10% GEC GWL GOC GAM GCM GWM GNW GSTV +10%	MAC MEC MOC MGW MSW MTW MWL	EDG24048RE143G 13229 EDG21648RE143G 10473 EDG19848RE143G 9490 EDG16848RE142G 7399 EDG14448RE142G 7180 EDG12048RE142G 6950 EDG9648RE141G 4379 EDG8448RE141G 4144 EDG7248RE141G 4040
2 Select a finish View finish details Metal finish MFMB Matte Black. Additional metal finishes are available, see options.	WLA WNW WAC WWP WEC WOC WAM WCM WWM WGW WBW WSW								
3 Select a edge View edge details									
4 Select hardware View hardware details	Hardware N/A	Hardware N/A	Hardware N/A	Hardware N/A					

Product features.

- 1" Thick top with rounded edges
- ENVI-CT finish on wood tops
- Matte black metal finish base standard
- 6" Radius corners
- 3" Adjustable glide

NOTES

- 4 leg: 72" - 96" width
- 6 leg: 120" - 168" width
- 8 leg: 198" - 240" width

Options.

EDGE

- SC1: Modify radius corner to square corner - n/c

INSET LEGS

- IL2: Inset legs for two piece top - 10% upcharge
- IL3: Inset legs for a three piece top - 10% upcharge

POWER

- Two pods mounted under the hinged seamless grommet. Each pod has 4 power and 2 data ports. Telecom connectors sold separately.
- PSG82-C: Plug with 124" cord (8 power, 2 telecom plates) - \$1875 each
- W21: Grey Wire Manager (10.5") - \$35 ea.



PREMIUM METAL FINISHES

- Specify Top Horn and Leg Metal Finish Color: \$660 (1) Piece Top, \$1,010 (2) Piece Top, \$1,355 (3) Piece Top
- MFW: White, MFS: Silver, MFGG: Graphite Gray, MFSS: Salmon Sienna, MFSA: Surfin Aquavert, MFPS: Pistachio, MFOS: Oyster, MFNA: Navy, MFOL: Olive, MFGB: Grey Beige
- PLANK MATCH VENEER
- RPMV: Random Walnut Plank Match Veneer (Horizontal Grain with 25%+ Sap) - Add 10%. Clear coat only.

Edgeworks.

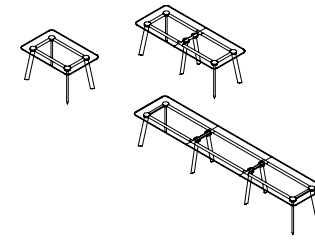
Glass Conference Tables
Rectangle 48" Depth Standing Height



1 Select a model w" x d" x h"	weight	Clear Gloss Glass Top Matte Black Metal Base		White Gloss Glass Top Matte Black Metal Base		Black Gloss Glass Top Matte Black Metal Base	
3 Piece Top							
240 x 48 x 42	310	EDG24048RE143SC	14616	EDG24048RE143SW	21168	EDG24048RE143SB	21168
216 x 48 x 42	420	EDG21648RE143SC	12225	EDG21648RE143SW	18122	EDG21648RE143SB	18122
198 x 48 x 42	400	EDG19848RE143SC	11832	EDG19848RE143SW	17237	EDG19848RE143SB	17237
2 Piece Top							
168 x 48 x 42	325	EDG16848RE142SC	9047	EDG16848RE142SW	13633	EDG16848RE142SB	13633
144 x 48 x 42	280	EDG14448RE142SC	8523	EDG14448RE142SW	12454	EDG14448RE142SB	12454
120 x 48 x 42	255	EDG12048RE142SC	7999	EDG12048RE142SW	11275	EDG12048RE142SB	11275
1 Piece Top							
96 x 48 x 42	195	EDG9648RE141SC	5334	EDG9648RE141SW	7955	EDG9648RE141SB	7955
84 x 48 x 42	175	EDG8448RE141SC	5072	EDG8448RE141SW	7365	EDG8448RE141SB	7365
72 x 48 x 42	165	EDG7248RE141SC	4810	EDG7248RE141SW	6776	EDG7248RE141SB	6776
2 Select a finish View finish details		MFMB		MFMB		MFMB	
Metal finish MFMB Matte Black. Additional metal finishes are available, see options.							
3 Select a edge View edge details							
		Flat		Flat		Flat	
4 Select hardware View hardware details		Hardware N/A		Hardware N/A		Hardware N/A	

View statement of line

Product features.

- 1/2" Clear glass top
- Matte black metal finish base standard
- 6" Radius corners
- 3" Adjustable glide
- Glass tops are glass finish, see options for Soft Etch Glass tops

NOTES

- Contact our customer service department for custom inset leg quote with glass tops
- 4 leg: 72" - 96" width
- 6 leg: 120" - 168" width
- 8 leg: 198" - 240" width

Options.

EDGE

- SC1: Modify radius corner to square corner - n/c

PREMIUM METAL FINISHES

- Specify Top Horn and Leg Metal Finish Color: \$660 (1) Piece Top, \$1,010 (2) Piece Top, \$1,355 (3) Piece Top
- MFW: White, MFS: Silver, MFGG: Graphite Gray, MFSS: Salmon Sienna, MFSA: Surfin Aquavert, MFPS: Pistachio, MFOS: Oyster, MFNA: Navy, MFOL: Olive, MFGB: Grey Beige

GLASS FINISH

- Optional Soft Etch Finished glass
- EB: Black Soft Etch Glass, EW: White Soft Etch Glass - n/c

POWER

- Glasspod cutouts will include an additional fee of \$125 per pod
- REF-310: Reef power unit with daisylink - \$1100 ea
- PD-Cove-PKO: Cove corded series - \$800 ea
- FPDB: Flush power/data bay
- Hardwired: FPDB-H72: 72" Cord - \$1250. FPDB-H108: 108" Cord - \$1300. FPDB-H144: 144" Cord - \$1350. FPDB-H180: 180" Cord - \$1400.
- Power/Plug: FPDB-C72: 72" Cord - \$1250. FPDB-C108: 108" Cord - \$1300. FPDB-C144: 144" - Cord \$1350. FPDB-C180: 180" Cord - \$1400

Edgeworks.

Conference Tables

Rectangle 54" Depth Sitting Height

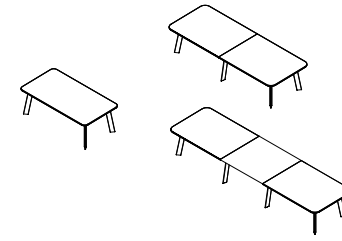

[View statement of line](#)

1 Select a model w" x d" x h"	weight	Standard Veneer Top Matte Black Metal Base		Premium Veneer Top Matte Black Metal Base		High Pressure Laminate Top Matte Black Metal Base		Thermally Fused Laminate Top Matte Black Metal Base		
		3 Piece Top 240 x 54 x 29 216 x 54 x 29 198 x 54 x 29 2 Piece Top 168 x 54 x 29 144 x 54 x 29 120 x 54 x 29 1 Piece Top 96 x 54 x 29 84 x 54 x 29 72 x 54 x 29								
		535	EDG24054RE123W 13393	EDG24054RE123P 14733	EDG24054RE123G 12526	EDG24054RE123M 10342				
		450	EDG21654RE123W 11259	EDG21654RE123P 12385	EDG21654RE123G 10456	EDG21654RE123M 8212				
		420	EDG19854RE123W 9942	EDG19854RE123P 10937	EDG19854RE123G 9337	EDG19854RE123M 7693				
		350	EDG16854RE122W 7918	EDG16854RE122P 8710	EDG16854RE122G 7355	EDG16854RE122M 5892				
		315	EDG14454RE122W 7622	EDG14454RE122P 8385	EDG14454RE122G 7103	EDG14454RE122M 5804				
		280	EDG12054RE122W 7316	EDG12054RE122P 8048	EDG12054RE122G 6847	EDG12054RE122M 5766				
		155	EDG9654RE121W 4461	EDG9654RE121P 4908	EDG9654RE121G 4155	EDG9654RE121M 3478				
		135	EDG8454RE121W 4302	EDG8454RE121P 4733	EDG8454RE121G 4040	EDG8454RE121M 3446				
		180	EDG7254RE121W 4139	EDG7254RE121P 4553	EDG7254RE121G 3921	EDG7254RE121M 3412				
2 Select a finish View finish details										
		WLA	WNW	TBCO	GAC	GSLV +10%	MAC			
		WAC	WWP	TBSW	GEC	GWL	MEC			
		WEC		TSTV	GOC		MOC			
		WOC		TSMV	GAM		MGW			
		WAM		TSLV	GCM		MSW			
		WCM		TOBW	GWM		MTW			
		WWM		WBO	GNW		MWL			
		WGW		WMO	GSTV					
		WBW		WSO	+10%					
		WSW								
3 Select a edge View edge details										
4 Select hardware View hardware details										
		Hardware		Hardware	Hardware		Hardware			
		N/A		N/A	N/A		N/A			

Product features.

- 1" Thick top with rounded edges
- ENVI-CT finish on wood tops
- Matte black metal finish base standard
- 6" Radius corners
- 3" Adjustable glide

NOTES

- 4 leg: 72" - 96" width
- 6 leg: 120" - 168" width
- 8 leg: 198" - 240" width

Options.

EDGE

- SC1: Modify radius corner to square corner - n/c

INSET LEGS

- IL2: Inset legs for two piece top - 10% upcharge
- IL3: Inset legs for a three piece top - 10% upcharge

POWER

- Two pods mounted under the hinged seamless grommet. Each pod has 4 power and 2 data ports. Telecom connectors sold separately.
- PSG82-C: Plug with 124" cord (8 power, 2 telecom plates) - \$1875 each
- W21: Grey Wire Manager (10.5") - \$35 ea.

PREMIUM METAL FINISHES

- Specify Top Horn and Leg Metal Finish Color: \$660 (1) Piece Top, \$1,010 (2) Piece Top, \$1,355 (3) Piece Top
- MFW: White, MFS: Silver, MFGG: Graphite Gray, MFSS: Salmon Sienna, MFSA: Surfin Aquavert, MFPS: Pistachio, MFOS: Oyster, MFNA: Navy, MFOL: Olive, MFGB: Grey Beige

PLANK MATCH VENEER

- RPMV: Random Walnut Plank Match Veneer (Horizontal Grain with 25%+ Sap) - Add 10%. Clear coat only.

Edgeworks.

Glass Conference Tables
Rectangle 54" Depth Sitting Height

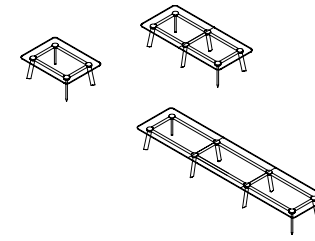

1 Select a model w" x d" x h"	weight	Clear Gloss Glass Top Matte Black Metal Base		White Gloss Glass Top Matte Black Metal Base		Black Gloss Glass Top Matte Black Metal Base	
3 Piece Top							
240 x 54 x 29	535	EDG24054RE123SC	14562	EDG24054RE123SW	21933	EDG24054RE123SB	21933
216 x 54 x 29	450	EDG21654RE123SC	12247	EDG21654RE123SW	18881	EDG21654RE123SB	18881
198 x 54 x 29	420	EDG19854RE123SC	11805	EDG19854RE123SW	17886	EDG19854RE123SB	17886
2 Piece Top							
168 x 54 x 29	350	EDG16854RE122SC	9080	EDG16854RE122SW	14240	EDG16854RE122SB	14240
144 x 54 x 29	315	EDG14454RE122SC	8491	EDG14454RE122SW	12913	EDG14454RE122SB	12913
120 x 54 x 29	280	EDG12054RE122SC	7999	EDG12054RE122SW	11587	EDG12054RE122SB	11587
1 Piece Top							
96 x 54 x 29	155	EDG9654RE121SC	5312	EDG9654RE121SW	8261	EDG9654RE121SB	8261
84 x 54 x 29	135	EDG8454RE121SC	5018	EDG8454RE121SW	7598	EDG8454RE121SB	7598
72 x 54 x 29	180	EDG7254RE121SC	4723	EDG7254RE121SW	6935	EDG7254RE121SB	6935
2 Select a finish View finish details		MFMB		MFMB		MFMB	
Metal finish MFMB Matte Black. Additional metal finishes are available, see options.							
3 Select a edge View edge details		Flat		Flat		Flat	
4 Select hardware View hardware details		Hardware N/A		Hardware N/A		Hardware N/A	

[View statement of line](#)

Product features.

- 1/2" Clear glass top
- Matte black metal finish base standard
- 6" Radius corners
- 3" Adjustable glide
- Glass tops are glass finish, see options for Soft Etch Glass tops

NOTES

- Contact our customer service department for custom inset leg quote with glass tops
- 4 leg: 72" - 96" width
- 6 leg: 120" - 168" width
- 8 leg: 198" - 240" width

Options.

EDGE

- SC1: Modify radius corner to square corner - n/c

PREMIUM METAL FINISHES

- Specify Top Horn and Leg Metal Finish Color: \$660 (1) Piece Top, \$1,010 (2) Piece Top, \$1,355 (3) Piece Top
- MFV: White, MFS: Silver, MFGG: Graphite Gray, MFSS: Salmon Sienna, MFSA: Surfin Aquavert, MFPS: Pistachio, MFOS: Oyster, MFNA: Navy, MFOL: Olive, MFGB: Grey Beige

GLASS FINISH

- Optional Soft Etch Finished glass
- EB: Black Soft Etch Glass, EW: White Soft Etch Glass - n/c

POWER

- Glasspod cutouts will include an additional fee of \$125 per pod
- REF-310: Reef power unit with daisylink - \$1100 ea
- PD-Cove-PKO: Cove corded series - \$800 ea
- FPDB: Flush power/data bay
- Hardwired: FPDB-H72: 72" Cord - \$1250. FPDB-H108: 108" Cord - \$1300. FPDB-H144: 144" Cord - \$1350. FPDB-H180: 180" Cord - \$1400.
- Power/Plug: FPDB-C72: 72" Cord - \$1250. FPDB-C108: 108" Cord - \$1300. FPDB-C144: 144" - Cord \$1350. FPDB-C180: 180" Cord - \$1400

Edgeworks.

Conference Tables
Rectangle 54" Depth Standing Height

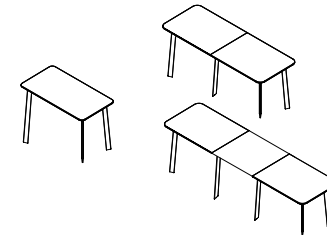

1 Select a model w" x d" x h"	weight	Standard Veneer Top Matte Black Metal Base		Premium Veneer Top Matte Black Metal Base		High Pressure Laminate Top Matte Black Metal Base		Thermally Fused Laminate Top Matte Black Metal Base	
		3 Piece Top 240 x 54 x 42 216 x 54 x 42 198 x 54 x 42 2 Piece Top 168 x 54 x 42 144 x 54 x 42 120 x 54 x 42 1 Piece Top 96 x 54 x 42 84 x 54 x 42 72 x 54 x 42		535 EDG24054RE143W 14103 450 EDG21654RE143W 11827 420 EDG19854RE143W 10510 350 EDG16854RE142W 8343 315 EDG14454RE142W 8049 280 EDG12054RE142W 7743 155 EDG9654RE141W 4887 135 EDG8454RE141W 4657 180 EDG7254RE141W 4423	EDG24054RE143P 15514 EDG21654RE143P 13010 EDG19854RE143P 11561 EDG16854RE142P 9178 EDG14454RE142P 8854 EDG12054RE142P 8518 EDG9654RE141P 5376 EDG8454RE141P 5123 EDG7254RE141P 4866	13235 EDG24054RE143G 11024 EDG21654RE143G 9905 EDG19854RE143G 7780 EDG16854RE142G 7530 EDG14454RE142G 7273 EDG12054RE142G 4581 EDG9654RE141G 4324 EDG8454RE141G 4205 EDG7254RE141G	11051 EDG24054RE143M 8780 EDG21654RE143M 8261 EDG19854RE143M 6317 EDG16854RE142M 6230 EDG14454RE142M 6192 EDG12054RE142M 3904 EDG9654RE141M 3696 EDG8454RE141M 3729 EDG7254RE141M		
2 Select a finish View finish details Metal finish MFMB Matte Black. Additional metal finishes are available, see options.	WLA WNW WAC WWP WEC WOC WAM WCM WWM WGW WBW WSW	TBCO TBSW TSTV TSMV TSLV TOBW WBO WMO WSO	GAC GSWL +10% GEC GWL GOC GAM GCM GWM GNW GSTV +10%	MAC MEC MOC MGW MSW MTW MWL					
3 Select a edge View edge details									
4 Select hardware View hardware details	Hardware N/A	Hardware N/A	Hardware N/A	Hardware N/A					

View statement of line

Product features.

- 1" Thick top with rounded edges
- ENVI-CT finish on wood tops
- Matte black metal finish base standard
- 6" Radius corners
- 3" Adjustable glide

NOTES

- 4 leg: 72" - 96" width
- 6 leg: 120" - 168" width
- 8 leg: 198" - 240" width

Options.

EDGE

- SC1: Modify radius corner to square corner - n/c

INSET LEGS

- IL2: Inset legs for two piece top - 10% upcharge
- IL3: Inset legs for a three piece top - 10% upcharge

POWER

- Two pods mounted under the hinged seamless grommet. Each pod has 4 power and 2 data ports. Telecom connectors sold separately.
- PSG82-C: Plug with 124" cord (8 power, 2 telecom plates) - \$1875 each
- W21: Grey Wire Manager (10.5") - \$35 ea.

PREMIUM METAL FINISHES



- Specify Top Horn and Leg Metal Finish Color: \$660 (1) Piece Top, \$1,010 (2) Piece Top, \$1,355 (3) Piece Top
- MFW: White, MFS: Silver, MFGG: Graphite Gray, MFSS: Salmon Sienna, MFSA: Surfin Aquavert, MFPS: Pistachio, MFOS: Oyster, MFNA: Navy, MFOL: Olive, MFGB: Grey Beige
- PLANK MATCH VENEER
- RPMV: Random Walnut Plank Match Veneer (Horizontal Grain with 25%+ Sap) - Add 10%. Clear coat only.

Edgeworks.

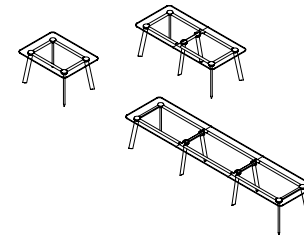
Glass Conference Tables
Rectangle 54" Depth Standing Height



[View statement of line](#)

1 Select a model w" x d" x h"	weight	Clear Gloss Glass Top Matte Black Metal Base	White Gloss Glass Top Matte Black Metal Base	Black Gloss Glass Top Matte Black Metal Base
3 Piece Top				
240 x 54 x 42	535	EDG24054RE143SC 15271	EDG24054RE143SW 22643	EDG24054RE143SB 22643
216 x 54 x 42	450	EDG21654RE143SC 12815	EDG21654RE143SW 19449	EDG21654RE143SCB 19449
198 x 54 x 42	420	EDG19854RE143SC 12373	EDG19854RE143SW 18454	EDG19854RE143SB 18454
2 Piece Top				
168 x 54 x 42	350	EDG16854RE142SC 9506	EDG16854RE142SW 14666	EDG16854RE142SB 14666
144 x 54 x 42	315	EDG14454RE142SC 8916	EDG14454RE142SW 13339	EDG14454RE142SB 13339
120 x 54 x 42	280	EDG12054RE142SC 8326	EDG12054RE142SW 12012	EDG12054RE142SB 12012
1 Piece Top				
96 x 54 x 42	155	EDG9654RE141SC 5596	EDG9654RE141SW 8545	EDG9654RE141SB 8545
84 x 54 x 42	135	EDG8454RE141SC 5302	EDG8454RE141SW 7882	EDG8454RE141SB 7882
72 x 54 x 42	180	EDG7254RE141SC 5007	EDG7254RE141SW 7219	EDG7254RE141SB 7219
2 Select a finish View finish details		MFMB	MFMB	MFMB
Metal finish MFMB Matte Black. Additional metal finishes are available, see options.				
3 Select a edge View edge details		 Flat	 Flat	 Flat
4 Select hardware View hardware details		Hardware N/A	Hardware N/A	Hardware N/A

Product features.

- 1/2" Clear glass top
- Matte black metal finish base standard
- 6" Radius corners
- 3" Adjustable glide
- Glass tops are glass finish, see options for Soft Etch Glass tops

NOTES

- Contact our customer service department for custom inset leg quote with glass tops
- 4 leg: 72" - 96" width
- 6 leg: 120" - 168" width
- 8 leg: 198" - 240" width

Options.

EDGE

- SC1: Modify radius corner to square corner - n/c

PREMIUM METAL FINISHES

- Specify Top Horn and Leg Metal Finish Color: \$660 (1) Piece Top, \$1,010 (2) Piece Top, \$1,355 (3) Piece Top
- MFV: White, MFS: Silver, MFGG: Graphite Gray, MFSS: Salmon Sienna, MFSA: Surfin Aquavert, MFPS: Pistachio, MFOS: Oyster, MFNA: Navy, MFOL: Olive, MFGB: Grey Beige

GLASS FINISH

- Optional Soft Etch Finished glass
- EB: Black Soft Etch Glass, EW: White Soft Etch Glass - n/c

POWER

- Glasspod cutouts will include an additional fee of \$125 per pod
- REF-310: Reef power unit with daisylink - \$1100 ea
- PD-Cove-PKO: Cove corded series - \$800 ea
- FPDB: Flush power/data bay
- Hardwired: FPDB-H72: 72" Cord - \$1250. FPDB-H108: 108" Cord - \$1300. FPDB-H144: 144" Cord - \$1350. FPDB-H180: 180" Cord - \$1400.
- Power/Plug: FPDB-C72: 72" Cord - \$1250. FPDB-C108: 108" Cord - \$1300. FPDB-C144: 144" - Cord \$1350. FPDB-C180: 180" Cord - \$1400

Edgeworks.

Conference Tables
Rectangle 60" Depth Sitting Height

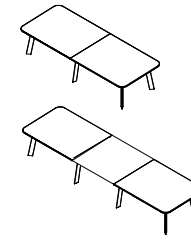

1 Select a model w" x d" x h"	weight	Standard Veneer Top Matte Black Metal Base		Premium Veneer Top Matte Black Metal Base		High Pressure Laminate Top Matte Black Metal Base		Thermally Fused Laminate Top Matte Black Metal Base	
		3 Piece Top 240 x 60 x 29 216 x 60 x 29 198 x 60 x 29 2 Piece Top 168 x 60 x 29 144 x 60 x 29 120 x 60 x 29	580 490 445 375 335 290	EDG24060RE123W EDG21660RE123W EDG19860RE123W EDG16860RE122W EDG14460RE122W EDG12060RE122W	14179 11990 10495 8430 8092 7743	EDG24060RE123P EDG21660RE123P EDG19860RE123P EDG16860RE122P EDG14460RE122P EDG12060RE122P	15597 13189 11545 9273 8902 8518	EDG24060RE123G EDG21660RE123G EDG19860RE123G EDG16860RE122G EDG14460RE122G EDG12060RE122G	13197 11078 9806 7792 7503 7207
2 Select a finish <i>View finish details</i> Metal finish MFMB Matte Black. Additional metal finishes are available, see options.	WLA WNW WAC WWP WEC WOC WAM WCM WWM WGW WBW WSW	TBCO TBSW TSTV TSMV TSLV TOBW WBO WMO WSO	GAC GSWL +10% GEC GWL GOC GAM GCM GWM GNW GSTV +10%	MAC MEC MOC MGW MSW MTW MWL					
3 Select a edge <i>View edge details</i>									
4 Select hardware <i>View hardware details</i>	Hardware N/A	Hardware N/A	Hardware N/A	Hardware N/A					

View statement of line

Product features.

- 1" Thick top with rounded edges
- ENVI-CT finish on wood tops
- Matte black metal finish base standard
- 6" Radius corners
- 3" Adjustable glide

NOTES

- 6 leg: 120" - 168" width
- 8 leg: 198" - 240" width

Options.

EDGE

- SC1: Modify radius corner to square corner - n/c

INSET LEGS

- IL2: Inset legs for two piece top - 10% upcharge
- IL3: Inset legs for a three piece top - 10% upcharge

POWER

- Two pods mounted under the hinged seamless grommet. Each pod has 4 power and 2 data ports. Telecom connectors sold separately.
- PSG82-C: Plug with 124" cord (8 power, 2 telecom plates) - \$1875 each
- W21: Grey Wire Manager (10.5") - \$35 ea.

PREMIUM METAL FINISHES

- Specify Top Horn and Leg Metal Finish Color: \$1,010 (2) Piece Top, \$1,355 (3) Piece Top
- MFW: White, MFS: Silver, MFGG: Graphite Gray, MFSS: Salmon Sienna, MFSA: Surfin Aquavert, MFPS: Pistachio, MFOS: Oyster, MFNA: Navy, MFOL: Olive, MFGB: Grey Beige

PLANK MATCH VENEER

- RPMV: Random Walnut Plank Match Veneer (Horizontal Grain with 25%+ Sap) - Add 10%. Clear coat only.

Edgeworks.

Glass Conference Tables
Rectangle 60" Depth Sitting Height

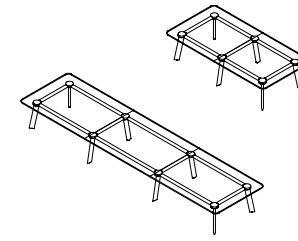

1 Select a model w" x d" x h"	weight	Clear Gloss Glass Top Matte Black Metal Base		White Gloss Glass Top Matte Black Metal Base		Black Gloss Glass Top Matte Black Metal Base	
3 Piece Top							
240 x 60 x 29	580	EDG24060RE123SC	15217	EDG24060RE123SW	23407	EDG24060RE123SB	23407
216 x 60 x 29	490	EDG21660RE123SC	12837	EDG21660RE123SW	20207	EDG21660RE123SB	20207
198 x 60 x 29	445	EDG19860RE123SC	12345	EDG19860RE123SW	19103	EDG19860RE123SB	19103
2 Piece Top							
168 x 60 x 29	375	EDG16860RE122SC	9539	EDG16860RE122SW	15271	EDG16860RE122SB	15271
144 x 60 x 29	335	EDG14460RE122SC	8884	EDG14460RE122SW	13798	EDG14460RE122SB	13798
120 x 60 x 29	290	EDG12060RE122SC	8228	EDG12060RE122SW	12323	EDG12060RE122SB	12323
2 Select a finish View finish details		MFMB		MFMB		MFMB	
Metal finish MFMB Matte Black. Additional metal finishes are available, see options.							
3 Select a edge View edge details		Flat		Flat		Flat	
4 Select hardware View hardware details		Hardware N/A		Hardware N/A		Hardware N/A	

View statement of line

Product features.

- 1/2" Clear glass top
- Matte black metal finish base standard
- 6" Radius corners
- 3" Adjustable glide
- Glass tops are gloss finish, see options for Soft Etch Glass tops

NOTES

- Contact our customer service department for custom inset leg quote with glass tops
- 6 leg: 120" - 168" width
- 8 leg: 198" - 240" width

Options.

EDGE

- SC1: Modify radius corner to square corner - n/c

PREMIUM METAL FINISHES

- Specify Top Horn and Leg Metal Finish Color: \$1,010 (2) Piece Top, \$1,355 (3) Piece Top
- MFW: White, MFS: Silver, MFGG: Graphite Gray, MFSS: Salmon Sienna, MFSA: Surfin Aquavert, MFPS: Pistachio, MFOS: Oyster, MFNA: Navy, MFOL: Olive, MFGB: Grey Beige

GLASS FINISH

- Optional Soft Etch Finished glass
- EB: Black Soft Etch Glass, EW: White Soft Etch Glass - n/c

POWER

- Glasspod cutouts will include an additional fee of \$125 per pod
- REF-310: Reef power unit with daisylink - \$1100 ea
- PD-Cove-PKO: Cove corded series - \$800 ea
- FPDB: Flush power/data bay
- Hardwired: FPDB-H72: 72" Cord - \$1250. FPDB-H108: 108" Cord - \$1300. FPDB-H144: 144" Cord - \$1350. FPDB-H180: 180" Cord - \$1400.
- Power/Plug: FPDB-C72: 72" Cord - \$1250. FPDB-C108: 108" Cord - \$1300. FPDB-C144: 144" - Cord \$1350. FPDB-C180: 180" Cord - \$1400

Edgeworks.

Conference Tables
Rectangle 60" Depth Standing Height

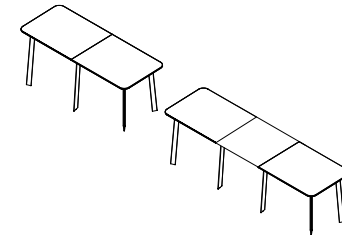

1 Select a model w" x d" x h"	weight	Standard Veneer Top Matte Black Metal Base		Premium Veneer Top		High Pressure Laminate Top Matte Black Metal Base		Thermally Fused Laminate Top Matte Black Metal Base	
		3 Piece Top 240 x 60 x 42 216 x 60 x 42 198 x 60 x 42 2 Piece Top 168 x 60 x 42 144 x 60 x 42 120 x 60 x 42	580 490 445 375 335 290	EDG24060RE143W EDG21660RE143W EDG19860RE143W EDG16860RE142W EDG14460RE142W EDG12060RE142W	14890 12558 11062 8857 8518 8168	EDG24060RE143P EDG21660RE143P EDG19860RE143P EDG16860RE142P EDG14460RE142P EDG12060RE142P	16379 13814 12169 9743 9370 8985	EDG24060RE143G EDG21660RE143G EDG19860RE143G EDG16860RE142G EDG14460RE142G EDG12060RE142G	13907 11646 10374 8217 7928 7634
2 Select a finish View finish details Metal finish MFMB Matte Black. Additional metal finishes are available, see options.	WLA WNW WAC WWP WEC WOC WAM WCM WWM WGW WBW WSW	TBCO TBSW TSTV TSMV TSLV TOBW WBO WMO WSO	GAC GSWL +10% GEC GWL GOC GAM GCM GWM GNW GSTV +10%	MAC MEC MOC MGW MSW MTW MWL	3 Select an edge View edge details 	4 Select hardware View hardware details Hardware N/A	Hardware N/A	Hardware N/A	Hardware N/A

[View statement of line](#)

Product features.

- 1" Thick top with rounded edges
- ENVI-CT finish on wood tops
- Matte black metal finish base standard
- 6" Radius corners
- 3" Adjustable glide

NOTES

- 6 leg: 120" - 168" width
- 8 leg: 198" - 240" width

Options.

EDGE

- SC1: Modify radius corner to square corner - n/c

INSET LEGS

- IL2: Inset legs for two piece top - 10% upcharge
- IL3: Inset legs for a three piece top - 10% upcharge

POWER

- Two pods mounted under the hinged seamless grommet. Each pod has 4 power and 2 data ports. Telecom connectors sold separately.
- PSG82-C: Plug with 124" cord (8 power, 2 telecom plates) - \$1875 each
- W21: Grey Wire Manager (10.5") - \$35 ea.

PREMIUM METAL FINISHES

- Specify Top Horn and Leg Metal Finish Color: \$1,010 (2) Piece Top, \$1,355 (3) Piece Top
- MFW: White, MFS: Silver, MFGG: Graphite Gray, MFSS: Salmon Sienna, MFSA: Surfing Aquavert, MFPS: Pistachio, MFOS: Oyster, MFNA: Navy, MFOL: Olive, MFGB: Grey Beige

PLANK MATCH VENEER

- RPMV: Random Walnut Plank Match Veneer (Horizontal Grain with 25%+ Sap) - Add 10%. Clear coat only.

Edgeworks.

Glass Conference Tables
Rectangle 60" Depth Standing Height

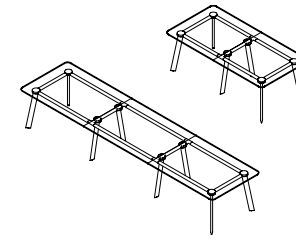

[View statement of line](#)

1 Select a model w" x d" x h"	weight	Clear Gloss Glass Top Metal Base		White Gloss Glass Top Metal Base		Black Gloss Glass Top Metal Base	
		3 Piece Top					
240 x 60 x 42	580	EDG24060RE143SC	15927	EDG24060RE143SW	24117	EDG24060RE143SB	24117
216 x 60 x 42	490	EDG21660RE143SC	13405	EDG21660RE143SW	20775	EDG21660RE143SB	20775
198 x 60 x 42	445	EDG19860RE143SC	12913	EDG19860RE143SW	19671	EDG19860RE143SB	19671
2 Piece Top							
168 x 60 x 42	375	EDG16860RE142SC	9964	EDG16860RE142SW	15698	EDG16860RE142SB	15698
144 x 60 x 42	335	EDG14460RE142SC	9309	EDG14460RE142SW	14223	EDG14460RE142SB	14223
120 x 60 x 42	290	EDG12060RE142SC	8654	EDG12060RE142SW	12749	EDG12060RE142SB	12749
2 Select a finish View finish details		MFMB		MFMB		MFMB	
Metal finish MFMB Matte Black. Additional metal finishes are available, see options.							
3 Select an edge View edge details		Flat					
4 Select hardware View hardware details		Hardware N/A					

Product features.

- 1/2" Clear glass top
- Matte black metal finish base standard
- 6" Radius corners
- 3" Adjustable glide
- Glass tops are glass finish, see options for Soft Etch Glass tops

NOTES

- Contact our customer service department for custom inset leg quote with glass tops
- 6 leg: 120" - 168" width
- 8 leg: 198" - 240" width

Options.

EDGE

- SC1: Modify radius corner to square corner - n/c

PREMIUM METAL FINISHES

- Specify Top Horn and Leg Metal Finish Color: \$1,010 (2) Piece Top, \$1,355 (3) Piece Top
- MFW: White, MFS: Silver, MFGG: Graphite Gray, MFSS: Salmon Sienna, MFSA: Surfin Aquavert, MFPS: Pistachio, MFOS: Oyster, MFNA: Navy, MFOL: Olive, MFGB: Grey Beige

GLASS FINISH

- Optional Soft Etch Finished glass
- EB: Black Soft Etch Glass, EW: White Soft Etch Glass - n/c

POWER

- Glasspod cutouts will include an additional fee of \$125 per pod
- REF-310: Reef power unit with daisylink - \$1100 ea
- PD-Cove-PKO: Cove corded series - \$800 ea
- FPDB: Flush power/data bay
- Hardwired: FPDB-H72: 72" Cord - \$1250. FPDB-H108: 108" Cord - \$1300. FPDB-H144: 144" Cord - \$1350. FPDB-H180: 180" Cord - \$1400.
- Power/Plug: FPDB-C72: 72" Cord - \$1250. FPDB-C108: 108" Cord - \$1300. FPDB-C144: 144" - Cord \$1350. FPDB-C180: 180" Cord - \$1400

Edgeworks.

Full Pedestal Credenzas
 Conferencing Storage Credenza

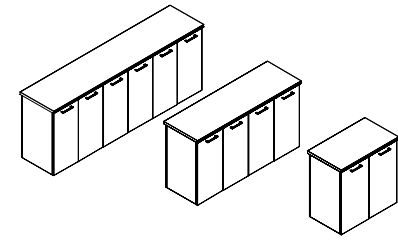

1 Select a model w" x d" x h"

weight	Standard Veneer Top Standard Veneer Chassis		Premium Veneer Top Premium Veneer Chassis		High Pressure Laminate Top Standard Veneer Chassis		Thermally Fused Laminate Top Thermally Fused Laminate Chassis	
	Double Storage							
72 x 24 x 36	EDG7224CA124W	4107	EDG7224CA124P	4518	EDG7224CA124G	4107	EDG7224CA124M	2725
66 x 24 x 36	EDG6624CA124W	3972	EDG6624CA124P	4369	EDG6624CA124G	3972	EDG6624CA124M	2676
60 x 24 x 36	EDG6024CA124W	3837	EDG6024CA124P	4221	EDG6024CA124G	3837	EDG6024CA124M	2626
48 x 24 x 36	EDG4824CA124W	3508	EDG4824CA124P	3859	EDG4824CA124G	3508	EDG4824CA124M	2473
Single Storage								
36 x 24 x 36	EDG3624CA124W	2335	EDG3624CA124P	2569	EDG3624CA124G	2335	EDG3624CA124M	1507

[View statement of line](#)

2 Select a finish [View finish details](#)

WLA WNW
 WAC WWP
 WEC
 WOC
 WAM
 WCM
 WWM
 WGW
 WBW
 WSW

TBCO
 TBSW
 TSTV
 TSMV
 TSLV
 TOBW
 WBO
 WMO
 WSO

GAC GSWL +10%
 GEC GWL
 GOC
 GAM
 GCM
 GWM
 GNW
 GSTV
 +10%

MAC
 MEC
 MOC
 MGW
 MSW
 MTW
 MWL

3 Select an edge [View edge details](#)

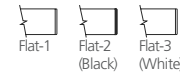
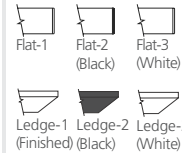
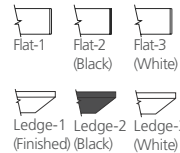
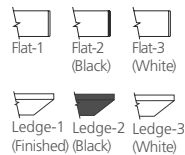

4 Select hardware [View hardware details](#)

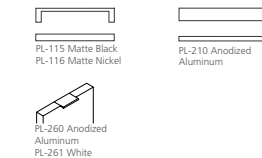
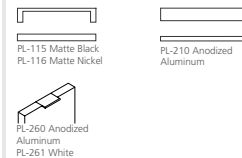
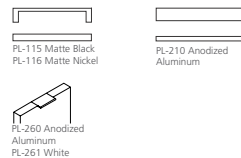
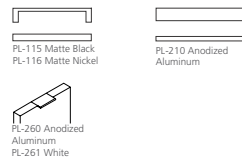

Product features.

- Adjustable glides
- "M" styles shelves match finish
- "W"/"G" styles have black adjustable shelf behind door set

NOTES

- All units are std with flush ends

Options.

ACCESSORIES

- REF-01: Modify Storage section for refrigerator - \$205

AUDIO VISUAL

- AVR1: AV Exhaust Fan - \$470
- AVR2: AV Pullout Rack - \$1655

DOOR

- D2: Wood Door Lock - \$100 per door set
- D6: Delete doors - n/c
- D6A: "W"/"G" Styles - Delete Doors and replace black laminate shelf with finished shelf - n/c
- D9SC: Soft Close Door Hinges - \$20 per door
- WPD3061: Designer White - \$80 per door

GROMMETS (STANDARD LOCATION)

- Specify Color and Left/Right/Center - \$50 ea.
- Black: TM30-R (Right), TM30-L (Left), TM30-C (Center)
 - Silver: TM31-R (Right), TM31-L (Left), TM31-C (Center)
 - White: TM34-R (Right), TM34-L (Left), TM34-C (Center)

GROMMETS (NON-STANDARD LOCATION)

- Provide drawing w/ Grommet Location and Specify Color - \$95 ea.
- Black: TM30-NS
 - Silver: TM31-NS
 - White: TM34-NS
- Grommets (Vertical Surface)
- Standard Location - \$50 ea.
- Black Plastic Vertical Surface: TM50-C (Bottom Center)
- Non-Standard Location - \$95 ea.
- Black Plastic Vertical Surface: TM50-NS
- Open Plan – Finished Back
- OPB: "W" "G" Style - Modify Unit for Open Plan Application - \$195
 - OPB: "M" Style - Modify Unit for Open Plan Application - \$95
- Shelf
- S25: Replace Black Laminate Shelf with Finished Shelf - \$80 per shelf ("W" styles only)

Options.



COMPUTER SUPPORT
single monitor arm

Style Number	List Price
MA1	280

Specifications

- Available in black or silver
- Desk clamp and mounting included
- Easy assembly and flexibility
- Elastic painting process for a durable and beautiful finish
- Gas spring tension adjustment for counter-balance height adjustment for monitors 1-8 KG
- Gas spring tested to 50,000 repetitions
- Hidden cable management



COMPUTER SUPPORT
double monitor arm

Style Number	List Price
MA2	450

Specifications

- Available in black or silver
- Desk clamp and mounting included
- Easy assembly and flexibility
- Elastic painting process for a durable and beautiful finish
- Gas spring tension adjustment for counter-balance height adjustment for monitors 1-8 KG
- Gas spring tested to 50,000 repetitions
- Hidden cable management



COMPUTER SUPPORT
triple monitor arm

Style Number	List Price
MA3	530

Specifications

- Available in black or silver
- Desk clamp and mounting included
- Easy assembly and flexibility
- Elastic painting process for a durable and beautiful finish
- Gas spring tension adjustment for counter-balance height adjustment for monitors 1-8 KG
- Gas spring tested to 50,000 repetitions
- Hidden cable management



COMPUTER SUPPORT
quadruple monitor arm

Style Number	List Price
MA4	705

Specifications

- Available in black
- Desk clamp and mounting included
- Easy assembly and flexibility
- Elastic painting process for a durable and beautiful finish
- Gas spring tension adjustment for counter-balance height adjustment for monitors 1-8 KG
- Gas spring tested to 50,000 repetitions
- Hidden cable management

Options.

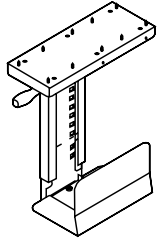

COMPUTER SUPPORT *cpu retractable cradle*

Style Number	List Price
K18	205

Specifications

- Black Metal CPU Carriage
- Full 360° swivel capability allows easy access to rear of CPU for cables / wires
- Track allows 8- 1/2" extension
- Width Adjustment 5-1/2" to 9-1/4"
- Height adjustment 14- 5/8" to 20- 1/2"
- Black epoxy finish

Notes

- Factory Installed



DOOR MODIFICATIONS *soft close door hinge*

Style Number	List Price
D9SC	20 Per door

Specifications

- Snap onto standard door hinge
- Requires (2) per door
- Max door height 43"
- Factory installed where specified
- Individually shipped for field installation

Notes

- Specify Each Item To Have Slow Close Feature

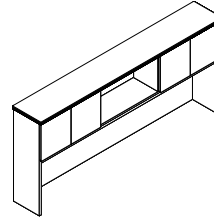

DOOR MODIFICATIONS *delete doors*

Style Number	List Price
D6	N/C

Specifications

- Standard Door overheads and cabinets can have door deleted for open access. Modification of hinge rails and structural components are made face ready.

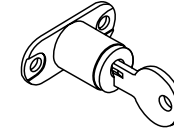

DOOR MODIFICATIONS *panel door lock*

Style Number	List Price
D2	100 Per door set

Specifications

- Door Locks - 1 Door w/ Lock, Other Door w/ Catch Latch
- Contact Customer Service regarding limited lock locations and keying.

Notes

- Available on: Panel Doors, Wood Frame Doors, and Silverluma doors

Options.

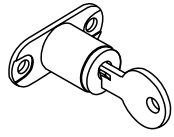

DOOR MODIFICATIONS *glass door lock*

Style Number	List Price
D2-G	205 Per door set

Specifications

- Door Locks - 1 Door w/ Lock, Other Door w/ Catch Latch
- Contact Customer Service regarding limited lock locations and keying.

Notes
- Available on: Glass Doors

GLASSBOARD ACCESSORIES *glassboard accessory kit*

Style Number	List Price
GBKIT	290

Specifications

- 8 Earth magnets, 1 magnetic marker cup holder and 1 magnetic dry eraser



RECESSED LIGHTING *lt-led task light*

Style Number	List Price
24" Task light LT-LED24R	190
48" Task light LT-LED48R	245
60" Task light LT-LED60R	310
72" Task light LT-LED72R	335

Specifications

- 6.5' Power cord. Switch with touch dimmer
- 36 LEDs per foot
- 4.6 Watts per foot
- 91 Lumens per watt
- Please note when ganging.

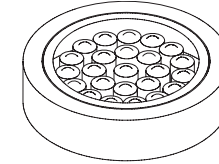

LIGHTING *led interior cabinet puck light*

Style Number	List Price
Starter Kit LEDPK	310
1 LED Interior Puck Light PK	135

Specifications

- Starter kit includes Infeed, 1 Puck Interior Light and the ability to daisy chain up to 6 total Puck Lights
- (1) LED Puck Light with 30W power drive and switch
- Recessed fixture
- 12V linking cord 98"L
- Silver finish
- 50,000 hour life
- 2 watt per light

Notes
- Available on: Overhead/Tower Units with glass doors or no doors
- Power drive included, Light only

Options.

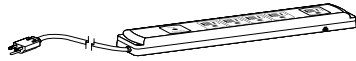

POWER / DATA *power supply cordset*

Style Number	List Price
PD717	100

Specifications

- SIZE: 10.75"L x 2.0"W x 1.06"H
- (5) Outlets w/ 10' cord
- Surge suppression (720 Joules)
- 15 Amp breaker
- Available on: Vertical Panels, Cabinet Interiors, and under tops

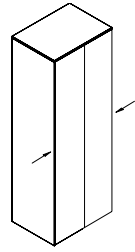

PRODUCT MODIFICATIONS *modify width - open/closed storage*

Style Number	List Price
MOD-2	250

Specifications

- Modify width down on any unit with open or closed storage section: overheads, wall hung units, storage credenzas

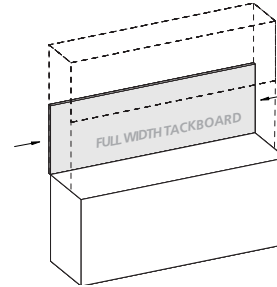

PRODUCT MODIFICATIONS *modify width - tackboard, slat wall, veneer panel, or a glassboard*

Style Number	List Price
MOD-4	50

Specifications

- Modify width down on tackboard, slat wall, veneer panel, or a overhead glassboard

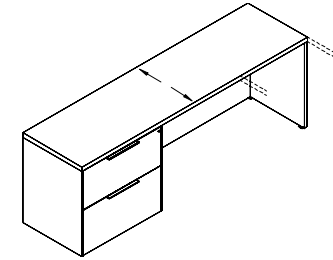

PRODUCT MODIFICATIONS *modify depth - increase depth*

Style Number	List Price
MOD-6	Add 10%

Specifications

- Increase depth by no more than 6"

Notes

- Ex. 24" to 30", 30" to 36", and 36" to 42"
- Add 10% to the unit you want to increase the depth of by no more than 6"

Options.

PRODUCT MODIFICATIONS *modify height*

Style Number	List Price
MOD-7	Contact for pricing

Specifications

- Modify height of a unit

PRODUCT MODIFICATIONS *modify conference table length and width - 1 piece top*

Style Number	List Price
MOD-8	125

Specifications

- Modify length/width on a 1 piece table top

PRODUCT MODIFICATIONS *modify conference table length and width - 2/3 piece top*

Style Number	List Price
MOD-9	250

Specifications

- Modify length/width on a 2 or 3 piece table top

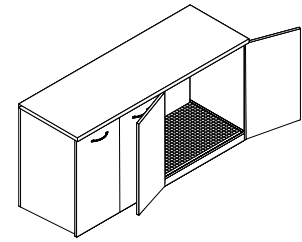

REFRIGERATOR MODIFICATION *refrigerator cabinet modification*

Style Number	List Price
REF01	205

Specifications

- Open back cutout for venting
- Moisture sponge mat
- Contaminate ledge
- Contact customer service for maximum refrigerator size (Changes based on unit).

Notes

- Available on: 36" and 42" Storage Credenzas

Options.

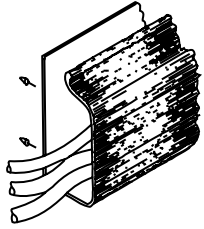

WIRE MANAGEMENT *horizontal j-channel wire management raceway*

Style Number	List Price
W1	80 Per 4' section

Specifications

- 4' section for field installation.
- The "J" shape black thermoplastic wire raceway may be added to specified worksurface tops to provide concealed channeling of wires to and from worksurface grommets. For use in open kneespace areas, raceway is attachable to top of back panel with pan head screws. Interior dimensions are 1" x 1- 1/2" providing ample storage for multiple wires and excess cable. Front of raceway flexes out for easy cord insertion.

Notes

- Units w/ Wire Channel Standard.
- Field Installation

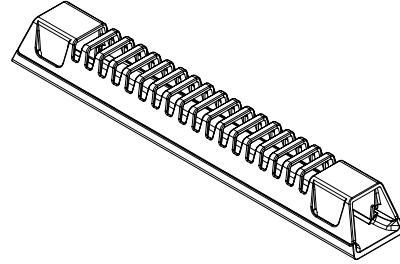

WIRE MANAGEMENT *horizontal wire management raceway*

Style Number	List Price
W21	35

Specifications

- 10"W x 1.5"D x 1.25"H
- Grey Wire Manager (10.5")
- Power and data cables can be discretely housed and managed with the W21 Gray Wire Manager. This can be mounted in any location to metal frame or underside of conference tables and runs cables through a 1" channel from power module to hollow steel legs. This keeps cables organized under the table top. Release clips make it simple to snap on and off the Wire Manager for easy organization and access after attached to the table

Notes

- Field installed

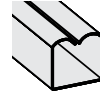

WIRE MANAGEMENT *horizontal u-channel wire management raceway*

Style Number	List Price
W2A	80 Per 4' section

Specifications

- 4' section for field installation.

Notes

- Units w/ Wire Channel Standard.
- Field Installation



WIRE MANAGEMENT *coil wire manager*

Style Number	List Price
W18	160

Specifications

- Weighted Base, Table attachment plate
- 39- 1/2" Length
- Black

Notes

- Location

Options.

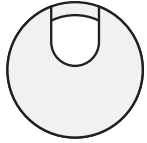

WIRE MANAGEMENT

standard location grommets - factory installed

Style Number	List Price
Standard Location Grommet	
Black	
TM30	50
Silver	
TM31	50
Antique Brass	
TM33	50
White	
TM34	50

Specifications

- 1 -5/8" Metal Grommet

Notes

- *Units w/ Grommets Standard Are Noted Under Standard Features. Grommets Match Pull Finish - Standard (Unless Specified Otherwise)

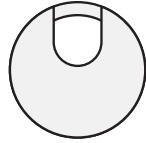

WIRE MANAGEMENT

non-standard location grommets - factory installed

Style Number	List Price
Non-Standard Location Grommet	
Black	
TM30 -NS	95
Silver	
TM31 -NS	95
Antique Brass	
TM33 -NS	95
White	
TM34 -NS	95

Specifications

- 1 -5/8" Metal Grommet

Notes

- *Units w/ Grommets Standard Are Noted Under Standard Features. Grommets Match Pull Finish - Standard (Unless Specified Otherwise)



WIRE MANAGEMENT

black plastic vertical surface grommets - factory installed

Style Number	List Price
Standard Location Grommet	
TM50-C	50
Non-Standard Location Grommet	
TM50-NS	95

Specifications

- 2 " Black Plastic Grommet

Notes

- Standard Location is Bottom Center

power & data options.

Aircharge wireless charging grommet

Style Number	List Price
 ACWG WIRELESS GROMMET	\$195

Specifications

- › When used with GROVE Tables an additional \$350 LIST will apply for the special cutout required.
- › AirCharge offers a convenient way to charge any Qi compatible smartphone or device without the need to carry charging cables or find an available power outlet.
- › The Aircharge is powered by the latest Qi compliant IC offering reliable and efficient wireless charging in a convenient 3" grommet hub. Simply place your phone on the Aircharge and an LED will confirm pairing and begin wireless charging.
- › Recess: Efficient space conservation and quick access
- › Input: DC 5V (with included AC power adapter), DC 9V, 1.67A (with optional QC 2.0 power adapter)
- › Output: 5 watts Max. with DC 5V, 2A power adapter, 10 watts Max. with QC 2.0 power adapter
- › Qi V1.2 compliant IC
- › Charging distance: 6mm Max.

Available: All DARRAN collections



power & data options.

Cove power unit - non-linking

Style Number

List Price



PD-COVE PLUG

\$550

Non-linking version

Specifications

- › Size 5.75" L x 2.5" W
- › (2) 15 Amp Receptacles and (2) USB charging ports
- › Surface Mount
- › 108" Cord
- › Standard Silver Finish, Available in White or Black Finish upon request
- › ETL Listed

Available: All DARRAN collections



power & data options.

Cove power unit with daisylink

Style Number	List Price
--------------	------------

STARTER UNITS



COV-DCH HARDWIRED	\$710
-------------------	-------

Includes (1) Cove unit with Hardwire Infeed - 120"



COV-DCP PLUG	\$800
--------------	-------

Includes (1) Cove unit with Plug infeed -
Includes 72" Cord and 32" Infeed Jumper for
104" total cord infeed

ADDITIONAL LINKING UNITS

COV-DCL	\$575 EACH
---------	------------

Includes Linking Cove unit and Jumper up to
96", cable length determined by the top size

Specifications

- › Size: 5.75"L x 2.5"W
- › (2) 15 Amp Receptacles and (2) 2.1 Amp USB charging ports
- › Surface Mount
- › Max Daisy Chain - Hardwire - (9) units; Plug/Corded - (4) units
- › Standard Silver Finish, Available in White or Black Finish upon request
- › ETL Listed

Available: All DARRAN collections



power & data options.

Cove corded series

Style Number

List Price



PD-COVE-PKO

\$800

Specifications

- › Size 9.5" L x 2.5" W x 3.18" D
- › When used with GROVE Tables an additional \$350 LIST will apply for the special cutout required.
- › (2) Power Receptacles, (2) 2.1 Amp USB charging ports and (1) Telecom Plate Knockout
- › Surface Mount
- › 108" Cord
- › Standard Silver Finish, Available in White or Black Finish upon request
- › ETL Listed

Available: All DARRAN collections

Telecom Plates

RJ45 (1)	\$35
RJ45 (2)	\$70
RJ45 (3)	\$105
USB (1)	\$70
USB (2)	\$140
RJ11/RJ45	\$70
RJ45/USB	\$105
RJ45/HDMI	\$190
HDMI/DVI	\$325
HDMI/USB	\$205
HDMI/VGA	\$240
VGA/MINI-STEREO	\$155
VGA/USB	\$175

This pod can have up to 1 total plates.

*All telecom connectors sold separately.



power & data options.

Dual

Style Number	List Price
STARTER UNITS	
PD-DUAL3P3J	\$1170
3 modules; 3' jumpers	
PD-DUAL3P6J	\$1185
3 modules; 6' jumpers	
PD-DUAL3P12J	\$1200
3 modules; 12' jumpers	
PD-DUAL4P3J	\$1450
4 modules; 3' jumpers	
PD-DUAL4P6J	\$1470
4 modules; 6' jumpers	
PD-DUAL4P12J	\$1490
4 modules; 12' jumpers	
PD-DUAL8P3J	\$2825
8 modules; 3' jumpers	
PD-DUAL8P6J	\$2865
8 modules; 6' jumpers	
PD-DUAL8P12J	\$2905
8 modules; 12' jumpers	

Specifications

- > Size: 3" x 1.75" x 1.25"
- > (2) 2.4 Amp USB charging ports per module
- > Undersurface mount
- > 72" cord
- > Standard black finish, available in white upon request
- > UL certified

Available: Conference, Milner, ThinkingQuietly

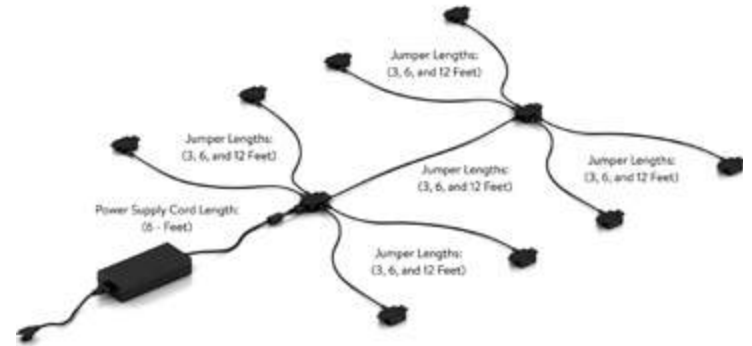

power & data options.

Keno power unit

Style Number

List Price



PD-KENO

\$195

Select power block to link workstations

Specifications

- > Size 5.5" L x 2.125" W x 2.5" H
- > 2 TR AC Outlets
- > 1 4.2A USB module w/ 2 charging ports
- > 10' Power cord

Available: EdgeWorks, NSS Open, Rail, Rail Open Office, ThinkingQuietly

Telecom Plates

With 120" hardwire power cord.

Two Pack Power Block System: 2PPBS \$390

Four Pack Power Block System: 4PPBS \$750

Six Pack Power Block System: 6PPBS \$1100

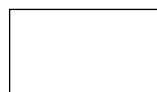

White



Black

power & data options.

Reef power unit with daisylink

Style Number	List Price
 REF310 PLUG	\$1100

Specifications

- > Size 16.1"L x 6.25"W x 4.89"D
- > When used with GROVE Tables an additional \$350 LIST will apply for the special cutout required.
- > (3) 120V Receptacles, (2) USB charging ports, 1 Data Plate Knockout, (2) Knockouts for RJ45 Data Ports
- > Surface Mount
- > 108" Cord
- > Features Convenience Plug on bottom of unit that allows for max (3) Daisy Chain
- > Standard Black Finish, Available in White or Silver Finish upon request
- > Additional Telecom Plate Knockout
- > RJ45 for Knockouts not required. If not ordered a small hole will be present in the pod in this this location
- > ETL Listed

Available: Conferencing

Telecom Plates	
RJ45 (1)	\$35
RJ45 (2)	\$70
RJ45 (3)	\$105
USB (1)	\$70
USB (2)	\$140
RJ11/RJ45	\$70
RJ45/USB	\$105
RJ45/HDMI	\$190
HDMI/DVI	\$325
HDMI/USB	\$205
HDMI/VGA	\$240
VGA/MINI-STEREO	\$155
VGA/USB	\$175

This pod can have up to 1 total plates.
*All telecom connectors sold separately.

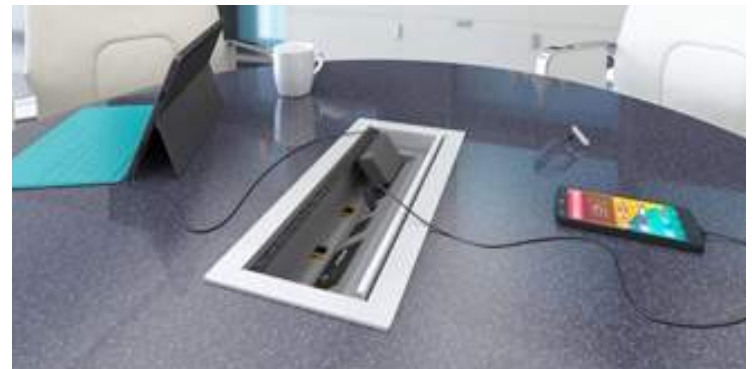

power & data options.

Powered seamless grommet

Style Number	List Price
	
Power/Plug	
PSG82-C: PLUG	\$1875

Specifications

- › Grommet comes with 2 Power Pods that are mounted under the Seamless Grommet. Pods daisylink together with (2) innerconnecting cables.
- › Soft close door
- › Size: 11.5”L x 8.25W”
- › (4) Power Receptacles per power pod, 8 total
- › 124” Power cord
- › Standard Black Finish
- › UL Listed
- › (2) 2.1 Dual USB ports per pod, 4 total
- › (2) Data ports per pod, 4 total
- › Contact customer service when daisy chaining 2 Seamless grommets together.

Available: ThinkingQuietly, Diva, EdgeWorks, Rift, Conference

Telecom Plates	
RJ45 (1)	\$35
RJ45 (2)	\$70
RJ45/HDMI	\$190
HDMI/VGA	\$240
RJ45/VGA	\$190

This pod can have up to 1 total plates.
 *All telecom connectors sold separately.



power & data options.

Seclusion corded power unit non-linking

Style Number	List Price
 P2SECL	\$245
Choose from plate mount or clamp mount (seen in photo)	

Specifications

- > Size: 3.5"L x 2.2"D x 2.5"H
- > (2) Power Receptacles
- > Worksurface Clamp Mount or Plate Under Surface Mount
- > Clamp Accessory accommodates table thickness up to 2"
- > 72" Cord
- > Standard Silver Finish, Black Finish available upon request
- > UL/UCL Listed

Available: All DARRAN collections



Clamp Mount

power & data options.

Soba wire manager

Style Number	List Price
STARTER UNITS	
SCDW	\$200
White wire manager	
SCDB	\$200
Black wire manager	

Specifications

- › Dimensions: 9ft x 9in x 3.15in
- › Zips up, bundles and routes loose, messy cables into a single tube
- › Routes and guides cables behind desks, TVs, and anywhere cables tend to get messy
- › Accommodates large or small cables, up to three cables at once
- › Support channels, used to route cables, include powerful adhesive backing which allows easy attachment to surfaces.

Available: All DARRAN collections



power & data options.

Tully power unit

Style Number

List Price



PD-TULLY

\$320

Select power block to link workstations

Specifications

- › 5.5" W x 3.2" H x 1.81" D
- › Finish: Smooth molded plastic integrated within a single piece cover
- › Mounts to the edge of your work surface, with no table cut outs or installation required.
- › (2) Power receptacles, (2) USB 2.1 Amp ports
- › 72" Cord (10' cord available, contact customer service).
- › Standard in White. Available in gray, black, neon red, harvest pumpkin, light green, daisy blue.
- › UL310, Class 2, FCC Part 15A approved
- › Clamp accessory accommodates table thickness from .75"-1.5"

Available: EdgeWorks, NSS Open, Rail, Rail Open Office, ThinkingQuietly.

Power Block

With 120" hardwire power cord.

Two Pack Power Block System: 2PPBS	\$390
Four Pack Power Block System: 4PPBS	\$750
Six Pack Power Block System: 6PPBS	\$1100

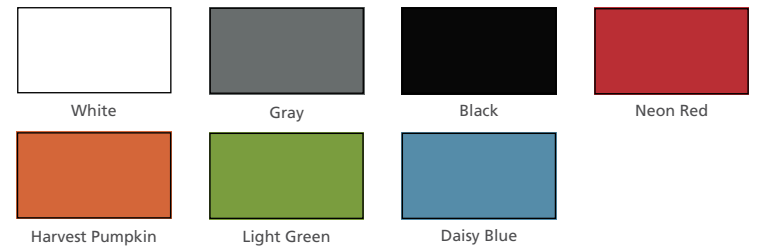

power & data options.

Tully data power unit

Style Number	List Price
PD-TULLY-DATA	\$400

Select power block to link workstations

Specifications

- > 5.5" W x 3.2" H x 1.81" D
- > Finish: Smooth molded plastic integrated within a single piece cover
- > Mounts to the edge of your work surface, with no table cut outs or installation required.
- > (2) Power receptacles, (2) knockouts for HDMI, VGA, or RJ45 (Please specify).
- > 72" Cord (10' cord available, contact customer service).
- > Standard in White. Available in gray, black, neon red, harvest pumpkin, light green, daisy blue.
- > UL310, Class 2, FCC Part 15A approved
- > Clamp accessory accommodates table thickness from .75"-1.5"
- > Includes 2 wire management grommets

Available: Bota booth table

Power Block	
With 120" hardwire power cord.	
Two Pack Power Block System 2PPBS	\$390
Four Pack Power Block System 4PPBS	\$750
Six Pack Power Block System 6PPBS	\$1100

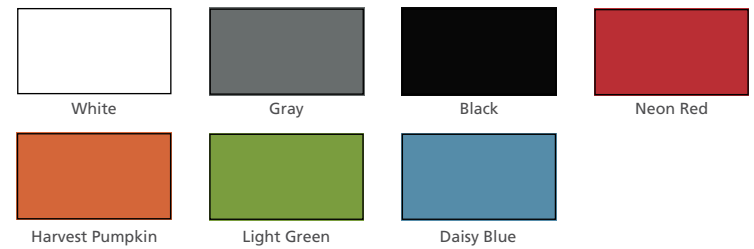

Grove price list



effective july 1, 2021

Grove price list revisions

Date	Page	Modification	Description
------	------	--------------	-------------

Grove table of contents

- Statement of Line
- Features & Advantages 1
- Live Edge Warranty & Care..... 2
- Live Edge tables 3
- Stools 4
- Power & Data 7

Grove statement of line

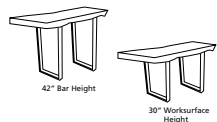

PAGE 3
Live Edge



PAGE 4
Small Round Table

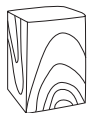

PAGE 5
Square Table

Grove features & advantages

From Table edge to the leg:

120" = 17" Inset

96" = 12" Inset

76" = 10" Inset

Butterflies are hand placed based on the tables natural cracks. Natural cracks in the wood are considered normal and enhance the beauty of the tables.

Every table is unique with live edge detailing

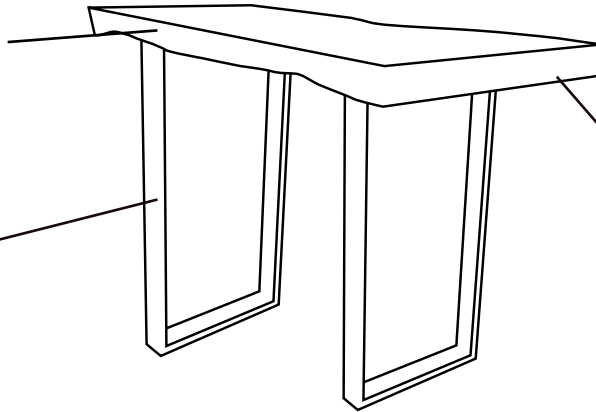

Metal legs standard in black. Optional in matte black and silver.

The Acacia tree is fast growing and known for its beautifully figured grain and distinct sap lines.

Solid slabs can vary from 2" - 3" thick.

Each Grove slab features a protective clear coat to enhance the natural cracks of the solid wood.

Every stool or table is unique with live edge detailing

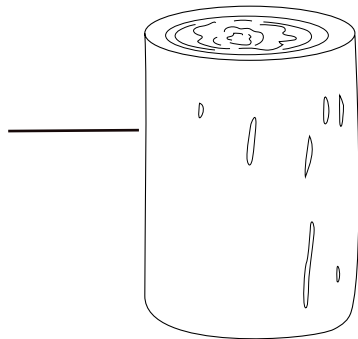

Butterflies are hand placed based on the stools natural cracks. Natural cracks in the wood are considered normal and enhance the beauty of the stools.

Stool depth varies

Powerports

Choose Byrne's Salt power port. Salt includes two powered USB ports. Salt power ports can be added to square stools only.

Grove live edge warranty & care

The DARRAN Grove Collection features natural live edge solid wood slab tables. The Grove slabs are all individually unique with different grain variations, knots, variations in color, splits, and holes that all add to the natural beauty of each table. The natural characteristics are further enhanced by a protective varnish top coat that provides superior resistance to water marks, heat damage, chemical contact, and scratch resistance.

Warranty

All tables and bases have a one-year warranty. We will repair or replace (at our option) any faulty product deemed to have been caused by manufacturing defects. Live edge materials have inherent inconsistencies, natural defects and irregularities that are part of their unique nature. These are considered to be desired effects. Solid wood adjusts different times of the year to the moisture content of the air. In a sense the wood breathes. Wood will also adjust to the moisture content of your office and its surroundings. You may notice your slab furniture piece move and develop small cracks or dips. This is normal. Slab furniture cannot be compared to other solid wood furniture pieces. This product will have movement during its life and this is just the nature of natural wood slab furniture.

Care

In order to maintain the natural beauty of your Grove table, DARRAN recommends the following:

- › Clean your Grove Table using a soft, damp cloth with a mild soap and wipe dry.
- › DARRAN's protective varnish top coat uses the latest advanced finishing technology to preserve the beauty of each Grove Table. Even with this protection, DARRAN recommends the use of coasters with drinks and to clean up any spilled liquids immediately. Avoid direct contact with hot items, harsh chemicals, and some plastic feet on desk accessories as they could damage the finish.
- › Take into account the humidity levels. This natural solid wood will continually contract and expand throughout its life and it will remain very sensitive to abrupt environment change, such as humidity, long after it has been harvested. Humidity levels should always remain between 30-50% to preserve your Grove table. Exposure to extreme fluxuations can cause additional cracking in the slab and would not be considered a manufacturer defect. A furniture repair expert can secure a new crack with a wood butterfly and then recoat the top.
- › Avoid placing your table in direct sunlight to prevent wood bleaching and color changes associated with UV exposure.



Grove.

Live Edge
Live Edge Conference Table

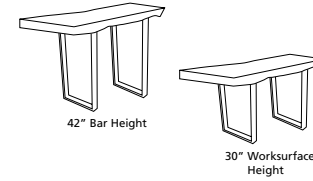

[View statement of line](#)

1 Select a model w" x d" x h"	weight	Standard Veneer Top		Premium Veneer Top		High Pressure Laminate Top		Thermally Fused Laminate Top	
		Standard Veneer Chassis		Premium Veneer Chassis		Veneer Chassis		Thermally Fused Laminate Chassis	
42" Bar Height									
120 Width	775	GRO12042RE400W	16175	"P" Option N/A		"G" Option N/A		"M" Option N/A	
96 Width	575	GRO9642RE400W	10327	"P" Option N/A		"G" Option N/A		"M" Option N/A	
76 Width	375	GRO7642RE400W	7702	"P" Option N/A		"G" Option N/A		"M" Option N/A	
30" Worksurface Height									
120 Width	750	GRO12030RE400W	15768	"P" Option N/A		"G" Option N/A		"M" Option N/A	
96 Width	550	GRO9630RE400W	10058	"P" Option N/A		"G" Option N/A		"M" Option N/A	
76 Width	350	GRO7630RE400W	7445	"P" Option N/A		"G" Option N/A		"M" Option N/A	
*Table depth and thickness varies. Images of inventory and slab dimensions can be viewed at darran.com under the Grove collection.									
2 Select a finish									
		WLE Clear Coat							
		View finish details							
		Metal finish MFB Black. Additional metal finishes are available, see options.							
3 Select a edge									
		Edge N/A							
		View edge details							
4 Select hardware									
		Hardware N/A							
		View hardware details							

Product features.

- Black Metal Legs are standard
- Tops are 2" - 3" thick
- Bases have adjustable glides for leveling

NOTES

- Butterflies are hand placed based on the tables natural characteristic
- Natural cracks in the wood are considered normal and enhance the beauty of the table
- Slabs are cut from the Acacia Tree and has figured grain with distinct sap line edges
- See page 6- 13 for power

Options.

PREMIUM FINISH OPTION

- Specify base in premium metal finish (MFS: Silver, MFMB: Matte Black) - \$160 per base
- Specify W17 wire management in premium metal finish - (MFS: Silver, MFMB: Matte Black) - \$55
- Specify W20 wire management in premium metal finish - (MFS: Silver, MFMB: Matte Black) - \$80

WIRE MANAGEMENT

- W17: Wire management cover - \$80 For 30" worksurface height
- W20: Wire management cover - \$105 For 42" worksurface height

Grove.

Round Tables
Round Acacia Stool Or Table



- 1 Select a model
w" x d" x h"
12 dia x 17
16 dia x 21
*** Stool or Table depth varies**

weight	Standard Veneer Top Standard Veneer Chassis	Premium Veneer Top Premium Veneer Chassis	High Pressure Laminate Top Veneer Chassis	Thermally Fused Laminate Top Thermally Fused Laminate Chassis
50	GRO1217AS372W 474	"P" Option N/A	"G" Option N/A	"M" Option N/A
60	GRO1621AS372W 958	"P" Option N/A	"G" Option N/A	"M" Option N/A

[View statement of line](#)

- 2 Select a finish
[View finish details](#)

WLE Clear Coat

- 3 Select a edge
[View edge details](#)

Edge
N/A

- 4 Select hardware
[View hardware details](#)

Hardware
N/A

Product features.

NOTES

- Butterflies are hand placed based on the tables natural characteristic
- Natural cracks in the wood are considered normal and enhance the beauty of the table
- Stools are cut from the Acacia tree and has figured grain with distinct sap line edges

Grove.

Square Table
Square Acacia Stool Or Table

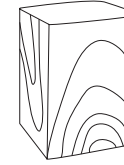

1 Select a model
w" x d" x h"
12 x 12 x 18
* Stool or Table depth varies

weight	Standard Veneer Top Standard Veneer Chassis	Premium Veneer Top Premium Veneer Chassis	High Pressure Laminate Top Veneer Chassis	Thermally Fused Laminate Top Thermally Fused Laminate Chassis
60	GRO1212CM373W 683	"P" Option N/A	"G" Option N/A	"M" Option N/A

[View statement of line](#)

2 Select a finish
[View finish details](#)

WLE Clear Coat

3 Select a edge
[View edge details](#)

Edge
N/A

4 Select hardware
[View hardware details](#)

Hardware
N/A

Product features.

NOTES

- Butterflies are hand placed based on the tables natural characteristic
- Natural cracks in the wood are considered normal and enhance the beauty of the table
- Stools are cut from the Acacia tree and has figured grain with distinct sap line edges

Options.

POWER

- PDS01-G: Salt (Powered USB) - \$425
- See power page for color options

power & data options.

Cove power unit - non-linking for Grove

Style Number	List Price
--------------	------------



PD-COVE-G PLUG	\$900
----------------	-------

Non-linking version

When used with GROVE Tables an additional \$350 LIST applies for the special cutout required. List price above is reflective of the additional \$350 charge.

Specifications

- › Size 5.75" L x 2.5" W
- › 2) 15 Amp Receptacles and (2) USB charging ports
- › Surface Mount
- › 108" Cord
- › Standard Silver Finish, Available in White or Black Finish upon request
- › ETL Listed

Available: All DARRAN collections



power & data options.

Cove power unit with daisylink for Grove

Style Number	List Price
STARTER UNITS	
 COV-DCH-G HARDWIRED	\$1060
Includes (1) Cove unit with Hardwire Infeed - 120"	
 COV-DCP-G PLUG	\$1150
Includes (1) Cove unit with Plug infeed - Includes 72" Cord and 32" Infeed Jumper for 104" total cord infeed	
ADDITIONAL LINKING UNITS	
COV-DCL-G	\$925 EACH

Includes Linking Cove unit and Jumper up to 96", cable length determined by the top size
 When used with GROVE Tables an additional \$350 LIST applies for the special cutout required. List price above is reflective of the additional \$350 charge.

Specifications

- > Size: 5.75" L x 2.5" W
- > (2) 15 Amp Receptacles and (2) 2.1 Amp USB charging ports
- > Surface Mount
- > Max Daisy Chain - Hardwire - (9) units; Plug/Corded - (4) units
- > Standard Silver Finish, Available in White or Black Finish upon request
- > ETL Listed

Available: Grove



power & data options.

Cove corded series for Grove

Style Number	List Price
--------------	------------



PD-COVE-PKO-G	\$1150
---------------	--------

When used with GROVE Tables an additional \$350 LIST applies for the special cutout required. List price above is reflective of the additional \$350 charge.

Specifications

- › Size 9.5"L x 2.5"W x 3.18"D
- › (2) Power Receptacles, (2) 2.1 Amp USB charging ports and (1) Telecom Plate Knockout
- › Surface Mount
- › 108" Cord
- › Standard Silver Finish, Available in White or Black Finish upon request
- › ETL Listed

Available: Grove

Telecom Plates

RJ45 (1)	\$35
RJ45 (2)	\$70
RJ45 (3)	\$105
USB (1)	\$70
USB (2)	\$140
RJ11/RJ45	\$70
RJ45/USB	\$105
RJ45/HDMI	\$190
HDMI/DVI	\$325
HDMI/USB	\$205
HDMI/VGA	\$240
VGA/MINI-STEREO	\$155
VGA/USB	\$175

This pod can have up to 1 total plates.
*All telecom connectors sold separately.



power & data options.

Dual

Style Number	List Price
STARTER UNITS	
PD-DUAL3P3J	\$1170
3 modules; 3' jumpers	
PD-DUAL3P6J	\$1185
3 modules; 6' jumpers	
PD-DUAL3P12J	\$1200
3 modules; 12' jumpers	
PD-DUAL4P3J	\$1450
4 modules; 3' jumpers	
PD-DUAL4P6J	\$1470
4 modules; 6' jumpers	
PD-DUAL4P12J	\$1490
4 modules; 12' jumpers	
PD-DUAL8P3J	\$2825
8 modules; 3' jumpers	
PD-DUAL8P6J	\$2865
8 modules; 6' jumpers	
PD-DUAL8P12J	\$2905
8 modules; 12' jumpers	

Specifications

- > Size: 3" x 1.75" x 1.25"
- > (2) 2.4 Amp USB charging ports per module
- > Undersurface mount
- > 72" cord
- > Standard black finish, available in white upon request
- > UL certified

Available: Conference, Milner, ThinkingQuietly

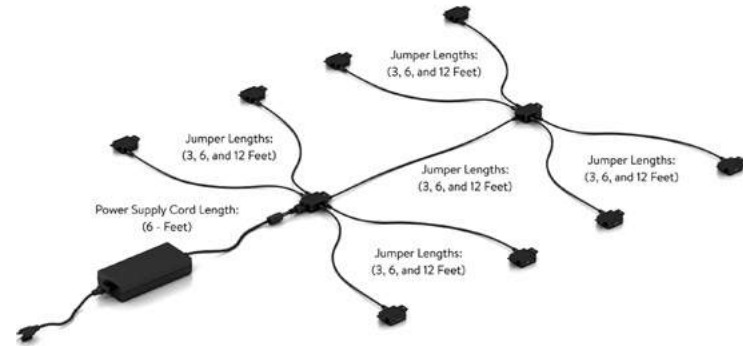

power & data options.

Salt power port for Grove stool

Style Number List Price



GROVE

PDS01-G Salt (powered USB) \$425

Available on Grove square stool only. When used on Grove stool an additional \$200 list applies for the special cutout. List price above is reflective of the additional \$200 charge.

Specifications

- > Salt port includes 2 power USB
- > Cord is 48" long
- > Spill-proof technology

Available: Grove square stool



Salt powered USB



power & data options.

Reef power unit with daisylink for Grove

Style Number List Price



REF310-G PLUG \$1450

When used with Grove tables an additional \$350 list applies for the special cutout required. List price above is reflective of the additional \$350 charge.

Specifications

- › Size 16.1" L x 6.25" W x 4.89"
- › (3) 120V Receptacles, (2) USB charging ports, 1 Data Plate Knockout, (2) Knockouts for RJ45 Data Ports
- › Surface Mount
- › 108" Cord
- › Features Convenience Plug on bottom of unit that allows for max (3) Daisy Chain
- › Standard Black Finish, Available in White or Silver Finish upon request
- › Additional Telecom Plate Knockout
- › RJ45 for Knockouts not required. If not ordered a small hole will be present in the pod in this this location
- › ETL Listed

Available: Grove

Telecom Plates



RJ45 (1)	\$35
RJ45 (2)	\$70
RJ45 (3)	\$105
USB (1)	\$70
USB (2)	\$140
RJ11/RJ45	\$70
RJ45/USB	\$105
RJ45/HDMI	\$190
HDMI/DVI	\$325
HDMI/USB	\$205
HDMI/VGA	\$240
VGA/MINI-STEREO	\$155
VGA/USB	\$175

This pod can have up to 1 total plates.
*All telecom connectors sold separately.



power & data options.

VILLA Power unit with daisylink for Grove

Style Number	List Price
STARTER UNITS	
 VIL-DCH-G HARDWIRED	\$950
Includes (1) Villa unit with 120" Hardwire Infeed	
 VIL-DCP-G PLUG	\$1045
Includes (1) Villa with Plug Infeed - Includes 72" Cord and 32" Infeed Jumper for 104" total cord infeed	
ADDITIONAL LINKING UNITS	
VIL-DCL-G ADDITIONAL	\$940
(Includes linking Villa and Jumper cable up to 96")	

Specifications

- > Size: Top Grommet 5.68"L X 3.39"W; Under Top 12"L x 3.13"W x 3.08"D
- > (4) Power receptacles; (2) surface and (2) undersurface, (2) 2.1A USB charging ports and (1) Knockout for RJ45 Data Port
- > Surface Mount
- > Daisy Chain - Hardwire Max (10) Units, Plug/Corded Max (5) Units
- > Standard Silver Finish, Black Finish available upon request
- > UL or ETL Certified

Available: Grove

RJ45 Knockout	
RJ45 (1)	\$35



Milner price list



Milner table of contents

Statement of Line	
Fabric seat & leather program.....	1
Features & Advantages	4
Finishes.....	5
Specifications.....	6
Edges.....	7
Round Conference Tables.....	8
Square Conference Tables	9
Rectangle Conference Tables.....	10
Stools	15
Power	19

Milner seating fabric & leather program

Seating & fabric leather program

DARRAN has partnered with some of the most prestigious fabric suppliers of the office furniture industry to bring you quality fabrics that are engaging designs, environmentally friendly and durable for years to come. The majority of fabrics we have graded-in are in heavy supply making it most likely available on our Quickship however, we cannot guarantee stock. If you do not see the fabric you wish to include in a project, please contact our Factory to see if this pattern can be graded in at 800.334.7891.

Fabrics

Please visit our Seating Fabrics page at darran.com/textilesleather

Momentum Textiles www.momentumtextiles.com	800.366.6839
Maharam www.maharam.com	800.645.3943
CFStinson www.cfstinson.com	800.841.6279
Knoll Textiles www.knolltextiles.com	866.565.5858
DesignTex www.designtex.com	800.797.4949
Mayer Fabrics www.mayerfabrics.com	800.428.4415

Leathers

Please visit our Seating Fabrics page at darran.com/textilesleather

Wollsdorf www.wollsdorf.com	336.884.5005
Elmo Leather www.elmoleather.com	732.549.5151
Green Hides www.greenhides.com	336.315.9720

Application instructions must be specified on the purchase order or COM / COL submission form. In the absence of application instructions, DARRAN will apply materials accordingly.

CAL117

All DARRAN seating products conform to California Technical Bulletin 117 as a minimum standard.

CAL133

To meet the California Technical Bulletin 133 flammability regulation, a combination of proper materials must be used to pass, as it tests the fire resistance of a finished product. Flame resistant fabric, a fire blocker material and special foam must be used to pass CAL133 fire codes.

Testing is available for all seating products with the following fees and considerations:

- If laboratory certification is not required, any style can be manufactured to comply with California Technical Bulletin 133 for \$75 list per yard required. (Customer's Own Materials must factor in additional yardage requirements based on repeat.)
- The purchase order must clearly indicate the requirement of California Technical Bulletin 133
- If laboratory California Technical Bulletin 133 certification is required, the cost of testing a chair is \$820 NET, plus the cost of the chair and covering material.
- An additional lead time of 4 to 6 weeks is required for testing for CAL133.
- Once testing is completed, we will provide a certification letter specific to the sample tested for CAL133.
- DARRAN's manufacturing procedures for California TB 133 compliance are based on the testing of representative style with specific fabrics. Please contact Customer Service for an updated list of tested models.
- A copy of test certification is available upon request.

Milner seating fabric & leather program

Combination fabrics

DARRAN is pleased to offer customers the design freedom of combination fabrics. When using fabric, vinyl or leather combinations, pricing will be as follows:

- When combining two materials of the same grade, pricing will be specified grade + 5%.
- If combining two materials of different grades or leather/ fabric combination, use the highest grade/price + 5%.
- If using COM or COL, pricing will be COM or COL + 5%. If both COM + COL are used in combination, use COL + 5%

COM/COL ordering instructions

Please complete the COM Submission Form prior to ordering the fabric from the supplier. All COM fabrics must be approved prior to order submission. Please refer to our website or contact DARRAN Seating Customer Service for an updated list of preapproved COM fabrics. Application instructions must be specified on the purchase order or COM/COL submission form. In the absence of application instructions, DARRAN will apply materials in the best manner and cannot be held responsible for tailoring or application objections after upholstering. COM orders will be scheduled for production after receipt of the material. Packages must be clearly marked and the fabric must be first quality, continuous yardage.

COM/COL yardage requirements

The yardage requirements stated in this price list for each style are calculated using 54" wide, non-directional fabrics. For fabrics with a different width or for patterns with repeats, please refer to the below chart to calculate the additional percent of fabric required:

Fabric Width	Plain Fabric	2" - 14" Repeat	15" - 19" Repeat	20" - 27" Repeat	28" - 36" Repeat
54"	0	15%	20%	25%	30%
53"	6%	19%	24%	28%	36%
52"	13%	23%	28%	33%	38%
51"	19%	26%	31%	36%	41%
50"	25%	30%	35%	40%	45%
49"	30%	35%	40%	45%	50%
48"	35%	40%	45%	50%	55%
47"	45%	50%	55%	58%	65%

Milner seating fabric & leather program

NOTE: Prior To Completion Of This Form, Please Refer To Our Graded In Materials Program For Preapproved Fabrics/Leathers.

COM/COL Approval

DARRAN Furniture Industries
 2402 Shore Street, High Point, NC 27263
 ATTN: Seating Division / COM/COL Approval
 TAG: DARRAN Purchase Order Number

Shipping approved COM/COL materials

DARRAN Furniture Industries
 2402 Shore Street, High Point, NC 27263
 ATTN: Seating Division / COM/COL Approval
 TAG: DARRAN Purchase Order Number

Please complete this form, attach a 6" x 6" sample and mail to the COM/COL APPROVAL address shown above.
 This form can also be downloaded from our website at www.darran.com/leathers OR www.darran.com/fabrics

Purchase Order # _____
 Dealer's Name _____
 Contact _____
 Address _____
 Telephone _____
 Email _____
 Chair Style _____
 Manufacturer _____
 Pattern Name _____
 Pattern Color _____
 Content _____
 Repeat _____

Please specify any special requirements and check the application above.

ATTACH 6" X 6" FABRIC/LEATHER SAMPLE HERE

NOTE

Actual Fabric/Leather samples needed instead of digital images. If digital images are sent in lieu of samples, DARRAN will only verify the pattern and will not take responsibility for color variances that cannot be verified due to printing restrictions

In the absence of application instructions, DARRAN will apply the material in the best manner and cannot be held responsible for tailoring or application objections after upholstery.

Unless otherwise instructed on the purchase order, excess COM materials will be recycled at the discretion of DARRAN after six months of the original product ship date.

The COM approval solely pertains to the application of the fabric onto the specified DARRAN seating product. DARRAN's approval or acceptance does not constitute any responsibility or warranty to the overall appearance, durability, flammability, defects, dye lot variations or colorfastness of the COM. It is the customer's responsibility to ensure the COM meets CAL 117 compliance and are first quality continuous goods.

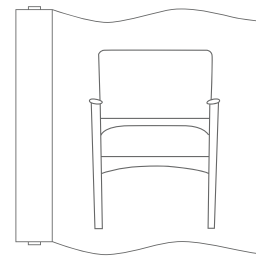

RAILROAD

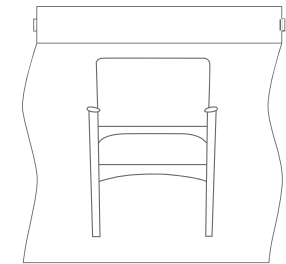

SETUP

Milner features & advantages

Veneer and HPL tops

Veneer tops and high-pressure laminate tops feature a 45-pound density substrate with balanced 3-ply construction. Tops are 1-1/2" thick. DARRAN only uses HPVA A Grade Flat Cut Walnut Veneers and A Grade Quartered Oak. Walnut veneers are book-matched. Oak Veneers are plank matched. Veneer tops feature a 3mm external solid hardwood band, HPL tops features a 2mm flat PVC band or a 1mm laminate self-edge.

Table construction

Table bases are constructed from 1" thick solid Oak or Walnut. Parts are securely fastened together using rails that are bored and joined with wood fasteners. Legs are pre-board to accept a tee nut for the adjustable glide.

Wire management

Power and data are concealed without notice under the surface of the table. A system of W21 cable clips and connectors run cords safely and cleanly around corners. Specify W21 under surface wire channels for organization and management of all communication wires and cords. Sold separately to conceal wire under worksurfaces.

Dual power

- PD-DUAL3P3J: 3 Packs (2 USB, 6 USB total) w/ 3' jumper - \$1170
- PD-DUAL3P6J: 3 Packs (2 USB, 6 USB total) w/ 6' jumper - \$1185
- PD-DUAL3P12J: 3 Packs (2 USB, 6 USB total) w/ 12' jumper - \$1200
- PD-DUAL4P3J: 4 Packs (2 USB, 8 USB total) w/ 3' jumper - \$1450
- PD-DUAL4P6J: 4 Packs (2 USB, 8 USB total) w/ 6' jumper - \$1470
- PD-DUAL4P12J: 4 Packs (2 USB, 8 USB total) w/ 12' jumper - \$1490
- PD-DUAL8P3J: 8 Packs (2 USB, 16 USB total) w/ 3' jumper - \$2825
- PD-DUAL8P6J: 8 Packs (2 USB, 16 USB total) w/ 6' jumper - \$2865
- PD-DUAL8P12J: 8 Packs (2 USB, 16 USB total) w/ 12' jumper - \$2905
- Size: 3" x 1.75" x 1.25"
- (2) 2.4 Amp USB charging ports per module
- Undersurface mount
- 72" cord
- Standard black finish, available in white upon request
- UL certified

Soba wire management

- SCD: Soba wire management - \$200
- Dimensions: 9ft x 9in x 3.15in
- Zips up, bundles and routes loose, messy cables into a single tube
- Routes and guides cables behind desks, TVs, and anywhere cables tend to get messy
- Accommodates large or small cables, up to three cables at once

Adjustable glides

Glides provide 1" of vertical leveling adjustment. Glide bottom is durable metal.

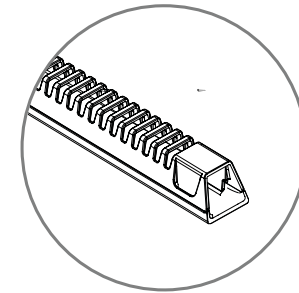

W21 Grey Wire Manager
10"W x 1.5"D x 1.25"H

Milner finishes | specifications

STANDARD VENEER	PREMIUM VENEER	HIGH PRESSURE LAMINATE	THERMALLY FUSED LAMINATE
N/A.....	WBO Blush Oak.....	N/A.....	N/A
N/A.....	WMO Mocha Oak.....	N/A.....	N/A
N/A.....	WNO Natural Oak.....	N/A.....	N/A
WOW Clear Walnut.....	WSO Salted Oak.....	N/A.....	N/A
WEW Executive Walnut.....	N/A.....	GEW Executive Walnut.....	N/A
WGW Gunstock Walnut.....	N/A.....	N/A.....	N/A
WBW Henna Walnut.....	N/A.....	N/A.....	N/A
WSW Smokey Walnut.....	N/A.....	N/A.....	N/A
WNW Natural Walnut.....	N/A.....	GNW Natural Walnut.....	N/A
WWP Designer White Paint.....	N/A.....	GWL Designer White.....	N/A
WEC Ebony.....	N/A.....	GEC Ebony.....	N/A

HPL TOPS ON TFL PRODUCTS Add 10% - Available with flat edge only

Milner specifications



Milner is available in conference, counter and bar height.

Milner Legs

Milner conference tables of 120" length have 3 support legs.

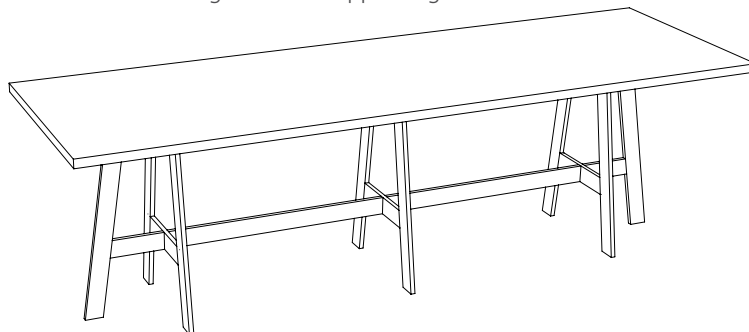

Milner edges

Standard Profile

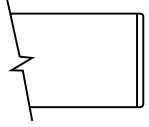

"W" "P" 3mm Hardwood Band
"G" HPL Self Laminate Band

Flat-1
"W" "G"

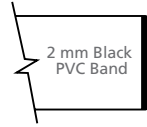

Flat-2
"W" "G"

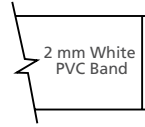



Flat-3
"W" "G"

Milner.

Conference Table
Round Top With Frame



[View statement of line](#)

1 Select a model w" x d" x h"	weight	Standard Veneer Top Solid Wood Base		Premium Veneer Top Solid Wood Base		High Pressure Laminate Top Solid Wood Base		Thermally Fused Laminate Top Solid Wood Base	
		Conference Height							
48 Dia x 30	115	MIL4848RD121W	2282	MIL4848RD121P	2511	MIL4848RD121G	2282	"M" Option N/A	
42 Dia x 30	90	MIL4242RD121W	2113	MIL4242RD121P	2325	MIL4242RD121G	2113	"M" Option N/A	
36 Dia x 30	70	MIL3636RD121W	1944	MIL3636RD121P	2139	MIL3636RD121G	1944	"M" Option N/A	
Counter Height									
48 Dia x 36	120	MIL4848RD131W	2451	MIL4848RD131P	2697	MIL4848RD131G	2451	"M" Option N/A	
42 Dia x 36	95	MIL4242RD131W	2282	MIL4242RD131P	2511	MIL4242RD131G	2282	"M" Option N/A	
36 Dia x 36	75	MIL3636RD131W	2113	MIL3636RD131P	2325	MIL3636RD131G	2113	"M" Option N/A	
Bar Height									
48 Dia x 42	125	MIL4848RD141W	2620	MIL4848RD141P	2882	MIL4848RD141G	2620	"M" Option N/A	
42 Dia x 42	100	MIL4242RD141W	2451	MIL4242RD141P	2697	MIL4242RD141G	2451	"M" Option N/A	
36 Dia x 42	80	MIL3636RD141W	2282	MIL3636RD141P	2511	MIL3636RD141G	2282	"M" Option N/A	
2 Select a finish View finish details	Top finishes	Base finishes		Top finishes	Base finishes		Top finishes	Base finishes	
	WEC	WEC		WBO	WBO		GEW	WEW	
	WOW	WOW		WMO	WMO		GWL	WWP	
	WEW	WEW		WNO	WNO		GEC	WEC	
	WGW	WGW		WSO	WSO		GNW	WNW	
	WBW	WBW							
	WSW	WSW							
	WNW	WNW							
WWP	WWP								
3 Select an edge View edge details									
	Flat			Flat			Flat		
4 Select hardware View hardware details	Hardware			Hardware			Hardware		
	N/A			N/A			N/A		

Product features.

- 1-1/2" Thick veneer top, 1 5/16" HPL top
- 1" adjustable glides
- ENVI-CT Finish on wood tops
- Solid 1" hardwood walnut/oak legs to maximize strength and longevity
- Shipped KD in subassemblies

NOTES

- All "G" style tops have a solid wood base, specify a "W" base finish

Options.

DUAL POWER

- PD-DUAL3P3J: 3 Packs (2 USB, 6 USB total) w/ 3' jumper - \$1170
- PD-DUAL3P6J: 3 Packs (2 USB, 6 USB total) w/ 6' jumper - \$1185
- PD-DUAL3P12J: 3 Packs (2 USB, 6 USB total) w/ 12' jumper - \$1200
- PD-DUAL4P3J: 4 Packs (2 USB, 8 USB total) w/ 3' jumper - \$1450
- PD-DUAL4P6J: 4 Packs (2 USB, 8 USB total) w/ 6' jumper - \$1470
- PD-DUAL4P12J: 4 Packs (2 USB, 8 USB total) w/ 12' jumper - \$1490



SOBA WIRE MANAGEMENT

- SCD: Soba wire management - \$210

Milner.

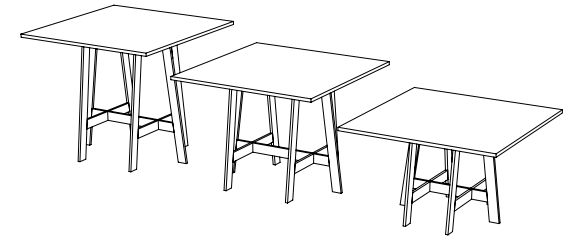
Conference Table
Square Top With Frame



1 Select a model w" x d" x h"	weight	Standard Veneer Top Solid Wood Base		Premium Veneer Top Solid Wood Base		High Pressure Laminate Top Solid Wood Base		Thermally Fused Laminate Top Solid Wood Base	
		Conference Height							
48 x 48 x 30	115	MIL4848SQ121W	2890	MIL4848SQ121P	3179	MIL4848SQ121G	2890	"M" Option N/A	
42 x 42 x 30	90	MIL4242SQ121W	2711	MIL4242SQ121P	2982	MIL4242SQ121G	2711	"M" Option N/A	
36 x 36 x 30	70	MIL3636SQ121W	2531	MIL3636SQ121P	2784	MIL3636SQ121G	2531	"M" Option N/A	
Counter Height									
48 x 48 x 36	120	MIL4848SQ131W	2973	MIL4848SQ131P	3270	MIL4848SQ131G	2973	"M" Option N/A	
42 x 42 x 36	95	MIL4242SQ131W	2911	MIL4242SQ131P	3202	MIL4242SQ131G	2911	"M" Option N/A	
36 x 36 x 36	75	MIL3636SQ131W	2732	MIL3636SQ131P	3005	MIL3636SQ131G	2732	"M" Option N/A	
Bar Height									
48 x 48 x 42	125	MIL4848SQ141W	3296	MIL4848SQ141P	3626	MIL4848SQ141G	3296	"M" Option N/A	
42 x 42 x 42	100	MIL4242SQ141W	3117	MIL4242SQ141P	3429	MIL4242SQ141G	3117	"M" Option N/A	
36 x 36 x 42	80	MIL3636SQ141W	2937	MIL3636SQ141P	3231	MIL3636SQ141G	2937	"M" Option N/A	
2 Select a finish <i>View finish details</i>	Top finishes	Base finishes		Top finishes	Base finishes	Top finishes	Base finishes		
	WEC	WEC		WBO	WBO	GEW	WEW		
	WOW	WOW		WMO	WMO	GWL	WWP		
	WEW	WEW		WNO	WNO	GEC	WEC		
	WGW	WGW		WSO	WSO	GNW	WNW		
	WBW	WBW							
	WSW	WSW							
WNW	WNW								
WWP	WWP								
3 Select an edge <i>View edge details</i>									
		Flat		Flat		Flat			
4 Select hardware <i>View hardware details</i>	Hardware			Hardware		Hardware			
	N/A			N/A		N/A			

View statement of line

Product features.

- 1-1/2" Thick veneer top, 1 5/16" HPL top
- 1" adjustable glides
- ENVI-CT Finish on wood tops
- Solid 1" hardwood walnut/oak legs to maximize strength and longevity
- Shipped KD in subassemblies

NOTES

- All "G" style tops have a solid wood base, specify a "W" base finish

Options.

DUAL POWER

- PD-DUAL3P3J: 3 Packs (2 USB, 6 USB total) w/ 3' jumper - \$1170
- PD-DUAL3P6J: 3 Packs (2 USB, 6 USB total) w/ 6' jumper - \$1185
- PD-DUAL3P12J: 3 Packs (2 USB, 6 USB total) w/ 12' jumper - \$1200
- PD-DUAL4P3J: 4 Packs (2 USB, 8 USB total) w/ 3' jumper - \$1450
- PD-DUAL4P6J: 4 Packs (2 USB, 8 USB total) w/ 6' jumper - \$1470
- PD-DUAL4P12J: 4 Packs (2 USB, 8 USB total) w/ 12' jumper - \$1490

SOBA WIRE MANAGEMENT

- SCD: Soba wire management - \$210

Milner.

Conference Table
Rectangle - 36" Depth

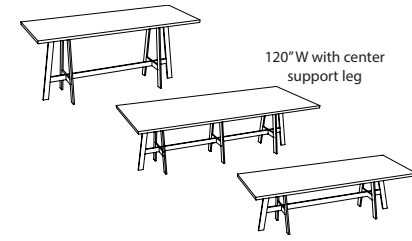

[View statement of line](#)

1 Select a model w" x d" x h"	weight	Standard Veneer Top Solid Wood Base		Premium Veneer Top Solid Wood Base		High Pressure Laminate Top Solid Wood Base		Thermally Fused Laminate Top Solid Wood Base	
Conference Height									
120 x 36 x 30	210	MIL12036RE121W	6117	MIL12036RE121P	6729	MIL12036RE121G	6117	"M" Option N/A	
96 x 36 x 30	170	MIL9636RE121W4836		MIL9636RE121P	5320	MIL9636RE121G	4836	"M" Option N/A	
84 x 36 x 30	150	MIL8436RE121W4479		MIL8436RE121P	4927	MIL8436RE121G	4479	"M" Option N/A	
72 x 36 x 30	130	MIL7236RE121W4122		MIL7236RE121P	4535	MIL7236RE121G	4122	"M" Option N/A	
Counter Height									
120 x 36 x 36	215	MIL12036RE131W	6370	MIL12036RE131P	7007	MIL12036RE131G	6370	"M" Option N/A	
96 x 36 x 36	175	MIL9636RE131W5006		MIL9636RE131P	5507	MIL9636RE131G	5006	"M" Option N/A	
84 x 36 x 36	155	MIL8436RE131W4648		MIL8436RE131P	5113	MIL8436RE131G	4648	"M" Option N/A	
72 x 36 x 36	135	MIL7236RE131W4290		MIL7236RE131P	4719	MIL7236RE131G	4290	"M" Option N/A	
Bar Height									
120 x 36 x 42	220	MIL12036RE141W	6624	MIL12036RE141P	7287	MIL12036RE141G	6624	"M" Option N/A	
96 x 36 x 42	180	MIL9636RE141W5174		MIL9636RE141P	5692	MIL9636RE141G	5174	"M" Option N/A	
84 x 36 x 42	160	MIL8436RE141W4817		MIL8436RE141P	5299	MIL8436RE141G	4817	"M" Option N/A	
72 x 36 x 42	140	MIL7236RE141W4460		MIL7236RE141P	4906	MIL7236RE141G	4460	"M" Option N/A	
2 Select a finish View finish details	Top finishes	WEC		WBO		GEW		WEW	
	Base finishes	WEC		WBO		GEW		WEW	
		WOW		WMO		GWL		WWP	
		WEW		WNO		GEC		WEC	
		WGW		WSO		GNW		WNW	
		WBW							
	WSW								
	WNW								
	WWP								
3 Select an edge View edge details									
		Flat		Flat		Flat			
4 Select hardware View hardware details	Hardware	N/A		Hardware	N/A	Hardware	N/A		

Product features.

- 1-1/2" Thick veneer top, 1 5/16" HPL top
- 1" adjustable glides
- ENVI-CT Finish on wood tops
- Solid 1" hardwood walnut/oak legs to maximize strength and longevity
- One piece top
- Shipped KD in subassemblies

NOTES

- 120"W tables feature trestle base with center support leg
- All "G" style tops have a solid wood base, specify a "W" base finish

Options.

DUAL POWER

- PD-DUAL3P3J: 3 Packs (2 USB, 6 USB total) w/ 3' jumper - \$1170
- PD-DUAL3P6J: 3 Packs (2 USB, 6 USB total) w/ 6' jumper - \$1185
- PD-DUAL3P12J: 3 Packs (2 USB, 6 USB total) w/ 12' jumper - \$1200
- PD-DUAL4P3J: 4 Packs (2 USB, 8 USB total) w/ 3' jumper - \$1450
- PD-DUAL4P6J: 4 Packs (2 USB, 8 USB total) w/ 6' jumper - \$1470
- PD-DUAL4P12J: 4 Packs (2 USB, 8 USB total) w/ 12' jumper - \$1490
- PD-DUAL8P3J: 8 Packs (2 USB, 16 USB total) w/ 3' jumper - \$2825
- PD-DUAL8P6J: 8 Packs (2 USB, 16 USB total) w/ 6' jumper - \$2865
- PD-DUAL8P12J: 8 Packs (2 USB, 16 USB total) w/ 12' jumper - \$2905

SOBA WIRE MANAGEMENT

- SCD: Soba wire management - \$210

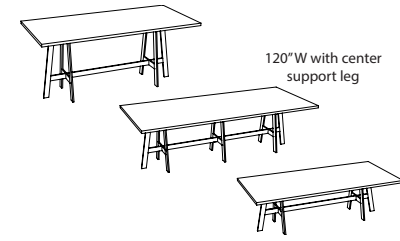

Milner.

Conference Table
Rectangle - 42" Depth



120"W with center support leg

[View statement of line](#)

1 Select a model w" x d" x h"	weight	Standard Veneer Top Solid Wood Base		Premium Veneer Top Solid Wood Base		High Pressure Laminate Top Solid Wood Base		Thermally Fused Laminate Top Solid Wood Base	
		Conference Height 120 x 42 x 30 96 x 42 x 30 84 x 42 x 30 72 x 42 x 30 Counter Height 120 x 42 x 36 96 x 42 x 36 84 x 42 x 36 72 x 42 x 36 Bar Height 120 x 42 x 42 96 x 42 x 42 84 x 42 x 42 72 x 42 x 42	230 190 165 145 235 195 170 150 240 200 175 155	MIL12042RE121W MIL9642RE121W5006 MIL8442RE121W4648 MIL7242RE121W4290 MIL12042RE131W MIL9642RE131W5174 MIL8442RE131W4817 MIL7242RE131W4460 MIL12042RE141W MIL9642RE141W5344 MIL8442RE141W4986 MIL7242RE141W4628	6370 5006 4648 4290 6624 5174 4817 4460 6878 5344 4986 4628	MIL12042RE121P MIL9642RE121P MIL8442RE121P MIL7242RE121P MIL12042RE131P MIL9642RE131P MIL8442RE131P MIL7242RE131P MIL12042RE141P MIL9642RE141P MIL8442RE141P MIL7242RE141P	7007 5507 5113 4719 7287 5692 5299 4906 7566 5879 5485 5091	MIL12042RE121G MIL9642RE121G MIL8442RE121G MIL7242RE121G MIL12042RE131G MIL9642RE131G MIL8442RE131G MIL7242RE131G MIL12042RE141G MIL9642RE141G MIL8442RE141G MIL7242RE141G	6370 5006 4648 4290 6624 5174 4817 4460 6878 5344 4986 4628
2 Select a finish View finish details	Top finishes WEC WOW WEW WGW WBW WSW WNW WWP	Base finishes WEC WOW WEW WGW WBW WSW WNW WWP	Top finishes WBO WMO WNO WSO	Base finishes WBO WMO WNO WSO	Top finishes GEW GWL GEC GNW	Base finishes WEW WWP WEC WNW	 Flat	 Flat	 Flat
4 Select hardware View hardware details	Hardware N/A	Hardware N/A	Hardware N/A	Hardware N/A	Hardware N/A	Hardware N/A	Hardware N/A	Hardware N/A	

Product features.

- 1-1/2" Thick veneer top, 1 5/16" HPL top
- 1" adjustable glides
- ENVI-CT Finish on wood tops
- Solid 1" hardwood walnut/oak legs to maximize strength and longevity
- One piece top
- Shipped KD in subassemblies

NOTES

- 120"W tables feature trestle base with center support leg
- All "G" style tops have a solid wood base, specify a "W" base finish

Options.

DUAL POWER

- PD-DUAL3P3J: 3 Packs (2 USB, 6 USB total) w/ 3' jumper - \$1170
- PD-DUAL3P6J: 3 Packs (2 USB, 6 USB total) w/ 6' jumper - \$1185
- PD-DUAL3P12J: 3 Packs (2 USB, 6 USB total) w/ 12' jumper - \$1200
- PD-DUAL4P3J: 4 Packs (2 USB, 8 USB total) w/ 3' jumper - \$1450
- PD-DUAL4P6J: 4 Packs (2 USB, 8 USB total) w/ 6' jumper - \$1470
- PD-DUAL4P12J: 4 Packs (2 USB, 8 USB total) w/ 12' jumper - \$1490
- PD-DUAL8P3J: 8 Packs (2 USB, 16 USB total) w/ 3' jumper - \$2825
- PD-DUAL8P6J: 8 Packs (2 USB, 16 USB total) w/ 6' jumper - \$2865
- PD-DUAL8P12J: 8 Packs (2 USB, 16 USB total) w/ 12' jumper - \$2905

SOBA WIRE MANAGEMENT

- SCD: Soba wire management - \$210

Milner.

Conference Table
Rectangle - 48" Depth

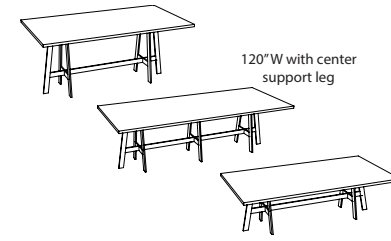

[View statement of line](#)

1 Select a model w" x d" x h"	weight	Standard Veneer Top Solid Wood Base		Premium Veneer Top Solid Wood Base		High Pressure Laminate Top Solid Wood Base		Thermally Fused Laminate Top Solid Wood Base		
Conference Height										
120 x 48 x 30	250	MIL12048RE121W	6624	MIL12048RE121P	7287	MIL12048RE121G	6624	"M" Option N/A		
96 x 48 x 30	210	MIL9648RE121W	5174	MIL9648RE121P	5692	MIL9648RE121G	5174	"M" Option N/A		
84 x 48 x 30	185	MIL8448RE121W	4817	MIL8448RE121P	5299	MIL8448RE121G	4817	"M" Option N/A		
72 x 48 x 30	160	MIL7248RE121W	4460	MIL7248RE121P	4906	MIL7248RE121G	4460	"M" Option N/A		
Counter Height										
120 x 48 x 36	255	MIL12048RE131W	6878	MIL12048RE131P	7566	MIL12048RE131G	6878	"M" Option N/A		
96 x 48 x 36	215	MIL9648RE131W	5344	MIL9648RE131P	5879	MIL9648RE131G	5344	"M" Option N/A		
84 x 48 x 36	190	MIL8448RE131W	4986	MIL8448RE131P	5485	MIL8448RE131G	4986	"M" Option N/A		
72 x 48 x 36	165	MIL7248RE131W	4628	MIL7248RE131P	5091	MIL7248RE131G	4628	"M" Option N/A		
Bar Height										
120 x 48 x 42	260	MIL12048RE141W	7131	MIL12048RE141P	7845	MIL12048RE141G	7131	"M" Option N/A		
96 x 48 x 42	220	MIL9648RE141W	5512	MIL9648RE141P	6064	MIL9648RE141G	5512	"M" Option N/A		
84 x 48 x 42	195	MIL8448RE141W	5155	MIL8448RE141P	5671	MIL8448RE141G	5155	"M" Option N/A		
72 x 48 x 42	170	MIL7248RE141W	4798	MIL7248RE141P	5277	MIL7248RE141G	4798	"M" Option N/A		
2 Select a finish View finish details	Top finishes	Base finishes		Top finishes	Base finishes		Top finishes	Base finishes		
	WEC	WEC		WBO	WBO		GEW	WEW		
	WOW	WOW		WMO	WMO		GWL	WWP		
	WEW	WEW		WNO	WNO		GEC	WEC		
	WGW	WGW		WSO	WSO		GNW	WNW		
	WBW	WBW								
WSW	WSW									
WNW	WNW									
WWP	WWP									
3 Select an edge View edge details	Flat		Flat		Flat		Flat		Flat	
4 Select hardware View hardware details	Hardware N/A		Hardware N/A		Hardware N/A		Hardware N/A		Hardware N/A	

Product features.

- 1-1/2" Thick veneer top, 1 5/16" HPL top
- 1" adjustable glides
- ENVI-CT Finish on wood tops
- Solid 1" hardwood walnut/oak legs to maximize strength and longevity
- One piece top
- Shipped KD in subassemblies

NOTES

- 120"W tables feature trestle base with center support leg
- All "G" style tops have a solid wood base, specify a "W" base finish

Options.

DUAL POWER

- PD-DUAL3P3J: 3 Packs (2 USB, 6 USB total) w/ 3' jumper - \$1170
- PD-DUAL3P6J: 3 Packs (2 USB, 6 USB total) w/ 6' jumper - \$1185
- PD-DUAL3P12J: 3 Packs (2 USB, 6 USB total) w/ 12' jumper - \$1200
- PD-DUAL4P3J: 4 Packs (2 USB, 8 USB total) w/ 3' jumper - \$1450
- PD-DUAL4P6J: 4 Packs (2 USB, 8 USB total) w/ 6' jumper - \$1470
- PD-DUAL4P12J: 4 Packs (2 USB, 8 USB total) w/ 12' jumper - \$1490
- PD-DUAL8P3J: 8 Packs (2 USB, 16 USB total) w/ 3' jumper - \$2825
- PD-DUAL8P6J: 8 Packs (2 USB, 16 USB total) w/ 6' jumper - \$2865
- PD-DUAL8P12J: 8 Packs (2 USB, 16 USB total) w/ 12' jumper - \$2905

SOBA WIRE MANAGEMENT

- SCD: Soba wire management - \$210

Milner.

Conference Table
Rectangle - 54" Depth

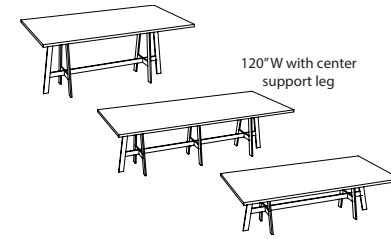

[View statement of line](#)

1 Select a model w" x d" x h"	weight	Standard Veneer Top Solid Wood Base		Premium Veneer Top Solid Wood Base		High Pressure Laminate Top Solid Wood Base		Thermally Fused Laminate Top Solid Wood Base	
		Conference Height 120 x 54 x 30	280	MIL12054RE121W	6878	MIL12054RE121P	7566	MIL12054RE121G	6878
Counter Height 120 x 54 x 36	285	MIL12054RE131W	7131	MIL12054RE131P	7845	MIL12054RE131G	7131	"M" Option N/A	
Bar Height 120 x 54 x 42	290	MIL12054RE141W	7384	MIL12054RE141P	8123	MIL12054RE141G	7384	"M" Option N/A	

2 Select a finish View finish details	Top finishes		Base finishes		Top finishes		Base finishes		Top finishes		Base finishes	
		WEC	WOW	WEW	WGW	WBW	WSW	WNW	WWP	WBO	WMO	WNO
	WOW	WEW	WGW	WBW	WSW	WNW	WWP	WBO	WMO	WNO	WSO	WEC
	WEW	WGW	WBW	WSW	WNW	WWP	WBO	WMO	WNO	WSO	WEC	WNW
	WGW	WBW	WSW	WNW	WWP	WBO	WMO	WNO	WSO	WEC	WNW	WBO
	WBW	WSW	WNW	WWP	WBO	WMO	WNO	WSO	WEC	WNW	WBO	WMO
	WSW	WNW	WWP	WBO	WMO	WNO	WSO	WEC	WNW	WBO	WMO	WNO
	WNW	WWP	WBO	WMO	WNO	WSO	WEC	WNW	WBO	WMO	WNO	WSO
	WWP	WBO	WMO	WNO	WSO	WEC	WNW	WBO	WMO	WNO	WSO	WEC

3 Select a edge View edge details	Flat		Flat		Flat	

4 Select hardware View hardware details	Hardware N/A		Hardware N/A		Hardware N/A	

Product features.

- 1-1/2" Thick veneer top, 1 5/16" HPL top
- 1" adjustable glides
- ENVI-CT Finish on wood tops
- Solid 1" hardwood walnut/oak legs to maximize strength and longevity
- One piece top
- Shipped KD in subassemblies

NOTES

- All "G" style tops have a solid wood base, specify a "W" base finish
- 120" has crossgrain

Options.

DUAL POWER

- PD-DUAL3P3J: 3 Packs (2 USB, 6 USB total) w/ 3' jumper - \$1170
- PD-DUAL3P6J: 3 Packs (2 USB, 6 USB total) w/ 6' jumper - \$1185
- PD-DUAL3P12J: 3 Packs (2 USB, 6 USB total) w/ 12' jumper - \$1200
- PD-DUAL4P3J: 4 Packs (2 USB, 8 USB total) w/ 3' jumper - \$1450
- PD-DUAL4P6J: 4 Packs (2 USB, 8 USB total) w/ 6' jumper - \$1470
- PD-DUAL4P12J: 4 Packs (2 USB, 8 USB total) w/ 12' jumper - \$1490
- PD-DUAL8P3J: 8 Packs (2 USB, 16 USB total) w/ 3' jumper - \$2825
- PD-DUAL8P6J: 8 Packs (2 USB, 16 USB total) w/ 6' jumper - \$2865
- PD-DUAL8P12J: 8 Packs (2 USB, 16 USB total) w/ 12' jumper - \$2905

SOBA WIRE MANAGEMENT

- SCD: Soba wire management - \$210

Milner.

Conference Table
Rectangle - 60" Depth

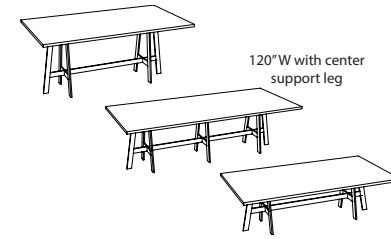

[View statement of line](#)

1 Select a model w" x d" x h"	weight	Standard Veneer Top Solid Wood Base		Premium Veneer Top Solid Wood Base		High Pressure Laminate Top Solid Wood Base		Thermally Fused Laminate Top Solid Wood Base	
Conference Height 120 x 60 x 30	305	MIL12060RE121W	7131	MIL12060RE121P	7845	MIL12060RE121G	7131	"M" Option N/A	
Counter Height 120 x 60 x 36	310	MIL12060RE131W	7384	MIL12060RE131P	8123	MIL12060RE131G	7384	"M" Option N/A	
Bar Height 120 x 60 x 42	315	MIL12060RE141W	7638	MIL12060RE141P	8402	MIL12060RE141G	7638	"M" Option N/A	

2 Select a finish View finish details	Top finishes		Base finishes		Top finishes		Base finishes		Top finishes		Base finishes	
	WEC	WOW	WOW	WOW	WBO	WMO	WMO	WMO	GEW	WEW	WEW	WEW
	WEW	WEW	WEW	WEW	WNO	WNO	WNO	WNO	GWL	WWP	WWP	WWP
	WGW	WGW	WGW	WGW	WNO	WNO	WNO	WNO	GEC	WEC	WEC	WEC
	WBW	WBW	WBW	WBW	WSO	WSO	WSO	WSO	GNW	WNW	WNW	WNW
	WSW	WSW	WSW	WSW								
	WNW	WNW	WNW	WNW								
	WWP	WWP	WWP	WWP								

3 Select a edge View edge details	Flat		Flat		Flat	

4 Select hardware View hardware details	Hardware N/A		Hardware N/A		Hardware N/A	

Product features.

- 1-1/2" Thick veneer top, 1 5/16" HPL top
- 1" adjustable glides
- ENVI-CT Finish on wood tops
- Solid 1" hardwood walnut/oak legs to maximize strength and longevity
- One piece top
- Shipped KD in subassemblies

NOTES

- All "G" style tops have a solid wood base, specify a "W" base finish
- 120" has crossgrain

Options.

DUAL POWER

- PD-DUAL3P3J: 3 Packs (2 USB, 6 USB total) w/ 3' jumper - \$1170
- PD-DUAL3P6J: 3 Packs (2 USB, 6 USB total) w/ 6' jumper - \$1185
- PD-DUAL3P12J: 3 Packs (2 USB, 6 USB total) w/ 12' jumper - \$1200
- PD-DUAL4P3J: 4 Packs (2 USB, 8 USB total) w/ 3' jumper - \$1450
- PD-DUAL4P6J: 4 Packs (2 USB, 8 USB total) w/ 6' jumper - \$1470
- PD-DUAL4P12J: 4 Packs (2 USB, 8 USB total) w/ 12' jumper - \$1490
- PD-DUAL8P3J: 8 Packs (2 USB, 16 USB total) w/ 3' jumper - \$2825
- PD-DUAL8P6J: 8 Packs (2 USB, 16 USB total) w/ 6' jumper - \$2865
- PD-DUAL8P12J: 8 Packs (2 USB, 16 USB total) w/ 12' jumper - \$2905

SOBA WIRE MANAGEMENT

- SCD: Soba wire management - \$210

Milner.

Barstool
Barstool

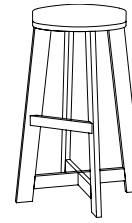

[View statement of line](#)

Product features.

- 2.5" Upholstered Seat
- Solid 3/4" hardwood walnut/oak legs to maximize strength and longevity
- Clear cap foot rail guard protects solid wood

1 model	COM	COL	1	2	3	4	5	6	7	8	9	10	11/L1	12	13/L2
MIL2332BAR38	843	868	871	885	899	913	927	941	955	969	983	997	1011	1025	1053
W x D x H 20 x 20 x 30 Arm Height: n/a Seat Height: 30" Inside Seat Depth: 14" Inside Seat Width: 14"	Upholstery Requirements Fabric yds: 0.75 Leather Sq. Ft.: 13.5 Carton Weight: 35														

2 Select a finish

[View finish details](#)

- WEC Ebony
- WOW Clear Walnut
- WEW Executive Walnut
- WGW Gunstock Walnut
- WBW Henna Walnut
- WSW Smokey Walnut
- WNW Natural Walnut
- WWP Designer White Paint
- WBO Blush Oak
- WMO Mocha Oak
- WNO Natural Oak
- WSO Salted Oak

3 Combination Fabrics

[View finish details](#)

Combination
Fabric Option
Not Available

Milner.

Counter Height
Counter Height Stool

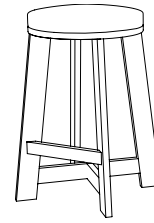

[View statement of line](#)

Product features.

- 2.5" Upholstered Seat
- Solid 3/4" hardwood walnut/oak legs to maximize strength and longevity
- Clear cap foot rail guard protects solid wood

1 model	COM	COL	1	2	3	4	5	6	7	8	9	10	11/L1	12	13/L2
MIL2332CTR43	815	840	843	857	871	885	899	913	927	941	955	969	983	997	1025
W x D x H 19 x 19 x 24			Upholstery Requirements												
Arm Height: n/a			Fabric yds: 0.75 Leather Sq. Ft.: 13.5												
Seat Height: 24"			Carton Weight: 30												
Inside Seat Depth: 14"															
Inside Seat Width: 14"															

2 Select a finish

[View finish details](#)

- WEC Ebony
- WOW Clear Walnut
- WEW Executive Walnut
- WGW Gunstock Walnut
- WBW Henna Walnut
- WSW Smokey Walnut
- WNW Natural Walnut
- WWP Designer White Paint
- WBO Blush Oak
- WMO Mocha Oak
- WNO Natural Oak
- WSO Salted Oak

3 Combination Fabrics

[View finish details](#)

Combination
Fabric Option
Not Available

Milner.

Bench Seat
Bench Seat

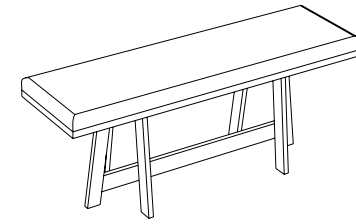

[View statement of line](#)

Product features.

- 1.5" Upholstered Seat
- Solid 3/4" hardwood walnut/oak legs to maximize strength and longevity

1 model	COM	COL	1	2	3	4	5	6	7	8	9	10	11/L1	12	13/L2
MIL4814TSB02	1424	1451	1480	1508	1536	1564	1592	1620	1648	1676	1704	1732	1760	1788	1844
W x D x H 48 x 14 x 19 Arm Height: n/a Seat Height: 19" Inside Seat Depth: 14" Inside Seat Width: 48"	Upholstery Requirements Fabric yds: 1.5 Leather Sq. Ft.: 27 Carton Weight: 30														

2 Select a finish

[View finish details](#)

- WEC Ebony
- WOW Clear Walnut
- WEW Executive Walnut
- WGW Gunstock Walnut
- WBW Henna Walnut
- WSW Smokey Walnut
- WNW Natural Walnut
- WWP Designer White Paint
- WBO Blush Oak
- WMO Mocha Oak
- WNO Natural Oak
- WSO Salted Oak

3 Combination Fabrics

[View finish details](#)

Combination
Fabric Option
Not Available

Milner.

Bench Seat
Bench Seat

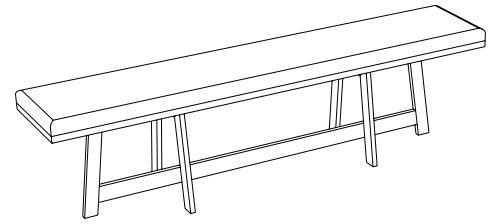

1 model	COM	COL	1	2	3	4	5	6	7	8	9	10	11/L1	12	13/L2
MIL7214TSB03	1610	1639	1693	1734	1775	1816	1857	1898	1939	1980	2021	2062	2103	2144	2226
W x D x H 72 x 14 x 19															
Arm Height: n/a															
Seat Height: 19"															
Inside Seat Depth: 14"															
Inside Seat Width: 72"															
			Upholstery Requirements Fabric yds: 2.25 Leather Sq. Ft.: 41 Carton Weight: 45												

[View statement of line](#)

Product features.

- 1.5" Upholstered Seat
- Solid 3/4" hardwood walnut/oak legs to maximize strength and longevity

2 Select a finish

[View finish details](#)

- WEC Ebony
- WOW Clear Walnut
- WEW Executive Walnut
- WGW Gunstock Walnut
- WBW Henna Walnut
- WSW Smokey Walnut
- WNW Natural Walnut
- WWP Designer White Paint
- WBO Blush Oak
- WMO Mocha Oak
- WNO Natural Oak
- WSO Salted Oak

3 Combination Fabrics

[View finish details](#)

Combination
Fabric Option
Not Available

power & data options.

Soba wire manager

Style Number	List Price
STARTER UNITS	
SCDW	\$200
White wire manager	
SCDB	\$200
Black wire manager	

Specifications

- › Dimensions: 9ft x 9in x 3.15in
- › Zips up, bundles and routes loose, messy cables into a single tube
- › Routes and guides cables behind desks, TVs, and anywhere cables tend to get messy
- › Accommodates large or small cables, up to three cables at once
- › Support channels, used to route cables, include powerful adhesive backing which allows easy attachment to surfaces.

Available: All DARRAN collections



power & data options.

Dual

Style Number	List Price
STARTER UNITS	
PD-DUAL3P3J	\$1170
3 modules; 3' jumpers	
PD-DUAL3P6J	\$1185
3 modules; 6' jumpers	
PD-DUAL3P12J	\$1200
3 modules; 12' jumpers	
PD-DUAL4P3J	\$1450
4 modules; 3' jumpers	
PD-DUAL4P6J	\$1470
4 modules; 6' jumpers	
PD-DUAL4P12J	\$1490
4 modules; 12' jumpers	
PD-DUAL8P3J	\$2825
8 modules; 3' jumpers	
PD-DUAL8P6J	\$2865
8 modules; 6' jumpers	
PD-DUAL8P12J	\$2905
8 modules; 12' jumpers	

Specifications

- > Size: 3" x 1.75" x 1.25"
- > (2) 2.4 Amp USB charging ports per module
- > Undersurface mount
- > 72" cord
- > Standard black finish, available in white upon request
- > UL certified

Available: Conference, Milner, Thinking Quietly

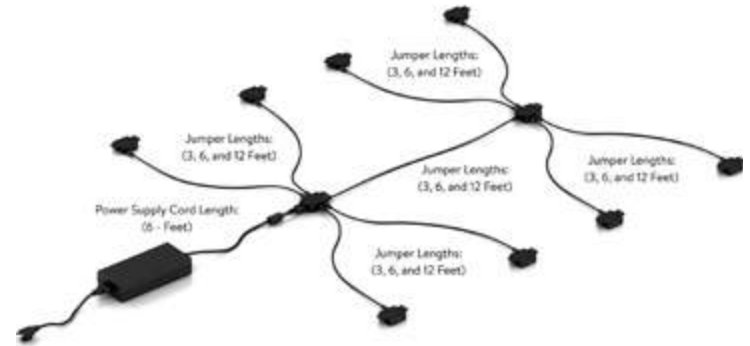

Occasional price list



effective july 1, 2021

designed by keith melbourne

Occasional table of contents

Statement of Line	
Features & Advantages	
Finishes.....	1
Edges Pulls Knobs.....	2
Around Town Tables.....	3
Cell Tables.....	4
Fluted Post Tables.....	5
Grove Tables	7
Jackson Tables.....	10
Lamina Tables	13
Trade Street Tables	14
Zum Tables.....	18
Options.....	19

Occasional statement of line.

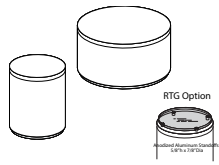

PAGE 3
Around Town Tables

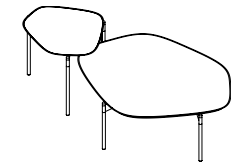

PAGE 4
Cell Tables

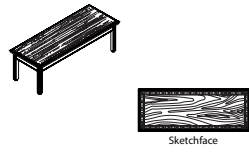

PAGE 5
Fluted Post Tables



PAGE 6
Fluted Post Tables



PAGE 7
Grove Small Round Table



PAGE 8
Grove Square Table



PAGE 9
Grove Round Table

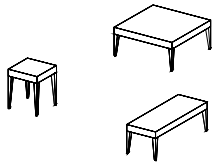

PAGE 10
Jackson Tables

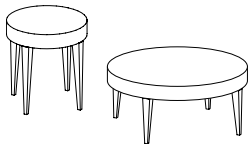

PAGE 11
Jackson Tables

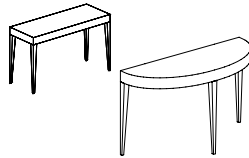

PAGE 12
Jackson Tables



PAGE 13
Lamina Tables

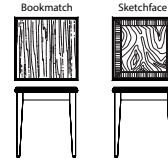

PAGE 14
Trade Street Tables

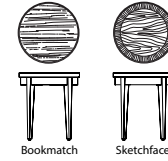

PAGE 15
Trade Street Tables

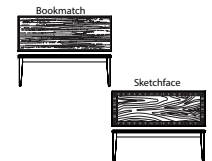

PAGE 16
Trade Street Tables

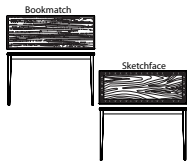

PAGE 17
Trade Street Tables

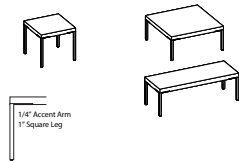

PAGE 18
Zum Table

Occasional finishes | specifications

STANDARD VENEER		PREMIUM VENEER		HIGH PRESSURE LAMINATE		THERMALLY FUSED LAMINATE	
WLA Lofty Ash	N/A	N/A	N/A	N/A	N/A	N/A	N/A
WAC Amber Cherry	N/A	N/A	N/A	GAC Amber Cherry	N/A	MAC Amber Cherry	N/A
WRC Caramel Cherry	N/A	N/A	N/A	N/A	N/A	N/A	N/A
WIC Crimson Cherry	N/A	N/A	N/A	GIC Crimson Cherry	N/A	N/A	N/A
WEC Ebony on Cherry	N/A	N/A	N/A	GEC Ebony	N/A	MEC Ebony	N/A
WHC Honey Cherry	N/A	N/A	N/A	GHC Honey Cherry	N/A	MHC Honey Cherry	N/A
WOC KoKo Cherry	N/A	N/A	N/A	GOC KoKo Cherry	N/A	MOC KoKo Cherry	N/A
WAM Alabaster Maple	N/A	N/A	N/A	GAM Alabaster Maple	N/A	N/A	N/A
WCM Clear Maple	N/A	N/A	N/A	GCM Clear Maple	N/A	N/A	N/A
WWM Wheat Maple	N/A	N/A	N/A	GWM Wheat Maple	N/A	N/A	N/A
N/A	N/A	WBO Blush Oak	N/A	N/A	N/A	N/A	N/A
N/A	N/A	WMO Mocha Oak	N/A	N/A	N/A	N/A	N/A
N/A	N/A	WSO Salted Oak	N/A	N/A	N/A	N/A	N/A
WEW Executive Walnut	N/A	N/A	N/A	GEW Executive Walnut	N/A	N/A	N/A
WGW Gunstock Walnut	N/A	N/A	N/A	N/A	N/A	MGW Gunstock Walnut	N/A
WBW Henna Walnut	N/A	N/A	N/A	N/A	N/A	N/A	N/A
WSW Smokey Walnut	N/A	N/A	N/A	N/A	N/A	N/A	N/A
WNW Natural Walnut	N/A	N/A	N/A	GNW Natural Walnut	N/A	N/A	N/A
N/A	N/A	TBCO Baby's Cheek	N/A	N/A	N/A	N/A	N/A
N/A	N/A	TBSW Brown Sugar	N/A	N/A	N/A	N/A	N/A
N/A	N/A	TOBW Organic Brown	N/A	N/A	N/A	N/A	N/A
N/A	N/A	TSTV Studio Teak Walnut	N/A	GSTV Studio Teak Walnut	N/A	MTW Studio Teak Walnut	N/A
N/A	N/A	TSMV Seattle Mist	N/A	N/A	N/A	N/A	N/A
N/A	N/A	TSLV Skyline Walnut	N/A	GSLV Skyline Walnut	N/A	N/A	N/A

Note: Finish availability differs on each product. please see specific product page for availability.

Occasional edges

Standard profile

Capitol Park Edge for "M" Styles

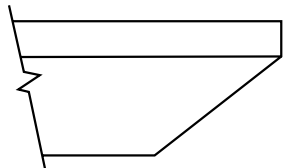

NSS Bevel
3mm solid
hardwood band

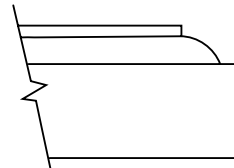

Classic
3mm solid
hardwood band

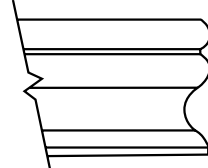

Cobee

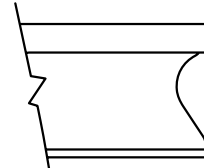

Cove

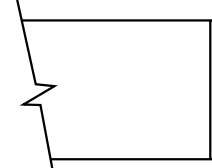

Flat
"W" 3mm solid hardwood band
"P" 3mm solid hardwood band
"G" HPL self edge

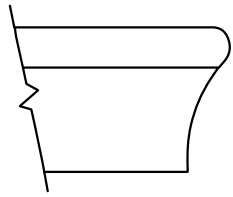

Knife

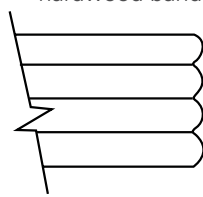

Reed

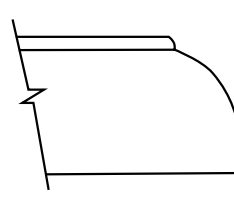

Waterfall

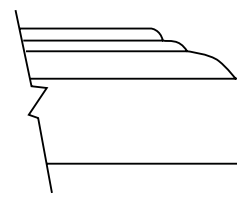

Traditional

"W" & "G" Premium profile

3/4" Hardwood Rim Band Species Same As Surface Veneer

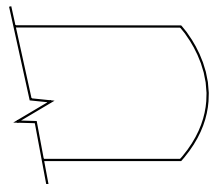

Bullnose

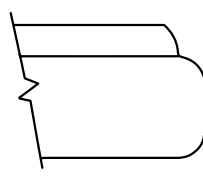

Ogee

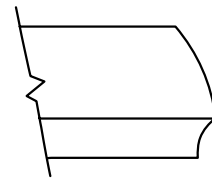

Radius

Pulls/knobs

Factory Installed

PL-5 Antique Brass

PL-50 Brushed Pewter



PL-4 Antique Brass



Note: edge and hardware availability differs on each product. please see specific product page for availability.

Occasional.

Around Town Tables
Plinthe Table

1 Select a model w" x d" x h"		weight	Standard Veneer Top Standard Veneer	Premium Veneer Top Premium Veneer Chassis	High Pressure Laminate Top Veneer Chassis	Thermally Fused Laminate Top Thermally Fused Laminate Chassis
Cocktail						
36 dia x 16		70	DBO3636RT372W 2165	DBO3636RT372P 2382	DBO3636RT372G 2165	"M" Option N/A
30 dia x 16		55	DBO3030RT372W 2003	DBO3030RT372P 2204	DBO3030RT372G 2003	"M" Option N/A
End						
24 dia x 22		45	DBO2424RT372W 1406	DBO2424RT372P 1547	DBO2424RT372G 1406	"M" Option N/A
18 dia x 22		40	DBO1818RT372W 1350	DBO1818RT372P 1485	DBO1818RT372G 1350	"M" Option N/A
2 Select a finish <i>View finish details</i>			WAC WGW	WBO	GAC	
Metal finish			WRC WBW	WMO	GIC	
MFB Black, MFS Silver			WIC WSW	WSO	GHC	
			WEC WNW		GOC	
			WHC		GAM	
			WOC		GCM	
			WAM		GWM	
			WCM		GEW	
			WWW		GNW	
			WEW			
3 Select a edge <i>View edge details</i>			Edge	Edge	Edge	
			N/A	N/A	N/A	
4 Select hardware <i>View hardware details</i>			Hardware	Hardware	Hardware	
			N/A	N/A	N/A	

[View statement of line](#)

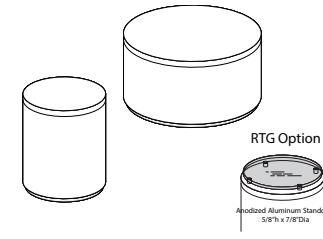

Product features.

- 1" Top with 3mm wood edge
- Plinthe base with black or optional silver accent
- Glides

NOTES

- Available in maple veneer only. Cherry and walnut finishes are matched on maple veneer

Options.

FROSTED GLASS TOP

- RTG22: 17" dia Frosted glass top - \$365
- RTG24: 23" dia Frosted glass top - \$390
- RTG26: 29" dia Frosted glass top - \$570
- RTG28: 35" dia Frosted glass top - \$755

CLEAR GLASS TOP

- RTG12: 17" dia Clear glass top - \$260
- RTG14: 23" dia Clear glass top - \$290
- RTG16: 29" dia Clear glass top - \$415
- RTG18: 35" dia Clear glass top - \$550

Occasional.

Cell Tables

Cocktail Table And End Table

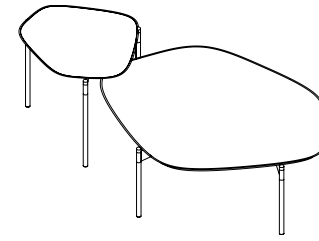

[View statement of line](#)

1 Select a model w" x d" x h"	weight	Standard Veneer Top Black Metal Base		Premium Veneer Top Black Metal Base		High Pressure Laminate Top Black Metal Base		Thermally Fused Laminate Top Black Metal Base	
End Table 23 x 19 x 17.75	60	CEL2319MT366W	1097	CEL2319MT366P	1207	CEL2319MT366G	1097	"M" Option N/A	
Cocktail Table 42 x 32 x 14.25	85	CEL4232MT369W	1524	CEL4232MT369P	1677	CEL4232MT369G	1524	"M" Option N/A	
2 Select a finish View finish details		WAC	WGW	WBO	TOBW	GAC	GNW		
Metal finish		WRC	WBW	WMO		GIC	GSTV		
MFB Black (standard),		WIC	WSW	WSO		GEC	GSLV		
MFW White (optional),		WEC	WNW	WOW		GHC	GWL		
MFS Silver (optional)		WHC	WWP	TBCO		GOC	GWL		
		WOC		TBSW		GAM			
		WAM		TSTV		GCM			
		WCM		TSMV		GWM			
		WWW		TSLV		GEW			
		WEW							
3 Select a edge View edge details		Edge		Edge		Edge			
		N/A		N/A		N/A			
4 Select hardware View hardware details		Hardware		Hardware		Hardware			
		N/A		N/A		N/A			

Product features.

- 1" Thick top
- Black metal finish standard (available in white and silver)
- Shipped KD

Options.

METAL FINISHES

- Specify metal finish leg color. End table - \$80 upcharge. Cocktail table - \$100 upcharge.
- MFW: White, MFS: Silver





Occasional.

Fluted Post Tables
Cocktail Table



Sketchface

[View statement of line](#)

1 Select a model w" x d" x h"	weight	Standard Veneer Top Standard Hardwood Base		Premium Veneer Top Premium Hardwood Base		High Pressure Laminate Top Standard Hardwood Base		Thermally Fused Laminate Top Standard Hardwood Base	
		Bookmatch Face							
Cocktail									
18 x 48 x 16	50	DBO1848FT351W	1358	"P" Option N/A		DBO1848FT351G	1358	"M" Option N/A	
36 x 36 x 16	60	DBO3636FT351W	1390	"P" Option N/A		DBO3636FT351G	1390	"M" Option N/A	
End									
24 x 24 x 20	40	DBO2424FT351W	1112	"P" Option N/A		DBO2424FT351G	1112	"M" Option N/A	
18 x 18 x 20	30	DBO1818FT351W	898	"P" Option N/A		DBO1818FT351G	898	"M" Option N/A	
Sketch Face									
Cocktail									
18 x 48 x 16	50	DBO1848FS351W	1514	"P" Option N/A		"G" Option N/A		"M" Option N/A	
36 x 36 x 16	60	DBO3636FS351W	1656	"P" Option N/A		"G" Option N/A		"M" Option N/A	
End									
24 x 24 x 20	40	DBO2424FS351W	1290	"P" Option N/A		"G" Option N/A		"M" Option N/A	
18 x 18 x 20	30	DBO1818FS351W	1095	"P" Option N/A		"G" Option N/A		"M" Option N/A	
2 Select a finish View finish details		WAC WNW				GAC			
		WRC				GIC			
		WIC				GHC			
		WEC				GOC			
		WHC				GEW			
		WOC				GNW			
		WEW							
		WGW							
		WBW							
		WSW							
3 Select a edge View edge details		 Classic				 Cove			
		 Cove				 Traditional			
		 Traditional							
4 Select hardware View hardware details		Hardware N/A				Hardware N/A			

Product features.

- 1-5/16" Thick top
- Floor levelers (adjustable 1/2")
- Solid hardwood base legs

NOTES







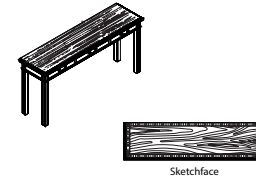



- Sketch face tops feature quartered cherry borders with cherry infield.
- Tables are available in Cherry and Walnut Finishes

Occasional.

Fluted Post Tables
Console Table



[View statement of line](#)

1 Select a model w" x d" x h"	weight	Standard Veneer Top Standard Hardwood Base		Premium Veneer Top Premium Hardwood Base		High Pressure Laminate Top Standard Hardwood Base		Thermally Fused Laminate Top Standard Hardwood Base	
		Bookmatch Face 16 x 60 x 29 16 x 48 x 29 Sketch Face 16 x 60 x 29 16 x 48 x 29	85 75 85 75	DBO1660JW361W DBO1648JW361W DBO1660JS361W DBO1648JS361W	1789 1649 2070 1928	"P" Option N/A "P" Option N/A "P" Option N/A "P" Option N/A	DBO1660JW361G DBO1648JW361G "G" Option N/A "G" Option N/A	1789 1649 "M" Option N/A "M" Option N/A	"M" Option N/A "M" Option N/A "M" Option N/A "M" Option N/A
2 Select a finish View finish details		WAC WNW WRC WIC WEC WHC WOC WEW WGW WBW WSW			GAC GIC GHC GOC GEW GNW				
3 Select an edge View edge details		 Classic  Cove  Traditional			 Classic  Cove  Traditional				
4 Select hardware View hardware details		 PL-4 Antique Brass  PL-5 Antique Brass PL-50 Brushed Pewter			 PL-4 Antique Brass  PL-5 Antique Brass PL-50 Brushed Pewter				

Product features.

- 1-5/16" Thick top
- Floor levelers (adjustable 1/2")
- Solid hardwood base legs

NOTES

- Sketch face tops feature quartered cherry borders with cherry infield.
- Tables are available in Cherry and Walnut Finishes

Occasional.

Grove Small Round Table
Acacia Stool/Round Table



1 Select a model		Live Edge					
w" x d" x h"	weight						
12 dia x 17	50	GRO1217AS372W	474				
* Stool/Table depth varies							
2 Select a finish		WLE					
View finish details							
3 Select a edge		Edge					
View edge details		N/A					
4 Select hardware		Hardware					
View hardware details		N/A					

[View statement of line](#)

Product features.

NOTES

- Butterflies are hand placed based on the tables natural characteristic
- Every stool is unique with live edge detailing
- Natural cracks in the wood are considered normal and enhance the beauty of the stool

Occasional.

Grove Square Table
Acacia Stool/Square Table



1 Select a model		Live Edge		View statement of line	
w" x d" x h"	weight				
12 x 12 x 18	60	GRO1212CM373W	683		
* Stool/Table depth varies					
2 Select a finish		WLE			
View finish details					
3 Select a edge		Edge			
View edge details		N/A			
4 Select hardware		Hardware			
View hardware details		N/A			

Product features.

NOTES

- Butterflies are hand placed based on the tables natural characteristic
- Every stool is unique with live edge detailing
- Natural cracks in the wood are considered normal and enhance the beauty of the stool
- Stools are cut from the Acacia Tree and has figured grain with distinct sap line edges

Occasional.

Grove Round Table
Acacia Stool/Round Table



1 Select a model		Live Edge		View statement of line	
w" x d" x h"	weight				
16 dia x 21	140	GRO1621AS372W	958		
* Stool/Table depth varies					
2 Select a finish		WLE			
View finish details					
3 Select a edge		Edge			
View edge details		N/A			
4 Select hardware		Hardware			
View hardware details		N/A			

Product features.

NOTES

- Butterflies are hand placed based on the tables natural characteristic
- Every stool is unique with live edge detailing
- Natural cracks in the wood are considered normal and enhance the beauty of the stool

Occasional.

Jackson Tables

Square End Table/Cocktail

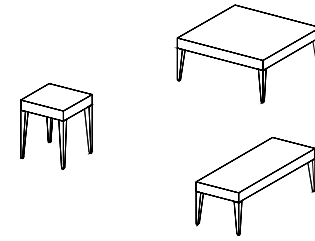

[View statement of line](#)

1 Select a model w" x d" x h"	weight	Standard Veneer Top Standard Hardwood Base		Premium Veneer Top Premium Hardwood Base		High Pressure Laminate Top Standard Hardwood Base		Thermally Fused Laminate Top Standard Hardwood Base	
		End Table							
24 x 24 x 22	40	DBO2424JK366W	1187	"P" Option N/A		DBO2424JK366G	1187	"M" Option N/A	
18 x 18 x 22	35	DBO1818JK366W	1114	"P" Option N/A		DBO1818JK366G	1114	"M" Option N/A	
Cocktail Table									
48 x 18 x 16	50	DBO4818JK369W	1612	"P" Option N/A		DBO4818JK369G	1612	"M" Option N/A	
42 x 42 x 16	65	DBO4242JK369W	1794	"P" Option N/A		DBO4242JK369G	1794	"M" Option N/A	
36 x 36 x 16	55	DBO3636JK369W	1685	"P" Option N/A		DBO3636JK369G	1685	"M" Option N/A	
2 Select a finish View finish details		WAC	WBW			GAC			
		WRC	WSW			GIC			
		WIC	WNW			GHC			
		WEC	WWP			GOC			
		WHC				GCM			
		WOC				GWM			
		WCM				GEW			
		WWM				GNW			
		WEW				GWL			
		WGW							
3 Select a edge View edge details		Edge				Edge			
		N/A				N/A			
4 Select hardware View hardware details		Hardware				Hardware			
		N/A				N/A			

Product features.

- 3-3/4" Thick top
- Flat-cut w/ reverse slip-matched veneer
- Glides
- Tapered solid hardwood legs

Occasional.

Jackson Tables
Round Table

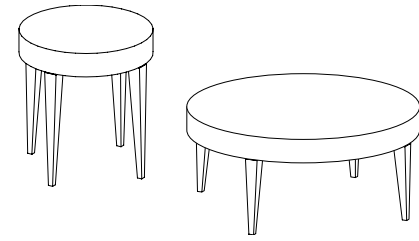

[View statement of line](#)

1 Select a model w" x d" x h"	weight	Standard Veneer Top Standard Hardwood Base		Premium Veneer Top Premium Hardwood Base		High Pressure Laminate Top Standard Hardwood Base		Thermally Fused Laminate Top Standard Hardwood Base	
		End Table 24 dia x 22 18 dia x 22	40 35	DBO2424JK367W DBO1818JK367W	1405 1193	"P" Option N/A "P" Option N/A		DBO2424JK367G DBO1818JK367G	1405 1193
Cocktail Table 42 dia x 16 36 dia x 16	65 55	DBO4242JK367W DBO3636JK367W	2024 1771	"P" Option N/A "P" Option N/A		DBO4242JK367G DBO3636JK367G	2024 1771	"M" Option N/A "M" Option N/A	
2 Select a finish View finish details		WAC WRC WIC WEC WHC WOC WCM WWM WEW WGW	WBW WSW WNW WWP			GAC GIC GHC GOC GCM GWM GEW GNW GWL			
3 Select an edge View edge details		Edge N/A				Edge N/A			
4 Select hardware View hardware details		Hardware N/A				Hardware N/A			

Product features.

- 3-3/4" Thick top
- Flat-cut w/ reverse slip-matched veneer
- Glides
- Tapered solid hardwood legs

Occasional.

Jackson Tables
Console Tables

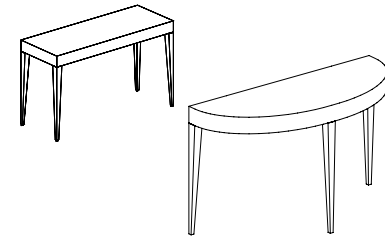

1 Select a model w" x d" x h"		weight	Standard Veneer Top Standard Hardwood Base	Premium Veneer Top Premium Hardwood Base	High Pressure Laminate Top Standard Hardwood Base	Thermally Fused Laminate Top Standard Hardwood Base
Square Console Table 48 x 18 x 29		60	DBO4818JK361W 1722	"P" Option N/A	DBO4818JK361G 1722	"M" Option N/A
Semi-Circle Console 48 x 18 x 29		60	DBO4818JK367W 2208	"P" Option N/A	DBO4818JK367G 2208	"M" Option N/A
2 Select a finish <i>View finish details</i>			WAC WSW WRC WSW WIC WNW WEC WWP WHC WOC WCM WWM WEW WGW		GAC GIC GHC GOC GCM GWM GEW GNW GWL	
3 Select a edge <i>View edge details</i>			Edge N/A		Edge N/A	
4 Select hardware <i>View hardware details</i>			Hardware N/A		Hardware N/A	

[View statement of line](#)

Product features.

- 3-3/4" Thick top
- Flat-cut w/ reverse slip-matched veneer
- Glides
- Tapered solid hardwood legs

Occasional.

Lamina Tables
End Table/Coffee Table

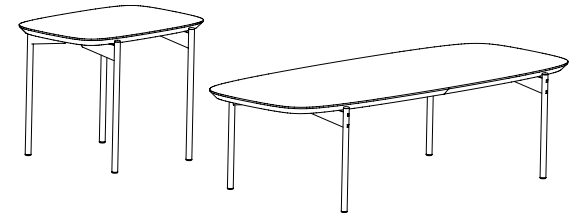

1 Select a model w" x d" x h"		weight	Standard Veneer Top Black Metal Base	Premium Veneer Top Black Metal Base	High Pressure Laminate Top Black Metal Base	Thermally Fused Laminate Top Black Metal Base
End Table 23.25 x 15.75 x 17.5		1227	LAM2315MT359W	LAM2315MT359P 1350	LAM2315MT359G 1134	"M" Option N/A
Coffee Table 52.5 x 21.5 x 14.25		1487	LAM5221MT359W	LAM5221MT359P 1636	LAM5221MT359G 1373	"M" Option N/A
2 Select a finish View finish details			WAC WGW WRC WBW WIC WSW	WBO TOBW WMO WSO WOW TBCO TBSW TSTV TSMV TSLV	GAC GNW GIC GSTV GEC GSLV GHC GWL GOC GWL GAM GCM GWM GEW	
Metal finish MFB Black (standard), MFW White (optional), MFS Silver (optional)			WEC WNW WHC WWP WAM WCM WWW WEW			
3 Select a edge View edge details			Edge N/A	Edge N/A	Edge N/A	
4 Select hardware View hardware details			Hardware N/A	Hardware N/A	Hardware N/A	

[View statement of line](#)

Product features.

- 1" Thick top
- Black metal finish standard
- Shipped KD

Options.

QUARTERED VENEER

- QW1: Quartered Walnut Veneer Upgrade - 5% upcharge

METAL FINISHES

- Specify metal finish leg color: \$105 upcharge
- MFB: Black, MFW: White, MFS: Silver

Occasional.

Trade Street Tables
Square Table

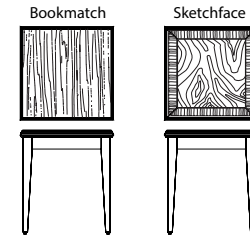

[View statement of line](#)

1 Select a model w" x d" x h"	weight	Standard Veneer Top Standard Hardwood Base		Premium Veneer Top Premium Hardwood Base		High Pressure Laminate Top Standard Hardwood Base		Thermally Fused Laminate Top Standard Hardwood Base	
		Bookmatch Face							
Cocktail 36 x 36 x 16	57	DBO3636TT366W	1236	"P" Option N/A		DBO3636TT366G	1236	"M" Option N/A	
End 24 x 24 x 20	40	DBO2424TT366W	1084	"P" Option N/A		DBO2424TT366G	1084	"M" Option N/A	
18 x 18 x 20	35	DBO1818TT366W	1017	"P" Option N/A		DBO1818TT366G	1017	"M" Option N/A	
Sketch Face									
Cocktail 36 x 36 x 16	57	DBO3636TS366W	1348	"P" Option N/A		"G" Option N/A		"M" Option N/A	
End 24 x 24 x 20	40	DBO2424TS366W	1196	"P" Option N/A		"G" Option N/A		"M" Option N/A	
18 x 18 x 20	35	DBO1818TS366W	1129	"P" Option N/A		"G" Option N/A		"M" Option N/A	
2 Select a finish View finish details		WAC WBW WRC WSW WIC WNW WEC WHC WOC WCM WWM WEW WGW				GAC GIC GHC GOC GCM GWM GEW GNW			
3 Select an edge View edge details		Bullnose Classic Cobee Cove Flat Knife Ogee Radius Reed Waterfall				Bullnose Classic Cobee Cove Flat Knife Ogee Radius Reed Waterfall			
4 Select hardware View hardware details		Hardware N/A				Hardware N/A			

Product features.

- 1-5/16" Thick top
- Glides
- Solid hardwood base and legs

NOTES

- Sketch face tops feature quartered cherry borders with cherry infield.
- Tables are available in Cherry, Maple and Walnut Finishes

Occasional.

Trade Street Tables
Round Table

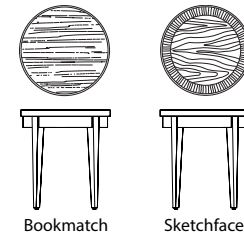

[View statement of line](#)

1 Select a model w" x d" x h"	weight	Standard Veneer Top Standard Hardwood Base		Premium Veneer Top Premium Hardwood Base		High Pressure Laminate Top Standard Hardwood Base		Thermally Fused Laminate Top Standard Hardwood Base	
		Bookmatch Face							
Cocktail 36 dia x 16	45	DBO3636TT367W	1376	"P" Option N/A		DBO3636TT367G	1376	"M" Option N/A	
End 24 dia x 20	35	DBO2424TT367W	1205	"P" Option N/A		DBO2424TT367G	1205	"M" Option N/A	
18 dia x 20	30	DBO1818TT367W	1125	"P" Option N/A		DBO1818TT367G	1125	"M" Option N/A	
Sketch Face									
Cocktail 36 dia x 16	45	DBO3636TS367W	1488	"P" Option N/A		"G" Option N/A		"M" Option N/A	
End 24 dia x 20	35	DBO2424TS367W	1318	"P" Option N/A		"G" Option N/A		"M" Option N/A	
18 dia x 20	30	DBO1818TS367W	1238	"P" Option N/A		"G" Option N/A		"M" Option N/A	
2 Select a finish View finish details		WAC WBW WRC WSW WIC WNW WEC WHC WOC WCM WWM WEW WGW				GAC GIC GHC GOC GCM GWM GEW GNW			
3 Select an edge View edge details		Bullnose Classic Cobee Cove Flat Knife Ogee Radius Reed Waterfall				Bullnose Classic Cobee Cove Flat Knife Ogee Radius Reed Waterfall			
4 Select hardware View hardware details		Hardware N/A				Hardware N/A			

Product features.

- 1-5/16" Thick top
- Glides
- Solid hardwood base and legs

NOTES

- Sketch face tops feature quartered cherry borders with cherry infield.
- Tables are available in Cherry, Maple and Walnut Finishes





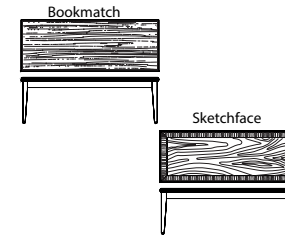













Occasional.

Trade Street Tables
Cocktail Table



1 Select a model w" x d" x h"	weight	Standard Veneer Top Standard Hardwood Base		Premium Veneer Top Premium Hardwood Base		High Pressure Laminate Top Standard Hardwood Base		Thermally Fused Laminate Top Standard Hardwood Base	
		Bookmatch Face 18 x 48 x 16	50	DBO1848TT369W	1376	"P" Option N/A		DBO1848TT369G	1376
Sketch Face 18 x 48 x 16	50	DBO1848TS369W	1656	"P" Option N/A		"G" Option N/A		"M" Option N/A	

2 Select a finish <i>View finish details</i>	Standard Veneer Top		Premium Veneer Top		High Pressure Laminate Top		Thermally Fused Laminate Top	
	<i>View finish details</i>	WAC	WBW			GAC		
	WRC	WSW			GIC			
	WIC	WNW			GHC			
	WEC				GOC			
	WHC				GCM			
	WOC				GWM			
	WCM				GEW			
	WWM				GNW			
	WEW							
	WGW							

3 Select a edge <i>View edge details</i>	Standard Veneer Top		Premium Veneer Top		High Pressure Laminate Top		Thermally Fused Laminate Top	
	<i>View edge details</i>	 Bullnose	 Classic	 Cobee	 Cove	 Bullnose	 Classic	 Cobee
	 Flat	 Knife	 Ogee	 Radius	 Flat	 Knife	 Ogee	 Radius
	 Reed	 Waterfall			 Reed	 Waterfall		

4 Select hardware <i>View hardware details</i>	Standard Veneer Top	Premium Veneer Top	High Pressure Laminate Top	Thermally Fused Laminate Top
	<i>View hardware details</i>	Hardware N/A		Hardware N/A

[View statement of line](#)

Product features.

- 1-5/16" Thick top
- Glides
- Solid hardwood base and legs

NOTES

- Sketch face tops feature quartered cherry borders with cherry infield.
- Tables are available in Cherry, Maple and Walnut Finishes

Occasional.

Trade Street Tables
Console Table

1 Select a model w" x d" x h"

weight	Standard Veneer Top Standard Hardwood Base		Premium Veneer Top Premium Hardwood Base		High Pressure Laminate Top Standard Hardwood Base		Thermally Fused Laminate Top Standard Hardwood Base	
	Bookmatch Face							
	18 x 60 x 29	70 DBO1860TT361W 1794	"P" Option N/A		DBO1860TT361G 1794	"M" Option N/A		
	18 x 48 x 29	60 DBO1848TT361W 1514	"P" Option N/A		DBO1848TT361G 1514	"M" Option N/A		
	Sketch Face							
	18 x 60 x 29	70 DBO1860TS361W 2075	"P" Option N/A		"G" Option N/A	"M" Option N/A		
	18 x 48 x 29	60 DBO1848TS361W 1794	"P" Option N/A		"G" Option N/A	"M" Option N/A		

[View statement of line](#)

2 Select a finish [View finish details](#)

WAC WBW
WRC WSW
WIC WNW
WEC
WHC
WOC
WCM
WWM
WEW
WGW

GAC
GIC
GHC
GOC
GCM
GWM
GEW
GNW

3 Select an edge [View edge details](#)

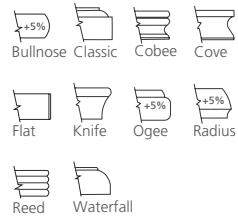

4 Select hardware [View hardware details](#)

Hardware
N/A

Hardware
N/A

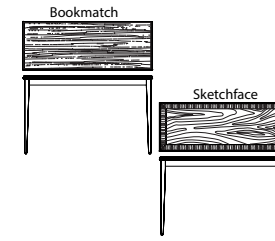

Product features.

- 1-5/16" Thick top
- Glides
- Solid hardwood base and legs

NOTES

- Sketch face tops feature quartered cherry borders with cherry infield.
- Tables are available in Cherry, Maple and Walnut Finishes

Occasional.

Zum Table

End Table/Cocktail Table

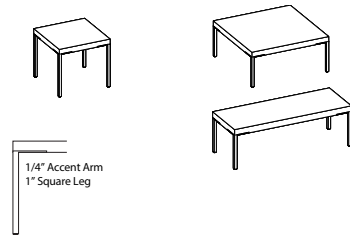

[View statement of line](#)

1 Select a model w" x d" x h"	weight	Standard Veneer Top Brushed Nickel Base		Premium Veneer Top Brushed Nickel Base		High Pressure Laminate Top Brushed Nickel Base		Thermally Fused Laminate Top Brushed Nickel Base	
		End Table							
24 x 24 x 22	35	OPO2424ZU366W	1069	OPO2424ZU366P	1176	OPO2424ZU366G	1069	"M" Option N/A	
18 x 18 x 22	30	OPO1818ZU366W	1019	OPO1818ZU366P	1121	OPO1818ZU366G	1019	"M" Option N/A	
Cocktail Table									
42 x 42 x 16	60	OPO4242ZU369W	1519	OPO4242ZU369P	1671	OPO4242ZU369G	1519	"M" Option N/A	
36 x 36 x 16	55	OPO3636ZU369W	1490	OPO3636ZU369P	1639	OPO3636ZU369G	1490	"M" Option N/A	
30 x 30 x 16	45	OPO3030ZU369W	1435	OPO3030ZU369P	1579	OPO3030ZU369G	1435	"M" Option N/A	
18 x 48 x 16	45	OPO1848ZU369W	1462	OPO1848ZU369P	1609	OPO1848ZU369G	1462	"M" Option N/A	
2 Select a finish View finish details		WAC WRC WIC WEC WHC WOC WAM WCM WWW WWP		WBO WMO WSO TBCO TBSW TSTV TSMV TSLV TOBW		GAC GIC GEC GHC GOC GAM GCM GWM GEW	GNW GSTV GSLV GWL		
3 Select a edge View edge details		Edge N/A		Edge N/A		Edge N/A			
4 Select hardware View hardware details		Hardware N/A		Hardware N/A		Hardware N/A			

Product features.

- 2" Thick top with 3mm hardwood edge band
- Glides
- Brushed nickel legs have accent arms recessed in top edge

Occasional options.

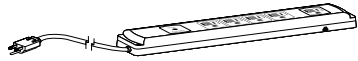

POWER / DATA
power supply cordset

Style Number	List Price
PD717	95

Specifications

- SIZE: 10.75"L x 2.0"W x 1.06"H
- (5) Outlets w/ 10' cord
- Surge suppression (720 Joules)
- 15 Amp breaker
- Available on: Vertical Panels, Cabinet Interiors, and under tops

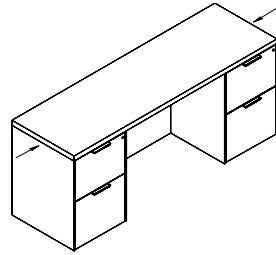

PRODUCT MODIFICATIONS
modify width - open kneespace

Style Number	List Price
MOD-1	125

Specifications

- Modify width down on any unit with an open kneespace: desk, workstation credenza, bridge, return

PRODUCT MODIFICATIONS
modify width - outside of mod-1, mod-2

Style Number	List Price
MOD-3	Contact for pricing

Specifications

- Width modification outside of MOD-1 & MOD-2

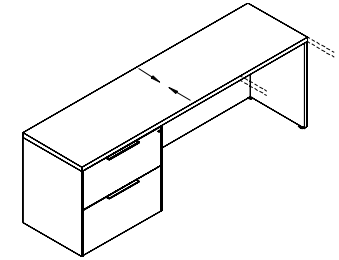

PRODUCT MODIFICATIONS
modify depth - decrease depth

Style Number	List Price
MOD-5	125

Specifications

- Modify depth down (minimum depth for a unit with drawers is 21"D)

Notes
- Ex. 24" to 21", 30" to 24", and 36" to 30"

Occasional options.

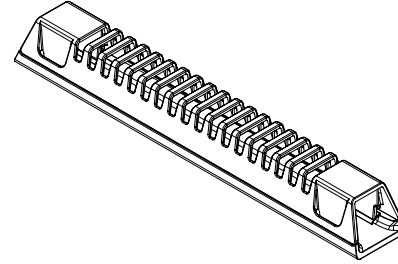
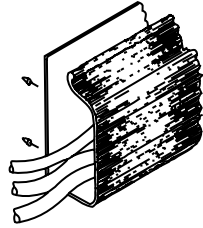

PRODUCT MODIFICATIONS
modify height

Style Number	List Price
MOD-7	Contact for pricing

Specifications

- Modify height of a unit

WIRE MANAGEMENT
horizontal j-channel wire management raceway

Style Number	List Price
W1	80 Per 4' section

Specifications

- 4' section for field installation.
- The "J" shape black thermoplastic wire raceway may be added to specified worksurface tops to provide concealed channeling of wires to and from worksurface grommets. For use in open kneespace areas, raceway is attachable to top of back panel with pan head screws. Interior dimensions are 1" x 1- 1/2" providing ample storage for multiple wires and excess cable. Front of raceway flexes out for easy cord insertion.

- Notes
- Units w/ Wire Channel Standard.
 - Field Installation

WIRE MANAGEMENT
horizontal wire management raceway

Style Number	List Price
W21	35

Specifications

- 10"W x 1.5"D x 1.25"H
- Grey Wire Manager (10.5")
- Power and data cables can be discretely housed and managed with the W21 Gray Wire Manager. This can be mounted in any location to metal frame or underside of conference tables and runs cables through a 1" channel from power module to hollow steel legs. This keeps cables organized under the table top. Release clips make it simple to snap on and off the Wire Manager for easy organization and access after attached to the table

- Notes
- Field installed

WIRE MANAGEMENT
horizontal u-channel wire management raceway

Style Number	List Price
W2A	80 Per 4' section

Specifications

- 4' section for field installation.

- Notes
- Units w/ Wire Channel Standard.
 - Field Installation

Occasional options.

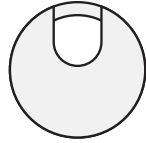
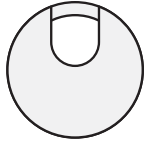

WIRE MANAGEMENT

standard location grommets - factory installed

Style Number	List Price
Standard Location Grommet	
Black	
TM30	50
Silver	
TM31	50
Antique Brass	
TM33	50
White	
TM34	50

Specifications

- 1 -5/8" Metal Grommet

Notes

- *Units w/ Grommets Standard Are Noted Under Standard Features. Grommets Match Pull Finish - Standard (Unless Specified Otherwise)

WIRE MANAGEMENT

non-standard location grommets - factory installed

Style Number	List Price
Non-Standard Location Grommet	
Black	
TM30 -NS	95
Silver	
TM31 -NS	95
Antique Brass	
TM33 -NS	95
White	
TM34 -NS	95

Specifications

- 1 -5/8" Metal Grommet

Notes

- *Units w/ Grommets Standard Are Noted Under Standard Features. Grommets Match Pull Finish - Standard (Unless Specified Otherwise)

WIRE MANAGEMENT

black plastic vertical surface grommets - factory installed

Style Number	List Price
Standard Location Grommet	
TM50-C	50
Non-Standard Location Grommet	
TM50-NS	95

Specifications

- 2 " Black Plastic Grommet

Notes

- Standard Location is Bottom Center

Spire price list



effective july 1, 2021

designed by michael wolk

Spire table of contents

Statement of Line	
Guest seating fabric & leather program.....	1
Finishes.....	4
Occasional Tables.....	7
Conference Tables.....	9
Barstool.....	13
Guest/Lounge Chairs.....	14
Power & Data.....	24

Spire statement of line

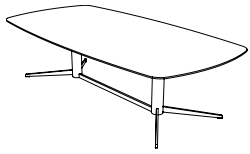

PAGE 7
Occasional Table



PAGE 8
Occasional Table



PAGE 9
Conference Table



PAGE 10
Conference Table



PAGE 11
Conference Table



PAGE 12
Conference Table



PAGE 13
Barstool

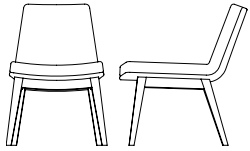

PAGE 14
Guest Chair

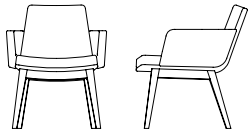

PAGE 15
Guest Chair

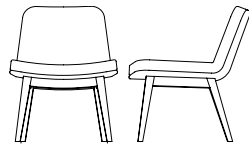

PAGE 16
Lounge Chair

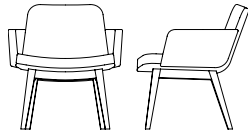

PAGE 17
Lounge Chair



PAGE 18
Guest Chair



PAGE 19
Guest Chair



PAGE 20
Lounge Chair

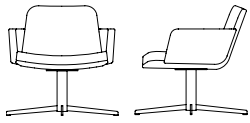

PAGE 21
Lounge Chair

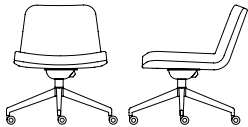

PAGE 22
Conference Lounge Chair

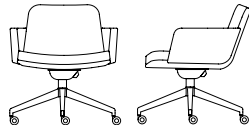

PAGE 23
Conference Lounge Chair

Spire seating fabric & leather program

Seating & fabric leather program

DARRAN has partnered with some of the most prestigious fabric suppliers of the office furniture industry to bring you quality fabrics that are engaging designs, environmentally friendly and durable for years to come. The majority of fabrics we have graded-in are in heavy supply making it most likely available on our Quickship however, we cannot guarantee stock. If you do not see the fabric you wish to include in a project, please contact our Factory to see if this pattern can be graded in at 800.334.7891.

Fabrics & Leathers

Please visit our Seating Fabrics page at darran.com/textilesleather

Camira
www.camirafabrics.com
800.334.789

Wollsdorf
www.wollsdorf.com
336.884.5005

CFStinson
www.cfstinson.com
800.841.6279

Green Hides
www.greenhides.com
336.315.9720

DesignTex
www.designtex.com
800.797.4949

Maharam
www.maharam.com
800.645.3943

Momentum Textiles
www.momentumtextiles.com
800.366.6839

Ultrafabrics
www.ultrafabricsinc.com
800.334.7891

Application instructions must be specified on the purchase order or COM / COL submission form. In the absence of application instructions, DARRAN will apply materials accordingly.

CAL117

All DARRAN seating products conform to California Technical Bulletin 117 as a minimum standard.

CAL133

To meet the California Technical Bulletin 133 flammability regulation, a combination of proper materials must be used to pass, as it tests the fire resistance of a finished product. Flame resistant fabric, a fire blocker material and special foam must be used to pass CAL133 fire codes.

Testing is available for all seating products with the following fees and considerations:

- If laboratory certification is not required, any style can be manufactured to comply with California Technical Bulletin 133 for \$75 list per yard required. (Customer's Own Materials must factor in additional yardage requirements based on repeat.)
- The purchase order must clearly indicate the requirement of California Technical Bulletin 133
- If laboratory California Technical Bulletin 133 certification is required, the cost of testing a chair is \$820 NET, plus the cost of the chair and covering material.
- An additional lead time of 4 to 6 weeks is required for testing for CAL133.
- Once testing is completed, we will provide a certification letter specific to the sample tested for CAL133.
- DARRAN's manufacturing procedures for California TB 133 compliance are based on the testing of representative style with specific fabrics. Please contact Customer Service for an updated list of tested models.
- A copy of test certification is available upon request.W

Spire seating fabric & leather program

Combination fabrics

DARRAN is pleased to offer customers the design freedom of combination fabrics. When using fabric, vinyl or leather combinations, pricing will be as follows:

- When combining two materials of the same grade, pricing will be specified grade + 5%.
- If combining two materials of different grades or leather/ fabric combination, use the highest grade/price + 5%.
- If using COM or COL, pricing will be COM or COL + 5%. If both COM + COL are used in combination, use COL + 5%

COM/COL ordering instructions

Please complete the COM Submission Form prior to ordering the fabric from the supplier. All COM fabrics must be approved prior to order submission. Please refer to our website or contact DARRAN Seating Customer Service for an updated list of preapproved COM fabrics. Application instructions must be specified on the purchase order or COM/COL submission form. In the absence of application instructions, DARRAN will apply materials in the best manner and cannot be held responsible for tailoring or application objections after upholstering. COM orders will be scheduled for production after receipt of the material. Packages must be clearly marked and the fabric must be first quality, continuous yardage.

COM/COL yardage requirements

The yardage requirements stated in this price list for each style are calculated using 54" wide, non-directional fabrics. For fabrics with a different width or for patterns with repeats, please refer to the below chart to calculate the additional percent of fabric required:

Fabric Width	Plain Fabric	2" - 14" Repeat	15" - 19" Repeat	20" - 27" Repeat	28" - 36" Repeat
54"	0	15%	20%	25%	30%
53"	6%	19%	24%	28%	36%
52"	13%	23%	28%	33%	38%
51"	19%	26%	31%	36%	41%
50"	25%	30%	35%	40%	45%
49"	30%	35%	40%	45%	50%
48"	35%	40%	45%	50%	55%
47"	45%	50%	55%	58%	65%

Spire seating fabric & leather program

NOTE: Prior To Completion Of This Form, Please Refer To Our Graded In Materials Program For Preapproved Fabrics/Leathers.

COM/COL Approval

DARRAN Furniture Industries
 2402 Shore Street, High Point, NC 27263
 ATTN: Seating Division / COM/COL Approval
 TAG: DARRAN Purchase Order Number

Shipping approved COM/COL materials

DARRAN Furniture Industries
 2402 Shore Street, High Point, NC 27263
 ATTN: Seating Division / COM/COL Approval
 TAG: DARRAN Purchase Order Number

Please complete this form, attach a 6"x 6" sample and mail to the COM/COL APPROVAL address shown above.
 This form can also be downloaded from our website at www.darran.com/leathers OR www.darran.com/fabrics

Purchase Order # _____
 Dealer's Name _____
 Contact _____
 Address _____
 Telephone _____
 Email _____
 Chair Style _____
 Manufacturer _____
 Pattern Name _____
 Pattern Color _____
 Content _____
 Repeat _____

Please specify any special requirements and check the application above.

ATTACH 6" X 6" FABRIC/LEATHER SAMPLE HERE

NOTE

Actual Fabric/Leather samples needed instead of digital images. If digital images are sent in lieu of samples, DARRAN will only verify the pattern and will not take responsibility for color variances that cannot be verified due to printing restrictions

In the absence of application instructions, DARRAN will apply the material in the best manner and cannot be held responsible for tailoring or application objections after upholstery.

Unless otherwise instructed on the purchase order, excess COM materials will be recycled at the discretion of DARRAN after six months of the original product ship date.

The COM approval solely pertains to the application of the fabric onto the specified DARRAN seating product. DARRAN's approval or acceptance does not constitute any responsibility or warranty to the overall appearance, durability, flammability, defects, dye lot variations or colorfastness of the COM. It is the customer's responsibility to ensure the COM meets CAL 117 compliance and are first quality continuous goods.

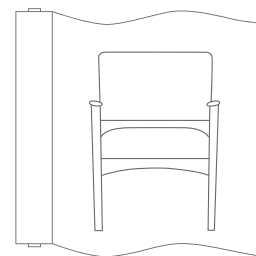

RAILROAD

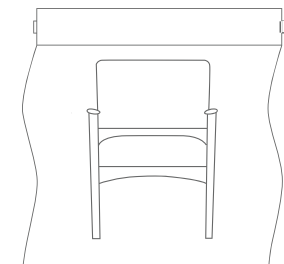

SETUP

Spire seating finishes

Solid Ash Frame Finishes

WLA Lofty Ash
WEC Ebony
WAM Alabaster Maple
WBO Blush Oak
WMO Mocha Oak
WNO Natural Oak
WSO Salted Oak
TBCO Baby's Cheek
TBSW Brown Sugar
TOBW Organic Brown
TSTV Studio Teak
SSM Seattle Mist Paint
SSL Skyline Walnut Paint
WWP Designer White Paint

Solid Walnut Frame Finishes

WOW Clear Walnut
WEW Executive Walnut
WGW Gunstock Walnut
WBW Henna Walnut
WSW Smokey Walnut
WNW Natural Walnut

Send 3x3 or larger finish chip for color match. Custom finish upcharge is 3% or \$250 Net (whichever is greater).

Finish

ENVI-CT Green Certified European Technology Coatings Finish.

Spire seating specification

Seat cushions are made of high resiliency foam with proper density to give comfort and support.

Seat rails are reinforced with hardwood corner blocks and cleats attached with glue and wood screws.

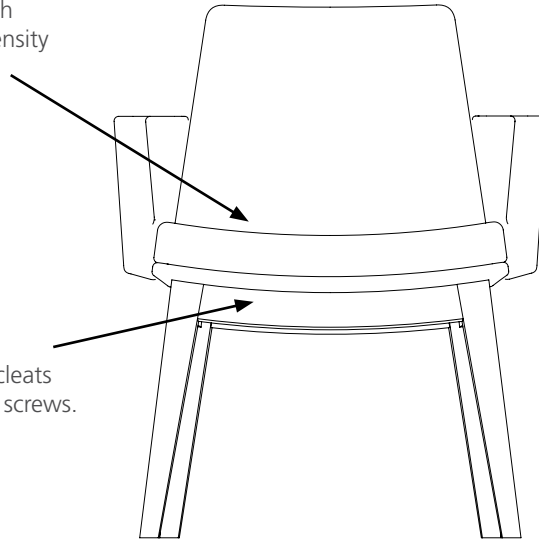

Frame is constructed of kiln-dried solid Ash or Walnut, perpetuating premium quality and durability.

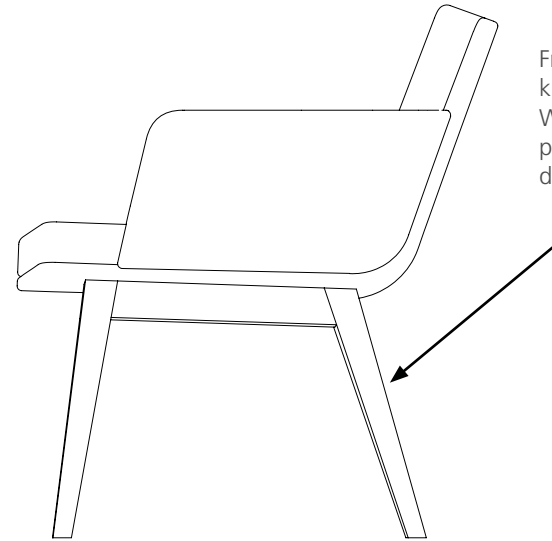

Variety of textiles and back options offer customers flexibility in design and consistency within each office setting.

Spire desks and workstations finishes

STANDARD VENEER	PREMIUM VENEER	HIGH PRESSURE LAMINATE	THERMALLY FUSED LAMINATE
WLA Lofty Ash.....	N/A.....	N/A.....	N/A
WEC Ebony.....	N/A.....	GEC Ebony.....	MEC Ebony
WAM Alabaster Maple.....	N/A.....	GAM Alabaster Maple.....	N/A
N/A.....	WOW Clear Walnut.....	N/A.....	N/A
WEW Executive Walnut.....	N/A.....	GEW Executive Walnut.....	N/A
WGW Gunstock Walnut.....	N/A.....	N/A.....	MGW Gunstock Walnut
WBW Henna Walnut.....	N/A.....	N/A.....	N/A
WSW Smokey Walnut.....	N/A.....	N/A.....	N/A
WNW Natural Walnut.....	N/A.....	GNW Natural Walnut.....	N/A
N/A.....	WBO Blush Oak.....	N/A.....	N/A
N/A.....	WMO Mocha Oak.....	N/A.....	N/A
N/A.....	WNO Natural Oak.....	N/A.....	N/A
N/A.....	WSO Salted Oak.....	N/A.....	N/A
N/A.....	TBCO Baby's Cheek.....	N/A.....	N/A
N/A.....	TBSW Brown Sugar.....	N/A.....	N/A
N/A.....	TOBW Organic Brown.....	N/A.....	N/A
N/A.....	TSTV Studio Teak Walnut.....	GSTV Studio Teak Walnut +10%.....	MTW Studio Teak Walnut
N/A.....	TSMV Seattle Mist Walnut.....	N/A.....	N/A
N/A.....	TSLV Skyline Walnut.....	GSLV Skyline Walnut +10%.....	MSW Skyline Walnut
WWP Designer White Paint.....	N/A.....	GWL Designer White.....	MWL Designer White

Send 3x3 or larger finish chip for color match. Custom finish upcharge is 3% or \$250 Net (whichever is greater).

Finish



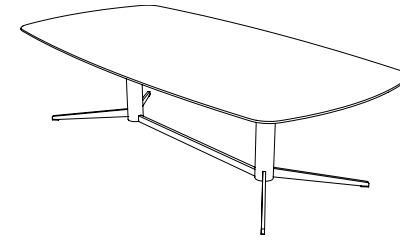

ENVI-CT Green Certified European Technology Coatings Finish.

Spire.

Occasional Table
Y Blade Base Occasional Table



[View statement of line](#)

1 Select a model w" x d" x h"	weight	Standard Veneer Top		Premium Veneer Top		High Pressure Laminate Top		Thermally Fused Laminate Top	
30" Depth									
60 x 30 x 16	90	SPI6030RE111W	1785	SPI6030RE111P	1964	SPI6030RE111G	1785	SPI6030RE111M	1350
72 x 30 x 16	100	SPI7230RE111W	1830	SPI7230RE111P	2013	SPI7230RE111G	1830	SPI7230RE111M	1448
36" Depth									
60 x 36 x 16	100	SPI6036RE111W	1865	SPI6036RE111P	2052	SPI6036RE111G	1865	SPI6036RE111M	1482
72 x 36 x 16	130	SPI7236RE111W	2008	SPI7236RE111P	2209	SPI7236RE111G	2008	SPI7236RE111M	1574
2 Select a finish View finish details									
		WEC		TBCO	WNO	GEC		MEC	
		WAM		TBSW	WSO	GAM		MGW	
		WEW		TSTV		GEW		MTW	
Metal finish		WGW		TSMV		GNW		MSW	
MFW White. Additional metal finishes are available, see options.		WBW		TSLV		GSTV		MWL	
		WSW		TOBW		GSLV			
		WNW		WBO		GWL			
		WWP		WOW					
		WLA		WMO					
3 Select an edge View edge details									
									
		Spire		Spire		Spire		Spire	
4 Select hardware View hardware details									
		Hardware		Hardware		Hardware		Hardware	
		N/A		N/A		N/A		N/A	

Product features.

- 1-5/16" Thick top
- ENVI-CT Finish on wood tops
- Hollow legs allow for concealed wire management
- Standard white blade metal base (optional black, silver)

Options.

POWER

- PDP01: Pepper (Power) - \$95 ea.
- PDS01: Salt (Powered USB) - \$225 ea.
- Installed directly above post

PREMIUM FINISH OPTION

- Base metal finish color - \$160 per base
- Specify MFB: Black, MFS: Silver

Spire.

Occasional Table
Blade Base Occasional Table



1 Select a model w" x d" x h"		weight	Standard Veneer Top	Premium Veneer Top	High Pressure Laminate Top	Thermally Fused Laminate Top
30" Square 30 x 30 x 16		50	SPI3030SQ111W 1368	SPI3030SQ111P 1505	SPI3030SQ111G 1368	SPI3030SQ111M 1024
36" Square 36 x 36 x 16		55	SPI3636SQ111W 1464	SPI3636SQ111P 1611	SPI3636SQ111G 1464	SPI3636SQ111M 1087
42" Square 42 x 42 x 16		60	SPI4242SQ111W 1608	SPI4242SQ111P 1769	SPI4242SQ111G 1608	SPI4242SQ111M 1178

2 Select a finish <i>View finish details</i>	3 Select a edge <i>View edge details</i>	4 Select hardware <i>View hardware details</i>
<p>WEC</p> <p>WAM</p> <p>WEW</p> <p>Metal finish MFW White. Additional metal finishes are available, see options.</p> <p>WGW</p> <p>WBW</p> <p>WSW</p> <p>WNW</p> <p>WWP</p> <p>WLA</p>	<p>TBCO WNO</p> <p>TBSW WSO</p> <p>TSTV</p> <p>TSMV</p> <p>TSLV</p> <p>TOBW</p> <p>WBO</p> <p>WOW</p> <p>WMO</p>	<p>GEC</p> <p>GAM</p> <p>GEW</p> <p>GNW</p> <p>GSTV</p> <p>GSLV</p> <p>GWL</p>
<p>MEC</p> <p>MGW</p> <p>MTW</p> <p>MSW</p> <p>MWL</p>	<p>Spire</p>	<p>Hardware N/A</p>

[View statement of line](#)

Product features.

- 1-5/16" Thick top
- ENVI-CT Finish on wood tops
- Hollow legs allow for concealed wire management
- Standard white blade metal base (optional black, silver)

Options.

POWER

- PDP01: Pepper (Power) - \$95 ea.
- PDS01: Salt (Powered USB) - \$225 ea.
- Installed directly above post





PREMIUM FINISH OPTION

- Base metal finish color - \$160 per base
- Specify MFB: Black, MFS: Silver

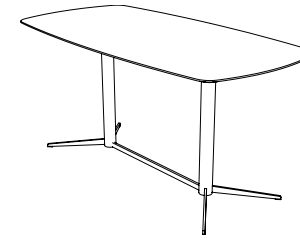
Spire.

Conference Table
Y Blade Base Work Table



1 Select a model w" x d" x h"		weight	Standard Veneer Top	Premium Veneer Top	High Pressure Laminate Top	Thermally Fused Laminate Top
30" Depth						
60 x 30 x 29		100	SPI6030RE121W 1871	SPI6030RE121P 2058	SPI6030RE121G 1871	SPI6030RE121M 1436
72 x 30 x 29		110	SPI7230RE121W 1917	SPI7230RE121P 2109	SPI7230RE121G 1917	SPI7230RE121M 1533
36" Depth						
60 x 36 x 29		110	SPI6036RE121W 1945	SPI6036RE121P 2140	SPI6036RE121G 1945	SPI6036RE121M 1562
72 x 36 x 29		140	SPI7236RE121W 2088	SPI7236RE121P 2297	SPI7236RE121G 2088	SPI7236RE121M 1654
84 x 36 x 29		150	SPI8436RE121W 2271	SPI8436RE121P 2498	SPI8436RE121G 2271	SPI8436RE121M 1773
2 Select a finish <i>View finish details</i>			WEC WAM WEW	TBCO WNO TBSW WSO	GEC GAM GEW GNW GSTV GSLV GWL	MEC MGW MTW MSW MWL
Metal finish MFW White. Additional metal finishes are available, see options.			WGW WBW WSW WNW WWP WLA	TSMV TSLV TOBW WBO WOW WMO		
3 Select an edge <i>View edge details</i>						
4 Select hardware <i>View hardware details</i>			Hardware N/A	Hardware N/A	Hardware N/A	Hardware N/A

View statement of line

Product features.

- 1-5/16" Thick top
- ENVI-CT Finish on wood tops
- Hollow legs allow for concealed wire management
- Standard white blade metal base (optional black, silver)

Options.

POWER

- PDP01: Pepper (Power) - \$95 ea.
- PDS01: Salt (Powered USB) - \$225 ea.
- Installed directly above post

PREMIUM FINISH OPTION

- Base metal finish color - \$160 per base
- Specify MFB: Black, MFS: Silver





Spire.

Conference Table
Blade Base Work Table



[View statement of line](#)

1 Select a model w" x d" x h"	weight	Standard Veneer Top	Premium Veneer Top	High Pressure Laminate Top	Thermally Fused Laminate Top
30" Square 30 x 30 x 29	55	SPI3030SQ121W 1413	SPI3030SQ121P 1555	SPI3030SQ121G 1413	SPI3030SQ121M 1070
36" Square 36 x 36 x 29	60	SPI3636SQ121W 1510	SPI3636SQ121P 1661	SPI3636SQ121G 1510	SPI3636SQ121M 1133
42" Square 42 x 42 x 29	65	SPI4242SQ121W 1654	SPI4242SQ121P 1820	SPI4242SQ121G 1654	SPI4242SQ121M 1224

2 Select a finish View finish details	3 Select a edge View edge details	4 Select hardware View hardware details
WEC WAM WEW Metal finish MFW White. Additional metal finishes are available, see options. WGW WBW WSW WNW WWP WLA	 Spire  Spire  Spire  Spire	Hardware N/A Hardware N/A Hardware N/A Hardware N/A

Product features.

- 1-5/16" Thick top
- ENVI-CT Finish on wood tops
- Hollow legs allow for concealed wire management
- Standard white blade metal base (optional black, silver)

Options.

POWER

- PDP01: Pepper (Power) - \$95 ea.
- PDS01: Salt (Powered USB) - \$225 ea.
- Installed directly above post





PREMIUM FINISH OPTION

- Base metal finish color - \$160 per base
- Specify MFB: Black, MFS: Silver

Spire.

Conference Table
Y Blade Base Bar Table



1 Select a model w" x d" x h"		weight	Standard Veneer Top	Premium Veneer Top	High Pressure Laminate Top	Thermally Fused Laminate Top
30" Depth						
60 x 30 x 42		110	SPI6030RE141W 1951	SPI6030RE141P 2146	SPI6030RE141G 1951	SPI6030RE141M 1516
72 x 30 x 42		120	SPI7230RE141W 2002	SPI7230RE141P 2202	SPI7230RE141G 2002	SPI7230RE141M 1619
36" Depth						
60 x 36 x 42		120	SPI6036RE141W 2025	SPI6036RE141P 2228	SPI6036RE141G 2025	SPI6036RE141M 1642
72 x 36 x 42		150	SPI7236RE141W 2168	SPI7236RE141P 2385	SPI7236RE141G 2168	SPI7236RE141M 1734
84 x 36 x 42		160	SPI8436RE141W 2351	SPI8436RE141P 2586	SPI8436RE141G 2351	SPI8436RE141M 1853
2 Select a finish <i>View finish details</i>			WEC WAM WEW	TBCO WNO TBSW WSO	GEC GAM GEW GNW GSTV GSLV GWL	MEC MGW MTW MSW MWL
Metal finish MFW White. Additional metal finishes are available, see options.			WGW WBW WSW WNW WWP WLA	TSMV TSLV TOBW WBO WOW WMO		
3 Select an edge <i>View edge details</i>						
4 Select hardware <i>View hardware details</i>			Hardware N/A	Hardware N/A	Hardware N/A	Hardware N/A

View statement of line

Product features.

- 1-5/16" Thick top
- ENVI-CT Finish on wood tops
- Hollow legs allow for concealed wire management
- Standard white blade metal base (optional black, silver)

Options.

POWER

- PDP01: Pepper (Power) - \$95 ea.
- PDS01: Salt (Powered USB) - \$225 ea.
- Installed directly above post

PREMIUM FINISH OPTION

- Base metal finish color - \$160 per base
- Specify MFB: Black, MFS: Silver

Spire.





Conference Table
Blade Base Bar Table



[View statement of line](#)

1 Select a model w" x d" x h"	weight	Standard Veneer Top	Premium Veneer Top	High Pressure Laminate Top	Thermally Fused Laminate Top
30" Square 30 x 30 x 42	60	SPI3030SQ141W 1459	SPI3030SQ141P 1605	SPI3030SQ141G 1459	SPI3030SQ141M 1116
36" Square 36 x 36 x 42	65	SPI3636SQ141W 1556	SPI3636SQ141P 1712	SPI3636SQ141G 1556	SPI3636SQ141M 1178
42" Square 42 x 42 x 42	70	SPI4242SQ141W 1699	SPI4242SQ141P 1869	SPI4242SQ141G 1699	SPI4242SQ141M 1270

2 Select a finish View finish details					
Metal finish MFW White. Additional metal finishes are available, see options.	WEC WAM WEW WGW WBW WSW WNW WWP WLA	TBCO TBSW TSTV TSMV TSLV TOBW WBO WOW WMO	WNO WSO	GEC GAM GEW GNW GSTV GSLV GWL	MEC MGW MTW MSW MWL

3 Select an edge View edge details					
	Spire		Spire		

4 Select hardware View hardware details				
Hardware N/A	Hardware N/A	Hardware N/A	Hardware N/A	Hardware N/A

Product features.

- 1-5/16" Thick top
- ENVI-CT Finish on wood tops
- Hollow legs allow for concealed wire management
- Standard white blade metal base (optional black, silver)

Options.

POWER

- PDP01: Pepper (Power) - \$95 ea.
- PDS01: Salt (Powered USB) - \$225 ea.
- Installed directly above post

PREMIUM FINISH OPTION

- Base metal finish color - \$160 per base
- Specify MFB: Black, MFS: Silver

Spire.

Barstool
Wood Base Barstool

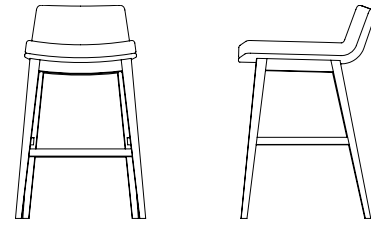

[View statement of line](#)

1 model	COM	COL	1	2	3	4	5	6	7	8	9	10	11/L1	12	13/L2
SPI2332WFS38	1166	1247	1241	1278	1315	1352	1389	1426	1463	1500	1537	1574	1611	1648	1722
W x D x H 22.5 x 22 x 36.5 Arm Height: n/a Seat Height: 30" Inside Seat Depth: 16" Inside Seat Width: 19"			Upholstery Requirements Fabric yds: 2 Leather Sq. Ft.: 36 Carton Weight: 35												

2 Select a finish

[View finish details](#)

- WLA Lofty Ash
- WEC Ebony
- WAM Alabaster Maple
- WBO Blush Oak
- WMO Mocha Oak
- WNO Natural Oak
- WSO Salted Oak
- WOW Clear Walnut
- WEW Executive Walnut
- WGW Gunstock Walnut
- WBW Henna Walnut
- WSW Smokey Walnut
- WNW Natural Walnut
- TBCO Baby's Cheek
- TBSW Brown Sugar
- TSTV Studio Teak Walnut
- SSM Seattle Mist Paint
- SSL Skyline Walnut Paint
- TOBW Organic Brown
- WWP Designer White Paint

3 Combination Fabrics

[View finish details](#)

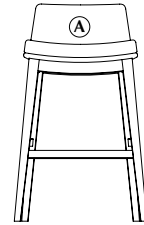

Front View

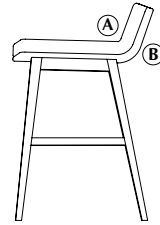

Side View

DARRAN is pleased to offer customers the design freedom of combination fabrics. When using fabric, vinyl or leather combinations, pricing/yardage requirements will be as follows:

- A** Inside Seat 1 yd(s).
- B** Outside Back 1 yd(s).

- When combining two materials of the same grade, pricing will be specified grade + 5%
- If combining two materials of different grades or leather/fabric combination, use the highest grade/price + 5%
- If using COM or COL, pricing will be COM or COL + 5%.
- If both COM + COL are used in combination, use COL + 5%.

Spire.

Guest Chair Wood Base Guest Chair

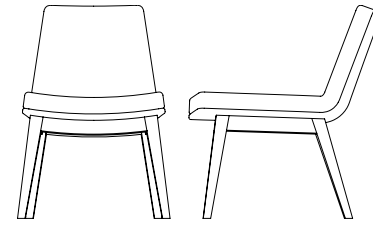

View statement of line

1 model	COM	COL	1	2	3	4	5	6	7	8	9	10	11/L1	12	13/L2
SPI2332WFC24	1053	1134	1136	1177	1218	1259	1300	1341	1382	1423	1464	1505	1546	1587	1669
W x D x H 20.5 x 26 x 29			Upholstery Requirements												
Arm Height: n/a			Fabric yds: 2.25 Leather Sq. Ft.: 40.5												
Seat Height: 17"			Carton Weight: 25												
Inside Seat Depth: 18"															
Inside Seat Width: 19"															

2 Select a finish *View finish details*

- WLA Lofty Ash
- WEC Ebony
- WAM Alabaster Maple
- WBO Blush Oak
- WMO Mocha Oak
- WNO Natural Oak
- WSO Salted Oak
- WOW Clear Walnut
- WEW Executive Walnut
- WGW Gunstock Walnut
- WBW Henna Walnut
- WSW Smokey Walnut
- WNW Natural Walnut
- TBCO Baby's Cheek
- TBSW Brown Sugar
- TSTV Studio Teak Walnut
- SSM Seattle Mist Paint
- SSL Skyline Walnut Paint
- TOBW Organic Brown
- WWP Designer White Paint

3 Combination Fabrics *View finish details*

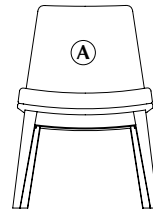

Front View

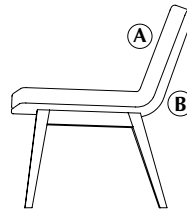

Side View

DARRAN is pleased to offer customers the design freedom of combination fabrics. When using fabric, vinyl or leather combinations, pricing/yardage requirements will be as follows:

- A Inside Seat 1.25 yd(s).**
- B Outside Back 1 yd(s).**

- When combining two materials of the same grade, pricing will be specified grade + 5%
- If combining two materials of different grades or leather/fabric combination, use the highest grade/price + 5%
- If using COM or COL, pricing will be COM or COL + 5%.
- If both COM + COL are used in combination, use COL + 5%.

Spire.

Guest Chair Wood Base Guest Chair W/ Arms

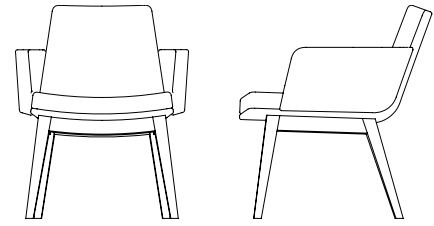

[View statement of line](#)

1 model	COM	COL	1	2	3	4	5	6	7	8	9	10	11/L1	12	13/L2
SPI2332WFC25	1312	1416	1423	1478	1533	1588	1643	1698	1753	1808	1863	1918	1973	2028	2138
W x D x H 24.5 x 26 x 29	Upholstery Requirements														
Arm Height: 23.5"	Fabric yds: 3 Leather Sq. Ft.: 54														
Seat Height: 17"	Carton Weight: 30														
Inside Seat Depth: 18"															
Inside Seat Width: 19"															

2 Select a finish [View finish details](#)

- WLA Lofty Ash
- WEC Ebony
- WAM Alabaster Maple
- WBO Blush Oak
- WMO Mocha Oak
- WNO Natural Oak
- WSO Salted Oak
- WOW Clear Walnut
- WEW Executive Walnut
- WGW Gunstock Walnut
- WBW Henna Walnut
- WSW Smokey Walnut
- WNW Natural Walnut
- TBCO Baby's Cheek
- TBSW Brown Sugar
- TSTV Studio Teak Walnut
- SSM Seattle Mist Paint
- SSL Skyline Walnut Paint
- TOBW Organic Brown
- WWP Designer White Paint

3 Combination Fabrics [View finish details](#)

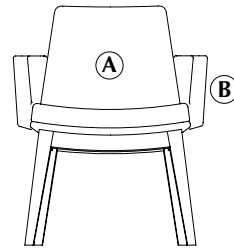

Front View

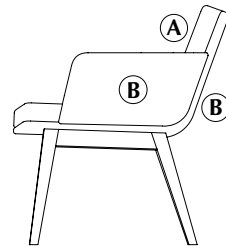

Side View

DARRAN is pleased to offer customers the design freedom of combination fabrics. When using fabric, vinyl or leather combinations, pricing/yardage requirements will be as follows:

- A** Inside Seat 2 yd(s).
- B** Outside Back and Arms 1 yd(s).

- When combining two materials of the same grade, pricing will be specified grade + 5%
- If combining two materials of different grades or leather/fabric combination, use the highest grade/price + 5%
- If using COM or COL, pricing will be COM or COL + 5%.
- If both COM + COL are used in combination, use COL + 5%.

Spire.

Lounge Chair Wood Base Lounge Chair

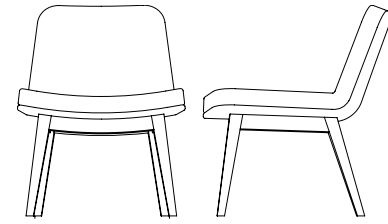

View statement of line

1 model	COM	COL	1	2	3	4	5	6	7	8	9	10	11/L1	12	13/L2
SPI2332WFL24	1055	1136	1148	1194	1240	1286	1332	1378	1424	1470	1516	1562	1608	1654	1746
W x D x H 22.5 x 26 x 29	Upholstery Requirements														
Arm Height: n/a	Fabric yds: 2.5 Leather Sq. Ft.: 45														
Seat Height: 17"	Carton Weight: 25														
Inside Seat Depth: 18"															
Inside Seat Width: 22.5															

2 Select a finish *View finish details*

- WLA Lofty Ash
- WEC Ebony
- WAM Alabaster Maple
- WBO Blush Oak
- WMO Mocha Oak
- WNO Natural Oak
- WSO Salted Oak
- WOW Clear Walnut
- WEW Executive Walnut
- WGW Gunstock Walnut
- WBW Henna Walnut
- WSW Smokey Walnut
- WNW Natural Walnut
- TBCO Baby's Cheek
- TBSW Brown Sugar
- TSTV Studio Teak Walnut
- SSM Seattle Mist Paint
- SSL Skyline Walnut Paint
- TOBW Organic Brown
- WWP Designer White Paint

3 Combination Fabrics *View finish details*

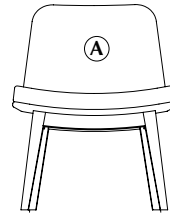

Front View

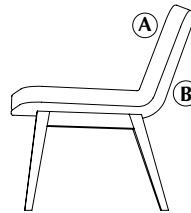

Side View

DARRAN is pleased to offer customers the design freedom of combination fabrics. When using fabric, vinyl or leather combinations, pricing/yardage requirements will be as follows:

- A Inside Seat** 1.25 yd(s).
- B Outside Back** 1.25 yd(s).

- When combining two materials of the same grade, pricing will be specified grade + 5%
- If combining two materials of different grades or leather/fabric combination, use the highest grade/price + 5%
- If using COM or COL, pricing will be COM or COL + 5%.
- If both COM + COL are used in combination, use COL + 5%.

Product features.

- Seat and back utilizes high density ultra cell cushioning that conforms to individual's lumbar curvatures for adaptive support
- Upholstered seat and back
- Hardwood base to maximize strength and longevity

Spire.

Lounge Chair
Wood Base Lounge Chair W/ Arms

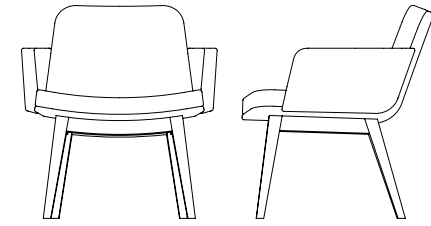

[View statement of line](#)

1 model	COM	COL	1	2	3	4	5	6	7	8	9	10	11/L1	12	13/L2
SPI2332WFL25	1317	1421	1447	1511	1575	1639	1703	1767	1831	1895	1959	2023	2087	2151	2279
W x D x H 26.5 x 26 x 29 Arm Height: 23.5" Seat Height: 18" Inside Seat Depth: 18" Inside Seat Width: 22.5			Upholstery Requirements Fabric yds: 3.5 Leather Sq. Ft.: 63 Carton Weight: 30												

2 Select a finish

[View finish details](#)

- WLA Lofty Ash
- WEC Ebony
- WAM Alabaster Maple
- WBO Blush Oak
- WMO Mocha Oak
- WNO Natural Oak
- WSO Salted Oak
- WOW Clear Walnut
- WEW Executive Walnut
- WGW Gunstock Walnut
- WBW Henna Walnut
- WSW Smokey Walnut
- WNW Natural Walnut
- TBCO Baby's Cheek
- TBSW Brown Sugar
- TSTV Studio Teak Walnut
- SSM Seattle Mist Paint
- SSL Skyline Walnut Paint
- TOBW Organic Brown
- WWP Designer White Paint

3 Combination Fabrics

[View finish details](#)

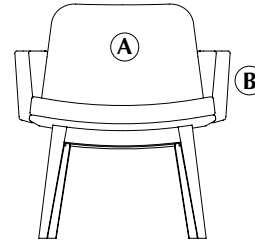

Front View

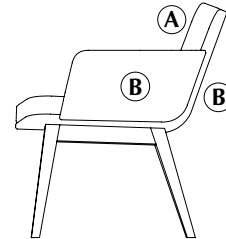

Side View

DARRAN is pleased to offer customers the design freedom of combination fabrics. When using fabric, vinyl or leather combinations, pricing/yardage requirements will be as follows:

- A Inside Seat 2.25 yd(s).
- B Outside Back and Arms 1.25 yd(s).

- When combining two materials of the same grade, pricing will be specified grade + 5%
- If combining two materials of different grades or leather/fabric combination, use the highest grade/price + 5%
- If using COM or COL, pricing will be COM or COL + 5%.
- If both COM + COL are used in combination, use COL + 5%.

Product features.

- Seat and back utilizes high density ultra cell cushioning that conforms to individual's lumbar curvatures for adaptive support
- Upholstered seat, back and arms
- Hardwood base to maximize strength and longevity

Spire.

Guest Chair
Swivel Blade Base Guest Chair

1 model	COM	COL	1	2	3	4	5	6	7	8	9	10	11/L1	12	13/L2
SPI2332NSC26	1255	1336	1338	1379	1420	1461	1502	1543	1584	1625	1666	1707	1748	1789	1871
W x D x H			Upholstery Requirements												
20.5 x 26 x 29			Fabric yds: 2.25 Leather Sq. Ft.: 40.5												
Arm Height: n/a			Carton Weight: 25												
Seat Height: 18"															
Inside Seat Depth: 18"															
Inside Seat Width: 19"															

2 Select a finish

[View finish details](#)

Metal finish
MFW White. Additional metal finishes are available, see options.

3 Combination Fabrics

[View finish details](#)

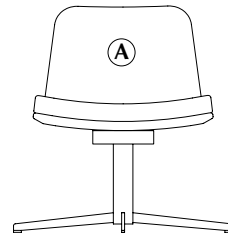

Front View

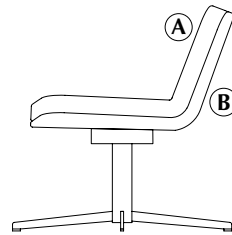

Side View

DARRAN is pleased to offer customers the design freedom of combination fabrics. When using fabric, vinyl or leather combinations, pricing/yardage requirements will be as follows:

A Inside Seat 1.25 yd(s).
B Outside Back 1 yd(s).

- When combining two materials of the same grade, pricing will be specified grade + 5%
- If combining two materials of different grades or leather/fabric combination, use the highest grade/price + 5%
- If using COM or COL, pricing will be COM or COL + 5%.
- If both COM + COL are used in combination, use COL + 5%.

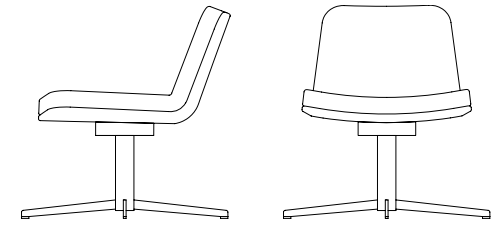

[View statement of line](#)

Product features.

- Seat and back utilizes high density ultra cell cushioning that conforms to individual's lumbar curvatures for adaptive support
- Upholstered seat and back
- Carbon steel powdercoated base with a memory swivel
- Standard white blade metal base (optional black, silver)

Options.

PREMIUM FINISH OPTION

- Specify base metal finish color - \$160 per base
- MFB: Black, MFS: Silver

Spire.

Guest Chair
Swivel Blade Base Guest Chair W/ Arms

1 model	COM	COL	1	2	3	4	5	6	7	8	9	10	11/L1	12	13/L2
SPI2332ASC27	1570	1674	1681	1736	1791	1846	1901	1956	2011	2066	2121	2176	2231	2286	2396
W x D x H			Upholstery Requirements												
24.5 x 26 x 29			Fabric yds: 3 Leather Sq. Ft.: 54												
Arm Height: 23.5"			Carton Weight: 30												
Seat Height: 18"															
Inside Seat Depth: 18"															
Inside Seat Width: 19"															

2 Select a finish

[View finish details](#)

Metal finish
MFW White. Additional metal finishes are available, see options.

3 Combination Fabrics

[View finish details](#)

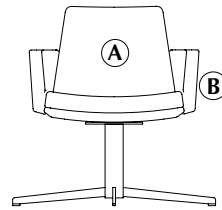

Front View

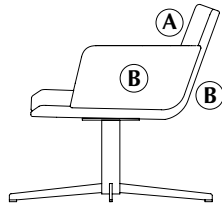

Side View

DARRAN is pleased to offer customers the design freedom of combination fabrics. When using fabric, vinyl or leather combinations, pricing/yardage requirements will be as follows:

A Inside Seat 2 yd(s).
B Outside Back and Arms 1 yd(s).

- When combining two materials of the same grade, pricing will be specified grade + 5%
- If combining two materials of different grades or leather/fabric combination, use the highest grade/price + 5%
- If using COM or COL, pricing will be COM or COL + 5%.
- If both COM + COL are used in combination, use COL + 5%.

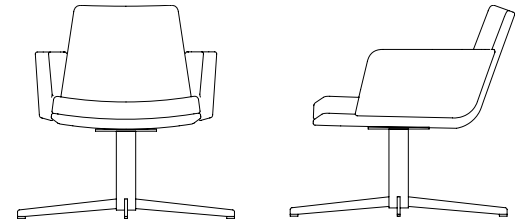

[View statement of line](#)

Product features.

- Seat and back utilizes high density ultra cell cushioning that conforms to individual's lumbar curvatures for adaptive support
- Upholstered seat, back and arms
- Carbon steel powdercoated base with a memory swivel
- Standard white blade metal base (optional black, silver)

Options.

PREMIUM FINISH OPTION

- Specify base metal finish color - \$150 per base
- MFB: Black, MFS: Silver

Spire.

Lounge Chair
Swivel Blade Base Lounge Chair

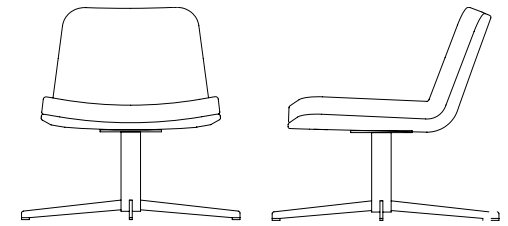

View statement of line

1 model	COM	COL	1	2	3	4	5	6	7	8	9	10	11/L1	12	13/L2
SPI2332NSL26	1264	1345	1375	1430	1485	1540	1595	1650	1705	1760	1815	1870	1925	1980	2090
W x D x H 22.5 x 26 x 29			Upholstery Requirements												
Arm Height: n/a			Fabric yds: 3 Leather Sq. Ft.: 54												
Seat Height: 18"			Carton Weight: 25												
Inside Seat Depth: 18"															
Inside Seat Width: 22.5"															

2 Select a finish

[View finish details](#)

Metal finish
MFW White. Additional metal finishes are available, see options.

3 Combination Fabrics

[View finish details](#)

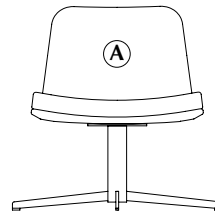

Front View

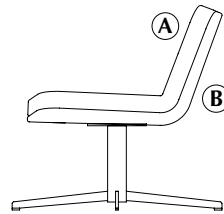

Side View

DARRAN is pleased to offer customers the design freedom of combination fabrics. When using fabric, vinyl or leather combinations, pricing/yardage requirements will be as follows:

A Inside Seat 2 yd(s).s
B Outside Back 1 yd(s).s

- When combining two materials of the same grade, pricing will be specified grade + 5%
- If combining two materials of different grades or leather/fabric combination, use the highest grade/price + 5%
- If using COM or COL, pricing will be COM or COL + 5%.
- If both COM + COL are used in combination, use COL + 5%.

Product features.

- Seat and back utilizes high density ultra cell cushioning that conforms to individual's lumbar curvatures for adaptive support
- Upholstered seat and back
- Carbon steel powdercoated base with a memory swivel
- Standard white blade metal base (optional black, silver)

Options.

PREMIUM FINISH OPTION

- Specify base metal finish color - \$160 per base
- MFB: Black, MFS: Silver

Spire.

Lounge Chair Swivel Blade Base Lounge Chair W/ Arms

1 model	COM	COL	1	2	3	4	5	6	7	8	9	10	11/L1	12	13/L2
SPI2332ASL27	1575	1679	1705	1769	1833	1897	1961	2025	2089	2153	2217	2281	2345	2409	2537
W x D x H 26.5 x 26 x 29 Arm Height: 23.5" Seat Height: 18" Inside Seat Depth: 18" Inside Seat Width: 22.5	Upholstery Requirements Fabric yds: 3.5 Leather Sq. Ft.: 63 Carton Weight: 30														

2 Select a finish [View finish details](#)

Metal finish
MFW White. Additional metal finishes are available, see options.

3 Combination Fabrics [View finish details](#)

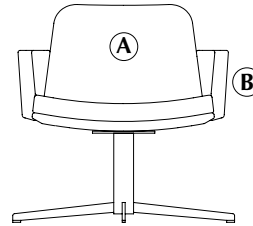

Front View

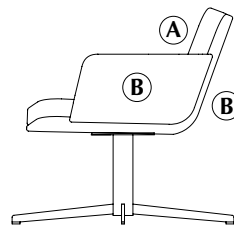

Side View

DARRAN is pleased to offer customers the design freedom of combination fabrics. When using fabric, vinyl or leather combinations, pricing/yardage requirements will be as follows:

A Inside Seat 2.25 yd(s).s
B Outside Back and Arms 1.25 yd(s).

- When combining two materials of the same grade, pricing will be specified grade + 5%
- If combining two materials of different grades or leather/fabric combination, use the highest grade/price + 5%
- If using COM or COL, pricing will be COM or COL + 5%.
- If both COM + COL are used in combination, use COL + 5%.

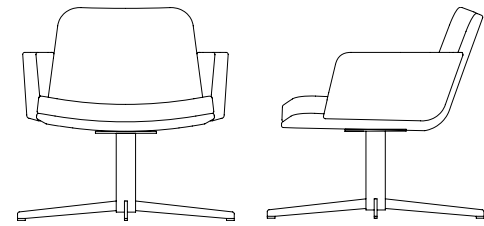

[View statement of line](#)

Product features.

- Seat and back utilizes high density ultra cell cushioning that conforms to individual's lumbar curvatures for adaptive support
- Upholstered seat, back and arms
- Carbon steel powdercoated base with a memory swivel
- Standard white blade metal base (optional black, silver)

Options.

PREMIUM FINISH OPTION

- Specify base metal finish color - \$160 per base
- MFB: Black, MFS: Silver

Spire.

Conference Lounge Chair Conference Chair

1 model	COM	COL	1	2	3	4	5	6	7	8	9	10	11/L1	12	13/L2
SPI2332NLC31	1285	1366	1378	1424	1470	1516	1562	1608	1654	1700	1746	1792	1838	1884	1976
W x D x H 27 x 26 x 31.5			Upholstery Requirements												
Arm Height: n/a			Fabric yds: 2.5 Leather Sq. Ft.: 45												
Seat Height: 19-22"			Carton Weight: 30												
Inside Seat Depth: 18"															
Inside Seat Width: 22.5"															

2 Select a finish [View finish details](#)

3 Combination Fabrics [View finish details](#)

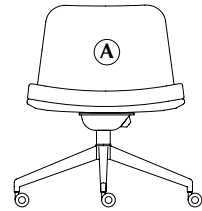

Front View

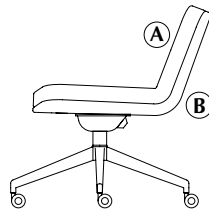

Side View

DARRAN is pleased to offer customers the design freedom of combination fabrics. When using fabric, vinyl or leather combinations, pricing/yardage requirements will be as follows:

A Inside Seat 1.25 yd(s).
B Outside Back 1.25 yd(s).

- When combining two materials of the same grade, pricing will be specified grade + 5%
- If combining two materials of different grades or leather/fabric combination, use the highest grade/price + 5%
- If using COM or COL, pricing will be COM or COL + 5%.
- If both COM + COL are used in combination, use COL + 5%.

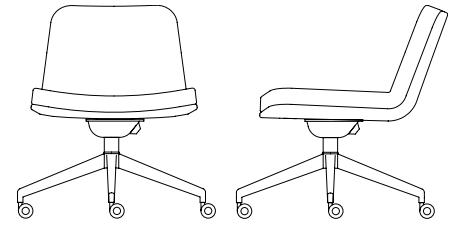

[View statement of line](#)

Product features.

- 26" diameter polished aluminum base
- Seat and back utilizes high density ultra cell cushioning that conforms to individual's lumbar curvatures for adaptive support
- Knee Tilt Swivel w/ forward pivot point
- Large 60mm diameter casters are standard to promote increased mobility.
- Upholstered seat, back and arms

Spire.

Conference Lounge Chair Conference Chair W/ Arms

1 model	COM	COL	1	2	3	4	5	6	7	8	9	10	11/L1	12	13/L2
SPI2332ALC32	1598	1702	1728	1792	1856	1920	1984	2048	2112	2176	2240	2304	2368	2432	2560
W x D x H 24.5 x 26 x 29	Upholstery Requirements														
Arm Height:	Fabric yds: 3.5 Leather Sq. Ft.: 63														
Seat Height: 18-22"	Carton Weight: 30														
Inside Seat Depth: 18"															
Inside Seat Width: 22.5"															

2 Select a finish [View finish details](#)

3 Combination Fabrics [View finish details](#)

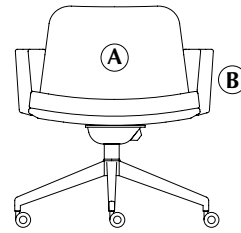

Front View

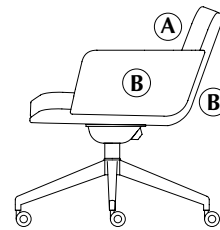

Side View

DARRAN is pleased to offer customers the design freedom of combination fabrics. When using fabric, vinyl or leather combinations, pricing/yardage requirements will be as follows:

- A Inside Seat 2.25 yd(s).
- B Outside Back and Arms 1.25 yd(s).

- When combining two materials of the same grade, pricing will be specified grade + 5%
- If combining two materials of different grades or leather/fabric combination, use the highest grade/price + 5%
- If using COM or COL, pricing will be COM or COL + 5%.
- If both COM + COL are used in combination, use COL + 5%.

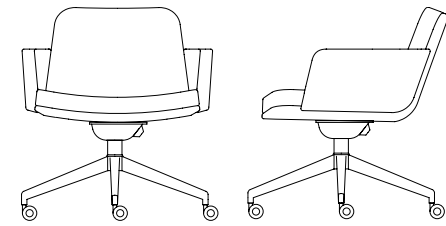

[View statement of line](#)

Product features.

- 26" diameter polished aluminum base
- Seat and back utilizes high density ultra cell cushioning that conforms to individual's lumbar curvatures for adaptive support
- Knee Tilt Swivel w/ forward pivot point
- Large 60mm diameter casters are standard to promote increased mobility.

power & data options.

Salt & pepper power ports

Style Number

List Price



PDP01 Pepper (power)

\$95

PDP01 Salt (powered USB)

\$225

Specifications

- › Pepper port includes 1 power plug
- › Salt port includes 2 power USB
- › Cord is 72" long
- › Spill-proof technology

Available: Boss, Spire



Pepper power pod



Salt powered USB



Thinking quietly price list

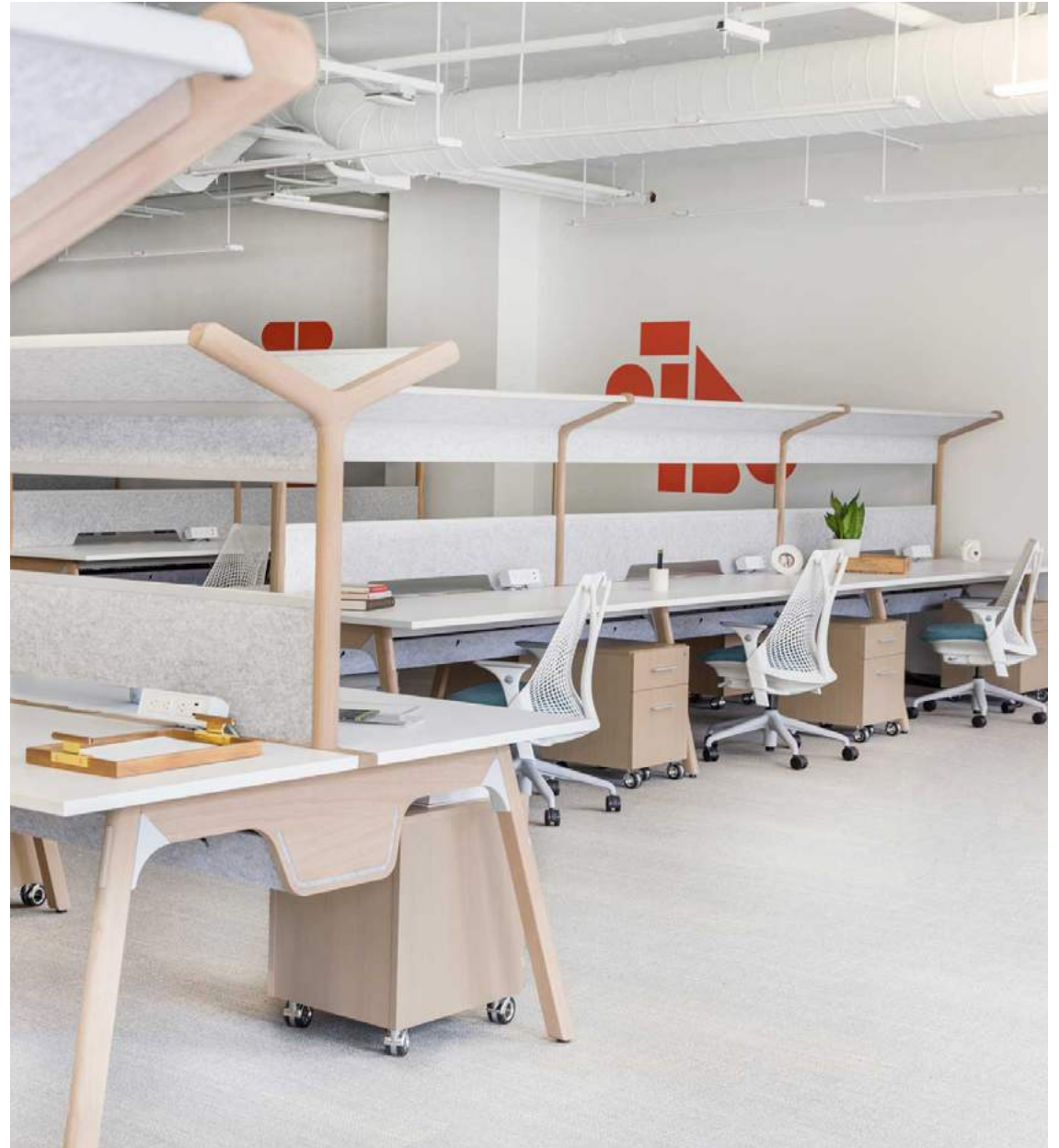

Thinking quietly table of contents

Statement of Line	
Features & Advantages	1
Finishes Specifications	3
Specifications.....	4
Workbay Dimensions Specifications	7
Edges Pulls Wire management.....	16
Workstation Infill Block System	17
Grommet Grommet Reference	19
Grain Direction	20
Drawer Dimensions Fiing Reference.....	21
Workstations with Umbrellas.....	22
Workstations	25
Full Pedestal Credenza	28
Pedestals.....	29
Screens	31
Breif Screen	36
Desk Pad.....	37
Terrarium	38
Workbay Typicals	39
Workbay Modulares	44
Cone	47
Round Conference Tables.....	49
Square Conference Tables	50
Conference Tables.....	51
Conference Credenza	56
Options.....	57
Power & Data	63

statement of line.



PAGE 22
Workstation With Umbrella

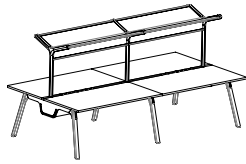

PAGE 23
Workstation With Umbrella



PAGE 24
Workstation With Umbrella



PAGE 25
Workstation

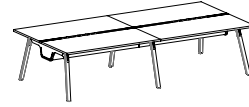

PAGE 26
Workstation



PAGE 27
Workstation

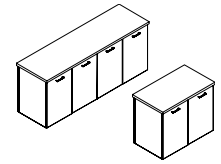

PAGE 28
Full Pedestal Credenzas

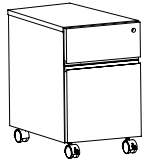

PAGE 29
Pedestals

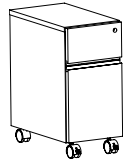

PAGE 30
Pedestals

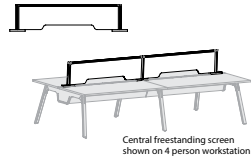

PAGE 31
Screens

Central freestanding screen shown on 4 person workstation

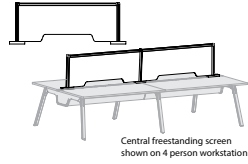

PAGE 32
Acrylic Screens

Central freestanding screen shown on 4 person workstation

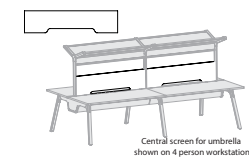

PAGE 33
Screens

Central screen for umbrella shown on 4 person workstation

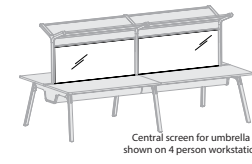

PAGE 34
Acrylic Screens

Central screen for umbrella shown on 4 person workstation

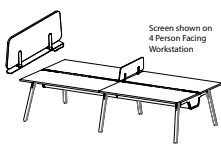

PAGE 35
Interpersonal Screen

Screen shown on 4 Person Facing Workstation

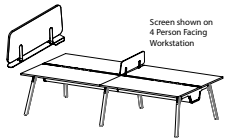

PAGE 36
Interpersonal Screen

Screen shown on 4 Person Facing Workstation

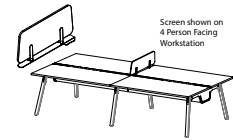

PAGE 37
Interpersonal Screen

Screen shown on 4 Person Facing Workstation

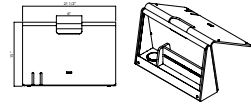

PAGE 38
Brief Screen

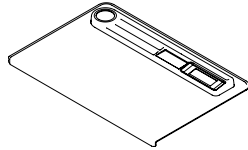

PAGE 39
Desk Pad

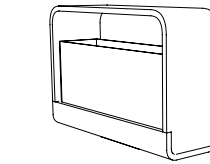

PAGE 40
Terrarium

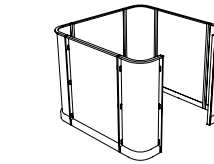

PAGE 41
Workbay Typical

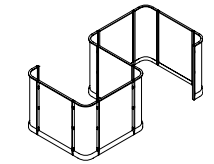

PAGE 42
Workbay Typical

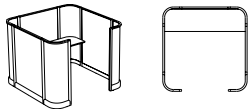

PAGE 43
Workbay Typical

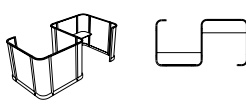

PAGE 44
Workbay Typical

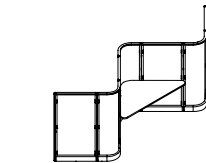

PAGE 45
Workbay Typical



PAGE 46
Workbay Modular

Outside Skirting OC918

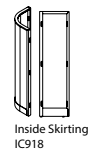

Inside Skirting IC918

PAGE 47
Workbay Modular



PAGE 48
Workbay Modular

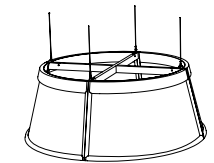

PAGE 49
Meeting Space

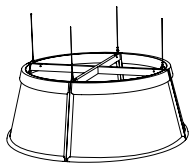

PAGE 50
Meeting Space



PAGE 51
Conference Tables

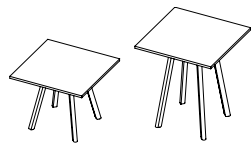

PAGE 52
Conference Tables



PAGE 53
Conference Tables

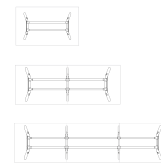

PAGE 54
Conference Tables

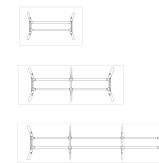

PAGE 55
Conference Tables



PAGE 56
Conference Tables

statement of line.



PAGE 57
Conference Tables

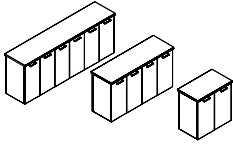

PAGE 58
Full Pedestal Credenzas

Thinking quietly features & advantages

Veneer

DARRAN only uses HPVA AA Grade Flat Cut Cherry and Maple, and AA Grade Quartered Oak Veneers. All veneers are selected and matched for balance and consistency.

Veneer tops

Thinking quietly veneer tops feature a 45-pound density substrate with balanced 3-ply construction. Tops are 1" thick on MDF core comprised of 100% recycled and recovered wood fibers. All veneer tops are slipmatched and feature a 3mm external solid hardwood band or profile edge.

Laminate tops

Laminate tops

Thinking quietly high-pressure laminate tops feature a 45-pound density substrate with balanced 3-ply construction. Tops are 1" thick on MDF core comprised of 100% recycled and recovered wood fibers. All high pressure laminate tops are available with a profile edge, laminate self-edge or 2mm PVC edge band. Laminates in wood grain patterns feature a fine grain texture that features the polish and luxe of a real wood veneer with a subtle narrow grain structure.

TFL tops

Thermally Fused Laminate tops feature a 45-pound density substrate with balanced 3-ply construction. Tops are 1" thick on MDF core that is comprised of 100% recycled and recovered wood fibers. All Thermally Fused Laminate tops are available with a 2mm flat PVC band. Laminates in wood grain patterns feature Timberline Texture providing the grain pattern of wood.

Cleaning wood & laminate

In addition to regular dusting, give your furniture an occasional cleaning in accordance with our cleaning instructions. DARRAN wood and laminate products can be cleaned with a soft cloth and a mild soap and water mixture. Use approximately 32 oz of water mixed with one tablespoon of dish soap, always wiping with the grain. Dry with a soft cloth, going with the grain, to avoid spotting or streaking.

Wood products should be waxed periodically using a non-wax liquid; please do not use any waxy polish or cleaner. Interior of drawers may also be cleaned with mild soap and water mixture, or any household cleaner that is not petroleum or thinner-based.

Chassis & pedestal

Chassis components are ¾" thick core of particle board or MDF rated EPP/SCS/CARB-

II material with 3-ply balanced construction. Pedestal and Cabinets feature dowel construction reinforced with steel bracket plates, wood cleats, screws and glue. All units are standard with 1" adjustable glides that allow for leveling of units that are secured in solid wood glide blocks to prevent tearout.

Adjustable glides

Glides provide 1" of vertical leveling adjustment. Glide bottom is durable metal. Glides are secured in solid wood blocks that are screwed and glued for durability.

Drawers

All drawers are constructed with mitre joint/dowel construction in a natural maple finish with four sides and a bottom, which are attached to a drawer front with screws for easy removal. Drawer fronts are vertically matched in balanced sets. Pencil trays are standard in all box drawers. Drawers are constructed of 1/2" thick wood grained wrapped 5 sided miter-folded construction with 1/4" thick hardboard bottoms reinforced for heavy weight capacity. Drawers have been tested and pass BIFMA 50,000 cycle test. All drawers are guaranteed lifetime with free replacement warranty.

Drawer fronts

Drawer fronts are vertically matched in balanced sets.

Optional wood drawers

Optional hardwood veneer plywood drawers feature banded top and bottom edges for smoothness. Drawers are dowel joint construction with a UV cured finish over maple veneers, plus a lifetime free replacement guarantee. Optional Wood Drawer (Any Size) – Option Code

Suspensions

All casegoods utilize cold rolled steel zinc plated high-grade drawer suspensions. All suspensions are warranted for the lifetime of the product. Box and File drawers are full extension, featuring steel ball bearings for a smoother quieter range of motion and are rated 100lbs. Lateral file drawers are a progressive action full extension suspension and is rated at 150lbs. Veneer and High Pressure laminate casegoods feature soft close suspension. Thermally Fused Laminate casegoods feature standard suspensions. Lateral files include anti tip mechanism that allow only one drawer to be opened at a time.

Filing

Thinking quietly features a highly durable black plastic extrusion that is securely fastened into a route on top of the drawer to support hanging files. An adjustable crossbar is provided for all file drawers that enables legal/letter filing front to back or side-to-side based on the drawer size.

Thinking quietly features & advantages

Locks

Locks are Standard on all drawers below the worksurface. Random lock cores are installed at the factory. Some units may be shipped with the same key number. Locks are Silver, Black or Bronze and match pull finish unless otherwise specified.

DARRAN will also send lock cores separately to the dealer at your request. These units will be send with an empty lock core and the Dealer will receive a shipment of the requested lock core/keys.

Keying

Keying is available either factory or field installed. Factory installed keying is random.

Grommets

Metal grommets are provided to match the drawer pull selection. Grommet is available in black, silver or white. Must specify standard or non-standard location. Black plastic grommets are available as an option for vertical applications.

Wire management

Wire management capabilities include standard and optional worksurface grommets. Specify W21 under surface wire channels for organization and management of all communication wires and cords. Sold separately to conceal wire under worksurfaces.

Infill blocks

Wire management for worksurface clamp mount power is concealed by central infill blocks that drop wires to a cable management tray.

Cable trays

The cable tray is constructed of acoustical material concealing power and data, while reducing floor level noise.

Powerports

A large selection of power pods are available and handle power, data, docking stations and communication. See options section for selection.

LED tasklights

LED task lighting provides high efficiency, low energy lighting with a long life. Recessed light is encased in silver aluminum channel with milk lense and rounded end caps. Lights are factory installed. Product specifications listed below:

- Diffuser creates a softer light and eliminates hot spots
- Touch dimmer switch
- Can be "daisy chained" up to 90W
- 4.6 watts per foot
- 120 LEDs per meter
- Certification: UL Listed
- 50,000 hour life span.

Color Temp is 4000K

Thinking quietly finishes | specifications

STANDARD VENEER	PREMIUM VENEER	HIGH PRESSURE LAMINATE	THERMALLY FUSED LAMINATE
WEC Ebony on Cherry	N/A	GEC Ebony	MEC Ebony
WAM Alabaster Maple.....	N/A	GAM Alabaster Maple	N/A
WSO Salted Oak	N/A	N/A	N/A
WWP Designer White Paint.....	N/A	GWL Designer White	MWL Designer White

*WSO Salted Oak and WEC Ebony Features matte 5% sheen. All other finishes are 40% sheen

HPL TOPS ON TFL PRODUCTS Add 10% - Available with flat edge only

Send 3x3 or larger finish chip for color match. Custom finish upcharge is 3% or \$250 Net (whichever is greater).

Finish

ENVI-CT Green Certified European Technology Coatings
Finish.

Thinking quietly specifications



Thinking quietly design

Designed by Thinking Works Design Studio

In a lively setting, Thinking quietly's range of acoustic furniture turns the volume down on peripheral sound. Acoustic engineers assisted in the design process of this collection that focuses on reducing external noise. Sound comfort with a 21st Century design fits perfectly in the modern office!

Acoustic Engineers used acoustic modeling software to determine that a Thinking quietly 4-Pack with the acoustic umbrella, screens, and desk pads has up to a 44% improvement over a standard open plan station with screens.



Scope

2, 4, and 6 pack workstations with 54", 60", 66", and 72" tops. Conference room settings offering 29" heights with wood or laminate. Available in round, square, and rectangle shapes. Thinking quietly workstations are available with or without the umbrella. Optional front screens are available with or without umbrella. Deletion of the signature acoustic panels will reduce the effectiveness of the noise reduction.

Thinking quietly specifications



Thinking quietly cone design

Designed by Thinking Works Design Studio

- Only available as fixed height
- Recommended position is 5' above floor
- Solid wood frame available in Salted Oak or Ebony finish
- Metal hardware offered in Gray or Graphite Gray powdercoat
- Acoustic panels are available in Heather or Charcoal gray

Thinking quietly specifications



Thinking quietly workbay design

Designed by Thinking Works Design Studio

- Solid wood frame available in Salted Oak or Ebony finish
- Metal hardware offered in Gray or Graphite Gray powdercoat
- Acoustic panels are available in Heather or Charcoal gray

Thinking quietly workbay dimension specifications (c-shape)

THQ6767CS920

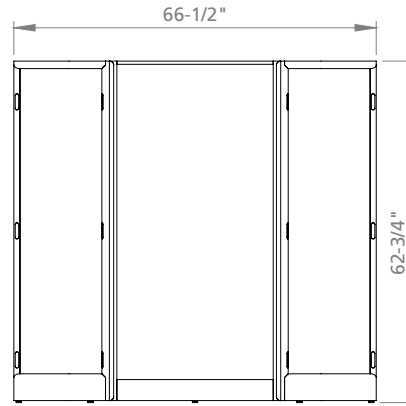
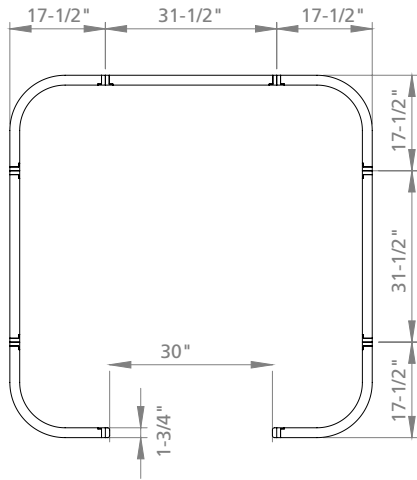

THQ8267CS920

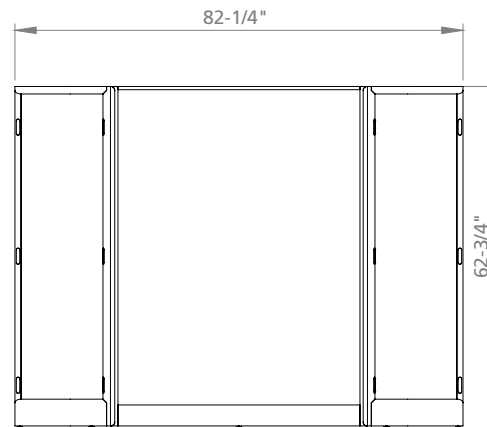
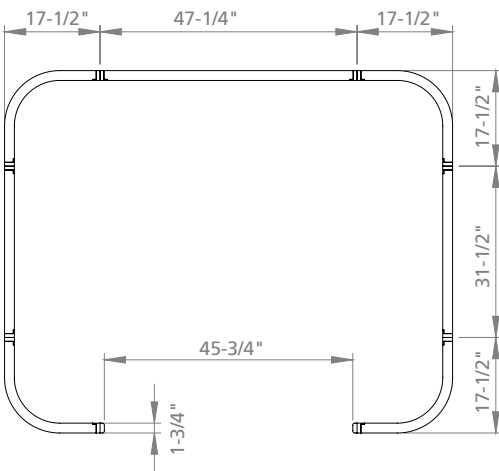

Thinking quietly workbay dimension specifications (c-shape)

THQ8282CS920

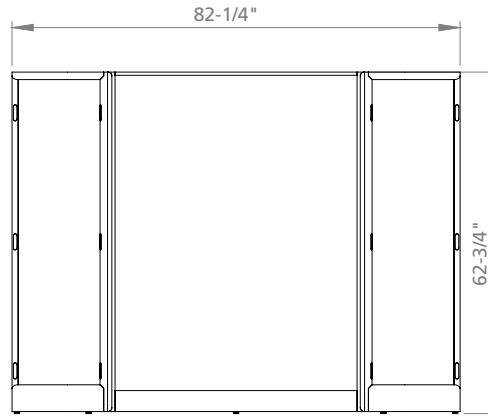
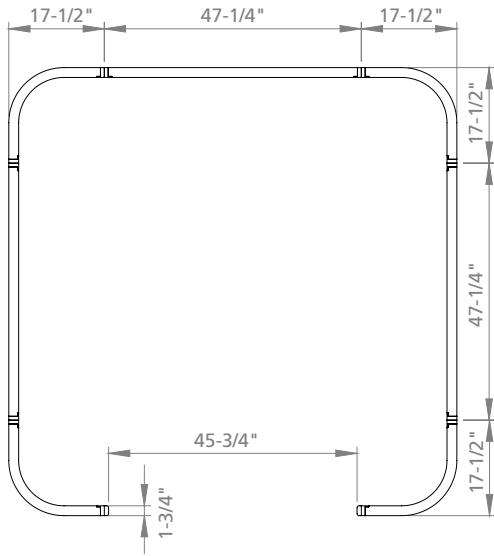

1-3/4"

Thinking quietly workbay dimension specifications (c-shape)

THQ9882CS920

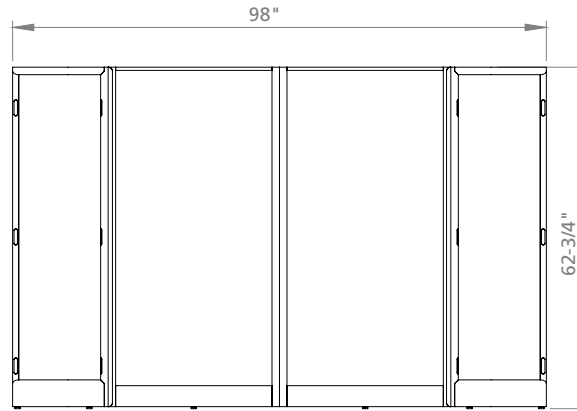
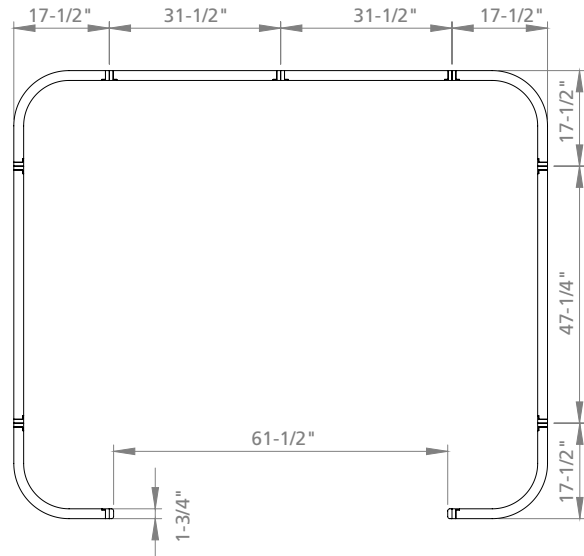

THQ9898CS920

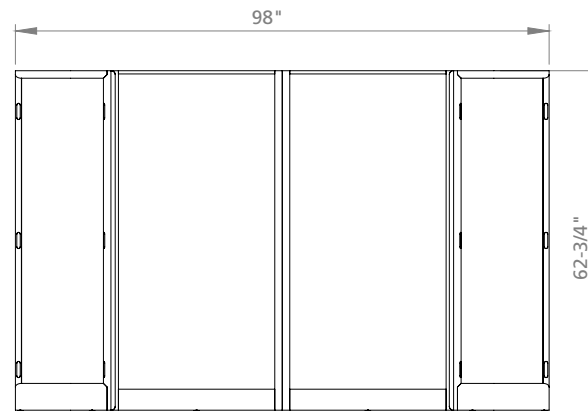
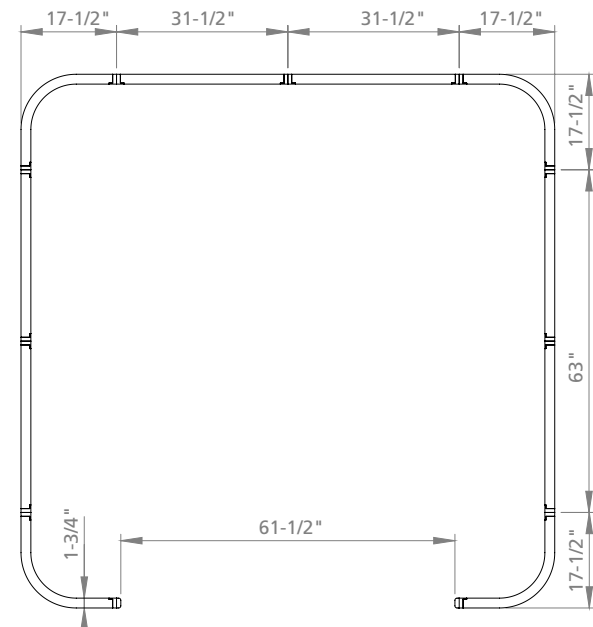

Thinking quietly workbay dimension specifications (s-shape)

THQ13267SS920

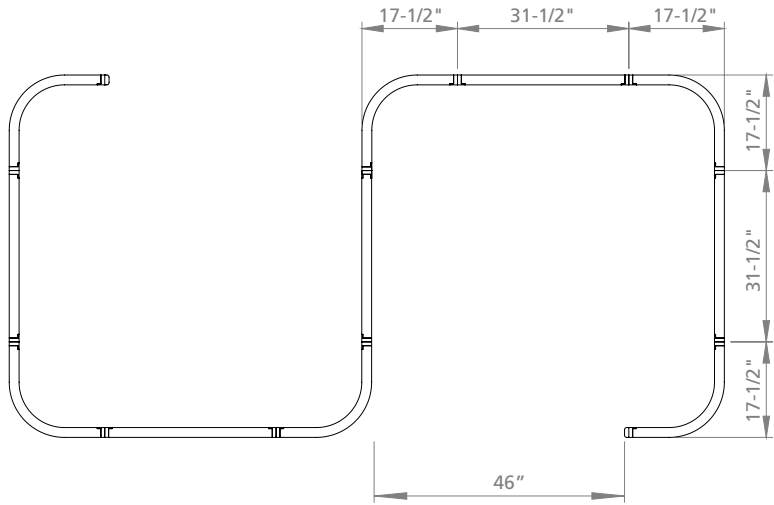

THQ16367SS920

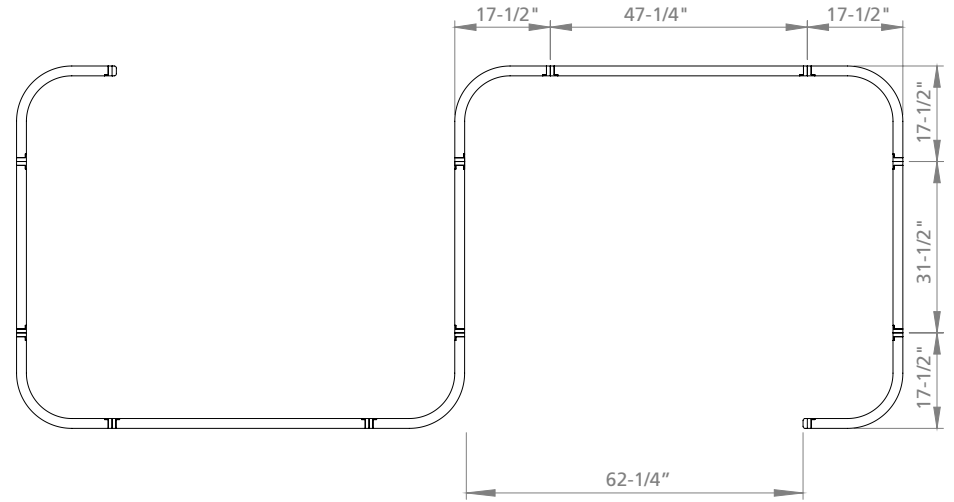

THQ16382SS920

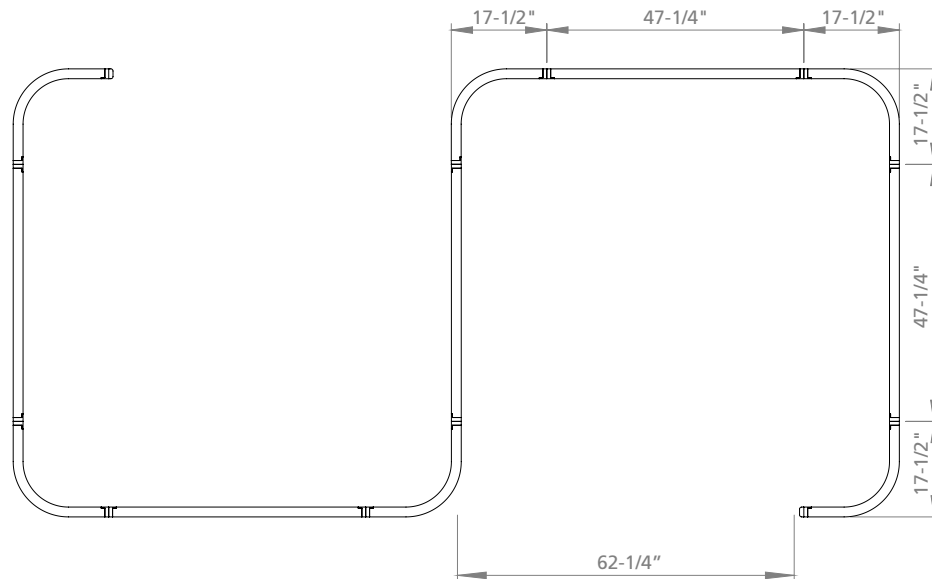

Thinking quietly workbay dimension specifications (s-shape)

THQ19482SS920

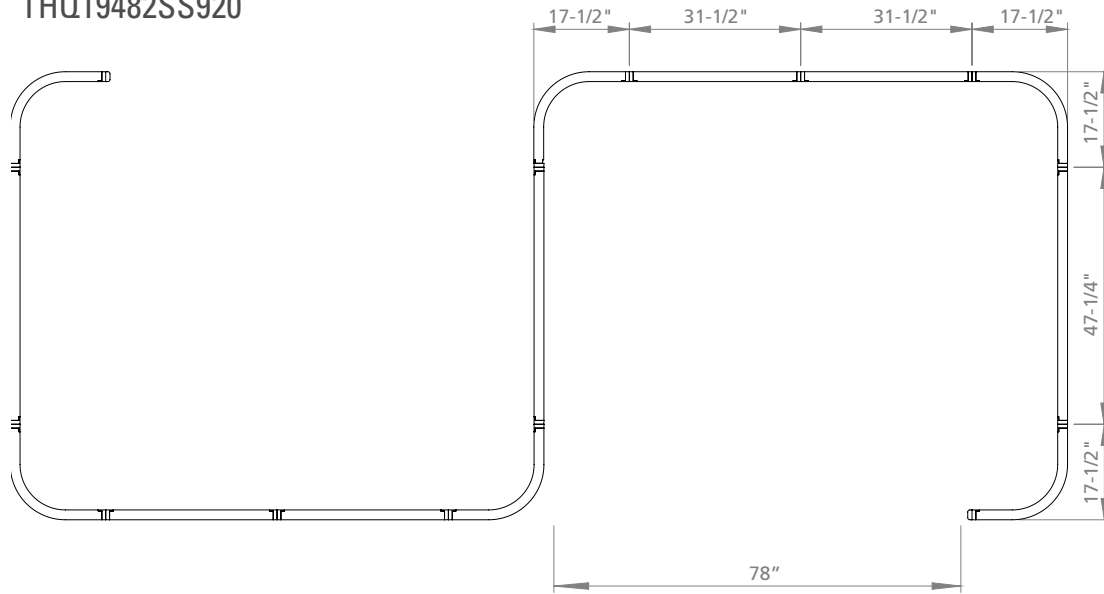

THQ19498SS920

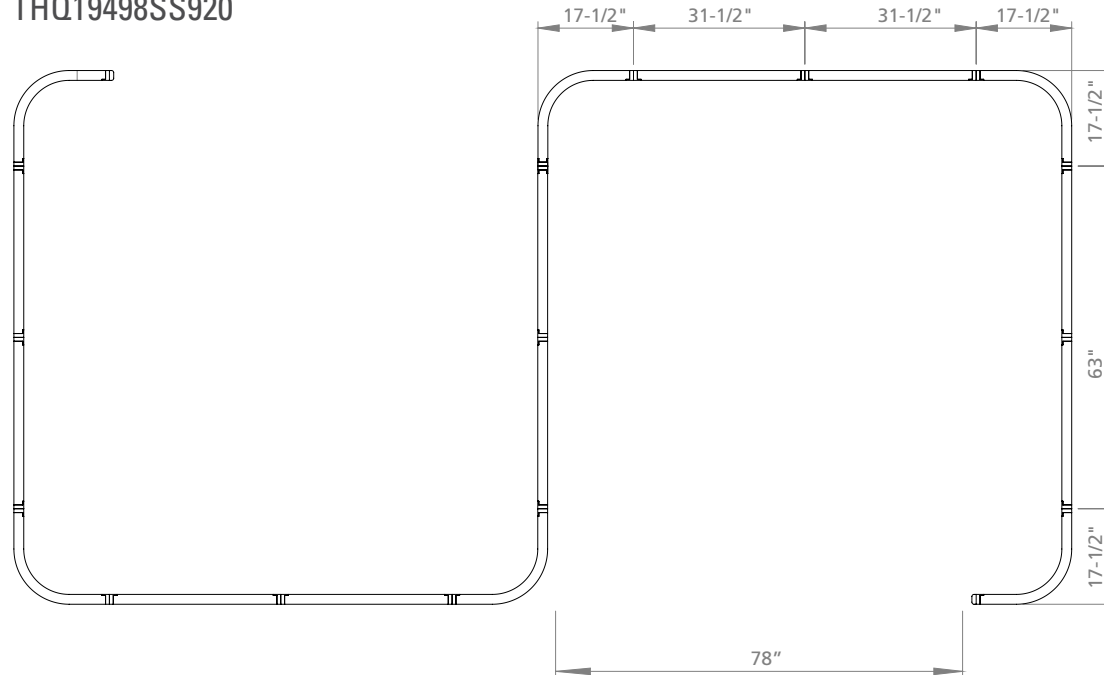

Thinking quietly workbay dimension specifications (zig-zag)

THQ7036ZS920

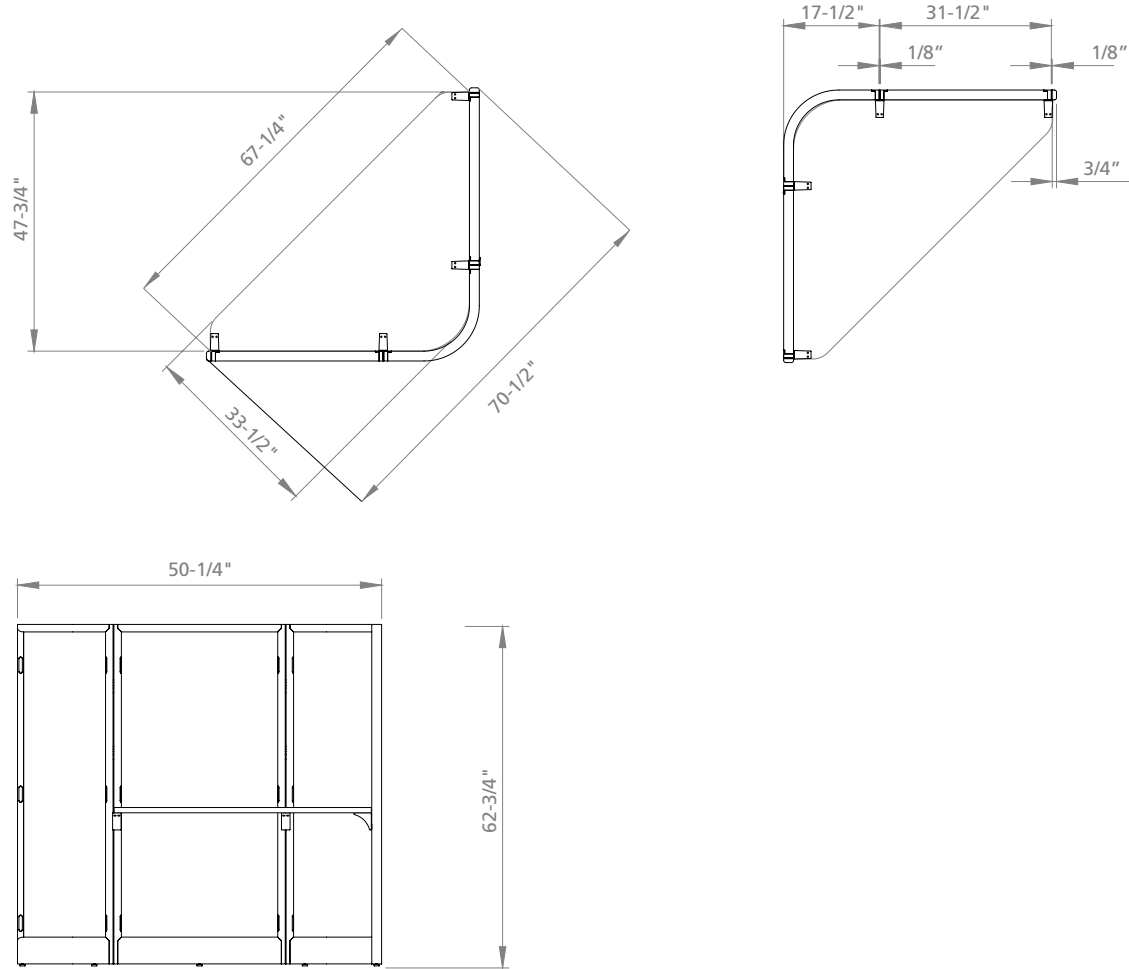

Thinking quietly workbay dimension specifications (zig-zag)
 THQ11941ZS920

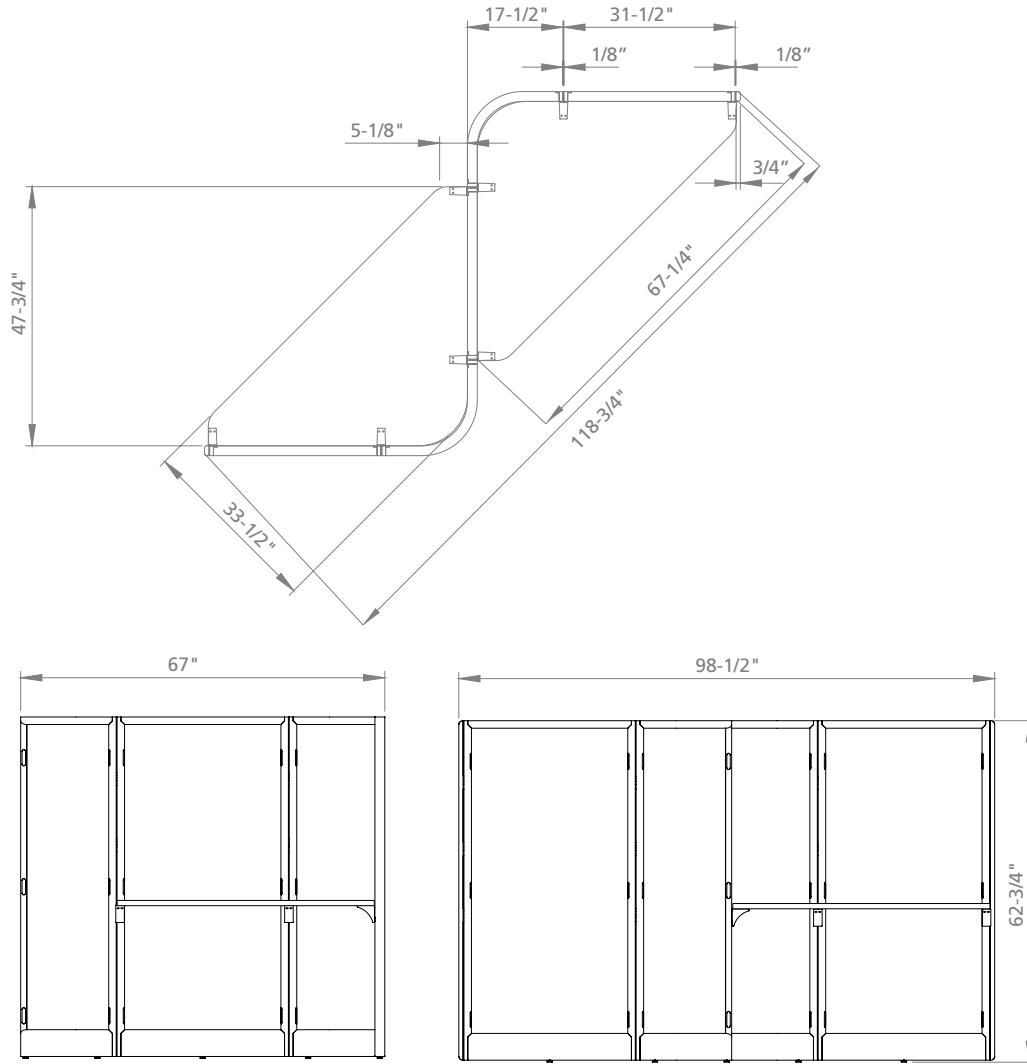

Thinking quietly workbay dimension specifications (zig-zag)
 THQ16241ZS920

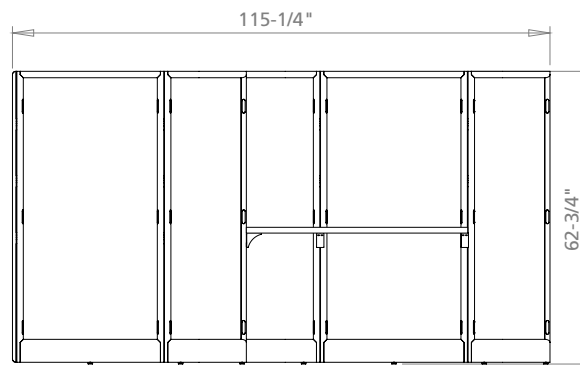
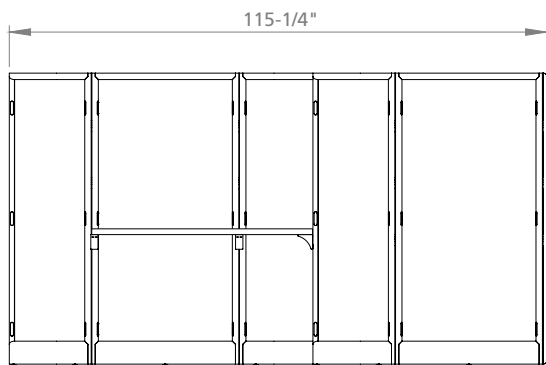
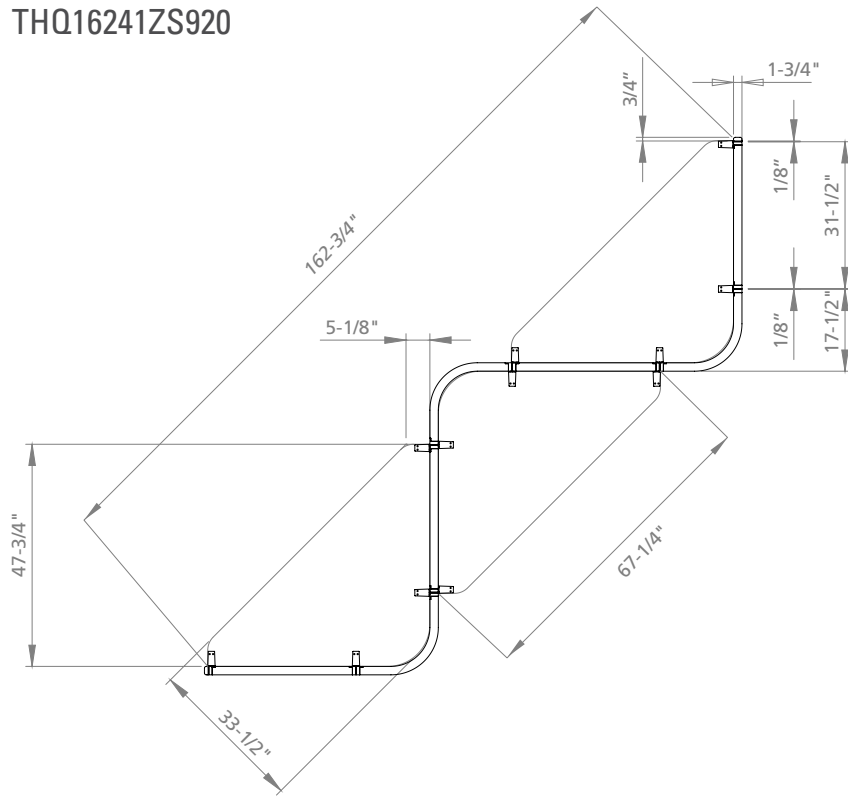

Thinking quietly workbay dimension specifications (zig-zag)

THQ21041ZS920

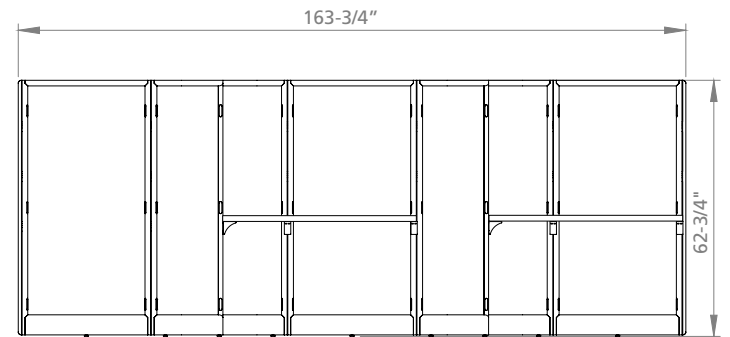
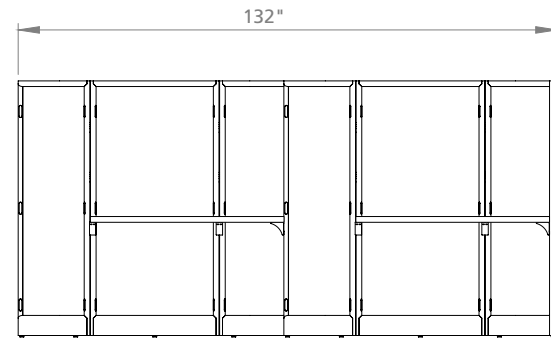
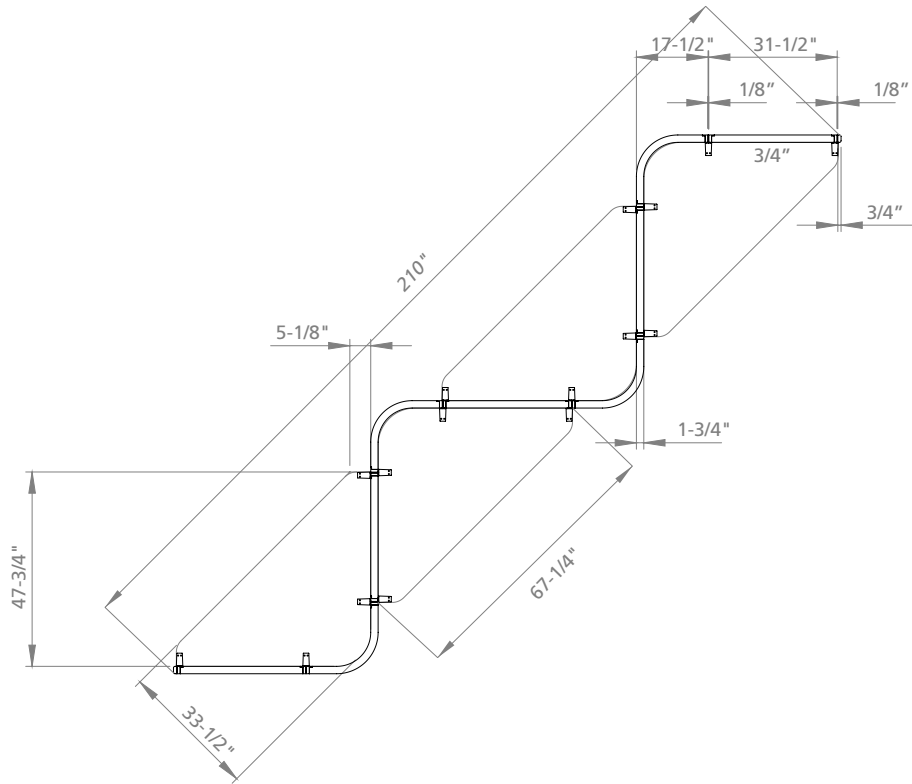

Edges | pulls

STANDARD PROFILE

"W" & "G" STANDARD PROFILE

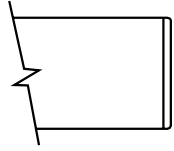

"W" "P" 3mm Hardwood Band
"G" HPL Self Laminate Band

Flat-1
"W" "G"

*Flat-1 not available in GWL finish

"W" "G" & "M" STANDARD PROFILE

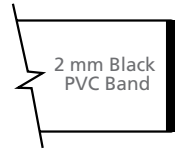

Flat-2
"W" "G"

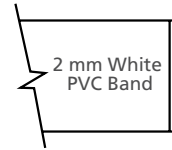

Flat-3
"W" "G"

PULLS

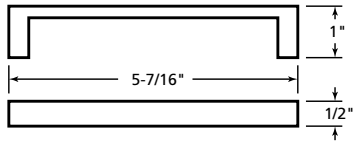

PL-115 Matte Black
PL-116 Matte Nickel

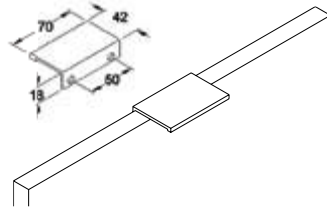

PL-260 Anodized Aluminum
PL-261 White
(Drawers Only)
Optional \$15 list per pull

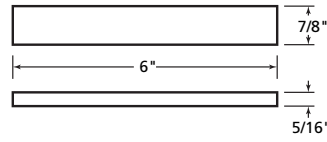

PL-210 Anodized Aluminum

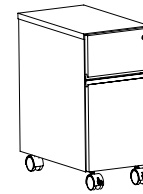

Finger Pull
"W" "G"
Styles Only

Thinking quietly Workstation infill block system

54" WORKSURFACE INFILL PLACEMENT GUIDE

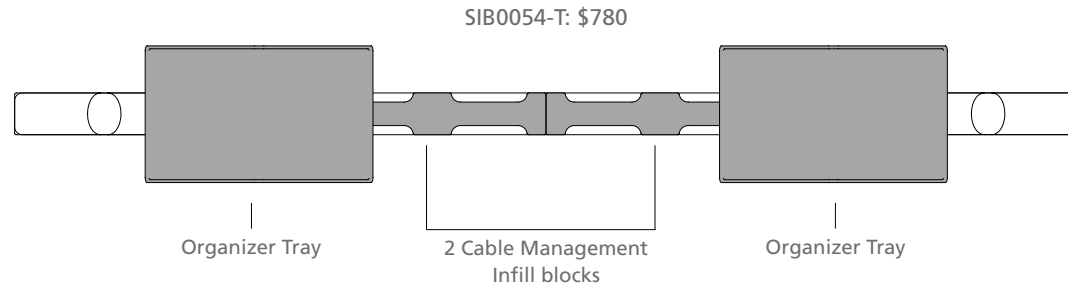
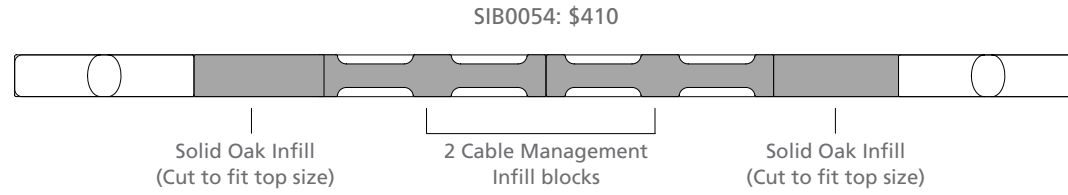

Tully Clamp Mount Power fits in the cable management infill block.
 Please reference our Thinking quietly Power Guide:
http://www.darran.com/assets/pricelists/power_Thinking quietly.pdf

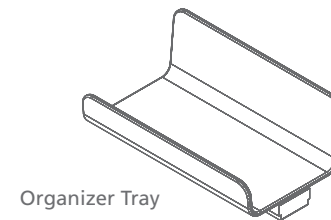

Thinking quietly Workstation infill block system
60", 66" & 72" WORKSURFACE INFILL PLACEMENT GUIDE

SIB6072: \$505

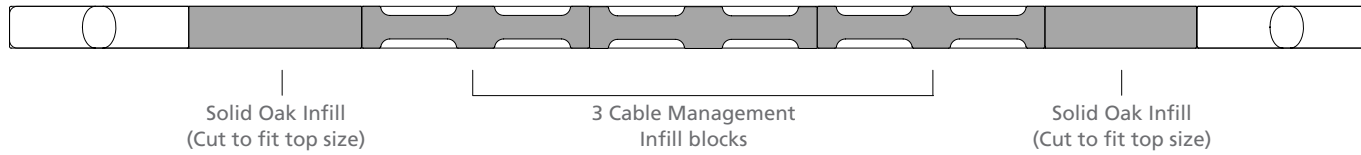

SIB6072-T: \$890

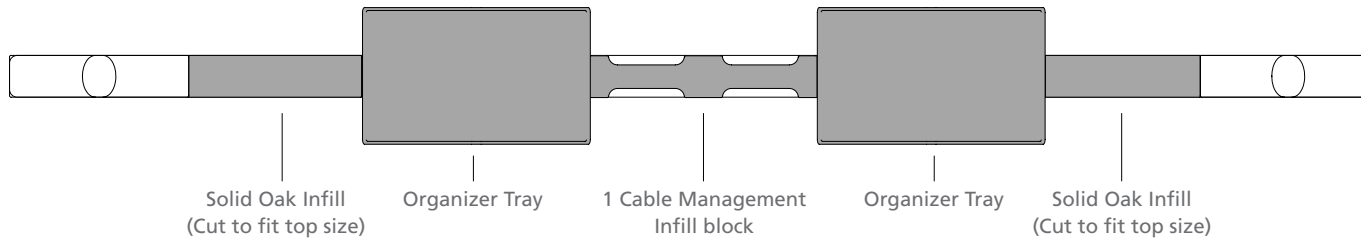

Tully Clamp Mount Power fits in the cable management infill block.
 Please reference our Thinking quietly Power Guide:
http://www.darran.com/assets/pricelists/power_Thinking quietly.pdf

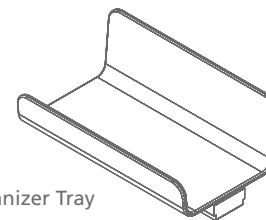

Organizer Tray

Thinking quietly Grommets | grommet reference

TM30
Black
1-5/8" Dia.

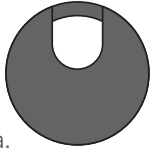

TM31
Silver
1-5/8" Dia.

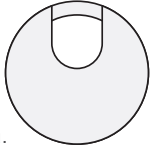

TM34
White
1-5/8" Dia.

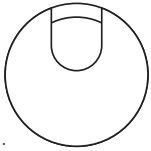

Optional Grommets

Factory Installed

Grommets (Standard Location)

Specify Color and Left/Right/Center - \$50 ea.

- Black: TM30-R (Right), TM30-L (Left), TM30-C (Center)

- Silver: TM31-R (Right), TM31-L (Left), TM31-C (Center)

- White: TM34-R (Right), TM34-L (Left), TM34-C (Center)

Grommets (Non-Standard Location)

Provide drawing w/ Grommet Location and Specify Color - \$95 ea.

- Black: TM30-NS

- Silver: TM31-NS

- White: TM33-NS

TM50
Black
1-5/8" Dia.



Grommets (Vertical Surface)

Standard Location - \$50 ea.

- Black Plastic Vertical Surface: TM50-C (Bottom Center)

Non-Standard Location - \$95 ea.

- Black Plastic Vertical Surface: TM50-NS

CONFERENCE WIRE MANAGEMENT

Power and data cables can be discretely housed and managed. 10"W x 1.5"D x 1.25"H

W21: Grey Wire Manager (10.5") - \$35

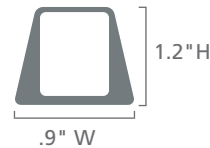
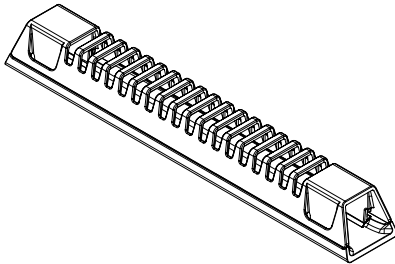

VERTEBRAE WIRE MANAGEMENT

W22 - Vertebrae (Clear) - \$135

W23 - Vertebrae (Gray) - \$140

*Field Installed



Standard Grommet Location Reference

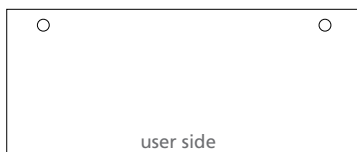

Desk

Specify Right or Left Grommet

Thinking quietly Grain direction

Veneer chassis parts are vertical grain. The backs of Thermally Fused Laminate overheads, wall hungs, wall hung shelves and flush chassis desks are horizontal grain. Bridges, returns, and credenza kneespace Thermally Fused Laminate backs over 60" are horizontal grain. Doors feature vertical veneer bookmatched horizontally in sets of 2,4, and 6 doors. Tower fronts are matched in vertical sets.

GRAIN DIRECTION

"W" CONFERENCE

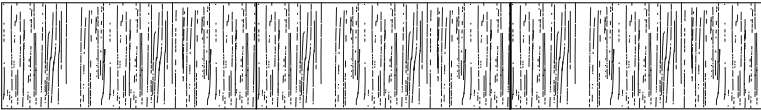
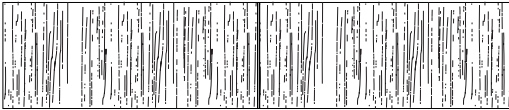

"G" & "M" CONFERENCE



WORKSURFACES



Desk

Thinking quietly Drawer dimensions | filing reference

Interior drawer dimensions

UNIT DEPTH	DRAWER TYPE	OVERALL DIMENSIONS			INTERIOR DRAWER DIMENSIONS			NOTES
		W	D	H	W	D	H	
15-5/8" Letter	18" Box	13-1/8	16-1/16	4	12-1/8	15-1/16	3-7/16	Units less than 72"
	18" File	13-1/8	16-1/16	9-13/16	12-1/8	15-1/16	9-5/16	
	10" Box	7-1/2	16-1/16	4	6-1/2	15-1/16	3-7/16	
	10" File	7-1/2	16-1/16	9-13/16	6-1/2	15-1/16	9-5/16	

FILING REFERENCE

FILING FOR 18" DEPTH UNITS

13 1/8" Wide File Drawer - 16 1/16" Deep

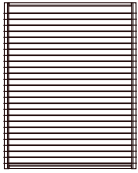

Letter Front to Back

FILING FOR 10" DEPTH UNITS

7-1/2" Wide File Drawer - 16 1/16" Deep

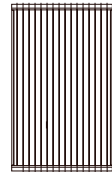

Letter Side to Side

Thinking quietly.

Workstation With Umbrella
2 Person Facing - Umbrella

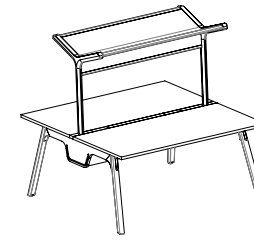

[View statement of line](#)

1 Select a model w" x d" x h"	weight	Standard Veneer Top Salted Oak Frame		Premium Veneer Top Salted Oak Frame		High Pressure Laminate Top Salted Oak Frame		Thermally Fused Laminate Top Salted Oak Frame	
		Worksurface Dimensions							
72 x 29 x 29	338	THQ7260WP901W	8951	"P" Option N/A	THQ7260WP901G	8578	THQ7260WP901M	8130	
66 x 29 x 29	307	THQ6660WP901W	8716	"P" Option N/A	THQ6660WP901G	8354	THQ6660WP901M	7906	
60 x 29 x 29	266	THQ6060WP901W	8479	"P" Option N/A	THQ6060WP901G	8130	THQ6060WP901M	7562	
54 x 29 x 29	235	THQ5460WP901W	8201	"P" Option N/A	THQ5460WP901G	7862	THQ5460WP901M	7295	
2 Select a finish View finish details Metal finish MFG Gray (standard). Premium metal finishes available, see options.	Top finish	Frame finish		Top finish	Frame finish	Top finish	Frame finish	Top finish	Frame finish
	WEC WAM WWP WSO	WSO WEC +10%		GEC GAM GWL	WSO WEC +10%	MEC MWL	WSO WEC +10%		
3 Select a edge View edge details	Flat-1	Flat-2 (Black)	Flat-3 (White)	Flat-1	Flat-2 (Black)	Flat-3 (White)	Flat-2 (Black)	Flat-3 (White)	
4 Select acoustic color View hardware details	SHG	SCG		SHG	SCG	SHG	SCG	SHG	SCG

Product features.

- 2" Central trough for adding infill blocks and power
- Includes: 2 worksurfaces, 1 central cable tray, and umbrella
- 1" Thick top
- ENVI-CT Finish on wood tops
- Base and umbrella: Solid Salted Oak with Lofty Ash Inserts
- Umbrella is acoustically beneficial with it's felt material composition.
- Acoustic cable tray absorbs floor level noise

NOTES

- 72 x 30 worksurface - 72"W x 60"D
- 66 x 30 worksurface - 66"W x 60"D
- 60 x 30 worksurface - 60"W x 60"D
- 54 x 30 worksurface - 54"W x 60"D

Options.

WORKSTATION INFILL

- 1SIB0054: 54" Worksurface Infill Blocks; (2) cable management infills (2) solid infills - \$410
- 1SIB0054-T: 54" Worksurface Infill Blocks; (2) cable management infills (2) organizer trays - \$780
- 1SIB6072: 60", 66" & 72" Worksurface Infill Blocks; (3) cable management infills (2) solid infills - \$505
- 1SIB6072-T: 60", 66" & 72" Worksurface Infill Blocks; (1) cable management infill (2) organizer trays (2) Solid Infills - \$890

TASK LIGHT KIT - 2 PERSON WORKSTATION

- TQ-LED72: LED Lighting for 72" Umbrella - \$530
- TQ-LED66: LED Lighting for 66" Umbrella - \$510
- TQ-LED60: LED Lighting for 60" Umbrella - \$490
- TQ-LED54: LED Lighting for 54" Umbrella - \$470

POWER BLOCK KIT FOR CABLE TRAY - 2 PERSON WORKSTATION

- 2PPBS: Two Pack Power Block System with either Hardwired or Power Cord - \$390
- Specify hardwired (120" cord) or plugged (72" cord)
- Includes (1) Power Block and Infeed
- Power block has 8 duplex outlets

WORKSURFACE CLAMP MOUNT POWER

- PD-KENO: Keno power pod with clamp - \$195 ea.
- PD-TULLY: Tully power pod with clamp - \$320 ea.

WIRE MANAGER

- W22: Vertebrae (Clear) - \$135
- W23: Vertebrae (Gray) - \$140

PREMIUM FINISH

- WEC: Ebony finish on solid wood frame - 10% upcharge

PREMIUM METAL FINISH

- MFGG: Graphite Gray - \$825

Thinking quietly.

Workstation With Umbrella
4 Person Facing - Umbrella

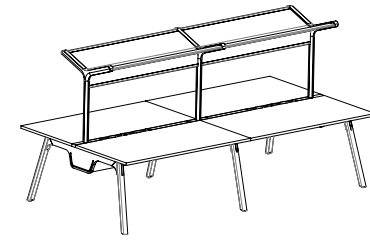

[View statement of line](#)

1 Select a model w" x d" x h"	weight	Standard Veneer Top Salted Oak Frame		Premium Veneer Top Salted Oak Frame		High Pressure Laminate Top Salted Oak Frame		Thermally Fused Laminate Top Salted Oak Frame	
		Worksurface Dimensions							
72 x 29 x 29	591	THQ14460WP901W	15156	"P" Option N/A		THQ14460WP901G	14409	THQ14460WP901M	13514
66 x 29 x 29	544	THQ13260WP901W	14855	"P" Option N/A		THQ13260WP901G	14130	THQ13260WP901M	13235
60 x 29 x 29	477	THQ12060WP901W	14551	"P" Option N/A		THQ12060WP901G	13852	THQ12060WP901M	12716
54 x 29 x 29	430	THQ10860WP901W	14164	"P" Option N/A		THQ10860WP901G	13487	THQ10860WP901M	12351
2 Select a finish View finish details Metal finish MFG Gray (standard). Premium metal finishes available, see options.	Top finish	Frame finish		Top finish	Frame finish	Top finish	Frame finish	Top finish	Frame finish
	WEC WAM WWP WSO	WSO WEC +10%		GEC GAM GWL	WSO WEC +10%	MEC MWL	WSO WEC +10%		
3 Select a edge View edge details	Flat-1	Flat-2 (Black)	Flat-3 (White)	Flat-1	Flat-2 (Black)	Flat-3 (White)	Flat-2 (Black)	Flat-3 (White)	
4 Select acoustic color View hardware details	SHG	SCG		SHG	SCG	SHG	SCG	SHG	SCG

Product features.

- 2" Central trough for adding infill blocks and power
- Includes: 4 worksurfaces, 2 central cable trays, and umbrella
- 1" Thick top
- ENVI-CT Finish on wood tops
- Base and umbrella: Solid Salted Oak with Lofty Ash Inserts
- Umbrella is acoustically beneficial with it's felt material composition.
- Acoustic cable tray absorbs floor level noise

NOTES

- 72 x 30 worksurface - 144"W x 60"D
- 66 x 30 worksurface - 132"W x 60"D
- 60 x 30 worksurface - 120"W x 60"D
- 54 x 30 worksurface - 108"W x 60"D

Options.

WORKSTATION INFILL

- 2SIB0054: 54" Worksurface Infill Blocks; (4) cable management infills (4) solid infills - \$815
- 2SIB0054-T: 54" Worksurface Infill Blocks; (4) cable management infills (4) organizer trays - \$1560
- 2SIB6072: 60", 66" & 72" Worksurface Infill Blocks; (6) cable management infills (4) solid infills - \$1010
- 2SIB6072-T: 60", 66" & 72" Worksurface Infill Blocks; (2) cable management infill (4) organizer trays (4) Solid Infills - \$1780

TASK LIGHT KIT - 4 PERSON WORKSTATION

- TQ-LED72: LED Lighting for 72" Umbrella - \$1000
- TQ-LED66: LED Lighting for 66" Umbrella - \$955
- TQ-LED60: LED Lighting for 60" Umbrella - \$905
- TQ-LED54: LED Lighting for 54" Umbrella - \$860

POWER BLOCK KIT FOR CABLE TRAY - 4 PERSON WORKSTATION

- 4PPBS: Four Pack Power Block System with either Hardwired or Power Cord - \$750
- Specify hardwired (120" cord) or plugged (72" cord)
- Includes (2) Power Blocks, (1) Jumper and Infeed
- Each power block has 8 duplex outlets

WORKSURFACE CLAMP MOUNT POWER

- PD-KENO: Keno power pod with clamp - \$195 ea.
- PD-TULLY: Tully power pod with clamp - \$320 ea.

WIRE MANAGER

- W22: Vertebrae (Clear) - \$135
- W23: Vertebrae (Gray) - \$140

PREMIUM FINISH

- WEC: Ebony finish on solid wood frame - 10% upcharge

PREMIUM METAL FINISH

- MFGG: Graphite Gray - \$1290

Thinking quietly.

Workstation With Umbrella
6 Person Facing - Umbrella

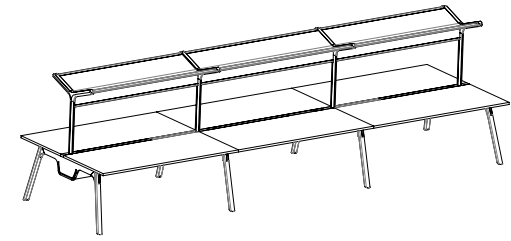

1 Select a model

weight

Standard Veneer Top
Salted Oak Frame

Premium Veneer Top
Salted Oak Frame

High Pressure Laminate Top
Salted Oak Frame

View statement of line

Thermally Fused Laminate Top
Salted Oak Frame

Worksurface Dimensions

W x D x H	Weight	Standard Veneer Top	Premium Veneer Top
72 x 29 x 29	844	THQ21660WP901W 21508	"P" Option N/A
66 x 29 x 29	781	THQ19860WP901W 21093	"P" Option N/A
60 x 29 x 29	688	THQ18060WP901W 20672	"P" Option N/A
54 x 29 x 29	625	THQ16260WP901W 20126	"P" Option N/A

Top finish	Frame finish	High Pressure Laminate Top	Thermally Fused Laminate Top
WEC	WSO	THQ21660WP901G 20388	THQ21660WP901M 19044
WAM	WEC +10%	THQ19860WP901G 20005	THQ19860WP901M 18663
WWP		THQ18060WP901G 19624	THQ18060WP901M 17920
WSO		THQ16260WP901G 19110	THQ16260WP901M 17406

2 Select a finish

Top finish
WEC
WAM
WWP
WSO

Frame finish
WSO
WEC +10%

Top finish
GEC
GAM
GWL

Frame finish
WSO
WEC +10%

Top finish
MEC
MWL

Frame finish
WSO
WEC +10%

Metal finish
MFG Gray (standard).
Premium metal finishes
available, see options.

3 Select a edge

View edge details

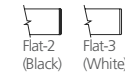
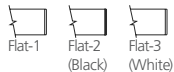
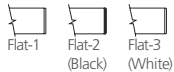

4 Select acoustic color

View hardware details

SHG
SCG

SHG
SCG

SHG
SCG

Product features.

- 2" Central trough for adding infill blocks and power
- Includes: 6 worksurfaces, 3 central cable trays, and umbrella
- 1" Thick top
- ENVI-CT Finish on wood tops
- Base and umbrella: Solid Salted Oak with Lofty Ash Inserts
- Umbrella is acoustically beneficial with it's felt material composition.
- Acoustic cable tray absorbs floor level noise

NOTES

- 72 x 30 worksurface - 216"W x 60"D
- 66 x 30 worksurface - 198"W x 60"D
- 60 x 30 worksurface - 180"W x 60"D
- 54 x 30 worksurface - 162"W x 60"D

Options.

WORKSTATION INFILL

- 3SIB0054: 54" Worksurface Infill Blocks; (6) cable management infills (6) solid infills - \$1220
- 3SIB0054-T: 54" Worksurface Infill Blocks; (6) cable management infills (6) organizer trays - \$2340
- 3SIB6072: 60", 66" & 72" Worksurface Infill Blocks; (9) cable management infills (6) solid infills - \$1515
- 3SIB6072-T: 60", 66" & 72" Worksurface Infill Blocks; (3) cable management infill (6) organizer trays (6) Solid Infills - \$2670

TASK LIGHT KIT - 6 PERSON WORKSTATION

- TQ-LED72: LED Lighting for 72" Umbrella - \$1470
- TQ-LED66: LED Lighting for 66" Umbrella - \$1395
- TQ-LED60: LED Lighting for 60" Umbrella - \$1325
- TQ-LED54: LED Lighting for 54" Umbrella - \$1250

POWER BLOCK KIT FOR CABLE TRAY - 6 PERSON WORKSTATION

- 6PPBS: Six Pack Power Block System with either Hardwired or Power Cord - \$1,100
- Specify hardwired (120" cord) or plugged (72" cord)
- Includes (3) Power Blocks, (2) Jumpers and Infeed
- Each power block has 8 duplex outlets
- Plug Infeed can be daisy chained up to 16 duplex outlets on one 20 amp circuit

WORKSURFACE CLAMP MOUNT POWER

- PD-KENO: Keno power pod with clamp - \$195 ea.
- PD-TULLY: Tully power pod with clamp - \$320 ea.

WIRE MANAGER

- W22: Vertebrae (Clear) - \$135
- W23: Vertebrae (Gray) - \$140

PREMIUM FINISH

- WEC: Ebony finish on solid wood frame - 10% upcharge

PREMIUM METAL FINISH

- MFGG: Graphite Gray - \$1730

Thinking quietly.

Workstation
2 Person Facing - No Umbrella

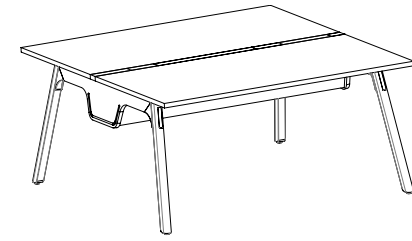

[View statement of line](#)

1 Select a model w" x d" x h"	weight	Standard Veneer Top Salted Oak Frame		Premium Veneer Top Salted Oak Frame		High Pressure Laminate Top Salted Oak Frame		Thermally Fused Laminate Top Salted Oak Frame																																					
		<p>Worksurface Dimensions</p> <table border="1"> <tr> <td>72 x 29 x 29</td> <td>275</td> <td>THQ7260WP900W</td> <td>4998</td> <td>"P" Option N/A</td> <td>THQ7260WP900G</td> <td>4625</td> <td>THQ7260WP900M</td> <td>4177</td> </tr> <tr> <td>66 x 29 x 29</td> <td>250</td> <td>THQ6660WP900W</td> <td>4829</td> <td>"P" Option N/A</td> <td>THQ6660WP900G</td> <td>4467</td> <td>THQ6660WP900M</td> <td>4019</td> </tr> <tr> <td>60 x 29 x 29</td> <td>215</td> <td>THQ6060WP900W</td> <td>4657</td> <td>"P" Option N/A</td> <td>THQ6060WP900G</td> <td>4308</td> <td>THQ6060WP900M</td> <td>3740</td> </tr> <tr> <td>54 x 29 x 29</td> <td>190</td> <td>THQ5460WP900W</td> <td>4445</td> <td>"P" Option N/A</td> <td>THQ5460WP900G</td> <td>4106</td> <td>THQ5460WP900M</td> <td>3538</td> </tr> </table>										72 x 29 x 29	275	THQ7260WP900W	4998	"P" Option N/A	THQ7260WP900G	4625	THQ7260WP900M	4177	66 x 29 x 29	250	THQ6660WP900W	4829	"P" Option N/A	THQ6660WP900G	4467	THQ6660WP900M	4019	60 x 29 x 29	215	THQ6060WP900W	4657	"P" Option N/A	THQ6060WP900G	4308	THQ6060WP900M	3740	54 x 29 x 29	190	THQ5460WP900W	4445	"P" Option N/A	THQ5460WP900G	4106
72 x 29 x 29	275	THQ7260WP900W	4998	"P" Option N/A	THQ7260WP900G	4625	THQ7260WP900M	4177																																					
66 x 29 x 29	250	THQ6660WP900W	4829	"P" Option N/A	THQ6660WP900G	4467	THQ6660WP900M	4019																																					
60 x 29 x 29	215	THQ6060WP900W	4657	"P" Option N/A	THQ6060WP900G	4308	THQ6060WP900M	3740																																					
54 x 29 x 29	190	THQ5460WP900W	4445	"P" Option N/A	THQ5460WP900G	4106	THQ5460WP900M	3538																																					
2 Select a finish View finish details Metal finish MFG Gray (standard). Premium metal finishes available, see options.	Top finish	Frame finish		Top finish	Frame finish	Top finish	Frame finish	Top finish	Frame finish																																				
	WEC WAM WWP WSO	WSO WEC +10%		GEC GAM GWL	WSO WEC +10%	MEC MWL	WSO WEC +10%																																						
3 Select a edge View edge details	Flat-1		Flat-2 (Black)	Flat-3 (White)	Flat-1	Flat-2 (Black)	Flat-3 (White)	Flat-2 (Black)	Flat-3 (White)																																				
	SHG		SCG		SHG		SCG		SHG																																				
4 Select acoustic color View hardware details	SHG		SCG		SHG		SCG		SHG																																				
	SCG		SHG		SCG		SHG		SCG																																				

Product features.

- 2" Central trough for adding infill blocks and power
- Includes: 2 worksurfaces, 1 central cable tray
- 1" Thick top
- ENVI-CT Finish on wood tops
- Base is Solid Salted Oak with Lofty Ash inserts
- Surfaces 66" and over have horizontal support rods
- Acoustic cable tray absorbs floor level noise

NOTES

- 72 x 30 worksurface - 72"W x 60"D
- 66 x 30 worksurface - 66"W x 60"D
- 60 x 30 worksurface - 60"W x 60"D
- 54 x 30 worksurface - 54"W x 60"D

Options.

WORKSTATION INFILL

- 1SIB0054: 54" Worksurface Infill Blocks; (2) cable management infills (2) solid infills - \$410
- 1SIB0054-T: 54" Worksurface Infill Blocks; (2) cable management infills (2) organizer trays - \$780
- 1SIB6072: 60", 66" & 72" Worksurface Infill Blocks; (3) cable management infills (2) solid infills - \$505
- 1SIB6072-T: 60", 66" & 72" Worksurface Infill Blocks; (1) cable management infill (2) organizer trays (2) Solid Infills - \$890

POWER BLOCK KIT FOR CABLE TRAY - 2 PERSON WORKSTATION

- 2PPBS: Two Pack Power Block System with either Hardwired or Power Cord - \$390
- Specify hardwired (120" cord) or plugged (72" cord)
- Includes (1) Power Block and Infeed
- Power block has 8 duplex outlets

WORKSURFACE CLAMP MOUNT POWER

- PD-KENO: Keno power pod with clamp - \$195 ea.
- PD-TULLY: Tully power pod with clamp - \$320 ea.

WIRE MANAGER

- W22: Vertebrae (Clear) - \$135
- W23: Vertebrae (Gray) - \$140

PREMIUM FINISH

- WEC: Ebony finish on solid wood frame - 10% upcharge

PREMIUM METAL FINISH

- MFGG: Graphite Gray - \$645

Thinking quietly.

Workstation
4 Person Facing - No Umbrella

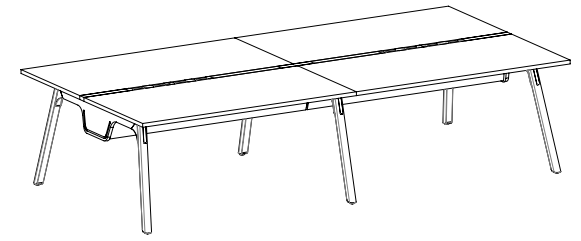

DARRAN™

1 Select a model w" x d" x h"	weight	Standard Veneer Top Salted Oak Frame		Premium Veneer Top Salted Oak Frame		High Pressure Laminate Top Salted Oak Frame		Thermally Fused Laminate Top Salted Oak Frame	
Worksurface Dimensions									
72 x 29 x 29	500	THQ14460WP900W	7971	"P" Option N/A		THQ14460WP900G	7224	THQ14460WP900M	6328
66 x 29 x 29	460	THQ13260WP900W	7769	"P" Option N/A		THQ13260WP900G	7044	THQ13260WP900M	6148
60 x 29 x 29	400	THQ12060WP900W	7562	"P" Option N/A		THQ12060WP900G	6863	THQ12060WP900M	5727
54 x 29 x 29	360	THQ10860WP900W	7273	"P" Option N/A		THQ10860WP900G	6596	THQ10860WP900M	5460
2 Select a finish View finish details	Top finish	Frame finish		Top finish	Frame finish	Top finish	Frame finish	Top finish	Frame finish
	WEC WAM WWP WSO	WSO WEC +10%		GEC GAM GWL	WSO WEC +10%	MEC MWL	WSO WEC +10%		
Metal finish MFG Gray (standard). Premium metal finishes available, see options.									
3 Select a edge View edge details	Flat-1	Flat-2 (Black)	Flat-3 (White)	Flat-1	Flat-2 (Black)	Flat-3 (White)	Flat-2 (Black)	Flat-3 (White)	
4 Select acoustic color View hardware details	SHG	SCG		SHG	SCG	SHG	SCG	SHG	SCG

[View statement of line](#)

Product features.

- 2" Central trough for adding infill blocks and power
- Includes: 4 worksurfaces, 2 central cable trays
- 1" Thick top
- ENVI-CT Finish on wood tops
- Base is Solid Salted Oak with Lofty Ash inserts
- Acoustic cable tray absorbs floor level noise

NOTES

- 72 x 30 worksurface - 144"W x 60"D
- 66 x 30 worksurface - 132"W x 60"D
- 60 x 30 worksurface - 120"W x 60"D
- 54 x 30 worksurface - 108"W x 60"D

Options.

WORKSTATION INFILL

- 2SIB0054: 54" Worksurface Infill Blocks; (4) cable management infills (4) solid infills - \$815
- 2SIB0054-T: 54" Worksurface Infill Blocks; (4) cable management infills (4) organizer trays - \$1560
- 2SIB6072: 60", 66" & 72" Worksurface Infill Blocks; (6) cable management infills (4) solid infills - \$1010
- 2SIB6072-T: 60", 66" & 72" Worksurface Infill Blocks; (2) cable management infill (4) organizer trays (4) Solid Infills - \$1780

POWER BLOCK KIT FOR CABLE TRAY - 4 PERSON WORKSTATION

- 4PPBS: Four Pack Power Block System with either Hardwired or Power Cord - \$750
- Specify hardwired (120" cord) or plugged (72" cord)
- Includes (2) Power Blocks, (1) Jumper and Infeed
- Each power block has 8 duplex outlets

WORKSURFACE CLAMP MOUNT POWER

- PD-KENO: Keno power pod with clamp - \$195 ea.
- PD-TULLY: Tully power pod with clamp - \$320 ea.

WIRE MANAGER

- W22: Vertebrae (Clear) - \$135
- W23: Vertebrae (Gray) - \$140

PREMIUM FINISH

- WEC: Ebony finish on solid wood frame - 10% upcharge

PREMIUM METAL FINISH

- MFGG: Graphite Gray - \$930

Thinking quietly.

Workstation
6 Person Facing - No Umbrella

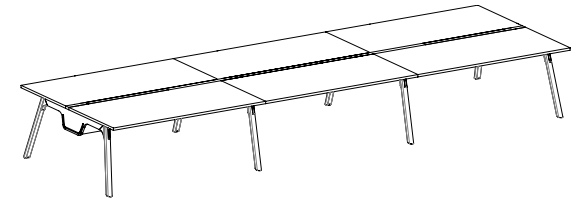

DARRAN™

1 Select a model w" x d" x h"	weight	Standard Veneer Top Salted Oak Frame		Premium Veneer Top Salted Oak Frame		High Pressure Laminate Top Salted Oak Frame		Thermally Fused Laminate Top Salted Oak Frame		
Worksurface Dimensions										
72 x 29 x 29	725	THQ21660WP900W	10911	"P" Option N/A		THQ21660WP900G	9790	THQ21660WP900M	8681	
66 x 29 x 29	670	THQ19860WP900W	10632	"P" Option N/A		THQ19860WP900G	9544	THQ19860WP900M	8290	
60 x 29 x 29	585	THQ18060WP900W	10347	"P" Option N/A		THQ18060WP900G	9299	THQ18060WP900M	7595	
54 x 29 x 29	530	THQ16260WP900W	9937	"P" Option N/A		THQ16260WP900G	8922	THQ16260WP900M	7219	
2 Select a finish <i>View finish details</i>	Top finish	Frame finish		Top finish	Frame finish	Top finish	Frame finish	Top finish	Frame finish	
	WEC WAM WWP WSO	WSO WEC +10%		GEC GAM GWL	WSO WEC +10%	MEC MWL	WSO WEC +10%			
Metal finish MFG Gray (standard). Premium metal finishes available, see options.										
3 Select a edge <i>View edge details</i>	Flat-1		Flat-2 (Black)		Flat-3 (White)		Flat-2 (Black)		Flat-3 (White)	
4 Select acoustic color <i>View hardware details</i>	SHG		SCG		SHG		SCG		SHG	

[View statement of line](#)

Product features.

- 2" Central trough for adding infill blocks and power
- Includes: 6 worksurfaces, 3 central cable trays
- 1" Thick top
- ENVI-CT Finish on wood tops
- Base is Solid Salted Oak with Lofty Ash inserts
- Acoustic cable tray absorbs floor level noise

NOTES

- 72 x 30 worksurface - 216"W x 60"D
- 66 x 30 worksurface - 198"W x 60"D
- 60 x 30 worksurface - 180"W x 60"D
- 54 x 30 worksurface - 162"W x 60"D

Options.

WORKSTATION INFILL

- 3SIB0054: 54" Worksurface Infill Blocks; (6) cable management infills (6) solid infills - \$1220
- 3SIB0054-T: 54" Worksurface Infill Blocks; (6) cable management infills (6) organizer trays - \$2340
- 3SIB6072: 60", 66" & 72" Worksurface Infill Blocks; (9) cable management infills (6) solid infills - \$1515
- 3SIB6072-T: 60", 66" & 72" Worksurface Infill Blocks; (3) cable management infill (6) organizer trays (6) Solid Infills - \$2670

POWER BLOCK KIT FOR CABLE TRAY - 6 PERSON WORKSTATION

- 6PPBS: Six Pack Power Block System with either Hardwired or Power Cord - \$1,100
- Specify hardwired (120" cord) or plugged (72" cord)
- Includes (3) Power Blocks, (2) Jumpers and Infeed
- Each power block has 8 duplex outlets
- Plug Infeed can be daisy chained up to 16 duplex outlets on one 20 amp circuit

WORKSURFACE CLAMP MOUNT POWER

- PD-KENO: Keno power pod with clamp - \$195 ea.
- PD-TULLY: Tully power pod with clamp - \$320 ea.

WIRE MANAGER

- W22: Vertebrae (Clear) - \$135
- W23: Vertebrae (Gray) - \$140

PREMIUM FINISH

- WEC: Ebony finish on solid wood frame - 10% upcharge

PREMIUM METAL FINISH

- MFGG: Graphite Gray - \$1290





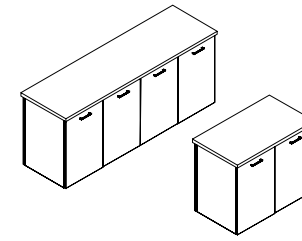











Thinking quietly.

Full Pedestal Credenzas
Storage Credenza



[View statement of line](#)

1 Select a model w" x d" x h"	weight	Standard Veneer Top Standard Veneer Chassis		Premium Veneer Top Premium Veneer Chassis		High Pressure Laminate Top High Pressure Laminate Chassis		Thermally Fused Laminate Top Thermally Fused Laminate Chassis	
		70 x 24 x 29	225	THQ7024CA125W	3702	"P" Option N/A	THQ7024CA125G	3205	THQ7024CA125M
58 x 24 x 29	195	THQ5824CA125W	3324	"P" Option N/A	THQ5824CA125G	2878	THQ5824CA125M	1851	
35 x 24 x 29	130	THQ3524CA125W	2060	"P" Option N/A	THQ3524CA125G	1784	THQ3524CA125M	1191	
29 x 24 x 29	115	THQ2924CA125W	1918	"P" Option N/A	THQ2924CA125G	1660	THQ2924CA125M	1109	

2 Select a finish View finish details	3 Select a edge View edge details	4 Select hardware View hardware details
WEC WAM WWP WSO	 Flat-1  Flat-2 (Black)  Flat-3 (White)	 PL-115 Matte Black PL-116 Matte Nickel  PL-210 Anodized Aluminum  PL-260 Anodized Aluminum PL-261 White
GEC GAM GWL	 Flat-1  Flat-2 (Black)  Flat-3 (White)	 PL-115 Matte Black PL-116 Matte Nickel  PL-210 Anodized Aluminum  PL-260 Anodized Aluminum PL-261 White
MEC MWL	 Flat-2 (Black)  Flat-3 (White)	 PL-115 Matte Black PL-116 Matte Nickel  PL-210 Anodized Aluminum  PL-260 Anodized Aluminum PL-261 White

Product features.

- Black adjustable shelf behind door set

NOTES

- "M" Styles have matching "M" Finish Shelf
- All units are standard w/ flush ends
- Unit not designed for open plan use, standard with unfinished back. Select OPB Option for Open Plan application.

Options.

DOOR

- D2: Wood Door Lock - \$100 per door set
- D6: Delete doors - n/c
- D6A: "W"/"G" Styles - Delete Doors and replace black laminate shelf with finished shelf - n/c
- D9SC: Soft Close Door Hinges - \$20 per door
- WPD3061: Designer White - \$80 per door

GROMMETS (STANDARD LOCATION)

Specify Color and Left/Right/Center - \$50 ea.

- Black: TM30-R (Right), TM30-L (Left), TM30-C (Center)
- Silver: TM31-R (Right), TM31-L (Left), TM31-C (Center)
- White: TM34-R (Right), TM34-L (Left), TM34-C (Center)

GROMMETS (NON-STANDARD LOCATION)

Provide drawing w/ Grommet Location and Specify Color - \$95 ea.

- Black: TM30-NS
- Silver: TM31-NS
- White: TM34-NS

GROMMETS (VERTICAL SURFACE)

Standard Location - \$50 ea.

- Black Plastic Vertical Surface: TM50-C (Bottom Center)

Non-Standard Location - \$95 ea.

- Black Plastic Vertical Surface: TM50-NS

OPEN PLAN – FINISHED BACK

- OPB: "W" "G" Style - Modify Unit for Open Plan Application - \$195
- OPB: "M" Style - Modify Unit for Open Plan Application - \$95

SHELF

- S25: Replace Black Laminate Shelf with Finished Shelf - \$80 per shelf ("W" styles only)

Thinking quietly.

Pedestals

Open Plan Mobile Desk Pedestal With Casters

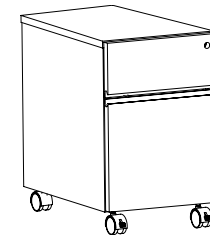

1 Select a model w" x d" x h" Box/File Pedestal 16 x 18 x 22	weight	Standard Veneer Top Standard Veneer Chassis		Premium Veneer Top Premium Veneer Chassis		High Pressure Laminate Top High Pressure Laminate Chassis		Thermally Fused Laminate Top Thermally Fused Laminate Chassis	
		55	THQ1618PD423W	1322	"P" Option N/A	"G" Option N/A	THQ1618PD423M	1016	

2 Select a finish View finish details	Standard Veneer Top		Premium Veneer Top		High Pressure Laminate Top		Thermally Fused Laminate Top	
	WEC WAM WWP WSO							MEC MWL

3 Select a edge View edge details	Standard Veneer Top		Premium Veneer Top		High Pressure Laminate Top		Thermally Fused Laminate Top	
	Edge N/A							Edge N/A

4 Select hardware View hardware details	Standard Veneer Top		Premium Veneer Top		High Pressure Laminate Top		Thermally Fused Laminate Top	

[View statement of line](#)

Product features.

- Anti-tilt safety feature
- Finished all sides and top - open plan
- Full extension drawers - locking
- 3" White hollow wheel caster

Options.

CUSHION

- BC16: Bench Cushion
- Specify fabric grade (1 yd. required)

DRAWER

- P33: Wood Drawer Upgrade - \$45 per drawer

BC16 Cushion fabric grades.

COM 224	COL N/A	1 261	2 279	3 297
4 315	5 333	6 351	7 369	8 387
9 405	10 423	11/ L1 441	12 459	13/ L2 495

Thinking quietly.

Pedestals

Open Plan Mini Mobile Desk Pedestal With Casters

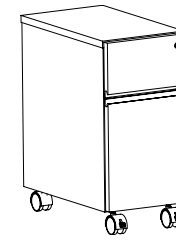

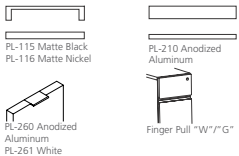
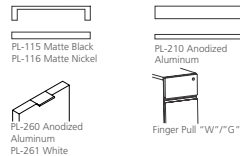
1 Select a model w" x d" x h"	weight	Standard Veneer Top Standard Veneer Chassis		Premium Veneer Top Premium Veneer Chassis		High Pressure Laminate Top High Pressure Laminate Chassis		Thermally Fused Laminate Top Thermally Fused Laminate Chassis	
		Box/File Mini Pedestal 10 x 18 x 22	40	THQ1018PD423W	1256	"P" Option N/A	"G" Option N/A		
2 Select a finish <i>View finish details</i>		WEC WAM WWP WSO						MEC MWL	
3 Select a edge <i>View edge details</i>		Edge N/A						Edge N/A	
4 Select hardware <i>View hardware details</i>									

View statement of line

Product features.

- Anti-tilt safety feature
- Finished all sides and top - open plan
- Full extension drawers - locking
- 3" White hollow wheel caster

Options.

- CUSHION**
- BC10: Bench Cushion
 - Specify fabric grade (.5 yd. required)

- DRAWER**
- P33: Wood Drawer Upgrade - \$45 per drawer

BC10 Cushion fabric grades.

COM	COL	1	2	3
203	N/A	240	258	276
4	5	6	7	8
294	312	330	348	366
9	10	11/ L1	12	13/ L2
384	402	420	438	474

Thinking quietly.

Screens

Central Freestanding Screen With Wood Posts

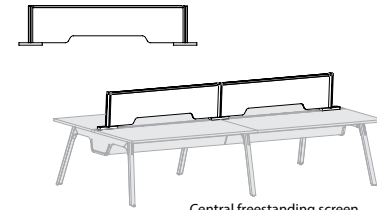

Central freestanding screen shown on 4 person workstation

[View statement of line](#)

1 Select a model	weight	Salted Oak Frame	
w" x d" x h"		Heather Gray	
6 Person Workstation/3 Central Screens			
216 x .5 x 15	80	THQ21615PS601	2610
198 x .5 x 15	70	THQ19815PS601	2545
180 x .5 x 15	60	THQ18015PS601	2479
162 x .5 x 15	50	THQ16215PS601	2414
4 Person Workstation/2 Central Screens			
144 x .5 x 15	65	THQ14415PS601	1868
132 x .5 x 15	55	THQ13215PS601	1813
120 x .5 x 15	45	THQ12015PS601	1759
108 x .5 x 15	35	THQ10815PS601	1704
2 Person Workstation/1 Central Screen			
72 x .5 x 15	50	THQ7215PS601	1152
66 x .5 x 15	40	THQ6615PS601	1125
60 x .5 x 15	30	THQ6015PS601	1097
54 x .5 x 15	20	THQ5415PS601	1070

2 Select a finish	Frame finish
View finish details	WSO
	WEC +10%
Metal finish	
MFG Gray (standard).	
Premium metal finishes available, see options.	

3 Select a edge	Edge
View edge details	N/A

4 Select acoustic color	
View hardware details	SHG
	SCG

Product features.

- Available for 2/4/6 Person workstations without Umbrella
- Made from sound absorbing acoustic material
- Wood posts finished in Salted Oak

Options.

PREMIUM FINISH

- WEC: Ebony finish on solid wood frame - 10% upcharge

PREMIUM METAL FINISH

- 6 Person Workstation
- MFGG: Graphite Gray - \$300
- 4 Person Workstation
- MFGG: Graphite Gray - \$240
- 2 Person Workstation
- MFGG: Graphite Gray - \$185

Thinking quietly.

Acrylic Screens

Central Freestanding Screen With Wood Posts

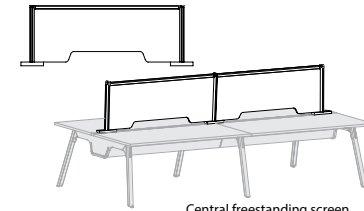

Central freestanding screen shown on 4 person workstation

[View statement of line](#)

1 Select a model w" x d" x h"	weight	Salted Oak Frame		Salted Oak Frame		Salted Oak Frame	
		Frosted Acrylic Screen		White Acrylic Screen		Black Acrylic Screen	
6 Person Workstation/3 Central Screens							
216 x .5 x 24	80	THQ21624PS597AF	3135	THQ21624PS597AW	2555	THQ21624PS597AB	2555
198 x .5 x 24	70	THQ19824PS597AF	3025	THQ19824PS597AW	2495	THQ19824PS597AB	2495
180 x .5 x 24	60	THQ18024PS597AF	2915	THQ18024PS597AW	2435	THQ18024PS597AB	2435
162 x .5 x 24	50	THQ16224PS597AF	2805	THQ16224PS597AW	2375	THQ16224PS597AB	2375
4 Person Workstation/2 Central Screens							
144 x .5 x 24	65	THQ14424PS597AF	2215	THQ14424PS597AW	1835	THQ14424PS597AB	1835
132 x .5 x 24	55	THQ13224PS597AF	2145	THQ13224PS597AW	1795	THQ13224PS597AB	1795
120 x .5 x 24	45	THQ12024PS597AF	2075	THQ12024PS597AW	1755	THQ12024PS597AB	1755
108 x .5 x 24	35	THQ10824PS597AF	2005	THQ10824PS597AW	1715	THQ10824PS597AB	1715
2 Person Workstation/1 Central Screen							
72 x .5 x 24	50	THQ7224PS597AF	1315	THQ7224PS597AW	1115	THQ7224PS597AB	1115
66 x .5 x 24	40	THQ6624PS597AF	1275	THQ6624PS597AW	1095	THQ6624PS597AB	1095
60 x .5 x 24	30	THQ6024PS597AF	1235	THQ6024PS597AW	1065	THQ6024PS597AB	1065
54 x .5 x 24	20	THQ5424PS597AF	1195	THQ5424PS597AW	1045	THQ5424PS597AB	1045
2 Select a finish		Frame finish		Frame finish		Frame finish	
View finish details		WSO		WSO		WSO	
Metal finish		WEC +10%		WEC +10%		WEC +10%	
MFG Gray (standard).							
Premium metal finishes available, see options.							
3 Select a edge		Edge		Edge		Edge	
View edge details		N/A		N/A		N/A	
4 Select acoustic color		Acoustic		Acoustic		Acoustic	
View hardware details		N/A		N/A		N/A	

Product features.

- Available for 2/4/6 Person workstations without Umbrella
- Available with frosted or white acrylic
- Wood posts finished in Salted Oak

Options.

PREMIUM FINISH

- WEC: Ebony finish on solid wood frame - 10% upcharge

PREMIUM METAL FINISH

- 6 Person Workstation
- MFGG: Graphite Gray - \$300
- 4 Person Workstation
- MFGG: Graphite Gray - \$240
- 2 Person Workstation
- MFGG: Graphite Gray - \$185

Thinking quietly.

Screens

Central Screen For Umbrella

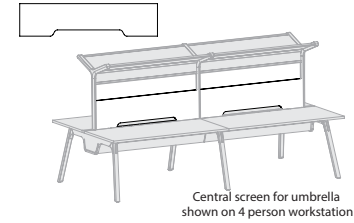

Central screen for umbrella shown on 4 person workstation

[View statement of line](#)

1	Select a model w" x d" x h"	weight	Heather Gray		
	Above Desk Umbrella Screen				
	72" Worksurface				
	66 x .5 x 12	6	CS7212	470	
	66" Worksurface				
	60 x .5 x 12	6	CS6612	448	
	60" Worksurface				
	54 x .5 x 12	5	CS6012	426	
	54" Worksurface				
	48 x .5 x 12	5	CS5412	405	
2	Select a finish View finish details		MFG		
	Metal finish MFG Gray (standard). Premium metal finishes available, see options.				
3	Select a edge View edge details		Edge N/A		
4	Select acoustic color View hardware details		SHG SCG		

Product features.

- Available for 2/4/6 Person workstations with Umbrella
- Made from sound absorbing acoustic material

NOTES

- Screen is for use with umbrella workstations only

PREMIUM METAL FINISH

- MFGG: Graphite Gray - \$185

Thinking quietly.
Acrylic Screens
Central Screen For Umbrella

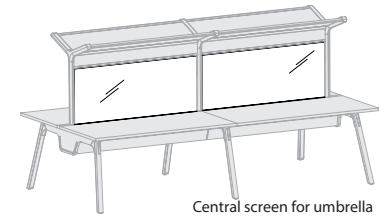

Central screen for umbrella
shown on 4 person workstation

[View statement of line](#)

1 Select a model w" x d" x h"		weight	Salted Oak Frame Frosted Acrylic Screen	Salted Oak Frame White Acrylic Screen	Salted Oak Frame Black Acrylic Screen
Above Desk Umbrella Screen					
72" Worksurface					
72 x .5 x 21	18	AS7221AF	655	AS7221AW	405
66 x .5 x 21	16	AS6621AF	620	AS6621AW	425
60 x .5 x 21	14	AS6021AF	585	AS6021AW	445
54 x .5 x 21	12	AS5421AF	550	AS5421AW	465
2 Select a finish View finish details			Frame finish WSO WEC +10%	Frame finish WSO WEC +10%	Frame finish WSO WEC +10%
Metal finish MFG Gray (standard). Premium metal finishes available, see options.					
3 Select a edge View edge details			Edge N/A	Edge N/A	Edge N/A
4 Select acoustic color View hardware details			Acoustic N/A	Acoustic N/A	Acoustic N/A

Product features.

- Available for 2/4/6 Person workstations with Umbrella
- Available with frosted or white acrylic

NOTES

- Screen is for use with umbrella workstations only
- Screens priced per screen

Options.

PREMIUM METAL FINISH

MFGG: Graphite Gray. Priced per screen - \$50

Thinking quietly.

Interpersonal Screen
Fabric Interpersonal Screen

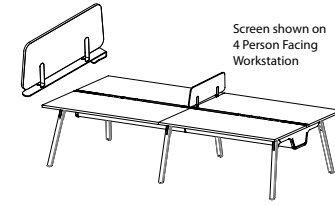

[View statement of line](#)

1	Select a model	Fabric Screen	weight	Graphite gray metal	THQ2413PS603	317
	w" x d" x h"					
	24 x .5 x 12.75		5			

2	Select a finish	MFG
	View finish details	
	Metal finish MFG Gray (standard). Premium metal finishes available, see options.	

3	Select a edge	Edge N/A
	View edge details	

4	Select hardware	Hardware N/A
	View hardware details	

Product features.

- Fabric panels are double sided with angled sides
- Panels are mounted on die cast space blocks between workstations
- Specify only one between two facing units
- Mounting brackets are gray metal finish (optional graphite gray)

NOTES

- Central Screens are not available in leather or vinyl

Options.

PREMIUM METAL FINISHES

- Specify Screen Brackets Metal Finish Color: \$55
- MFGG: Graphite Gray

Screen fabric grades.

COM	COL	1	2	3
313	N/A	353	373	393
4	5	6	7	8
413	433	453	473	493
9	10	11/ L1	12	13/ L2
513	533	553	573	613

Thinking quietly.
 Interpersonal Screen
Acrylic Interpersonal Screen

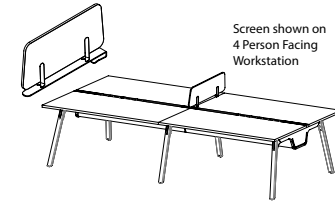

1	Select a model	weight	Acrylic Screen	
	w" x d" x h"		Graphite gray metal	
	24 x .5 x 12.75	5	THQ2413PS601	311

[View statement of line](#)

2	Select a finish	MFG
	View finish details	
<p>Metal finish MFG Gray (standard). Premium metal finishes available, see options.</p>		

3	Select a edge	Edge
	View edge details	N/A

4	Select hardware	Hardware
	View hardware details	N/A

Product features.

- Acrylic panels are double sided with angled sides
- Acrylic panels are opaque white
- Mounting brackets are gray metal finish (optional graphite gray)

Options.

PREMIUM METAL FINISHES

- Specify Screen Brackets Metal Finish Color: \$55
- MFGG: Graphite Gray

Thinking quietly.
 Interpersonal Screen
Acoustic Material Interpersonal Screen

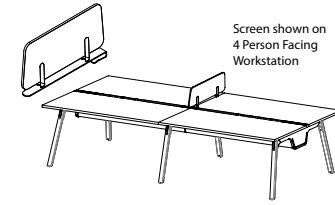

1	Select a model	weight	Acoustic Screen	
	w" x d" x h"		Graphite gray metal	
	24 x .5 x 12.75	5	THQ2413PS602	361

[View statement of line](#)

2	Select a finish	MFG
	View finish details	
<p>Metal finish MFG Gray (standard). Premium metal finishes available, see options.</p>		

3	Select a edge	Edge
	View edge details	N/A

4	Select acoustic color	SHG
	View hardware details	SCG

Product features.

- Acoustic panels are double sided with angled sides
- Panels are mounted on die cast space blocks between workstations
- Specify only one between two inline units
- Acoustic material panels are light gray
- Mounting brackets are gray metal finish (optional graphite gray)

Options.

PREMIUM METAL FINISHES

- Specify Screen Brackets Metal Finish Color: \$55
- MFGG: Graphite Gray

Thinking quietly.

Brief Screen
Brief Screen

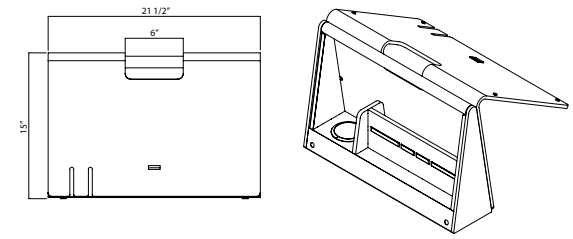

[View statement of line](#)

1	Select a model w" x d" x h"	weight	Salted Oak Frame	
			Heather Gray	
	21.5 x 6 x 15	10	BS2215N	1026

2	Select a finish View finish details	Frame finish
		WSO WEC +10%

3	Select a edge View edge details	Edge
		N/A

4	Select acoustic color View hardware details	SHG
		SCG

Product features.

- Solid Salted Oak Handle
- Grey metal finish frame faced with acoustical cover
- Area for organizing office supplies
- Leather pull tab w/ magnetic closure

NOTES

- Interpersonal privacy that functions as desk top organization
- Pencil holder standard

Options.

POWER

AirCharge offers a convenient way to charge any Qi compatible smartphone or device without the need to carry charging cables or find an available power outlet.

- ACWG: AirCharge Wireless Grommet - \$195

PREMIUM FINISH

- WEC: Ebony finish on solid wood frame - 10% upcharge

Thinking quietly.

Desk Pad
Desk Pad

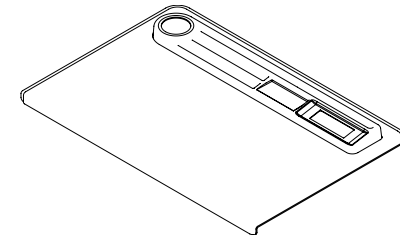

1 Select a model		weight			View statement of line	
w" x d" x h"			Desk Pad Heather Gray			
36 x 23.75		5	DP36	703		
2 Select a finish			Finish N/A			
			View finish details			
3 Select a edge			Edge N/A			
			View edge details			
4 Select acoustic color			SHG			
			View hardware details			

Product features.

- Light gray sound absorbing material
- Pen cup and tray in black
- Organizer tray and device storage in molded acoustical material

Options.

POWER BLOCK FOR DESK PAD

AirCharge offers a convenient way to charge any Qi compatible smartphone or device without the need to carry charging cables or find an available power outlet. Devices not equipped with the Qi technology, can be adapted to accept a charge with the AirCharge Wireless Receiver.

- ACWG: AirCharge Wireless Grommet (Black Aluminum) \$575
- ACWR: AirCharge Wireless Charging Receiver with Lightning Cable \$170

Thinking quietly.

Terrarium
Terrarium

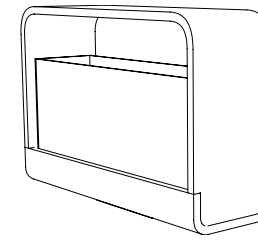

1 Select a model		weight	Salted Oak Frame		View statement of line		
w" x d" x h"							
18 x 12 x 6		5	THQ1812TR811W	410			
2 Select a finish			Frame finish				
	View finish details		WSO				
			WEC +10%				
3 Select a edge			Edge				
	View edge details		N/A				
4 Select hardware			Hardware				
	View hardware details		N/A				

Product features.

- Plywood wrap frame with flower basin insert
- Insert is clear acrylic material
- Flower basin insert is 16" x 8" x 4.5"

NOTES

- Terrarium is not water tight
- Mounts into infill block rail

Options.

PREMIUM FINISH

- WEC: Ebony finish on solid wood frame - 10% upcharge

Thinking quietly.

Workbay Typicals
C-Shape Workbay

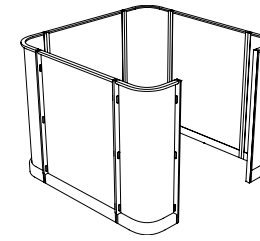

1 Select a model		Heather Gray	
w" x d" x h"	weight	Salted Oak Frame	
66.5 x 66.5 x 63	150	THQ6767CS920W	16751
82.25 x 66.5 x 63	160	THQ8267CS920W	17057
82.25 x 82.25 x 63	170	THQ8282CS920W	17669
98 x 82.5 x 63	190	THQ9882CS920W	19416
98 x 98 x 63	210	THQ9898CS920W	22910

[View statement of line](#)

2 Select a finish		Frame finish	
View finish details		WSO	
		WEC +10%	
Metal finish			
MFG Gray (standard), MFGG Graphite Gray (optional)			

3 Select a edge		Edge	
View edge details		N/A	

4 Select acoustic color		SHG	
View hardware details		SCG	

Product features.

- Solid wood frame in Salted Oak finish
- Hardware included
- Shipped KD
- Workbay provides sound absorption with its acoustic material composition

NOTES

- Workbay openings are based on total workbay width: 63" W unit (opening 30"), 78.75" W unit (opening 45.75"), 94.5" W unit (opening 61.5")

Options.

PREMIUM FINISH

- WEC: Ebony finish on solid wood frame - 10% upcharge

PREMIUM METAL FINISH

- MFGG: Graphite Gray - \$400

Thinking quietly.
Workbay Typical
S-Shape Workbay

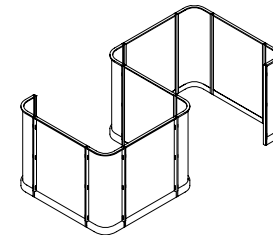

1 Select a model w" x d" x h"	weight	Heather Gray	
		Salted Oak Frame	
131.25 x 66.5 x 63	230	THQ13267SS920W	26023
163 x 66.5 x 63	250	THQ16367SS920W	26634
163 x 82.25 x 63	280	THQ16382SS920W	27552
194.5 x 82.25 x 63	300	THQ19482SS920W	31046
194.5 x 98 x 63	330	THQ19498SS920W	36288

[View statement of line](#)

2 Select a finish View finish details	Frame finish	
	Metal finish MFG Gray (standard), MFGG Graphite Gray (optional)	WSO

3 Select a edge View edge details	Edge	
		N/A

4 Select acoustic color View hardware details	SHG	
		SCG

Product features.

- Solid wood frame in Salted Oak finish
- Hardware included
- Shipped KD
- Workbay provides sound absorption with its acoustic material composition

NOTES

- Workbay openings are based on total workbay width: 63" W unit (opening 30"), 78.75" W unit (opening 45.75"), 94.5" W unit (opening 61.5")

Options.

PREMIUM FINISH

- WEC: Ebony finish on solid wood frame - 10% upcharge

PREMIUM METAL FINISH

- MFGG: Graphite Gray - \$800

Thinking quietly.

Workbay Typicals

C-Shape Workbay with Worksurface

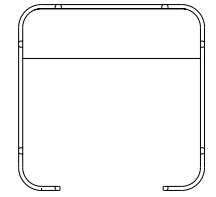
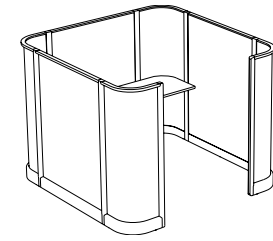

DARRAN

1 Select a model

w" x d" x h"	weight	Standard Veneer Top Salted Oak Frame/Heather Gray	Premium Veneer Top Salted Oak Frame/Heather Gray
66.5 x 66.5 x 63	150	THQ6767CS910W 18951	"P" Option N/A
82.25 x 66.5 x 63	150	THQ8267CS910W 19457	"P" Option N/A
82.25 x 82.25 x 63	170	THQ8282CS910W 20069	"P" Option N/A
98 x 82.5 x 63	190	THQ9882CS910W 22031	"P" Option N/A
98 x 98 x 63	210	THQ9898CS910W 25526	"P" Option N/A

2 Select a finish

[View finish details](#)

Metal finish
MFG Gray (standard),
MFGG Graphite Gray
(optional)

Top finish	Frame finish
WEC	WSO
WAM	WEC +10%
WWP	

3 Select a edge

[View edge details](#)



4 Select acoustic color

[View hardware details](#)

SHG
SCG

[View statement of line](#)

High Pressure Laminate Top Salted Oak Frame/Heather Gray		Thermally Fused Laminate Top Salted Oak Frame/Heather Gray	
THQ6767CS910G	18640	THQ6767CS910M	18370
THQ8267CS910G	19124	THQ8267CS910M	18793
THQ8282CS910G	19735	THQ8282CS910M	19404
THQ9882CS910G	21673	THQ9882CS910M	21277
THQ9898CS910G	25167	THQ9898CS910M	24772

Top finish	Frame finish
GEC	WSO
GAM	WEC +10%
GWL	

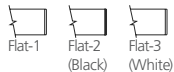

SHG
SCG

Top finish	Frame finish
MEC	WSO
MWL	WEC +10%

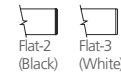

SHG
SCG

Product features.

- Solid wood frame in Salted Oak finish
- Hardware included
- Shipped KD
- Workbay provides sound absorption with its acoustic material composition
- 1" thick worksurface tops

NOTES

- Workbay openings are based on total workbay width: 63" W unit (opening 30"), 78.75" W unit (opening 45.75"), 94.5" W unit (opening 61.5")

Options.

GROMMETS (STANDARD LOCATION)

- Center - \$50 ea.
- Black: TM30-R (Right), TM30-L (Left)
- Silver: TM31-R (Right), TM31-L (Left)
- White: TM34-C (Center)

PREMIUM FINISH

- WEC: Ebony finish on solid wood frame - 10% upcharge

PREMIUM METAL FINISH

- MFGG: Graphite Gray - \$400

POWER

- PD-KENO: Keno powered with clamp - \$195 ea.
- PD-TULLY: Tully power pod with clamp - \$320 ea.
- SCD: Soba wire management - \$200

Thinking quietly.

Workbay Typicals
S-Shape Workbay with Worksurface

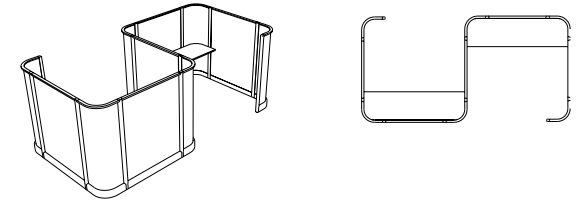

1 Select a model w" x d" x h"	weight	Standard Veneer Top Salted Oak Frame/Heather Gray		Premium Veneer Top Salted Oak Frame/Heather Gray		High Pressure Laminate Top Salted Oak Frame/Heather Gray		Thermally Fused Laminate Top Salted Oak Frame/Heather Gray	
		131.25 x 66.5 x 63	230	THQ13267SS910W	28430	"P" Option N/A	THQ13267SS910G	27912	THQ13267SS910M
163 x 66.5 x 63	230	THQ16367SS910W	29042	"P" Option N/A	THQ16367SS910G	28523	THQ16367SS910M	28253	
163 x 82.25 x 63	280	THQ16382SS910W	30160	"P" Option N/A	THQ16382SS910G	29618	THQ16382SS910M	29287	
194.5 x 82.25 x 63	300	THQ19482SS910W	33654	"P" Option N/A	THQ19482SS910G	33113	THQ19482SS910M	32782	
194.5 x 98 x 63	330	THQ19498SS910W	39111	"P" Option N/A	THQ19498SS910G	38544	THQ19498SS910M	38149	

2 Select a finish View finish details Metal finish MFG Gray (standard), MFGG Graphite Gray (optional)	Top finish		Frame finish		Top finish	Frame finish	Top finish	Frame finish
	WEC WAM WWP	WEC	WSO	WEC +10%				

3 Select an edge View edge details	Flat-1 Flat-2 (Black) Flat-3 (White)			Flat-1 Flat-2 (Black) Flat-3 (White)			Flat-2 (Black) Flat-3 (White)	
	SHG SCG	SHG SCG	SHG SCG	SHG SCG	SHG SCG	SHG SCG	SHG SCG	SHG SCG

4 Select acoustic color View hardware details	SHG SCG		SHG SCG		SHG SCG	
	SHG SCG	SHG SCG	SHG SCG	SHG SCG	SHG SCG	SHG SCG

[View statement of line](#)

Product features.

- Solid wood frame in Salted Oak finish
- Hardware included
- Shipped KD
- Workbay provides sound absorption with its acoustic material composition
- 1" thick worksurface tops

NOTES

- Workbay openings are based on total workbay width: 63" W unit (opening 30"), 78.75" W unit (opening 45.75"), 94.5" W unit (opening 61.5")

Options.

GROMMETS (STANDARD LOCATION)

- Center - \$50 ea.
- Black: TM30-R (Right), TM30-L (Left)
- Silver: TM31-R (Right), TM31-L (Left)
- White: TM34-C (Center)

PREMIUM FINISH

- WEC: Ebony finish on solid wood frame - 10% upcharge

PREMIUM METAL FINISH

- MFGG: Graphite Gray - \$800

POWER

- PD-KENO: Keno powered with clamp - \$195 ea.
- PD-TULLY: Tully power pod with clamp - \$320 ea.
- SCD: Soba wire management - \$200

Thinking quietly.

Workbay Typicals
Zig-Zag Workbay

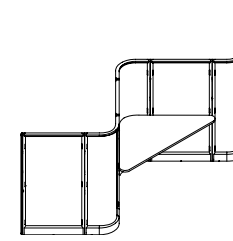

[View statement of line](#)

1 Select a model w" x d" x h"	weight	Standard Veneer Top		Premium Veneer Top	High Pressure Laminate Top		Thermally Fused Laminate Top	
		Salted Oak Frame/Heather Gray		Salted Oak Frame/Heather Gray	Salted Oak Frame/Heather Gray		Salted Oak Frame/Heather Gray	
1 Person Workbay 36 x 70.5 x 63	150	THQ7036ZS920W	8469	"P" Option N/A	THQ7036ZS920G	8326	THQ7036ZS920M	8103
2 Person Workbay 41 x 119 x 63	270	THQ11941ZS920W	14317	"P" Option N/A	THQ11941ZS920G	14033	THQ11941ZS920M	13584
3 Person Workbay 41 x 162 x 63	390	THQ16241ZS920W	20164	"P" Option N/A	THQ16241ZS920G	19738	THQ16241ZS920M	19066
4 Person Workbay 41 x 210 x 63	510	THQ21041ZS920W	26011	"P" Option N/A	THQ21041ZS920G	25444	THQ21041ZS920M	24548
2 Select a finish View finish details Metal finish MFG Gray (standard), MFGG Graphite Gray (optional)	Top finish	Frame finish		Top finish	Frame finish	Top finish	Frame finish	
	WEC WAM WWP	WSO WEC +10%		GEC GAM GWL	WSO WEC +10%	MEC MWL	WSO WEC +10%	
3 Select a edge View edge details	Flat-1	Flat-2 (Black)	Flat-3 (White)	Flat-1	Flat-2 (Black)	Flat-3 (White)	Flat-2 (Black)	Flat-3 (White)
4 Select acoustic color View hardware details	SHG		SHG		SHG		SHG	
	SCG		SCG		SCG		SCG	

Product features.

- Solid wood frame in Salted Oak finish
- Hardware included
- Shipped KD
- Workbay provides sound absorption with its acoustic material composition

Options.

GROMMETS (STANDARD LOCATION)

- Center - \$50 ea.
- Black: TM30-R (Right), TM30-L (Left)
- Silver: TM31-R (Right), TM31-L (Left)
- White: TM34-C (Center)

PREMIUM FINISH

- WEC: Ebony finish on solid wood frame - 10% upcharge

PREMIUM METAL FINISH

- MFGG: Graphite Gray - \$1020

POWER

- PD-KENO: Keno powered with clamp - \$195 ea.
- PD-TULLY: Tully power pod with clamp - \$320 ea.
- SCD: Soba wire management - \$200

Thinking quietly.

Workbay Modular

Wall Corner Outside And Inside Skirting

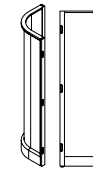

Outside Skirting
OC918

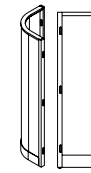

Inside Skirting
IC918

[View statement of line](#)

1 Select a model	weight	Heather Gray		
w" x d" x h"		Salted Oak Frame		
Outside Skirting				
17.75 x 17.75 x 63	20	THQ1863OC918W	2582	
Inside Skirting				
17.75 x 17.75 x 63	20	THQ1863IC918W	2582	

2 Select a finish	Frame finish
View finish details	WSO
	WEC +10%
Metal finish	
MFG Gray (standard), MFGG Graphite Gray (optional)	

3 Select a edge	Edge
View edge details	N/A

4 Select acoustic color	SHG	SCG
View hardware details		

Product features.

- Solid wood frame in Salted Oak finish
- Hardware included
- Panel provides sound absorption with its acoustic material composition

Options.

PREMIUM FINISH

- WEC: Ebony finish on solid wood frame - 10% upcharge

PREMIUM METAL FINISH

- MFGG: Graphite Gray - \$75

Thinking quietly.
 Workbay Modular
 Straight Workbay Wall



1 Select a model

w" x d" x h"	weight	Heather Gray	Salted Oak Frame
31.5 x 1.75 x 63	20	THQ3263SW919W	2053
47.25 x 1.75 x 63	30	THQ4863SW919W	2359

[View statement of line](#)

2 Select a finish

Frame finish
WSO
WEC +10%

[View finish details](#)

Metal finish
 MFG Gray (standard),
 MFGG Graphite Gray (optional)

3 Select a edge

Edge
N/A

[View edge details](#)

4 Select acoustic color

SHG	SCG

[View hardware details](#)

Product features.

- Solid wood frame in Salted Oak finish
- Hardware included
- Panel provides sound absorption with its acoustic material composition

Options.

PREMIUM FINISH

- WEC: Ebony finish on solid wood frame - 10% upcharge

PREMIUM METAL FINISH

- MFGG: Graphite Gray - \$75

Thinking quietly.
Workbay Modular
End Cap



1 Select a model	weight	Heather Gray	
w" x d" x h"		Salted Oak Frame	
1.75 x .75 x 62.5	5	ECAP01	131

[View statement of line](#)

Product features.

- Solid Salted Oak

Options.

PREMIUM FINISH

- WEC: Ebony finish on solid wood frame - 10% upcharge

2 Select a finish	Frame finish
View finish details	WSO
	WEC +10%

3 Select a edge	Edge
View edge details	N/A

4 Select hardware	Hardware
View hardware details	N/A

Thinking quietly.
Meeting Space
Stationary Cone

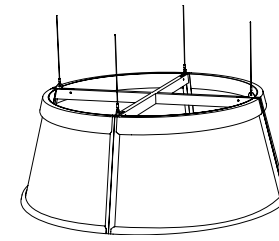

[View statement of line](#)

1 Select a model	weight	Heather Gray	Salted Oak Frame
w" x d" x h" DIA 82.5 x 32	100	THQ7932CO730W	15496

2 Select a finish	Frame finish
View finish details	WSO
Metal finish MFG Gray (standard), MFGG Graphite Gray (optional)	WEC +10%

3 Select a edge	Edge
View edge details	N/A

4 Select acoustic color	SHG	SCG
View hardware details		

Product features.

- Cone is acoustically beneficial with its material composition.
- Solid wood frame in Salted Oak finish
- Hardware included
- Shipped KD in subassemblies

Options.

PREMIUM FINISH

- WEC: Ebony finish on solid wood frame - 10% upcharge

PREMIUM METAL FINISH

- MFGG: Graphite Gray - \$125

Thinking quietly.
Meeting Space
Adjustable Cone

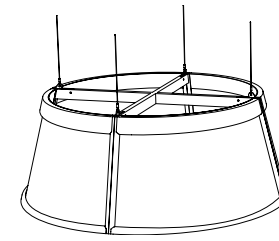

[View statement of line](#)

1 Select a model w" x d" x h" DIA 82.5 x 32	weight 100	Heather Gray	THQ7932CO731W	15933
		Salted Oak Frame		

2 Select a finish View finish details Metal finish MFG Gray (standard). Premium metal finishes available, see options.	Frame finish
	WSO WEC +10%

3 Select a edge View edge details	Edge
	N/A

4 Select acoustic color View hardware details	SHG
	SCG

Product features.

- Cone is acoustically beneficial with its material composition.
- Solid wood frame in Salted Oak finish
- Hardware included
- Shipped KD in subassemblies
- 4 handles included

NOTES

- Must be installed by a structural engineer
- Recommended installation height 5' above ground

Options.

PREMIUM FINISH

- WEC: Ebony finish on solid wood frame - 10% upcharge

PREMIUM METAL FINISH

- MFGG: Graphite Gray - \$125

Thinking quietly.

Conference Tables
Round Top With Frame



1 Select a model w" x d" x h"	weight	Standard Veneer Top Salted Oak Frame		Premium Veneer Top Salted Oak Frame		High Pressure Laminate Top Salted Oak Frame		Thermally Fused Laminate Top Salted Oak Frame				
		Sitting Height				"P" Option N/A						
60 DIA x 29	150	THQ6060RD121W	4184	"P" Option N/A	THQ6060RD121G	3857	THQ6060RD121M	3397				
54 DIA x 29	140	THQ5454RD121W	3947	"P" Option N/A	THQ5454RD121G	3696	THQ5454RD121M	3331				
48 DIA x 29	130	THQ4848RD121W	2671	"P" Option N/A	THQ4848RD121G	2416	THQ4848RD121M	2022				
42 DIA x 29	120	THQ4242RD121W	2638	"P" Option N/A	THQ4242RD121G	2392	THQ4242RD121M	1985				
36 DIA x 29	110	THQ3636RD121W	2607	"P" Option N/A	THQ3636RD121G	2368	THQ3636RD121M	1938				
Standing Height				"P" Option N/A								
48 DIA x 42	145	THQ4848RD141W	2874	"P" Option N/A	THQ4848RD141G	2620	THQ4848RD141M	2225				
42 DIA x 42	135	THQ4242RD141W	2841	"P" Option N/A	THQ4242RD141G	2596	THQ4242RD141M	2189				
36 DIA x 42	125	THQ3636RD141W	2811	"P" Option N/A	THQ3636RD141G	2572	THQ3636RD141M	2141				
2 Select a finish <i>View finish details</i>	Top finish	Frame finish		Top finish		Frame finish		Top finish		Frame finish		
	WEC	WSO		GEC		WSO		MEC		WSO		
	WAM	WEC +10%		GAM		WEC +10%		MWL		WEC +10%		
	WWP WSO			GWL								
3 Select a edge <i>View edge details</i>	Flat-1		Flat-2 (Black)		Flat-3 (White)		Flat-1		Flat-2 (Black)		Flat-3 (White)	
4 Select hardware <i>View hardware details</i>	Hardware		Hardware		Hardware		Hardware		Hardware		Hardware	
	N/A		N/A		N/A		N/A		N/A		N/A	

View statement of line

Product features.

- 1" Thick top
- ENVI-CT Finish on wood tops
- Base is Solid Salted Oak with Lofty Ash inserts
- Top attaches to metal frame rail

Options.

PREMIUM FINISH

- WEC: Ebony finish on solid wood frame - 10% upcharge

Thinking quietly.

Conference Tables
Square Top With Frame

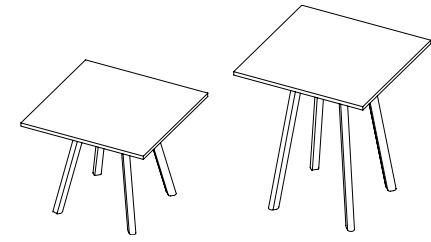

[View statement of line](#)

1 Select a model w" x d" x h"	weight	Standard Veneer Top Salted Oak Frame		Premium Veneer Top Salted Oak Frame		High Pressure Laminate Top Salted Oak Frame		Thermally Fused Laminate Top Salted Oak Frame	
Sitting Height				"P" Option N/A					
60 x 60 x 29	155	THQ6060SQ121W	4184	"P" Option N/A	THQ6060SQ121G	3857	THQ6060SQ121M	3397	
54 x 54 x 29	145	THQ5454SQ121W	3947	"P" Option N/A	THQ5454SQ121G	3696	THQ5454SQ121M	3331	
48 x 48 x 29	135	THQ4848SQ121W	2671	"P" Option N/A	THQ4848SQ121G	2422	THQ4848SQ121M	2022	
42 x 42 x 29	125	THQ4242SQ121W	2638	"P" Option N/A	THQ4242SQ121G	2392	THQ4242SQ121M	1985	
36 x 36 x 29	115	THQ3636SQ121W	2607	"P" Option N/A	THQ3636SQ121G	2368	THQ3636SQ121M	1938	
Standing Height				"P" Option N/A					
48 x 48 x 42	150	THQ4848SQ141W	2874	"P" Option N/A	THQ4848SQ141G	2625	THQ4848SQ141M	2225	
42 x 42 x 42	140	THQ4242SQ141W	2841	"P" Option N/A	THQ4242SQ141G	2596	THQ4242SQ141M	2189	
36 x 36 x 42	130	THQ3636SQ141W	2811	"P" Option N/A	THQ3636SQ141G	2572	THQ3636SQ141M	2141	
2 Select a finish View finish details		Top finish	Frame finish		Top finish	Frame finish	Top finish	Frame finish	
		WEC	WSO		GEC	WSO	MEC	WSO	
		WAM	WEC +10%		GAM	WEC +10%	MWL	WEC +10%	
		WWP			GWL				
		WSO							
3 Select a edge View edge details									
		Flat-1	Flat-2 (Black)	Flat-3 (White)	Flat-1	Flat-2 (Black)	Flat-3 (White)	Flat-2 (Black)	Flat-3 (White)
4 Select hardware View hardware details		Hardware			Hardware		Hardware		
		N/A			N/A		N/A		

Product features.

- 1" Thick top
- ENVI-CT Finish on wood tops
- Base is Solid Salted Oak with Lofty Ash inserts
- Top attaches to metal frame rail

Options.

PREMIUM FINISH

- WEC: Ebony finish on solid wood frame - 10% upcharge

Thinking quietly.

Conference Tables
Rectangle - 36" Depth

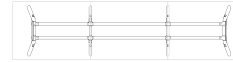

1 Select a model w" x d" x h"	weight	Standard Veneer Top Salted Oak Frame		Premium Veneer Top Salted Oak Frame		High Pressure Laminate Top Salted Oak Frame		Thermally Fused Laminate Top Salted Oak Frame	
		3 Piece Top							
240 x 36 x 29	315	THQ24036RE123W	9486	"P" Option N/A		THQ24036RE123G	8617	THQ24036RE123M	7552
216 x 36 x 29	290	THQ21636RE123W	9164	"P" Option N/A		THQ21636RE123G	8361	THQ21636RE123M	7457
198 x 36 x 29	265	THQ19836RE123W	8148	"P" Option N/A		THQ19836RE123G	7535	THQ19836RE123M	6715
2 Piece Top									
168 x 36 x 29	240	THQ16836RE122W	6581	"P" Option N/A		THQ16836RE122G	6022	THQ16836RE122M	5340
144 x 36 x 29	215	THQ14436RE122W	6317	"P" Option N/A		THQ14436RE122G	5806	THQ14436RE122M	5269
120 x 36 x 29	190	THQ12036RE122W	6054	"P" Option N/A		THQ12036RE122G	5591	THQ12036RE122M	5197
1 Piece Top									
96 x 36 x 29	165	THQ9636RE121W	4096	"P" Option N/A		THQ9636RE121G	3792	THQ9636RE121M	3366
84 x 36 x 29	155	THQ8436RE121W	3983	"P" Option N/A		THQ8436RE121G	3696	THQ8436RE121M	3331
72 x 36 x 29	145	THQ7236RE121W	3869	"P" Option N/A		THQ7236RE121G	3606	THQ7236RE121M	3295
2 Select a finish View finish details		Top finish	Frame finish			Top finish	Frame finish	Top finish	Frame finish
Metal finish MFG Gray (standard). Premium metal finishes available, see options.		WEC	WSO			GEC	WSO	MEC	WSO
		WAM	WEC +10%			GAM	WEC +10%	MWL	WEC +10%
		WWP				GWL			
		WSO							
3 Select a edge View edge details		Flat-1 Flat-2 (Black) Flat-3 (White)		Flat-1 Flat-2 (Black) Flat-3 (White)		Flat-2 (Black) Flat-3 (White)			
4 Select hardware View hardware details		Hardware N/A		Hardware N/A		Hardware N/A		Hardware N/A	

[View statement of line](#)

Product features.

- 1" Thick top
- ENVI-CT Finish on wood tops
- Base is Solid Salted Oak with Lofty Ash inserts
- Grey metal finish frame standard
- Top attaches to metal frame rail

NOTES

- 72"-96" Width Tops have 4 Legs
- 120"-168" Wood Tops have 6 Legs
- 198"-240" Wood Tops have 8 Legs

Options.

POWER

- Two pods mounted under the hinged seamless grommet. Each pod has 4 power and 2 data ports. Telecom connectors sold separately.
- PSG82-C: Plug with 124" cord (8 power, 2 telecom plates) - \$1875 each
 - W21: Grey Wire Manager (10.5") - \$35 ea.

PREMIUM FINISH

- WEC: Ebony finish on solid wood frame - 10% upcharge

PREMIUM METAL FINISH

- One Piece Top
- MFGG: Graphite Gray - \$575
- Two Piece Top
- MFGG: Graphite Gray - \$850
- Three Piece Top
- MFGG: Graphite Gray - \$1200

Thinking quietly.

Conference Tables
Rectangle - 42" Depth



1 Select a model w" x d" x h"	weight	Standard Veneer Top Salted Oak Frame		Premium Veneer Top Salted Oak Frame		High Pressure Laminate Top Salted Oak Frame		Thermally Fused Laminate Top Salted Oak Frame	
3 Piece Top									
240 x 42 x 29	345	THQ24042RE123W	10070	"P" Option N/A		THQ24042RE123G	9090	THQ24042RE123M	7672
216 x 42 x 29	320	THQ21642RE123W	9705	"P" Option N/A		THQ21642RE123G	8796	THQ21642RE123M	7565
198 x 42 x 29	295	THQ19842RE123W	8538	"P" Option N/A		THQ19842RE123G	7852	THQ19842RE123M	6811
2 Piece Top									
168 x 42 x 29	270	THQ16842RE122W	6964	"P" Option N/A		THQ16842RE122G	6327	THQ16842RE122M	5424
144 x 42 x 29	235	THQ14442RE122W	6700	"P" Option N/A		THQ14442RE122G	6117	THQ14442RE122M	5340
120 x 42 x 29	210	THQ12042RE122W	6432	"P" Option N/A		THQ12042RE122G	5897	THQ12042RE122M	5256
1 Piece Top									
96 x 42 x 29	185	THQ9642RE121W	4309	"P" Option N/A		THQ9642RE121G	3959	THQ9642RE121M	3457
84 x 42 x 29	170	THQ8442RE121W	4184	"P" Option N/A		THQ8442RE121G	3857	THQ8442RE121M	3397
72 x 42 x 29	160	THQ7242RE121W	4058	"P" Option N/A		THQ7242RE121G	3755	THQ7242RE121M	3331

2 Select a finish <i>View finish details</i>	Top finish		Frame finish		Top finish	Frame finish		Top finish	Frame finish	
Metal finish MFG Gray (standard), MFGG Graphite Gray (optional)	WEC	WSO			GEC	WSO		MEC	WSO	
	WAM	WEC +10%			GAM	WEC +10%		MWL	WEC +10%	
	WWP				GWL					
	WSO									

3 Select an edge <i>View edge details</i>	Standard Veneer Top			Premium Veneer Top			High Pressure Laminate Top			Thermally Fused Laminate Top		
	Flat-1	Flat-2 (Black)	Flat-3 (White)	Flat-1	Flat-2 (Black)	Flat-3 (White)	Flat-1	Flat-2 (Black)	Flat-3 (White)	Flat-2 (Black)	Flat-3 (White)	

4 Select hardware <i>View hardware details</i>	Standard Veneer Top		Premium Veneer Top		High Pressure Laminate Top		Thermally Fused Laminate Top	
	Hardware	N/A	Hardware	N/A	Hardware	N/A	Hardware	N/A

View statement of line

Product features.

- 1" Thick top
- ENVI-CT Finish on wood tops
- Base is Solid Salted Oak with Lofty Ash inserts
- Grey metal finish frame standard
- Top attaches to metal frame rail

NOTES

- 72"-96" Width Tops have 4 Legs
- 120"-168" Wood Tops have 6 Legs
- 198"-240" Wood Tops have 8 Legs

Options.

POWER

Two pods mounted under the hinged seamless grommet. Each pod has 4 power and 2 data ports. Telecom connectors sold separately.
 - PSG82-C: Plug with 124" cord (8 power, 2 telecom plates) - \$1875 each
 - W21: Grey Wire Manager (10.5") - \$35 ea.

PREMIUM FINISH

- WEC: Ebony finish on solid wood frame - 10% upcharge

PREMIUM METAL FINISH

One Piece Top
 - MFGG: Graphite Gray - \$575
 Two Piece Top
 - MFGG: Graphite Gray - \$850
 Three Piece Top
 -MFGG: Graphite Gray - \$1200

Thinking quietly.

Conference Tables
Rectangle - 48" Depth

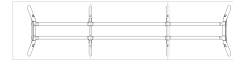

[View statement of line](#)

1 Select a model w" x d" x h"	weight	Standard Veneer Top Salted Oak Frame		Premium Veneer Top Salted Oak Frame		High Pressure Laminate Top Salted Oak Frame		Thermally Fused Laminate Top Salted Oak Frame	
		3 Piece Top 240 x 48 x 29 216 x 48 x 29 198 x 48 x 29 2 Piece Top 168 x 48 x 29 144 x 48 x 29 120 x 48 x 29 1 Piece Top 96 x 48 x 29 84 x 48 x 29 72 x 48 x 29							
		THQ24048RE123W	10773	"P" Option N/A	THQ24048RE123G	9657	THQ24048RE123M	7792	
		THQ21648RE123W	10358	"P" Option N/A	THQ21648RE123G	9323	THQ21648RE123W	7672	
		THQ19848RE123W	9027	"P" Option N/A	THQ19848RE123G	8246	THQ19848RE123M	6841	
		THQ16848RE122W	7422	"P" Option N/A	THQ16848RE122G	6698	THQ16848RE122M	5442	
		THQ14448RE122W	7121	"P" Option N/A	THQ14448RE122G	6458	THQ14448RE122M	5347	
		THQ12048RE122W	6814	"P" Option N/A	THQ12048RE122G	6208	THQ12048RE122M	5316	
		THQ9648RE121W	4560	"P" Option N/A	THQ9648RE121G	4162	THQ9648RE121M	3505	
		THQ8448RE121W	4416	"P" Option N/A	THQ8448RE121G	4049	THQ8448RE121M	3438	
		THQ7248RE121W	4271	"P" Option N/A	THQ7248RE121G	3935	THQ7248RE121M	3366	
2 Select a finish View finish details		Top finish	Frame finish		Top finish	Frame finish	Top finish	Frame finish	
		WEC	WSO		GEC	WSO	MEC	WSO	
		WAM	WEC +10%		GAM	WEC +10%	MWL	WEC +10%	
		WWP			GWL				
		WSO							
Metal finish MFG Gray (standard), MFGG Graphite Gray (optional)									
3 Select a edge View edge details		Flat-1	Flat-2 (Black)	Flat-3 (White)	Flat-1	Flat-2 (Black)	Flat-3 (White)	Flat-2 (Black)	Flat-3 (White)
4 Select hardware View hardware details		Hardware N/A			Hardware N/A		Hardware N/A		

Product features.

- 1" Thick top
- ENVI-CT Finish on wood tops
- Base is Solid Salted Oak with Lofty Ash inserts
- Grey metal finish frame standard

NOTES

- 72"-96" Width Tops have 4 Legs
- 120"-168" Wood Tops have 6 Legs
- 198"-240" Wood Tops have 8 Legs

Options.

POWER

- Two pods mounted under the hinged seamless grommet. Each pod has 4 power and 2 data ports. Telecom connectors sold separately.
- PSG82-C: Plug with 124" cord (8 power, 2 telecom plates) - \$1875 each
 - W21: Grey Wire Manager (10.5") - \$35 ea.

PREMIUM FINISH

- WEC: Ebony finish on solid wood frame - 10% upcharge

PREMIUM METAL FINISH







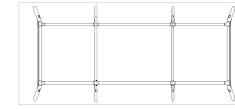

- One Piece Top
- MFGG: Graphite Gray - \$575
- Two Piece Top
- MFGG: Graphite Gray - \$850
- Three Piece Top
- MFGG: Graphite Gray - \$1200

Thinking quietly.

Conference Tables
Rectangle - 54" Depth



[View statement of line](#)

1 Select a model w" x d" x h"	weight	Standard Veneer Top Salted Oak Frame		Premium Veneer Top Salted Oak Frame		High Pressure Laminate Top Salted Oak Frame		Thermally Fused Laminate Top Salted Oak Frame	
		3 Piece Top 240 x 54 x 29 216 x 54 x 29 198 x 54 x 29 2 Piece Top 168 x 54 x 29 144 x 54 x 29 120 x 54 x 29	410 380 350 325 290 255	THQ24054RE123W THQ21654RE123W THQ19854RE123W THQ16854RE122W THQ14454RE122W THQ12054RE122W	11678 11208 9694 8034 7694 7342	"P" Option N/A "P" Option N/A "P" Option N/A "P" Option N/A "P" Option N/A "P" Option N/A	THQ24054RE123G THQ21654RE123G THQ19854RE123G THQ16854RE122G THQ14454RE122G THQ12054RE122G	10411 10035 8809 7212 6937 6656	THQ24054RE123M THQ21654RE123M THQ19854RE123M THQ16854RE122M THQ14454RE122M THQ12054RE122M
2 Select a finish View finish details Metal finish MFG Gray (standard), MFGG Graphite Gray (optional)	Top finish WEC WAM WWP WSO	Frame finish WSO WEC +10%			Top finish GEC GAM GWL	Frame finish WSO WEC +10%	Top finish MEC MWL	Frame finish WSO WEC +10%	
3 Select a edge View edge details	 Flat-1  Flat-2 (Black)  Flat-3 (White)				 Flat-1  Flat-2 (Black)  Flat-3 (White)		 Flat-2 (Black)  Flat-3 (White)		
4 Select hardware View hardware details	Hardware N/A				Hardware N/A		Hardware N/A		

Product features.

- 1" Thick top
- ENVI-CT Finish on wood tops
- Base is Solid Salted Oak with Lofty Ash inserts
- Grey metal finish frame standard

NOTES

- 120"-168" Wood Tops have 6 Legs
- 198"-240" Wood Tops have 8 Legs

Options.

POWER

- Two pods mounted under the hinged seamless grommet. Each pod has 4 power and 2 data ports. Telecom connectors sold separately.
- PSG82-C: Plug with 124" cord (8 power, 2 telecom plates) - \$1875 each
 - W21: Grey Wire Manager (10.5") - \$35 ea.

PREMIUM FINISH

- WEC: Ebony finish on solid wood frame - 10% upcharge

PREMIUM METAL FINISH

- One Piece Top
- MFGG: Graphite Gray - \$575
- Two Piece Top
- MFGG: Graphite Gray - \$850
- Three Piece Top
- MFGG: Graphite Gray - \$1200

Thinking quietly.

Conference Tables
Rectangle - 60" Depth

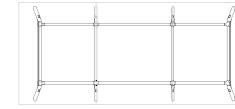

[View statement of line](#)

1 Select a model w" x d" x h"	weight	Standard Veneer Top Salted Oak Frame		Premium Veneer Top Salted Oak Frame		High Pressure Laminate Top Salted Oak Frame		Thermally Fused Laminate Top Salted Oak Frame	
		3 Piece Top 240 x 60 x 29 216 x 60 x 29 198 x 60 x 29 2 Piece Top 168 x 60 x 29 144 x 60 x 29 120 x 60 x 29	465 420 375 320 310 265	THQ24060RE123W THQ21660RE123W THQ19860RE123W THQ16860RE122W THQ14460RE122W THQ12060RE122W	12582 12048 10328 8624 8235 7832	"P" Option N/A "P" Option N/A "P" Option N/A "P" Option N/A "P" Option N/A "P" Option N/A	THQ24060RE123G THQ21660RE123G THQ19860RE123G THQ16860RE122G THQ14460RE122G THQ12060RE122G	11147 10716 9323 7691 7374 7050	THQ24060RE123M THQ21660RE123M THQ19860RE123M THQ16860RE122M THQ14460RE122M THQ12060RE122M
2 Select a finish View finish details Metal finish MFG Gray (standard), MFGG Graphite Gray (optional)	Top finish WEC WAM WWP WSO	Frame finish WSO WEC +10%			Top finish GEC GAM GWL	Frame finish WSO WEC +10%	Top finish MEC MWL	Frame finish WSO WEC +10%	
3 Select a edge View edge details	Flat-1 Flat-2 (Black) Flat-3 (White)				Flat-1 Flat-2 (Black) Flat-3 (White)		Flat-2 (Black) Flat-3 (White)		
4 Select hardware View hardware details	Hardware N/A				Hardware N/A		Hardware N/A		

Product features.

- 1" Thick top
- ENVI-CT Finish on wood tops
- Base is Solid Salted Oak with Lofty Ash inserts
- Grey metal finish frame standard

NOTES

- 120"-168" Wood Tops have 6 Legs
- 198"-240" Wood Tops have 8 Legs

Options.

POWER

- Two pods mounted under the hinged seamless grommet. Each pod has 4 power and 2 data ports. Telecom connectors sold separately.
- PSG82-C: Plug with 124" cord (8 power, 2 telecom plates) - \$1875 each
 - W21: Grey Wire Manager (10.5") - \$35 ea.

PREMIUM FINISH

- WEC: Ebony finish on solid wood frame - 10% upcharge

PREMIUM METAL FINISH

- One Piece Top
- MFGG: Graphite Gray - \$575
- Two Piece Top
- MFGG: Graphite Gray - \$850
- Three Piece Top
- MFGG: Graphite Gray - \$1200

Thinking quietly.

Full Pedestal Credenzas
 Conferencing Storage Credenza

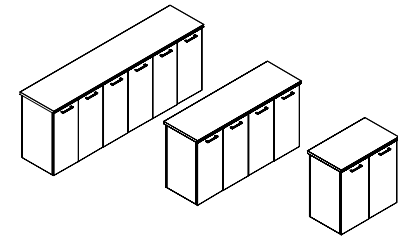

[View statement of line](#)

1 Select a model w" x d" x h"	weight	Standard Veneer Top Standard Veneer Chassis		Premium Veneer Top Premium Veneer Chassis		High Pressure Laminate Top High Pressure Laminate Chassis		Thermally Fused Laminate Top Thermally Fused Laminate Chassis	
		Triple Storage 93 x 24 x 36 87 x 24 x 36	390 340	THQ9324CA124W THQ8724CA124W	6715 6574	"P" Option N/A "P" Option N/A		THQ9324CA124G THQ8724CA124G	5814 5691
Double Storage 70 x 24 x 36 64 x 24 x 36 58 x 24 x 36 47 x 24 x 36	290 260 245 200	THQ7024CA124W THQ6424CA124W THQ5824CA124W THQ4724CA124W	4681 4523 4316 4052	"P" Option N/A "P" Option N/A "P" Option N/A "P" Option N/A		THQ7024CA124G THQ6424CA124G THQ5824CA124G THQ4724CA124G	4053 3917 3781 3508	THQ7024CA124M THQ6424CA124M THQ5824CA124M THQ4724CA124M	2670 2621 2572 2473
Single Storage 35 x 24 x 36 29 x 24 x 36	150 135	THQ3524CA124W THQ2924CA124W	2633 2477	"P" Option N/A "P" Option N/A		THQ3524CA124G THQ2924CA124G	2280 2144	THQ3524CA124M THQ2924CA124M	1453 1409

2 Select a finish View finish details	3 Select an edge View edge details	4 Select hardware View hardware details
WEC WAM WWP WSO	Flat-1 Flat-2 (Black) Flat-3 (White)	PL-115 Matte Black PL-116 Matte Nickel PL-210 Anodized Aluminum PL-260 Anodized Aluminum PL-261 White
GEC GAM GWL	Flat-1 Flat-2 (Black) Flat-3 (White)	PL-115 Matte Black PL-116 Matte Nickel PL-210 Anodized Aluminum PL-260 Anodized Aluminum PL-261 White
MEC MWL	Flat-2 (Black) Flat-3 (White)	PL-115 Matte Black PL-116 Matte Nickel PL-210 Anodized Aluminum PL-260 Anodized Aluminum PL-261 White

Product features.

- Adjustable glides
- "M" styles shelves match finish
- "W"/"G" styles have black adjustable shelf behind door set

NOTES

- All units are std with flush ends

Options.

ACCESSORIES

- REF-01: Modify Storage section for refrigerator - \$205

AUDIO VISUAL/BACK PANEL WALL ACCESS

- AVR1: AV Exhaust Fan - \$470
- AVR2: AV Pullout Rack - \$1655
- M19: 2 Heat vent/cord access slots in back - \$ 160

DOOR

- D2: Wood Door Lock - \$100 per door set
- D6: Delete doors - n/c
- D6A: "W"/"G" Styles - Delete Doors and replace black laminate shelf with finished shelf - n/c

GROMMETS (STANDARD LOCATION)

Specify Color and Left/Right/Center - \$50 ea.

- Black: TM30-R (Right), TM30-L (Left), TM30-C (Center)
- Silver: TM31-R (Right), TM31-L (Left), TM31-C (Center)
- White: TM34-R (Right), TM34-L (Left), TM34-C (Center)

GROMMETS (NON-STANDARD LOCATION)

Provide drawing w/ Grommet Location and Specify Color - \$95 ea.

- Black: TM30-NS
- Silver: TM31-NS
- White: TM34-NS

GROMMETS (VERTICAL SURFACE)

Standard Location - \$50 ea.

- Black Plastic Vertical Surface: TM50-C (Bottom Center)

Non-Standard Location - \$95 ea.

- Black Plastic Vertical Surface: TM50-NS

OPEN PLAN – FINISHED BACK

- OPB: "W" "G" Style - Modify Unit for Open Plan Application - \$195

- OPB: "M" Style - Modify Unit for Open Plan Application - \$95

SHELF

- S25: Replace Black Laminate Shelf with Finished Shelf - \$80 per shelf

TRASH CAN

- TRC50: EZ Cargo 50 dual trash can - (1) 8 gallon and (1) 5 gallon - \$680

Thinking Quietly options.



COMPUTER SUPPORT
single monitor arm

Style Number	List Price
MA1	280

Specifications

- Available in black or silver
- Desk clamp and mounting included
- Easy assembly and flexibility
- Elastic painting process for a durable and beautiful finish
- Gas spring tension adjustment for counter-balance height adjustment for monitors 1-8 KG
- Gas spring tested to 50,000 repetitions
- Hidden cable management



COMPUTER SUPPORT
double monitor arm

Style Number	List Price
MA2	450

Specifications

- Available in black or silver
- Desk clamp and mounting included
- Easy assembly and flexibility
- Elastic painting process for a durable and beautiful finish
- Gas spring tension adjustment for counter-balance height adjustment for monitors 1-8 KG
- Gas spring tested to 50,000 repetitions
- Hidden cable management



COMPUTER SUPPORT
triple monitor arm

Style Number	List Price
MA3	530

Specifications

- Available in black or silver
- Desk clamp and mounting included
- Easy assembly and flexibility
- Elastic painting process for a durable and beautiful finish
- Gas spring tension adjustment for counter-balance height adjustment for monitors 1-8 KG
- Gas spring tested to 50,000 repetitions
- Hidden cable management



COMPUTER SUPPORT
quadruple monitor arm

Style Number	List Price
MA4	705

Specifications

- Available in black
- Desk clamp and mounting included
- Easy assembly and flexibility
- Elastic painting process for a durable and beautiful finish
- Gas spring tension adjustment for counter-balance height adjustment for monitors 1-8 KG
- Gas spring tested to 50,000 repetitions
- Hidden cable management

Thinking Quietly options.

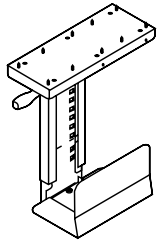

COMPUTER SUPPORT
cpu retractable cradle

Style Number	List Price
K18	205

Specifications

- Black Metal CPU Carriage
- Full 360° swivel capability allows easy access to rear of CPU for cables / wires
- Track allows 8- 1/2" extension
- Width Adjustment 5-1/2" to 9-1/4"
- Height adjustment 14- 5/8" to 20- 1/2"
- Black epoxy finish

Notes
- Factory Installed



DOOR MODIFICATIONS
soft close door hinge

Style Number	List Price
D9SC	20 Per door

Specifications

- Snap onto standard door hinge
- Requires (2) per door
- Max door height 43"
- Factory installed where specified
- Individually shipped for field installation

Notes
- Specify Each Item To Have Slow Close Feature

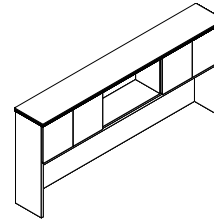

DOOR MODIFICATIONS
delete doors

Style Number	List Price
D6	N/C

Specifications

- Standard Door overheads and cabinets can have door deleted for open access. Modification of hinge rails and structural components are made face ready.

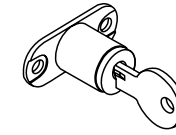

DOOR MODIFICATIONS
panel door lock

Style Number	List Price
D2	100 Per door set

Specifications

- Door Locks - 1 Door w/ Lock, Other Door w/ Catch Latch
- Contact Customer Service regarding limited lock locations and keying.

Notes
- Available on: Panel Doors, Wood Frame Doors, and Silverluma doors

Thinking Quietly options.

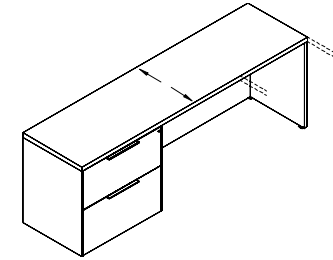
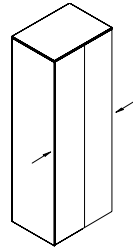
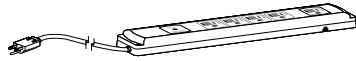

POWER / DATA *power supply cordset*

Style Number	List Price
PD717	100

Specifications

- SIZE: 10.75"L x 2.0"W x 1.06"H
- (5) Outlets w/ 10' cord
- Surge suppression (720 Joules)
- 15 Amp breaker
- Available on: Vertical Panels, Cabinet Interiors, and under tops

PRODUCT MODIFICATIONS *modify width - open/closed storage*

Style Number	List Price
MOD-2	250

Specifications

- Modify width down on any unit with open or closed storage section: storage credenzas

PRODUCT MODIFICATIONS *modify width - outside of mod-1, mod-2*

Style Number	List Price
MOD-3	Contact for pricing

Specifications

- Width modification outside of MOD-1 & MOD-2

PRODUCT MODIFICATIONS *modify depth - increase depth*

Style Number	List Price
MOD-6	Add 10%

Specifications

- Increase depth by no more than 6"

Notes

- Ex. 24" to 30", 30" to 36", and 36" to 42"
- Add 10% to the unit you want to increase the depth of by no more than 6"

Thinking Quietly options.

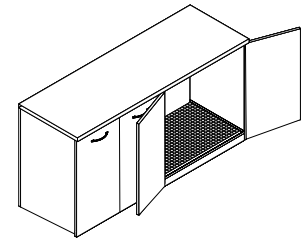

PRODUCT MODIFICATIONS
modify height

Style Number	List Price
MOD-7	Contact for pricing

Specifications
- Modify height of a unit

PRODUCT MODIFICATIONS
modify conference table length and width - 1 piece top

Style Number	List Price
MOD-8	125

Specifications
- Modify length/width on a 1 piece table top

PRODUCT MODIFICATIONS
modify conference table length and width - 2/3 piece top

Style Number	List Price
MOD-9	250

Specifications
- Modify length/width on a 2 or 3 piece table top

REFRIGERATOR MODIFICATION
refrigerator cabinet modification

Style Number	List Price
REF01	205

Specifications
 - Open back cutout for venting
 - Moisture sponge mat
 - Contaminate ledge
 - Contact customer service for maximum refrigerator size (Changes based on unit).
 - Available on: 36" and 42" Storage Credenzas

Thinking Quietly options.

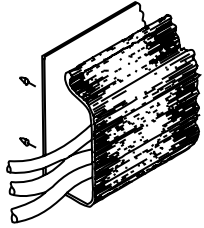

WIRE MANAGEMENT
horizontal j-channel wire management raceway

Style Number	List Price
W1	80 Per 4' section

Specifications

- 4' section for field installation.
- The "J" shape black thermoplastic wire raceway may be added to specified worksurface tops to provide concealed channeling of wires to and from worksurface grommets. For use in open kneespace areas, raceway is attachable to top of back panel with pan head screws. Interior dimensions are 1" x 1- 1/2" providing ample storage for multiple wires and excess cable. Front of raceway flexes out for easy cord insertion.

- Notes
- Units w/ Wire Channel Standard.
 - Field Installation

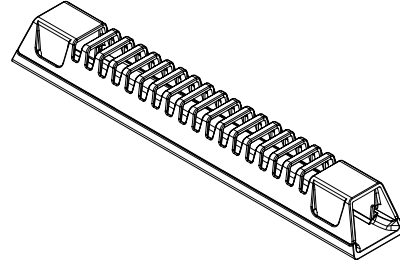

WIRE MANAGEMENT
horizontal wire management raceway

Style Number	List Price
W21	35

Specifications

- 10"W x 1.5"D x 1.25"H
- Grey Wire Manager (10.5")
- Power and data cables can be discretely housed and managed with the W21 Gray Wire Manager. This can be mounted in any location to metal frame or underside of conference tables and runs cables through a 1" channel from power module to hollow steel legs. This keeps cables organized under the table top. Release clips make it simple to snap on and off the Wire Manager for easy organization and access after attached to the table

- Notes
- Field installed

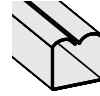

WIRE MANAGEMENT
horizontal u-channel wire management raceway

Style Number	List Price
W2A	80 Per 4' section

Specifications

- 4' section for field installation.
- Notes
- Units w/ Wire Channel Standard.
 - Field Installation



WIRE MANAGEMENT
coil wire manager

Style Number	List Price
W18	160

Specifications

- Weighted Base, Table attachment plate
 - 39- 1/2" Length
 - Black
- Notes
- Location

Thinking Quietly options.

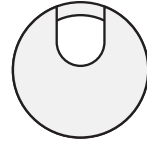
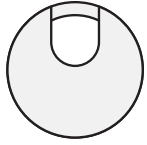

WIRE MANAGEMENT

standard location grommets - factory installed

Style Number	List Price
Standard Location Grommet	
Black	
TM30	50
Silver	
TM31	50
Antique Brass	
TM33	50
White	
TM34	50

Specifications

- 1 -5/8" Metal Grommet

Notes

- *Units w/ Grommets Standard Are Noted Under Standard Features. Grommets Match Pull Finish - Standard (Unless Specified Otherwise)

WIRE MANAGEMENT

non-standard location grommets - factory installed

Style Number	List Price
Non-Standard Location Grommet	
Black	
TM30 -NS	95
Silver	
TM31 -NS	95
Antique Brass	
TM33 -NS	95
White	
TM34 -NS	95

Specifications

- 1 -5/8" Metal Grommet

Notes

- *Units w/ Grommets Standard Are Noted Under Standard Features. Grommets Match Pull Finish - Standard (Unless Specified Otherwise)

WIRE MANAGEMENT

black plastic vertical surface grommets - factory installed

Style Number	List Price
Standard Location Grommet	
TM50-C	50
Non-Standard Location Grommet	
TM50-NS	95

Specifications

- 2 " Black Plastic Grommet

Notes

- Standard Location is Bottom Center

power & data options.

Aircharge wireless charging grommet

Style Number	List Price
 ACWG WIRELESS GROMMET	\$195

Specifications

- › When used with GROVE Tables an additional \$350 LIST will apply for the special cutout required.
- › AirCharge offers a convenient way to charge any Qi compatible smartphone or device without the need to carry charging cables or find an available power outlet.
- › The Aircharge is powered by the latest Qi compliant IC offering reliable and efficient wireless charging in a convenient 3" grommet hub. Simply place your phone on the Aircharge and an LED will confirm pairing and begin wireless charging.
- › Recess: Efficient space conservation and quick access
- › Input: DC 5V (with included AC power adapter), DC 9V, 1.67A (with optional QC 2.0 power adapter)
- › Output: 5 watts Max. with DC 5V, 2A power adapter, 10 watts Max. with QC 2.0 power adapter
- › Qi V1.2 compliant IC
- › Charging distance: 6mm Max.

Available: All DARRAN collections



power & data options.

Cove power unit - non-linking

Style Number

List Price



PD-COVE PLUG

\$550

Non-linking version

Specifications

- › Size 5.75" L x 2.5" W
- › (2) 15 Amp Receptacles and (2) USB charging ports
- › Surface Mount
- › 108" Cord
- › Standard Silver Finish, Available in White or Black Finish upon request
- › ETL Listed

Available: All DARRAN collections



power & data options.

Cove power unit with daisylink

Style Number	List Price
--------------	------------

STARTER UNITS



COV-DCH HARDWIRED	\$710
-------------------	-------

Includes (1) Cove unit with Hardwire Infeed
- 120"



COV-DCP PLUG	\$800
--------------	-------

Includes (1) Cove unit with Plug infeed -
Includes 72" Cord and 32" Infeed Jumper for
104" total cord infeed

ADDITIONAL LINKING UNITS

COV-DCL	\$575 EACH
---------	------------

Includes Linking Cove unit and Jumper up to
96", cable length determined by the top size

Specifications

- › Size: 5.75"L x 2.5"W
- › (2) 15 Amp Receptacles and (2) 2.1 Amp USB charging ports
- › Surface Mount
- › Max Daisy Chain - Hardwire - (9) units; Plug/Corded - (4) units
- › Standard Silver Finish, Available in White or Black Finish upon request
- › ETL Listed

Available: All DARRAN collections



power & data options.

Cove corded series

Style Number	List Price
 PD-COVE-PKO	\$800

Specifications

- > Size 9.5" L x 2.5" W x 3.18" D
- > When used with GROVE Tables an additional \$350 LIST will apply for the special cutout required.
- > (2) Power Receptacles, (2) 2.1 Amp USB charging ports and (1) Telecom Plate Knockout
- > Surface Mount
- > 108" Cord
- > Standard Silver Finish, Available in White or Black Finish upon request
- > ETL Listed

Available: All DARRAN collections

Telecom Plates

RJ45 (1)	\$35
RJ45 (2)	\$70
RJ45 (3)	\$105
USB (1)	\$70
USB (2)	\$140
RJ11/RJ45	\$70
RJ45/USB	\$105
RJ45/HDMI	\$190
HDMI/DVI	\$325
HDMI/USB	\$205
HDMI/VGA	\$240
VGA/MINI-STEREO	\$155
VGA/USB	\$175

This pod can have up to 1 total plates.
 *All telecom connectors sold separately.



power & data options.

Dual

Style Number	List Price
STARTER UNITS	
PD-DUAL3P3J	\$1170
3 modules; 3' jumpers	
PD-DUAL3P6J	\$1185
3 modules; 6' jumpers	
PD-DUAL3P12J	\$1200
3 modules; 12' jumpers	
PD-DUAL4P3J	\$1450
4 modules; 3' jumpers	
PD-DUAL4P6J	\$1470
4 modules; 6' jumpers	
PD-DUAL4P12J	\$1490
4 modules; 12' jumpers	
PD-DUAL8P3J	\$2825
8 modules; 3' jumpers	
PD-DUAL8P6J	\$2865
8 modules; 6' jumpers	
PD-DUAL8P12J	\$2905
8 modules; 12' jumpers	

Specifications

- > Size: 3" x 1.75" x 1.25"
- > (2) 2.4 Amp USB charging ports per module
- > Undersurface mount
- > 72" cord
- > Standard black finish, available in white upon request
- > UL certified

Available: Conference, Milner, Thinking quietly

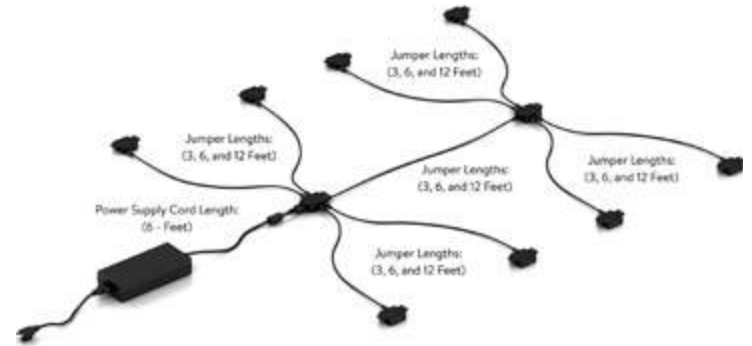

power & data options.

Keno power unit

Style Number

List Price



PD-KENO

\$195

Select power block to link workstations

Specifications

- > Size 5.5" L x 2.125" W x 2.5" H
- > 2 TR AC Outlets
- > 1 4.2A USB module w/ 2 charging ports
- > 10' Power cord

Available: EdgeWorks, NSS Open, Rail, Rail Open Office, ThinkingQuietly

Telecom Plates

With 120" hardwire power cord.

Two Pack Power Block System: 2PPBS	\$390
Four Pack Power Block System: 4PPBS	\$750
Six Pack Power Block System: 6PPBS	\$1100



White



Black

power & data options.

Reef power unit with daisylink

Style Number	List Price
 REF310 PLUG	\$1100

Specifications

- > Size 16.1"L x 6.25"W x 4.89"D
- > When used with GROVE Tables an additional \$350 LIST will apply for the special cutout required.
- > (3) 120V Receptacles, (2) USB charging ports, 1 Data Plate Knockout, (2) Knockouts for RJ45 Data Ports
- > Surface Mount
- > 108" Cord
- > Features Convenience Plug on bottom of unit that allows for max (3) Daisy Chain
- > Standard Black Finish, Available in White or Silver Finish upon request
- > Additional Telecom Plate Knockout
- > RJ45 for Knockouts not required. If not ordered a small hole will be present in the pod in this this location
- > ETL Listed

Available: Conferencing

Telecom Plates

RJ45 (1)	\$35
RJ45 (2)	\$70
RJ45 (3)	\$105
USB (1)	\$70
USB (2)	\$140
RJ11/RJ45	\$70
RJ45/USB	\$105
RJ45/HDMI	\$190
HDMI/DVI	\$325
HDMI/USB	\$205
HDMI/VGA	\$240
VGA/MINI-STEREO	\$155
VGA/USB	\$175

This pod can have up to 1 total plates.
*All telecom connectors sold separately.

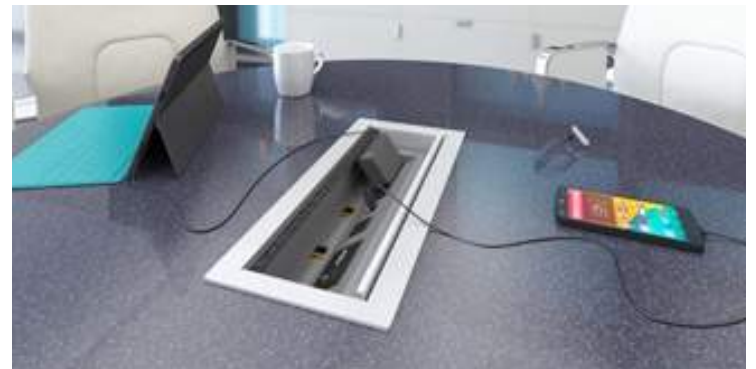

power & data options.

Powered seamless grommet

Style Number	List Price
	
Power/Plug	
PSG82-C: PLUG	\$1875

Specifications

- › Grommet comes with 2 Power Pods that are mounted under the Seamless Grommet. Pods daisylink together with (2) innerconnecting cables.
- › Size: 11.5" L x 8.25W"
- › (4) Power Receptacles per power pod, 8 total
- › 124" Power cord
- › Standard Black Finish
- › UL Listed
- › (2) 2.1 Dual USB ports per pod, 4 total
- › (2) Data ports per pod, 4 total

Available: Thinking quietly, Diva, EdgeWorks

Telecom Plates	
RJ45 (1)	\$35
RJ45 (2)	\$70
RJ45/HDMI	\$190
HDMI/VGA	\$240
RJ45/VGA	\$190

This pod can have up to 1 total plates.
*All telecom connectors sold separately.



power & data options.

Seclusion corded power unit non-linking

Style Number	List Price
 P2SECL	\$245
Choose from plate mount or clamp mount (seen in photo)	

Specifications

- > Size: 3.5"L x 2.2"D x 2.5"H
- > (2) Power Receptacles
- > Worksurface Clamp Mount or Plate Under Surface Mount
- > Clamp Accessory accommodates table thickness up to 2"
- > 72" Cord
- > Standard Silver Finish, Black Finish available upon request
- > UL/UCL Listed

Available: All DARRAN collections



Clamp Mount

power & data options.

Soba wire manager

Style Number	List Price
STARTER UNITS	
SCDW	\$200
White wire manager	
SCDB	\$200
Black wire manager	

Specifications

- › Dimensions: 9ft x 9in x 3.15in
- › Zips up, bundles and routes loose, messy cables into a single tube
- › Routes and guides cables behind desks, TVs, and anywhere cables tend to get messy
- › Accommodates large or small cables, up to three cables at once
- › Support channels, used to route cables, include powerful adhesive backing which allows easy attachment to surfaces.

Available: All DARRAN collections



power & data options.

Tully power unit

Style Number	List Price
 PD-TULLY	\$320
Select power block to link workstations	

Specifications

- › 5.5" W x 3.2" H x 1.81" D
- › Finish: Smooth molded plastic integrated within a single piece cover
- › Mounts to the edge of your work surface, with no table cut outs or installation required.
- › (2) Power receptacles, (2) USB 2.1 Amp ports
- › 72" Cord (10' cord available, contact customer service).
- › Standard in White. Available in gray, black, neon red, harvest pumpkin, light green, daisy blue.
- › UL310, Class 2, FCC Part 15A approved
- › Clamp accessory accomodates table thickness from .75"-1.5"

Available: EdgeWorks, NSS Open, Rail, Rail Open Office, Thinking quietly.

Power Block

With 120" hardwire power cord.

Two Pack Power Block System: 2PPBS	\$390
Four Pack Power Block System: 4PPBS	\$750
Six Pack Power Block System: 6PPBS	\$1100

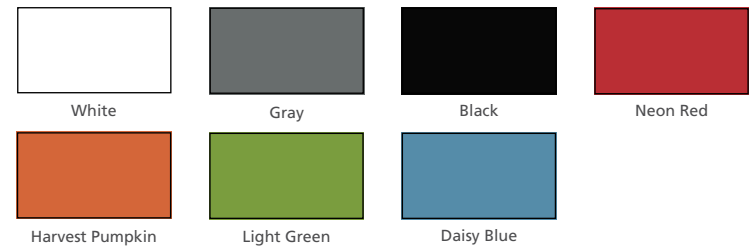

power & data options.

Tully data power unit

Style Number List Price



PD-TULLY-DATA \$400

Select power block to link workstations

Specifications

- › 5.5" W x 3.2" H x 1.81" D
- › Finish: Smooth molded plastic integrated within a single piece cover
- › Mounts to the edge of your work surface, with no table cut outs or installation required.
- › (2) Power receptacles, (2) knockouts for HDMI, VGA, or RJ45 (Please specify).
- › 72" Cord (10' cord available, contact customer service).
- › Standard in White. Available in gray, black, neon red, harvest pumpkin, light green, daisy blue.
- › UL310, Class 2, FCC Part 15A approved
- › Clamp accessory accommodates table thickness from .75"-1.5"
- › Includes 2 wire management grommets

Available: Bota booth table

Power Block

With 120" hardwire power cord.

Two Pack Power Block System 2PPBS	\$390
Four Pack Power Block System 4PPBS	\$750
Six Pack Power Block System 6PPBS	\$1100

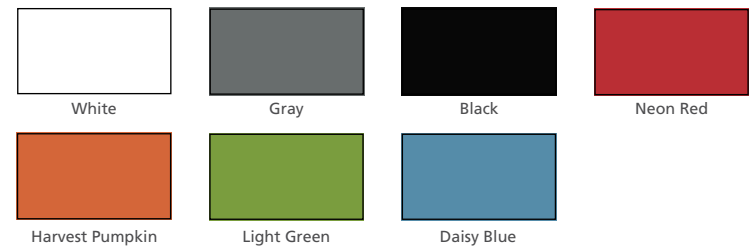

power & data options.

VILLA Power unit - non-linking

Style Number	List Price
VIL-C PLUG Non-Linking	\$515

Specifications

- › Size: Top Grommet 5.68" L X 3.39"W; Under Top 12"L x 3.13"W x 3.08"D
- › (2) Power receptacles; (2) USB charging ports and (1) Knockouts for RJ45 Data Ports
- › Surface Mount
- › 72" Cord (Longer cord available, contact Customer Service)
- › Standard Silver Finish, Black Finish available upon request
- › UL or ETL Certified

Available: All DARRAN collections, excludes Grove

RJ45 Knockout RJ45 (1)	\$35
---------------------------	------

