

EFFECTIVE FEB 2018 UPDATED JULY 2018



# Boss.

price list

DATE	PAGE	MODIFICATION	DESCRIPTION
2.1.18	All	Added Finish	Added WBW Henna Walnut finish

**TABLE OF CONTENTS**

Product index ..... 2  
 General Information ..... 3  
 Limited Lifetime Warranty ..... 4  
 Damages | Returns | Reparis ..... 5  
 Ordering Information ..... 6  
 GSA Customer Information ..... 7  
 Freight..... 8  
 Features & Advantages ..... 9  
 Specifications..... 11  
 Edges | Pulls | Knobs..... 12  
 Grommets | Grommet Reference ..... 13  
 Modesty Reference | Grain Direction..... 14  
 Drawer Dimensions | FILING Reference ..... 15  
 Conferencing Credenzas..... 16  
 Boat Conference Tables ..... 19  
 Table Frames..... 22  
 Options ..... 23  
 Power and Data..... 28

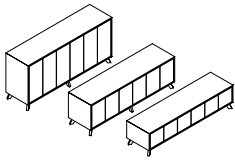

PAGE 16  
CONFERCING CREDENZAS

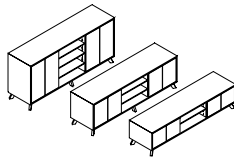

PAGE 17  
CONFERCING CREDENZAS

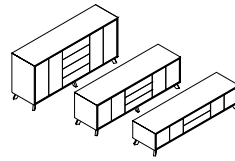

PAGE 18  
CONFERCING CREDENZAS

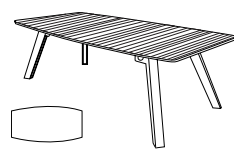

PAGE 19  
BOAT CONFERENCE TABLES

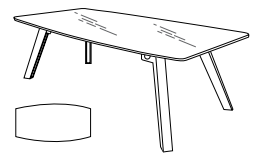

PAGE 20  
BOAT CONFERENCE TABLES

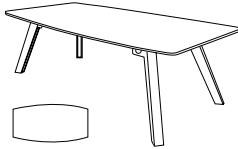

PAGE 21  
BOAT CONFERENCE TABLES

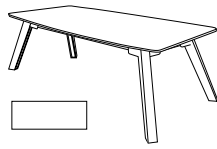

PAGE 22  
TABLE FRAME



All DARRAN products are proudly manufactured in the U.S.A.

**BUILT TO ORDER**

Manufactured per order the way you want it, including modifications.

**FULLY ASSEMBLED**

Unless otherwise noted, all products are fully assembled and ready to use, including add-on options.

**PERFORMANCE TESTED**

All products are tested to ensure performance exceeds BIFMA / ANSI standards.



**FINISH TECHNOLOGY**

DARRAN has continued its partnership with AkzoNobel Chemicals ([www.akzonobel.com](http://www.akzonobel.com)) to develop a new finish technology further improving indoor air quality with a coating that meets today's environmental standards and supports LEED buildings.

ENVI-CT (Environmental Coatings Technology) utilizes advanced European finish technology to deliver a high-end furniture coating with superior performance in appearance and durability, allowing DARRAN to deliver more sustainable products to our customers.

*ENVI-CT Advantages:*

- › ENVI-CT is a re-engineered high performance Urethane Top Coat
- › Exceptional hardness and clarity
- › Highly resistant to solvents and chemicals
- › Plasticizer Migration resistant
- › Excellent UV inhibitors for maximum color resistance
- › Exceeds current and proposed future Federal and State air quality requirements
- › Field Repairable
- › Dynamic chamber emissions tested and certified compliant to ANSI/BIFMA X 7.1 Standard / LEED 4.5 Standard for low – VOC emitting furniture.

**ADVANTAGES**

DARRAN collaborated with the world's leader in finishing materials, to formulate an additive that will inhibit the growth of mold, mildew, fungus and bacteria on wood surfaces. This additive infuses Silver Ions into DARRAN's ENVI-CT (Environmental Urethane Finish Technology), creating a protective surface for the life of the furniture. The best part - is standard on all DARRAN Caseloads for no additional fee.

## LIMITED LIFETIME WARRANTY

DARRAN Furniture Industries, Inc. ("DARRAN") warrants that each piece of furniture manufactured in its North Carolina Facilities will be free from defects in material and workmanship for as long as the original purchaser owns and uses the product. Subject to the limitations and exclusions herein, DARRAN, at its discretion and as the sole remedy under the DARRAN Limited Lifetime Warranty, will replace or repair a defective product or components with comparable product or components free of charge. This warranty is made only to the original purchaser from an authorized DARRAN dealer, for as long as that original purchaser owns and uses the product.

## LIMITATIONS: USE / CARE

- › Warranty is limited to normal single shift use.
- › Warranty is limited to generally accepted care and maintenance of natural wood products and environments.
- › Natural wood surfaces are subject to denting, scratching, and gauging if not properly used and cared for. Warranty is subject to use and care in accordance with the use and care instructions provided in the Product Care section of this site (including, but not limited to, the care and maintenance guide downloads linked thereon), available at [www.darran.com/product-care](http://www.darran.com/product-care), which are incorporated herein by reference.

## LIMITATIONS: MATERIALS / COMPONENTS

- › Laminates, Veneers / Finishes - 10 Years
- › Electrical lamps, Ballasts, Transformers - 3 Years
- › Fabrics, Pneumatic lifts, Foam - 5 Years
- › Custom products built to customers specifications - 3 Years

## WARRANTY EXCLUSIONS

*Damage identified as carrier or installer related.*

- › Normal wear and tear of wood products during course of ownership.
- › Color, grain, or texture of natural wood materials, laminates, and other covering materials.
- › Damages or failures resulting from misuse, abuse, negligence, improper care, modifications, or relocation.
- › Non Commercial use or locations.
- › So-called "ghost" indentions and similar damage caused by the failure to use appropriate desk or writing pads.
- › Marble Tops applicable

All Warranty Claims are subject to DARRAN-approved inspections. Disputes may involve independent third-party evaluation

## QUALITY ASSURANCE

DARRAN manufactures in accordance with the standards set by Architectural Woodwork Institute (AWI) for Quality Standards.

Every unit produced at DARRAN is completely inspected by an independent quality control team located within each plant whose emphasis is on assembly, finish, and final inspections with empowerment to stop any unit not meeting DARRAN's high quality standards.

## LIGHT AND NATURAL FINISHES

The beauty of veneer and all wood products comes from the

variations created by nature including color, grain, and texture. These variations are not considered defects and DARRAN's Limited Lifetime Warranty does not cover color, grain and texture variations associated with natural wood and grain seen in any finish color. DARRAN sets standards for veneer selections; however, variations, especially apparent in light/natural finishes, will occur from one piece to another even if they are finished at the same time.

Finishes such as Clear Maple, Light/Gunstock Walnut, and Clear/Caramel Cherry will display more natural characteristics due to their light stain. Grain, pattern and color from unit to unit are not guaranteed or warranted and products will not be replaced due to these variations. Exposure to light and age will cause darkening of natural wood products; therefore DARRAN cannot guarantee or warrant finish match of new products being placed with existing products in the field.

## GLASS

Use of glass overlays on surfaces will void DARRAN's Limited Lifetime Warranty, unless the overlay is installed and maintained in strict accordance with DARRAN's instructions. If an overlay is to be used, please contact DARRAN for installation and maintenance instructions.

## GENERAL

Performance questions will be tested to generally accepted practices and AWI guidelines and standards for wood veneer furniture. To obtain performance of the Limited Lifetime Warranty, the purchaser should contact in writing the authorized DARRAN representatives or current dealer who sold the product to the purchaser or mail the warranty claim to:

Warranty Department  
DARRAN Furniture Industries, Inc.  
P.O. Box 7614  
High Point, NC 27264  
Telephone: 336-861-2400      Toll Free: 800-334-7891  
email: [warranty@darran.com](mailto:warranty@darran.com)

EXCEPT FOR THE LIMITED LIFETIME WARRANTY EXPRESSLY DESCRIBED HEREIN, DARRAN MAKES NO OTHER REPRESENTATION OR WARRANTY OF ANY KIND, EXPRESS OR IMPLIED. DARRAN MAKES NO WARRANTY OF MERCHANTABILITY OR FITNESS FOR A PARTICULAR PURPOSE, AND DARRAN WILL NOT UNDER ANY CIRCUMSTANCES BE LIABLE FOR ANY INCIDENTAL OR CONSEQUENTIAL DAMAGES, OR ANY INDIRECT OR SPECIAL DAMAGES.

## THE WARRANTY AS STATED ABOVE, SUPERSEDES ALL PREVIOUS WARRANTIES

**NO HASSLE FREIGHT DAMAGED MERCHANDISE**

DARRAN products are packed in specially designed cartons and padding that protects all edges and corners from damage. This is proven by an industry low damage rate of .0030% per total pieces shipped.

For qualified freight damage claims DARRAN will take responsibility for the claim and remedy processes including assuming total cost coverage from claim settlements.

(Some items may not qualify. Contact Factory for specific details.)

**QUALIFIED CLAIM CONDITIONS****VISIBLE CARTON DAMAGE**

1. Take digital pictures of the damaged carton and damaged furniture if visible damage is found upon delivery at the dock
2. Open all cartons with puncture or crushed corner damage.
3. Note any damage to the goods on the Carrier's freight bill as number of pieces damaged.

**CONCEALED DAMAGE**

1. Take digital pictures of the furniture as it sits partially unpacked. Also, photograph external and internal carton materials that correspond with the damaged area on the product.
2. Carton and damaged unit(s) must be located at the location matching the original delivery address for Carrier inspection.
3. Digital pictures must be provided of the damaged furniture and carton materials

For qualified claims per above contact DARRAN Customer Service Department at 1-800-334-7891 or complete DARRAN's online warranty report form within the 15 day limit. [www.darran.com/warrantyreport](http://www.darran.com/warrantyreport)

**NON-QUALIFIED CLAIM CONDITIONS**

1. Deliveries made to non-dock locations
2. Claims made after furniture is installed and/or removed from original delivery location
3. Carton and padding has been discarded
4. Carrier used was not DARRAN approved
5. Inspection reveals questionable damages

**REPLACEMENT ORDERS**

Replacement orders entered without replacement tagging or factory authorization is considered a new order without dispute, therefore full payment is expected and will be collected.

**RETURN SHIPMENTS**

DARRAN will not accept return of merchandise without a signed RA (return authorization) form.

DARRAN will specify the carrier to be used. Return bills of lading must be marked "Class 125" freight rate and a copy of the RA should be used as a packing list. All returns must be received by DARRAN within 30 days of the RA date or the products will be considered accepted by the customer.

All products being returned must be properly packed and protected to avoid freight damage. Whenever possible, use the original cartons in which the merchandise was shipped. Freight

damage, signs of usage, missing parts, etc., will result in an adjustment of any credit to be issued.

DARRAN will issue RA's for the following reasons:

1. Manufacturing defect (inspection required)
2. Order processing error by DARRAN
3. Shipping error
4. Mismatched carton / merchandise

**SPECIFICATION CHANGES**

We reserve the right to change without notice any dimension, style, or specification of any model in the DARRAN line. Dimensions shown in the price list are nominal. It is the buyer's responsibility to read specification carefully when matching existing goods is desired.

**MANUFACTURING DEFECTS**

Claims of manufacturing defects will not be entertained without prior consultation with DARRAN's warranty department. Unauthorized deduction in payment of invoices will not be allowed without prior factory approval. Unapproved deductions are subject to factor's late payment charges.

**DAMAGE CLAIMS**

Claims of manufacturing damage or freight damage reported as nicks, dents, scratches, etc. after installation of furniture will not be covered under warranty or freight claim.

**ATTENTION:** Damage claims involving glass or stone components must be inspected and damage noted on delivering freight bill to qualify for replacement.

**REPAIR CHARGES**

Factory authorization must be secured from DARRAN's warranty department prior to incurring repair charges. Warranty will utilize DARRAN's National Repair Service through the Furniture Medic Franchise ([www.furnituremedic.com](http://www.furnituremedic.com)).

Repair charge authorizations are based on:

- › Set travel rate
- › Average regional job rate
- › Factory set maximum repair time
- › Falsely reported defect claims are subject to local service charges being charged to dealer/distributor.

**FINISH MAINTENANCE**

Wood office furniture and wood finishes can retain their natural beauty for life if proper care is taken and a stable environment is provided. Fluctuations in humidity and temperature cause panels and solid wood components to expand and contract and may lead to panel warpage and finish "checking" or cracking. Prolonged exposure of furniture to dry heat during winter months should be avoided. Careful examination of interior wood trim may indicate a damaging dry environment. If open joints, splits and cracks are appearing in trimwork consult with a HVAC professional for appropriate remedy.

DARRAN finishes are field repairable should damage occur. Professional furniture repair services are recommended. Regular cleaning with a non-silicone polish is recommended.

**ORDERING**

All orders should be emailed, mailed or transmitted by fax to:

DARRAN Furniture Industries, Inc.  
P.O. Box 7614  
High Point, NC 27264  
email: orders@darran.com  
Fax: 336-861-6485

DARRAN will only accept orders from authorized Dealers. All orders must be accurate and detailed. All Quick Ship orders must contain Quick Ship product ONLY. Orders should be separated and submitted according to lead time. Orders must contain Quick Ship code "QS" or have designated Quick Ship lead time to ensure correct order entry. Orders that contain multiple lead time products will be entered as one order and scheduled with the most extended lead time.

List product by office and tag accordingly. DARRAN will key alike all products under the office tag. Failure to assign and tag may result in random key number assignments. Keying is field changeable.

**CREDIT APPROVAL**

All orders are subject to credit approval for open account. All new accounts must be approved by a local DARRAN Sales Representative and should submit current financial information and trade references to:

DARRAN Furniture Industries, Inc. ATTN: Credit Department  
P.O. Box 7614  
High Point, NC 27264  
Telephone: 336-861-2400      Toll Free: 800-334-7891  
Fax: 336-861-2512

Orders submitted without accounts pre-approval or credit approval are subject to acceptance with lead times scheduled only after approval dates.

**LEAD TIME SCHEDULE**

DARRAN cannot assign a firm lead time until Credit approval and order accuracy are complete. Extended lead times due to credit or information delays are the responsibility of the Buyer.

**ORDER DELAY / HOLD**

Due to the committed manufacturing cost on Quick Ship processes, DARRAN cannot delay or hold orders, either in process or after completion.

**CANCELLATION AND ORDER CHANGES - FEES**

Acknowledged orders are considered firm orders and therefore not subject to cancellation or change. However, in the event we are able to stop an order prior to manufacturing process, we will consider cancellation or changes with a reprocessing fee of \$40.00 Net. Exceptions: Quickship orders cannot be changed or canceled after the 3rd business date after acknowledgment. Qualified changes/cancellations will be assessed a \$40.00 Net processing fee.

Changes or cancellation of order with special options or custom quoted items are also subject to additional material and vendor fee costs, plus a DARRAN special/custom reprocessing fee of \$100 NET.

**ORDER MOVEUPS**

Should an original scheduled ship date need to be improved, the Factory must be contacted 15 business days prior to the desired ship date. Move ups are subject to schedule availability.

**ORDER ACKNOWLEDGMENT**

Upon credit approval your order will be acknowledged and identified by an order number. When making reference to your order, please use this order number. Your acknowledgment is a detailed description of our interpretation of your order, pricing, shipping information, and estimated delivery date.

If you have not received an Acknowledgment within 10 Days of order issue, contact Customer Service immediately. All Quick Ship order acknowledgments will be faxed or emailed upon request to speed processing. Please read your acknowledgment carefully for correctness and notify DARRAN immediately of any discrepancies. Failure to notify relieves DARRAN from error liability.

Order acknowledgment is the final agreement between DARRAN and the customer superseding all previous communications regarding the order. DARRAN will not be responsible for errors made on orders placed by phone without written confirmation.

**SELLING INFORMATION**

Possession of this price list does not in itself constitute the right to sell DARRAN products. DARRAN products are sold and distributed through authorized dealerships. Contact factory for a listing of local representatives and dealerships.

**INVOICE TERMS**

Standard terms are NET 30 days. Finance charges of 1-1/2% will be added to delinquent accounts after 45 Days and for each 30 Days thereafter until paid.

Complaints involving newly received merchandise must be reported within 10 days from receipt to qualify for full invoice remittance suspension or term extension. Otherwise only items in dispute can be suspended from payment of invoice within terms.

**WAREHOUSE/STORAGE**

DARRAN will determine order warehousing approvals on a case by case basis. Orders that can be accommodated will be limited to a max of 30 days storage and must be invoiced at time of storage. Orders that exceed factory storage capacity will be transferred to local storage facilities subject to current storage rates and handling-transit charges. Storage charges must be paid prior to order release to shipping.



**EXECUTIVE OFFICE & CONFERENCE ROOM  
FURNITURE**

**November 3, 2015 through November 2, 2020**

FSC Group 71

GSA CONTRACT NUMBER: GS-27F-001DA

Business Classification:

WBENC Certified Woman-Owned Small Business

DARRAN FURNITURE INDUSTRIES

2402 SHORE DRIVE

HIGH POINT, NC 27263

336.861.2400 FAX 336.861.6485

Business Classification:

Woman-Owned Small Business

On-line access to contract ordering information, terms and conditions, up-to-date pricing, and the option to create an electronic delivery order are available through GSA Advantage!, a menu driven database system. The INTERNET address for GSA Advantage is <http://www.fss.gsa.gov>

For more information on ordering from Federal Supply Schedules click on the FSS Schedules button at <http://www.fss.gsa.gov>

**1a. Special Item Number**

711-8: Executive Office Furniture

711-9: Executive Conference Room Furniture

711-11: Tables and Accessories

711-16: Upholstered Seating

711-18: Multi-purpose Seating

**2. Maximum Order Limitations:**

711-8 \$500,000

711-9 \$500,000

711-11 \$500,000

711-16 \$300,000

711-18 \$200,000

**3. Minimum Order: \$100**

**4. Geographic Coverage:** 48 Contiguous States and the District of Columbia

**5. Point of Production:** High Point, North Carolina (Randolph County)

**6. Discount:** Prices shown herein are List (Discount is 56.9% Off List)

**7. Quantity Discounts:**

• \$467,837 List to \$1,000,000 List = 59.70%

• \$1,000,001 List to \$1,315,789 List = 61.70%

**8. Payment Terms:** ½% - Net 15 Days, Net 30 Days

**8a. Terms and Conditions of Government Credit Card Acceptance:**

a. No discount allowed for payment by Government Purchase Card

b. Provide commercial credit card number

c. Provide commercial credit card expiration date

d. Provide individual's name as it appears on

credit card

e. Provide telephone number of individual to whom credit is issued

**9a. Government Purchase Cards are accepted below the Micro Purchase Threshold.**

**9b. Government Purchase Cards are accepted above the Micro Purchase Threshold.**

**10. Foreign Terms:** None

**11a. Time of Delivery:** Regular Product: 60 - 90 days after receipt of order

Quick Ship Program: Contact DARRAN

**11b. Quick Ship Program:** Items available for expedited delivery are included in main Price Lists.

**11c. Overnight and 2-day delivery:** N/A

**11d. Urgent Requirements:** Will be considered on an individual basis. Contact DARRAN for details.

**12. FOB Point:** All destinations are limited to Commercial docks only. Carriers may refuse non-dock deliveries.

**12a. Freight Prices:**

a. All prices shown are suggested list prices with freight included where indicated.

b. Freight allows delivery to one qualified destination.

c. Within the Continental USA, all orders above \$1,500 net are shipped FOB factory, freight prepaid and allowed. All orders less than \$1,500 net will be subject to a \$100 net freight charge.

**13. Ordering Address:**

DARRAN Furniture Industries

P.O. Box 7614

High Point, NC 27264

Ph: 800.334.7891

Fax: 336.861.6485

**13a. Payment Address:**

Rosenthal & Rosenthal Southeast

P.O. Box 733909

Dallas, TX 75373-3909

**14. Warranty Provision:** Limited Lifetime (Contact DARRAN for details)

**15. Export Packing Charges:** Quoted on request

**13. Terms and Conditions: Order Cancellation / Changes.**

Restocking/Returns: No merchandise may be returned without a return authorization and shipping instructions. No credit or allowance will be given for repairs to defective materials unless DARRAN has given authority to make such repairs. A restocking charge of 25% will apply.

Cancellation: No cost prior to production. After

# gsa customer information

production has begun, only actual cost incurred will be billed to the Government that cannot be recovered through resale in 6 months

**14. Terms and Condition of Rental, Maintenance and Repair: Consult the Factory.**

**15. Terms and Conditions of Installation:** Installation by a Third party to be quoted on a per job basis. The ordering must specify what ranges of installation services are required.

**16. Terms and Conditions of Repair Parts:** Contact DARRAN for details.

**17. List of Service and distribution points:** Contact DARRAN for details..

**18. Preventative Maintenance:** Information enclosed with product.

**19. List of Participating Dealers:** Contact DARRAN for details.

**23. Environmental Attributes:** DARRAN is compliant with EPA standards. All plywood core material is CARB 2 compliant and contains recycled content. All DARRAN Casegood Products are BIFMA Level 2 Certified. DARRAN is FSC CoC Certified and our products are MAS Certified for Indoor Air Quality.

**23a. Recyclable and Recycled Content Packaging:**

The corrugated packaging that is supplied to DARRAN, meets the federal mandate that requires the paperboard to be composed of 30%-50% recycled paper, and in some cases the recycled content is close to 100%.

**23b. Chemical Emission:** DARRAN finishes its products in an ENVI-CT Finish. (Environmental Coatings Technology). DARRAN's seating is finished with a low VOC Conversion Varnish and the casegoods are finished with a formaldehyde free, low VOC Urethane finish. These ENVI-CT finishes allow DARRAN's products to be MAS Certified Green under the ANSI BIFMA X7.1 Standard. Products assist with LEED 4.5 Credit.

**23c. Vapor Emissions:** DARRAN's ENVI-CT finishes use the latest environmental coatings technology to provide lasting durability and exceptional clarity. The ENVI-CT finishes allows DARRAN casegoods to be MAS Certified Green meeting LEED Credit 4.5.

**24a. Duns Number:** 08-363-5318

**24b. Cage Code:** 0Y-6B6

**24c. Federal ID Number:** 56-117-1971

**24d. NAICS Code:** 337211

**25. SAM Network:** DARRAN is registered

## SHIPPING SCHEDULE

DARRAN will make every effort to match shipping requests that are clearly noted on orders. However, the company accepts no liability for failure of delivery and/or delay if the occurrence is outside the control of DARRAN. To ensure specific time arrival, we recommend arranging single stop, designated load carriers. Less than trailer load (LTL) shipments cannot be coordinated for a guaranteed delivery time.

## PRICES

- › All prices shown are suggested list prices with freight included where indicated.
- › Freight allows delivery to one qualified destination.
- › Within the Continental USA, all orders above \$1,500 net are shipped FOB factory, freight prepaid and allowed. All orders less than \$1,500 net will be subject to a \$100 net freight charge.
- › If shipment unloading takes longer than the specified 3 hours, a charge of \$100 per hour will be billed.

## CALL BEFORE DELIVERY REQUEST

DARRAN will arrange for carriers to call before delivery when requested.

Important Non-Qualified Destinations DARRAN Prepaid Freight Pricing does not include delivery to:

- › Residential Areas
- › Restricted Commercial Areas
- › No Dock Locations
- › Inside delivery/setup service

Orders received and installed without professional Furniture Installers voids all Warranty Coverage.

## CARRIER SELECTION

DARRAN selects and uses only carriers specialized in furniture transportation. Customer requested carriers can be authorized using Freight Excluded pricing with invoice add-on.

## EXPRESS CARRIERS

DARRAN assumes no responsibility for charges incurred caused by delayed or late deliveries. If a guaranteed delivery time is needed please call DARRAN Customer Service at 1.800.334.7891 for a quote as additional charges will apply. Weekend or after-hours deliveries are subject to additional charges.

## FEATURES & ADVANTAGES

### VENEER TOPS

Wood veneer tops and high-pressure laminate tops feature a M2 Grade, CARB2 MDF Core with balanced 3-ply construction. Tops are 1-5/16" thick on all veneer and HPL products except for the Rift Collection, which features 1-1/2" thick primary work surfaces. Tops are connected to chassis with steel angle brackets, wood cleats and dowels. DARRAN only uses HPVA A Grade Flat Cut Cherry, Maple, and Walnut Veneers that are book-matched and slip-matched. Rift-Cut White Oak and Quarter-Cut Ash are available as premium veneers. DARRAN's Rift Collection features a double-cut veneer in a rift-cut pattern for a clean linear aesthetic. Veneer tops feature shapeable MDF edges, 3/4", 1", or 3mm external solid hardwood bands based on collection and edge selection. HPL tops feature a laminate self edge, shapeable MDF edge, or a 3mm solid wood edge based on edge selection.

### CHASSIS & PEDESTAL CONSTRUCTION

All pedestals and chassis are constructed with 3/4" thick balanced 3-ply panels. Panels are securely fastened together using rails that are bored and doweled, glued, metal reinforcement brackets and wood cleat construction. Thick end panels are pre-bored to accept a tee nut for the adjustable glide and are reinforced with pvc banding to prevent glide tear out. Glue blocks are used where 3/4" thick panels are joined, bored for tee nut to accept adjustable glide.

### ADJUSTABLE GLIDES

Glides provide 1" of vertical leveling adjustment. Glide bottom is durable metal.

### DRAWERS

All drawers are constructed of four sides and a bottom, which are attached to a drawer front with screws for easy removal. Drawer fronts feature vertically matched veneer within each pedestal. 1/2" thick maple with dovetail joinery sides - 3/4" thick bottom.

### SUSPENSIONS (PUSH TO OPEN)

All casegoods utilize cold rolled steel zinc plated high-grade drawer suspensions. All suspensions are warranted for the lifetime of the product. Box and File drawers are full extension, featuring steel ball bearings for a smoother quieter range of motion with soft close operation and are rated 100lbs. Lateral file drawers are a progressive action full extension suspension with the soft close operation and is rated at 150lbs. Lateral files include anti tip mechanism that will allow only one drawer at a time to be opened.

### HINGES

Units with doors include 95 degree swing hinges.

### WIRE MANAGEMENT

Boss Table legs are hollow allowing for integrated wire management. Wire(s) enter at the top of the leg and channel to the bottom of the leg at the floor for seamless wire management.

### GROMMETS

Metal grommets are provided to match the drawer pull selection. Grommet is available in black, silver, white or antique brass. Must specify standard or non-standard location. Black plastic grommets are available as an option for vertical applications.

### POWERPORTS

Choose from Byrne's Salt and Pepper power ports. Pepper includes one power plug and Salt includes two powered USB ports. Each leg can be fitted up to 2 ports. Choose one or combine 2 power ports per leg. Tables can have up to 8 power ports or any Salt and Pepper combination.

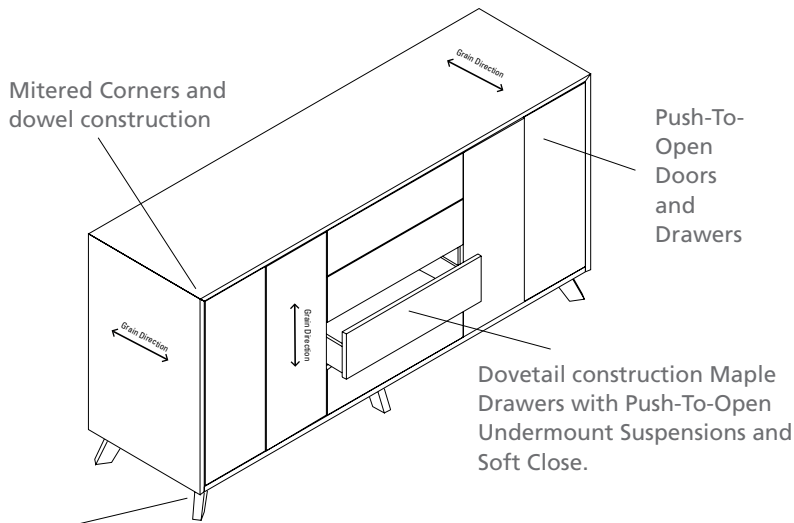

Walnut leg cover magnetized to a metal leg

1-1/2" Wood, 2cm Stone or 10 mm Back Painted Glass Tops are available.

Glass and Stone tops are supported with a 1-1/4" subtop

Magnetized Walnut aprons

Cover plates hide the wire management opening that are not in use and can be powder coated in white or black for no up-charge

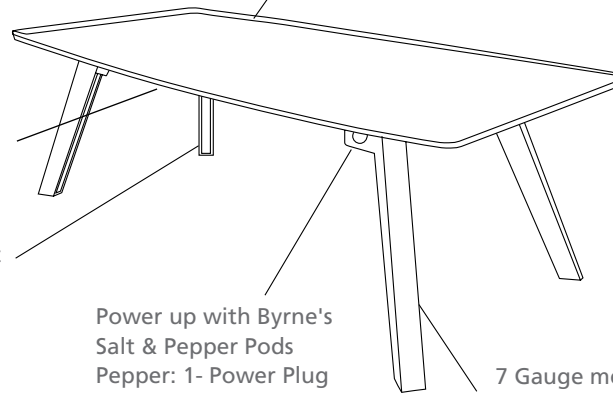

11 gauge steel metal frame, standard in White Finish

Legs are tubular steel with a cut out at the top and bottom for wire management

**FINISHES**

<b>"W"</b> Veneer <b>VENEER</b>	<b>"G"</b> HPL <b>LAMINATE HPL TOPS</b>	<b>"M"</b> TFL <b>THERMALLY FUSED LAMINATE</b>
WOW Clear Walnut.....	N/A.....	N/A
WEW Executive Walnut.....	N/A.....	N/A
WGW Gunstock Walnut.....	N/A.....	N/A
WBW Henna Walnut.....	N/A.....	N/A
WJW Judicial Walnut.....	N/A.....	N/A
WNW Natural Walnut.....	N/A.....	N/A

Boss Collection features Quartered Walnut Veneers

Send 3x3 or larger finish chip for color match. Custom finish upcharge is 3% or \$250 Net (whichever is greater).

**FINISH**

ENVI-CT Green Certified European Technology Coatings Finish.

**CONFERENCE TOPS**

1 1/2" thick core, Particleboard rated EPP/SCS/CARB-II material with 3 ply balanced construction. Quartered walnut veneers. Standard with hardwood rim bands.

**CHASSIS**

1" thick core, particleboard rated EPP/SCS/CARB-II material with 3 ply balanced construction. Pedestal and cabinets feature dowel construction reinforced with steel bracket plates, wood cleats, screws and glue. Exposed interiors feature finished veneer of same species as exterior faces.

NOTE: All units are standard with 1" adjustable glides that allow for leveling of units.

**DOORS/DRAWER FRONTS**

Door and drawer fronts are vertically matched in balanced sets. Quartered walnut.

**STANDARD WOOD DRAWERS**

Maple drawers are dobetailed at corners. Sides are 1/2" thick with a 3/4" thick bottom. UV cured finish

**BOSS TABLE PROFILE**

Boss Profile - Only Available on Table where option is shown  
Hardwood Rim Band Species Same As Surface Veneer

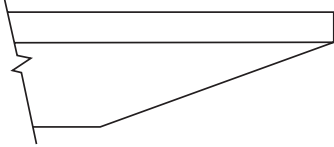

**CREDENZA PROFILE**

Flat Edge  
Hardwood Rim Band Species Same As Surface Veneer

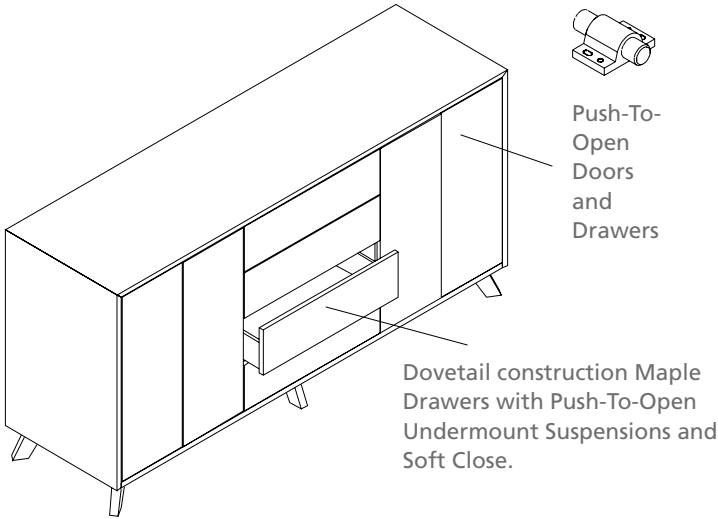
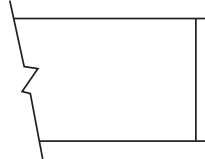

Push-To-Open  
Doors  
and  
Drawers

Dovetail construction Maple  
Drawers with Push-To-Open  
Undermount Suspensions and  
Soft Close.

**OPTIONAL WIRE MANAGEMENT GROMMETS**

Factory Installed

When grommets are specified or standard in a unit, DARRAN provides wire channels under the surface for organization and management of all communication wires and cords.

**Grommets (Standard Location)**

Specify Color and Left/Right/Center - \$45 ea.

- Black: TM30-R (Right), TM30-L (Left), TM30-C (Center)
- Silver: TM31-R (Right), TM31-L (Left), TM31-C (Center)
- Antique Brass: TM33-R (Right), TM33-L (Left), TM33-C (Center)

**Grommets (Non-Standard Location)**

Provide drawing w/ Grommet Location and Specify Color - \$90 ea.

- Black: TM30-NS
- Silver: TM31-NS
- Antique Brass: TM33-NS

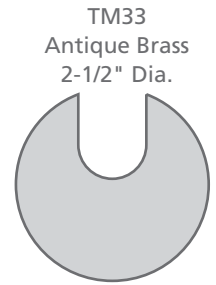

**GROMMETS (VERTICAL SURFACE)**

Standard Location - \$45 ea.

- Black Plastic Vertical Surface: TM50-C (Bottom Center)

Non-Standard Location - \$90 ea.

- Black Plastic Vertical Surface: TM50-NS

**GRAIN DIRECTION**

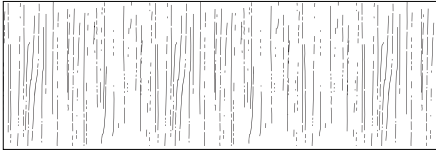

Credenza



**INTERIOR DRAWER DIMENSIONS**

UNIT DEPTH	DRAWER TYPE	OVERALL DIMENSIONS			INTERIOR DRAWER DIMENSIONS			NOTES
		W	D	H	W	D	H	
29" Wde	24" Box	27-7/8	18	5	26-7/8	17	3-3/4	Conference Box Drawers

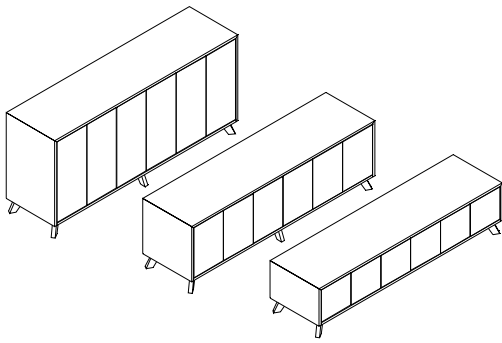

**STORAGE WITH DOORS**

**STANDARD FEATURES**

- 30" Height has 1 adjustable shelves per door section
- 42" Height has 2 adjustable shelves per door section
- Floor levelers (adjustable 1/2")
- Open Plan
- Quartered Walnut runs horizontally on case and vertically on doors. Top is short grain.

- Boss features push-to-open drawers and doors. Hardware is not available.
- Center vertical section will be removed when REF-01 option is specified. For interior cabinet dimensions contact factory

NOTES

[CLICK HERE TO VIEW PRODUCT INDEX](#)

**1 SELECT A STYLE**

DIMENSIONS		STYLE NUMBER	LIST PRICE	STYLE NUMBER	LIST PRICE	STYLE NUMBER	LIST PRICE
W" x D" x H"	WGT	"W" Veneer Top Veneer Chassis		"G" HPL High Pressure Laminate Top Veneer Chassis		"M" TFL Thermally Fused Laminate Top Thermally Fused Laminate Chassis	
<b>90" 6 Door Storage Credenza</b>							
90 x 24 x 42	490	BOS9042CA125W	6125	"G" Style N/A		"M" Style N/A	
90 x 24 x 30	330	BOS9030CA125W	5350	"G" Style N/A		"M" Style N/A	
90 x 24 x 22	220	BOS9022CA125W	4850	"G" Style N/A		"M" Style N/A	
<b>84" 6 Door Storage Credenza</b>							
84 x 24 x 42	460	BOS8442CA125W	5740	"G" Style N/A		"M" Style N/A	
84 x 24 x 30	310	BOS8430CA125W	5015	"G" Style N/A		"M" Style N/A	
84 x 24 x 22	205	BOS8422CA125W	4545	"G" Style N/A		"M" Style N/A	
<b>72" 4 Door Storage Credenza</b>							
72 x 24 x 42	395	BOS7242CA125W	4960	"G" Style N/A		"M" Style N/A	
72 x 24 x 30	265	BOS7230CA125W	4355	"G" Style N/A		"M" Style N/A	
72 x 24 x 22	180	BOS7222CA125W	3930	"G" Style N/A		"M" Style N/A	

**2 SELECT A FINISH**

"W" Veneer	"G" HPL	"M" TFL	
WOW	-	-	Clear Walnut
WEW	-	-	Executive Walnut
WGW	-	-	Gunstock Walnut
WBW	-	-	Henna Walnut
WJW	-	-	Judicial Walnut
WNW	-	-	Natural Walnut

**3 SELECT AN EDGE**

Edge Profile  
Option Not Available

**5 OPTIONS**

- DOOR**
- D2: Wood Door Lock - \$95 per Door Set
  - D6: Delete Doors - n/c
  - WPD3061: Designer White Fronts - \$125 per 2 door section
- REFRIGERATOR**
- REF-01: Specify Right or Left Refrigerator option (Water mat, heat vent and grommet hole) - \$195
  - Option is available on BOS9042CA125, BOS8442CA125, BOS7242CA125
- TRASH CAN**
- Specify Location
- TRC230: Trash Can Insert - (2) 30 gal containers - \$475
  - Option is available on BOS9042CA125, BOS8442CA125, BOS7242CA125

**4 SELECT HARDWARE**

Hardware  
Option Not Available

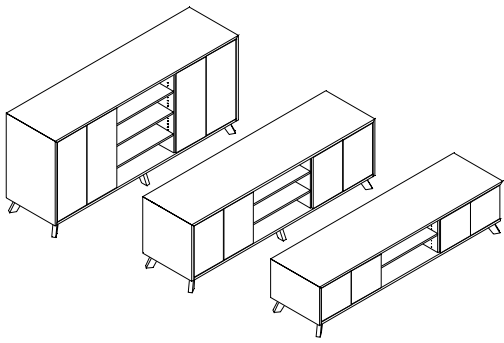

**STORAGE WITH DOORS/ OPEN CENTER**

**STANDARD FEATURES**

- 30" Height has 1 adjustable shelves per door section
- 42" Height has 2 adjustable shelves per door section
- Floor levelers (adjustable 1/2")
- Open Plan
- Quartered Walnut runs horizontally on case and vertically on doors. Top is short grain.

- Boss features push-to-open drawers and doors. Hardware is not available.
- Center vertical section will be removed when REF-01 option is specified. For interior cabinet dimensions contact factory

NOTES

[CLICK HERE TO VIEW PRODUCT INDEX](#)

**1 SELECT A STYLE**

DIMENSIONS		STYLE NUMBER	LIST PRICE	STYLE NUMBER	LIST PRICE	STYLE NUMBER	LIST PRICE
W" x D" x H"	WGT	"W" Veneer Top Veneer Chassis		"G" HPL High Pressure Laminate Top Veneer Chassis		"M" TFL Thermally Fused Laminate Top Thermally Fused Laminate Chassis	
<b>90" 4 Door Open/Storage Credenza</b>							
90 x 24 x 42	470	BOS9042CA128W	5925	"G" Style N/A		"M" Style N/A	
90 x 24 x 30	310	BOS9030CA128W	5200	"G" Style N/A		"M" Style N/A	
90 x 24 x 22	200	BOS9022CA128W	4750	"G" Style N/A		"M" Style N/A	
<b>84" 4 Door Open/Storage Credenza</b>							
84 x 24 x 42	440	BOS8442CA128W	5555	"G" Style N/A		"M" Style N/A	
84 x 24 x 30	290	BOS8430CA128W	4875	"G" Style N/A		"M" Style N/A	
84 x 24 x 22	185	BOS8422CA128W	4450	"G" Style N/A		"M" Style N/A	
<b>72" 2 Door Open/Storage Credenza</b>							
72 x 24 x 42	375	BOS7242CA128W	4800	"G" Style N/A		"M" Style N/A	
72 x 24 x 30	245	BOS7230CA128W	4215	"G" Style N/A		"M" Style N/A	
72 x 24 x 22	160	BOS7222CA128W	3850	"G" Style N/A		"M" Style N/A	

**2 SELECT A FINISH**

"W" Veneer	"G" HPL	"M" TFL	
WOW	-	-	Clear Walnut
WEW	-	-	Executive Walnut
WGW	-	-	Gunstock Walnut
WBW	-	-	Henna Walnut
WJW	-	-	Judicial Walnut
WNN	-	-	Natural Walnut

**3 SELECT AN EDGE**

Edge Profile  
Option Not Available

**5 OPTIONS**

**DOOR**

- D2: Wood Door Lock - \$95 per Door Set
- D6: Delete Doors - n/c
- WPD3061: Designer White Fronts - \$125 per 2 door section

**REFRIGERATOR**

- REF-01: Specify Right or Left Refrigerator option (Water mat, heat vent and grommet hole) - \$195
- Option is available on BOS9042CA128, BOS8442CA128, BOS7242CA128

**TRASH CAN**

- Specify Location
- TRC230: Trash Can Insert - (2) 30 gal containers - \$475
- Option is available on BOS9042CA128, BOS8442CA128, BOS7242CA128

**4 SELECT HARDWARE**

Hardware  
Option Not Available

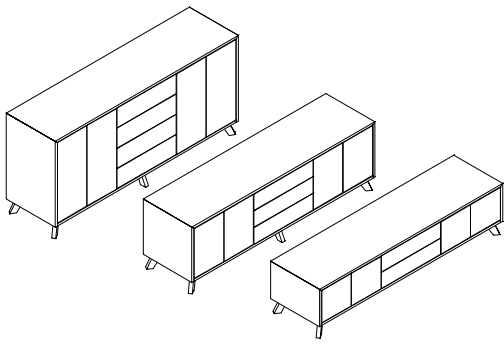

**BOX DRAWERS/STORAGE WITH DOORS**

**STANDARD FEATURES**

- 30" Height has 1 adjustable shelves per door section
- 42" Height has 2 adjustable shelves per door section
- Drawers feature soft close suspension
- Floor levelers (adjustable 1/2")
- Open Plan
- Quartered Walnut runs horizontally on case and vertically on doors. Top is short grain.

**NOTES**

- Boss features push-to-open drawers and doors. Hardware is not available.
- For interior cabinet dimensions contact factory

[CLICK HERE TO VIEW PRODUCT INDEX](#)

**1 SELECT A STYLE**

DIMENSIONS		STYLE NUMBER	LIST PRICE	STYLE NUMBER	LIST PRICE	STYLE NUMBER	LIST PRICE
W" x D" x H"	WGT	"W" Veneer Top Veneer Chassis		"G" HPL High Pressure Laminate Top Veneer Chassis		"M" TFL Thermally Fused Laminate Top Thermally Fused Laminate Chassis	
<b>90" 4 Door/Drawer Storage Credenza</b>							
90 x 24 x 42	490	BOS9042CA139W	7425	"G" Style N/A		"M" Style N/A	
90 x 24 x 30	330	BOS9030CA139W	6230	"G" Style N/A		"M" Style N/A	
90 x 24 x 22	220	BOS9022CA139W	5505	"G" Style N/A		"M" Style N/A	
<b>84" 4 Door/4 Drawer Storage Credenza</b>							
84 x 24 x 42	460	BOS8442CA139W	7030	"G" Style N/A		"M" Style N/A	
84 x 24 x 30	310	BOS8430CA139W	5890	"G" Style N/A		"M" Style N/A	
84 x 24 x 22	205	BOS8422CA139W	5195	"G" Style N/A		"M" Style N/A	
<b>72" 2 Door/ Drawer Storage Credenza</b>							
72 x 24 x 42	395	BOS7242CA139W	6225	"G" Style N/A		"M" Style N/A	
72 x 24 x 30	265	BOS7230CA139W	5205	"G" Style N/A		"M" Style N/A	
72 x 24 x 22	180	BOS7222CA139W	4565	"G" Style N/A		"M" Style N/A	

**2 SELECT A FINISH**

"W" Veneer	"G" HPL	"M" TFL	
WOW	-	-	Clear Walnut
WEW	-	-	Executive Walnut
WGW	-	-	Gunstock Walnut
WBW	-	-	Henna Walnut
WJW	-	-	Judicial Walnut
WNN	-	-	Natural Walnut

**3 SELECT AN EDGE**

Edge Profile  
Option Not Available

**5 OPTIONS**

**DOOR**

- D2: Wood Door Lock - \$95 per Door Set
- D6: Delete Doors - n/c
- WPD3061: Designer White Fronts - \$125 per 2 door section
- WPD3062: Designer White Fronts - \$60 per drawer

**DRAWER**

- P21U: Modify upper box/box to lateral - n/c
- P21L: Modify lower box/box to lateral - n/c

**REFRIGERATOR**

- REF-01: Specify Right or Left Refrigerator option (Water mat, heat vent and grommet hole) - \$195
- Option is available on BOS9042CA139, BOS8442CA139, BOS7242CA139

**TRASH CAN**

- Specify Location
- TRC230: Trash Can Insert - (2) 30 gal containers - \$475
- Option is available on BOS9042CA139, BOS8442CA139, BOS7242CA139

**4 SELECT HARDWARE**

Hardware  
Option Not Available

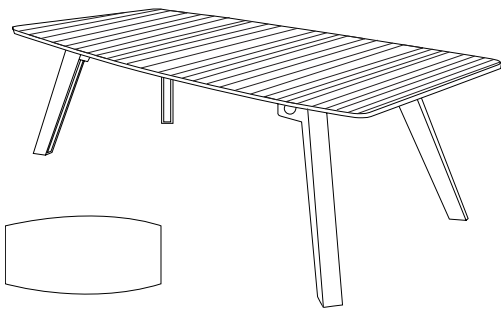

**QUARTERED WALNUT TOP**

**STANDARD FEATURES**

- 1.5" thick Quartered Walnut Top
- Adjustable Glides
- Hidden Wire Management down each leg, specify legs to be powered
- Quartered Walnut Runs Short Grain
- Steel Frame with magnetized solid wood aprons and leg caps
- Tops and bases are pre-located to ensure proper installation location

**NOTES**

- Table Ships KD

[CLICK HERE TO VIEW PRODUCT INDEX](#)

**1 SELECT A STYLE**

DIMENSIONS		STYLE NUMBER	LIST PRICE	STYLE NUMBER	LIST PRICE	STYLE NUMBER	LIST PRICE
W" x D" x H"	WGT	"W" Veneer Top Veneer Chassis		"G" High Pressure Laminate Top HPL Veneer Chassis		"M" Thermally Fused Laminate Top Thermally Fused Laminate Chassis	
72 x 42 x 30	240	BOS7242WT200W	4800	"G" Option N/A		"M" Option N/A	
84 x 42 x 30	280	BOS8442WT200W	5235	"G" Option N/A		"M" Option N/A	
96 x 48 x 30	315	BOS9648WT200W	5530	"G" Option N/A		"M" Option N/A	

**2 SELECT A FINISH**

"W" Veneer	"G" HPL	"M" TFL	
WOW	-	-	Clear Walnut
WEW	-	-	Executive Walnut
WGW	-	-	Gunstock Walnut
WBW	-	-	Henna Walnut
WJW	-	-	Judicial Walnut
WNN	-	-	Natural Walnut

**3 SELECT AN EDGE**



**5 OPTIONS**

**POWER**

- PDP01: Pepper (Power) - \$95 ea.
- PDS01: Salt (Powered USB) - \$225 ea.
- PD717: Power Supply Cordset - \$95 ea.
- Can specify up to 8 total power units (Specify location on drawing)
- W1: Horizontal J-Channel Wire Management Raceway - \$75 per 4'

**4 SELECT HARDWARE**

Hardware Option Not Available

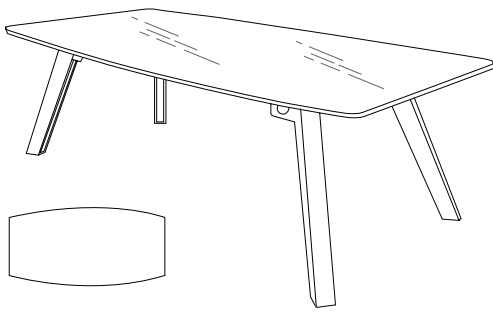

**10MM ICE WHITE GLASS TOP**

**STANDARD FEATURES**

- 10mm Ice White Glass Top
- 1-1/4" Subtop
- Adjustable glides
- Hidden Wire Management down each leg, specify legs to be powered
- Steel Frame with magnetized solid wood aprons and leg caps

**NOTES**

- Table Ships KD

[CLICK HERE TO VIEW PRODUCT INDEX](#)

**1 SELECT A STYLE**

DIMENSIONS		STYLE NUMBER	LIST PRICE	STYLE NUMBER	LIST PRICE	STYLE NUMBER	LIST PRICE
W" x D" x H"	WGT	"W" Veneer Glass Top Veneer Base		"G" HPL High Pressure Laminate Top Veneer Chassis		"M" TFL Thermally Fused Laminate Top Thermally Fused Laminate Chassis	
72 x 42 x 30	300	BOS7242GT200W	8620	"G" Option N/A		"M" Option N/A	
84 x 42 x 30	350	BOS8442GT200W	9625	"G" Option N/A		"M" Option N/A	
96 x 48 x 30	560	BOS9648GT200W	10670	"G" Option N/A		"M" Option N/A	

**2 SELECT A FINISH**

"W" Veneer	"G" HPL	"M" TFL	
WOW	-	-	Clear Walnut
WEW	-	-	Executive Walnut
WGW	-	-	Gunstock Walnut
WBW	-	-	Henna Walnut
WJW	-	-	Judicial Walnut
WNN	-	-	Natural Walnut

**3 SELECT AN EDGE**



**5 OPTIONS**

- POWER**
- PDP01: Pepper (Power) - \$95 ea.
  - PDS01: Salt (Powered USB) - \$225 ea.
  - PD717: Power Supply Cordset - \$95 ea.
  - Can specify up to 8 total power units (Specify location on drawing)
  - W1: Horizontal J-Channel Wire Management Raceway - \$75 per 4'

**4 SELECT HARDWARE**

Hardware Option Not Available

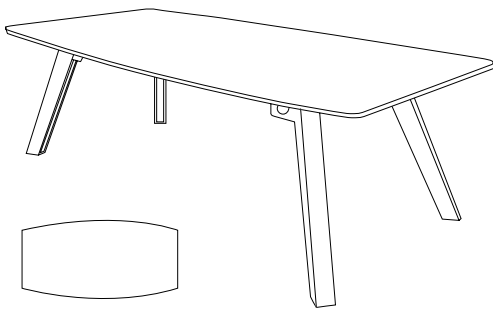

**2CM WHITE CARRARA TOP TABLE**

**STANDARD FEATURES**

- 1-1/4" Subtop
- 2cm White Carrara Top Table
- Adjustable glides
- Hidden Wire Management down each leg, specify legs to be powered
- Steel Frame with magnetized solid wood aprons and leg caps

**NOTES**

- Table Ships KD

[CLICK HERE TO VIEW PRODUCT INDEX](#)

**1 SELECT A STYLE**

DIMENSIONS		STYLE NUMBER	LIST PRICE	STYLE NUMBER	LIST PRICE	STYLE NUMBER	LIST PRICE
W" x D" x H"	WGT	"W" Veneer Stone Top Veneer Base		"G" HPL High Pressure Laminate Top Veneer Chassis		"M" TFL Thermally Fused Laminate Top Thermally Fused Laminate Chassis	
72 x 42 x 30	555	BOS7242ST200W	9975	"G" Option N/A		"M" Option N/A	
84 x 42 x 30	632	BOS8442ST200W	11545	"G" Option N/A		"M" Option N/A	
96 x 48 x 30	800	BOS9648ST200W	13350	"G" Option N/A		"M" Option N/A	

**2 SELECT A FINISH**

"W" Veneer	"G" HPL	"M" TFL	
WOW	-	-	Clear Walnut
WEW	-	-	Executive Walnut
WGW	-	-	Gunstock Walnut
WBW	-	-	Henna Walnut
WJW	-	-	Judicial Walnut
WNN	-	-	Natural Walnut

**3 SELECT AN EDGE**



**5 OPTIONS**

- POWER**
- PDP01: Pepper (Power) - \$95 ea.
  - PDS01: Salt (Powered USB) - \$225 ea.
  - PD717: Power Supply Cordset - \$95 ea.
  - Can specify up to 8 total power units (Specify location on drawing)
  - W1: Horizontal J-Channel Wire Management Raceway - \$75 per 4'

**4 SELECT HARDWARE**

Hardware Option Not Available

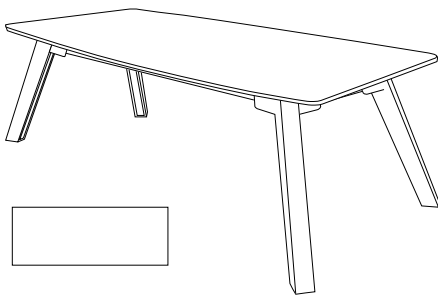

**TABLE FRAME W/ WOOD APRONS, LEGS & SUBTOP**

**STANDARD FEATURES**

- Adjustable glides
- Edge of subtop matches leg finish
- Hidden Wire Management down each leg, specify legs to be powered
- Steel Frame with magnetized solid wood aprons and leg caps
- Top & Bottom of Subtop is Finished Black (Template is available upon request for customers own top material)

**NOTES**

- Frame Ships KD

[CLICK HERE TO VIEW PRODUCT INDEX](#)

**1 SELECT A STYLE**

DIMENSIONS		STYLE NUMBER	LIST PRICE	STYLE NUMBER	LIST PRICE	STYLE NUMBER	LIST PRICE
W" x D" x H"	WGT	"W" Veneer Veneer Top Veneer Chassis		"G" HPL High Pressure Laminate Top Veneer Chassis		"M" TFL Thermally Fused Laminate Top	
66 x 36 x 29	140	BOS7242FO199W	4565	"G" Option N/A		"M" Option N/A	
78 x 36 x 29	165	BOS8442FO199W	4840	"G" Option N/A		"M" Option N/A	
90 x 42 x 29	220	BOS9648FO199W	5130	"G" Option N/A		"M" Option N/A	

**2 SELECT A FINISH**

"W" Veneer	"G" HPL	"M" TFL	
WOW	-	-	Clear Walnut
WEW	-	-	Executive Walnut
WGW	-	-	Gunstock Walnut
WBW	-	-	Henna Walnut
WJW	-	-	Judicial Walnut
WNN	-	-	Natural Walnut

**3 SELECT AN EDGE**



**5 OPTIONS**

- POWER**
- PDP01: Pepper (Power) - \$95 ea.
  - PDS01: Salt (Powered USB) - \$225 ea.
  - PD717: Power Supply Cordset - \$95 ea.
  - Can specify up to 8 total power units (Specify location on drawing)
  - W1: Horizontal J-Channel Wire Management Raceway - \$75 per 4'

**4 SELECT HARDWARE**

Hardware  
Option Not  
Available



**COMPUTER SUPPORT**

**DELUXE SINGLE MONITOR ARM W/ USB POST**



**STYLE NUMBER**  
MA1952

**LIST PRICE**  
495

**SPECIFICATIONS**

- (4) 2.0 USB Ports
- Post Length: 22-1/2"H, Post Base Requires 80mm Dia. Hole
- Spring Assist - Full Movement Arm, Arm Extends Up To 13 - 3/8"
- Supports Screens Up To 24", Swivels 180 degrees - Mount Plate Tilts 85 degrees
- Arm: Die Cast Aluminum

**Notes**

- Surface Factory Bored / Ready To Install

**COMPUTER SUPPORT**

**DELUXE DOUBLE MONITOR ARM W/ USB POST**



**STYLE NUMBER**  
MA2952

**LIST PRICE**  
795

**SPECIFICATIONS**

- (4) 2.0 USB Ports
- Post Length: 22-1/2"H, Post Base Requires 80mm Dia. Hole
- Spring Assist - Full Movement Arm, Arm Extends Up To 13 - 3/8"
- Supports Screens Up To 24", Swivels 180 degrees - Mount Plate Tilts 85 degrees
- Arm: Die Cast Aluminum

**Notes**

- Surface Factory Bored / Ready To Install
- Can Accommodate Up To 4 Monitors By Ordering Extra Double Arms.
- 1 Extra Arm and 1 Double Clamp - Add\$305

**DOOR MODIFICATIONS**

**SOFT CLOSE DOOR HINGE**



**STYLE NUMBER**  
D9SC

**LIST PRICE**  
15 Per Door

**SPECIFICATIONS**

- Snap onto standard door hinge
- Requires (2) per door
- Max door height 43"
- Factory installed where specified
- Individually shipped for field installation

**Notes**

- Specify Each Item To Have Slow Close Feature

**DOOR MODIFICATIONS**

**DELETE DOORS**

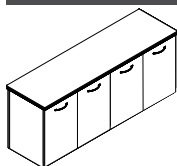

**STYLE NUMBER**  
D6

**LIST PRICE**  
N/C

**SPECIFICATIONS**

- Standard Door cabinets can have door deleted for open access.
- Modification of hinge rails and structural components are made face ready.

**DOOR MODIFICATIONS**

**PANEL DOOR LOCK**

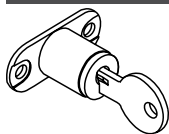

**STYLE NUMBER**  
D2

**LIST PRICE**  
95 Per Door Set

**SPECIFICATIONS**  
- Door Locks - 1 Door w/ Lock, Other Door w/ Catch Latch  
- Contact Customer Service regarding limited lock locations and keying.

**Notes**  
- Available on: Panel Doors, Wood Frame Doors, and Silverluma doors

**PEDESTAL MODIFICATIONS**

**BLACK LAMINATE PULLOUT BOTTOM SHELF**

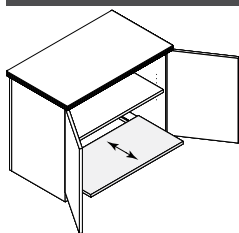

**STYLE NUMBER**  
PPOS

**LIST PRICE**  
214

**SPECIFICATIONS**  
- Black Laminate pullout shelf on suspension  
- Black grommet in back  
- Adjustable Shelf

**POWER / DATA**

**POWER SUPPLY CORDSET**

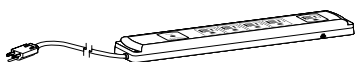

**STYLE NUMBER**  
PD717

**LIST PRICE**  
95

**SPECIFICATIONS**  
- SIZE: 10.75"L x 2.0"W x 1.06"H  
- (5) Outlets w/ 10' cord  
- Surge suppression (720 Joules)  
- 15 Amp breaker  
- Available on: Vertical Panels, Cabinet Interiors, and under tops

**PRODUCT MODIFICATIONS**

**MODIFY WIDTH - OPEN/CLOSED STORAGE**

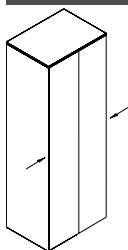

**STYLE NUMBER**  
MOD-2

**LIST PRICE**  
250

**SPECIFICATIONS**  
- Modify width down on any unit with open or closed storage section: overheads, wall hung units, storage credenzas, towers

**PRODUCT MODIFICATIONS** **MODIFY WIDTH - OUTSIDE OF MOD-1, MOD-2**

STYLE NUMBER	LIST PRICE	SPECIFICATIONS
MOD-3	Contact Factory for Pricing	- Width modification outside of MOD-1 & MOD-2

**PRODUCT MODIFICATIONS** **MODIFY DEPTH - INCREASE DEPTH**

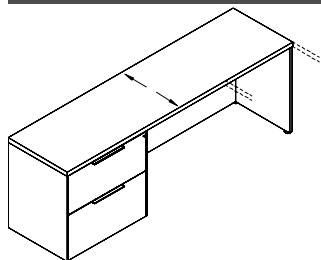

STYLE NUMBER	LIST PRICE	SPECIFICATIONS
MOD-6	Add 10%	- Increase depth  <b>Notes</b> - Ex. 24" to 30", 30" to 36", and 36" to 42"

**PRODUCT MODIFICATIONS** **MODIFY HEIGHT**

STYLE NUMBER	LIST PRICE	SPECIFICATIONS
MOD-7	Contact Factory for Pricing	- Modify height of a unit

**REFRIGERATOR MODIFICATION** **REFRIGERATOR CABINET MODIFICATION**

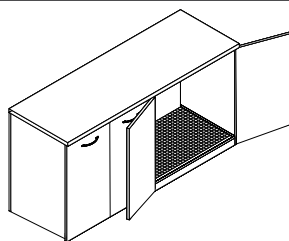

STYLE NUMBER	LIST PRICE	SPECIFICATIONS
REF01	195	- Open back cutout for venting - Moisture sponge mat - Contaminate ledge - Contact customer service for maximum refrigerator size (Changes based on unit).  <b>Notes</b> - Available on: Storage Credenzas

**WIRE MANAGEMENT**

**HORIZONTAL J-CHANNEL WIRE MANAGEMENT RACEWAY**

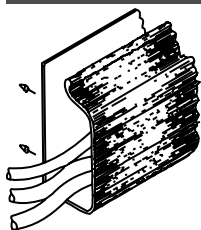

**STYLE NUMBER**  
W1

**LIST PRICE**  
75 Per 4 Foot Section

**SPECIFICATIONS**

- 4' section for field installation.
- The "J" shape black thermoplastic wire raceway may be added to specified worksurface tops to provide concealed channeling of wires to and from worksurface grommets. For use in open kneespace areas, raceway is attachable to top of back panel with pan head screws. Interior dimensions are 1" x 1- 1/2" providing ample storage for multiple wires and excess cable. Front of raceway flexes out for easy cord insertion.

**Notes**

- Units w/ Wire Channel Standard.
- Field Installation

**WIRE MANAGEMENT**

**HORIZONTAL WIRE MANAGEMENT RACEWAY**

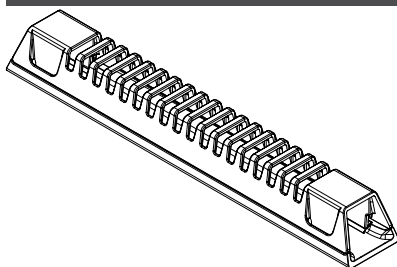

**STYLE NUMBER**  
W21

**LIST PRICE**  
30

**SPECIFICATIONS**

- 10"W x 1.5"D x 1.25"H
- Grey Wire Manager (10.5")
- Power and data cables can be discretely housed and managed with the W21 Gray Wire Manager. This can be mounted in any location to metal frame or underside of conference tables and runs cables through a 1" channel from power module to hollow steel legs. This keeps cables organized under the table top. Release clips make it simple to snap on and off the Wire Manager for easy organization and access after attached to the table

**Notes**

- Field installed

**WIRE MANAGEMENT**

**HORIZONTAL U-CHANNEL WIRE MANAGEMENT RACEWAY**



**STYLE NUMBER**  
W2A

**LIST PRICE**  
75 Per 4 Foot Section

**SPECIFICATIONS**

- 4' section for field installation.

**Notes**

- Units w/ Wire Channel Standard.
- Field Installation

**WIRE MANAGEMENT**

**COIL WIRE MANAGER**



**STYLE NUMBER**  
W18

**LIST PRICE**  
150

**SPECIFICATIONS**

- Weighted Base, Table attachment plate
- 39- 1/2" Length
- Black

**Notes**

- Location

**WIRE MANAGEMENT**

**STANDARD LOCATION GROMMETS - FACTORY INSTALLED**

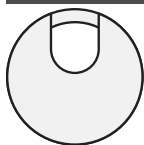

STYLE NUMBER	LIST PRICE	SPECIFICATIONS
<i>Standard Location Grommet</i>		- 1 -5/8" Metal Grommet
<i>Black</i>		<b>Notes</b>
TM30	45	- *Units w/ Grommets Standard Are Noted Under Standard Features. Grommets Match Pull Finish - Standard (Unless Specified Otherwise)
<i>Silver</i>		
TM31	45	
<i>Antique Brass</i>		
TM33	45	
<i>White</i>		
TM34	45	

**WIRE MANAGEMENT**

**NON-STANDARD LOCATION GROMMETS - FACTORY INSTALLED**

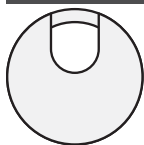

STYLE NUMBER	LIST PRICE	SPECIFICATIONS
<i>Non-Standard Location Grommet</i>		- 1 -5/8" Metal Grommet
<i>Black</i>		<b>Notes</b>
TM30 -NS	90	- *Units w/ Grommets Standard Are Noted Under Standard Features. Grommets Match Pull Finish - Standard (Unless Specified Otherwise)
<i>Silver</i>		
TM31 -NS	90	
<i>Antique Brass</i>		
TM33 -NS	90	
<i>White</i>		
TM34 -NS	90	

**WIRE MANAGEMENT**

**BLACK PLASTIC VERTICAL SURFACE GROMMETS - FACTORY INSTALLED**



STYLE NUMBER	LIST PRICE	SPECIFICATIONS
<i>Standard Location Grommet</i>		- 2 " Black Plastic Grommet
TM50-C	45	<b>Notes</b>
<i>Non-Standard Location Grommet</i>		- Standard Location is Bottom Center
TM50-NS	90	

**AIRCHARGE WIRELESS CHARGING GROMMET**

**STYLE NUMBER**

**LIST PRICE**



ACWG WIRELESS GROMMET

\$195



**SPECIFICATIONS**

- When used with GROVE Tables an additional \$350 LIST will apply for the special cutout required.
- AirCharge offers a convenient way to charge any Qi compatible smartphone or device without the need to carry charging cables or find an available power outlet.
- The Aircharge is powered by the latest Qi compliant IC offering reliable and efficient wireless charging in a convenient 3" grommet hub. Simply place your phone on the Aircharge and an LED will confirm pairing and begin wireless charging.
- Recess: Efficient space conservation and quick access
- Input: DC 5V (with included AC power adapter), DC 9V, 1.67A (with optional QC 2.0 power adapter)
- Output: 5 watts Max. with DC 5V, 2A power adapter, 10 watts Max. with QC 2.0 power adapter
- Qi V1.2 compliant IC
- Charging distance: 6mm Max.

AirCharge Wireless Grommet



**AVAILABLE**

- All Darran Collections

**COVE POWER UNIT - NON-LINKING**

**STYLE NUMBER**

**LIST PRICE**



PD COVE PLUG  
Non-Linking Version

\$550

**SPECIFICATIONS**

- Size 5.75" L x 2.5" W
- When used with GROVE Tables an additional \$350 LIST will apply for the special cutout required.
- (2) 15 Amp Receptacles and (2) USB charging ports
- Surface Mount
- 108" Cord
- Standard Silver Finish, Available in White or Black Finish upon request
- ETL Listed

**AVAILABLE**

- All Darran Collections



**COVE CORDED SERIES**

**STYLE NUMBER**

**LIST PRICE**



PD-COVE-PKO

\$800



**SPECIFICATIONS**

- Size 9.5" L x 2.5" W x 3.18" D
- When used with GROVE Tables an additional \$350 LIST will apply for the special cutout required.
- (2) Power Receptacles, (2) 2.1 Amp USB charging ports and (1) Telecom Plate Knockout
- Surface Mount
- 108" Cord
- Standard Silver Finish, Available in White or Black Finish upon request
- ETL Listed

**AVAILABLE**

- All Darran Collections



**TELECOM PLATES**

*THIS POD CAN HAVE UP TO 1 TOTAL PLATES*

STYLE NUMBER	LIST PRICE
RJ45 (1)	\$35
RJ45 (2)	\$70
RJ45 (3)	\$105
USB (1)	\$70
USB (2)	\$140
RJ11/RJ45	\$70
RJ45/USB	\$105
RJ45/HDMI	\$190
HDMI/DVI	\$325
HDMI/USB	\$205
HDMI/VGA	\$240
VGA/MINI-STEREO	\$155
VGA/USB	\$175



**PDFAA FLUSH DATA BAY ANODIZED ALUMINUM DOOR**

	STYLE NUMBER	LIST PRICE
	Hardwired	
	PDFAA-H72 72" Cord	\$1250
	PDFAA-H108 108" Cord	\$1300
	PDFAA-H144 144" Cord	\$1350
	PDFAA-H180 180" Cord	\$1400
	Power/Plug	
	PDFAA-C72 72" Cord	\$1250
	PDFAA-C108 108" Cord	\$1300
	PDFAA-C144 144" Cord	\$1350
	PDFAA-C180 180" Cord	\$1400



Standard underside Convenience plug. Can be used for Daisy Chaining up to (4) total units. Specify hardwired or plug for the first unit in series, daisy chained units will have a plug for connection through convenience plug.

**SPECIFICATIONS**

- Size 13.75"L x 6.375"W x 2.85"D
- (4) 15 Amp receptacles
- Surface Mount
- Standard Interior Black Finish
- (3) telecom plate cutouts standard
- Coded units are UL Listed and CSA Certified. Hardwired Units are CSA Certified
- Select 72", 108", 144", or 180" power cord or hardwire whip cord

**AVAILABLE**



- All Darran Collections
- Excludes Rail, Grove

**TELECOM PLATES**

*THIS POD CAN HAVE UP TO 3 TOTAL PLATES*  
- \*All telecom connectors sold separately

STYLE NUMBER	LIST PRICE
RJ45 (1)	\$35
RJ45 (2)	\$70
RJ45 (3)	\$105
USB (1)	\$70
USB (2)	\$140
RJ11/RJ45	\$70
RJ45/USB	\$105
RJ45/HDMI	\$190
HDMI/DVI	\$325
HDMI/USB	\$205
HDMI/VGA	\$240
VGA/MINI-STEREO	\$155
VGA/USB	\$175

**PDFAF FLUSH DATA BAY FROSTED GLASS DOOR WITH DAISYLINK**

	STYLE NUMBER	LIST PRICE
	Hardwired	
	PDFAF-H72 72" Cord	\$1150
	PDFAF-H108 108" Cord	\$1200
	PDFAF-H144 144" Cord	\$1250
	PDFAF-H180 180" Cord	\$1300
	Power/Plug	
	PDFAF-C72 72" Cord	\$1150
	PDFAF-C108 108" Cord	\$1200
	PDFAF-C144 144" Cord	\$1250
	PDFAF-C180 180" Cord	\$1300



**SPECIFICATIONS**

- Size 13.75"L x 6.375"W x 2.85"D
- (4) 15 Amp receptacles
- Surface Mount
- Standard Interior Black Finish
- (3) telecom plate cutouts standard
- Corded units are UL Listed and CSA Certified. Hardwired Units are CSA Certified
- Select 72", 108", 144", or 180" power cord or hardwire whip cord

**AVAILABLE**

- All Darran Collections
- Excludes Diva, Grove and Rail

**TELECOM PLATES**

*THIS POD CAN HAVE UP TO 3 TOTAL PLATES*  
 \*All telecom connectors sold separately

STYLE NUMBER	LIST PRICE
RJ45 (1)	\$35
RJ45 (2)	\$70
RJ45 (3)	\$105
USB (1)	\$70
USB (2)	\$140
RJ11/RJ45	\$70
RJ45/USB	\$105
RJ45/HDMI	\$190
HDMI/DVI	\$325
HDMI/USB	\$205
HDMI/VGA	\$240
VGA/MINI-STEREO	\$155
VGA/USB	\$175



Standard underside Convenience plug. Can be used for Daisy Chaining up to (4) total units. Specify hardwired or plug for the first unit in series, daisy chained units will have a plug for connection through convenience plug.

SALT AND PEPPER POWER PORTS

STYLE NUMBER LIST PRICE

BOSS



PDP01 Pepper (Power) \$95

PDP01 Salt (Powered USB) \$225



Pepper power pod

SPECIFICATIONS

- Pepper port includes 1 power plug
- Salt port includes 2 power USB
- Cord is 48" long
- Spill-proof technology

AVAILABLE

- Boss, Grove Square Stool



Salt powered USB



**REEF POWER UNIT WITH DAISYLINK**

**STYLE NUMBER**

**LIST PRICE**



REF310 PLUG

\$1100

**SPECIFICATIONS**

- Size 16.1”L x 6.25”W x 4.89”D
- When used with GROVE Tables an additional \$350 LIST will apply for the special cutout required.
- (3) 120V Receptacles, (2) USB charging ports, 1 Data Plate Knockout, (2) Knockouts for RJ45 Data Ports
- Surface Mount
- 108” Cord
- Features Convenience Plug on bottom of unit that allows for max (3) Daisy Chain
- Standard Black Finish, Available in White or Silver Finish upon request
- Additional Telecom Plate Knockout
- RJ45 for Knockouts not required. If not ordered a small hole will be present in the pod in this this location
- ETL Listed

**AVAILABLE**

- Grove
- Conferencing



**TELECOM PLATES**

*THIS POD CAN HAVE UP TO 1 TOTAL PLATES*

STYLE NUMBER	LIST PRICE
RJ45 (1)	\$35
RJ45 (2)	\$70
RJ45 (3)	\$105
USB (1)	\$70
USB (2)	\$140
RJ11/RJ45	\$70
RJ45/USB	\$105
RJ45/HDMI	\$190
HDMI/DVI	\$325
HDMI/USB	\$205
HDMI/VGA	\$240
VGA/MINI-STEREO	\$155
VGA/USB	\$175



**SOBA WIRE MANAGER**

STYLE NUMBER	LIST PRICE
<i>STARTER UNITS</i>	
SCDW	\$200
White wire manager	
SCDB	\$200
Black wire manager	



**SPECIFICATIONS**

- Dimensions: 9ft x 9in x 3.15in
- Zips up, bundles and routes loose, messy cables into a single tube
- Routes and guides cables behind desks, TVs, and anywhere cables tend to get messy
- Accommodates large or small cables, up to three cables at once

**AVAILABLE**

- All collections (excludes Spire, Occasional and Seating)



VILLA POWER UNIT WITH DAISYLINK

STYLE NUMBER LIST PRICE

STARTER UNITS



VIL-DCH HARDWIRED \$600  
Includes (1) Villa unit with 120" Hardwire Infeed



VIL-DCP PLUG \$695  
Includes (1) Villa with Plug Infeed - Includes 72" Cord and 32" Infeed Jumper for 104" total cord infeed

ADDITIONAL LINKING UNITS

VIL-DCL ADDITIONAL \$590  
(Includes linking Villa and Jumper cable up to 96")

SPECIFICATIONS

- Size: Top Grommet 5.68" L X 3.39"W; Under Top 12"L x 3.13"W x 3.08"D
- (4) Power receptacles; (2) surface and (2) undersurface, (2) 2.1A USB charging ports and (1) Knockout for RJ45 Data Port
- Surface Mount
- Daisy Chain - Hardwire Max (10) Units, Plug/Corded Max (5) Units
- Standard Silver Finish, Black Finish available upon request
- UL or ETL Certified

AVAILABLE

- All Darran Collections
- Excludes Grove



RJ45 KNOCKOUT

STYLE NUMBER	LIST PRICE
RJ45 (1)	\$35