

EFFECTIVE FEB 2018 UPDATED JULY 2018



# Maxton.

price list

DATE	PAGE	MODIFICATION	DESCRIPTION
2.1.18	All	Added finish	Added WBW Henna Walnut finish

**TABLE OF CONTENTS**

Seating Specification..... 2  
General Information ..... 3  
Limited Lifetime Warranty ..... 4  
Damages | Returns | Repairs ..... 5  
Ordering Information ..... 6  
GSA Customer Information ..... 7  
Freight..... 8  
Seating Fabric & leather Programs..... 9  
COM/COL Form..... 10  
Finishes..... 11  
Guest Chair ..... 12

Width = 23-1/4"  
 Depth = 23"  
 Height = 32"  
 Seat Width = 21"  
 Seat Depth = 20"  
 Seat Height = 18"  
 Arm Height = 25-1/4"  
 Cartoned Weight = 25 lbs.

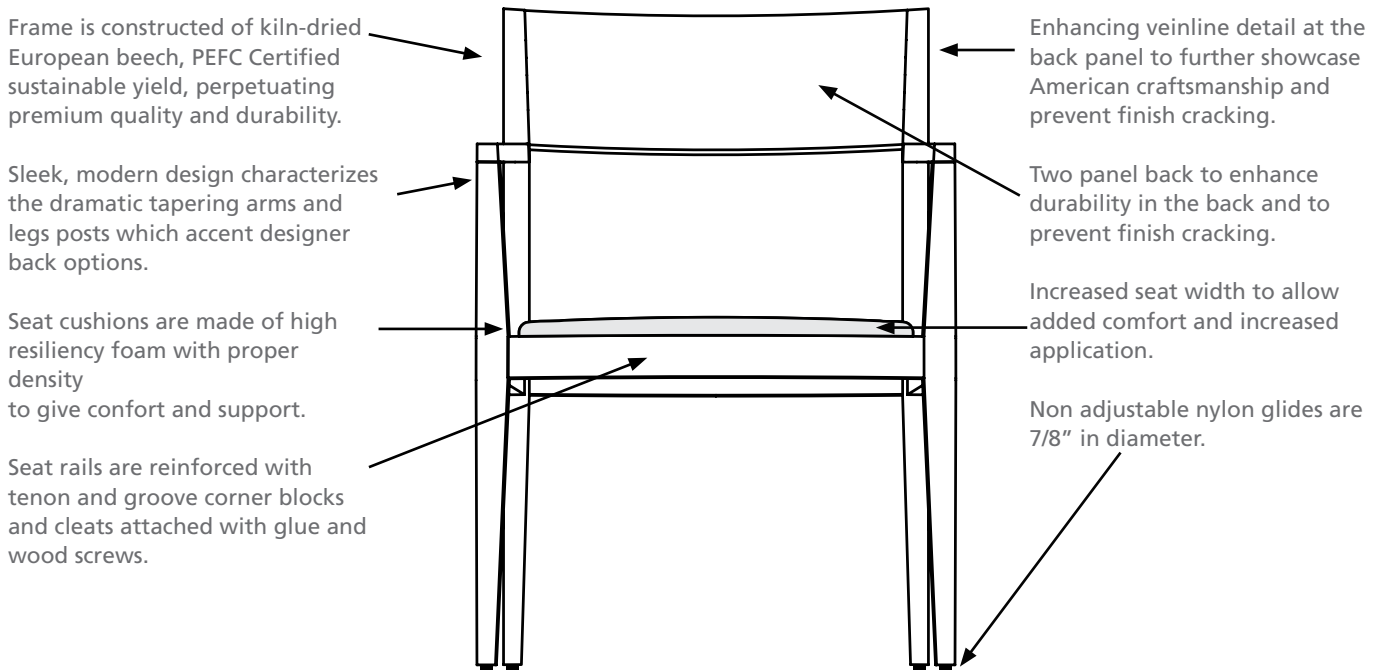

Variety of textiles and back options offer customers flexibility in design and consistency within each office setting.

### JOINTS

Joints are securely fastened with mortise and tenon joinery or double doweled construction to ensure long-term use.

### SEAT SUSPENSION

Seat suspension is constructed of 3/4" thick top quality Baltic Birch plywood that is machined to form an open perimeter of rounded inside edges to reduce strain on the seat suspension. A single piece of sheet webbing reduces stress on the foam and supports the foam across the entire opening of the seat pan, thus preventing foam cutting that can occur with straps.

### SEAT ASSEMBLY

Seat assembly is attached within finger grooved corner blocks and further secured by wood cleats, providing a vast superior means of stability in the chair.

### ENVI-CT FINISH

ENVI-CT (Environmental Coatings Technology) utilizes advanced European finish technology to deliver a high-end furniture coatings with superior performance in appearance and durability, allowing DARRAN to deliver more sustainable products to our customers.



All DARRAN products are proudly manufactured in the U.S.A.

### FULLY ASSEMBLED

Unless otherwise noted, all products are fully assembled and ready to use, including add-on options.

### PERFORMANCE TESTED

All products are tested to ensure performance exceeds BIFMA / ANSI standards.

### GREEN CERTIFIED

DARRAN has been committed to improving indoor air quality of office buildings since 1996. Since then, finish technology has allowed our commitment to continue with products that are air quality Certified Green.

DARRAN is proud to announce that all in veneer, laminate, and guest seating are MAS Certified Green for complying with the ANSI/BIFMA X 7.1 standard / LEED 4.5 Standard for low –VOC emitting Furniture.

MAS is an independent emission testing laboratory that is ISO 17025 compliant using ASTM, ANSI and CEN methods. MAS is a true 3rd party certification through NSF International to BIFMA standards and California’s ARB formaldehyde standard. Certification of compliance under the Low – VOC emitting Furniture testing, qualifies products for LEED 4.5 credits.



### FINISH TECHNOLOGY

DARRAN has continued its partnership with AkzoNobel Chemicals ([www.akzonobel.com](http://www.akzonobel.com)) to develop a new finish technology further improving indoor air quality with a coatings that meets today’s environmental standards and supports LEED buildings.



ENVI-CT (Environmental Coatings Technology) utilizes advanced European finish technology to deliver a high-end furniture coatings with superior performance in appearance and durability, allowing DARRAN to deliver more sustainable products to our customers.

#### *ENVI-CT Advantages:*

- › ENVI-CT is a re-engineered high performance Top Coat
- › Exceptional hardness and clarity
- › Highly resistant to solvents and chemicals
- › Plasticizer Migration resistant
- › Excellent UV inhibitors for maximum color resistance
- › Exceeds current and proposed future Federal and State air quality requirements
- › Field Repairable
- › Dynamic chamber emissions tested and certified compliant to ANSI/BIFMA X 7.1 Standard / LEED 4.5 Standard for low – VOC emitting furniture.

### ADVANTAGES

DARRAN collaborated with the world’s leader in finishing materials, to formulate an additive that will inhibit the growth of mold, mildew, fungus and bacteria on wood surfaces. This additive infuses Silver Ions into DARRAN’s ENVI-CT (Environmental Coatings Finish Technology), creating a protective surface for the life of the furniture. The best part - is standard on all DARRAN Seating for no additional fee.

### COM/COL REQUEST

DARRAN has graded in fabric selection from Momentum, Maharam, CF Stinson, Paul Brayton Designs, Knoll Textiles and Designtex. In addition, DARRAN has graded in leather from Wollsdorf and Elmo. Should a material be desired that is not graded in, DARRAN will accommodate your request with our selected alliance textile partners. Please fill out the COM/COL form.

### TEXTILE FLAMMABILITY TESTING

All DARRAN seating products conform to California Technical Bulletin 117 as a minimum standard. CAL133 may require additional testing to ensure compliance.

**LIMITED LIFETIME WARRANTY**

DARRAN Furniture Industries, Inc. ("DARRAN") warrants that each piece of furniture manufactured in its North Carolina Facilities will be free from defects in material and workmanship for as long as the original purchaser owns and uses the product. Subject to the limitations and exclusions herein, DARRAN, at its discretion and as the sole remedy under the DARRAN Limited Lifetime Warranty, will replace or repair a defective product or components with comparable product or components free of charge. This warranty is made only to the original purchaser from an authorized DARRAN dealer, for as long as that original purchaser owns and uses the product.

**LIMITATIONS: USE / CARE**

- › Warranty is limited to normal single shift use.
- › Warranty is limited to generally accepted care and maintenance of natural wood products and environments.
- › Natural wood surfaces are subject to denting, scratching, and gauging if not properly used and cared for. Warranty is subject to use and care in accordance with the use and care instructions provided in the Product Care section of this site (including, but not limited to, the care and maintenance guide downloads linked thereon), available at [www.darran.com/product-care](http://www.darran.com/product-care), which are incorporated herein by reference.

**LIMITATIONS: MATERIALS / COMPONENTS**

- › Chair Frames - 10 Years
- › Veneers / Laminates / Hardwoods - 10 Years
- › Custom / Modified Products - 3 Years
- › Foam Padding - 5 Years
- › Metal Accents / Glides - 10 Years
- › High Use Items - 5 Years (High Use Items include, but are not limited to, table arms, electrical components, ganging mechanisms, pneumatic lifts, and polymer based components)

**WARRANTY EXCLUSIONS**

*Damage identified as carrier or installer related.*

- › Normal wear and tear of wood products during course of ownership.
- › Color, grain, or texture of natural wood materials, laminates, and other covering materials.
- › Damages or failures resulting from misuse, abuse, negligence, improper care, modifications, or relocation.
- › Non Commercial use or locations.
- › C.O.M (Customer's Own Material) specified by the Customer.
- › Textiles (which may be subject to a separate warranty from the textile manufacturer).

All Warranty Claims are subject to DARRAN-approved inspections. Disputes may involve independent third-party evaluation

**QUALITY ASSURANCE**

DARRAN manufactures in accordance with the standards set by Architectural Woodwork Institute (AWI) for Quality Standards.

Every unit produced at DARRAN is completely inspected by an independent quality control team located within each plant whose emphasis is on assembly, finish, and final inspections

with empowerment to stop any unit not meeting DARRAN's high quality standards.

**LIGHT AND NATURAL FINISHES**

The beauty of veneer and all wood products comes from the variations created by nature including color, grain, and texture. These variations are not considered defects and DARRAN's Limited Lifetime Warranty does not cover color, grain and texture variations associated with natural wood and grain seen in any finish color. DARRAN sets standards for veneer selections; however, variations, especially apparent in light/natural finishes, will occur from one piece to another even if they are finished at the same time.

Finishes such as Clear Maple, Light/Gunstock Walnut, and Clear/Caramel Cherry will display more natural characteristics due to their light stain. Grain, pattern and color from unit to unit are not guaranteed or warranted and products will not be replaced due to these variations. Exposure to light and age will cause darkening of natural wood products; therefore DARRAN cannot guarantee or warrant finish match of new products being placed with existing products in the field.

**TEXTILES/LEATHER**

DARRAN does not manufacture textiles and does not warranty any textiles incorporated into its products (including, but not limited to, any warranty against colorfastness, crocking, wear abrasion, shrinking, stretching, tearing, wrinkling, durability, or dye lot match). Textiles are not covered under DARRAN's Limited Lifetime Warranty, but may be covered by a separate warranty from the textile manufacturer. Customers should contact the textile manufacturer directly with any concerns or claims regarding textiles.

**GENERAL**

Performance questions will be tested to generally accepted practices and AWI guidelines and standards for wood veneer furniture. To obtain performance of the Limited Lifetime Warranty, the purchaser should contact in writing the authorized DARRAN representatives or current dealer who sold the product to the purchaser or mail the warranty claim to:

Warranty Department  
 DARRAN Furniture Industries, Inc.  
 P.O. Box 7614  
 High Point, NC 27264  
 Telephone: 336-861-2400      Toll Free: 800-334-7891  
 Email: [warranty@darran.com](mailto:warranty@darran.com)

EXCEPT FOR THE LIMITED LIFETIME WARRANTY EXPRESSLY DESCRIBED HEREIN, DARRAN MAKES NO OTHER REPRESENTATION OR WARRANTY OF ANY KIND, EXPRESS OR IMPLIED. DARRAN MAKES NO WARRANTY OF MERCHANTABILITY OR FITNESS FOR A PARTICULAR PURPOSE, AND DARRAN WILL NOT UNDER ANY CIRCUMSTANCES BE LIABLE FOR ANY INCIDENTAL OR CONSEQUENTIAL DAMAGES, OR ANY INDIRECT OR SPECIAL DAMAGES.

**THE WARRANTY AS STATED ABOVE, SUPERSEDES ALL PREVIOUS WARRANTIES NO HASSLE FREIGHT DAMAGED MERCHANDISE**

DARRAN products are packed in specially designed cartons and padding that protects all edges and corners from damage. This is proven by an industry low damage rate of .0030% per total pieces shipped.

For qualified freight damage claims DARRAN will take responsibility for the claim and remedy processes including assuming total cost coverage from claim settlements.

(Some items may not qualify. Contact Factory for specific details.)

## QUALIFIED CLAIM CONDITIONS

### VISIBLE CARTON DAMAGE

1. Take digital pictures of the damaged carton and damaged furniture if visible damage is found upon delivery at the dock
2. Open all cartons with puncture or crushed corner damage.
3. Note any damage to the goods on the Carrier's freight bill as number of pieces damaged.

### CONCEALED DAMAGE

1. Take digital pictures of the furniture as it sits partially unpacked. Also, photograph external and internal carton materials that correspond with the damaged area on the product.
2. Carton and damaged unit(s) must be located at the location matching the original delivery address for Carrier inspection.
3. Digital pictures must be provided of the damaged furniture and carton materials

For qualified claims per above contact DARRAN Customer Service Department at 1-800-334-7891 or complete DARRAN's online warranty report form within the 15 day limit. [www.darran.com/warranty-report](http://www.darran.com/warranty-report)

### NON-QUALIFIED CLAIM CONDITIONS

1. Deliveries made to non-dock locations
2. Claims made after furniture is installed and/or removed from original delivery location
3. Carton and padding has been discarded
4. Carrier used was not DARRAN approved
5. Inspection reveals questionable damages

## REPLACEMENT ORDERS

Replacement orders entered without replacement tagging or factory authorization is considered a new order without dispute, therefore full payment is expected and will be collected.

## RETURN SHIPMENTS

DARRAN will not accept return of merchandise without a signed RA (return authorization) form.

DARRAN will specify the carrier to be used. Return bills of lading must be marked "Class 125" freight rate and a copy of the RA should be used as a packing list. All returns must be received by DARRAN within 30 days of the RA date or the products will be considered accepted by the customer.

All products being returned must be properly packed and protected to avoid freight damage. Whenever possible, use the original cartons in which the merchandise was shipped. Freight damage, signs of usage, missing parts, etc., will result in an

adjustment of any credit to be issued.

DARRAN will issue RA's for the following reasons:

1. Manufacturing defect (inspection required)
2. Order processing error by DARRAN
3. Shipping error
4. Mismatched carton / merchandise

## SPECIFICATION CHANGES

We reserve the right to change without notice any dimension, style, or specification of any model in the DARRAN line. Dimensions shown in the price list are nominal. It is the buyer's responsibility to read specification carefully when matching existing goods is desired.

## MANUFACTURING DEFECTS

Claims of manufacturing defects will not be entertained without prior consultation with DARRAN's warranty department. Unauthorized deduction in payment of invoices will not be allowed without prior factory approval. Unapproved deductions are subject to factor's late payment charges.

## DAMAGE CLAIMS

Claims of manufacturing damage or freight damage reported as nicks, dents, scratches, etc. after installation of furniture will not be covered under warranty or freight claim.

**ATTENTION:** Damage claims involving glass or stone components must be inspected and damage noted on delivering freight bill to qualify for replacement.

## REPAIR CHARGES

Factory authorization must be secured from DARRAN's warranty department prior to incurring repair charges. Warranty will utilize DARRAN's National Repair Service through the Furniture Medic Franchise ([www.furnituremedic.com](http://www.furnituremedic.com)).

Repair charge authorizations are based on:

- › Set travel rate
- › Average regional job rate
- › Factory set maximum repair time
- › Falsely reported defect claims are subject to local service charges being charged to dealer/distributor.

## FINISH MAINTENANCE

Wood office furniture and wood finishes can retain their natural beauty for life if proper care is taken and a stable environment is provided. Fluctuations in humidity and temperature cause panels and solid wood components to expand and contract and may lead to panel warpage and finish "checking" or cracking. Prolonged exposure of furniture to dry heat during winter months should be avoided. Careful examination of interior wood trim may indicate a damaging dry environment. If open joints, splits and cracks are appearing in trimwork consult with a HVAC professional for appropriate remedy.

DARRAN finishes are field repairable should damage occur. Professional furniture repair services are recommended. Regular cleaning with a non-silicone polish is recommended.

**ORDERING**

All orders should be emailed, mailed or transmitted by fax to:

DARRAN Furniture Industries, Inc.  
P.O. Box 7614  
High Point, NC 27264  
Email: orders@darran.com  
Fax: 336-861-6485

DARRAN will only accept orders from authorized Dealers. All orders must be accurate and detailed. All Quick Ship orders must contain Quick Ship product ONLY. Orders should be separated and submitted according to lead time. Orders must contain Quick Ship code "QS" or have designated Quick Ship lead time to ensure correct order entry. Orders that contain multiple lead time products will be entered as one order and scheduled with the most extended lead time.

**CREDIT APPROVAL**

All orders are subject to credit approval for open account. All new accounts must be approved by a local DARRAN Sales Representative and should submit current financial information and trade references to:

DARRAN Furniture Industries, Inc. ATTN: Credit Department  
P.O. Box 7614  
High Point, NC 27264  
Telephone: 336-861-2400 Toll Free: 800-334-7891  
Fax: 336-861-2512

Orders submitted without accounts pre-approval or credit approval are subject to acceptance with lead times scheduled only after approval dates.

**LEAD TIME SCHEDULE**

DARRAN cannot assign a firm lead time until Credit approval and order accuracy are complete. Extended lead times due to credit or information delays are the responsibility of the Buyer.

**ORDER DELAY / HOLD**

Due to the committed manufacturing cost on Quick Ship processes, DARRAN cannot delay or hold orders, either in process or after completion.

**CANCELLATION AND ORDER CHANGES - FEES**

Acknowledged orders are considered firm orders and therefore not subject to cancellation or change. However, in the event we are able to stop an order prior to manufacturing process, we will consider cancellation or changes with a reprocessing fee of \$40.00 Net. Exceptions: Quickship orders cannot be changed or canceled after the 3rd business date after acknowledgment. Qualified changes/cancellations will be assessed a \$40.00 Net processing fee.

Changes or cancellation of order with special options or custom quoted items are also subject to additional material and vendor fee costs, plus a DARRAN special/custom reprocessing fee of \$100 NET.

**ORDER MOVEUPS**

Should an original scheduled ship date need to be improved, the Factory must be contacted 15 business days prior to the desired ship date. Move ups are subject to schedule availability.

**ORDER ACKNOWLEDGMENT**

Upon credit approval your order will be acknowledged and identified by an order number. When making reference to your order, please use this order number. Your acknowledgment is a detailed description of our interpretation of your order, pricing, shipping information, and estimated delivery date.

If you have not received an Acknowledgment within 10 Days of order issue, contact Customer Service immediately. All Quick Ship order acknowledgments will be faxed or emailed upon request to speed processing. Please read your acknowledgment carefully for correctness and notify DARRAN immediately of any discrepancies. Failure to notify relieves DARRAN from error liability.

Order acknowledgment is the final agreement between DARRAN and the customer superseding all previous communications regarding the order. DARRAN will not be responsible for errors made on orders placed by phone without written confirmation.

**SELLING INFORMATION**

Possession of this price list does not in itself constitute the right to sell DARRAN products. DARRAN products are sold and distributed through authorized dealerships. Contact factory for a listing of local representatives and dealerships.

**INVOICE TERMS**

Standard terms are NET 30 days. Finance charges of 1-1/2% will be added to delinquent accounts after 45 Days and for each 30 Days thereafter until paid.

Complaints involving newly received merchandise must be reported within 10 days from receipt to qualify for full invoice remittance suspension or term extension. Otherwise only items in dispute can be suspended from payment of invoice within terms.

**WAREHOUSE/STORAGE**

DARRAN will determine order warehousing approvals on a case by case basis. Orders that can be accommodated will be limited to a max of 30 days storage and must be invoiced at time of storage. Orders that exceed factory storage capacity will be transferred to local storage facilities subject to current storage rates and handling-transit charges. Storage charges must be paid prior to order release to shipping.



**EXECUTIVE OFFICE & CONFERENCE ROOM  
FURNITURE**

**November 3, 2015 through November 2, 2020**

FSC Group 71

GSA CONTRACT NUMBER: GS-27F-001DA

Business Classification:

WBENC Certified Woman-Owned Small Business

DARRAN FURNITURE INDUSTRIES

2402 SHORE DRIVE

HIGH POINT, NC 27263

336.861.2400 FAX 336.861.6485

Business Classification:

Woman-Owned Small Business

On-line access to contract ordering information, terms and conditions, up-to-date pricing, and the option to create an electronic delivery order are available through GSA Advantage!, a menu driven database system. The INTERNET address for GSA Advantage is <http://www.fss.gsa.gov>

For more information on ordering from Federal Supply Schedules click on the FSS Schedules button at <http://www.fss.gsa.gov>

**1a. Special Item Number**

711-8: Executive Office Furniture

711-9: Executive Conference Room Furniture

711-11: Tables and Accessories

711-16: Upholstered Seating

711-18: Multi-purpose Seating

**2. Maximum Order Limitations:**

711-8 \$500,000

711-9 \$500,000

711-11 \$500,000

711-16 \$300,000

711-18 \$200,000

**3. Minimum Order: \$100**

**4. Geographic Coverage:** 48 Contiguous States and the District of Columbia

**5. Point of Production:** High Point, North Carolina (Randolph County)

**6. Discount:** Prices shown herein are List (Discount is 56.9% Off List)

**7. Quantity Discounts:**

• \$467,837 List to \$1,000,000 List = 59.70%

• \$1,000,001 List to \$1,315,789 List = 61.70%

**8. Payment Terms:** ½% - Net 15 Days, Net 30 Days

**8a. Terms and Conditions of Government Credit Card Acceptance:**

a. No discount allowed for payment by Government Purchase Card

b. Provide commercial credit card number

c. Provide commercial credit card expiration date

d. Provide individual's name as it appears on

credit card

e. Provide telephone number of individual to whom credit is issued

**9a. Government Purchase Cards are accepted below the Micro Purchase Threshold.**

**9b. Government Purchase Cards are accepted above the Micro Purchase Threshold.**

**10. Foreign Terms:** None

**11a. Time of Delivery:** Regular Product: 60 - 90 days after receipt of order

Quick Ship Program: Contact DARRAN

**11b. Quick Ship Program:** Items available for expedited delivery are included in main Price Lists.

**11c. Overnight and 2-day delivery:** N/A

**11d. Urgent Requirements:** Will be considered on an individual basis. Contact DARRAN for details.

**12. FOB Point:** All destinations are limited to Commercial docks only. Carriers may refuse non-dock deliveries.

**12a. Freight Prices:**

a. All prices shown are suggested list prices with freight included where indicated.

b. Freight allows delivery to one qualified destination.

c. Within the Continental USA, all orders above \$1,500 net are shipped FOB factory, freight prepaid and allowed. All orders less than \$1,500 net will be subject to a \$100 net freight charge.

**13. Ordering Address:**

DARRAN Furniture Industries

P.O. Box 7614

High Point, NC 27264

Ph: 800.334.7891

Fax: 336.861.6485

**13a. Payment Address:**

Rosenthal & Rosenthal Southeast

P.O. Box 733909

Dallas, TX 75373-3909

**14. Warranty Provision:** Limited Lifetime (Contact DARRAN for details)

**15. Export Packing Charges:** Quoted on request

**13. Terms and Conditions: Order Cancellation / Changes.**

Restocking/Returns: No merchandise may be returned without a return authorization and shipping instructions. No credit or allowance will be given for repairs to defective materials unless DARRAN has given authority to make such repairs. A restocking charge of 25% will apply.

Cancellation: No cost prior to production. After

## gsa customer information

production has begun, only actual cost incurred will be billed to the Government that cannot be recovered through resale in 6 months

**14. Terms and Condition of Rental, Maintenance and Repair: Consult the Factory.**

**15. Terms and Conditions of Installation:** Installation by a Third party to be quoted on a per job basis. The ordering must specify what ranges of installation services are required.

**16. Terms and Conditions of Repair Parts:** Contact DARRAN for details.

**17. List of Service and distribution points:** Contact DARRAN for details..

**18. Preventative Maintenance:** Information enclosed with product.

**19. List of Participating Dealers:** Contact DARRAN for details.

**23. Environmental Attributes:** DARRAN is compliant with EPA standards. All plywood core material is CARB 2 compliant and contains recycled content. All DARRAN Casegood Products are BIFMA Level 2 Certified. DARRAN is FSC CoC Certified and our products are MAS Certified for Indoor Air Quality.

**23a. Recyclable and Recycled Content Packaging:**

The corrugated packaging that is supplied to DARRAN, meets the federal mandate that requires the paperboard to be composed of 30%-50% recycled paper, and in some cases the recycled content is close to 100%.

**23b. Chemical Emission:** DARRAN finishes its products in an ENVI-CT Finish. (Environmental Coatings Technology). DARRAN's seating is finished with a low VOC Conversion Varnish and the casegoods are finished with a formaldehyde free, low VOC Urethane finish. These ENVI-CT finishes allow DARRAN's products to be MAS Certified Green under the ANSI BIFMA X7.1 Standard. Products assist with LEED 4.5 Credit.

**23c. Vapor Emissions:** DARRAN's ENVI-CT finishes use the latest environmental coatings technology to provide lasting durability and exceptional clarity. The ENVI-CT finishes allows DARRAN casegoods to be MAS Certified Green meeting LEED Credit 4.5.

**24a. Duns Number:** 08-363-5318

**24b. Cage Code:** 0Y-6B6

**24c. Federal ID Number:** 56-117-1971

**24d. NAICS Code:** 337211

**25. SAM Network:** DARRAN is registered

**SHIPPING SCHEDULE**

DARRAN will make every effort to match shipping requests that are clearly noted on orders. However, the company accepts no liability for failure of delivery and/or delay if the occurrence is outside the control of DARRAN. To ensure specific time arrival, we recommend arranging single stop, designated load carriers. Less than trailer load (LTL) shipments cannot be coordinated for a guaranteed delivery time.

**PRICES**

- › All prices shown are suggested list prices with freight included where indicated.
- › Freight allows delivery to one qualified destination.
- › Within the Continental USA, all orders above \$1,500 net are shipped FOB factory, freight prepaid and allowed. All orders less than \$1,500 net will be subject to a \$100 net freight charge.
- › If shipment unloading takes longer than the specified 3 hours, a charge of \$100 per hour will be billed.

**CALL BEFORE DELIVERY REQUEST**

DARRAN will arrange for carriers to call before delivery when requested.

Important Non-Qualified Destinations DARRAN Prepaid Freight Pricing does not include delivery to:

- › Residential Areas
- › Restricted Commercial Areas
- › No Dock Locations
- › Inside delivery/setup service

Orders received and installed without professional Furniture Installers voids all Warranty Coverage.

**CARRIER SELECTION**

DARRAN selects and uses only carriers specialized in furniture transportation. Customer requested carriers can be authorized using Freight Excluded pricing with invoice add-on.

**EXPRESS CARRIERS**

DARRAN assumes no responsibility for charges incurred caused by delayed or late deliveries. If a guaranteed delivery time is needed please call DARRAN Customer Service at 1.800.334.7891 for a quote as additional charges will apply. Weekend or after-hours deliveries are subject to additional charges.

## SEATING FABRIC & LEATHER PROGRAMS

DARRAN has partnered with some of the most prestigious fabric suppliers of the office furniture industry to bring you quality fabrics that are engaging designs, environmentally friendly, and durable for years to come. The majority of fabrics we have graded-in are in heavy supply making it most likely available on our Quickship program, however, we cannot guarantee stock. If you do not see the fabric you wish to include in a project, please contact our Factory to see if this pattern can be graded-in at 800.334.7891.

### FABRICS

Please visit our Seating Fabrics page at [darran.com/textilesleather](http://darran.com/textilesleather)

Momentum Textiles	800.366.6839
<a href="http://www.momentumtextiles.com">www.momentumtextiles.com</a>	
Maharam	800.645.3943
<a href="http://www.maharam.com">www.maharam.com</a>	
CFStinson	800.841.6279
<a href="http://www.cfstinson.com">www.cfstinson.com</a>	
Paul Brayton	800.882.4720
<a href="http://www.paulbraytondesigns.com">www.paulbraytondesigns.com</a>	
Knoll Textiles	866.565.5858
<a href="http://www.knolltextiles.com">www.knolltextiles.com</a>	
DesignTex	800.797.4949
<a href="http://www.designtex.com">www.designtex.com</a>	
Mayer Fabrics	800.428.4415
<a href="http://www.mayerfabrics.com">www.mayerfabrics.com</a>	

### LEATHERS

Please visit our Seating Fabrics page at [darran.com/textilesleather](http://darran.com/textilesleather)

Wollsdorf	336.884.5005
<a href="http://www.wollsdorf.com">www.wollsdorf.com</a>	
Elmo Leather	732.549.5151
<a href="http://www.elmoleather.com">www.elmoleather.com</a>	

Application instructions must be specified on the purchase order or COM / COL submission form. In the absence of application instructions, DARRAN will apply materials accordingly.

### CAL117

All DARRAN seating products conform to California Technical Bulletin 117 as a minimum standard.

### CAL133

To meet the California Technical Bulletin 133 flammability regulation, a combination of proper materials must be used to pass, as it tests the fire resistance of a finished product. Flame resistant fabric, a fire blocker material and special foam must be used to pass CAL133 fire codes.

Fabric Width	Plain Fabric	2"-14" Repeat
54"	0	15%
53"	6%	19%
52"	13%	23%
51"	19%	26%
50"	25%	30%
49"	30%	35%
48"	35%	40%
47"	45%	50%

Testing is available for all seating products with the following fees and considerations:

- › If laboratory certification is not required, any style can be manufactured to comply with California Technical Bulletin 133 for \$ 75 list per yard required. (Customer's Own Materials must factor in additional yardage requirements based on repeat.)
- › The purchase order must clearly indicate the requirement of California Technical Bulletin 133.
- › If laboratory California Technical Bulletin 133 certification is required, the cost of testing a chair is \$820 NET, plus the cost of the chair and covering material.
- › An additional lead time of 4 to 6 weeks is required for testing for CAL133.
- › Once testing is completed, we will provide a certification letter specific to the sample tested for CAL133.
- › DARRAN's manufacturing procedures for California TB 133 compliance are based on the testing of representative styles with specific fabrics. Please contact Customer Service for an updated list of tested models.
- › A copy of test certification is available upon request.

### COMBINATION FABRICS

DARRAN is pleased to offer customers the design freedom of combination fabrics. When using fabric, vinyl or leather combinations, pricing will be as follows:

- › When combining two materials of the same grade, pricing will be specified grade + 5%.
- › If combining two materials of different grades or leather/fabric combination, use the highest grade/price + 5%.
- › If using COM or COL, pricing will be COM or COL + 5%. If both COM + COL are used in combination, use COL + 5%

### COM/COL ORDERING INSTRUCTIONS

Please complete the COM Submission Form prior to ordering the fabric from the supplier. All COM fabrics must be approved prior to order submission. Please refer to our website or contact DARRAN Seating Customer Service for an updated list of preapproved COM fabrics. Application instructions must be specified on the purchase order or COM/COL submission form. In the absence of application instructions, DARRAN will apply materials in the best manner and cannot be held responsible for tailoring or application objections after upholstering. COM orders will be scheduled for production after receipt of the material. Packages must be clearly marked and the fabric must be first quality, continuous yardage.

### COM/COL YARDAGE REQUIREMENTS

The yardage requirements stated in this price list for each style are calculated using 54" wide, non-directional fabrics. For fabrics with a different width or for patterns with repeats, please refer to the below chart to calculate the additional percent of fabric required:

15"-19" Repeat	20"-27" Repeat	28"-36" Repeat
20%	25%	30%
24%	28%	36%
28%	33%	38%
31%	36%	41%
35%	40%	45%
40%	45%	50%
45%	50%	55%
55%	58%	65%

NOTE: Prior To Completion Of This Form, Please Refer To Our Graded In Materials Program For Preapproved Fabrics/Leathers.

**COM/COL APPROVAL**

DARRAN Furniture Industries  
 2402 Shore Street, High Point, NC 27263  
 ATTN: Seating Division / COM/COL Approval  
 TAG: DARRAN Purchase Order Number

**SHIPPING APPROVED COM/COL MATERIALS**

DARRAN Furniture Industries  
 2402 Shore Street, High Point, NC 27263  
 ATTN: Seating Division / COM/COL Approval  
 TAG: DARRAN Purchase Order Number

Please complete this form, attach a 6" x 6" sample and mail to the COM/COL APPROVAL address shown above. This form can also be downloaded from our website at [www.darran.com/leathers](http://www.darran.com/leathers) OR [www.darran.com/fabrics](http://www.darran.com/fabrics)

Purchase Order # _____	Chair Style _____
Dealer's Name _____	Manufacturer _____
Contact _____	Pattern Name _____
Address _____	Pattern Color _____
Telephone _____	Content _____
Email _____	Repeat _____

Please specify any special requirements and check the application below.

---



---

**COM/COL**

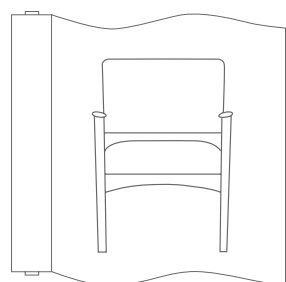

**RAILROAD**

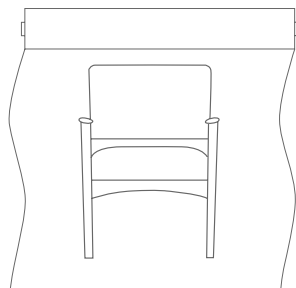

**SETUP**

In the absence of application instructions, DARRAN will apply the material in the best manner and cannot be held responsible for tailoring or application objections after upholstering. Unless otherwise instructed on the purchase order, excess COM materials will be recycled at the discretion of DARRAN after six months of the original product ship date.

The COM approval solely pertains to the application of the fabric onto the specified DARRAN seating product. DARRAN's approval or acceptance does not constitute any responsibility or warranty to the overall appearance, durability, flammability, defects, dye lot variations or colorfastness of the COM. It is the customer's responsibility to ensure the COM meets CAL 117 compliance and are first quality continuous goods.

**ATTACH 6" X 6"  
 FABRIC/LEATHER  
 SAMPLE HERE**

**NOTE**  
 Actual Fabric/Leather samples needed instead of digital images. If digital images are sent in lieu of samples, DARRAN will only verify the pattern and will not take responsibility for color variances that cannot be verified due to printing restrictions

**FINISHES**

WAC Amber Cherry  
 WRC Caramel Cherry  
 WIC Crimson Cherry  
 WEC Ebony on Beech  
 WHC Honey Cherry  
 WOC Koko Cherry  
 WSC Scotch Cherry  
 WAM Alabaster Maple  
 WCM Clear Maple  
 WWM Wheat Maple  
 WBO Blush Oak  
 WMO Mocha Oak  
 WTO Toast Oak  
 WWO Wheat Oak  
 WEW Executive Walnut  
 GWG Gunstock Walnut  
 WBW Henna Walnut  
 WJW Judicial Walnut  
 WNW Natural Walnut  
 TBCO Baby's Cheek  
 TBSW Brown Sugar  
 TFBO Fun Blonde  
 TFBW French Bordeaux  
 TLLW Luscious Lager  
 TOBW Organic Brown  
 WWP Designer White Paint  
 WEM Ebony Maple Paint

Send 3x3 or larger finish chip for color match. Custom finish upcharge is 3% or \$250 Net (whichever is greater).

**FINISH**

ENVI-CT Green Certified European Technology Coatings Finish.

Frames are constructed of kiln-dried European beech and coordinate with all DARRAN casegood finishes.

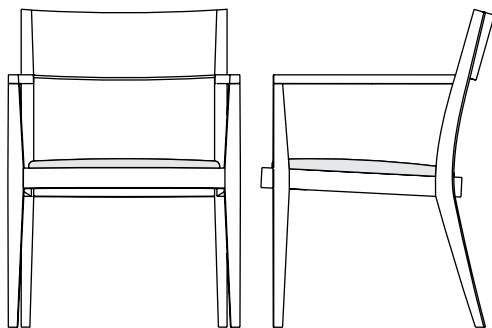

**MAXTON OPEN WOOD BACK**

**STANDARD FEATURES**

- Frame is constructed of kiln-dried European beech, PEFC Certified sustainable yield, perpetuating premium quality and durability.
- Joints are securely fastened with mortise and tenon joinery as well as corner block construction.
- MAS IAQ Certified
- Open Arms
- Open Wood Back
- Seat cushions are made of high resiliency foam.

- Seat rails are reinforced with tenon and groove corner blocks and cleats.
- Seat suspension is constructed of 3/4" thick Baltic Birch plywood.
- Sheet webbing
- Upholstered Seat

[CLICK HERE TO VIEW PRODUCT INDEX](#)

**1 SELECT UPHOLSTERY GRADE**

STYLE	COM	COL	1	2	3	4	5	6	7	8	9	10	11/L1	12	13/L2
EMX2332OWB03	828	846	870	884	898	912	926	940	954	968	982	996	1010	1024	1052

**DIMENSIONS W X D X H**

23 -1/4" x 23" x 32"  
 Arm Height: 25 -1/4"  
 Seat Height: 18"  
 Inside Seat Depth: 20"  
 Inside Seat Width: 21"

**UPHOLSTERY REQUIREMENTS**

Fabric yds: 0.75  
 Leather Sq. Ft.: 13.5  
 Carton Weight: 25 lbs.

**2 SELECT A FINISH      3 OPTIONS      4 COMBINATION**

- WAC Amber Cherry
- WRC Caramel Cherry
- WIC Crimson Cherry
- WEC Ebony
- WHC Honey Cherry
- WOC KoKo Cherry
- WSC Scotch Cherry
- WAM Alabaster Maple
- WCM Clear Maple
- WEM Ebony
- WWM Wheat Maple
- WBO Blush Oak
- WMO Mocha Oak
- WTO Toast Oak
- WWO Wheat Oak
- WEW Executive Walnut
- WGW Gunstock Walnut
- WBW Henna Walnut
- WJW Judicial Walnut
- WNW Natural Walnut
- TGLV Gray Luster Walnut
- TSTV Studio Teak Walnut
- TBCO Baby's Cheek
- TBSW Brown Sugar
- TFBO Fun Blonde
- TFBW French Bordeaux
- TLLW Luscious Lager
- TOBW Organic Brown
- WWP Designer White

Combination  
 Fabric Option  
 Not Available

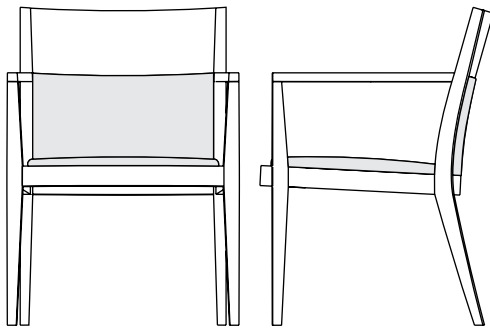

**MAXTON HALF UPHOLSTERED BACK**

**STANDARD FEATURES**

- Frame is constructed of kiln-dried European beech, PEFC Certified sustainable yield, perpetuating premium quality and durability.
- Half Upholstered/Half Wood Back
- Joints are securely fastened with mortise and tenon joinery as well as corner block construction.
- MAS IAQ Certified
- Open Arms
- Seat cushions are made of high resiliency foam.

- Seat rails are reinforced with tenon and groove corner blocks and cleats.
- Seat suspension is constructed of 3/4" thick Baltic Birch plywood.
- Sheet webbing
- Upholstered Seat

[CLICK HERE TO VIEW PRODUCT INDEX](#)

**1 SELECT UPHOLSTERY GRADE**

STYLE	COM	COL	1	2	3	4	5	6	7	8	9	10	11/L1	12	13/L2
EMX2332HUB05	910	935	979	1002	1025	1048	1071	1094	1117	1140	1163	1186	1209	1232	1278

**DIMENSIONS W X D X H**

23 -1/4" x 23" x 32"  
 Arm Height: 25 -1/4"  
 Seat Height: 18"  
 Inside Seat Depth: 20"  
 Inside Seat Width: 21"

**UPHOLSTERY REQUIREMENTS**

Fabric yds: 1.25  
 Leather Sq. Ft.: 22.5  
 Carton Weight: 25 lbs.

**2 SELECT A FINISH      3 OPTIONS      4 COMBINATION**

- WAC Amber Cherry
- WRC Caramel Cherry
- WIC Crimson Cherry
- WEC Ebony
- WHC Honey Cherry
- WOC KoKo Cherry
- WSC Scotch Cherry
- WAM Alabaster Maple
- WCM Clear Maple
- WEM Ebony
- WWM Wheat Maple
- WBO Blush Oak
- WMO Mocha Oak
- WTO Toast Oak
- WWO Wheat Oak
- WEW Executive Walnut
- WGW Gunstock Walnut
- WBW Henna Walnut
- WJW Judicial Walnut
- WNW Natural Walnut
- TGLV Gray Luster Walnut
- TSTV Studio Teak Walnut
- TBCO Baby's Cheek
- TBSW Brown Sugar
- TFBO Fun Blonde
- TFBW French Bordeaux
- TLLW Luscious Lager
- TOBW Organic Brown
- WWP Designer White

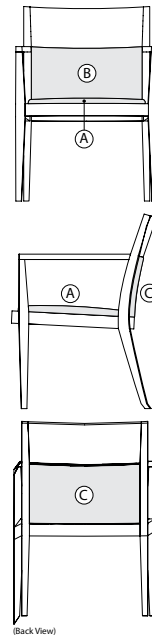

**DARRAN is pleased to offer customers the design freedom of combination fabrics. When using fabric, vinyl or leather combinations, pricing/yardage requirements will be as follows:**

- A Seat 1 yd(s).
- B Inside Back 0.25 yd(s)
- C Outside Back 0.25 yd(s)

- When combining two materials of the same grade, pricing will be specified grade + 5%
- If combining two materials of different grades or leather/fabric combination, use the highest grade/price + 5%
- If using COM or COL, pricing will be COM or COL + 5%.
- If both COM + COL are used in combination, use COL + 5%.

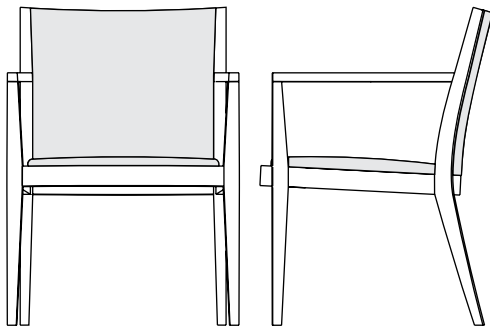

**MAXTON FULLY UPHOLSTERED BACK**

**STANDARD FEATURES**

- Frame is constructed of kiln-dried European beech, PEFC Certified sustainable yield, perpetuating premium quality and durability.
- Fully Upholstered Back
- Joints are securely fastened with mortise and tenon joinery as well as corner block construction.
- MAS IAQ Certified
- Open Arms
- Seat cushions are made of high resiliency foam.

- Seat rails are reinforced with tenon and groove corner blocks and cleats.
- Seat suspension in constructed of 3/4" thick Baltic Birch plywood.
- Sheet webbing
- Upholstered Seat

[CLICK HERE TO VIEW PRODUCT INDEX](#)

**1 SELECT UPHOLSTERY GRADE**

STYLE	COM	COL	1	2	3	4	5	6	7	8	9	10	11/L1	12	13/L2
EMX2332FUB07	890	921	987	1019	1051	1083	1115	1147	1179	1211	1243	1275	1307	1339	1403

**DIMENSIONS W X D X H**

23 -1/4" x 23" x 32"  
 Arm Height: 25 -1/4"  
 Seat Height: 18"  
 Inside Seat Depth: 20"  
 Inside Seat Width: 21"

**UPHOLSTERY REQUIREMENTS**

Fabric yds: 1.75  
 Leather Sq. Ft.: 31.5  
 Carton Weight: 25 lbs.

**2 SELECT A FINISH      3 OPTIONS      4 COMBINATION**

- WAC Amber Cherry
- WRC Caramel Cherry
- WIC Crimson Cherry
- WEC Ebony
- WHC Honey Cherry
- WOC KoKo Cherry
- WSC Scotch Cherry
- WAM Alabaster Maple
- WCM Clear Maple
- WEM Ebony
- WWM Wheat Maple
- WBO Blush Oak
- WMO Mocha Oak
- WTO Toast Oak
- WWO Wheat Oak
- WEW Executive Walnut
- WGW Gunstock Walnut
- WBW Henna Walnut
- WJW Judicial Walnut
- WNW Natural Walnut
- TGLV Gray Luster Walnut
- TSTV Studio Teak Walnut
- TBCO Baby's Cheek
- TBSW Brown Sugar
- TFBO Fun Blonde
- TFBW French Bordeaux
- TLLW Luscious Lager
- TOBW Organic Brown
- WWP Designer White

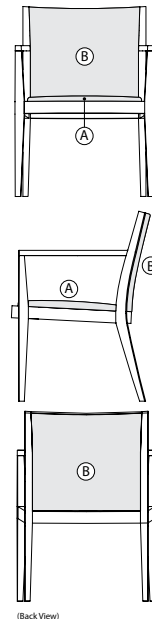

DARRAN is pleased to offer customers the design freedom of combination fabrics. When using fabric, vinyl or leather combinations, pricing/yardage requirements will be as follows:

A Seat 1 yd(s).  
 B Inside/Outside Back 1.5 yd(s).

- When combining two materials of the same grade, pricing will be specified grade + 5%
- If combining two materials of different grades or leather/fabric combination, use the highest grade/price + 5%
- If using COM or COL, pricing will be COM or COL + 5%.
- If both COM + COL are used in combination, use COL + 5%.



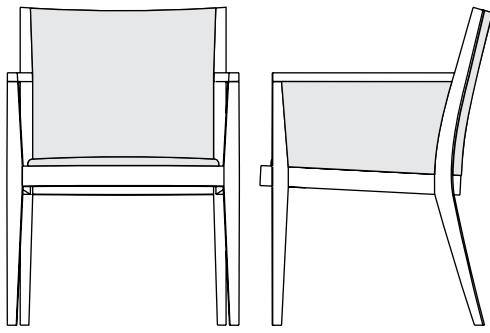

**MAXTON FULLY UPH. BACK / ARMS**

**STANDARD FEATURES**

- Frame is constructed of kiln-dried European beech, PEFC Certified sustainable yield, perpetuating premium quality and durability.
- Half Upholstered/Half Wood Back
- Joints are securely fastened with mortise and tenon joinery as well as corner block construction.
- MAS IAQ Certified
- Seat cushions are made of high resiliency foam.
- Seat rails are reinforced with tenon and groove

- corner blocks and cleats.
- Seat suspension in constructed of 3/4" thick Baltic Birch plywood.
- Sheet webbing
- Upholstered Arms
- Upholstered Seat

[CLICK HERE TO VIEW PRODUCT INDEX](#)

**1 SELECT UPHOLSTERY GRADE**

STYLE	COM	COL	1	2	3	4	5	6	7	8	9	10	11/L1	12	13/L2
EMX2332UPA07	1084	1138	1195	1232	1269	1306	1343	1380	1417	1454	1491	1565	1602	1676	1644

**DIMENSIONS W X D X H**

23 -1/4" x 23" x 32"  
 Arm Height: 25 -1/4"  
 Seat Height: 18"  
 Inside Seat Depth: 20"  
 Inside Seat Width: 21"

**UPHOLSTERY REQUIREMENTS**

Fabric yds: 2  
 Leather Sq. Ft.: 36  
 Carton Weight: 25 lbs.

**2 SELECT A FINISH | 3 OPTIONS | 4 COMBINATION**

- WAC Amber Cherry
- WRC Caramel Cherry
- WIC Crimson Cherry
- WEC Ebony
- WHC Honey Cherry
- WOC KoKo Cherry
- WSC Scotch Cherry
- WAM Alabaster Maple
- WCM Clear Maple
- WEM Ebony
- WWM Wheat Maple
- WBO Blush Oak
- WMO Mocha Oak
- WTO Toast Oak
- WWO Wheat Oak
- WEW Executive Walnut
- WGW Gunstock Walnut
- WBW Henna Walnut
- WJW Judicial Walnut
- WNW Natural Walnut
- TGLV Gray Luster Walnut
- TSTV Studio Teak Walnut
- TBCO Baby's Cheek
- TBSW Brown Sugar
- TFBO Fun Blonde
- TFBW French Bordeaux
- TLLW Luscious Lager
- TOBW Organic Brown
- WWP Designer White

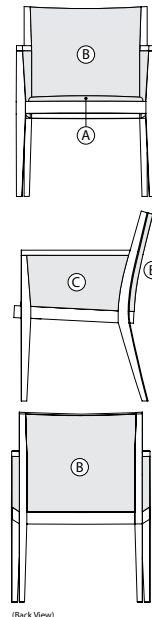

**DARRAN is pleased to offer customers the design freedom of combination fabrics. When using fabric, vinyl or leather combinations, pricing/yardage requirements will be as follows:**

- A Seat 1 yd(s).
- B Inside/Outside Back 1.5 yd(s).
- C Arms 1 yd(s).

- When combining two materials of the same grade, pricing will be specified grade + 5%
- If combining two materials of different grades or leather/fabric combination, use the highest grade/price + 5%
- If using COM or COL, pricing will be COM or COL + 5%.
- If both COM + COL are used in combination, use COL + 5%.