



Posh Price List

Effective April 1, 2024

Designed By John Stafford & Chris Carter

Date	Page	Modification	Description
04.04.24		Updated Pricing	

Fabric seat & leather program.....1
Seating Specification4
Finishes5
Executive Chair6

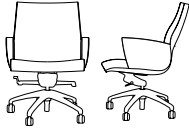

Page 6
Upholstered Arms
Mid-Back



Page 7
Upholstered Arms
High-Back

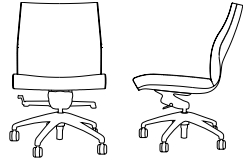

Page 8
Armless
Mid-Back

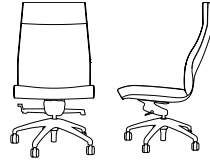

Page 9
Armless
High-Back

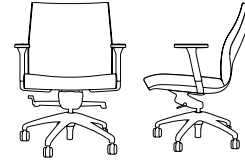

Page 10
Adjustable Ergonomic Arms
Mid-Back

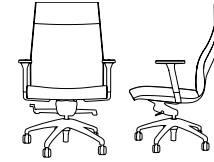

Page 11
Adjustable Ergonomic Arms
High-Back

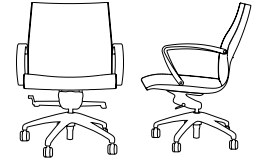

Page 12
Urethane Loop Arms
Mid-Back

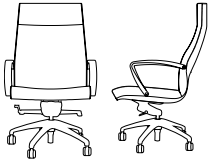

Page 13
Urethane Loop Arms
High-Back

Seating & fabric leather program

DARRAN has partnered with some of the most prestigious fabric suppliers of the office furniture industry to bring you quality fabrics that are engaging designs, environmentally friendly and durable for years to come. The majority of fabrics we have graded-in are in heavy supply making it most likely available on our Quickship however, we cannot guarantee stock. If you do not see the fabric you wish to include in a project, please contact Customer Service to see if this pattern can be graded in at 800.334.7891.

Fabrics & Leathers

Please visit our Seating Fabrics page at darran.com/textilesleather

Camira
www.camirafabrics.com
800.334.789

Wollsdorf
www.wollsdorf.com
336.884.5005

CFStinson
www.cfstinson.com
800.841.6279

Green Hides
www.greenhides.com
336.315.9720

DesignTex
www.designtex.com
800.797.4949

Kvadrat
www.kvadrat.fabrics.com
+45 8953 1866

Maharam
www.maharam.com
800.645.3943

Momentum Textiles
www.momentumtextiles.com
800.366.6839

Ultrafabrics
www.ultrafabricsinc.com
800.334.7891

Application instructions must be specified on the purchase order or COM / COL submission form. In the absence of application instructions, DARRAN will apply materials accordingly.

CAL117

All DARRAN seating products conform to California Technical Bulletin 117 as a minimum standard.

CAL133

To meet the California Technical Bulletin 133 flammability regulation, a combination of proper materials must be used to pass, as it tests the fire resistance of a finished product. Flame resistant fabric, a fire blocker material and special foam must be used to pass CAL133 fire codes.

Testing is available for all seating products with the following fees and considerations:

- If laboratory certification is not required, any style can be manufactured to comply with California Technical Bulletin 133 for \$75 list per yard required. (Customer's Own Materials must factor in additional yardage requirements based on repeat.)
- The purchase order must clearly indicate the requirement of California Technical Bulletin 133
- If laboratory California Technical Bulletin 133 certification is required, the cost of testing a chair is \$820 NET, plus the cost of the chair and covering material.
- An additional lead time of 4 to 6 weeks is required for testing for CAL133.
- Once testing is completed, we will provide a certification letter specific to the sample tested for CAL133.
- DARRAN's manufacturing procedures for California TB 133 compliance are based on the testing of representative style with specific fabrics. Please contact Customer Service for an updated list of tested models.
- A copy of test certification is available upon request.

Combination fabrics

DARRAN is pleased to offer customers the design freedom of combination fabrics. When using fabric, vinyl or leather combinations, pricing will be as follows:

- When combining two materials of the same grade, pricing will be specified grade + 5%.
- If combining two materials of different grades or leather/ fabric combination, use the highest grade/price + 5%.
- If using COM or COL, pricing will be COM or COL + 5%. If both COM + COL are used in combination, use COL + 5%

COM/COL ordering instructions

Please complete the COM Submission Form prior to ordering the fabric from the supplier. All COM fabrics must be approved prior to order submission. Please refer to our website or contact DARRAN Seating Customer Service for an updated list of preapproved COM fabrics. Application instructions must be specified on the purchase order or COM/COL approval form. In the absence of application instructions, DARRAN will apply materials in the best manner and cannot be held responsible for tailoring or application objections after upholstery. COM orders will be scheduled for production after receipt of the material. Packages must be clearly marked and the fabric must be first quality, continuous yardage.

COM/COL yardage requirements

The yardage requirements stated in this price list for each style are calculated using 54” wide, non-directional fabrics. For fabrics with a different width or for patterns with repeats, please refer to the below chart to calculate the additional percent of fabric required:

Fabric Width	Plain Fabric	2”- 14” Repeat	15”- 19”Repeat	20”- 27”Repeat	28”- 36” Repeat
54”	0	15%	20%	25%	30%
53”	6%	19%	24%	28%	36%
52”	13%	23%	28%	33%	38%
51”	19%	26%	31%	36%	41%
50”	25%	30%	35%	40%	45%
49”	30%	35%	40%	45%	50%
48”	35%	40%	45%	50%	55%
47”	45%	50%	55%	58%	65%

DARRAN®

NOTE: Prior To Completion Of This Form, Please Refer To Our Graded In Materials Program For Preapproved Fabrics/Leathers.

COM/COL Approval

DARRAN Furniture Industries
2402 Shore Street, High Point, NC 27263
ATTN: Seating Division / COM/COL Approval
TAG: DARRAN Quote Number

Shipping approved COM/COL materials

DARRAN Furniture Industries
2402 Shore Street, High Point, NC 27263
ATTN: Seating Division / COM/COL Approval
TAG: DARRAN Quote Number

Please complete this form, attach a 6"x 6" sample and mail to the COM/COL APPROVAL address shown above.
This form can also be downloaded from our website at www.darran.com/leathers OR www.darran.com/fabrics

Quote # _____

Dealer's Name _____

Contact _____

Address _____

Telephone _____

Email _____

Chair Stlye _____

Manufacturer _____

Pattern Name _____

Pattern Color _____

Content _____

Repeat _____

Please specify any special requirements and check the application above.

Posh Fabric & Leather Program

ATTACH 6" X 6" FABRIC/LEATHER SAMPLE HERE

NOTE

Actual Fabric/Leather samples needed instead of digital images. If digital images are sent in lieu of samples, DARRAN will only verify the pattern and will not take responsibility for color variances that cannot be verified due to printing limitations.

In the absence of application instructions, DARRAN will apply the material in the best manner and cannot be held responsible for tailoring or application objections after upholstering.

Unless otherwise instructed on the purchase order, excess COM materials will be recycled at the discretion of DARRAN after six months of the original product ship date.

The COM approval solely pertains to the application of the fabric onto the specified DARRAN seating product. DARRAN's approval or acceptance does not constitute any responsibility or warranty to the overall appearance, durability, flammability, defects, dye lot variations or colorfastness of the COM. It is the customer's responsibility to ensure the COM meets CAL 117 compliance and are first quality continuous goods.

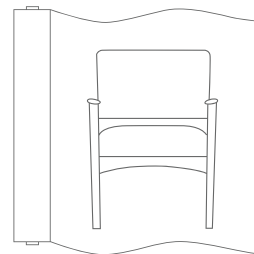

RAILROAD

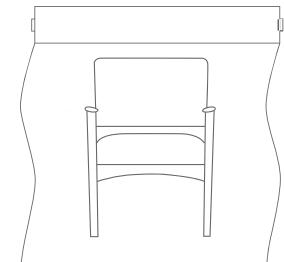

SETUP

Overall Width = 25"
 Overall Depth = 24-1/2"
 Height = 38-1/2" - 41-1/4"
 Seat Width = 22-1/2"
 Seat Depth = 18-1/2"
 Seat Height = 18-1/4" - 21-1/2"
 Arm Height = 27-1/2" - 30-3/4"

Frame Construction: 9-ply hardwood molded plywood frame construction for superior strength and durability. Frames are precision cut on CNC routers to insure uniformity.

Cushioning: High density CAL117 polyurethane foams of varying compression are laminated together to provide long term comfort.

Upholstered Arms: 2" wide upholstered panel arms, urethane coated loop arms, adjustable T arms and armless versions provide options for multiple use applications.

Adjustable Urethane Arms: Black adjustable ergonomic arms are available with spring loaded height adjustment and button activation. Arms are angled at 15 degrees with an adjustable arm pad for additional comfort and ergonomic support. Arms adjust 3-1/4" in height and 1-1/2" in width.

Bases: 26" diameter, available in Polished Aluminum (Standard), Black or Wood.

Casters: 60mm diameter casters are standard and promote increased mobility.

Carpet casters are standard. For hard floor surfaces specify CST20 - no upcharge.

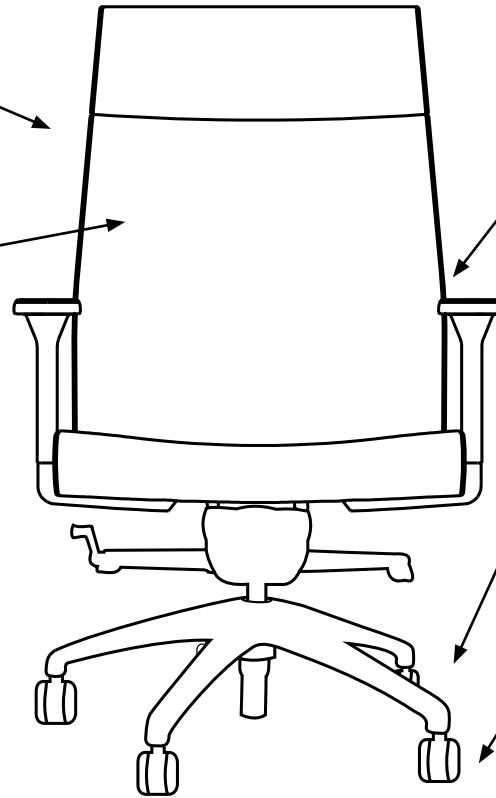

Upholstered Arms
(Mid-Back or High-Back)

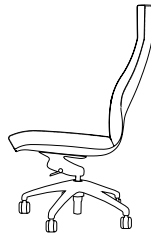

Armless
(Mid-Back or High-Back)



Adjustable Arms
(Mid-Back or High-Back)



Urethane Loop Arms
(Mid-Back or High-Back)

Posh's thin profile of subtle curves and signature channel back design provides an elegant executive seating solution for any office environment. Versatility in options, and highback / midback chair designs allow customers to specify Posh for mid-management, upper executives, and conferencing applications. Posh is offered in armless, upholstered, adjustable, and black urethane arms.

Knee tilt swivel mechanisms

The Knee-tilt mechanism features an advanced forward pivot point that reduces leg tilt with a 16 degree seat angle and a 25 degree back angle tilt. The mechanism locks in task and reclines positions with side tension adjustment. height adjustment and tilt tensions are also provided.

DARRAN®

Posh Finishes

(For base options only)



GWL Designer White

WAM Alabaster Maple

WCM Clear Maple

WLF Lofty Oak

WSO Salted Oak

TBCO Baby's Cheek

WNF Natural Oak

SSM Seattle Mist



TSTV Studio Teak Walnut

WHC Honey Cherry

WGW Gunstock Walnut

WAC Amber Cherry

TBSW Brown Sugar

WMF Mocha Oak

TSLV Skyline Walnut

WNW Natural Walnut



WEW Executive Walnut

WIC Crimson Cherry

GOC KoKo Cherry

WBW Henna Walnut



Finish

Welltech Finish delivers a superior furniture coating with exceptional performance that can withstand stringent cleaning agents and possesses unparalleled durability, allowing DARRAN to provide lasting, sustainable products to our customers.

Posh

Upholstered Arms
Mid-Back

[Click here to view statement of line](#)

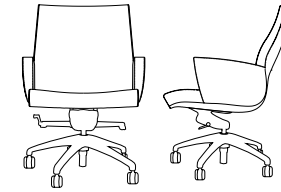

1 Model

PSH9825UAM04

w" x d" x h"
25 x 24.5 x 37.75-40.5
Arm Height 27 -1/2" - 30 -3/4"
Seat Height 18 -1/4" - 21 -1/2"
Inside Seat Depth 18 -1/2"
Inside Seat Width 22 -1/2"

COM	COL	1	2	3	4	5	6	7	8	9	10	11/L1	12	13/L2
2357	2427	2478	2537	2596	2655	2714	2773	2832	2891	2950	3009	3068	3127	3245

Upholstery Requirements
Fabric yds: 3.25 Leather Sq. Ft.: 58.5
Carton Weight: 55

Product Features

- 2" wide upholstered arms
- 26" diameter polished aluminum base
- 9-ply molded plywood frame
- High density CAL117 polyurethane foams of varying compression are laminated together to provide long term comfort.
- Large 60mm diameter casters are standard and promote increased mobility.
- Knee tilt swivel w/ forward pivot point

2 Select Finish

[Click to view finishes](#)

Finishes N/A

3 Combination Fabrics

[Click to view finishes](#)

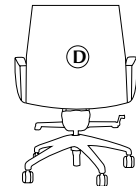
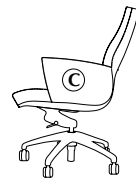
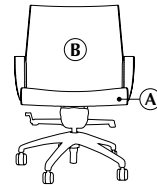

DARRAN is pleased to offer customers the design freedom of combination fabrics. When using fabric, vinyl or leather combinations, pricing/yardage requirements will be as follows:

- A Seat 1 yd(s).
- B Inside Back .75 yd(s).
- C Arms 1 yd(s).
- D Outside Back .75 yd(s).

- When combining two materials of the same grade, pricing will be specified grade + 5%
- If combining two materials of different grades or leather/fabric combination, use the highest grade/price + 5%
- If using COM or COL, pricing will be COM or COL + 5%.
- If both COM + COL are used in combination, use COL + 5%.

Options

Base

- BBPC: Black Base - \$95
- BOW: Wood Base, see page 5 to specify finish - \$170

Stitching

- BPS: Back Panel Stitching Detail - \$105

Posh

Upholstered Arms
High-Back

[Click here to view statement of line](#)

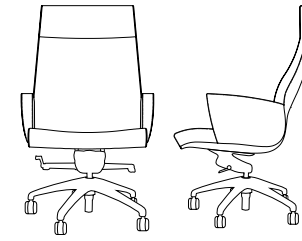

1 Model PSH9825UAH05

w" x d" x h"
25 x 24.5 x 43.25-46.25
Arm Height 27 -1/2" - 30 -3/4"
Seat Height 18 -1/4" - 21 -1/2"
Inside Seat Depth 18 -1/2"
Inside Seat Width 22 -1/2"

COM	COL	1	2	3	4	5	6	7	8	9	10	11/L1	12	13/L2
2495	2568	2625	2689	2753	2817	2881	2945	3009	3073	3137	3201	3265	3329	3457

Upholstery Requirements
Fabric yds: 3.5 Leather Sq. Ft.: 63
Carton Weight: 60

2 Select Finish

[Click to view finishes](#)

Finishes N/A

3 Combination Fabrics

[Click to view finishes](#)

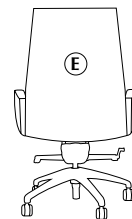
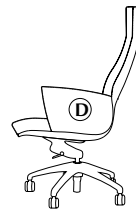
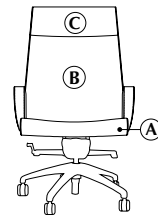

DARRAN is pleased to offer customers the design freedom of combination fabrics. When using fabric, vinyl or leather combinations, pricing/yardage requirements will be as follows:

- A Seat 1 yd(s).
- B Lower Inside Back .75 yd(s).
- C Upper Inside Back .5 yd(s).
- D Arms 1 yd(s).
- E Outside Back .75 yd(s).

- When combining two materials of the same grade, pricing will be specified grade + 5%
- If combining two materials of different grades or leather/fabric combination, use the highest grade/price + 5%
- If using COM or COL, pricing will be COM or COL + 5%.
- If both COM + COL are used in combination, use COL + 5%.

Product Features

- 2" wide upholstered arms
- 26" diameter polished aluminum base
- 9-ply molded plywood frame
- High density CAL117 polyurethane foams of varying compression are laminated together to provide long term comfort.
- Large 60mm diameter casters are standard and promote increased mobility.
- Knee tilt swivel w/ forward pivot point

Options

Base

- BBPC: Black Base - \$95
- BOW: Wood Base, see page 5 to specify finish - \$170

Stitching

- BPS: Back Panel Stitching Detail - \$105

Posh

Armless
Mid-Back

[Click here to view statement of line](#)

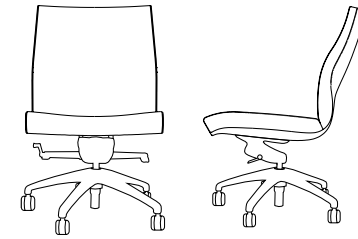

1 Model PSH9825NAM00

w" x d" x h"
21 x 24.5 x 37.75-40.5
Arm Height N/A
Seat Height 18 -1/4" - 21 -1/2"
Inside Seat Depth 18 -1/2"
Inside Seat Width 22 -1/2"

COM	COL	1	2	3	4	5	6	7	8	9	10	11/L1	12	13/L2
1897	1946	2008	2063	2118	2173	2228	2283	2338	2393	2448	2503	2558	2613	2723

Upholstery Requirements
Fabric yds: 3 Leather Sq. Ft.: 54
Carton Weight: 50

2 Select Finish

[Click to view finishes](#)

Finishes N/A

3 Combination Fabrics

[Click to view finishes](#)

DARRAN is pleased to offer customers the design freedom of combination fabrics. When using fabric, vinyl or leather combinations, pricing/yardage requirements will be as follows:

A Seat 1 yd(s).
B Inside Back .75 yd(s).
C Outside Back .75 yd(s).

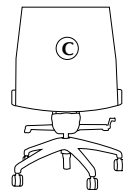
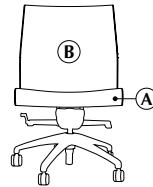

- When combining two materials of the same grade, pricing will be specified grade + 5%
- If combining two materials of different grades or leather/fabric combination, use the highest grade/price + 5%
- If using COM or COL, pricing will be COM or COL + 5%.
- If both COM + COL are used in combination, use COL + 5%.

Product Features

- 26" diameter polished aluminum base
- 9-ply molded plywood frame
- High density CAL117 polyurethane foams of varying compression are laminated together to provide long term comfort.
- Large 60mm diameter casters are standard and promote increased mobility.
- Knee tilt swivel w/ forward pivot point

Options

Base

- BBPC: Black Base - \$95
- BOW: Wood Base, see page 5 to specify finish - \$170

Stitching

- BPS: Back Panel Stitching Detail - \$105

Posh

Armless
High-Back

[Click here to view statement of line](#)

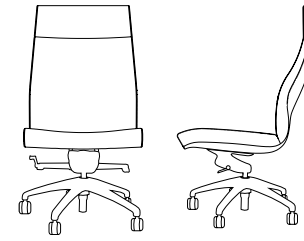

1 Model PSH9825NAH01

w" x d" x h"
21 x 24.5 x 43.25-46.25
Arm Height N/A
Seat Height 18 -1/4" - 21 -1/2"
Inside Seat Depth 18 -1/2"
Inside Seat Width 22 -1/2"

COM	COL	1	2	3	4	5	6	7	8	9	10	11/L1	12	13/L2
2028	2080	2149	2208	2267	2326	2385	2444	2503	2562	2621	2680	2739	2798	2916

Upholstery Requirements
Fabric yds: 3.25 Leather Sq. Ft.: 58.5
Carton Weight: 55

2 Select Finish

[Click to view finishes](#)

Finishes N/A

3 Combination Fabrics

[Click to view finishes](#)

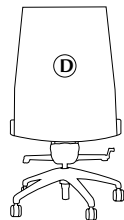
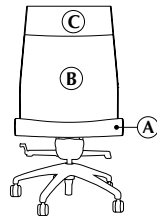

DARRAN is pleased to offer customers the design freedom of combination fabrics. When using fabric, vinyl or leather combinations, pricing/yardage requirements will be as follows:

- A Seat 1 yd(s).
- B Lower Inside Back .75 yd(s).
- C Upper Inside Back .5 yd(s).
- D Outside Back .75 yd(s).

- When combining two materials of the same grade, pricing will be specified grade + 5%
- If combining two materials of different grades or leather/fabric combination, use the highest grade/price + 5%
- If using COM or COL, pricing will be COM or COL + 5%.
- If both COM + COL are used in combination, use COL + 5%.

Product Features

- 26" diameter polished aluminum base
- 9-ply molded plywood frame
- High density CAL117 polyurethane foams of varying compression are laminated together to provide long term comfort.
- Large 60mm diameter casters are standard and promote increased mobility.
- Knee tilt swivel w/ forward pivot point

Options

Base

- BBPC: Black Base - \$95
- BOW: Wood Base, see page 5 to specify finish - \$170

Stitching

- BPS: Back Panel Stitching Detail - \$105

Posh

Adjustable Ergonomic Arms
Mid-Back

[Click here to view statement of line](#)

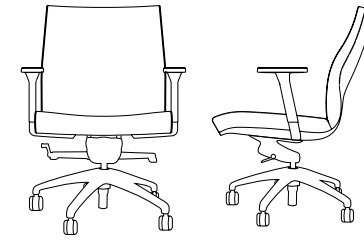

1 Model PSH9825AAM02

w" x d" x h"
21 x 24.5 x 37.75-40.5
Arm Height 28 -1/2" - 31 -3/4"
Seat Height 18 -1/4" - 21 -1/2"
Inside Seat Depth 18 -1/2"
Inside Seat Width 22 -1/2"

COM	COL	1	2	3	4	5	6	7	8	9	10	11/L1	12	13/L2
2055	2104	2166	2221	2276	2331	2386	2441	2496	2551	2606	2661	2716	2771	2881

Upholstery Requirements
Fabric yds: 3 Leather Sq. Ft.: 54
Carton Weight: 55

2 Select Finish

[Click to view finishes](#)

Finishes N/A

3 Combination Fabrics

[Click to view finishes](#)

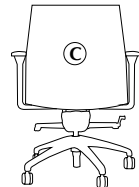
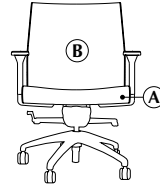

DARRAN is pleased to offer customers the design freedom of combination fabrics. When using fabric, vinyl or leather combinations, pricing/yardage requirements will be as follows:

A Seat 1 yd(s).
B Inside Back .75 yd(s).
C Outside Back .75 yd(s).

- When combining two materials of the same grade, pricing will be specified grade + 5%
- If combining two materials of different grades or leather/fabric combination, use the highest grade/price + 5%
- If using COM or COL, pricing will be COM or COL + 5%.
- If both COM + COL are used in combination, use COL + 5%.

Product Features

- 26" diameter polished aluminum base
- 9-ply molded plywood frame
- Black adjustable ergonomic arms are available with spring loaded height adjustment and button activation. Arms are angled at 15 degrees with an adjustable arm pad for additional comfort and support. Arm adjusts 3- 1/4" in height and 1-1/2" in width
- High density CAL117 polyurethane foams of varying compression are laminated together to provide long term comfort.
- Large 60mm diameter casters are standard and promote increased mobility.
- Knee tilt swivel w/ forward pivot point

Options

Base

- BBPC: Black Base - \$95
- BOW: Wood Base, see page 5 to specify finish - \$170

Stitching

- BPS: Back Panel Stitching Detail - \$105

Posh

Adjustable Ergonomic Arms
High-Back

[Click here to view statement of line](#)

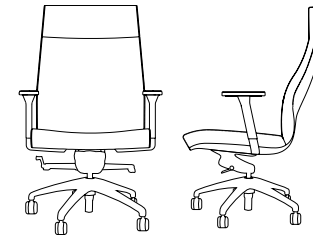

1 Model PSH9825AAH03

w" x d" x h"
21 x 24.5 x 43.25-46.25
Arm Height 28 -1/2" - 31 -3/4"
Seat Height 18 -1/4" - 21 1/2"
Inside Seat Depth 18 -1/2"
Inside Seat Width 22 -1/2"

COM	COL	1	2	3	4	5	6	7	8	9	10	11/L1	12	13/L2
2184	2236	2305	2364	2423	2482	2541	2600	2659	2718	2777	2836	2895	2954	3072

Upholstery Requirements
Fabric yds: 3.25 Leather Sq. Ft.: 58.5
Carton Weight: 60

2 Select Finish

[Click to view finishes](#)

Finishes N/A

3 Combination Fabrics

[Click to view finishes](#)

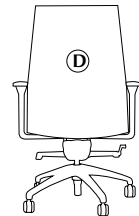
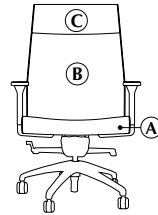

DARRAN is pleased to offer customers the design freedom of combination fabrics. When using fabric, vinyl or leather combinations, pricing/yardage requirements will be as follows:

- A Seat 1 yd(s).
- B Lower Inside Back .75 yd(s).
- C Upper Inside Back .5 yd(s).
- D Outside Back .75 yd(s).

- When combining two materials of the same grade, pricing will be specified grade + 5%
- If combining two materials of different grades or leather/fabric combination, use the highest grade/price + 5%
- If using COM or COL, pricing will be COM or COL + 5%.
- If both COM + COL are used in combination, use COL + 5%.

Product Features

- 26" diameter polished aluminum base
- 9-ply molded plywood frame
- Black adjustable ergonomic arms are available with spring loaded height adjustment and button activation. Arms are angled at 15 degrees with an adjustable arm pad for additional comfort and support. Arm adjusts 3- 1/4" in height and 1-1/2" in width
- High density CAL117 polyurethane foams of varying compression are laminated together to provide long term comfort.
- Large 60mm diameter casters are standard and promote increased mobility.
- Knee tilt swivel w/ forward pivot point

Options

Base

- BBPC: Black Base - \$95
- BOW: Wood Base, see page 5 to specify finish - \$170

Stitching

- BPS: Back Panel Stitching Detail - \$105

Posh

Urethane Loop Arms
Mid-Back

[Click here to view statement of line](#)

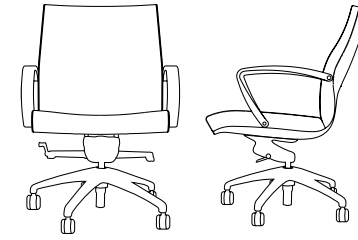

1 Model
PSH9825CAM16

w" x d" x h"
25 x 24.5 x 37.75-40.5
Arm Height 27 -3/4" - 31"
Seat Height 18 -1/4" - 21 -1/2"
Inside Seat Depth 18 -1/2"
Inside Seat Width 22 -1/2"

COM	COL	1	2	3	4	5	6	7	8	9	10	11/L1	12	13/L2
1984	2033	2095	2150	2205	2260	2315	2370	2425	2480	2535	2590	2645	2700	2810

Upholstery Requirements
Fabric yds: 3 Leather Sq. Ft.: 54
Carton Weight: 55

Product Features

- 26" diameter polished aluminum base
- 9-ply molded plywood frame
- Black urethane loop arms
- High density CAL117 polyurethane foams of varying compression are laminated together to provide long term comfort.
- Large 60mm diameter casters are standard and promote increased mobility.
- Knee tilt swivel w/ forward pivot point

2 Select Finish

[Click to view finishes](#)

Finishes N/A

3 Combination Fabrics

[Click to view finishes](#)

DARRAN is pleased to offer customers the design freedom of combination fabrics. When using fabric, vinyl or leather combinations, pricing/yardage requirements will be as follows:

- A Seat 1 yd(s).
- B Inside Back .75 yd(s).
- C Outside Back .75 yd(s).

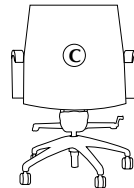
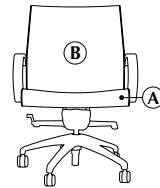

- When combining two materials of the same grade, pricing will be specified grade + 5%
- If combining two materials of different grades or leather/fabric combination, use the highest grade/price + 5%
- If using COM or COL, pricing will be COM or COL + 5%.
- If both COM + COL are used in combination, use COL + 5%.

Options

Base

- BBPC: Black Base - \$95
- BOW: Wood Base, see page 5 to specify finish - \$170

Stitching

- BPS: Back Panel Stitching Detail - \$105

Posh

Urethane Loop Arms
High-Back

[Click here to view statement of line](#)

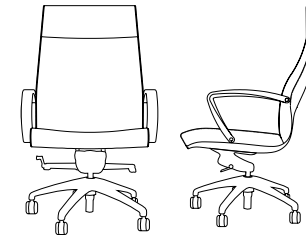

1 Model PSH9825CAH17

w" x d" x h"
25 x 24.5 x 43.25-46.25
Arm Height 27 -3/4" - 31"
Seat Height 18 -1/4" - 21 -1/2"
Inside Seat Depth 18 -1/2"
Inside Seat Width 22 -1/2"

COM	COL	1	2	3	4	5	6	7	8	9	10	11/L1	12	13/L2
2111	2163	2232	2291	2350	2409	2468	2527	2586	2645	2704	2763	2822	2881	2999

Upholstery Requirements
Fabric yds: 3.25 Leather Sq. Ft.: 58.5
Carton Weight: 60

2 Select Finish

[Click to view finishes](#)

Finishes N/A

3 Combination Fabrics

[Click to view finishes](#)

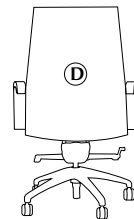
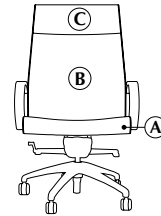

DARRAN is pleased to offer customers the design freedom of combination fabrics. When using fabric, vinyl or leather combinations, pricing/yardage requirements will be as follows:

A Seat 1 yd(s).
B Lower Inside Back .75 yd(s).
C Upper Inside Back .5 yd(s).
D Outside Back .75 yd(s).

- When combining two materials of the same grade, pricing will be specified grade + 5%
- If combining two materials of different grades or leather/fabric combination, use the highest grade/price + 5%
- If using COM or COL, pricing will be COM or COL + 5%.
- If both COM + COL are used in combination, use COL + 5%.

Product Features

- 26" diameter polished aluminum base
- 9-ply molded plywood frame
- Black urethane loop arms
- High density CAL117 polyurethane foams of varying compression are laminated together to provide long term comfort.
- Large 60mm diameter casters are standard and promote increased mobility.
- Knee tilt swivel w/ forward pivot point

Options

Base

- BBPC: Black Base - \$95
- BOW: Wood Base, see page 5 to specify finish - \$170

Stitching

- BPS: Back Panel Stitching Detail - \$105