



Versi Price List

Effective February 2025

Designed by DARRAN Studio

Date
03.10.2025

Page

Modification
Corrected seat height for all units to 19.25"

DARRAN®

Statement of Line	
Versi Fabric & Leather Program	1
Versi Seating Specification	4
Banquette Seating	5
Power Option	15

Statement of Line



Page 5
Banquette
Angled Right Facing Banquette



Page 6
Banquette
Angled Left Facing Banquette

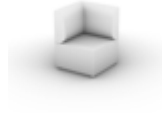

Page 7
Inside Corner Banquette
90 Degree



Page 8
Outside Corner Banquette
90 Degree



Page 9
Banquette
Return End Cap Banquette



Page 10
Banquette
Straight Banquette - Armless



Page 11
Banquette
Straight Banquette w/ Right
Facing Arm



Page 12
Banquette
Straight Banquette w/ Left Facing
Arm



Page 13
Banquette
Round End Left Facing Banquette



Page 14
Banquette
Round End Right Facing Banquette

Seating fabric & leather program

DARRAN has partnered with some of the most prestigious fabric suppliers of the office furniture industry to bring you quality fabrics that are engaging designs, environmentally friendly and durable for years to come. If you do not see the fabric you wish to include in a project, please contact Customer Service at 800.334.7891 to see if this pattern can be graded in

For current information about graded-in fabrics and leather, please visit our Resources page at www.darran.com/resources/textiles-leather/

Anzea

www.cfstinson.com/anzea

817.336.2310

Camira

www.camirafabrics.com

616.288.0655

Carroll Leather

www.carrollleather.com

828.466.5489

CF Stinson

www.cfstinson.com

800.841.6279

DesignTex

www.designtex.com

800.221.1540

Green Hides

www.greenhides.com

336.315.9720

HBF Textiles

www.hbftextiles.com

877.494.5727

Knoll Textiles

www.maharam.com/knoll-textiles

800.645.3943

Kvadrat

www.kvadrat.dk

+45 8953 1866

Maharam

www.maharam.com

800.645.3943

Momentum Textiles

www.momentumtextilesandwalls.com

800.366.6839

Sina Pearson

www.momentumtextilesandwalls.com/collections/sina-pearson

800.366.6839

Ultrafabrics

www.ultrafabricsinc.com

877.309.6648

CAL 117-2013

All DARRAN seating products conform to California Technical Bulletin 117-2013 as a minimum standard.

ASTM E1537

Testing for ASTM E1537 is available for all DARRAN seating products. If ASTM E1537 testing is required, please contact DARRAN customer service at 800.334.7891 for testing fees and considerations.

Combination fabrics

DARRAN is pleased to offer customers the design freedom of combination fabrics. When using fabric, vinyl or leather combinations, pricing will be as follows:

- When combining two materials of the same grade, pricing will be specified grade + 5%.
- If combining two materials of different grades or leather/ fabric combination, use the highest grade/price + 5%.
- If using COM or COL, pricing will be COM or COL + 5%. If both COM + COL are used in combination, use COL + 5%

COM/COL ordering instructions

Please complete the COM Submission Form prior to ordering the fabric from the supplier. All COM fabrics must be approved prior to order submission. Please refer to our website or contact DARRAN Seating Customer Service for an updated list of preapproved COM fabrics. Application instructions must be specified on the purchase order or COM/COL approval form. In the absence of application instructions, DARRAN will apply materials in the best manner and cannot be held responsible for tailoring or application objections after upholstering. COM orders will be scheduled for production after receipt of the material. Packages must be clearly marked and the fabric must be first quality, continuous yardage.

COM/COL yardage requirements

The yardage requirements stated in this price list for each style are calculated using 54" wide, non-directional fabrics. For fabrics with a different width or for patterns with repeats, please refer to the below chart to calculate the additional percent of fabric required:

Fabric Width	Plain Fabric	2" - 14" Repeat	15" - 19" Repeat	20" - 27" Repeat	28" - 36" Repeat
54"	0	15%	20%	25%	30%
53"	6%	19%	24%	28%	36%
52"	13%	23%	28%	33%	38%
51"	19%	26%	31%	36%	41%
50"	25%	30%	35%	40%	45%
49"	30%	35%	40%	45%	50%
48"	35%	40%	45%	50%	55%
47"	45%	50%	55%	58%	65%

DARRAN®

NOTE: Prior to completion of this form, please refer to our Graded In Materials Program for pre-approved fabrics/leathers.

COM/COL Approval

DARRAN Furniture Industries
2402 Shore Street, High Point, NC 27263
ATTN: Seating Division / COM/COL Approval
TAG: DARRAN Quote Number

Shipping approved COM/COL materials

DARRAN Furniture Industries
2402 Shore Street, High Point, NC 27263
ATTN: Seating Division / COM/COL Approval
TAG: DARRAN Quote Number

Please complete this form, attach a 6"x 6" sample and mail to the COM/COL Approval address shown above.

This form can also be downloaded from our website at www.darran.com/resources/textiles-leather/

Quote # _____

Dealer's Name _____

Contact _____

Address _____

Telephone _____

Email _____

Chair Style _____

Manufacturer _____

Pattern Name _____

Pattern Color _____

Content _____

Repeat _____

Please specify any special requirements and check the application above.

Versi Fabric & Leather Program

ATTACH 6" X 6" FABRIC/LEATHER SAMPLE HERE

NOTE

Actual Fabric/Leather samples needed instead of digital images. If digital images are sent in lieu of samples, DARRAN will only verify the pattern and will not take responsibility for color variances that cannot be verified due to printing limitations

In the absence of application instructions, DARRAN will apply the material in the best manner and cannot be held responsible for tailoring or application objections after upholstering.

Unless otherwise instructed on the purchase order, excess COM materials will be recycled at the discretion of DARRAN after six months of the original product ship date.

The COM approval solely pertains to the application of the fabric onto the specified DARRAN seating product. DARRAN's approval or acceptance does not constitute any responsibility or warranty to the overall appearance, durability, flammability, defects, dye lot variations, or colorfastness of the COM. It is the customer's responsibility to ensure the COM meets CAL 117-2013 compliance and are first quality continuous goods.

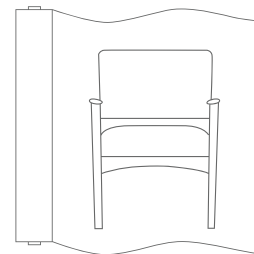

RAILROAD

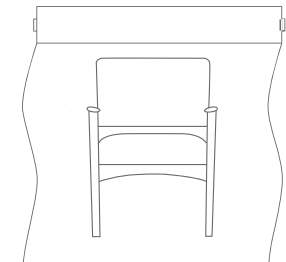

SETUP

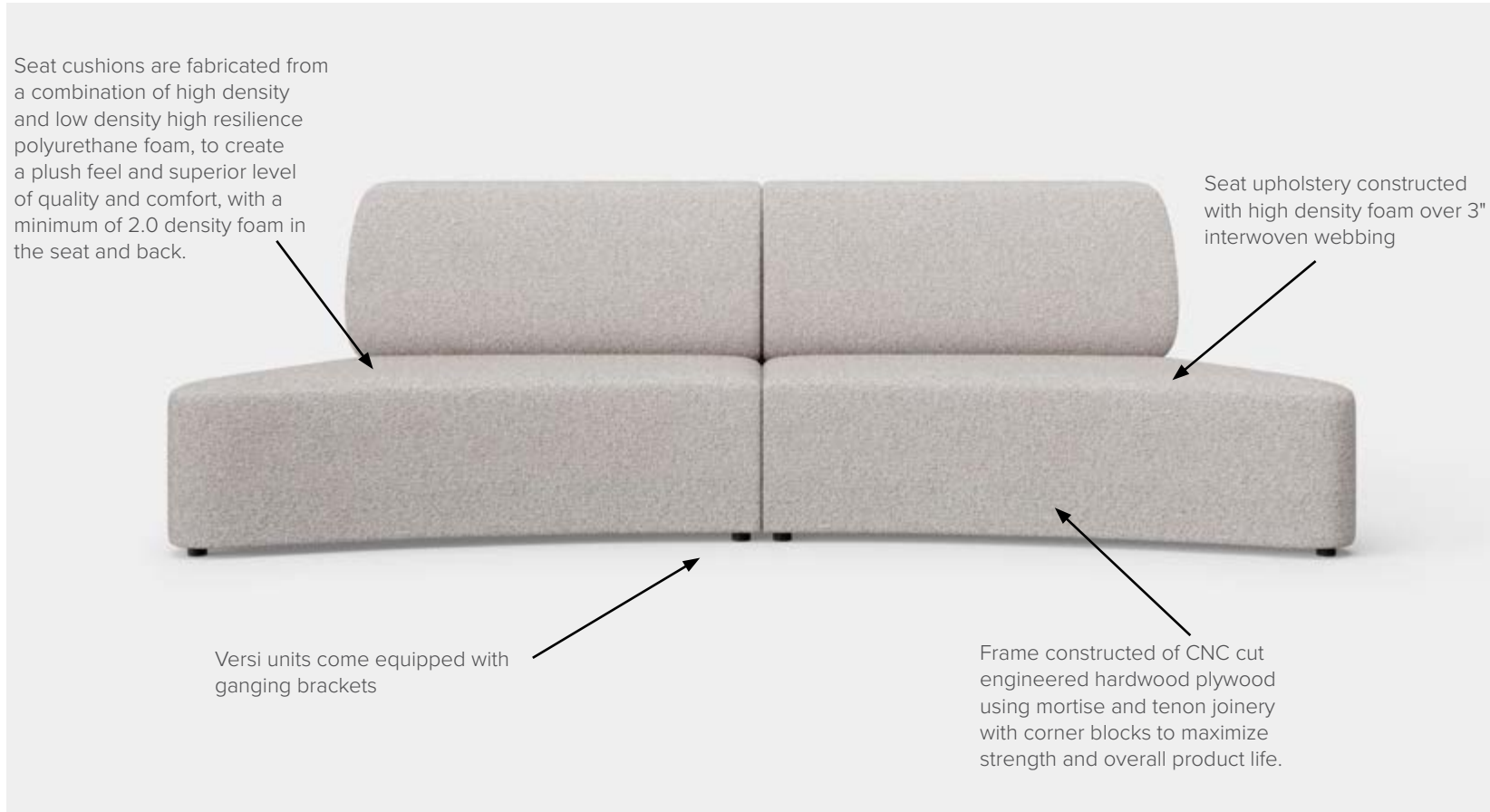

Versi

Banquette
 Angled Right Facing Banquette

[Click here to view statement of line](#)



1 Model
VER0220MBR97

w" x d" x h"
 59 x 37 x 36

Seat Height 19.25"
 Inside Seat Depth 19.5" - 25"
 Inside Seat Width 59"

COM	COL	1	2	3	4	5	6	7	8	9	10	11/L1	12	13/L2
3187	3283	3379	3475	3571	3667	3763	3859	3955	4051	4147	4243	4339	4435	4627

Upholstery Requirements
 Fabric yds: 5.25 Leather Sq. Ft.: 94.5
 Carton Weight:

Product Features

- Seats sprung with 3" ultra high strength webbing
- High density resilient polyurethane foam used in seats and backs
- Frames constructed from CNC cut hardwood plywood
- Units can be ganged, unganged, and re-arranged

Notes

- Optional PLATEAU power option can be daisy chained across multiple units

Options

Power Option

- PD-PLAT-2: Plateau Power Option - \$691 each
- Specify Color (White, Black, or Gray)
- Power unit is installed on the front left facing body of the banquette
- See Power & Data Options for further details

2 Material Selections

DARRAN is pleased to offer customers the design freedom of combination fabrics. When using fabric, vinyl or leather combinations, pricing/yardage requirements will be as follows:

- A Entire Back Rest 1.75 yds.
- B Body Perimeter 2.25 yds.
- C Seat Top 1.5 yds.

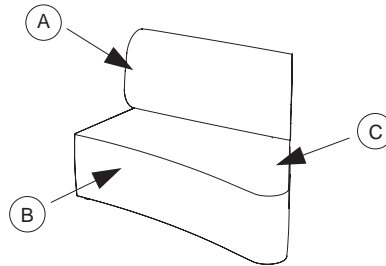

- When combining two materials of the same grade, pricing will be specified grade + 5%
- If combining two materials of different grades or leather/fabric combination, use the highest grade/price + 5%
- If using COM or COL, pricing will be COM or COL + 5%.
- If both COM + COL are used in combination, use COL + 5%.

Versi

Banquette
 Angled Left Facing Banquette

[Click here to view statement of line](#)



1 Model
VERO220MBL97

w" x d" x h"
 59 x 37 x 36

Seat Height 19.25"
 Inside Seat Depth 19.5" - 25"
 Inside Seat Width 59"

COM	COL	1	2	3	4	5	6	7	8	9	10	11/L1	12	13/L2
3187	3283	3379	3475	3571	3667	3763	3859	3955	4051	4147	4243	4339	4435	4627

Upholstery Requirements
 Fabric yds: 5.25 Leather Sq. Ft.: 94.5
 Carton Weight:

Product Features

- Seats sprung with 3" ultra high strength webbing
- High density resilient polyurethane foam used in seats and backs
- Frames constructed from CNC cut hardwood plywood
- Units can be ganged, unganged, and re-arranged

Notes

- Optional PLATEAU power option can be daisy chained across multiple units

Options

Power Option

- PD-PLAT-2: Plateau Power Option - \$691 each
- Specify Color (White, Black, or Gray)
- Power unit is installed on the front right facing body of the banquette
- See Power & Data Options for further details

2 Material Selections

DARRAN is pleased to offer customers the design freedom of combination fabrics. When using fabric, vinyl or leather combinations, pricing/yardage requirements will be as follows:

- A Entire Back Rest 1.75 yds.
- B Body Perimeter 2.25 yds.
- C Seat Top 1.5 yds.

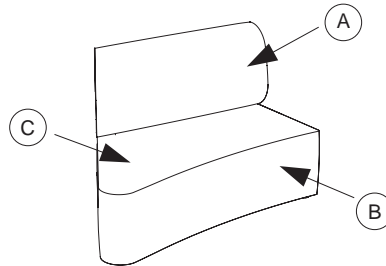

- When combining two materials of the same grade, pricing will be specified grade + 5%
- If combining two materials of different grades or leather/fabric combination, use the highest grade/price + 5%
- If using COM or COL, pricing will be COM or COL + 5%.
- If both COM + COL are used in combination, use COL + 5%.

Versi

Inside Corner Banquette
90 Degree

[Click here to view statement of line](#)

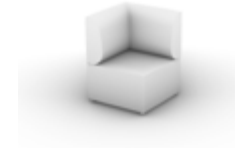

1 Model
VER0220BSQ97

w" x d" x h"
28 x 28 x 36

Seat Height 19.25"
Inside Seat Depth 19.5"
Inside Seat Width 19.5"

COM	COL	1	2	3	4	5	6	7	8	9	10	11/L1	12	13/L2
2708	2808	2908	3008	3108	3208	3308	3408	3508	3608	3708	3808	3908	4008	4208

Upholstery Requirements
Fabric yds: 5.5 Leather Sq. Ft.: 99
Carton Weight:

Product Features

- Seats sprung with 3" ultra high strength webbing
- High density resilient polyurethane foam used in seats and backs
- Frames constructed from CNC cut hardwood plywood
- Units can be ganged, unganged, and re-arranged

2 Material Selections

DARRAN is pleased to offer customers the design freedom of combination fabrics. When using fabric, vinyl or leather combinations, pricing/yardage requirements will be as follows:

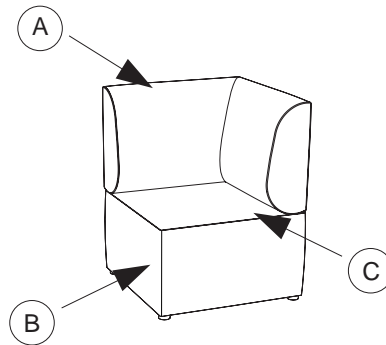

- A Entire Back Rest 3 yds.
- B Body Perimeter 2.25 yds.
- C Seat Top 1 yd.

- When combining two materials of the same grade, pricing will be specified grade + 5%
- If combining two materials of different grades or leather/fabric combination, use the highest grade/price + 5%
- If using COM or COL, pricing will be COM or COL + 5%.
- If both COM + COL are used in combination, use COL + 5%.

Versi

Outside Corner Banquette
90 Degree

[Click here to view statement of line](#)



1 Model
VER0220BOC97

w" x d" x h"
40 x 40 x 36

Seat Height 19.25"
Inside Seat Depth 19.5"
Inside Seat Width 40"

COM	COL	1	2	3	4	5	6	7	8	9	10	11/L1	12	13/L2
2885	2976	3067	3158	3249	3340	3431	3522	3613	3704	3795	3886	3977	4068	4250

Upholstery Requirements
Fabric yds: 5 Leather Sq. Ft.: 90
Carton Weight:

Product Features

- Seats sprung with 3" ultra high strength webbing
- High density resilient polyurethane foam used in seats and backs
- Frames constructed from CNC cut hardwood plywood
- Units can be ganged, unganged, and re-arranged

Notes

- Optional PLATEAU power option can be daisy chained across multiple units

Options

Power Option

- PD-PLAT-2: Plateau Power Option - \$691 each
- Specify Color (White, Black, or Gray) and Location (Left Facing/Right Facing)
- See Power & Data Options for further details

2 Material Selections

DARRAN is pleased to offer customers the design freedom of combination fabrics. When using fabric, vinyl or leather combinations, pricing/yardage requirements will be as follows:

- A Entire Back Rest 1.75 yds.
- B Body Perimeter 2.5 yds.
- C Seat Top 1.25 yds.

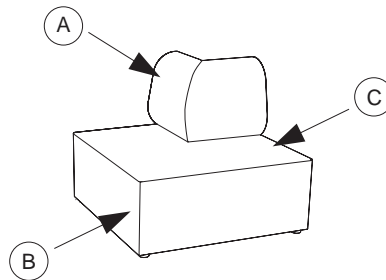

- When combining two materials of the same grade, pricing will be specified grade + 5%
- If combining two materials of different grades or leather/fabric combination, use the highest grade/price + 5%
- If using COM or COL, pricing will be COM or COL + 5%.
- If both COM + COL are used in combination, use COL + 5%.

Versi

Banquette
Return End Cap Banquette

[Click here to view statement of line](#)

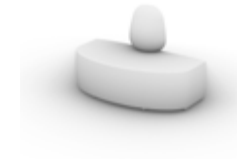

1 Model
VER0220BEC97

w" x d" x h"
56 x 28 x 36

Seat Height 19.25"
Inside Seat Depth 19.5"
Inside Seat Width 56"

COM	COL	1	2	3	4	5	6	7	8	9	10	11/L1	12	13/L2
3385	3476	3567	3658	3749	3840	3931	4022	4113	4204	4295	4386	4477	4568	4750

Upholstery Requirements
Fabric yds: 5 Leather Sq. Ft.: 90
Carton Weight:

Product Features

- Seats sprung with 3" ultra high strength webbing
- High density resilient polyurethane foam used in seats and backs
- Frames constructed from CNC cut hardwood plywood
- Units can be ganged, unganged, and re-arranged

Notes

- Optional PLATEAU power option can be daisy chained across multiple units

Options

Power Option

- PD-PLAT-2: Plateau Power Option - \$691 each
- Specify Color (White, Black, or Gray) and Location (Left Facing/Right Facing)
- See Power & Data Options for further details

2 Material Selections

DARRAN is pleased to offer customers the design freedom of combination fabrics. When using fabric, vinyl or leather combinations, pricing/yardage requirements will be as follows:

- A Entire Back Rest 1.75 yds.
- B Body Perimeter 2.75 yds.
- C Seat Top 1.5 yds.

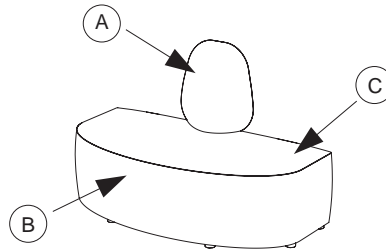

- When combining two materials of the same grade, pricing will be specified grade + 5%
- If combining two materials of different grades or leather/fabric combination, use the highest grade/price + 5%
- If using COM or COL, pricing will be COM or COL + 5%.
- If both COM + COL are used in combination, use COL + 5%.

Versi

Banquette
Straight Banquette - Armless



[Click here to view statement of line](#)

1 Model

VER0220BBSxx	Width	Fabric yds	Leather sq. ft.	Carton weight	COM	COL	1	2	3	4	5	6	7	8	9	10	11/L1	12	13/L2
	36" - 40"	4.75	85.5		2655	2742	2829	2916	3003	3090	3177	3264	3351	3438	3525	3612	3699	3786	3960
	41" - 45"	4.75	85.5		2860	2947	3034	3121	3208	3295	3382	3469	3556	3643	3730	3817	3904	3991	4165
	46" - 50"	5	90		3065	3156	3247	3338	3429	3520	3611	3702	3793	3884	3975	4066	4157	4248	4430
	51" - 55"	8	144		3270	3416	3562	3708	3854	4000	4146	4292	4438	4584	4730	4876	5022	5168	5460
	56" - 60"	8	144		3475	3621	3767	3913	4059	4205	4351	4497	4643	4789	4935	5081	5227	5373	5665

d" x h"
28 x 36

Seat Height 19.25"
Inside Seat Depth 19.5"

When ordering, replace xx in the sku with the desired length in inches of the banquette.
Example: a 51" Straight Banquette - Armless would be VER0220BBS51

Product Features

- Seats sprung with 3" ultra high strength webbing
- High density resilient polyurethane foam used in seats and backs
- Frames constructed from CNC cut hardwood plywood
- Units can be ganged, unganged, and re-arranged

Notes

- Available in 1" increments
- For banquette units under 46", two power ports are not recommended
- Optional PLATEAU power option can be daisy chained across multiple units

Options

Power Option

- PD-PLAT-2: Plateau Power Option - \$691 each
- Specify Color (White, Black, or Gray) and Location (Left Facing/Right Facing)
- See Power & Data Options for further details

2 Material Selections

A Entire Back Rest B Body Perimeter C Seat Top

36" - 40"	2.25 yds.	2.25 yds.	1 yd.
41" - 45"	2.25 yds.	2.25 yds.	1 yd.
46" - 50"	2.25 yds.	3.25 yds.	1.75 yds
51" - 55"	3.25 yds.	3.25 yds.	1.75 yds.
56" - 60"	3.25 yds.	3.25 yds.	1.75 yds.

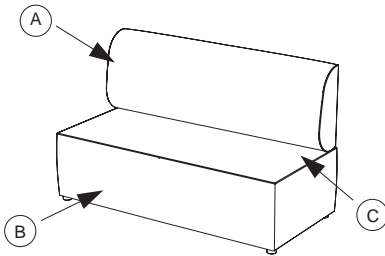

DARRAN is pleased to offer customers the design freedom of combination fabrics. When using fabric, vinyl or leather combinations, pricing/yardage requirements will be as shown in the above table.

- When combining two materials of the same grade, pricing will be specified grade + 5%
- If combining two materials of different grades or leather/fabric combination, use the highest grade/price + 5%
- If using COM or COL, pricing will be COM or COL + 5%.
- If both COM + COL are used in combination, use COL + 5%.

Versi

Banquette
Straight Banquette w/ Right Facing Arm



[Click here to view statement of line](#)

1 Model

VER0220BBRxx	Width	Fabric yds	Leather sq. ft.	Carton weight	COM	COL	1	2	3	4	5	6	7	8	9	10	11/L1	12	13/L2
	36" - 40"	5.75	103.5		2960	3065	3170	3275	3380	3485	3590	3695	3800	3905	4010	4115	4220	4325	4535
	41" - 45"	5.75	103.5		3165	3270	3375	3480	3585	3690	3795	3900	4005	4110	4215	4320	4425	4530	4740
	46" - 50"	6	108		3370	3479	3588	3697	3806	3915	4024	4133	4242	4351	4460	4569	4678	4787	5005
	51" - 55"	9	162		3575	3739	3903	4067	4231	4395	4559	4723	4887	5051	5215	5379	5543	5707	6035
	56" - 60"	9	162		3780	3944	4108	4272	4436	4600	4764	4928	5092	5256	5420	5584	5748	5912	6240

d" x h"
28 x 36

Seat Height 19.25"
Inside Seat Depth 19.5"

When ordering, replace xx in the sku with the desired length in inches of the banquette.
Example: a 51" Straight Banquette w/ Right Facing Arm would be VER0220BBR**51**

Product Features

- Seats sprung with 3" ultra high strength webbing
- High density resilient polyurethane foam used in seats and backs
- Frames constructed from CNC cut hardwood plywood
- Units can be ganged, unganged, and re-arranged

Notes

- Available in 1" increments
- For banquette units under 46", two power ports are not recommended
- Optional PLATEAU power option can be daisy chained across multiple units

Options

Power Option

- PD-PLAT-2: Plateau Power Option - \$691 each
- Specify Color (White, Black, or Gray) and Location (Left Facing/Right Facing)
- See Power & Data Options for further details

2 Material Selections

A Entire Back Rest B Body Perimeter C Seat Top D Arm

36" - 40"	2.25 yds.	2.25 yds.	1 yd.	1 yd.
41" - 45"	2.25 yds.	2.25 yds.	1 yd.	1 yd.
46" - 50"	2.25 yds.	3.25 yds.	1.75 yds.	1 yd.
51" - 55"	3.25 yds.	3.25 yds.	1.75 yds.	1 yd.
56" - 60"	3.25 yds.	3.25 yds.	1.75 yds.	1 yd.

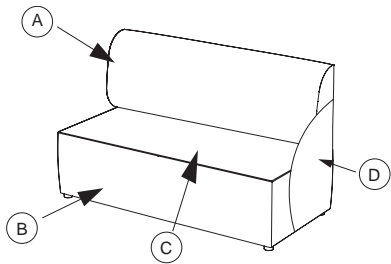

DARRAN is pleased to offer customers the design freedom of combination fabrics. When using fabric, vinyl or leather combinations, pricing/yardage requirements will be as shown in the above table.

- When combining two materials of the same grade, pricing will be specified grade + 5%
- If combining two materials of different grades or leather/fabric combination, use the highest grade/price + 5%
- If using COM or COL, pricing will be COM or COL + 5%.
- If both COM + COL are used in combination, use COL + 5%.

Versi

Banquette
Straight Banquette w/ Left Facing Arm



[Click here to view statement of line](#)

1 Model

VER0220BBLxx	Width	Fabric yds	Leather sq. ft.	Carton weight	COM	COL	1	2	3	4	5	6	7	8	9	10	11/L1	12	13/L2
	36" - 40"	5.75	103.5		2960	3065	3170	3275	3380	3485	3590	3695	3800	3905	4010	4115	4220	4325	4535
	41" - 45"	5.75	103.5		3165	3270	3375	3480	3585	3690	3795	3900	4005	4110	4215	4320	4425	4530	4740
	46" - 50"	6	108		3370	3479	3588	3697	3806	3915	4024	4133	4242	4351	4460	4569	4678	4787	5005
	51" - 55"	9	162		3575	3739	3903	4067	4231	4395	4559	4723	4887	5051	5215	5379	5543	5707	6035
	56" - 60"	9	162		3780	3944	4108	4272	4436	4600	4764	4928	5092	5256	5420	5584	5748	5912	6240

d" x h"
28 x 36

Seat Height 19.25"
Inside Seat Depth 19.5"

When ordering, replace xx in the sku with the desired length in inches of the banquette.
Example: a 51" Straight Banquette w/ Left Facing Arm would be VER0220BBL51

Product Features

- Seats sprung with 3" ultra high strength webbing
- High density resilient polyurethane foam used in seats and backs
- Frames constructed from CNC cut hardwood plywood
- Units can be ganged, unganged, and re-arranged

Notes

- Available in 1" increments
- For banquette units under 46", two power ports are not recommended
- Optional PLATEAU power option can be daisy chained across multiple units

Options

Power Option

- PD-PLAT-2: Plateau Power Option - \$691 each
- Specify Color (White, Black, or Gray) and Location (Left Facing/Right Facing)
- See Power & Data Options for further details

2 Material Selections

	A Entire Back Rest	B Body Perimeter	C Seat Top	D Arm
36" - 40"	2.25 yds.	2.25 yds.	1 yd.	1 yd.
41" - 45"	2.25 yds.	2.25 yds.	1 yd.	1 yd.
46" - 50"	2.25 yds.	3.25 yds.	1.75 yds	1 yd.
51" - 55"	3.25 yds.	3.25 yds.	1.75 yds.	1 yd.
56" - 60"	3.25 yds.	3.25 yds.	1.75 yds.	1 yd.

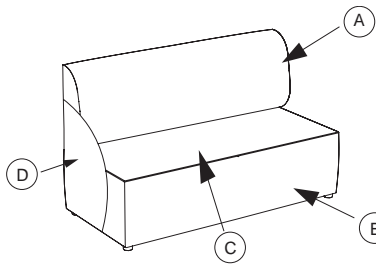

DARRAN is pleased to offer customers the design freedom of combination fabrics. When using fabric, vinyl or leather combinations, pricing/yardage requirements will be as shown in the above table.

- When combining two materials of the same grade, pricing will be specified grade + 5%
- If combining two materials of different grades or leather/fabric combination, use the highest grade/price + 5%
- If using COM or COL, pricing will be COM or COL + 5%.
- If both COM + COL are used in combination, use COL + 5%.

Versi

Banquette
Round End Left Facing Banquette



[Click here to view statement of line](#)

1 Model

VER0220BRLxx	Width	Fabric yds	Leather sq. ft.	Carton weight	COM	COL	1	2	3	4	5	6	7	8	9	10	11/L1	12	13/L2
	45" - 50"	4.75	85.5		3105	3192	3279	3366	3453	3540	3627	3714	3801	3888	3975	4062	4149	4236	4410
	51" - 55"	5	90		3310	3401	3492	3583	3674	3765	3856	3947	4038	4129	4220	4311	4402	4493	4675
	56" - 60"	5.25	94.5		3515	3611	3707	3803	3899	3995	4091	4187	4283	4379	4475	4571	4667	4763	4955
	61" - 65"	5.5	99		3720	3820	3920	4020	4120	4220	4320	4420	4520	4620	4720	4820	4920	5020	5220

d" x h"
28 x 36

Seat Height 19.25"
Inside Seat Depth 19.5"

When ordering, replace xx in the sku with the desired length in inches of the banquette.
Example: a 51" Round End Left Facing Banquette would be VER0220BRL51

2 Material Selections

A Entire Back Rest B Body Perimeter C Seat Top

45" - 50"	1.75 yds.	2.25 yds.	1 yd.
51" - 55"	1.75 yds.	2.25 yds.	1.75 yds.
56" - 60"	2.5 yds.	2.25 yds.	1.75 yds.
61" - 65"	2.5 yds.	2.25 yds.	1.75 yds.

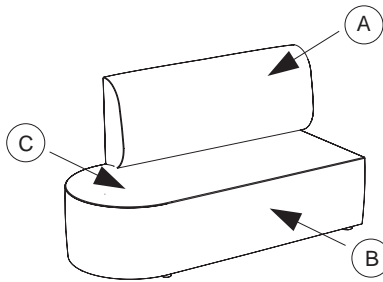

DARRAN is pleased to offer customers the design freedom of combination fabrics. When using fabric, vinyl or leather combinations, pricing/yardage requirements will be as shown in the above table.

- When combining two materials of the same grade, pricing will be specified grade + 5%
- If combining two materials of different grades or leather/fabric combination, use the highest grade/price + 5%
- If using COM or COL, pricing will be COM or COL + 5%.
- If both COM + COL are used in combination, use COL + 5%.

Product Features

- Seats sprung with 3" ultra high strength webbing
- High density resilient polyurethane foam used in seats and backs
- Frames constructed from CNC cut hardwood plywood
- Units can be ganged, unganged, and re-arranged

Notes

- Available in 1" increments
- Optional PLATEAU power option can be daisy chained across multiple units

Options

Power Option

- PD-PLAT-2: Plateau Power Option - \$691 each
- Specify Color (White, Black, or Gray) and Location (Left Facing/Right Facing)
- See Power & Data Options for further details

Versi

Banquette
Round End Right Facing Banquette



[Click here to view statement of line](#)

1 Model

VER0220BRRxx	Width	Fabric yds	Leather sq. ft.	Carton weight	COM	COL	1	2	3	4	5	6	7	8	9	10	11/L1	12	13/L2
	45" - 50"	4.75	85.5		3105	3192	3279	3366	3453	3540	3627	3714	3801	3888	3975	4062	4149	4236	4410
	51" - 55"	5	90		3310	3401	3492	3583	3674	3765	3856	3947	4038	4129	4220	4311	4402	4493	4675
	56" - 60"	5.25	94.5		3515	3611	3707	3803	3899	3995	4091	4187	4283	4379	4475	4571	4667	4763	4955
	61" - 65"	5.5	99		3720	3820	3920	4020	4120	4220	4320	4420	4520	4620	4720	4820	4920	5020	5220

d" x h"
28 x 36

Seat Height 19.25"
Inside Seat Depth 19.5"

When ordering, replace xx in the sku with the desired length in inches of the banquette.
Example: a 51" Round End Right Facing Banquette would be VER0220BRR51

Product Features

- Seats sprung with 3" ultra high strength webbing
- High density resilient polyurethane foam used in seats and backs
- Frames constructed from CNC cut hardwood plywood
- Units can be ganged, unganged, and re-arranged

Notes

- Available in 1" increments
- Optional PLATEAU power option can be daisy chained across multiple units

Options

Power Option

- PD-PLAT-2: Plateau Power Option - \$691 each
- Specify Color (White, Black, or Gray) and Location (Left Facing/Right Facing)
- See Power & Data Options for further details

2 Material Selections

A Entire Back Rest B Body Perimeter C Seat Top

45" - 50"	1.75 yds.	2.25 yds.	1 yd.
51" - 55"	1.75 yds.	2.25 yds.	1.75 yds.
56" - 60"	2.5 yds.	2.25 yds.	1.75 yds.
61" - 65"	2.5 yds.	2.25 yds.	1.75 yds.

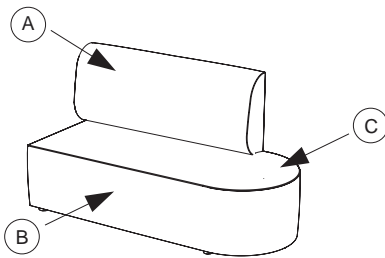

DARRAN is pleased to offer customers the design freedom of combination fabrics. When using fabric, vinyl or leather combinations, pricing/yardage requirements will be as shown in the above table.

- When combining two materials of the same grade, pricing will be specified grade + 5%
- If combining two materials of different grades or leather/fabric combination, use the highest grade/price + 5%
- If using COM or COL, pricing will be COM or COL + 5%.
- If both COM + COL are used in combination, use COL + 5%.

PLATEAU

Flush-mount in-surface power

○ ● ● Standard White. Special order Black or Gray

Style Number	List Price
PD-PLAT-2	\$691

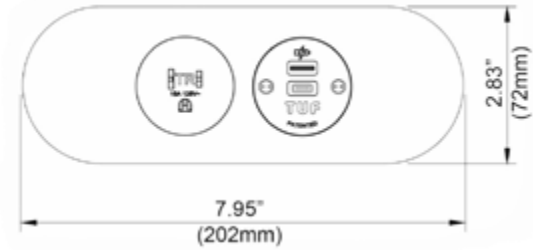

Features

- > Shallow profile for tight installations
- > Spill-resistant TR socket as standard
- > Comes with 1 AC Power, 1 USB-A, and 1 USB-C
- > Optional High Power 60W USB charging with TUF | PROTECT

Specifications

Add flush mount power to training tables, soft seating and more with PLATEAU. A stylish in-surface unit with a near flush profile, PLATEAU fits neatly into surfaces 0.7" - 1.26" (18 - 32 mm) proud by just 0.08 (2 mm), integrating seamlessly into your furniture. Available in white (standard), black, or gray, with standard adjustable side or rear power cord exit.

Easy to install and even easier to use, multiple PLATEAU units can be connected and disconnected with no tools, all powered from a single starter cord with in-built over-current protection for added peace of mind.

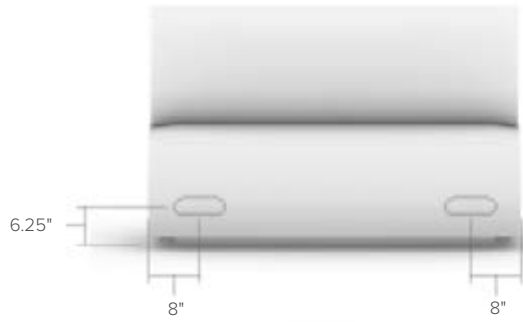

Straight Units

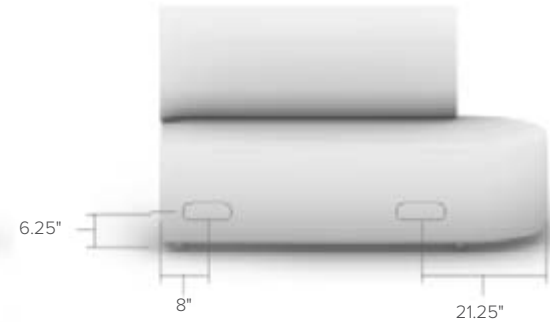

Round End Units



End Cap Units

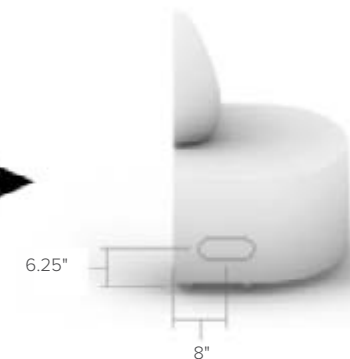

End Cap Units

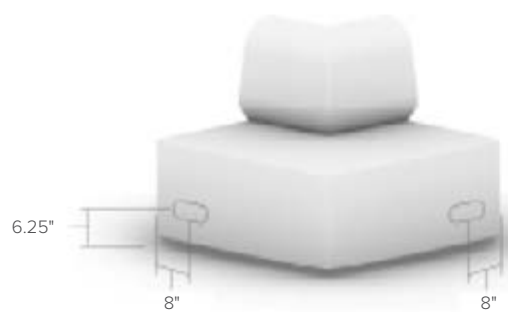

Outside Corner Units